



A D T

FCC TEST REPORT

REPORT NO.: RF990628C13

MODEL NO.: WL-760A

FCC ID: RYKWL760A

RECEIVED: June 28, 2010

TESTED: July 14 ~ 15, 2010

ISSUED: July 21, 2010

APPLICANT: SparkLAN Communications, Inc.

ADDRESS: 8F., No.257, Sec. 2, Tiding Blvd., Neihu District,
Taipei City 11493, Taiwan (R.O.C.)

ISSUED BY: Bureau Veritas Consumer Products Services
(H.K.) Ltd., Taoyuan Branch

LAB LOCATION: No. 47, 14th Ling, Chia Pau Tsuen, Lin Kou
Hsiang, Taipei Hsien, 244 Taiwan

This test report consists of 57 pages in total. It may be duplicated completely for legal use with the approval of the applicant. It should not be reproduced except in full, without the written approval of our laboratory. The client should not use it to claim product endorsement by TAF or any government agencies. The test results in the report only apply to the tested sample.





A D T

TABLE OF CONTENTS

1.	CERTIFICATION.....	4
2.	SUMMARY OF TEST RESULTS	5
2.1	MEASUREMENT UNCERTAINTY	5
3.	GENERAL INFORMATION	6
3.1	GENERAL DESCRIPTION OF EUT	6
3.2	DESCRIPTION OF TEST MODES	7
3.2.1	CONFIGURATION OF SYSTEM UNDER TEST	7
3.2.2	TEST MODE APPLICABILITY AND TESTED CHANNEL DETAIL.....	8
3.3	GENERAL DESCRIPTION OF APPLIED STANDARDS	10
3.4	DESCRIPTION OF SUPPORT UNITS.....	10
4.	TEST TYPES AND RESULTS.....	11
4.1	RADIATED EMISSION MEASUREMENT	11
4.1.1	LIMITS OF RADIATED EMISSION MEASUREMENT	11
4.1.2	TEST INSTRUMENTS	12
4.1.3	TEST PROCEDURES	13
4.1.4	DEVIATION FROM TEST STANDARD	13
4.1.5	TEST SETUP	14
4.1.6	EUT OPERATING CONDITIONS.....	14
4.1.7	TEST RESULTS	15
4.2	CONDUCTED EMISSION MEASUREMENT	23
4.2.1	LIMITS OF CONDUCTED EMISSION MEASUREMENT	23
4.2.2	TEST INSTRUMENTS	23
4.2.3	TEST PROCEDURES	24
4.2.4	DEVIATION FROM TEST STANDARD	24
4.2.5	TEST SETUP	25
4.2.6	EUT OPERATING CONDITIONS.....	25
4.2.7	TEST RESULTS	26
4.3	6dB BANDWIDTH MEASUREMENT	28
4.3.1	LIMITS OF 6dB BANDWIDTH MEASUREMENT.....	28
4.3.2	TEST INSTRUMENTS	28
4.3.3	TEST PROCEDURE	28
4.3.4	DEVIATION FROM TEST STANDARD	28
4.3.5	TEST SETUP	29
4.3.6	EUT OPERATING CONDITIONS.....	29
4.3.7	TEST RESULTS	30
4.4	MAXIMUM OUTPUT POWER	33
4.4.1	LIMITS OF MAXIMUM PEAK OUTPUT POWER MEASUREMENT	33
4.4.2	INSTRUMENTS	33
4.4.3	TEST PROCEDURES	33
4.4.4	DEVIATION FROM TEST STANDARD	34
4.4.5	TEST SETUP	34
4.4.6	EUT OPERATING CONDITIONS.....	34
4.4.7	TEST RESULTS	35
4.5	POWER SPECTRAL DENSITY MEASUREMENT	36



A D T

4.5.1	LIMITS OF POWER SPECTRAL DENSITY MEASUREMENT	36
4.5.2	TEST INSTRUMENTS	36
4.5.3	TEST PROCEDURE	36
4.5.4	DEVIATION FROM TEST STANDARD	37
4.5.5	TEST SETUP	37
4.5.6	EUT OPERATING CONDITION	37
4.5.7	TEST RESULTS	38
4.6	BAND EDGES MEASUREMENT	41
4.6.1	LIMITS OF BAND EDGES MEASUREMENT	41
4.6.2	TEST INSTRUMENTS	41
4.6.3	TEST PROCEDURE	42
4.6.4	DEVIATION FROM TEST STANDARD	42
4.6.5	EUT OPERATING CONDITION	42
4.6.6	TEST RESULTS	43
5.	PHOTOGRAPHS OF THE TEST CONFIGURATION	55
6.	INFORMATION ON THE TESTING LABORATORIES	56
7.	APPENDIX A - MODIFICATIONS RECORDERS FOR ENGINEERING CHANGES TO THE EUT BY THE LAB	57



A D T

1. CERTIFICATION

PRODUCT: WLAN 802.11b/g PCI Adapter
BRAND NAME: SparkLAN
MODEL NO.: WL-760A
APPLICANT: SparkLAN Communications, Inc.
TEST SAMPLE: ENGINEERING SAMPLE
TESTED: July 14 ~ 15, 2010
STANDARDS: **FCC Part 15, Subpart C (Section 15.247)**
ANSI C63.4-2003

The above equipment has been tested by **Bureau Veritas Consumer Products Services (H.K.) Ltd., Taoyuan Branch**, and found compliance with the requirement of the above standards. The test record, data evaluation & Equipment Under Test (EUT) configurations represented herein are true and accurate accounts of the measurements of the sample's EMC characteristics under the conditions specified in this report.

PREPARED BY : Celia Chen , **DATE:** July 21, 2010
(Celia Chen / Senior Specialist)

TECHNICAL ACCEPTANCE : Jamison Chan , **DATE:** July 21, 2010
Responsible for RF (Jamison Chan / Supervisor)

APPROVED BY : Ken Liu , **DATE:** July 21, 2010
(Ken Liu / Assistant Manager)



A D T

2. SUMMARY OF TEST RESULTS

The EUT has been tested according to the following specifications:

APPLIED STANDARD: FCC PART 15, SUBPART C (SECTION 15.247)			
STANDARD SECTION	TEST TYPE AND LIMIT	RESULT	REMARK
15.207	AC Power Conducted Emission	PASS	Meet the requirement of limit. Minimum passing margin is -14.84dB at 0.185MHz
15.247(a)(2)	Spectrum Bandwidth of a Direct Sequence Spread Spectrum System Limit: min. 500kHz	PASS	Meet the requirement of limit.
15.247(b)	Maximum Peak Output Power Limit: max. 30dBm	PASS	Meet the requirement of limit.
15.247(d)	Radiated Emissions Limit: Table 15.209	PASS	Meet the requirement of limit. Minimum passing margin is -0.1dB at 4874.00MHz
15.247(e)	Power Spectral Density Limit: max. 8dBm	PASS	Meet the requirement of limit.
15.247(d)	Band Edge Measurement Limit: 20dB less than the peak value of fundamental frequency	PASS	Meet the requirement of limit.
15.203	Antenna Requirement	PASS	Antenna connector is R-SMA not a standard connector.

2.1 MEASUREMENT UNCERTAINTY

Where relevant, the following measurement uncertainty levels have been estimated for tests performed on the EUT as specified in CISPR 16-4-2:

This uncertainty represents an expanded uncertainty expressed at approximately the 95% confidence level using a coverage factor of $k = 2$.

MEASUREMENT	FREQUENCY	UNCERTAINTY
Conducted emissions	150kHz~30MHz	2.41 dB
Radiated emissions	30MHz~1GHz	3.67 dB
	Above 1GHz	2.89 dB



3. GENERAL INFORMATION

3.1 GENERAL DESCRIPTION OF EUT

PRODUCT	WLAN 802.11b/g PCI Adapter
MODEL NO.	WL-760A
FCC ID	RYKWL760A
POWER SUPPLY	3.3Vdc
MODULATION TYPE	CCK, DQPSK, DBPSK for DSSS 64QAM, 16QAM, QPSK, BPSK for OFDM
MODULATION TECHNOLOGY	DSSS, OFDM
TRANSFER RATE	802.11b:11/ 5.5/ 2/ 1Mbps 802.11g: 54/ 48/ 36/ 24/ 18/ 12/ 9/ 6Mbps (*Turbo mode: up to 108Mbps)
OPERATING FREQUENCY	2412 ~ 2462MHz
NUMBER OF CHANNEL	11 for normal / 1 for turbo
OUTPUT POWER	225.9mW
ANTENNA TYPE	NMO Socket antenna with 3dBi gain
ANTENNA CONNECTOR	R-SMA connector
DATA CABLE	NA
I/O PORTS	NA
ASSOCIATED DEVICES	NA

Note:

1. The EUT incorporates a SISO function. Physically, the EUT provides one completed transmitter and one receiver.

Modulation Mode	Tx Function
802.11b	1TX
802.11g	1TX

2. This EUT is capable of providing data rates of up to 108Mbps in Turbo Mode depending upon reception quality.
3. The above EUT information was declared by manufacturer and for more detailed features description, please refer to the manufacturer's specifications or user's manual.

3.2 DESCRIPTION OF TEST MODES

11 channels are provided for 802.11b, 802.11g:

CHANNEL	FREQUENCY	CHANNEL	FREQUENCY
1	2412MHz	7	2442MHz
2	2417MHz	8	2447MHz
3	2422MHz	9	2452MHz
4	2427MHz	10	2457MHz
5	2432MHz	11	2462MHz
6	2437MHz		

1 channel is provided for 802.11g turbo mode:

CHANNEL	FREQUENCY
6	2437 MHz

3.2.1 CONFIGURATION OF SYSTEM UNDER TEST

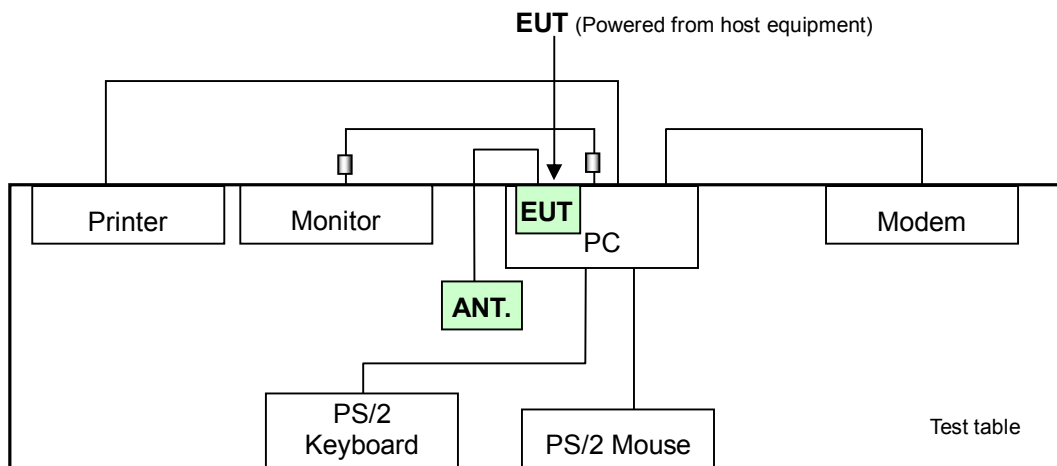



3.2.2 TEST MODE APPLICABILITY AND TESTED CHANNEL DETAIL

EUT CONFIGURE MODE	APPLICABLE TO				DESCRIPTION
	RE \geq 1G	RE<1G	PLC	APCM	
-	√	√	√	√	-

Where **RE \geq 1G**: Radiated Emission above 1GHz **RE<1G**: Radiated Emission below 1GHz
PLC: Power Line Conducted Emission **APCM**: Antenna Port Conducted Measurement

RADIATED EMISSION TEST (ABOVE 1GHz):

- Pre-Scan has been conducted to determine the worst-case mode from all possible combinations between available modulations, data rates, XZ Axis and antenna ports (if EUT with antenna diversity architecture).
- Following channel(s) was (were) selected for the final test as listed below.

MODE	AVAILABLE CHANNEL	TESTED CHANNEL	MODULATION TECHNOLOGY	MODULATION TYPE	DATA RATE (Mbps)	AXIS
802.11b	1 to 11	1, 6, 11	DSSS	DBPSK	1.0	Z
802.11g	1 to 11	1, 6, 11	OFDM	BPSK	6.0	Z
802.11g Turbo	1	6	OFDM	QPSK	12.0	Z

RADIATED EMISSION TEST (BELOW 1GHz):

- Pre-Scan has been conducted to determine the worst-case mode from all possible combinations between available modulations, data rates, XZ Axis and antenna ports (if EUT with antenna diversity architecture).
- Following channel(s) was (were) selected for the final test as listed below.

MODE	AVAILABLE CHANNEL	TESTED CHANNEL	MODULATION TECHNOLOGY	MODULATION TYPE	DATA RATE (Mbps)	AXIS
802.11g	1 to 11	11	OFDM	BPSK	6.0	Z

POWER LINE CONDUCTED EMISSION TEST:

- Pre-Scan has been conducted to determine the worst-case mode from all possible combinations between available modulations, data rates and antenna ports (if EUT with antenna diversity architecture).
- Following channel(s) was (were) selected for the final test as listed below.

MODE	AVAILABLE CHANNEL	TESTED CHANNEL	MODULATION TECHNOLOGY	MODULATION TYPE	DATA RATE (Mbps)
802.11g	1 to 11	11	OFDM	BPSK	6.0



BANDEDGE MEASUREMENT:

- Pre-Scan has been conducted to determine the worst-case mode from all possible combinations between available modulations, data rates and antenna ports (if EUT with antenna diversity architecture).
- Following channel(s) was (were) selected for the final test as listed below.

MODE	AVAILABLE CHANNEL	TESTED CHANNEL	MODULATION TECHNOLOGY	MODULATION TYPE	DATA RATE (Mbps)
802.11b	1 to 11	1, 11	DSSS	DBPSK	1.0
802.11g	1 to 11	1, 11	OFDM	BPSK	6.0
802.11g Turbo	1	6	OFDM	QPSK	12.0

ANTENNA PORT CONDUCTED MEASUREMENT:

- This item includes all test value of each mode, but only includes spectrum plot of worst value of each mode.
- Pre-Scan has been conducted to determine the worst-case mode from all possible combinations between available modulations, data rates and antenna ports (if EUT with antenna diversity architecture).
- Following channel(s) was (were) selected for the final test as listed below.

MODE	AVAILABLE CHANNEL	TESTED CHANNEL	MODULATION TECHNOLOGY	MODULATION TYPE	DATA RATE (Mbps)
802.11b	1 to 11	1, 6, 11	DSSS	DBPSK	1.0
802.11g	1 to 11	1, 6, 11	OFDM	BPSK	6.0
802.11g Turbo	1	6	OFDM	QPSK	12.0

TEST CONDITION:

APPLICABLE TO	ENVIRONMENTAL CONDITIONS	INPUT POWER (SYSTEM)	TESTED BY
RE ≥ 1G	25deg. C, 68% RH, 1009hPa	120Vac, 60Hz	Nick Chen
RE < 1G	25deg. C, 68% RH, 1009hPa	120Vac, 60Hz	Nick Chen
PLC	26deg. C, 71% RH, 1009hPa	120Vac, 60Hz	Jamison Chan
APCM	25deg. C, 70% RH, 1009hPa	120Vac, 60Hz	Jun Wu



A D T

3.3 GENERAL DESCRIPTION OF APPLIED STANDARDS

The EUT is a RF Product. According to the specifications of the manufacturer, it must comply with the requirements of the following standards:

FCC Part 15, Subpart C (15.247)

ANSI C63.4-2003

All test items have been performed and recorded as per the above standards.

NOTE: The EUT is also considered as a kind of computer peripheral, because the connection to computer is necessary for typical use. It has been verified to comply with the requirements of FCC Part 15, Subpart B, Class B (DoC). The test report has been issued separately.

3.4 DESCRIPTION OF SUPPORT UNITS

The EUT has been tested as an independent unit together with other necessary accessories or support units. The following support units or accessories were used to form a representative test configuration during the tests.

NO.	PRODUCT	BRAND	MODEL NO.	SERIAL NO.	FCC ID
1	PERSONAL COMPUTER	HP	dx7300MT	SGH72102QS	FCC DoC Approved
2	LCD MONITOR	BenQ	Q24W5	ET18712601SL0	FCC DoC Approved
3	PRINTER	EPSON	LQ-300+	DCGY017096	FCC DoC Approved
4	MODEM	ACEEX	1414	980020538	IFAXDM1414
5	USB MOUSE	MICROSOFT	X800898	9241921-30608	FCC DoC Approved
6	USB KEYBOARD	Dell	RTD750	N/A	FCC DoC Approved

NO.	SIGNAL CABLE DESCRIPTION OF THE ABOVE SUPPORT UNITS
1	N/A
2	1.8m D-Sub cable with two cores.
3	1.8m braid shielded wire, terminated with DB25 and Centronics connector via metallic frame, w/o core
4	1.2 m braid shielded wire, terminated with DB25 and DB9 connector via metallic frame, w/o core.
5	1.8 m foil shielded wire, terminated with USB connector via drain wire, with 1 core.
6	1.8 m foil shielded wire, terminated with USB connector via drain wire, w/o core.

NOTE: All power cords of the above support units are non-shielded (1.8m).



4. TEST TYPES AND RESULTS

4.1 RADIATED EMISSION MEASUREMENT

4.1.1 LIMITS OF RADIATED EMISSION MEASUREMENT

Emissions radiated outside of the specified bands, shall be according to the general radiated limits in 15.209 as following:

FREQUENCIES (MHz)	FIELD STRENGTH (microvolts/meter)	MEASUREMENT DISTANCE (meters)
0.009 ~ 0.490	2400/F(kHz)	300
0.490 ~ 1.705	24000/F(kHz)	30
1.705 ~ 30.0	30	30
30 ~ 88	100	3
88 ~ 216	150	3
216 ~ 960	200	3
Above 960	500	3

NOTE:

1. The lower limit shall apply at the transition frequencies.
2. Emission level (dBuV/m) = 20 log Emission level (uV/m).
3. As shown in 15.35(b), for frequencies above 1000MHz, the field strength limits are based on average detector, however, the peak field strength of any emission shall not exceed the maximum permitted average limits, specified above by more than 20dB under any condition of modulation.



A D T

4.1.2 TEST INSTRUMENTS

DESCRIPTION & MANUFACTURER	MODEL NO.	SERIAL NO.	CALIBRATED DATE	CALIBRATED UNTIL
HP Preamplifier	8447D	2432A03504	May 06, 2010	May 05, 2011
HP Preamplifier	8449B	3008A01924	Jul. 14, 2010	Jul. 13, 2011
HP Preamplifier	8449B	3008A01292	Jul. 14, 2010	Jul. 13, 2011
ROHDE & SCHWARZ TEST RECEIVER	ESU26	100005	Jun. 10, 2010	Jun. 09, 2011
Schwarzbeck Antenna	VULB 9168	137	Apr. 29, 2010	Apr. 28, 2011
Schwarzbeck Antenna	VHBA 9123	480	Apr. 29, 2010	Apr. 28, 2011
ADT. Turn Table	TT100	0306	NA	NA
ADT. Tower	AT100	0306	NA	NA
Software	ADT_Radiated_V 7.6.15.9.2	NA	NA	NA
SUHNER RF cable	SF104-26.5	CABLE-CH6-17m -01	Aug. 20, 2009	Aug. 19, 2010
ROHDE & SCHWARZ Spectrum Analyzer	FSP 40	100036	Apr. 06, 2010	Apr. 05, 2011
EMCO Horn Antenna	3115	6714	Oct. 26, 2009	Oct. 25, 2010
EMCO Horn Antenna	3115	9312-4192	Apr. 23, 2010	Apr. 22, 2011

- NOTE:** 1. The calibration interval of the above test instruments is 12/24 months. And the calibrations are traceable to NML/ROC and NIST/USA.
2. The horn antenna and HP preamplifier (model: 8449B) are used only for the measurement of emission frequency above 1GHz if tested.
3. The test was performed in Chamber No. 6.
4. The Industry Canada Reference No. IC 7450E-6.
5. The FCC Site Registration No. is 447212.



4.1.3 TEST PROCEDURES

- a. The EUT was placed on the top of a rotating table 0.8 meters above the ground at a 3 meters semi-anechoic chamber. The table was rotated 360 degrees to determine the position of the highest radiation.
- b. The EUT was set 3 meters away from the interference-receiving antenna, which was mounted on the top of a variable-height antenna tower.
- c. The height of antenna is varied from one meter to four meters above the ground to determine the maximum value of the field strength. Both horizontal and vertical polarizations of the antenna are set to make the measurement.
- d. For each suspected emission, the EUT was arranged to its worst case and then the antenna was tuned to heights from 1 meter to 4 meters and the rotatable table was turned from 0 degrees to 360 degrees to find the maximum reading.
- e. The test-receiver system was set to Peak Detect Function and Specified Bandwidth with Maximum Hold Mode.
- f. If the emission level of the EUT in peak mode was lower than the limit specified, then testing could be stopped and the peak values of the EUT would be reported. Otherwise the emissions would be re-tested one by one using peak, quasi-peak or average method as specified and then reported in a data sheet.

NOTE:

1. The resolution bandwidth and video bandwidth of test receiver/spectrum analyzer is 120kHz for Peak detection (PK) and Quasi-peak detection (QP) at frequency below 1GHz.
2. The resolution bandwidth of test receiver/spectrum analyzer is 1MHz and video bandwidth is 3MHz for Peak detection at frequency above 1GHz.
3. The resolution bandwidth of test receiver/spectrum analyzer is 1MHz and the video bandwidth is 10Hz for Average detection (AV) at frequency above 1GHz.
4. All modes of operation were investigated and the worst-case emissions are reported.

4.1.4 DEVIATION FROM TEST STANDARD

No deviation

4.1.5 TEST SETUP

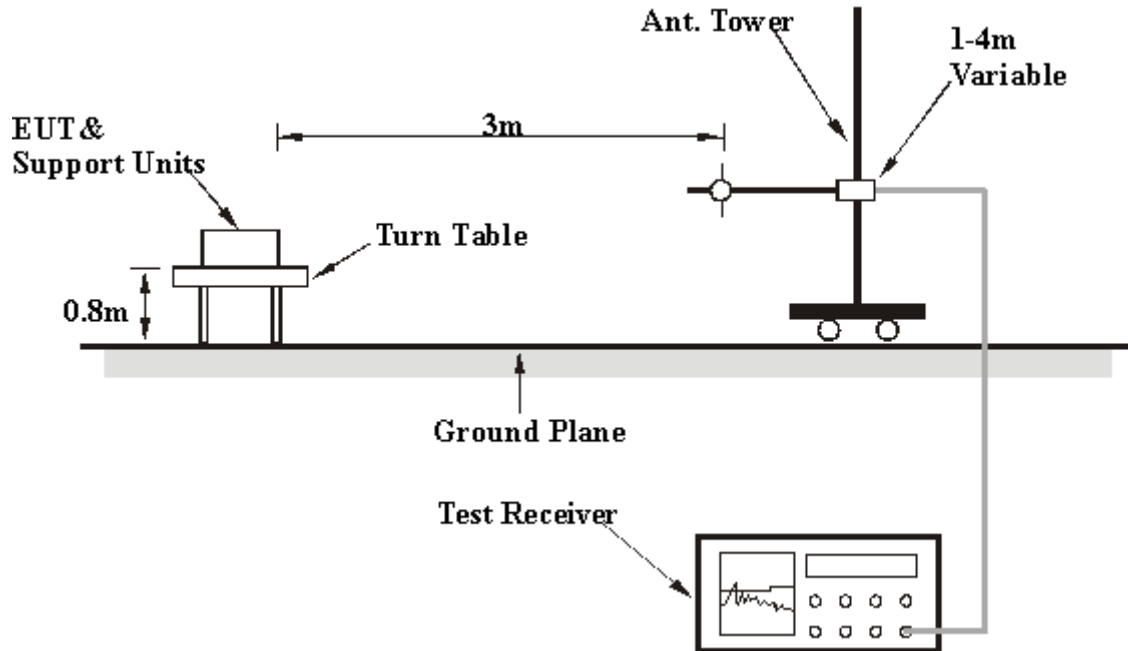

For the actual test configuration, please refer to the attached file (Test Setup Photo).

4.1.6 EUT OPERATING CONDITIONS

- a. Installed the EUT into PC.
- b. Turn on the power of all equipment.
- c. PC ran a test program (provided by manufacture) to enable EUT under transmitting condition at specific channel continuously.
- d. PC read and wrote messages to/ from HDD.
- e. PC sent messages to monitor and displayed on its screen.
- f. PC sent messages to printer, and the printer printed them out.
- g. PC sent messages to modem.
- h. Repeated d ~ h.



A D T

4.1.7 TEST RESULTS

802.11b

EUT TEST CONDITION		MEASUREMENT DETAIL	
CHANNEL	Channel 1	FREQUENCY RANGE	1 ~ 25GHz
INPUT POWER (SYSTEM)	120Vac, 60Hz	DETECTOR FUNCTION	Peak (PK) Average (AV)
ENVIRONMENTAL CONDITIONS	25deg. C, 68%RH 1009 hPa	TESTED BY	Nick Chen

ANTENNA POLARITY & TEST DISTANCE: HORIZONTAL AT 3 M								
NO.	FREQ. (MHz)	EMISSION LEVEL (dBuV/m)	LIMIT (dBuV/m)	MARGIN (dB)	ANTENNA HEIGHT (m)	TABLE ANGLE (Degree)	RAW VALUE (dBuV)	CORRECTION FACTOR (dB/m)
1	2390.00	61.2 PK	74.0	-12.8	1.00 H	195	29.35	31.89
2	2390.00	50.9 AV	54.0	-3.1	1.00 H	195	18.98	31.89
3	*2412.00	106.0 PK			1.00 H	195	74.07	31.97
4	*2412.00	101.2 AV			1.00 H	195	69.19	31.97
5	4824.00	53.6 PK	74.0	-20.4	1.00 H	209	14.48	39.16
6	4824.00	48.0 AV	54.0	-6.0	1.00 H	209	8.82	39.16
7	#9648.00	66.5 PK	86.0	-19.6	1.00 H	215	18.04	48.44
8	#9648.00	62.4 AV	81.2	-18.7	1.00 H	215	13.99	48.44
ANTENNA POLARITY & TEST DISTANCE: VERTICAL AT 3 M								
NO.	FREQ. (MHz)	EMISSION LEVEL (dBuV/m)	LIMIT (dBuV/m)	MARGIN (dB)	ANTENNA HEIGHT (m)	TABLE ANGLE (Degree)	RAW VALUE (dBuV)	CORRECTION FACTOR (dB/m)
1	2390.00	63.8 PK	74.0	-10.2	1.00 V	206	31.89	31.89
2	2390.00	53.1 AV	54.0	-0.9	1.00 V	206	21.23	31.89
3	*2412.00	110.4 PK			1.00 V	206	78.46	31.97
4	*2412.00	105.1 AV			1.00 V	206	73.16	31.97
5	4824.00	52.9 PK	74.0	-21.1	1.09 V	200	13.77	39.16
6	4824.00	47.3 AV	54.0	-6.7	1.09 V	200	8.16	39.16
7	#9648.00	63.5 PK	90.4	-27.0	1.08 V	129	15.03	48.44
8	#9648.00	59.3 AV	85.1	-25.9	1.08 V	129	10.82	48.44

- REMARKS:**
1. Emission level (dBuV/m) = Raw Value (dBuV) + Correction Factor (dB/m).
 2. Correction Factor (dB/m) = Antenna Factor (dB/m) + Cable Factor (dB).
 3. The other emission levels were very low against the limit.
 4. Margin value = Emission level – Limit value.
 5. “ * “: Fundamental frequency.
 6. “#“: The radiated frequency is out the restricted band.



A D T

EUT TEST CONDITION		MEASUREMENT DETAIL	
CHANNEL	Channel 6	FREQUENCY RANGE	1 ~ 25GHz
INPUT POWER (SYSTEM)	120Vac, 60Hz	DETECTOR FUNCTION	Peak (PK) Average (AV)
ENVIRONMENTAL CONDITIONS	25deg. C, 68%RH 1009 hPa	TESTED BY	Nick Chen

ANTENNA POLARITY & TEST DISTANCE: HORIZONTAL AT 3 M								
NO.	FREQ. (MHz)	EMISSION LEVEL (dBuV/m)	LIMIT (dBuV/m)	MARGIN (dB)	ANTENNA HEIGHT (m)	TABLE ANGLE (Degree)	RAW VALUE (dBuV)	CORRECTION FACTOR (dB/m)
1	*2437.00	107.2 PK			1.00 H	195	75.13	32.06
2	*2437.00	102.1 AV			1.00 H	195	70.02	32.06
3	4874.00	56.9 PK	74.0	-17.1	1.00 H	151	17.54	39.38
4	4874.00	53.1 AV	54.0	-0.9	1.00 H	151	13.72	39.38
5	#9748.00	65.3 PK	87.2	-21.9	1.05 H	136	16.76	48.58
6	#9748.00	60.3 AV	82.1	-21.8	1.05 H	136	11.74	48.58
ANTENNA POLARITY & TEST DISTANCE: VERTICAL AT 3 M								
NO.	FREQ. (MHz)	EMISSION LEVEL (dBuV/m)	LIMIT (dBuV/m)	MARGIN (dB)	ANTENNA HEIGHT (m)	TABLE ANGLE (Degree)	RAW VALUE (dBuV)	CORRECTION FACTOR (dB/m)
1	*2437.00	112.8 PK			1.00 V	207	80.74	32.06
2	*2437.00	107.9 AV			1.00 V	207	75.88	32.06
3	4874.00	56.9 PK	74.0	-17.1	1.25 V	308	17.55	39.38
4	4874.00	53.9 AV	54.0	-0.1	1.25 V	308	14.48	39.38
5	#9748.00	65.2 PK	92.8	-27.6	1.24 V	192	16.65	48.58
6	#9748.00	60.6 AV	87.9	-27.4	1.24 V	192	11.99	48.58

- REMARKS:**
1. Emission level (dBuV/m) = Raw Value (dBuV) + Correction Factor (dB/m).
 2. Correction Factor (dB/m) = Antenna Factor (dB/m) + Cable Factor (dB).
 3. The other emission levels were very low against the limit.
 4. Margin value = Emission level – Limit value.
 5. “ * “: Fundamental frequency.
 6. “#”:The radiated frequency is out the restricted band.



A D T

EUT TEST CONDITION		MEASUREMENT DETAIL	
CHANNEL	Channel 11	FREQUENCY RANGE	1 ~ 25GHz
INPUT POWER (SYSTEM)	120Vac, 60Hz	DETECTOR FUNCTION	Peak (PK) Average (AV)
ENVIRONMENTAL CONDITIONS	25deg. C, 68%RH 1009 hPa	TESTED BY	Nick Chen

ANTENNA POLARITY & TEST DISTANCE: HORIZONTAL AT 3 M								
NO.	FREQ. (MHz)	EMISSION LEVEL (dBuV/m)	LIMIT (dBuV/m)	MARGIN (dB)	ANTENNA HEIGHT (m)	TABLE ANGLE (Degree)	RAW VALUE (dBuV)	CORRECTION FACTOR (dB/m)
1	*2462.00	104.1 PK			1.02 H	304	71.93	32.14
2	*2462.00	99.2 AV			1.02 H	304	67.07	32.14
3	2483.50	59.8 PK	74.0	-14.2	1.04 H	304	27.57	32.21
4	2483.50	48.0 AV	54.0	-6.0	1.04 H	304	15.83	32.21
5	4924.00	53.9 PK	74.0	-20.1	1.04 H	190	14.36	39.56
6	4924.00	48.4 AV	54.0	-5.6	1.04 H	190	8.85	39.56
7	#9848.00	61.8 PK	84.1	-22.3	1.04 H	152	13.09	48.69
8	#9848.00	54.7 AV	79.2	-24.5	1.04 H	152	6.04	48.69
ANTENNA POLARITY & TEST DISTANCE: VERTICAL AT 3 M								
NO.	FREQ. (MHz)	EMISSION LEVEL (dBuV/m)	LIMIT (dBuV/m)	MARGIN (dB)	ANTENNA HEIGHT (m)	TABLE ANGLE (Degree)	RAW VALUE (dBuV)	CORRECTION FACTOR (dB/m)
1	*2462.00	110.6 PK			1.00 V	209	78.44	32.14
2	*2462.00	105.7 AV			1.00 V	209	73.53	32.14
3	2483.50	63.3 PK	74.0	-10.7	1.00 V	209	31.13	32.21
4	2483.50	52.4 AV	54.0	-1.7	1.00 V	209	20.14	32.21
5	4924.00	57.3 PK	74.0	-16.7	1.04 V	192	17.72	39.56
6	4924.00	53.6 AV	54.0	-0.4	1.04 V	192	14.01	39.56
7	#9848.00	61.3 PK	90.6	-29.3	1.00 V	11	12.60	48.69
8	#9848.00	53.4 AV	85.7	-32.3	1.00 V	11	4.71	48.69

- REMARKS:**
1. Emission level (dBuV/m) = Raw Value (dBuV) + Correction Factor (dB/m).
 2. Correction Factor (dB/m) = Antenna Factor (dB/m) + Cable Factor (dB).
 3. The other emission levels were very low against the limit.
 4. Margin value = Emission level – Limit value.
 5. “ * “: Fundamental frequency.
 6. “#“: The radiated frequency is out the restricted band.



A D T

802.11g (NORMAL MODE)

EUT TEST CONDITION		MEASUREMENT DETAIL	
CHANNEL	Channel 1	FREQUENCY RANGE	1 ~ 25GHz
INPUT POWER (SYSTEM)	120Vac, 60Hz	DETECTOR FUNCTION	Peak (PK) Average (AV)
ENVIRONMENTAL CONDITIONS	25deg. C, 68%RH 1009 hPa	TESTED BY	Nick Chen

ANTENNA POLARITY & TEST DISTANCE: HORIZONTAL AT 3 M								
NO.	FREQ. (MHz)	EMISSION LEVEL (dBuV/m)	LIMIT (dBuV/m)	MARGIN (dB)	ANTENNA HEIGHT (m)	TABLE ANGLE (Degree)	RAW VALUE (dBuV)	CORRECTION FACTOR (dB/m)
1	2390.00	70.0 PK	74.0	-4.0	1.00 H	195	38.12	31.89
2	2390.00	49.3 AV	54.0	-4.7	1.00 H	195	17.40	31.89
3	*2412.00	105.5 PK			1.00 H	195	73.52	31.97
4	*2412.00	94.5 AV			1.00 H	195	62.48	31.97
5	4824.00	49.6 PK	74.0	-24.4	1.13 H	196	10.47	39.16
6	4824.00	36.4 AV	54.0	-17.6	1.13 H	196	-2.73	39.16
ANTENNA POLARITY & TEST DISTANCE: VERTICAL AT 3 M								
NO.	FREQ. (MHz)	EMISSION LEVEL (dBuV/m)	LIMIT (dBuV/m)	MARGIN (dB)	ANTENNA HEIGHT (m)	TABLE ANGLE (Degree)	RAW VALUE (dBuV)	CORRECTION FACTOR (dB/m)
1	2390.00	73.4 PK	74.0	-0.6	1.00 V	208	41.53	31.89
2	2390.00	50.7 AV	54.0	-3.3	1.00 V	208	18.77	31.89
3	*2412.00	109.6 PK			1.00 V	208	77.62	31.97
4	*2412.00	98.5 AV			1.00 V	208	66.49	31.97
5	4824.00	49.5 PK	74.0	-24.5	1.20 V	41	10.31	39.16
6	4824.00	35.8 AV	54.0	-18.2	1.20 V	41	-3.37	39.16

- REMARKS:**
1. Emission level (dBuV/m) = Raw Value (dBuV) + Correction Factor (dB/m).
 2. Correction Factor (dB/m) = Antenna Factor (dB/m) + Cable Factor (dB).
 3. The other emission levels were very low against the limit.
 4. Margin value = Emission level – Limit value.
 5. “ * “: Fundamental frequency.



A D T

EUT TEST CONDITION		MEASUREMENT DETAIL	
CHANNEL	Channel 6	FREQUENCY RANGE	1 ~ 25GHz
INPUT POWER (SYSTEM)	120Vac, 60Hz	DETECTOR FUNCTION	Peak (PK) Average (AV)
ENVIRONMENTAL CONDITIONS	25deg. C, 68%RH 1009 hPa	TESTED BY	Nick Chen

ANTENNA POLARITY & TEST DISTANCE: HORIZONTAL AT 3 M								
NO.	FREQ. (MHz)	EMISSION LEVEL (dBuV/m)	LIMIT (dBuV/m)	MARGIN (dB)	ANTENNA HEIGHT (m)	TABLE ANGLE (Degree)	RAW VALUE (dBuV)	CORRECTION FACTOR (dB/m)
1	*2437.00	109.4 PK			1.01 H	277	77.35	32.06
2	*2437.00	98.7 AV			1.01 H	277	66.66	32.06
3	4874.00	53.3 PK	74.0	-20.7	1.04 H	149	13.93	39.38
4	4874.00	40.4 AV	54.0	-13.6	1.04 H	149	1.04	39.38
ANTENNA POLARITY & TEST DISTANCE: VERTICAL AT 3 M								
NO.	FREQ. (MHz)	EMISSION LEVEL (dBuV/m)	LIMIT (dBuV/m)	MARGIN (dB)	ANTENNA HEIGHT (m)	TABLE ANGLE (Degree)	RAW VALUE (dBuV)	CORRECTION FACTOR (dB/m)
1	*2437.00	114.3 PK			1.00 V	209	82.27	32.06
2	*2437.00	103.3 AV			1.00 V	209	71.27	32.06
3	4874.00	61.2 PK	74.0	-12.8	1.29 V	197	21.79	39.38
4	4874.00	46.9 AV	54.0	-7.1	1.29 V	197	7.56	39.38

- REMARKS:**
1. Emission level (dBuV/m) = Raw Value (dBuV) + Correction Factor (dB/m).
 2. Correction Factor (dB/m) = Antenna Factor (dB/m) + Cable Factor (dB).
 3. The other emission levels were very low against the limit.
 4. Margin value = Emission level – Limit value.
 5. “ * “: Fundamental frequency.



A D T

EUT TEST CONDITION		MEASUREMENT DETAIL	
CHANNEL	Channel 11	FREQUENCY RANGE	1 ~ 25GHz
INPUT POWER (SYSTEM)	120Vac, 60Hz	DETECTOR FUNCTION	Peak (PK) Average (AV)
ENVIRONMENTAL CONDITIONS	25deg. C, 68%RH 1009 hPa	TESTED BY	Nick Chen

ANTENNA POLARITY & TEST DISTANCE: HORIZONTAL AT 3 M								
NO.	FREQ. (MHz)	EMISSION LEVEL (dBuV/m)	LIMIT (dBuV/m)	MARGIN (dB)	ANTENNA HEIGHT (m)	TABLE ANGLE (Degree)	RAW VALUE (dBuV)	CORRECTION FACTOR (dB/m)
1	*2462.00	104.0 PK			1.00 H	277	71.85	32.14
2	*2462.00	92.6 AV			1.00 H	277	60.47	32.14
3	2483.50	66.3 PK	74.0	-7.7	1.00 H	277	34.08	32.21
4	2483.50	49.1 AV	54.0	-4.9	1.00 H	277	16.86	32.21
5	4924.00	49.7 PK	74.0	-24.3	1.25 H	142	10.14	39.56
6	4924.00	36.9 AV	54.0	-17.1	1.25 H	142	-2.70	39.56
ANTENNA POLARITY & TEST DISTANCE: VERTICAL AT 3 M								
NO.	FREQ. (MHz)	EMISSION LEVEL (dBuV/m)	LIMIT (dBuV/m)	MARGIN (dB)	ANTENNA HEIGHT (m)	TABLE ANGLE (Degree)	RAW VALUE (dBuV)	CORRECTION FACTOR (dB/m)
1	*2462.00	109.6 PK			1.00 V	339	77.45	32.14
2	*2462.00	98.3 AV			1.00 V	339	66.14	32.14
3	2483.50	71.6 PK	74.0	-2.4	1.00 V	339	39.40	32.21
4	2483.50	50.8 AV	54.0	-3.2	1.00 V	339	18.59	32.21
5	4924.00	50.6 PK	74.0	-23.4	1.01 V	177	11.05	39.56
6	4924.00	38.2 AV	54.0	-15.9	1.01 V	177	-1.41	39.56

- REMARKS:**
1. Emission level (dBuV/m) = Raw Value (dBuV) + Correction Factor (dB/m).
 2. Correction Factor (dB/m) = Antenna Factor (dB/m) + Cable Factor (dB).
 3. The other emission levels were very low against the limit.
 4. Margin value = Emission level – Limit value.
 5. “ * “: Fundamental frequency.



A D T

802.11g (TURBO MODE)

EUT TEST CONDITION		MEASUREMENT DETAIL	
CHANNEL	Channel 6	FREQUENCY RANGE	1 ~ 25GHz
INPUT POWER (SYSTEM)	120Vac, 60Hz	DETECTOR FUNCTION	Peak (PK) Average (AV)
ENVIRONMENTAL CONDITIONS	25deg. C, 68%RH 1009 hPa	TESTED BY	Nick Chen

ANTENNA POLARITY & TEST DISTANCE: HORIZONTAL AT 3 M								
NO.	FREQ. (MHz)	EMISSION LEVEL (dBuV/m)	LIMIT (dBuV/m)	MARGIN (dB)	ANTENNA HEIGHT (m)	TABLE ANGLE (Degree)	RAW VALUE (dBuV)	CORRECTION FACTOR (dB/m)
1	2390.00	65.1 PK	74.0	-8.9	1.32 H	276	33.25	31.89
2	2390.00	50.9 AV	54.0	-3.1	1.32 H	276	18.97	31.89
3	*2437.00	103.4 PK			1.32 H	276	71.35	32.06
4	*2437.00	92.2 AV			1.32 H	276	60.17	32.06
5	2483.50	67.2 PK	74.0	-6.8	1.32 H	276	34.96	32.21
6	2483.50	50.4 AV	54.0	-3.6	1.32 H	276	18.20	32.21
7	4874.00	50.2 PK	74.0	-23.8	1.05 H	211	10.81	39.38
8	4874.00	37.4 AV	54.0	-16.6	1.05 H	211	-1.94	39.38
ANTENNA POLARITY & TEST DISTANCE: VERTICAL AT 3 M								
NO.	FREQ. (MHz)	EMISSION LEVEL (dBuV/m)	LIMIT (dBuV/m)	MARGIN (dB)	ANTENNA HEIGHT (m)	TABLE ANGLE (Degree)	RAW VALUE (dBuV)	CORRECTION FACTOR (dB/m)
1	2390.00	68.1 PK	74.0	-5.9	1.00 V	208	36.22	31.89
2	2390.00	52.9 AV	54.0	-1.1	1.00 V	208	21.04	31.89
3	*2437.00	108.1 PK			1.00 V	208	76.01	32.06
4	*2437.00	97.6 AV			1.00 V	208	65.54	32.06
5	2483.50	71.1 PK	74.0	-2.9	1.00 V	208	38.85	32.21
6	2483.50	52.1 AV	54.0	-1.9	1.00 V	208	19.85	32.21
7	4874.00	49.6 PK	74.0	-24.4	1.00 V	157	10.24	39.38
8	4874.00	36.1 AV	54.0	-17.9	1.00 V	157	-3.30	39.38

- REMARKS:**
1. Emission level (dBuV/m) = Raw Value (dBuV) + Correction Factor (dB/m).
 2. Correction Factor (dB/m) = Antenna Factor (dB/m) + Cable Factor (dB).
 3. The other emission levels were very low against the limit.
 4. Margin value = Emission level – Limit value.
 5. “ * “: Fundamental frequency.



A D T

BELOW 1GHz WORST-CASE DATA : 802.11g (NORMAL MODE)

EUT TEST CONDITION		MEASUREMENT DETAIL	
CHANNEL	Channel 11	FREQUENCY RANGE	Below 1000MHz
INPUT POWER (SYSTEM)	120Vac, 60Hz	DETECTOR FUNCTION	Quasi-Peak
ENVIRONMENTAL CONDITIONS	25deg. C, 68%RH 1009 hPa	TESTED BY	Nick Chen

ANTENNA POLARITY & TEST DISTANCE: HORIZONTAL AT 3 M								
NO.	FREQ. (MHz)	EMISSION LEVEL (dBuV/m)	LIMIT (dBuV/m)	MARGIN (dB)	ANTENNA HEIGHT (m)	TABLE ANGLE (Degree)	RAW VALUE (dBuV)	CORRECTION FACTOR (dB/m)
1	67.31	32.4 QP	40.0	-7.6	1.27 H	247	19.78	12.61
2	159.02	39.8 QP	43.5	-3.7	1.45 H	322	24.93	14.89
3	288.04	42.0 QP	46.0	-4.0	1.39 H	4	26.74	15.28
4	384.42	36.8 QP	46.0	-9.2	1.22 H	52	18.78	18.00
5	723.30	37.6 QP	46.0	-8.4	1.47 H	214	12.41	25.16
6	897.40	37.0 QP	46.0	-9.0	1.02 H	217	9.14	27.87
7	908.29	37.5 QP	46.0	-8.5	1.00 H	232	9.44	28.02
ANTENNA POLARITY & TEST DISTANCE: VERTICAL AT 3 M								
NO.	FREQ. (MHz)	EMISSION LEVEL (dBuV/m)	LIMIT (dBuV/m)	MARGIN (dB)	ANTENNA HEIGHT (m)	TABLE ANGLE (Degree)	RAW VALUE (dBuV)	CORRECTION FACTOR (dB/m)
1	68.86	34.7 QP	40.0	-5.3	1.14 V	10	22.32	12.41
2	288.04	32.2 QP	46.0	-13.9	1.39 V	1	16.87	15.28
3	487.02	35.7 QP	46.0	-10.3	1.27 V	334	15.22	20.44
4	566.30	32.6 QP	46.0	-13.4	1.25 V	310	10.11	22.51
5	718.64	37.3 QP	46.0	-8.7	1.33 V	322	12.18	25.10
6	908.29	38.7 QP	46.0	-7.3	1.23 V	229	10.70	28.02
7	956.47	32.7 QP	46.0	-13.3	1.02 V	169	4.02	28.65

- REMARKS:**
1. Emission level (dBuV/m) = Raw Value (dBuV) + Correction Factor (dB/m).
 2. Correction Factor (dB/m) = Antenna Factor (dB/m) + Cable Factor (dB).
 3. The other emission levels were very low against the limit.
 4. Margin value = Emission level – Limit value.



4.2 CONDUCTED EMISSION MEASUREMENT

4.2.1 LIMITS OF CONDUCTED EMISSION MEASUREMENT

FREQUENCY OF EMISSION (MHz)	CONDUCTED LIMIT (dBµV)	
	Quasi-peak	Average
0.15 ~ 0.5	66 to 56	56 to 46
0.5 ~ 5	56	46
5 ~ 30	60	50

- NOTE:**
1. The lower limit shall apply at the transition frequencies.
 2. The limit decreases in line with the logarithm of the frequency in the range of 0.15 to 0.50MHz.
 3. All emanations from a class A/B digital device or system, including any network of conductors and apparatus connected thereto, shall not exceed the level of field strengths specified above.

4.2.2 TEST INSTRUMENTS

DESCRIPTION & MANUFACTURER	MODEL NO.	SERIAL NO.	CALIBRATED DATE	CALIBRATED UNTIL
ROHDE & SCHWARZ Test Receiver	ESCS 30	100276	Dec. 15, 2009	Dec. 14, 2010
ROHDE & SCHWARZ Artificial Mains Network (for EUT)	ESH3-Z5	100218	Nov. 24, 2009	Nov. 23, 2010
LISN With Adapter (for EUT)	AD10	C10Ada-001	Nov. 24, 2009	Nov. 23, 2010
ROHDE & SCHWARZ Artificial Mains Network (for peripherals)	ESH3-Z5	100219	Nov. 23, 2009	Nov. 22, 2010
Software	ADT_Cond_V7.3.7	NA	NA	NA
Software	ADT_ISN_V7.3.7	NA	NA	NA
RF cable (JYEBAO)	5D-FB	Cable-C10.01	Feb. 23, 2010	Feb. 22, 2011
SUHNER Terminator (For ROHDE & SCHWARZ LISN)	65BNC-5001	E1-010773	Feb. 23, 2010	Feb. 22, 2011

- NOTE:**
1. The calibration interval of the above test instruments is 12 months and the calibrations are traceable to NML/ROC and NIST/USA.
 2. The test was performed in Shielded Room No. 10.
 3. The VCCI Site Registration No. C-1852.



A D T

4.2.3 TEST PROCEDURES

- a. The EUT was placed 0.4 meters from the conducting wall of the shielded room with EUT being connected to the power mains through a line impedance stabilization network (LISN). Other support units were connected to the power mains through another LISN. The two LISNs provide 50 ohm/ 50uH of coupling impedance for the measuring instrument.
- b. Both lines of the power mains connected to the EUT were checked for maximum conducted interference.
- c. The frequency range from 150kHz to 30MHz was searched. Emission levels under (Limit - 20dB) was not recorded.

NOTE: All modes of operation were investigated and the worst-case emissions are reported.

4.2.4 DEVIATION FROM TEST STANDARD

No deviation

4.2.5 TEST SETUP

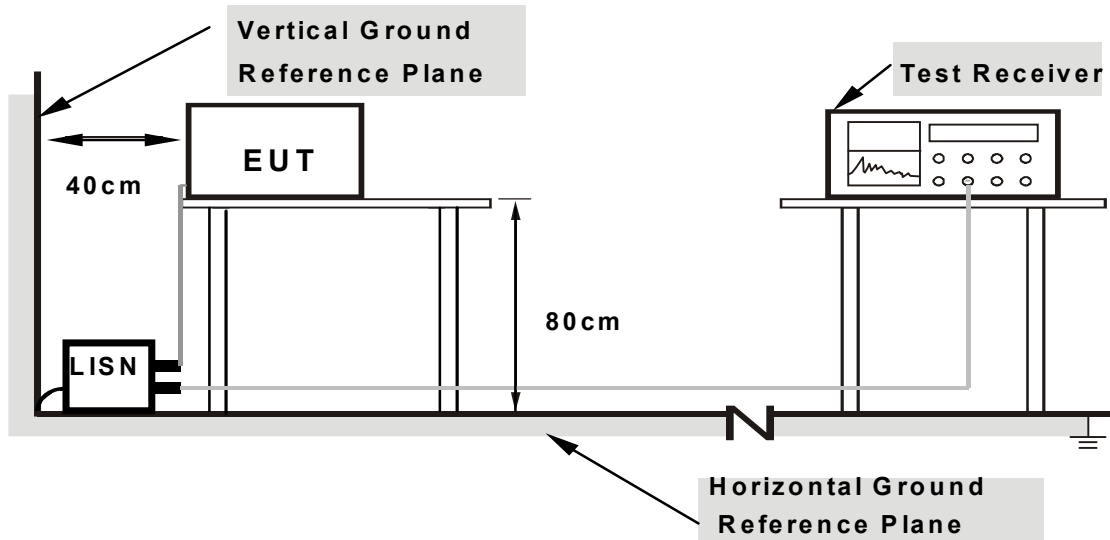

Note: 1. Support units were connected to second LISN.

2. Both of LISNs (AMN) are 80 cm from EUT and at least 80 cm from other units and other metal planes

For the actual test configuration, please refer to the attached file (Test Setup Photo).

4.2.6 EUT OPERATING CONDITIONS

Same as Item 4.1.6.

4.2.7 TEST RESULTS

CONDUCTED WORST-CASE DATA : 802.11g (NORMAL MODE)

CHANNEL	Channel 11		
6dB BANDWIDTH	9kHz	PHASE	Line 1

No	Freq. [MHz]	Corr. Factor (dB)	Reading Value		Emission Level		Limit		Margin	
			[dB (uV)]		[dB (uV)]		[dB (uV)]		(dB)	
			Q.P.	AV.	Q.P.	AV.	Q.P.	AV.	Q.P.	AV.
1	0.170	0.19	47.91	-	48.10	-	64.98	54.98	-16.88	-
2	0.185	0.19	49.22	-	49.41	-	64.25	54.25	-14.84	-
3	0.205	0.19	47.29	-	47.48	-	63.42	53.42	-15.94	-
4	0.259	0.22	42.78	-	43.00	-	61.45	51.45	-18.45	-
5	0.427	0.30	41.92	-	42.22	-	57.30	47.30	-15.08	-
6	9.926	0.71	40.83	-	41.54	-	60.00	50.00	-18.46	-

- REMARKS:**
1. Q.P. and AV. are abbreviations of quasi-peak and average individually.
 2. "-": The Quasi-peak reading value also meets average limit and measurement with the average detector is unnecessary.
 3. The emission levels of other frequencies were very low against the limit.
 4. Margin value = Emission level - Limit value
 5. Correction factor = Insertion loss + Cable loss
 6. Emission Level = Correction Factor + Reading Value.

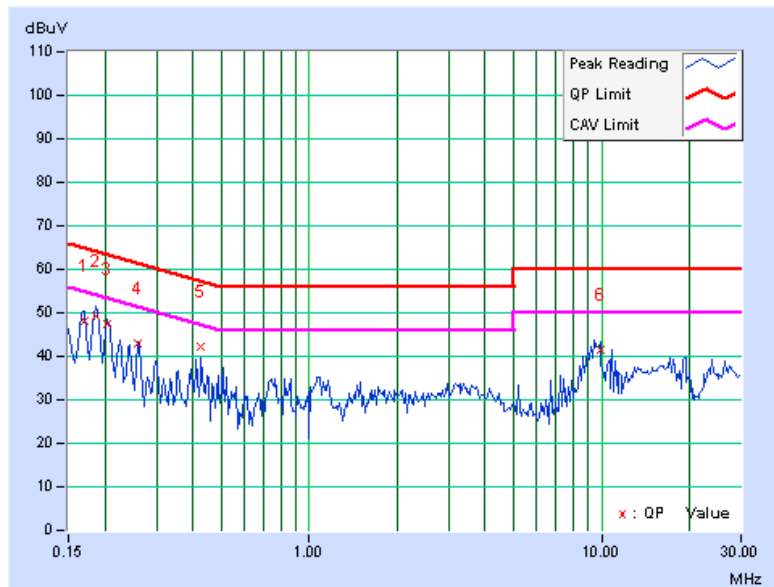



A D T

CHANNEL	Channel 11		
6dB BANDWIDTH	9kHz	PHASE	Line 2

No	Freq. [MHz]	Corr. Factor (dB)	Reading Value		Emission Level		Limit		Margin	
			[dB (uV)]		[dB (uV)]		[dB (uV)]		(dB)	
			Q.P.	AV.	Q.P.	AV.	Q.P.	AV.	Q.P.	AV.
1	0.170	0.29	46.25	-	46.54	-	64.98	54.98	-18.45	-
2	0.185	0.28	47.57	-	47.85	-	64.25	54.25	-16.40	-
3	0.408	0.38	36.60	-	36.98	-	57.69	47.69	-20.71	-
4	0.505	0.38	37.51	-	37.89	-	56.00	46.00	-18.11	-
5	0.767	0.39	37.01	-	37.40	-	56.00	46.00	-18.60	-
6	9.676	0.69	39.36	-	40.05	-	60.00	50.00	-19.95	-

- REMARKS:**
1. Q.P. and AV. are abbreviations of quasi-peak and average individually.
 2. "-": The Quasi-peak reading value also meets average limit and measurement with the average detector is unnecessary.
 3. The emission levels of other frequencies were very low against the limit.
 4. Margin value = Emission level - Limit value
 5. Correction factor = Insertion loss + Cable loss
 6. Emission Level = Correction Factor + Reading Value.

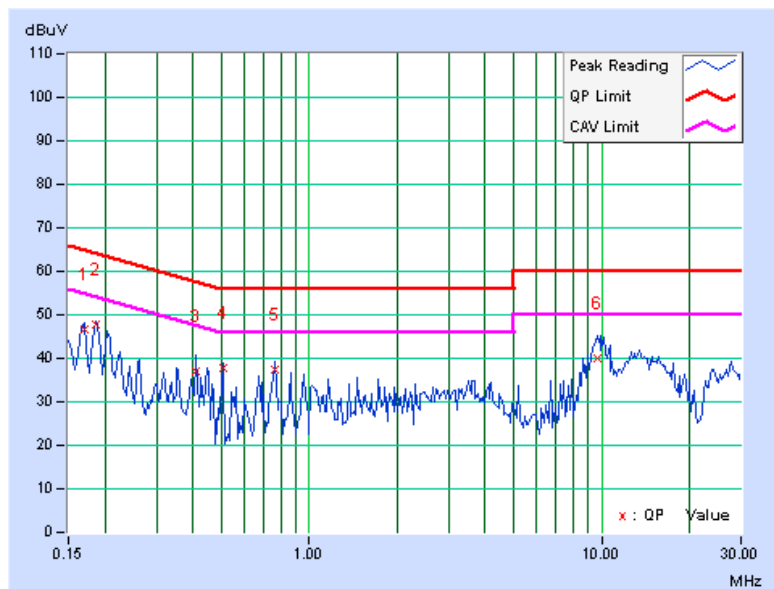



A D T

4.3 6dB BANDWIDTH MEASUREMENT

4.3.1 LIMITS OF 6dB BANDWIDTH MEASUREMENT

The minimum of 6dB Bandwidth Measurement is 0.5 MHz.

4.3.2 TEST INSTRUMENTS

DESCRIPTION & MANUFACTURER	MODEL NO.	SERIAL NO.	DATE OF CALIBRATION	DUE DATE OF CALIBRATION
R&S SPECTRUM ANALYZER	FSP 40	100036	Apr. 27, 2010	Apr. 26, 2011

NOTE: The calibration interval of the above test instruments is 12 months and the calibrations are traceable to NML/ROC and NIST/USA.

4.3.3 TEST PROCEDURE

The transmitter output was connected to the spectrum analyzer through an attenuator. The bandwidth of the fundamental frequency was measured by spectrum analyzer with 100kHz RBW and 300kHz VBW. The 6dB bandwidth is defined as the total spectrum the power of which is higher than peak power minus 6dB.

4.3.4 DEVIATION FROM TEST STANDARD

No deviation

4.3.5 TEST SETUP

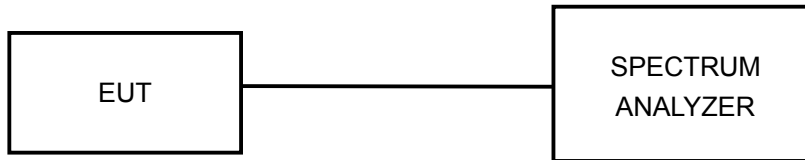

4.3.6 EUT OPERATING CONDITIONS

The software provided by client to enable the EUT under transmission condition continuously at lowest, middle and highest channel frequencies individually.



A D T

4.3.7 TEST RESULTS

802.11b

CHANNEL	CHANNEL FREQUENCY (MHz)	6dB BANDWIDTH (MHz)	MINIMUM LIMIT (MHz)	PASS / FAIL
1	2412	11.07	0.5	PASS
6	2437	11.14	0.5	PASS
11	2462	10.18	0.5	PASS

CH 6

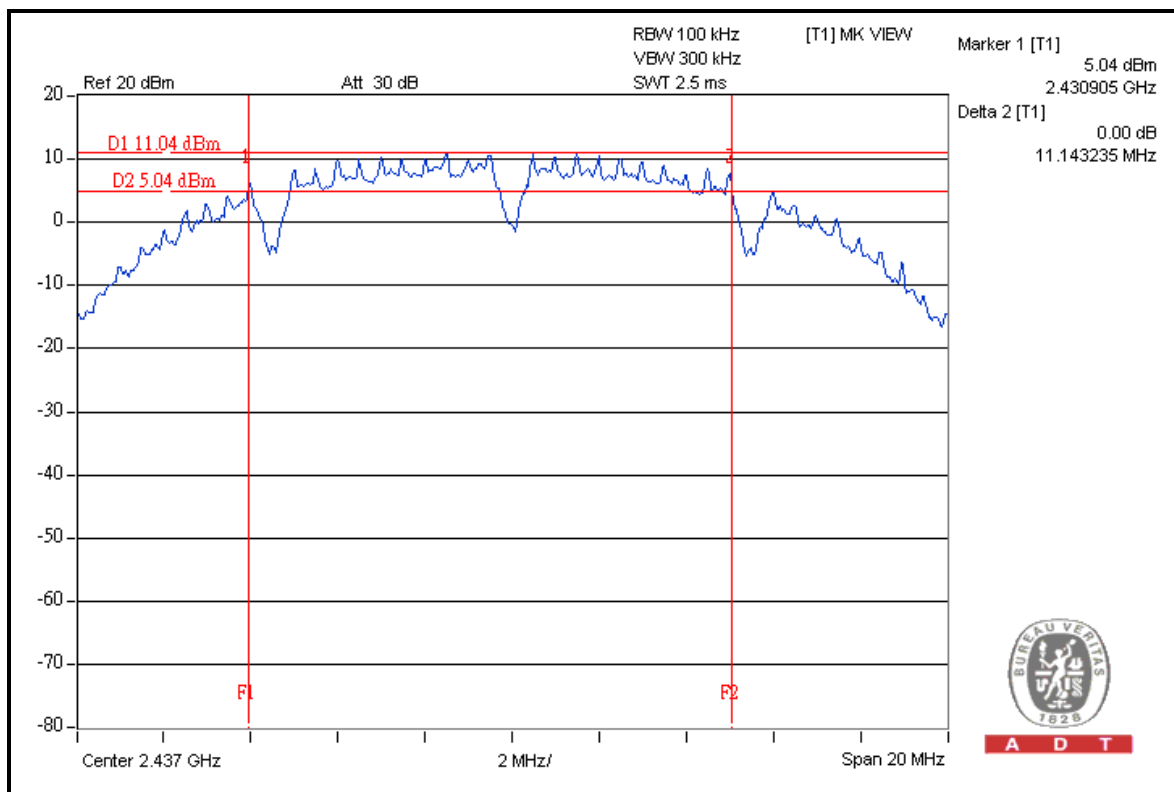



A D T

802.11g (NORMAL MODE)

CHANNEL	CHANNEL FREQUENCY (MHz)	6dB BANDWIDTH (MHz)	MINIMUM LIMIT (MHz)	PASS / FAIL
1	2412	16.38	0.5	PASS
6	2437	16.40	0.5	PASS
11	2462	16.44	0.5	PASS

CH 11

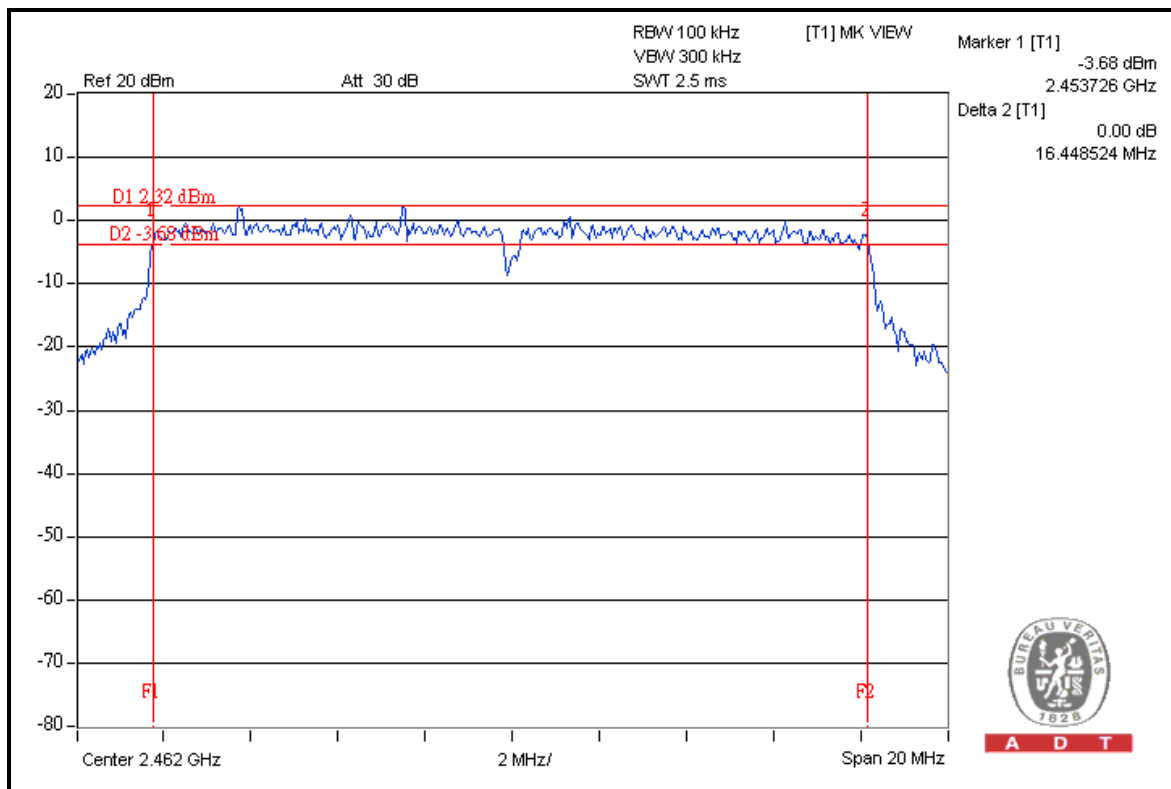



A D T

802.11g (TURBO MODE)

CHANNEL	CHANNEL FREQUENCY (MHz)	6dB BANDWIDTH (MHz)	MINIMUM LIMIT (MHz)	PASS / FAIL
6	2437	30.63	0.5	PASS

CH 6

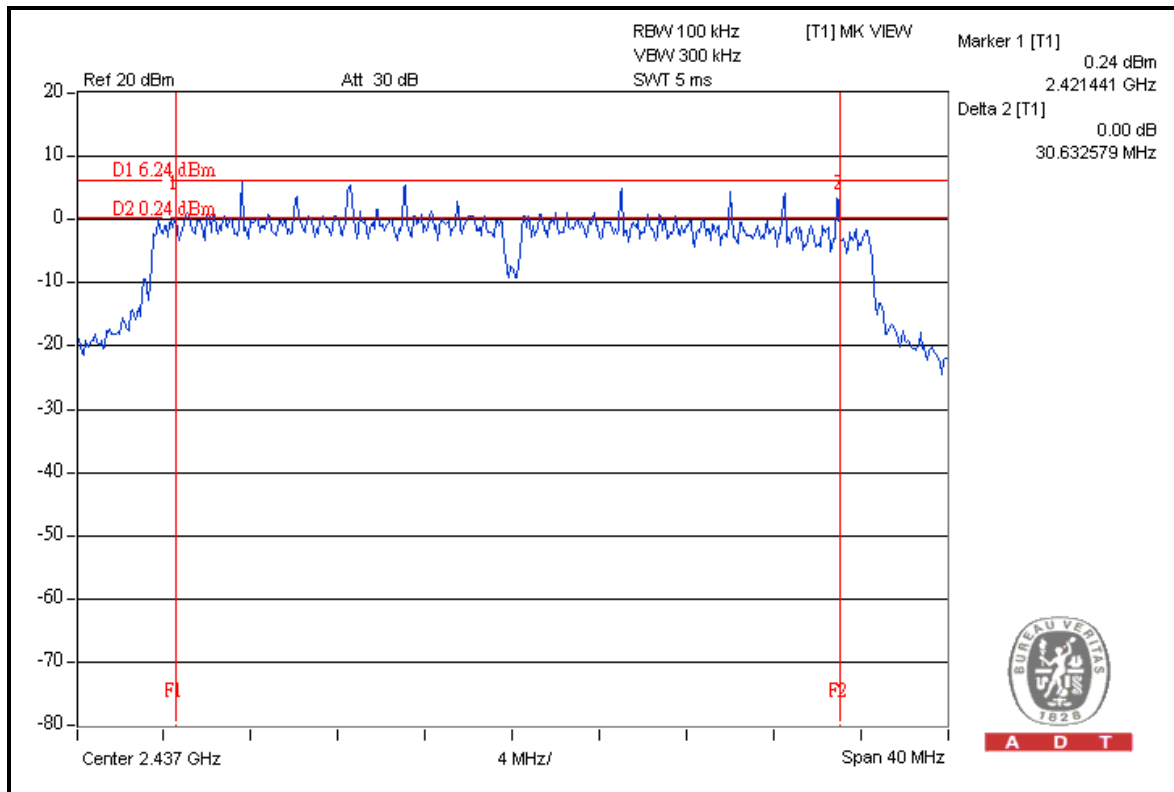



A D T

4.4 MAXIMUM OUTPUT POWER

4.4.1 LIMITS OF MAXIMUM PEAK OUTPUT POWER MEASUREMENT

The Maximum Output Power Measurement is 30dBm.

4.4.2 INSTRUMENTS

DESCRIPTION & MANUFACTURER	MODEL NO.	SERIAL NO.	DATE OF CALIBRATION	DUE DATE OF CALIBRATION
Anritsu Power Sensor	MA2411B	0738404	Apr. 21, 2010	Apr. 20, 2011
Anritsu Power Meter	ML2495A	0842014	Apr. 21, 2010	Apr. 20, 2011

- Note:** 1. The calibration interval of the above test instruments is 12 months and the calibrations are traceable to NML/ROC and NIST/USA.
2. Measurement Bandwidth of ML2495A is 65MHz greater than 6dB bandwidth of emission.

4.4.3 TEST PROCEDURES

A power sensor was used on the output port of the EUT. A power meter was used to read the response of the power sensor. Record the power level.

4.4.4 DEVIATION FROM TEST STANDARD

No deviation

4.4.5 TEST SETUP

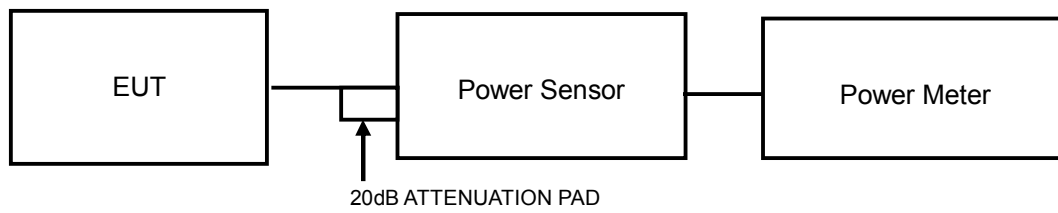

4.4.6 EUT OPERATING CONDITIONS

Same as Item 4.3.6



4.4.7 TEST RESULTS

802.11b

CHANNEL	CHANNEL FREQUENCY (MHz)	PEAK OUTPUT POWER (dBm)	PEAK OUTPUT POWER (mW)	PEAK OUTPUT POWER (dBm)	PASS / FAIL
1	2412	21.0	124.5	30	PASS
6	2437	22.6	181.1	30	PASS
11	2462	20.3	106.7	30	PASS

802.11g (NORMAL MODE)

CHANNEL	CHANNEL FREQUENCY (MHz)	PEAK OUTPUT POWER (dBm)	PEAK OUTPUT POWER (mW)	PEAK OUTPUT POWER (dBm)	PASS / FAIL
1	2412	22.0	159.6	30	PASS
6	2437	23.5	225.9	30	PASS
11	2462	22.2	167.5	30	PASS

802.11g (TURBO MODE)

CHANNEL	CHANNEL FREQUENCY (MHz)	PEAK OUTPUT POWER (dBm)	PEAK OUTPUT POWER (mW)	PEAK OUTPUT POWER (dBm)	PASS / FAIL
6	2437	22.9	195.9	30	PASS



A D T

4.5 POWER SPECTRAL DENSITY MEASUREMENT

4.5.1 LIMITS OF POWER SPECTRAL DENSITY MEASUREMENT

The Maximum of Power Spectral Density Measurement is 8dBm.

4.5.2 TEST INSTRUMENTS

DESCRIPTION & MANUFACTURER	MODEL NO.	SERIAL NO.	DATE OF CALIBRATION	DUE DATE OF CALIBRATION
R&S SPECTRUM ANALYZER	FSP 40	100036	Apr. 27, 2010	Apr. 26, 2011

NOTE: The calibration interval of the above test instruments is 12 months and the calibrations are traceable to NML/ROC and NIST/USA.

4.5.3 TEST PROCEDURE

The transmitter output was connected to the spectrum analyzer through an attenuator, the bandwidth of the fundamental frequency was measured with the spectrum analyzer using 3kHz RBW and 30kHz VBW, set sweep time = span/3kHz. The power spectral density was measured and recorded.

The sweep time is allowed to be longer than span/3kHz for a full response of the mixer in the spectrum analyzer.



A D T

4.5.4 DEVIATION FROM TEST STANDARD

No deviation

4.5.5 TEST SETUP

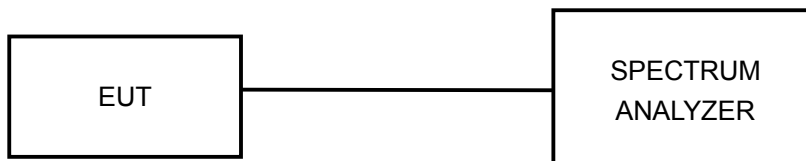

4.5.6 EUT OPERATING CONDITION

Same as Item 4.3.6



A D T

4.5.7 TEST RESULTS

802.11b

CHANNEL	CHANNEL FREQUENCY (MHz)	RF POWER LEVEL IN 3kHz BW (dBm)	MAXIMUM LIMIT (dBm)	PASS / FAIL
1	2412	-3.7	8	PASS
6	2437	-3.4	8	PASS
11	2462	-6.8	8	PASS

CH 6

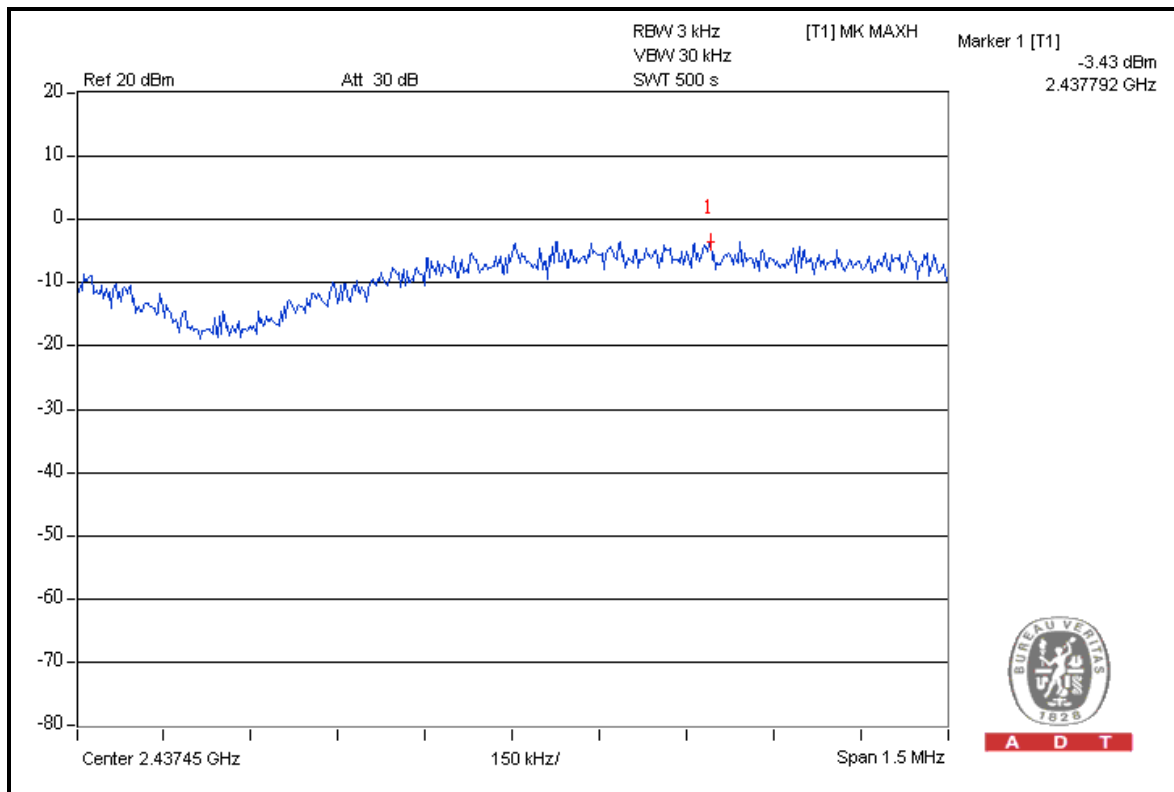

A D T



A D T

802.11g (NORMAL MODE)

CHANNEL	CHANNEL FREQUENCY (MHz)	RF POWER LEVEL IN 3kHz BW (dBm)	MAXIMUM LIMIT (dBm)	PASS / FAIL
1	2412	-11.7	8	PASS
6	2437	-5.8	8	PASS
11	2462	-11.6	8	PASS

CH 6

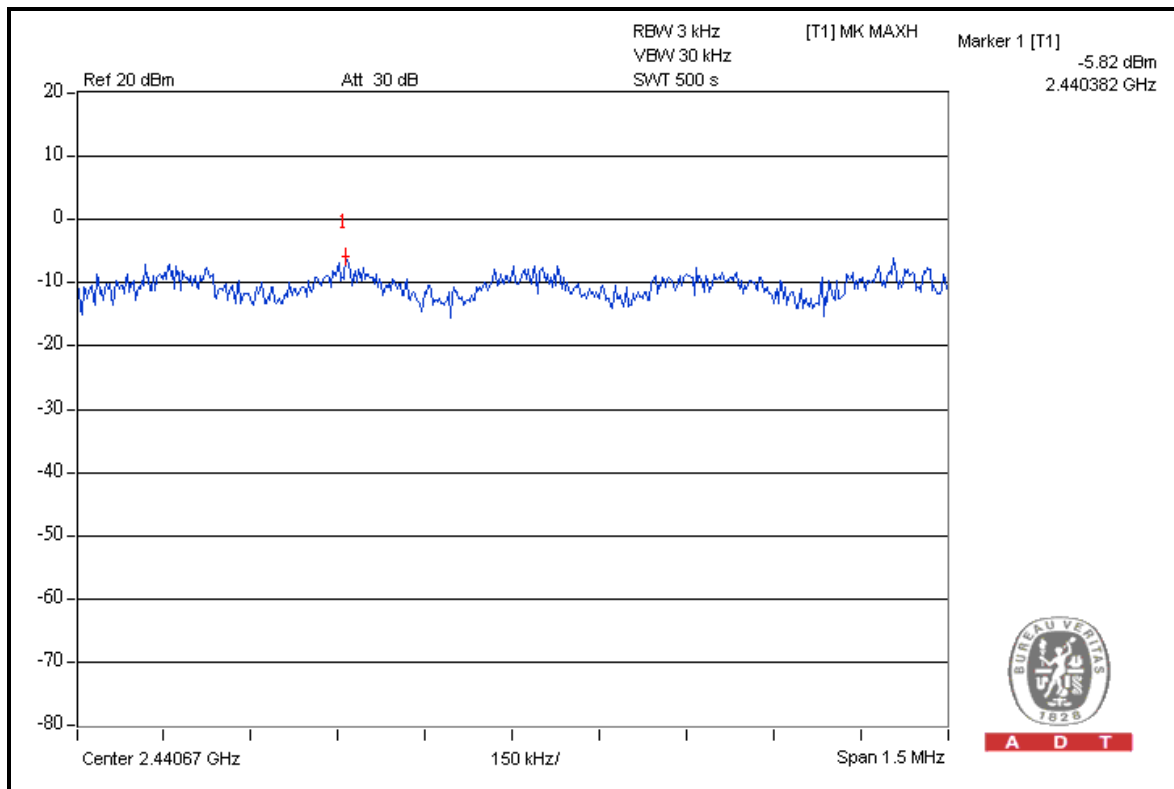



A D T

802.11g (TURBO MODE)

CHANNEL	CHANNEL FREQUENCY (MHz)	RF POWER LEVEL IN 3kHz BW (dBm)	MAXIMUM LIMIT (dBm)	PASS / FAIL
6	2437	-11.2	8	PASS

CH 6

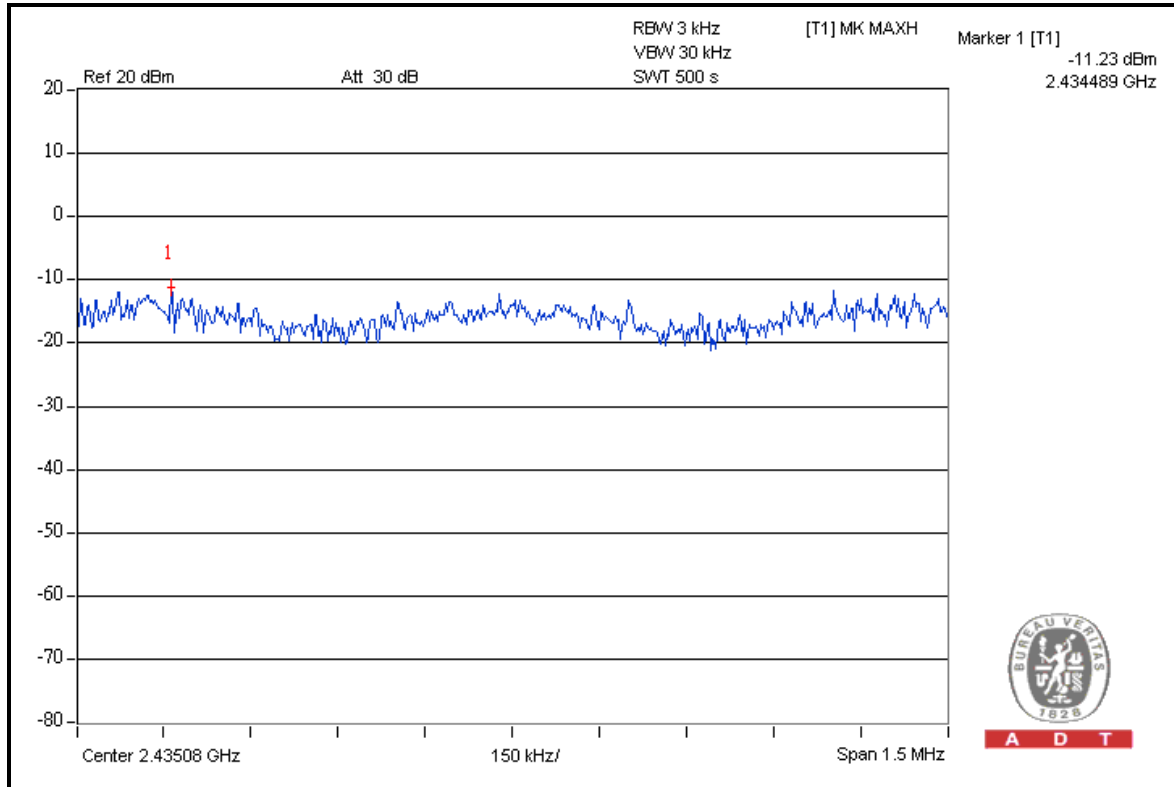



A D T

4.6 BAND EDGES MEASUREMENT

4.6.1 LIMITS OF BAND EDGES MEASUREMENT

Below -20dB of the highest emission level of operating band (in 100kHz Resolution Bandwidth).

4.6.2 TEST INSTRUMENTS

DESCRIPTION & MANUFACTURER	MODEL NO.	SERIAL NO.	DATE OF CALIBRATION	CALIBRATED UNTIL
FOR CONDUCTED MEASUREMENT:				
R&S SPECTRUM ANALYZER	FSP 40	100036	Apr. 27, 2010	Apr. 26, 2011
FOR RADIATED MEASUREMENT:				
HP Preamplifier	8447D	2432A03504	May 06, 2010	May 05, 2011
HP Preamplifier	8449B	3008A01924	Aug. 31, 2009	Aug. 30, 2010
HP Preamplifier	8449B	3008A01292	Aug. 10, 2009	Aug. 09, 2010
ROHDE & SCHWARZ TEST RECEIVER	ESU26	100005	Jun. 10, 2010	Jun. 09, 2011
Schwarzbeck Antenna	VULB 9168	137	Apr. 29, 2010	Apr. 28, 2011
Schwarzbeck Antenna	VHBA 9123	480	Apr. 29, 2010	Apr. 28, 2011
EMCO Horn Antenna	3115	6714	Oct. 26, 2009	Oct. 25, 2010
EMCO Horn Antenna	3115	9312-4192	Apr. 23, 2010	Apr. 22, 2011
ADT. Turn Table	TT100	0306	NA	NA
ADT. Tower	AT100	0306	NA	NA
Software	ADT_Radiated_V7 .6.15.9.2	NA	NA	NA
SUHNER RF cable	SF104-26.5	CABLE-CH6-17 m-01	Aug. 20, 2009	Aug. 19, 2010
ROHDE & SCHWARZ Spectrum Analyzer	FSP 40	100036	Apr. 06, 2010	Apr. 05, 2011

- NOTE:**
1. The calibration interval of the above test instruments is 12/24 months. And the calibrations are traceable to NML/ROC and NIST/USA.
 2. The horn antenna and HP preamplifier (model: 8449B) are used only for the measurement of emission frequency above 1GHz if tested.
 3. The test was performed in Chamber No. 6.
 4. The Industry Canada Reference No. IC 7450E-6.
 5. The FCC Site Registration No. is 447212.



A D T

4.6.3 TEST PROCEDURE

FOR CONDUCTED MEASUREMENT:

The transmitter output was connected to the spectrum analyzer via a low loss cable. Set both RBW and VBW of spectrum analyzer to 100kHz and 300kHz with suitable frequency span including 100MHz bandwidth from band edge. The band edges was measured and recorded.

The spectrum plots (Peak RBW =100kHz, VBW = 300kHz; Average RBW = 1MHz, VBW = 10Hz) are attached on the following pages.

FOR RADIATED MEASUREMENT:

- a. The EUT was placed on the top of a rotating table 0.8 meters above the ground at a 3 meter semi-anechoic chamber. The table was rotated 360 degrees to determine the position of the highest radiation.
- b. The EUT was set 3 meters away from the interference-receiving antenna, which was mounted on the top of a variable-height antenna tower.
- c. The height of antenna is varied from one meter to four meters above the ground to determine the maximum value of the field strength. Both horizontal and vertical polarizations of the antenna are set to make the measurement.
- d. For each suspected emission, the EUT was arranged to its worst case and then the antenna was tuned to heights from 1 meter to 4 meters and the rotatable table was turned from 0 degrees to 360 degrees to find the maximum reading.
- e. Set both RBW and VBW of spectrum analyzer to 100kHz and 300kHz with suitable frequency span including 100MHz bandwidth from band edge. The band edges was measured and recorded.

The spectrum plots (Peak RBW =100kHz, VBW = 300kHz; Average RBW = 1MHz, VBW = 10Hz) are attached on the following pages.

NOTE: The resolution bandwidth of test receiver/spectrum analyzer is 1MHz and the video bandwidth is 10Hz for Average detection (AV) at frequency above 1GHz.

4.6.4 DEVIATION FROM TEST STANDARD

No deviation

4.6.5 EUT OPERATING CONDITION

Same as Item 4.3.6



A D T

4.6.6 TEST RESULTS

The spectrum plots are attached on the following pages. D1 line indicates the highest level, and D2 line indicates the 20dB offset below D1. It shows compliance with the requirement in part 15.247(d).

802.11b

RESTRICT BAND (2310 ~ 2390 MHz)

FREQUENCY (MHz)	FUNDAMENTAL EMISSION (dBuV/m)	DELTA (dB)	MAXIMUM FIELD STRENGTH IN RESTRICT BAND (dBuV/m)	LIMIT (dBuV/m)
2412.00 (PK)	110.4	49.8	60.6	74.00
2412.00 (AV)	105.1	51.4	53.7	54.00

RESTRICT BAND (2483.5 ~ 2500 MHz)

FREQUENCY (MHz)	FUNDAMENTAL EMISSION (dBuV/m)	DELTA (dB)	MAXIMUM FIELD STRENGTH IN RESTRICT BAND (dBuV/m)	LIMIT (dBuV/m)
2462.00 (PK)	110.6	51.6	59.0	74.00
2462.00 (AV)	105.7	54.0	51.7	54.00

NOTE:

1. Delta = Amplitude between the peak of the fundamental and the peak of the band edge emission. Please check following 3 pages.
2. Maximum field strength in restrict band = Fundamental emission – Delta.



A D T

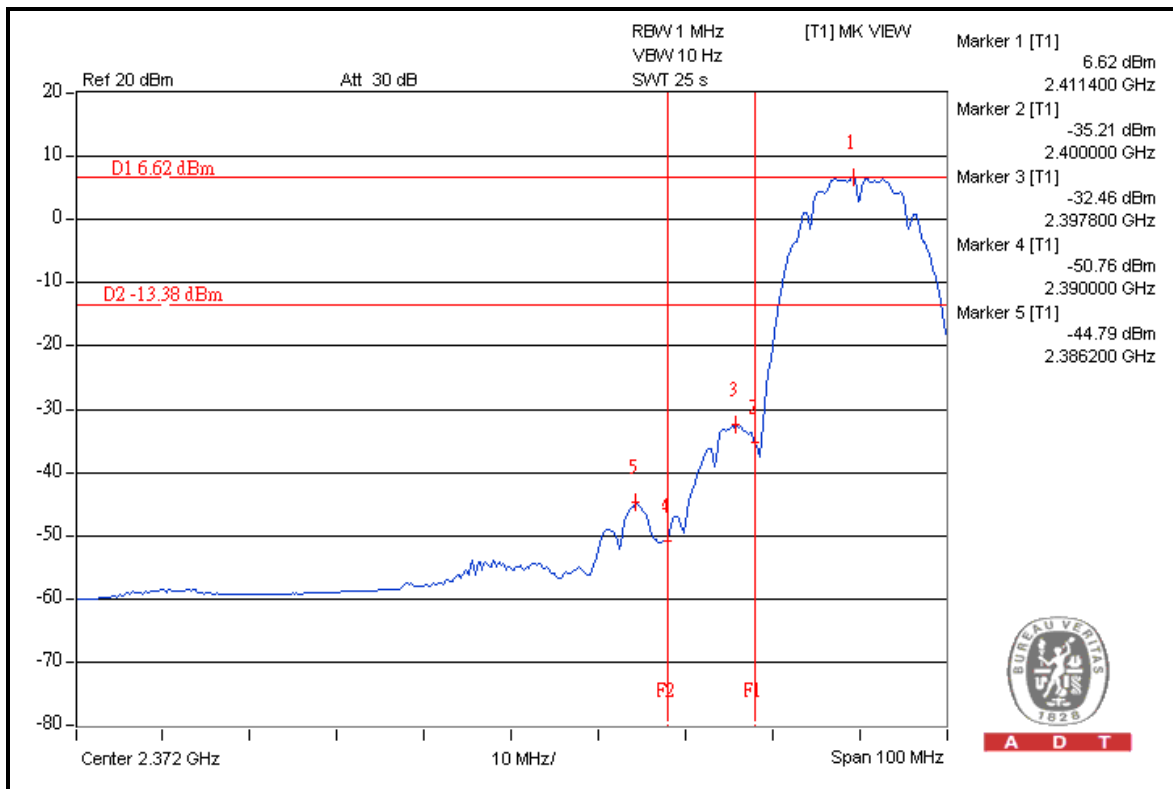
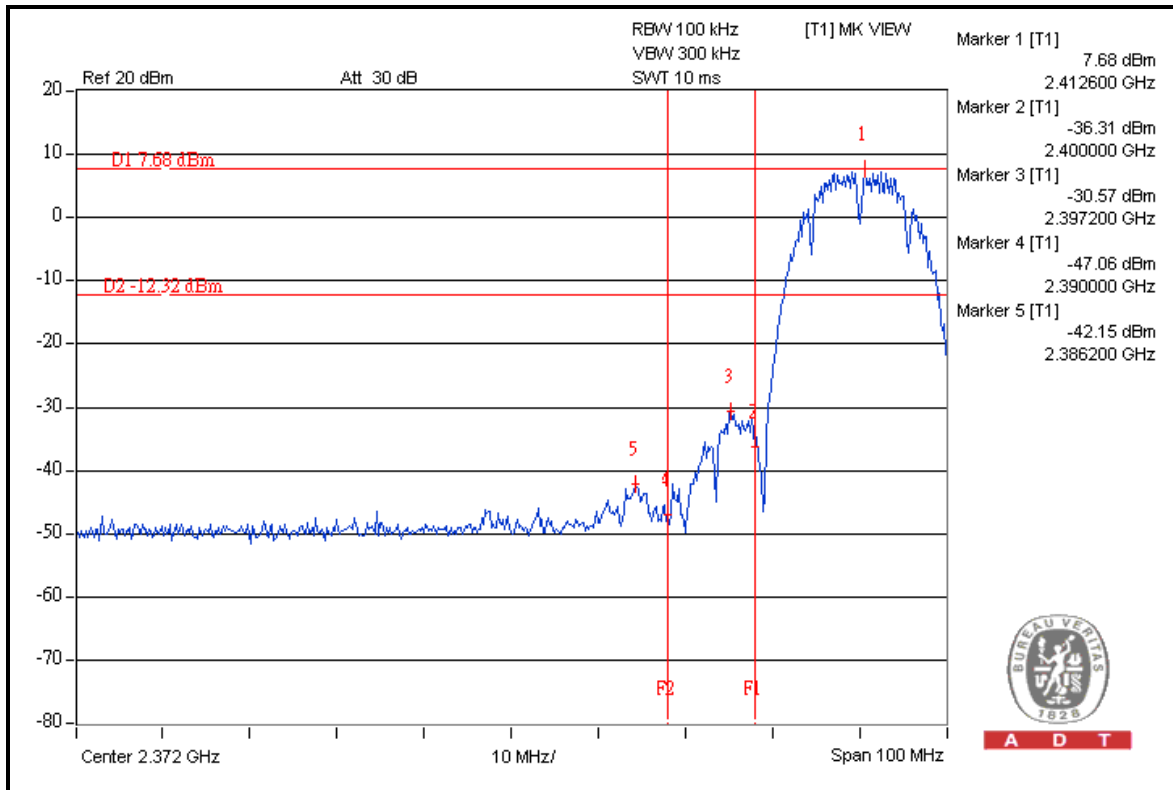



A D T

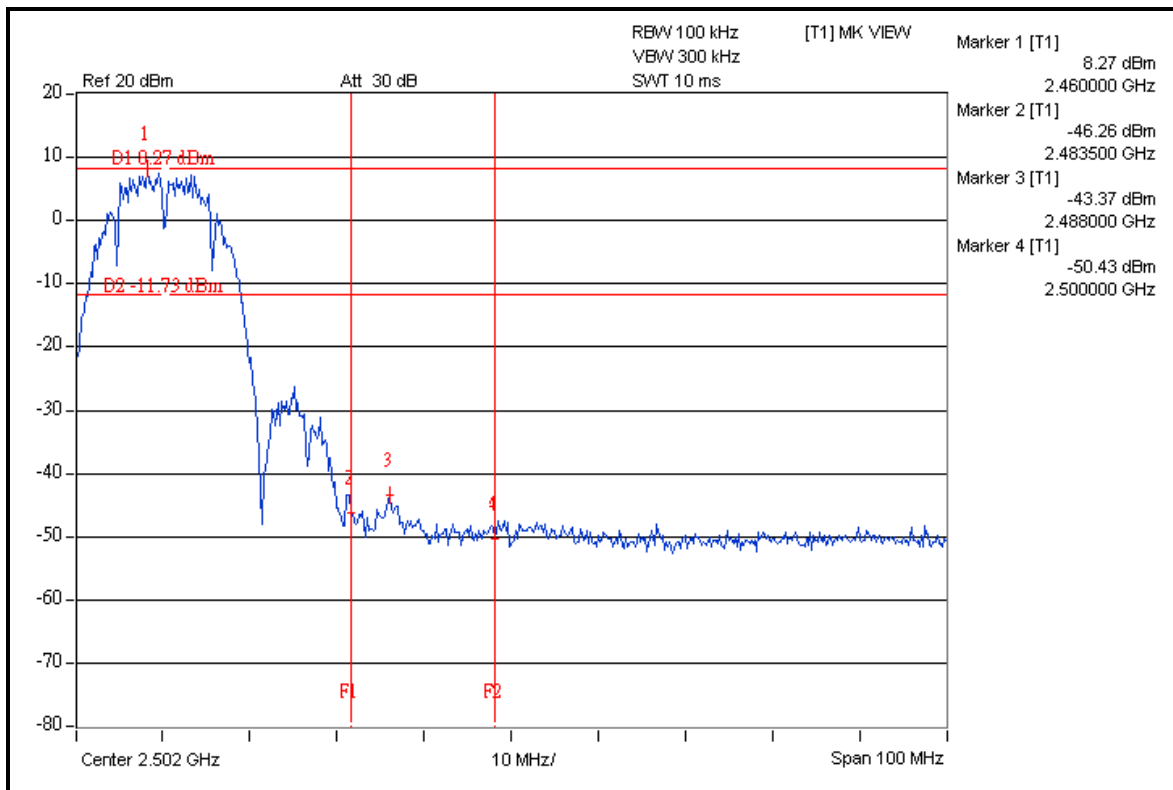
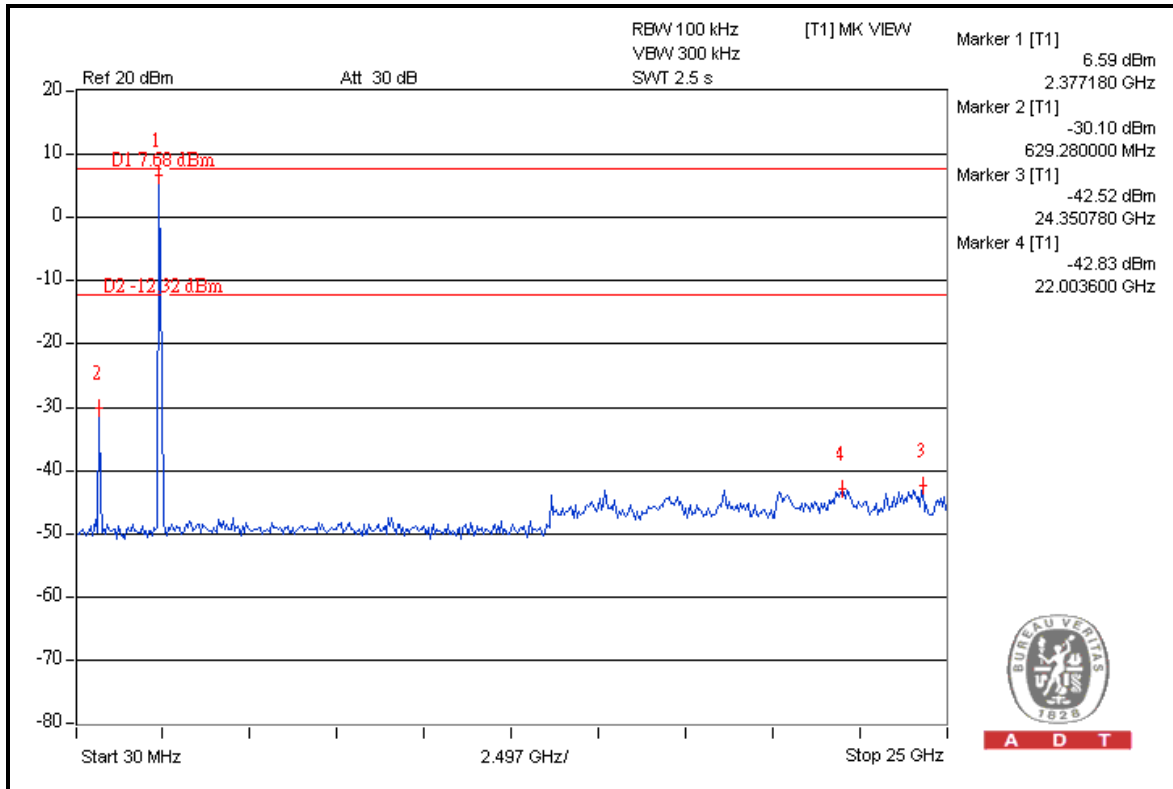



A D T

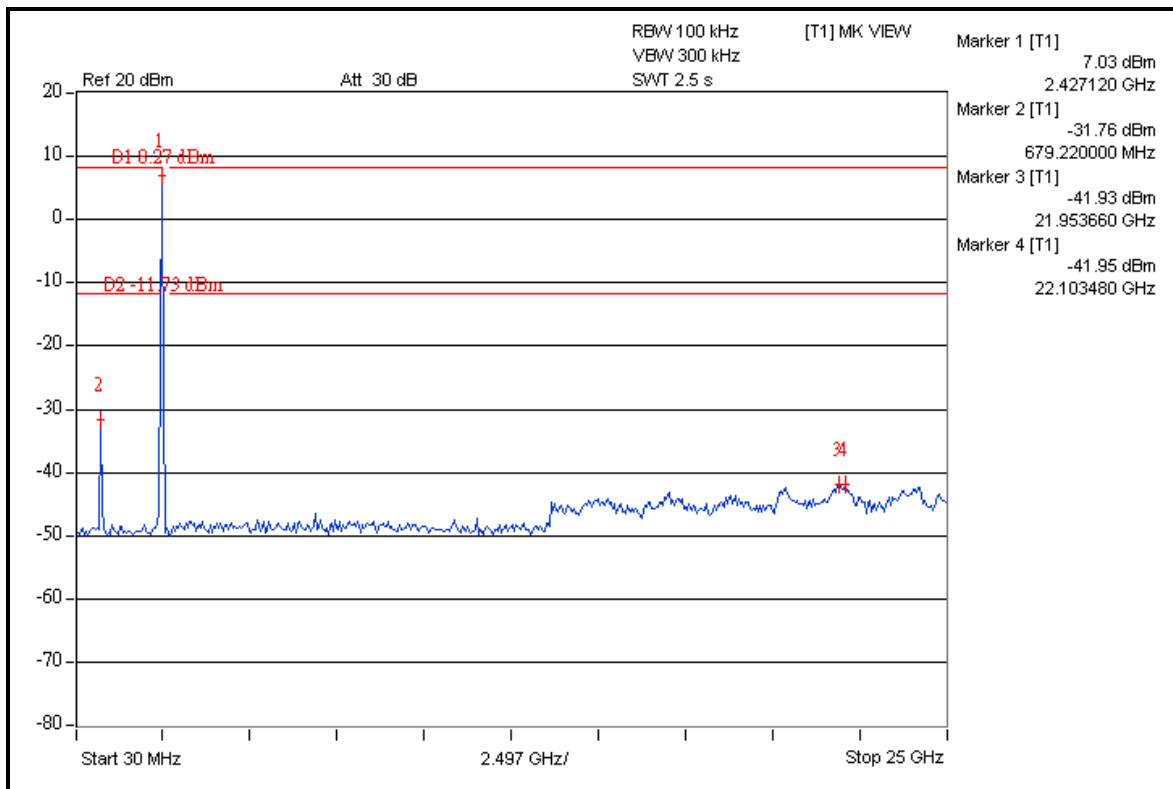
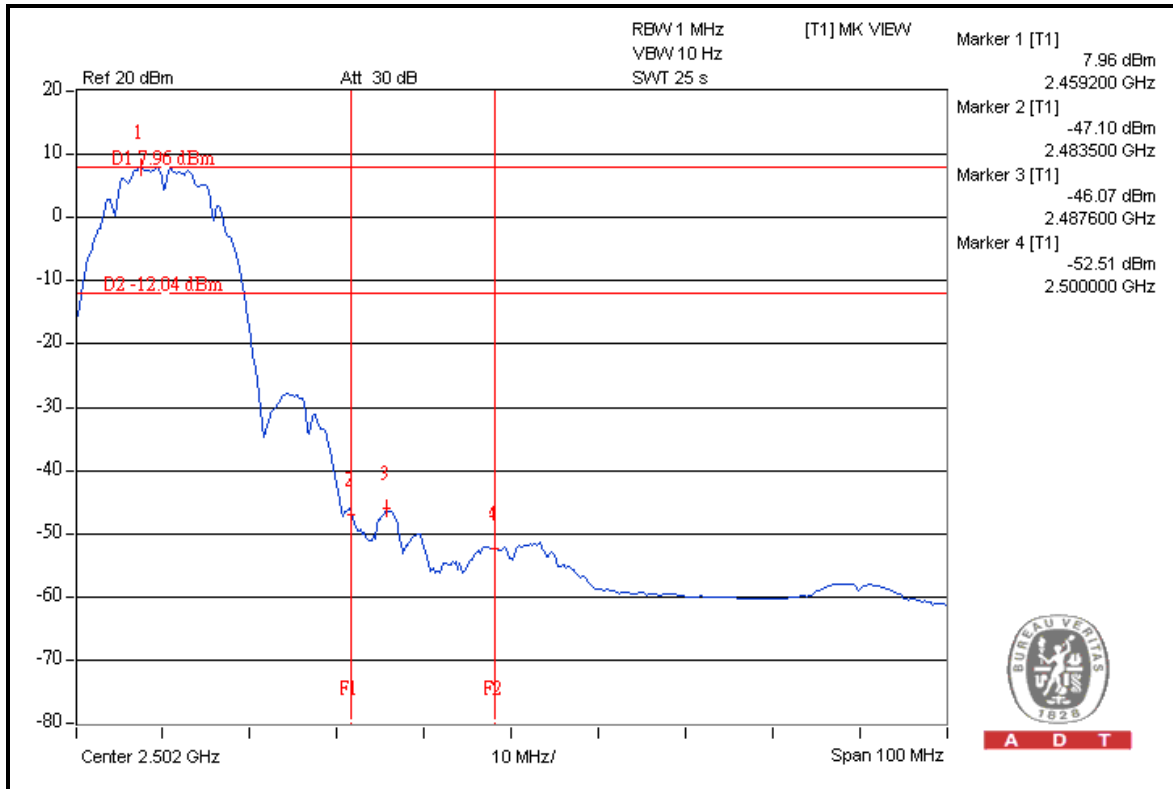



A D T

802.11g (NORMAL MODE)

RESTRICT BAND (2310 ~ 2390 MHz)

FREQUENCY (MHz)	FUNDAMENTAL EMISSION (dBuV/m)	DELTA (dB)	MAXIMUM FIELD STRENGTH IN RESTRICT BAND (dBuV/m)	LIMIT (dBuV/m)
2412.00 (PK)	109.6	45.4	64.2	74.00
2412.00 (AV)	98.5	49.5	49.0	54.00

RESTRICT BAND (2483.5 ~ 2500 MHz)

FREQUENCY (MHz)	FUNDAMENTAL EMISSION (dBuV/m)	DELTA (dB)	MAXIMUM FIELD STRENGTH IN RESTRICT BAND (dBuV/m)	LIMIT (dBuV/m)
2462.00 (PK)	109.6	45.4	64.2	74.00
2462.00 (AV)	98.3	48.7	49.6	54.00

NOTE:

1. Delta = Amplitude between the peak of the fundamental and the peak of the band edge emission. Please check following 3 pages.
2. Maximum field strength in restrict band = Fundamental emission – Delta.



A D T

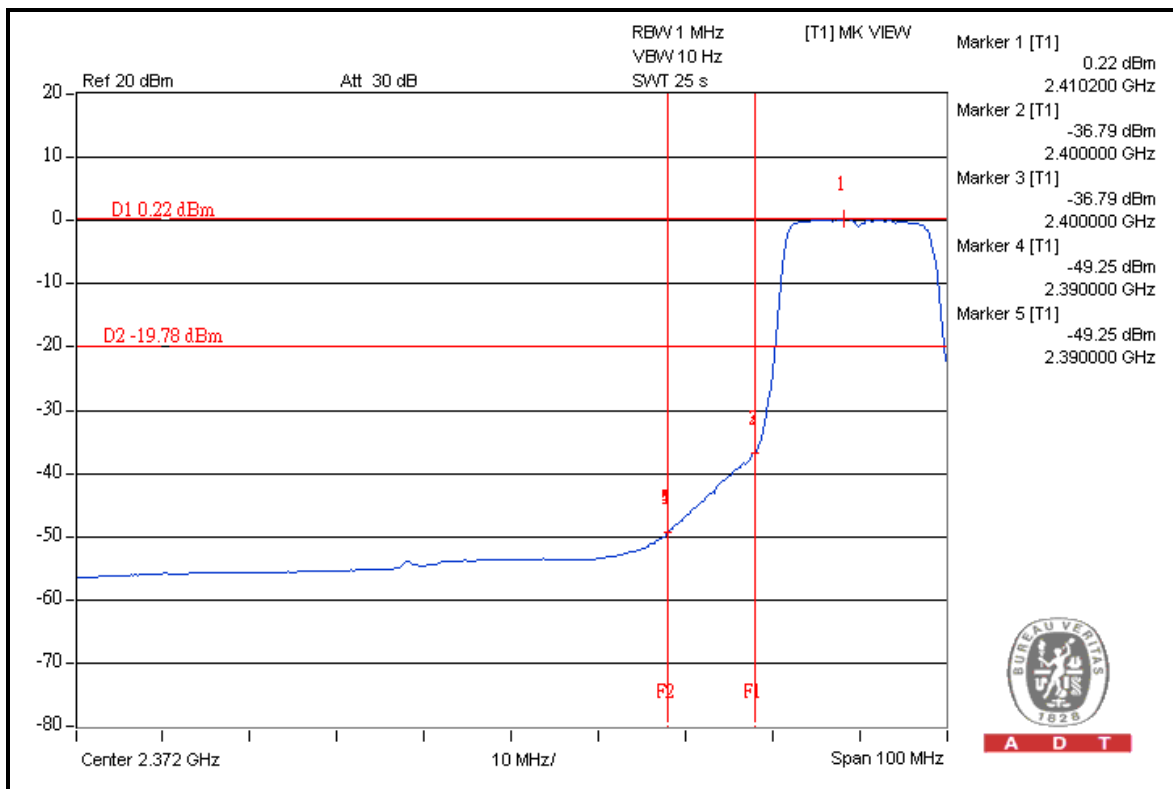
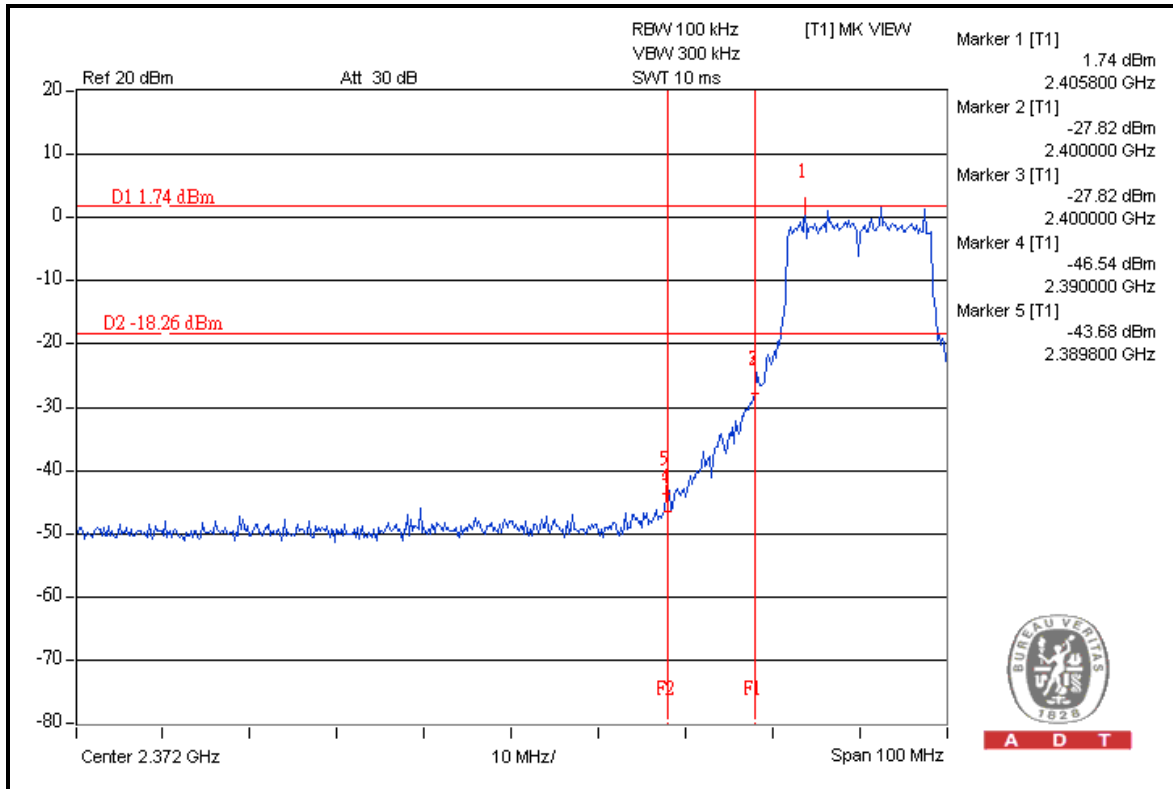



A D T

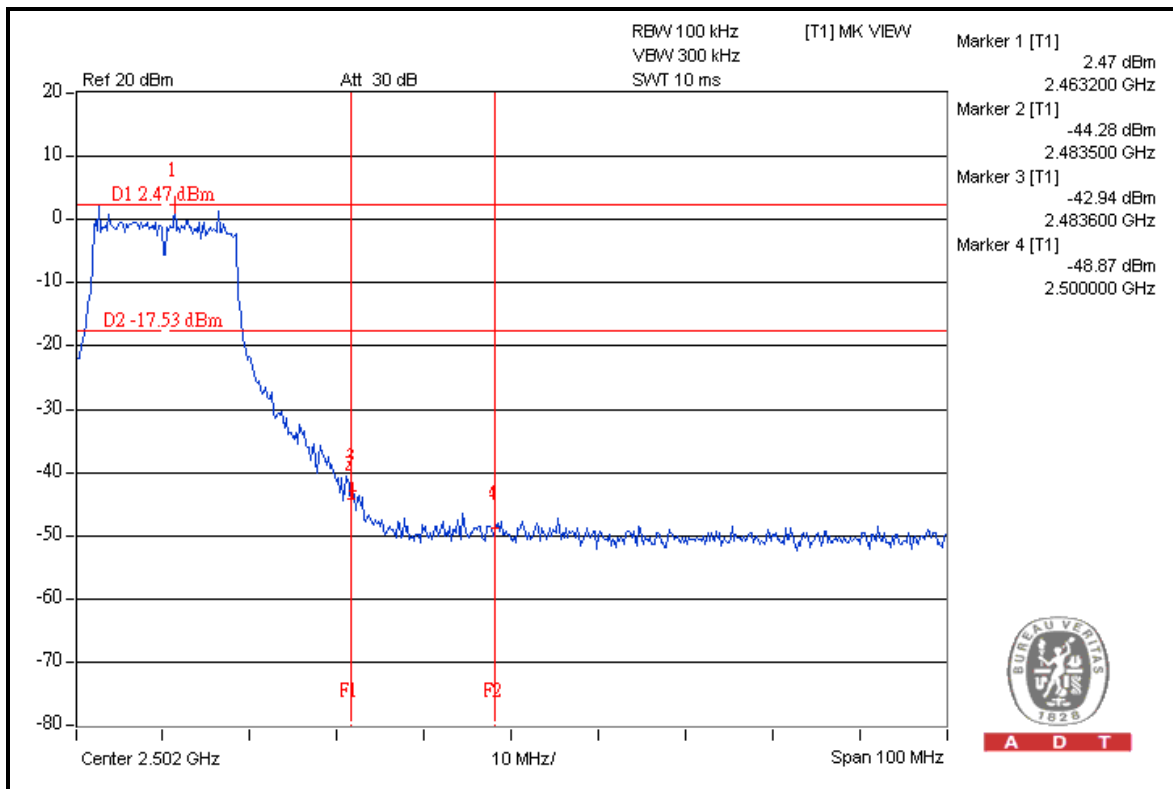
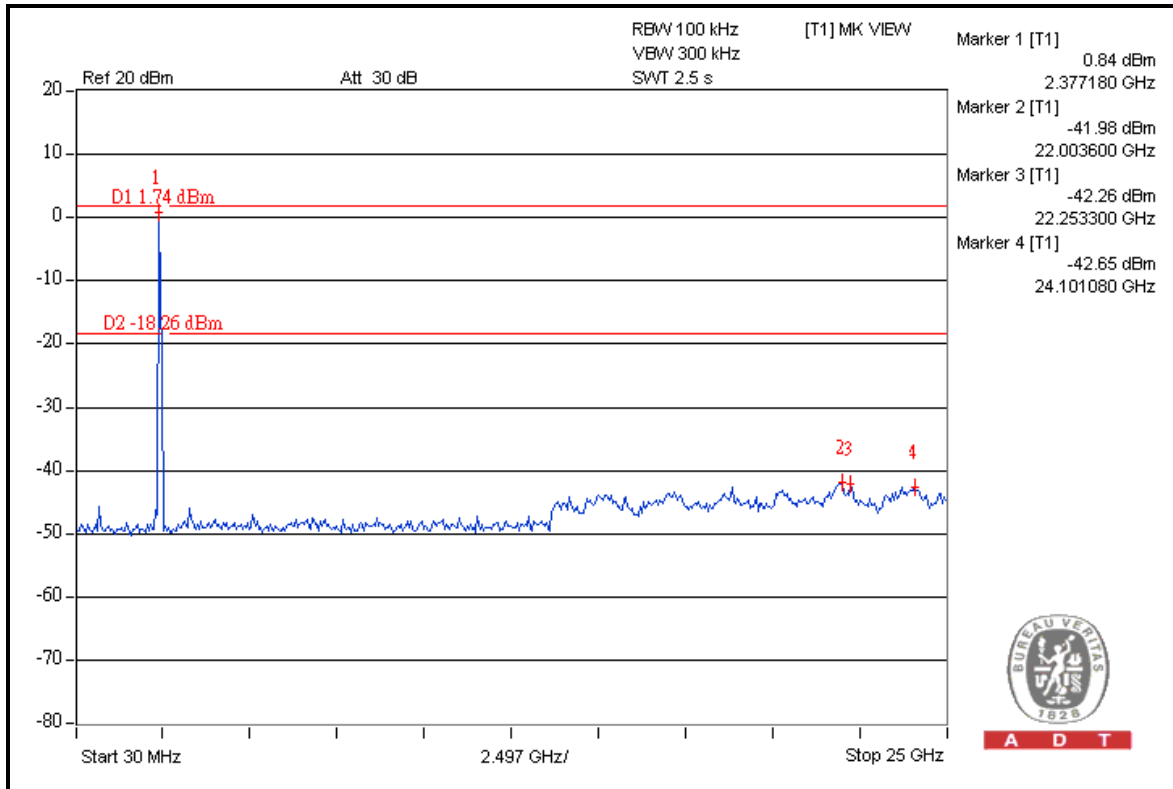



A D T

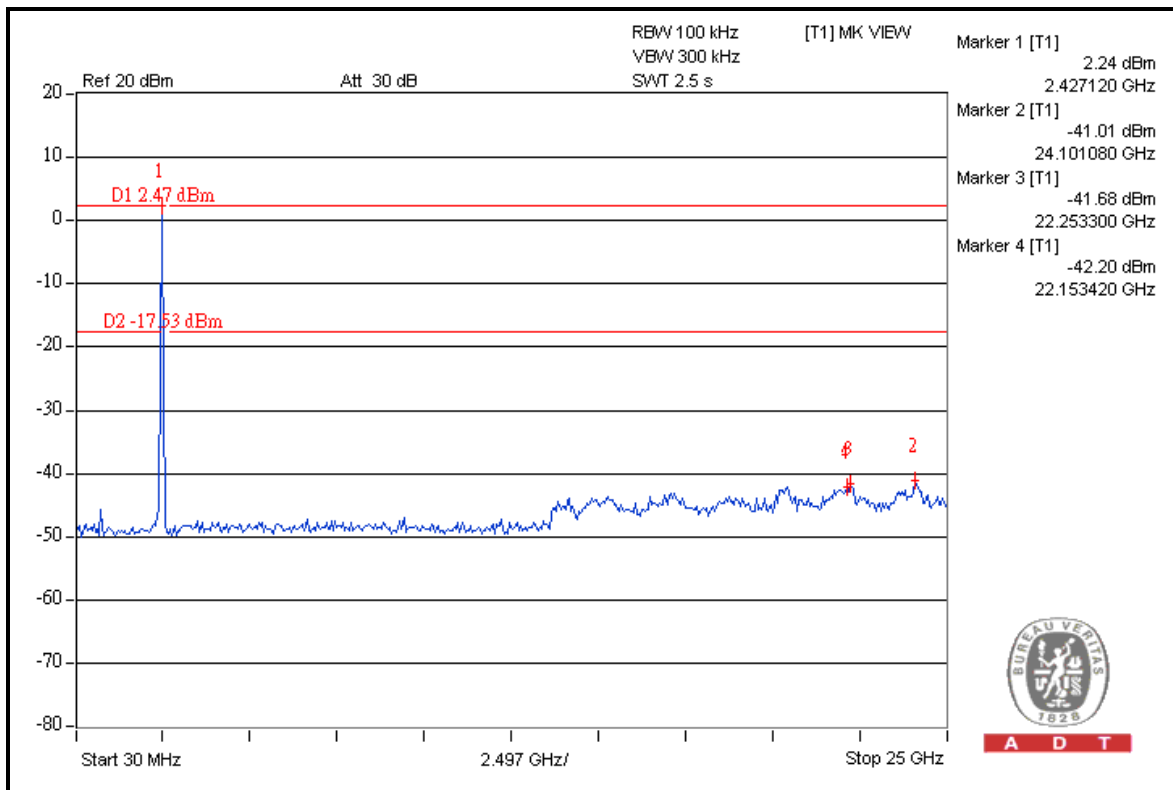
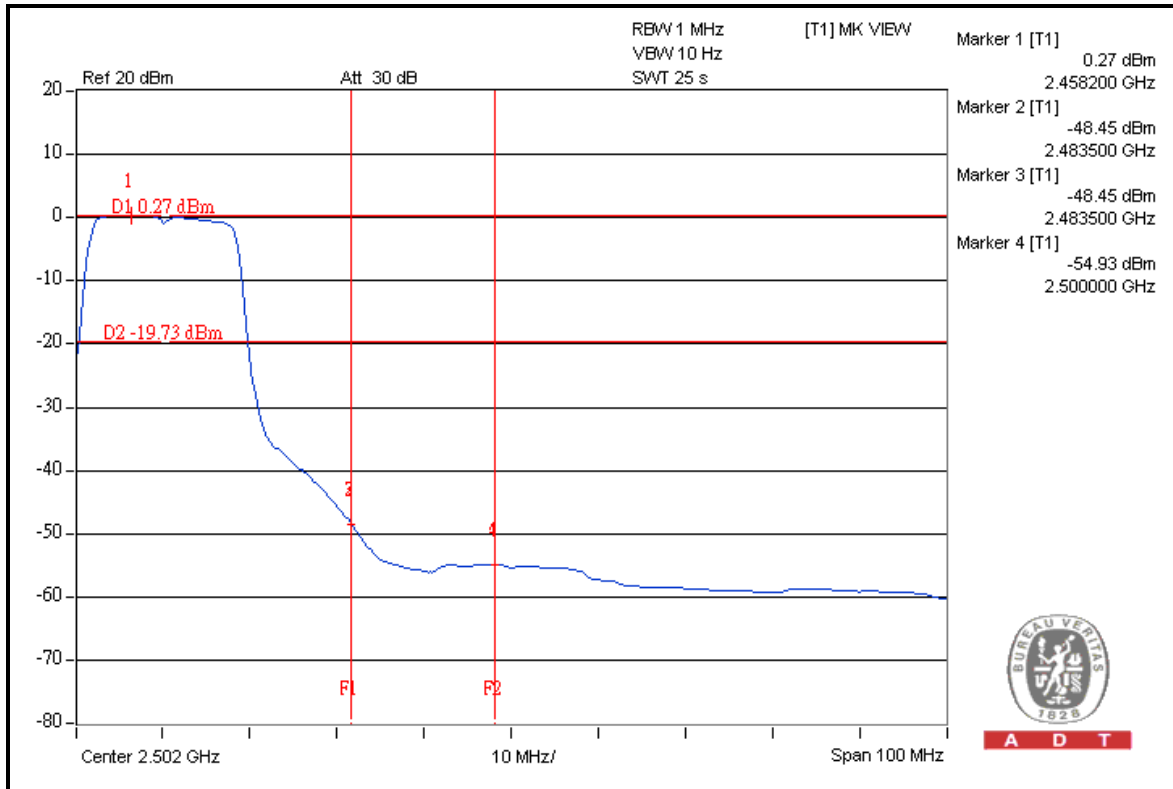



A D T

802.11g (TURBO MODE)

RESTRICT BAND (2310 ~ 2390 MHz)

FREQUENCY (MHz)	FUNDAMENTAL EMISSION (dBuV/m)	DELTA (dB)	MAXIMUM FIELD STRENGTH IN RESTRICT BAND (dBuV/m)	LIMIT (dBuV/m)
2437.00 (PK)	108.1	48.3	59.8	74.00
2437.00 (AV)	97.6	43.9	53.7	54.00

RESTRICT BAND (2483.5 ~ 2500 MHz)

FREQUENCY (MHz)	FUNDAMENTAL EMISSION (dBuV/m)	DELTA (dB)	MAXIMUM FIELD STRENGTH IN RESTRICT BAND (dBuV/m)	LIMIT (dBuV/m)
2437.00 (PK)	108.1	47.6	60.5	74.00
2437.00 (AV)	97.6	44.5	53.1	54.00

NOTE:

1. Delta = Amplitude between the peak of the fundamental and the peak of the band edge emission. Please check following 3 pages.
2. Maximum field strength in restrict band = Fundamental emission – Delta.



A D T

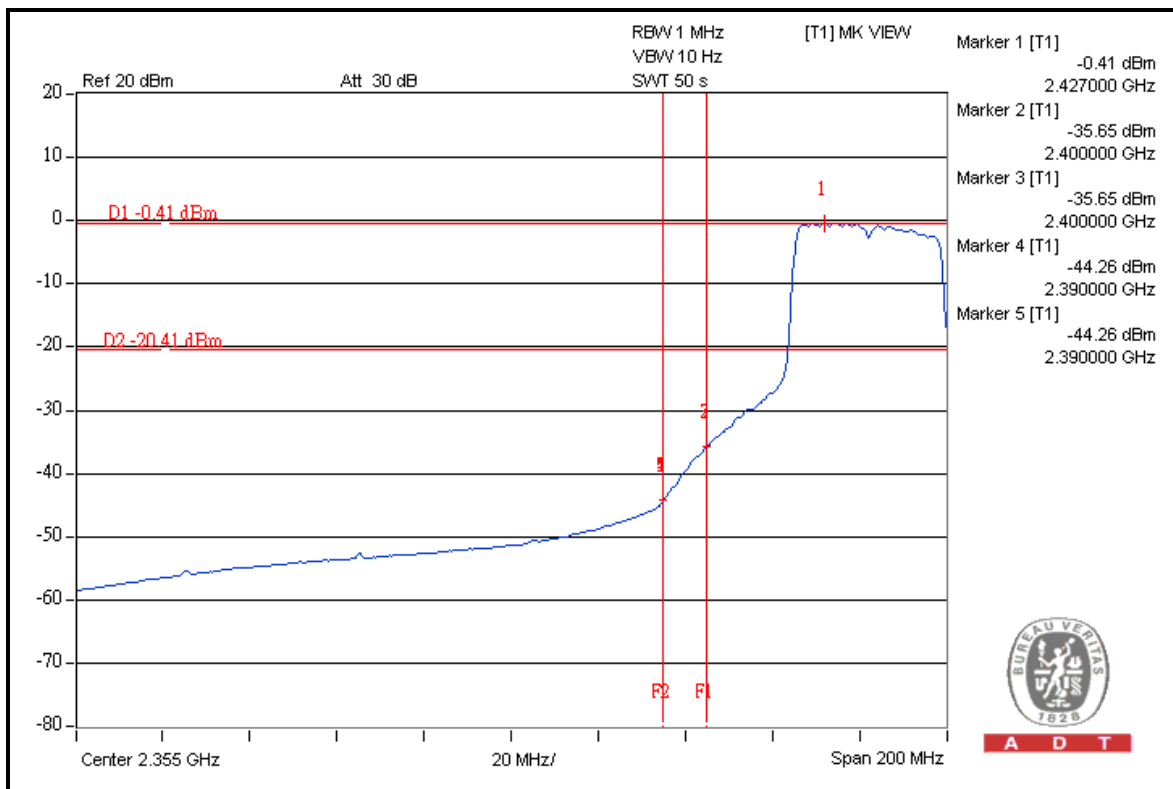
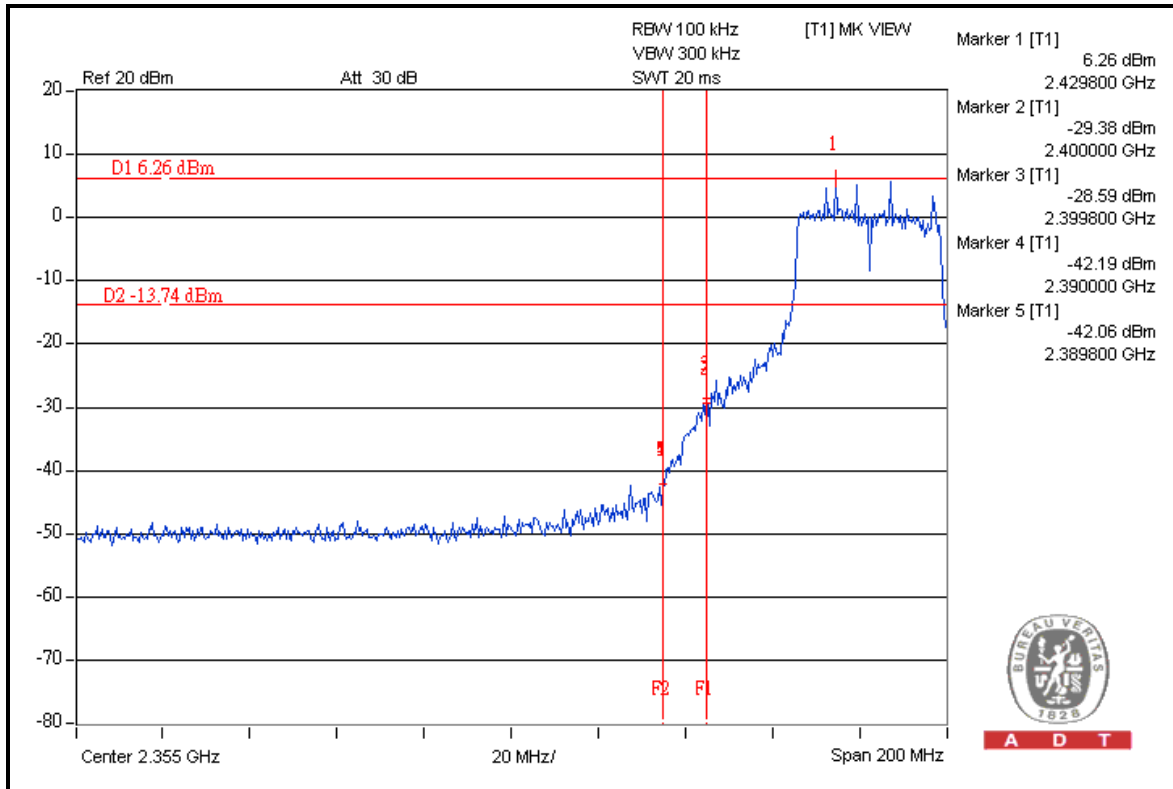



A D T

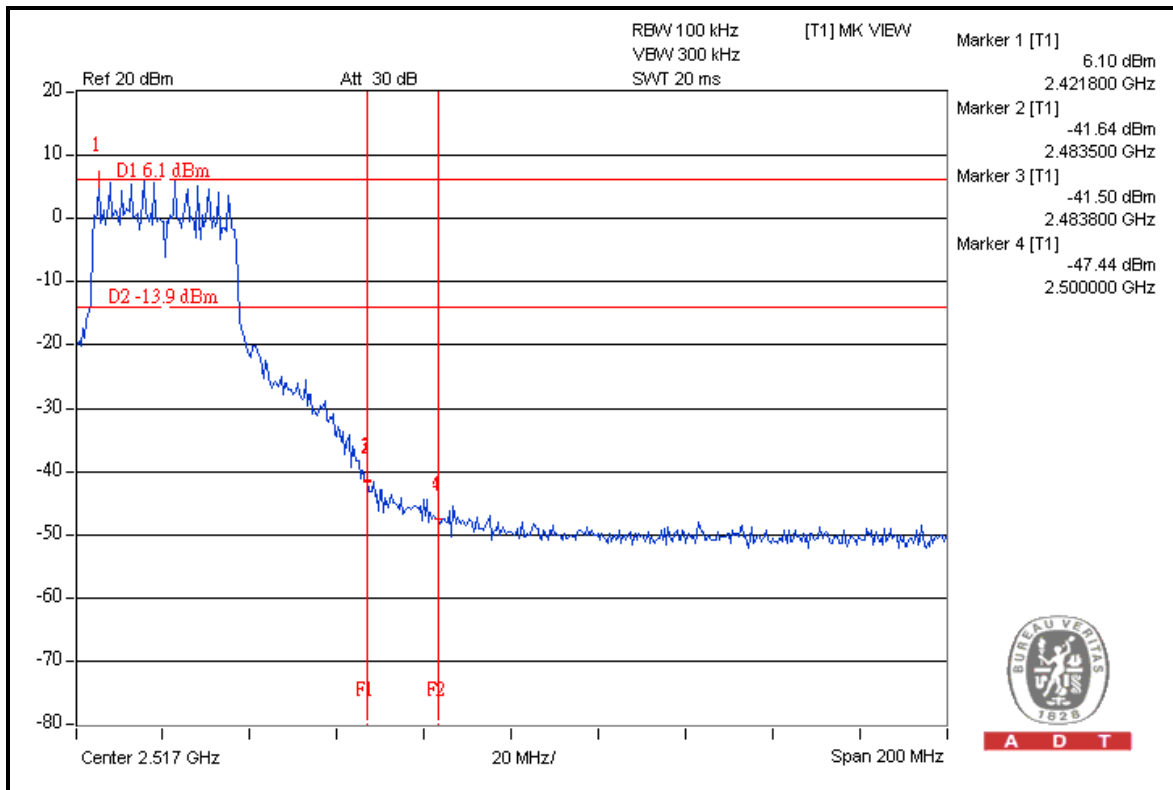
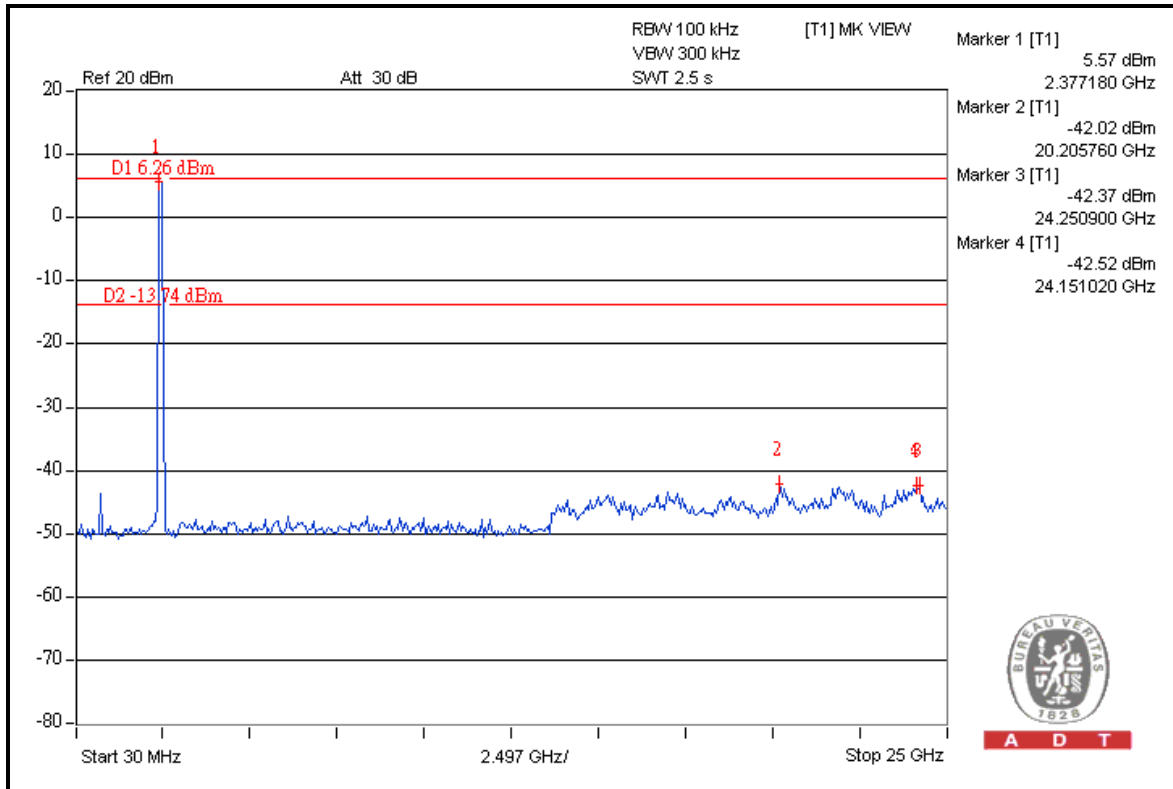



A D T

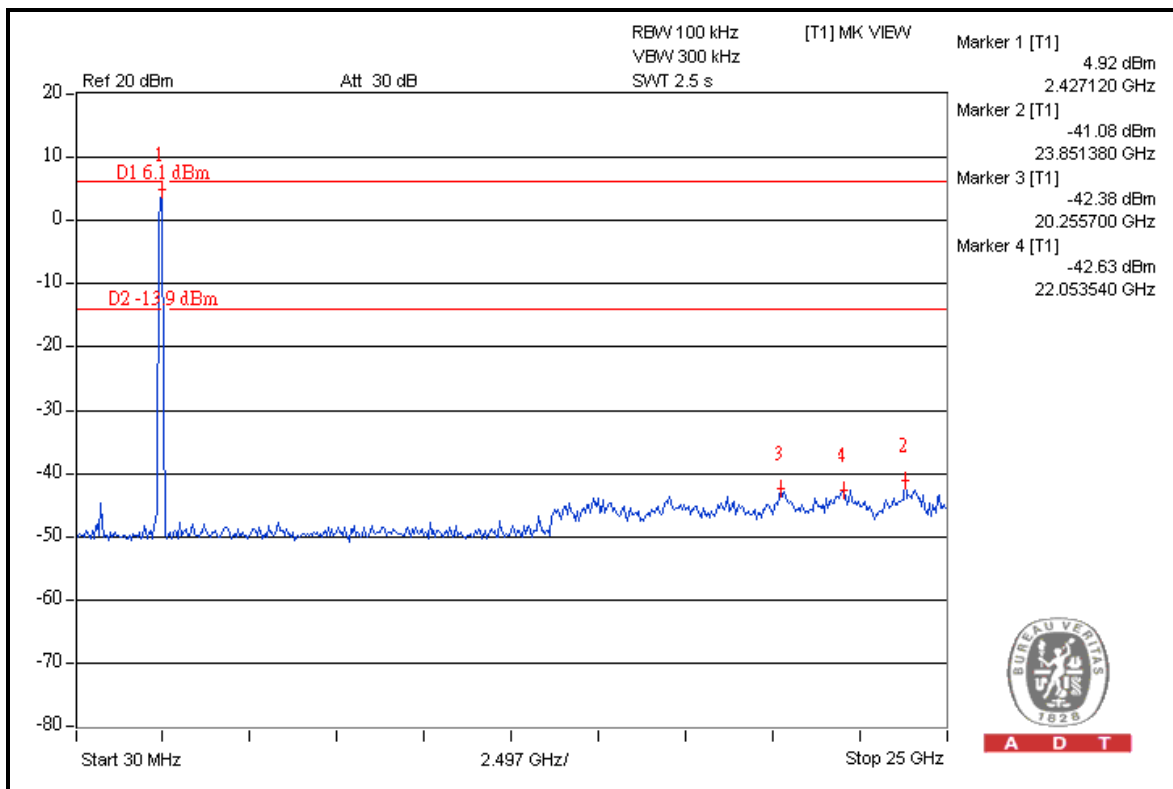
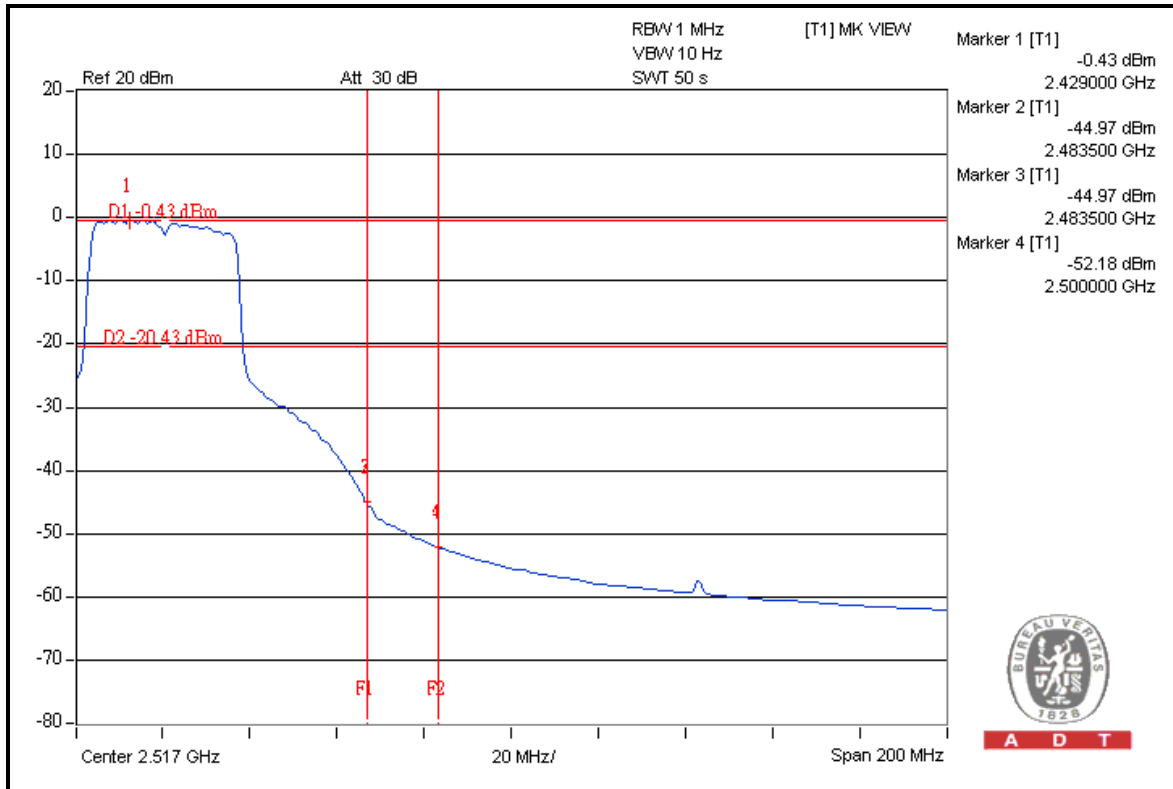



A D T

5. PHOTOGRAPHS OF THE TEST CONFIGURATION

Please refer to the attached file (Test Setup Photo).



A D T

6. INFORMATION ON THE TESTING LABORATORIES

We, Bureau Veritas Consumer Products Services (H.K.) Ltd., Taoyuan Branch, were founded in 1988 to provide our best service in EMC, Radio, Telecom and Safety consultation. Our laboratories are accredited and approved according to ISO/IEC 17025.

Copies of accreditation certificates of our laboratories obtained from approval agencies can be downloaded from our web site: www.adt.com.tw/index.5/phtml.
If you have any comments, please feel free to contact us at the following:

Linko EMC/RF Lab:

Tel: 886-2-26052180

Fax: 886-2-26051924

Hsin Chu EMC/RF Lab:

Tel: 886-3-5935343

Fax: 886-3-5935342

Hwa Ya EMC/RF/Safety / Telecom Lab:

Tel: 886-3-3183232

Fax: 886-3-3185050

Web Site: www.adt.com.tw

The address and road map of all our labs can be found in our web site also.



A D T

7. APPENDIX A - MODIFICATIONS RECORDERS FOR ENGINEERING CHANGES TO THE EUT BY THE LAB

No any modifications are made to the EUT by the lab during the test.

---END---