

FCC Radio Test Report

FCC ID: RYK-WSDB104GNIBT

This report concerns (check one): Original Grant Class I Change Class II Change

Project No. : 1709003
Equipment : 802.11b/g/n WiFi+BT IOT Module
Test Model : WSDB-104GNI(BT)
Series Model : N/A
Applicant : SparkLAN Communications, Inc.
Address : 8F.,No.257,Sec.2,Tiding-Blvd.,Neihu District,Taipei
City 11493,Taiwan (R.O.C.)

Date of Receipt : Sep. 07, 2017
Date of Test : Sep. 07, 2017 ~ Nov. 17, 2017
Issued Date : Nov. 21, 2017
Tested by : BTL Inc.

Testing Engineer : 
(Kay Wu)

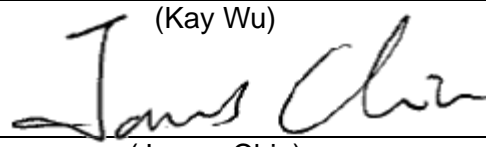
Technical Manager : 
(James Chiu)

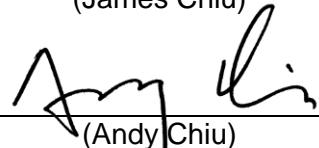
Authorized Signatory : 
(Andy Chiu)

B T L I N C .

No.18, Ln. 171, Sec. 2, Jiuzong Rd.,
Neihu Dist., Taipei City, Taiwan (R.O.C.)

TEL:+886-2-2657-3299 FAX: +886-2-2657-3331



Declaration

BTL represents to the client that testing is done in accordance with standard procedures as applicable and that test instruments used has been calibrated with standards traceable to international standard(s) and/or national standard(s).

BTL's reports apply only to the specific samples tested under conditions. It is manufacture's responsibility to ensure that additional production units of this model are manufactured with the identical electrical and mechanical components. **BTL** shall have no liability for any declarations, inferences or generalizations drawn by the client or others from **BTL** issued reports.

BTL's report must not be used by the client to claim product certification, approval, or endorsement by NVLAP, NIST, or any agency of the Federal Government.

This report is the confidential property of the client. As a mutual protection to the clients, the public and **BTL-self**, extracts from the test report shall not be reproduced except in full with **BTL's** authorized written approval.

BTL's laboratory quality assurance procedures are in compliance with the **ISO Guide 17025** requirements, and accredited by the conformity assessment authorities listed in this test report.

Limitation

For the use of the authority's logo is limited unless the Test Standard(s)/Scope(s)/Item(s) mentioned in this test report is (are) included in the conformity assessment authorities acceptance respective.

Table of Contents	Page
1 . CERTIFICATION	5
2 . SUMMARY OF TEST RESULTS	6
2.1 TEST FACILITY	7
2.2 MEASUREMENT UNCERTAINTY	7
3 . GENERAL INFORMATION	8
3.1 GENERAL DESCRIPTION OF EUT	8
3.2 DESCRIPTION OF TEST MODES	9
3.3 DUTY CYCLE	10
3.4 BLOCK DIAGRAM SHOWING THE CONFIGURATION OF SYSTEM TESTED	11
3.5 DESCRIPTION OF SUPPORT UNITS	12
4 . EMC EMISSION TEST	13
4.1 CONDUCTED EMISSIONS MEASUREMENT	13
4.1.1 POWER LINE CONDUCTED EMISSIONS LIMITS	13
4.1.2 TEST PROCEDURE	13
4.1.3 DEVIATION FROM TEST STANDARD	13
4.1.4 TEST SETUP	14
4.1.5 EUT OPERATING CONDITIONS	14
4.1.6 EUT TEST CONDITIONS	14
4.1.7 TEST RESULTS	14
4.2 RADIATED EMISSIONS MEASUREMENT	15
4.2.1 RADIATED EMISSIONS LIMITS	15
4.2.2 TEST PROCEDURE	16
4.2.3 DEVIATION FROM TEST STANDARD	16
4.2.4 TEST SETUP	17
4.2.5 EUT OPERATING CONDITIONS	18
4.2.6 EUT TEST CONDITIONS	18
4.2.7 TEST RESULTS (9KHZ TO 30MHZ)	18
4.2.8 TEST RESULTS (30MHZ TO 1000 MHZ)	18
4.2.9 TEST RESULTS (ABOVE 1000 MHZ)	18
5 . MEASUREMENT INSTRUMENTS LIST	19
6 . EUT TEST PHOTO	20
APPENDIX A – CONDUCTED EMISSIONS	26
APPENDIX B – RADIATED EMISSIONS (9KHZ TO 30MHZ)	31
APPENDIX C – RADIATED EMISSIONS (30MHZ TO 1000MHZ)	32
APPENDIX D – RADIATED EMISSIONS (ABOVE 1000MHZ)	37

REPORT ISSUED HISTORY

Issued No.	Description	Issued Date
BTL-FCCP-1-1709003	Original Issue.	Nov. 21, 2017

1. CERTIFICATION

Equipment : 802.11b/g/n WiFi+BT IOT Module
Brand Name : SparkLAN
Test Model : WSDB-104GNI(BT)
Series Model : N/A
Applicant : SparkLAN Communications, Inc.
Manufacturer : SparkLAN Communications, Inc.
Address : 8F.,No.257,Sec.2,Tiding-Blvd.,Neihu District,Taipei City 11493,Taiwan
(R.O.C.)
Date of Test : Sep. 07, 2017 ~ Nov. 17, 2017
Test Sample : Production Unit
Standard(s) : FCC Part15, Subpart C (15.247)
ANSI C63.10-2013

The above equipment has been tested and found in compliance with the requirement of the relative standards by BTL Inc.

The test data, data evaluation, and equipment configuration contained in our test report (Ref No. BTL-FCCP-1-1709003) were obtained utilizing the test procedures, test instruments, test sites that has been accredited by the Authority of TAF according to the ISO-17025 quality assessment standard and technical standard(s).

Test results included in this report is only for the WIFI 2.4GHz part.

2. SUMMARY OF TEST RESULTS

Test procedures according to the technical standard(s):

Applied Standard(s): FCC Part15, Subpart C (15.247)			
Standard(s) Section	Test Item	Judgment	Remark
15.207	Conducted Emissions	PASS	-----
15.247(d) 15.209	Radiated Emissions	PASS	-----
15.203	Antenna Requirement	PASS	-----

Note:

- (1) "N/A" denotes test is not applicable in this test report
- (2) Accord to the EUT((Report Number: STR17068025I-1 and model: WSDB-104GNI(BT)) has been certificated, Conducted and Radiated emission were criticized and reconfirmed in this report.
- (3) Compared with the previous report (STR17068025I-1), Added two new different type (Dipole&PCB) antennas.

2.1 TEST FACILITY

The test facilities used to collect the test data in this report:

Conducted emission Test:

C05: (VCCI RN: C-4742; FCC RN:965108; FCC DN:TW1082)

No. 68-1, Ln. 169, Sec.2, Datong Rd., Xizhi Dist., New Taipei City 221, Taiwan

Radiated emission Test (Below 1 GHz):

CB15: (FCC RN:674415; FCC DN:TW0659)

No. 68-1, Ln. 169, Sec.2, Datong Rd., Xizhi Dist., New Taipei City 221, Taiwan

Radiated emission Test (Above 1 GHz):

CB15: (FCC RN:674415; FCC DN:TW0659)

No. 68-1, Ln. 169, Sec.2, Datong Rd., Xizhi Dist., New Taipei City 221, Taiwan

2.2 MEASUREMENT UNCERTAINTY

Where relevant, the following measurement uncertainty levels have been estimated for tests performed on the EUT as specified in CISPR 16-4-2. The BTL measurement uncertainty is less than the CISPR 16-4-2 U_{CISPR} requirement.

The reported uncertainty of measurement $y \pm U$, where expanded uncertainty U is based on a standard uncertainty multiplied by a coverage factor of $k=2$, providing a level of confidence of approximately 95 %.

A. Conducted emission test:

Test Site	Method	Measurement Frequency Range	U,(dB)
C05	CISPR	150 kHz ~ 30MHz	2.68

B. Radiated emission test:

Test Site	Method	Measurement Frequency Range	U,(dB)
CB15 (3m)	CISPR	9kHz ~ 150kHz	2.82
		150kHz ~ 30MHz	2.58

Test Site	Method	Measurement Frequency Range	Ant. H / V	U,(dB)
CB15 (3m)	CISPR	30MHz ~ 200MHz	V	4.20
		30MHz ~ 200MHz	H	3.64
		200MHz ~ 1,000MHz	V	4.56
		200MHz ~ 1,000MHz	H	3.90

Test Site	Method	Measurement Frequency Range	Ant. H / V	U,(dB)
CB15 (3m)	CISPR	1GHz ~ 6GHz	V	4.46
		1GHz ~ 6GHz	H	4.40
		6GHz ~ 18GHz	V	3.88
		6GHz ~ 18GHz	H	4.00

Test Site	Method	Measurement Frequency Range	U,(dB)
CB15 (1m)	CISPR	18 ~ 26.5 GHz	4.62
		26.5 ~ 40 GHz	5.12

3. GENERAL INFORMATION

3.1 GENERAL DESCRIPTION OF EUT

Equipment	802.11b/g/n WiFi+BT IOT Module	
Brand Name	SparkLAN	
Test Model	WSDB-104GNI(BT)	
Series Model	N/A	
Model Difference	N/A	
Product Description	Operation Frequency	2412~2462 MHz
	Modulation Technology	802.11b:DSSS 802.11g:OFDM 802.11n:OFDM
	Bit Rate of Transmitter	802.11b: 11/5.5/2/1 Mbps 802.11g: 54/48/36/24/18/12/9/6 Mbps 802.11n up to 150 Mbps
EUT Power Rating	3.3Vdc form host equipment	
Products Covered	N/A	

Note:

- For a more detailed features description, please refer to the manufacturer's specifications or the user's manual.
- Channel List:

CH01 – CH11 for 802.11b, 802.11g, 802.11n(20MHz)							
Channel	Frequency (MHz)	Channel	Frequency (MHz)	Channel	Frequency (MHz)	Channel	Frequency (MHz)
01	2412	04	2427	07	2442	10	2457
02	2417	05	2432	08	2447	11	2462
03	2422	06	2437	09	2452		

- Table for Filed Antenna:

Group 1:

Ant.	Brand	Model	Type	Connector	Gain (dBi)
0	Long Cheng	FDE_ACBSMA_BGP	Dipole	RP-SMA	3.67

Group 2:

Ant.	Brand	Model	Type	Connector	Gain (dBi)
0	N/A	N/A	PCB	N/A	-5.01

3.2 DESCRIPTION OF TEST MODES

To investigate the maximum EMI emission characteristics generated from EUT, the test system was pre-scanning tested based on the consideration of following EUT operation mode or test configuration mode which possibly have effect on EMI emission level. Each of these EUT operation mode(s) or test configuration mode(s) mentioned above was evaluated respectively.

Pretest Mode	Description
Mode 1	TX B Mode / CH01, CH06, CH 11
Mode 2	TX G Mode / CH01, CH06, CH 11
Mode 3	TX N-20MHZ Mode / CH01, CH06, CH 11
Mode 4	TX Mode

The EUT system operated these modes were found to be the worst case during the pre-scanning test as following:

For Conducted Test	
Final Test Mode	Description
Mode 4	TX Mode

For Radiated Emissions	
Final Test Mode	Description
Mode 1	TX B Mode / CH01, CH06, CH 11
Mode 2	TX G Mode / CH01, CH06, CH 11
Mode 3	TX N-20MHZ Mode / CH01, CH06, CH 11

Note:

- (1) The measurements are performed at the high, middle, low available channels.
- (2) 802.11b mode: DBPSK (1Mbps)
802.11g mode: OFDM (6Mbps)
802.11n HT20 mode : BPSK (13Mbps)
For radiated emission tests, the highest output powers were set for final test.
- (3) For radiated emission below 1GHz test, the IEEE 802.11g is found to be the worst case and recorded.
- (4) The EUT was programmed to be in continuously transmitting mode and the transmit duty cycle is not less than 98%.
- (5) For Dipole Antenna, the EUT has pre-tested on positioned of 0° & 90°. The worst case was found positioned on 90°. Therefore only the test data of this 90° was used for radiated emission measurement test.
For PCB Antenna, the EUT has pre-tested on positioned of each 3 axis. The worst case was found positioned on Z-plane. Therefore only the test data of this Z-plane was used for radiated emission measurement test.

3.3 DUTY CYCLE

If duty cycle is $\geq 98\%$, duty factor is not required.
 If duty cycle is $< 98\%$, duty factor shall be considered.

<p style="text-align: center;">IEEE 802.11b</p> <p>Date: 11.OCT.2017 17:51:28</p>	<p style="text-align: center;">IEEE 802.11g</p> <p>Date: 11.OCT.2017 17:50:18</p>
<p>Duty cycle = $1.640 \text{ ms} / 1.640 \text{ ms} = 100\%$ Duty Factor = $10 * \log(1 / 1) = 0$</p>	<p>Duty cycle = $1.380 \text{ ms} / 1.510 \text{ ms} = 91.39\%$ Duty Factor = $10 * \log(1 / 0.9139) = 0.39$</p>
<p style="text-align: center;">IEEE 802.11n (20 MHz)</p> <p>Date: 11.OCT.2017 17:48:10</p>	
<p>Duty cycle = $1.400 \text{ ms} / 1.530 \text{ ms} = 91.50\%$ Duty Factor = $10 * \log(1 / 0.9150) = 0.39$</p>	

Note:

For IEEE 802.11g and IEEE 802.11n (20 MHz):
 For radiated emissions frequency above 1 GHz, the resolution bandwidth of test receiver/spectrum analyzer is 1 MHz and the video bandwidth is 1 kHz (Duty cycle $< 98\%$).

3.4 BLOCK DIAGRAM SHOWING THE CONFIGURATION OF SYSTEM TESTED

Antenna Type: PCB

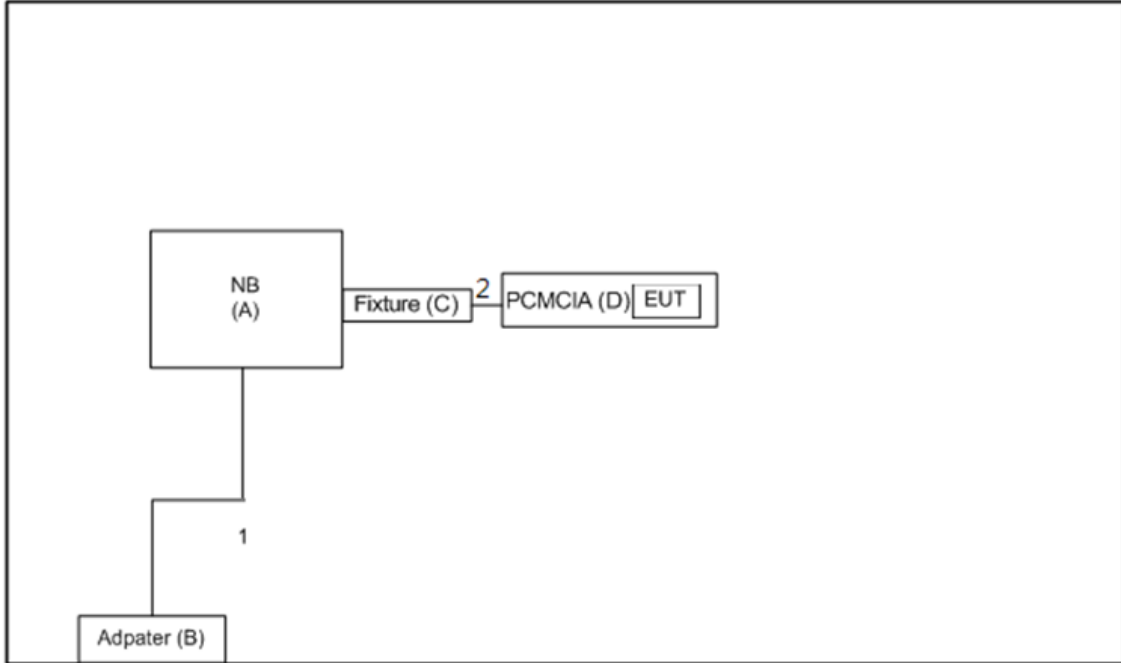

Antenna Type: Dipole

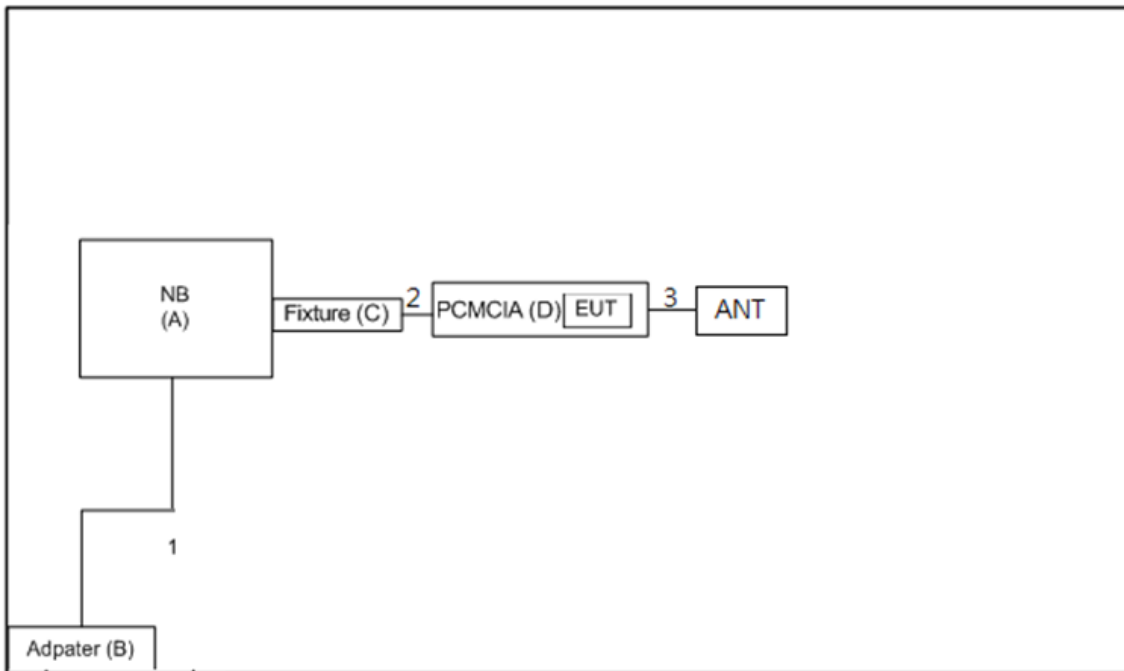

3.5 DESCRIPTION OF SUPPORT UNITS

The EUT has been tested as an independent unit together with other necessary accessories or support units. The following support units or accessories were used to form a representative test configuration during the tests.

Item	Equipment	Mfr/Brand	Model/Type No.	FCC ID	Series No.
A	NB	Lenovo	N/A	N/A	N/A
B	Adapter	Lenovo	ADLX65CLGU2A	N/A	N/A
C	Fixture(Test tool)	N/A	N/A	N/A	N/A
D	PCMCIA(Test tool)	Sparklan	N/A	N/A	N/A

Item	Shielded Type	Ferrite Core	Length	Note
1	NO	NO	2.0m	Power Cable
2	NO	NO	0.1m	Cable
3	NO	NO	0.1m	Cable

4. EMC EMISSION TEST

4.1 CONDUCTED EMISSIONS MEASUREMENT

4.1.1 POWER LINE CONDUCTED EMISSIONS LIMITS (Frequency Range 150KHz-30MHz)

Frequency of Emissions (MHz)	Conducted Limit (dBμV)	
	Quasi-peak	Average
0.15 -0.50	66 to 56*	56 to 46*
0.50 -5.0	56	46
5.0 -30.0	60	50

Note:

- (1) The limit of " * " decreases with the logarithm of the frequency
- (2) The test result calculated as following:
 Measurement Value = Reading Level + Correct Factor
 Correct Factor = Insertion Loss + Cable Loss + Attenuator Factor(if use)
 Margin Level = Measurement Value - Limit Value

The following table is the setting of the receiver

Receiver Parameters	Setting
Attenuation	10 dB
Start Frequency	0.15 MHz
Stop Frequency	30 MHz
IF Bandwidth	9 KHz

4.1.2 TEST PROCEDURE

- a. The EUT was placed 0.8 meters from the horizontal ground plane with EUT being connected to the power mains through a line impedance stabilization network (LISN). All other support equipment powered from additional LISN(s). The LISN provide 50 Ohm/ 50uH of coupling impedance for the measuring instrument.
- b. Interconnecting cables that hang closer than 40 cm to the ground plane shall be folded back and forth in the center forming a bundle 30 to 40 cm long.
- c. I/O cables that are not connected to a peripheral shall be bundled in the center. The end of the cable may be terminated, if required, using the correct terminating impedance. The overall length shall not exceed 1 m.
- d. LISN at least 80 cm from nearest part of EUT chassis.
- e. For the actual test configuration, please refer to the related Item –EUT Test Photos.

4.1.3 DEVIATION FROM TEST STANDARD

No deviation

4.1.4 TEST SETUP

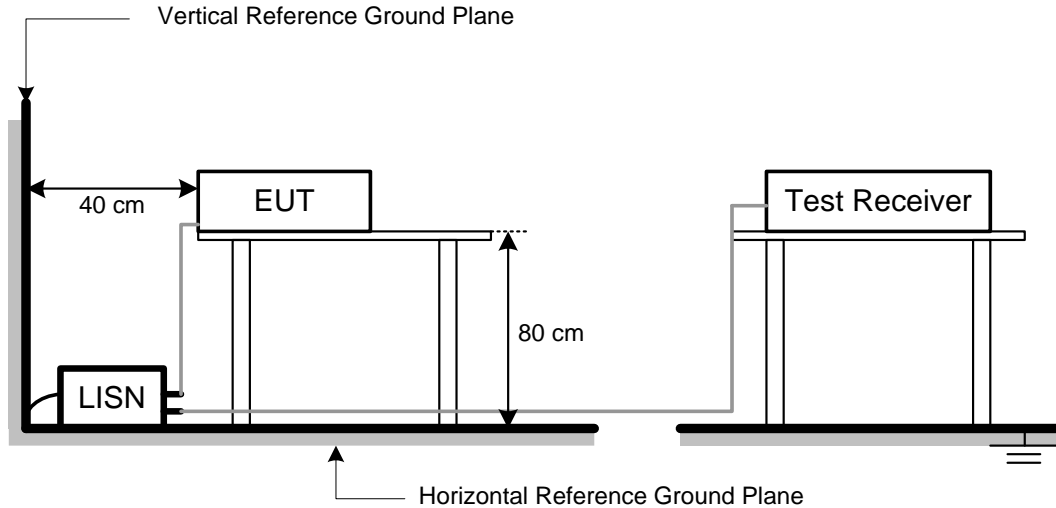

4.1.5 EUT OPERATING CONDITIONS

The EUT was configured for testing in a typical function (as a customer would normally use it), EUT was programmed to be in continuously transmitting/receiving data or hopping on mode.

4.1.6 EUT TEST CONDITIONS

Temperature: 25°C
 Relative Humidity: 55%
 Test Voltage: AC 120V/60Hz

4.1.7 TEST RESULTS

Please refer to the Appendix A.

Remark:

- (1) All readings are QP Mode value unless otherwise stated AVG in column of "Note". If the QP Mode Measured value compliance with the QP Limits and lower than AVG Limits, the EUT shall be deemed to meet both QP & AVG Limits and then only QP Mode was measured, but AVG Mode didn't perform. In this case, a "*" marked in AVG Mode column of Interference Voltage Measured.
- (2) Measuring frequency range from 150KHz to 30MHz.
- (3) "N/A" denotes test is not applicable to this device.

4.2 RADIATED EMISSIONS MEASUREMENT

4.2.1 RADIATED EMISSIONS LIMITS

In case the emission fall within the restricted band specified on 15.205(a), then the 15.209(a) limit in the table below has to be followed.

LIMITS OF RADIATED EMISSIONS MEASUREMENT (9KHz-1000MHz)

Frequency (MHz)	Field Strength (microvolts/meter)	Measurement Distance (meters)
0.009~0.490	2400/F(KHz)	300
0.490~1.705	24000/F(KHz)	30
1.705~30.0	30	30
30~88	100	3
88~216	150	3
216~960	200	3
960~1000	500	3

LIMITS OF RADIATED EMISSIONS MEASUREMENT (Above 1000MHz)

Frequency (MHz)	(dBuV/m) (at 3 m)	
	PEAK	AVERAGE
Above 1000	74	54

Notes:

- (1) The limit for radiated test was performed according to FCC Part 15, Subpart C.
- (2) The tighter limit applies at the band edges.
- (3) Emissions level (dBuV/m)=20log Emissions level (uV/m).
- (4) The test result calculated as following:
 Measurement Value = Reading Level + Correct Factor
 Correct Factor = Antenna Factor + Cable Loss - Amplifier Gain(if use)
 Margin Level = Measurement Value - Limit Value

Spectrum Parameter	Setting
Attenuation	Auto
Start Frequency	1000 MHz
Stop Frequency	10th carrier harmonic
RBW / VBW (Emissions in restricted band)	1MHz / 3MHz for Peak, 1MHz / 1/T for Average

Receiver Parameter	Setting
Attenuation	Auto
Start ~ Stop Frequency	9KHz~90KHz for PK/AVG detector
Start ~ Stop Frequency	90KHz~110KHz for QP detector
Start ~ Stop Frequency	110KHz~490KHz for PK/AVG detector
Start ~ Stop Frequency	490KHz~30MHz for QP detector
Start ~ Stop Frequency	30MHz~1000MHz for QP detector

4.2.2 TEST PROCEDURE

- a. The measuring distance of 3 m shall be used for measurements. The EUT was placed on the top of a rotating table 0.8 m above the ground at a 3 m semi-anechoic chamber. The table was rotated 360 degrees to determine the position of the highest radiation.(below 1GHz)
- b. The measuring distance of 3 m shall be used for measurements. The EUT was placed on the top of a rotating table 1.5 m above the ground at a 3 m semi-anechoic chamber. The table was rotated 360 degrees to determine the position of the highest radiation.(above 1GHz)
- c. The height of the equipment or of the substitution antenna shall be 0.8m or 1.5m; the height of the test antenna shall vary between 1 m to 4 m. Both horizontal and vertical polarizations of the antenna are set to make the measurement.
- d. For each suspected emission, the EUT was arranged to its worst case and then the antenna was tuned to heights find the maximum reading (used Bore sight function).
- e. The receiver system was set to peak and average detect function and specified bandwidth with maximum hold mode when the test frequency is above 1GHz.
- f. The initial step in collecting radiated emission data is a receiver peak detector mode pre-scanning the measurement frequency range. Significant peaks are then marked and then Quasi Peak detector mode re-measured.
- g. All readings are Peak unless otherwise stated QP in column of Note. Peak denotes that the Peak reading compliance with the QP Limits and then QP Mode measurement didn't perform. (below 1GHz)
- h. All readings are Peak Mode value unless otherwise stated AVG in column of Note. If the Peak Mode Measured value compliance with the Peak Limits and lower than AVG Limits, the EUT shall be deemed to meet both Peak & AVG Limits and then only Peak Mode was measured, but AVG Mode didn't perform. (above 1GHz)
- i. For the actual test configuration, please refer to the related Item –EUT Test Photos.

4.2.3 DEVIATION FROM TEST STANDARD

No deviation

4.2.4 TEST SETUP

(A) Radiated Emissions Test Set-Up Frequency Below 1 GHz

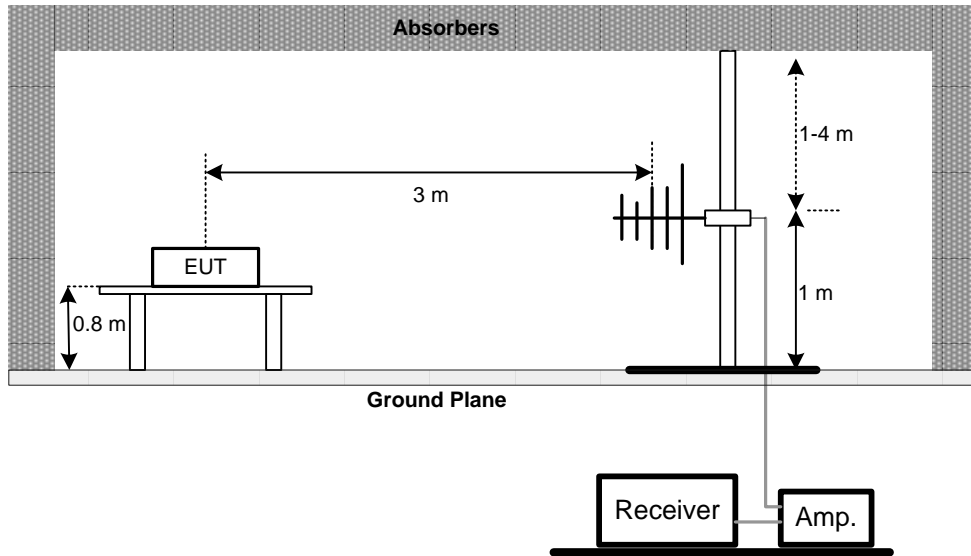

(B) Radiated Emissions Test Set-Up Frequency Above 1 GHz

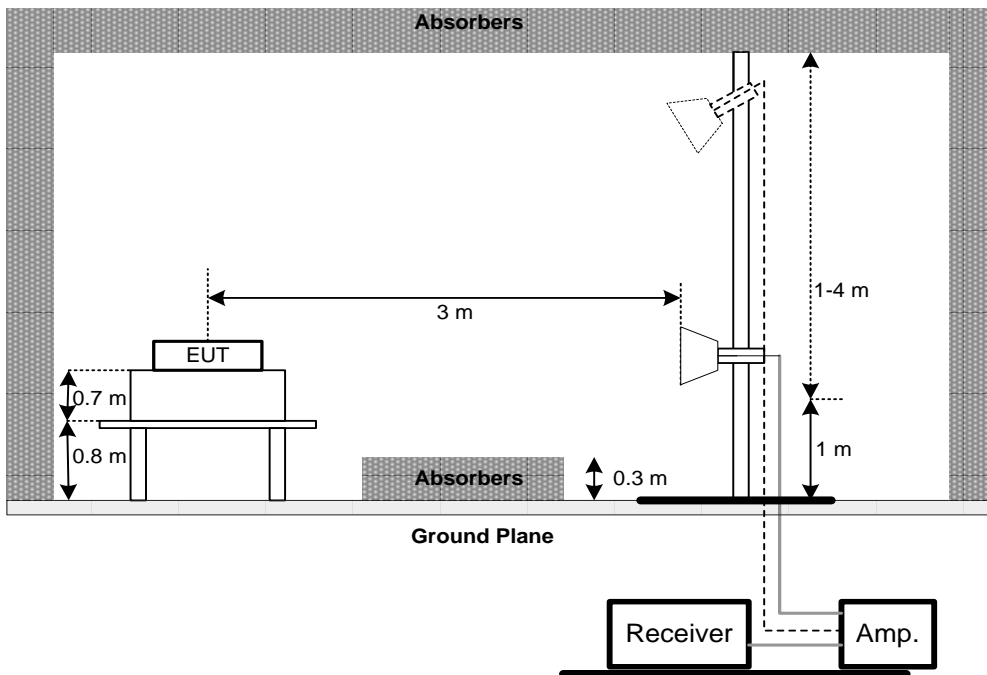

(C) For Radiated Emissions Below 30MHz

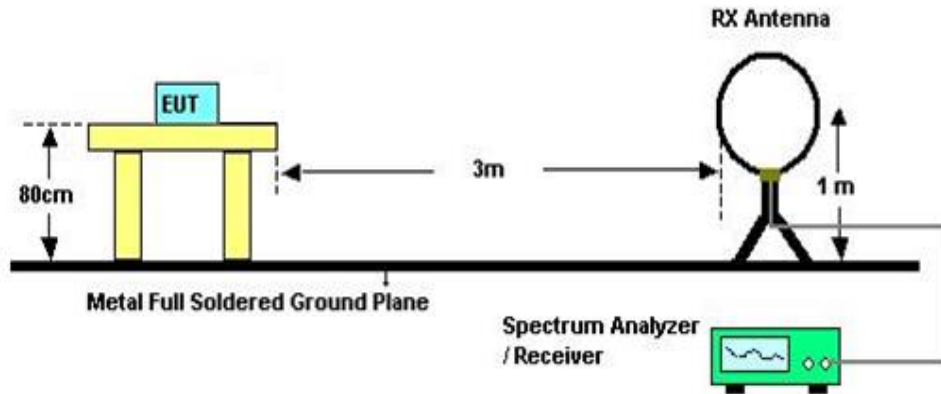

4.2.5 EUT OPERATING CONDITIONS

The EUT was programmed to be in continuously transmitting mode.

4.2.6 EUT TEST CONDITIONS

Temperature: 25°C Relative Humidity: 45% Test Voltage: AC 120V/60Hz

4.2.7 TEST RESULTS (9KHZ TO 30MHZ)

Please refer to the Appendix B.

Remark:

- (1) The amplitude of spurious emissions which are attenuated by more than 20 dB below the permissible value has no need to be reported.
- (2) Distance extrapolation factor = $40 \log(\text{specific distance} / \text{test distance})$ (dB).
- (3) Limit line = specific limits (dBuV) + distance extrapolation factor.

4.2.8 TEST RESULTS (30MHZ TO 1000 MHZ)

Please refer to the Appendix C.

4.2.9 TEST RESULTS (ABOVE 1000 MHZ)

Please refer to the Appendix D.

Remark:

- (1) No limit: This is fundamental signal, the judgment is not applicable.
For fundamental signal judgment was referred to Peak output test.

5. MEASUREMENT INSTRUMENTS LIST

Conducted Emissions Measurement					
Item	Kind of Equipment	Manufacturer	Type No.	Serial No.	Calibrated until
1	TWO-LINE V-NETWORK	R&S	ENV216	101050	Jan. 25, 2018
2	Test Cable	TIMES	CFD300-NL	C02	Jun. 14, 2018
3	EMI Test Receiver	R&S	ESR7	101433	Dec. 09, 2017
4	Measurement Software	EZ	EZ_EMG (Version NB-03A)	N/A	N/A

Radiated Emissions Measurement					
Item	Kind of Equipment	Manufacturer	Type No.	Serial No.	Calibrated until
1	Preamplifier	EMCI	012645B	980267	Feb. 28, 2018
2	Preamplifier	EMCI	EMC02325	980217	Dec. 29, 2017
3	Preamplifier	EMCI	EMC2654045	980030	Feb. 14, 2018
4	Test Cable	EMCI	EMC104-SM-S M-8000	8m	Jan. 04, 2018
5	Test Cable	EMCI	EMC104-SM-S M-800	150207	Jan. 04, 2018
6	Test Cable	EMCI	EEMC104-SM-S M-3000	151205	Jan. 04, 2018
7	MXE EMI Receiver	Agilent	N9038A	MY55420127	Jan. 09, 2018
8	Signal Analyzer	Agilent	N9010A	MY52220990	Feb. 22, 2018
9	Loop Ant	EMCO	6502	42960	Nov. 24, 2017
10	Horn Ant	SCHWARZBECK	BBHA 9120D	9120D-1342	Feb. 28, 2018
11	Horn Ant	Schwarzbeck	BBHA 9170	187	Dec. 07, 2017
12	Trilog-Broadband Antenna	Schwarzbeck	VULB 9168	9168-548	Jan. 16, 2018
13	5dB Attenuator	EMCI	EMCI-N-6-05	AT-N0623	Jan. 16, 2018

Remark: "N/A" denotes no model name, serial no. or calibration specified.

All calibration period of equipment list is one year.

6. EUT TEST PHOTO

Conducted Measurement Photos Antenna Type: Dipole



**Conducted Measurement Photos
Antenna Type: PCB**

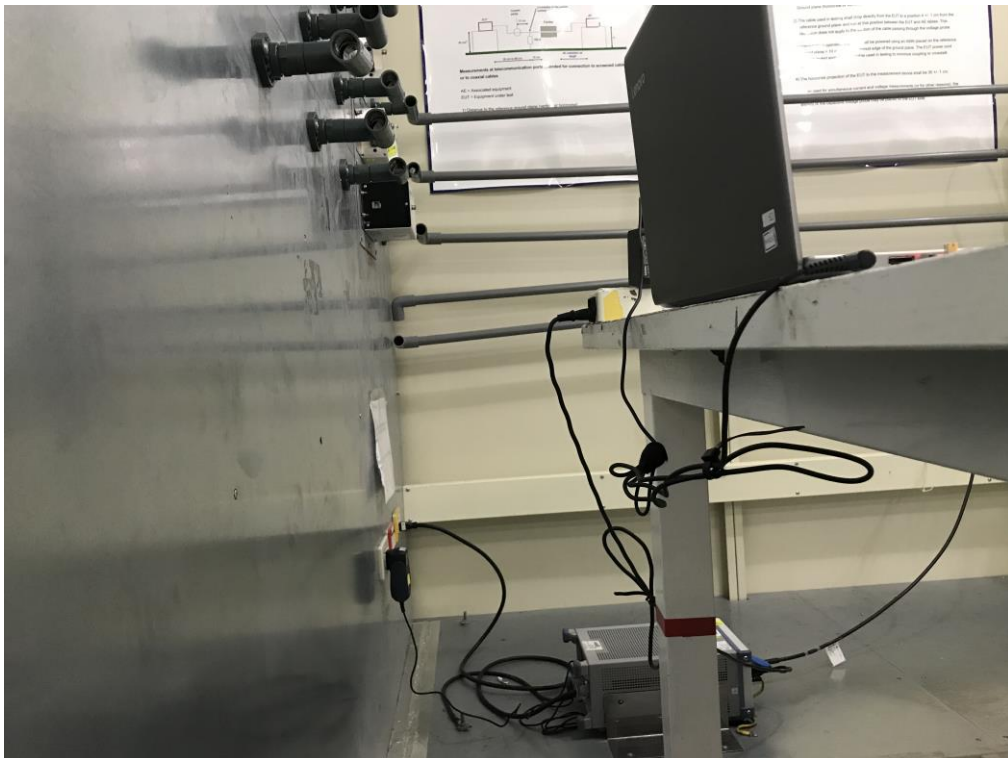

Radiated Measurement Photos
30MHz to 1000MHz_Antenna Type: Dipole

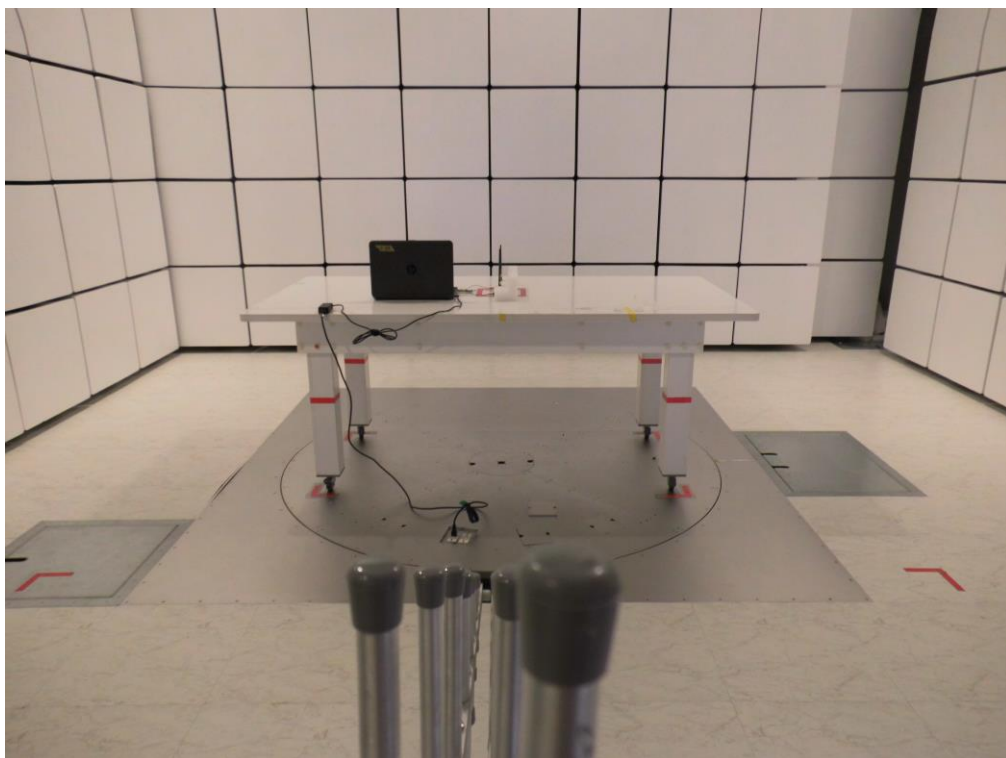
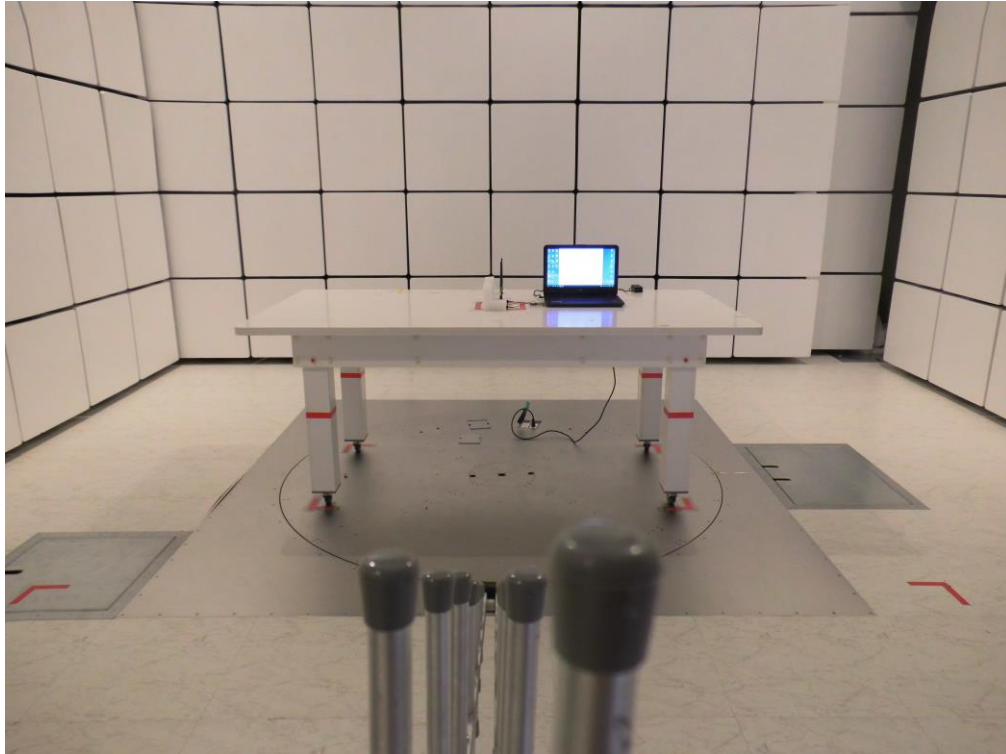

Radiated Measurement Photos
30MHz to 1000MHz_Antenna Type: PCB

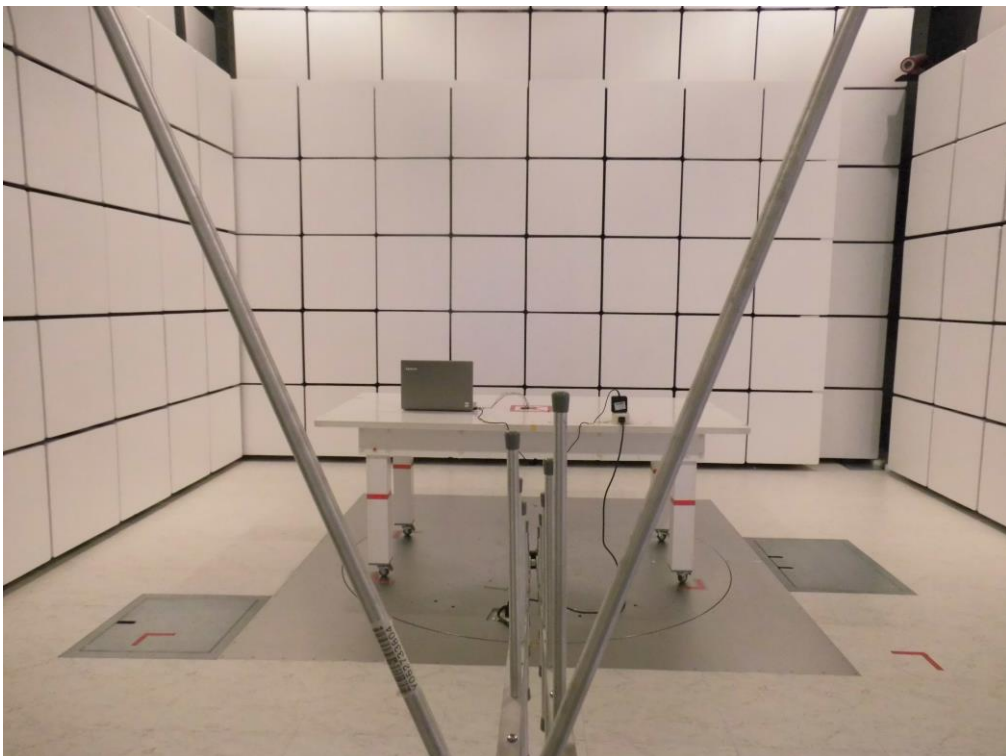
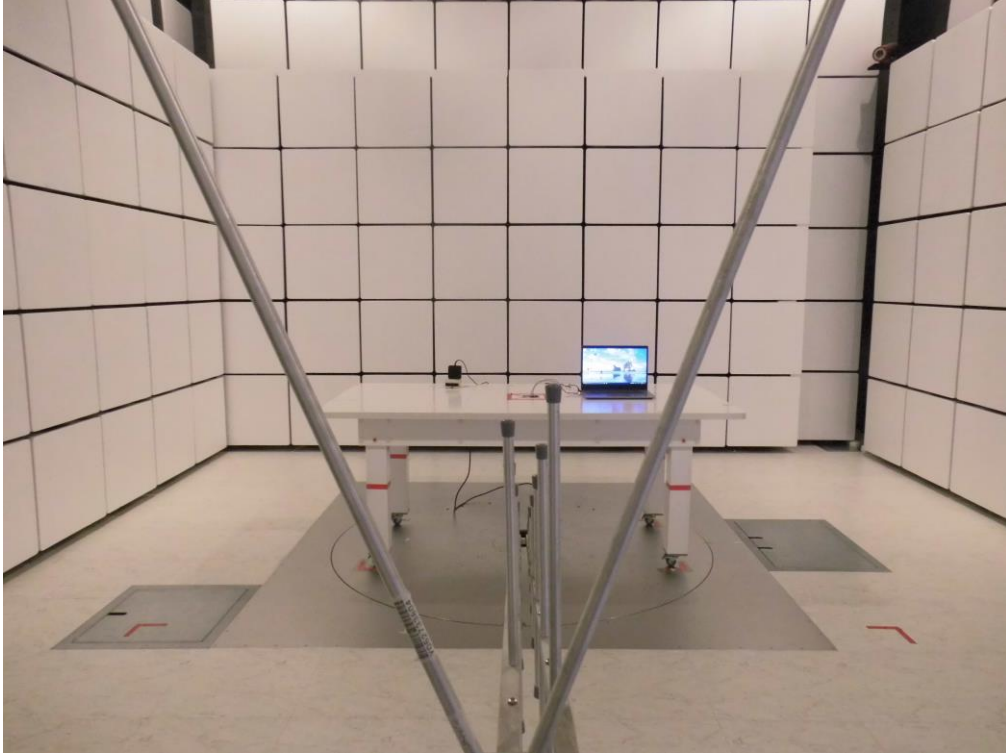

**Radiated Measurement Photos
Above 1000MHz_Antenna Type: Dipole**



**Radiated Measurement Photos
Above 1000MHz_Antenna Type: PCB**

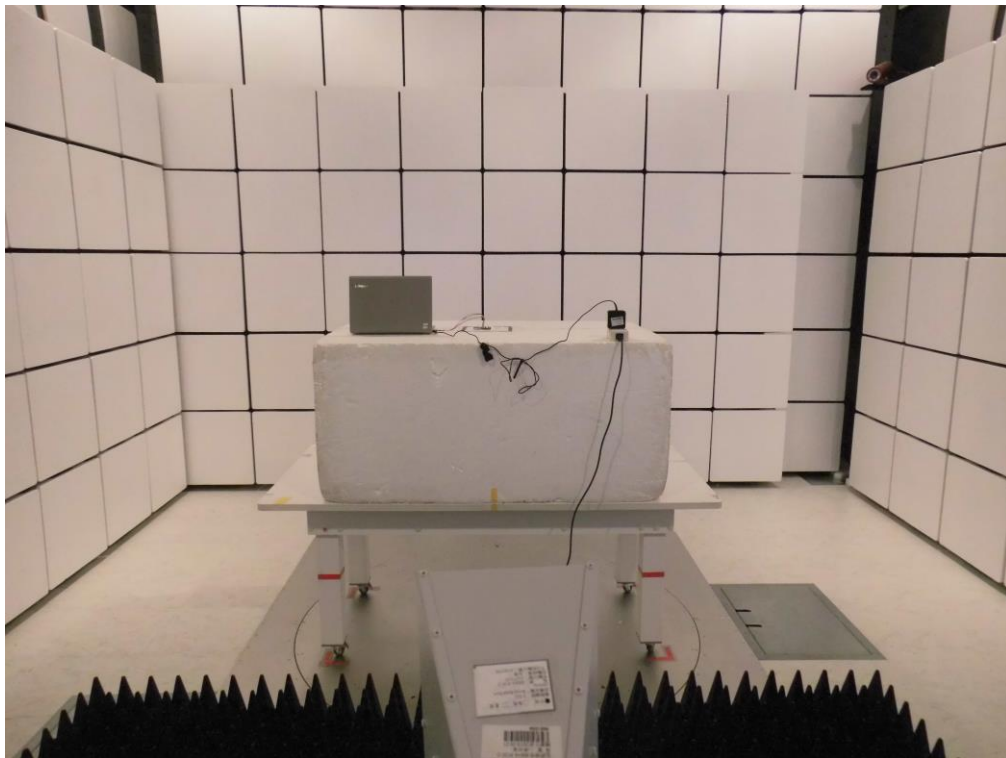

APPENDIX A – CONDUCTED EMISSIONS

Test Mode: TX Mode_ Antenna Type: Dipole

Line

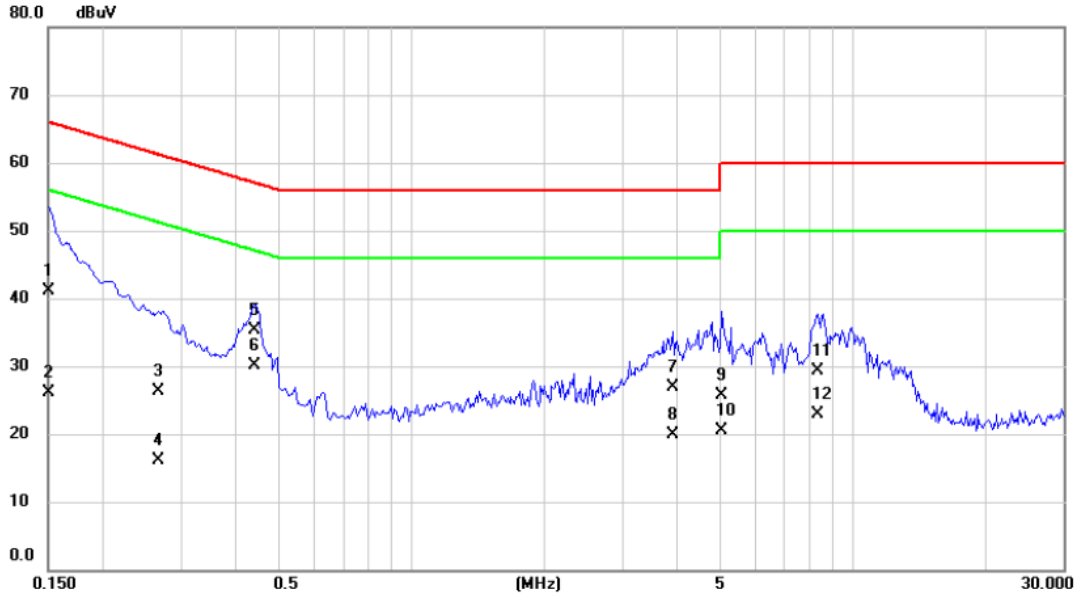

No.	Mk.	Freq. MHz	Reading Level dBuV	Correct Factor dB	Measure- ment dBuV	Limit dBuV	Over dB	Detector	Comment
1		0.1500	31.30	9.73	41.03	66.00	-24.97	QP	
2		0.1500	16.30	9.73	26.03	56.00	-29.97	AVG	
3		0.2662	16.60	9.73	26.33	61.24	-34.91	QP	
4		0.2662	6.40	9.73	16.13	51.24	-35.11	AVG	
5		0.4391	25.50	9.74	35.24	57.08	-21.84	QP	
6	*	0.4391	20.30	9.74	30.04	47.08	-17.04	AVG	
7		3.9020	17.10	9.80	26.90	56.00	-29.10	QP	
8		3.9020	10.10	9.80	19.90	46.00	-26.10	AVG	
9		5.0500	15.90	9.83	25.73	60.00	-34.27	QP	
10		5.0500	10.70	9.83	20.53	50.00	-29.47	AVG	
11		8.3500	19.30	9.93	29.23	60.00	-30.77	QP	
12		8.3500	13.00	9.93	22.93	50.00	-27.07	AVG	

Test Mode: TX Mode_ Antenna Type: Dipole

Neutral

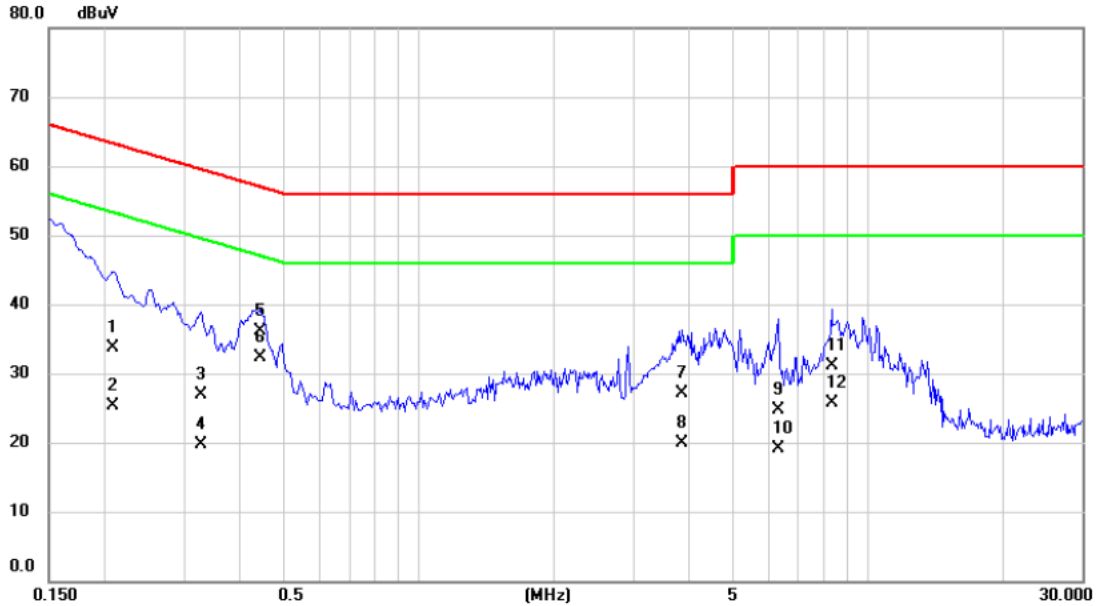

No.	Mk.	Freq. MHz	Reading Level dBuV	Correct Factor dB	Measure- ment dBuV	Limit dBuV	Over dB	Detector	Comment
1		0.2088	24.00	9.65	33.65	63.25	-29.60	QP	
2		0.2088	15.60	9.65	25.25	53.25	-28.00	AVG	
3		0.3271	17.20	9.67	26.87	59.52	-32.65	QP	
4		0.3271	10.00	9.67	19.67	49.52	-29.85	AVG	
5		0.4426	26.40	9.68	36.08	57.01	-20.93	QP	
6	*	0.4426	22.70	9.68	32.38	47.01	-14.63	AVG	
7		3.8570	17.30	9.76	27.06	56.00	-28.94	QP	
8		3.8570	10.10	9.76	19.86	46.00	-26.14	AVG	
9		6.3000	14.90	9.83	24.73	60.00	-35.27	QP	
10		6.3000	9.30	9.83	19.13	50.00	-30.87	AVG	
11		8.3000	21.30	9.90	31.20	60.00	-28.80	QP	
12		8.3000	15.90	9.90	25.80	50.00	-24.20	AVG	

Test Mode: TX Mode_ Antenna Type: PCB

Line

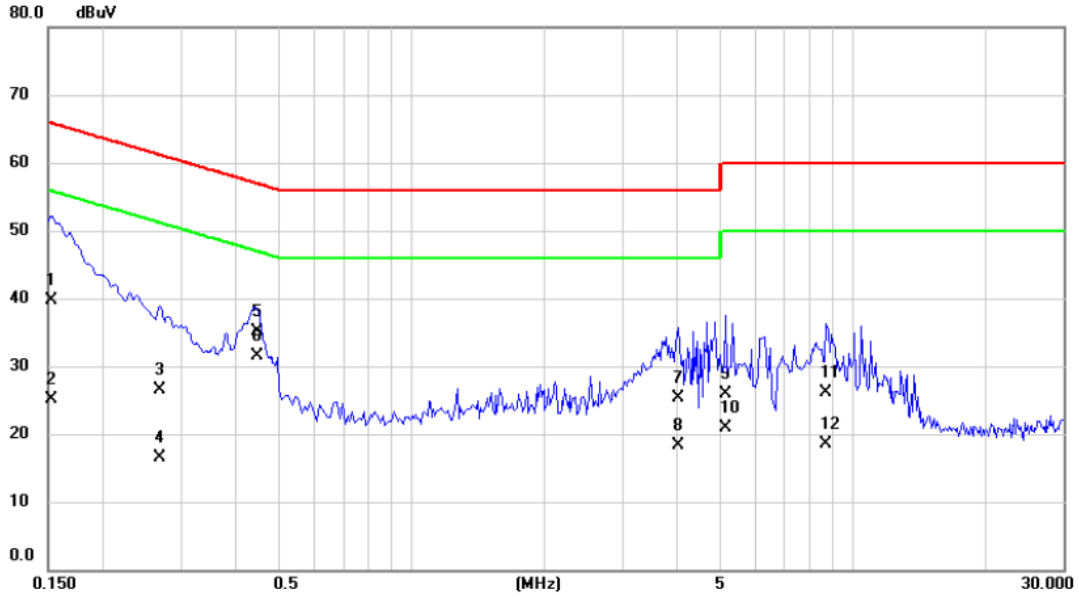

No.	Mk.	Freq. MHz	Reading Level dBuV	Correct Factor dB	Measure- ment dBuV	Limit dBuV	Over dB	Detector	Comment
1		0.1528	29.90	9.73	39.63	65.85	-26.22	QP	
2		0.1528	15.30	9.73	25.03	55.85	-30.82	AVG	
3		0.2690	16.80	9.73	26.53	61.15	-34.62	QP	
4		0.2690	6.80	9.73	16.53	51.15	-34.62	AVG	
5		0.4454	25.30	9.74	35.04	56.96	-21.92	QP	
6	*	0.4454	21.80	9.74	31.54	46.96	-15.42	AVG	
7		4.0100	15.40	9.81	25.21	56.00	-30.79	QP	
8		4.0100	8.50	9.81	18.31	46.00	-27.69	AVG	
9		5.1500	16.00	9.83	25.83	60.00	-34.17	QP	
10		5.1500	11.00	9.83	20.83	50.00	-29.17	AVG	
11		8.7000	16.10	9.94	26.04	60.00	-33.96	QP	
12		8.7000	8.50	9.94	18.44	50.00	-31.56	AVG	

Test Mode: TX Mode_ Antenna Type: PCB

Neutral

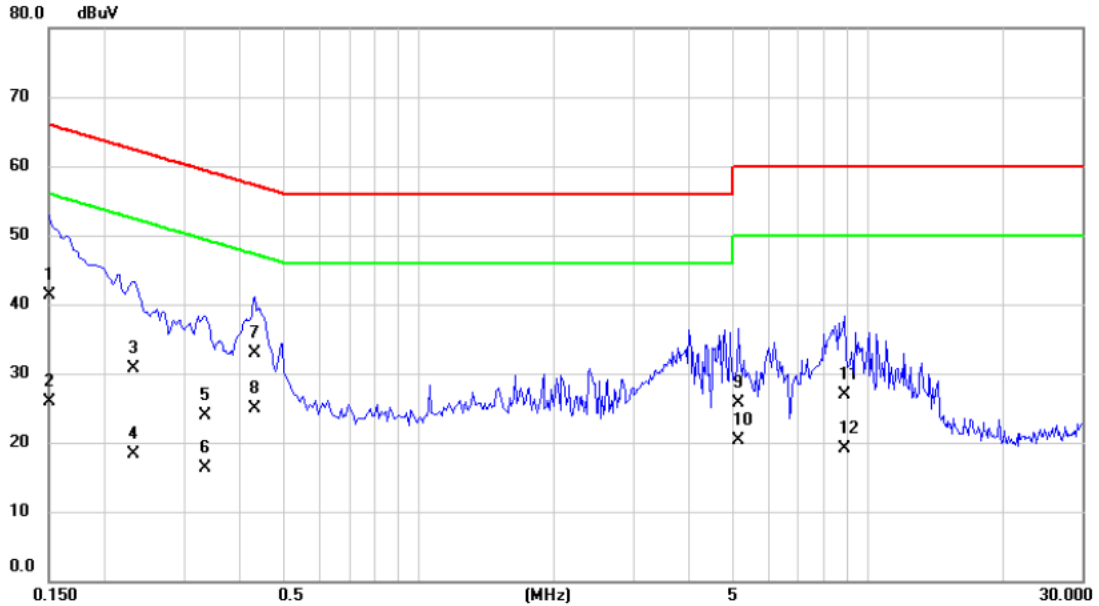

No.	Mk.	Freq. MHz	Reading Level dBuV	Correct Factor dB	Measurement dBuV	Limit dBuV	Over dB	Detector	Comment
1		0.1500	31.60	9.65	41.25	66.00	-24.75	QP	
2		0.1500	16.20	9.65	25.85	56.00	-30.15	AVG	
3		0.2320	21.00	9.66	30.66	62.38	-31.72	QP	
4		0.2320	8.70	9.66	18.36	52.38	-34.02	AVG	
5		0.3334	14.20	9.67	23.87	59.37	-35.50	QP	
6		0.3334	6.70	9.67	16.37	49.37	-33.00	AVG	
7		0.4307	23.30	9.68	32.98	57.24	-24.26	QP	
8	*	0.4307	15.30	9.68	24.98	47.24	-22.26	AVG	
9		5.1500	15.90	9.79	25.69	60.00	-34.31	QP	
10		5.1500	10.60	9.79	20.39	50.00	-29.61	AVG	
11		8.8500	17.00	9.92	26.92	60.00	-33.08	QP	
12		8.8500	9.20	9.92	19.12	50.00	-30.88	AVG	

APPENDIX B – RADIATED EMISSIONS (9KHZ to 30MHZ)

Test Mode: N/A

Note: "N/A" denotes test is not applicable to this device.

**APPENDIX C – RADIATED EMISSIONS
(30MHZ TO 1000MHZ)**

Test Mode: TX G Mode 2462MHz _ Antenna Type: Dipole

Vertical

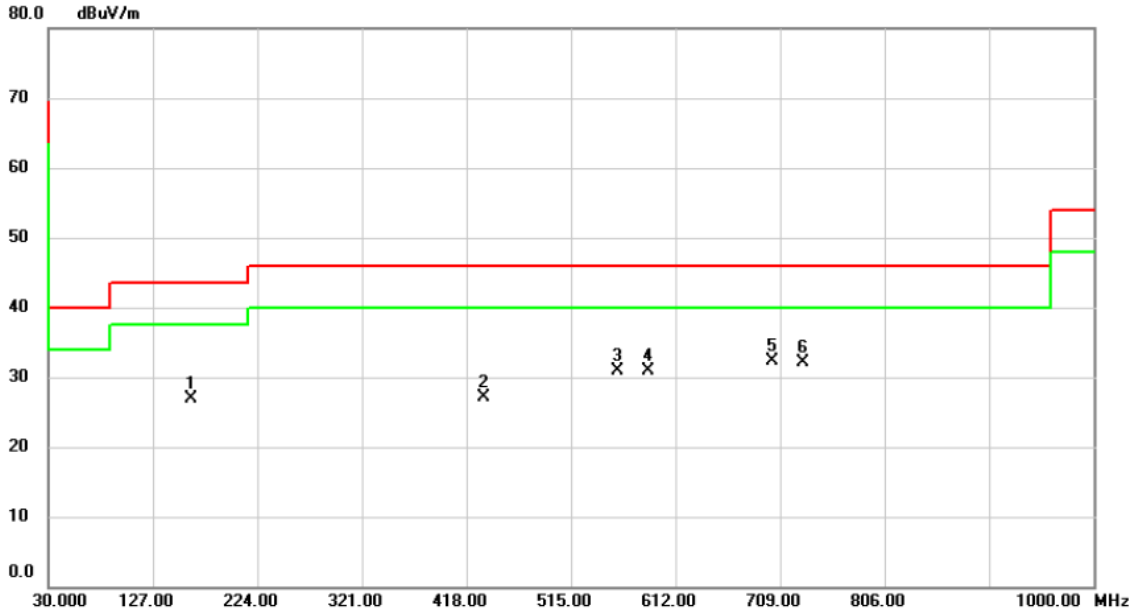

No.	Mk.	Freq. MHz	Reading Level dBuV	Correct Factor dB	Measure- ment dBuV/m	Limit dBuV/m	Over dB	Detector	Comment
1		162.8900	35.45	-8.59	26.86	43.50	-16.64	peak	
2		433.5200	31.13	-4.02	27.11	46.00	-18.89	peak	
3		558.6500	32.34	-1.49	30.85	46.00	-15.15	peak	
4		586.7800	31.60	-0.77	30.83	46.00	-15.17	peak	
5	*	701.2400	31.41	0.88	32.29	46.00	-13.71	peak	
6		730.3400	30.66	1.49	32.15	46.00	-13.85	peak	

Test Mode: TX G Mode 2462MHz _ Antenna Type: Dipole

Horizontal

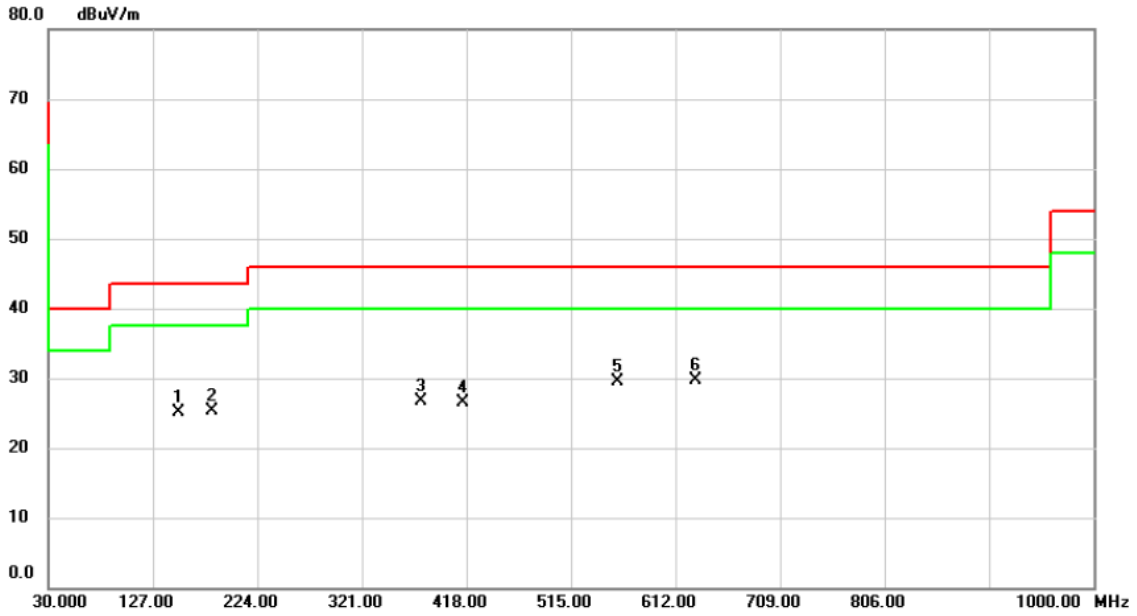

No.	Mk.	Freq. MHz	Reading Level dBuV	Correct Factor dB	Measure- ment dBuV/m	Limit dBuV/m	Over dB	Detector	Comment
1		150.2800	34.15	-8.95	25.20	43.50	-18.30	peak	
2		181.3200	34.95	-9.71	25.24	43.50	-18.26	peak	
3		375.3200	32.34	-5.58	26.76	46.00	-19.24	peak	
4		415.0900	31.06	-4.53	26.53	46.00	-19.47	peak	
5		558.6500	30.97	-1.49	29.48	46.00	-16.52	peak	
6	*	630.4300	29.81	-0.19	29.62	46.00	-16.38	peak	

Test Mode: TX G Mode 2437MHz _ Antenna Type: PCB

Vertical

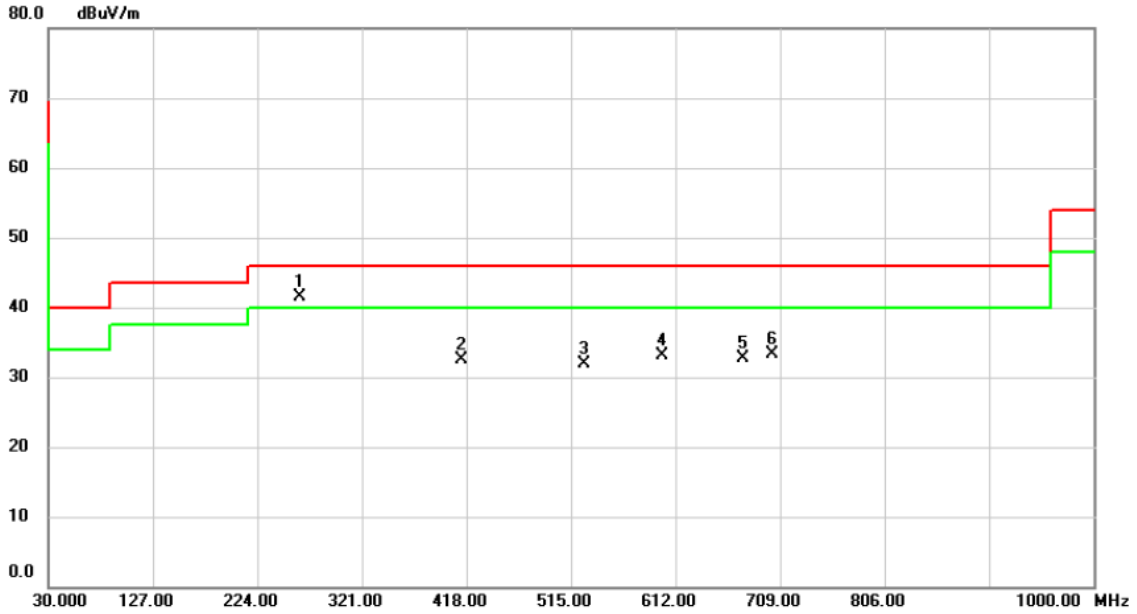

No.	Mk.	Freq. MHz	Reading Level dBuV	Correct Factor dB	Measure- ment dBuV/m	Limit dBuV/m	Over dB	Detector	Comment
1	*	262.8000	50.11	-8.67	41.44	46.00	-4.56	peak	
2		413.1500	37.14	-4.57	32.57	46.00	-13.43	peak	
3		526.6400	34.10	-2.20	31.90	46.00	-14.10	peak	
4		599.3900	33.53	-0.43	33.10	46.00	-12.90	peak	
5		674.0800	32.35	0.40	32.75	46.00	-13.25	peak	
6		701.2400	32.41	0.88	33.29	46.00	-12.71	peak	

Test Mode: TX G Mode 2437MHz _ Antenna Type: PCB

Horizontal

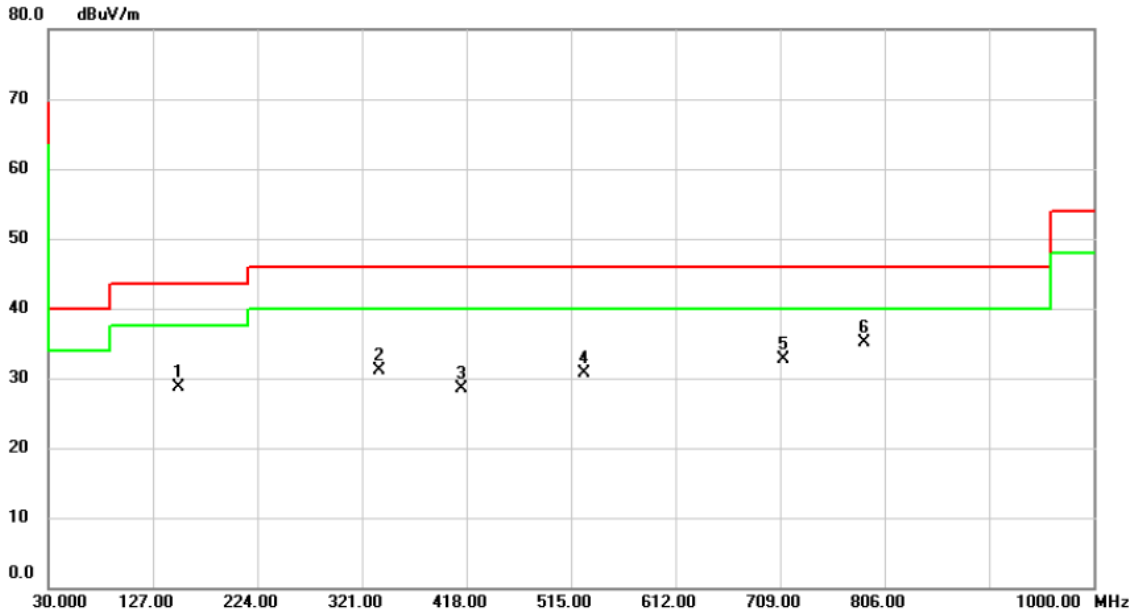

No.	Mk.	Freq. MHz	Reading Level dBuV	Correct Factor dB	Measure- ment dBuV/m	Limit dBuV/m	Over dB	Detector	Comment
1		150.2800	37.72	-8.95	28.77	43.50	-14.73	peak	
2		337.4900	37.68	-6.55	31.13	46.00	-14.87	peak	
3		413.1500	33.07	-4.57	28.50	46.00	-17.50	peak	
4		526.6400	32.97	-2.20	30.77	46.00	-15.23	peak	
5		711.9100	31.70	1.10	32.80	46.00	-13.20	peak	
6	*	786.6000	32.74	2.43	35.17	46.00	-10.83	peak	

**APPENDIX D – RADIATED EMISSIONS
(ABOVE 1000MHZ)**

Orthogonal Axis :	X
Test Mode :	TX B Mode 2412MHz _ Antenna Type: Dipole

Vertical

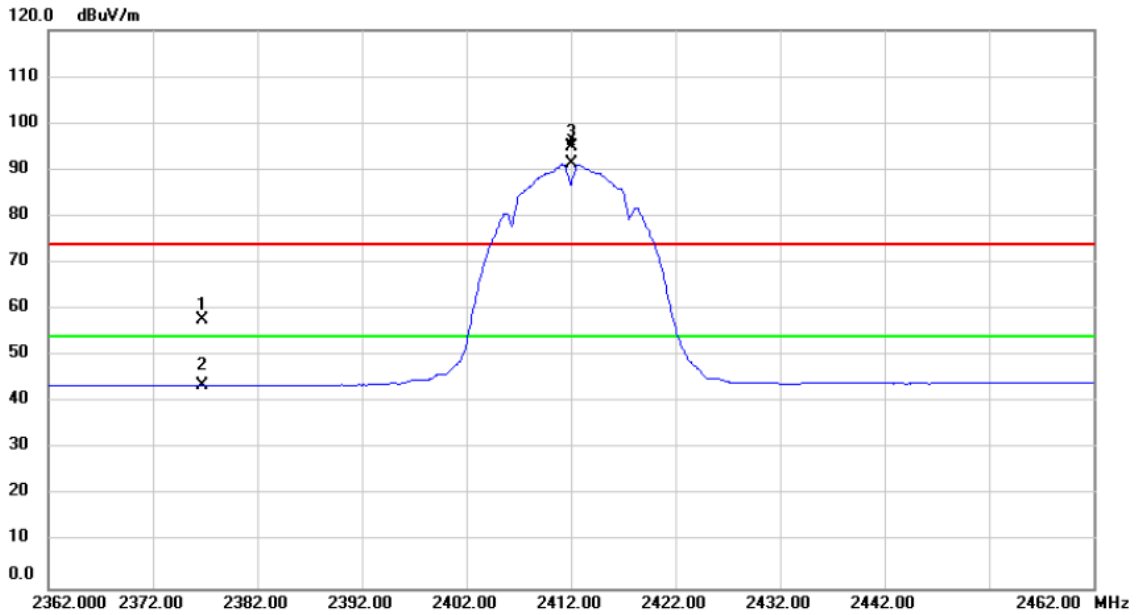

No.	Mk.	Freq. MHz	Reading Level dBuV	Correct Factor dB	Measure- ment dBuV/m	Limit dBuV/m	Over dB	Detector	Comment
1		2376.672	26.65	31.01	57.66	74.00	-16.34	peak	
2		2376.672	12.58	31.01	43.59	54.00	-10.41	AVG	
3	X	2412.000	63.85	31.14	94.99	74.00	20.99	peak	No Limit
4	*	2412.000	60.13	31.14	91.27	54.00	37.27	AVG	No Limit

Orthogonal Axis :	X
Test Mode :	TX B Mode 2412MHz _ Antenna Type: Dipole

Vertical

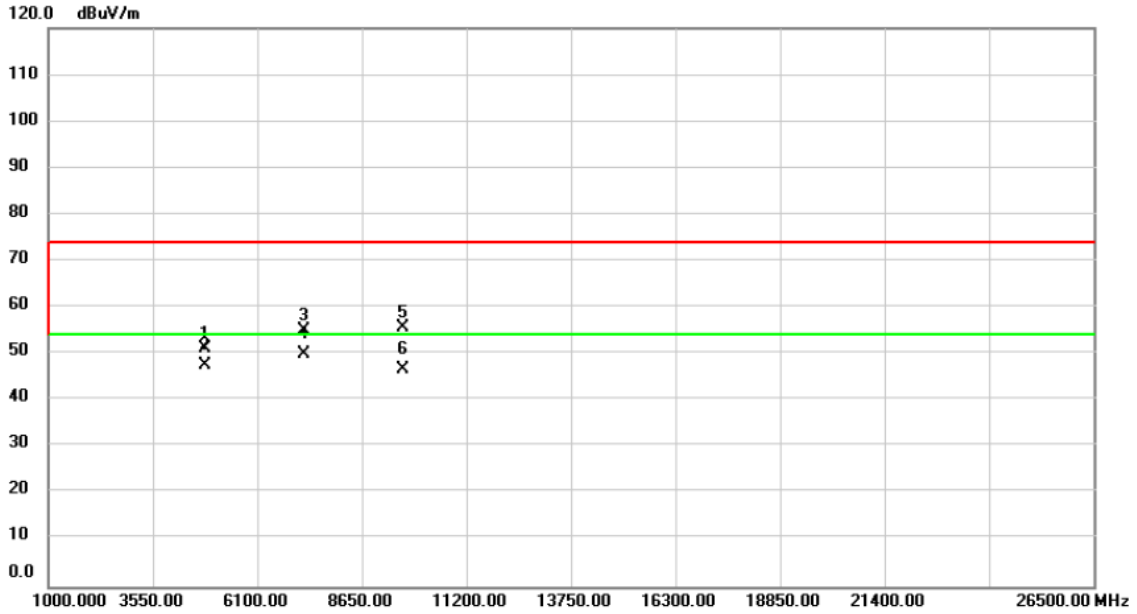

No. Mk.	Freq. MHz	Reading Level dBuV	Correct Factor dB	Measure- ment dBuV/m	Limit dBuV/m	Over dB	Detector	Comment
1	4824.000	62.63	-11.37	51.26	74.00	-22.74	peak	
2	4824.000	58.79	-11.37	47.42	54.00	-6.58	AVG	
3	7236.000	60.43	-5.40	55.03	74.00	-18.97	peak	
4 *	7236.000	55.27	-5.40	49.87	54.00	-4.13	AVG	
5	9648.000	55.20	0.53	55.73	74.00	-18.27	peak	
6	9648.000	46.13	0.53	46.66	54.00	-7.34	AVG	

Orthogonal Axis :	X
Test Mode :	TX B Mode 2412MHz _ Antenna Type: Dipole

Horizontal

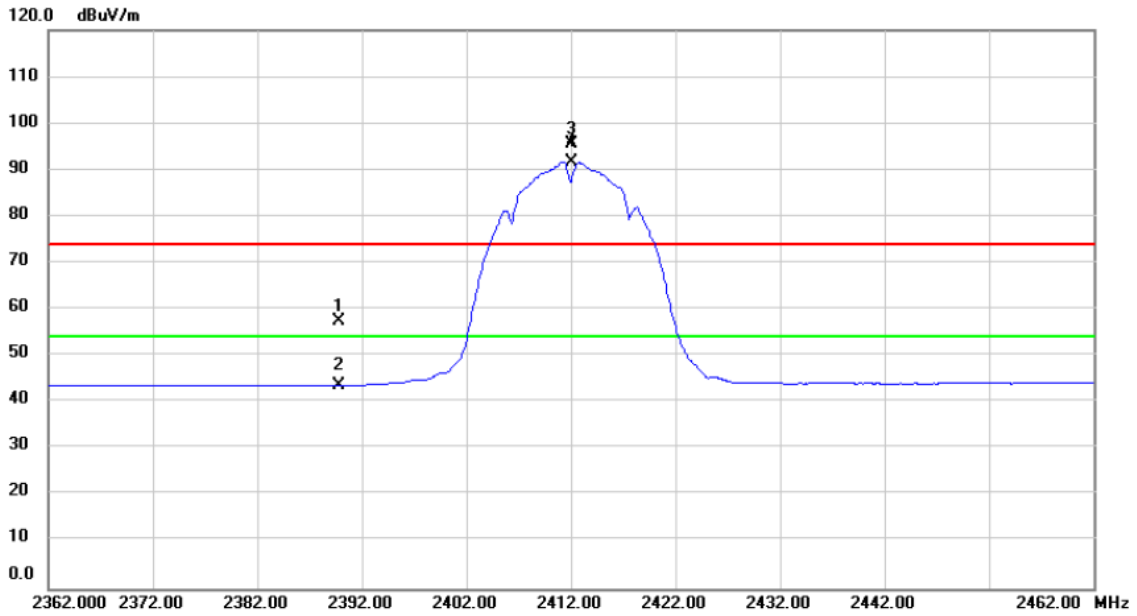

No.	Mk.	Freq.	Reading Level	Correct Factor	Measurement	Limit	Over	Detector	Comment
		MHz	dBuV	dB	dBuV/m	dBuV/m	dB		
1		2389.800	26.47	31.06	57.53	74.00	-16.47	peak	
2		2389.800	12.72	31.06	43.78	54.00	-10.22	AVG	
3	X	2412.000	64.32	31.14	95.46	74.00	21.46	peak	No Limit
4	*	2412.000	60.64	31.14	91.78	54.00	37.78	AVG	No Limit

Orthogonal Axis :	X
Test Mode :	TX B Mode 2412MHz _ Antenna Type: Dipole

Horizontal

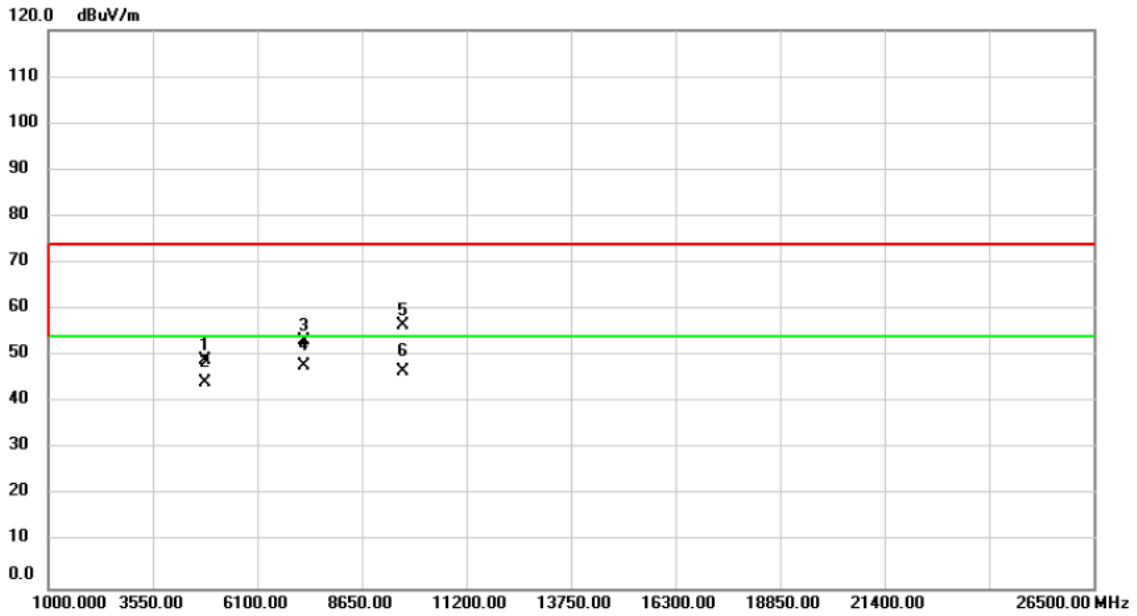

No. Mk.	Freq. MHz	Reading Level dBuV	Correct Factor dB	Measure- ment dBuV/m	Limit dBuV/m	Over dB	Detector	Comment
1	4824.000	60.35	-11.37	48.98	74.00	-25.02	peak	
2	4824.000	55.54	-11.37	44.17	54.00	-9.83	AVG	
3	7236.000	58.76	-5.40	53.36	74.00	-20.64	peak	
4 *	7236.000	53.10	-5.40	47.70	54.00	-6.30	AVG	
5	9648.000	56.00	0.53	56.53	74.00	-17.47	peak	
6	9648.000	46.03	0.53	46.56	54.00	-7.44	AVG	

Orthogonal Axis :	X
Test Mode :	TX B Mode 2437MHz _ Antenna Type: Dipole

Vertical

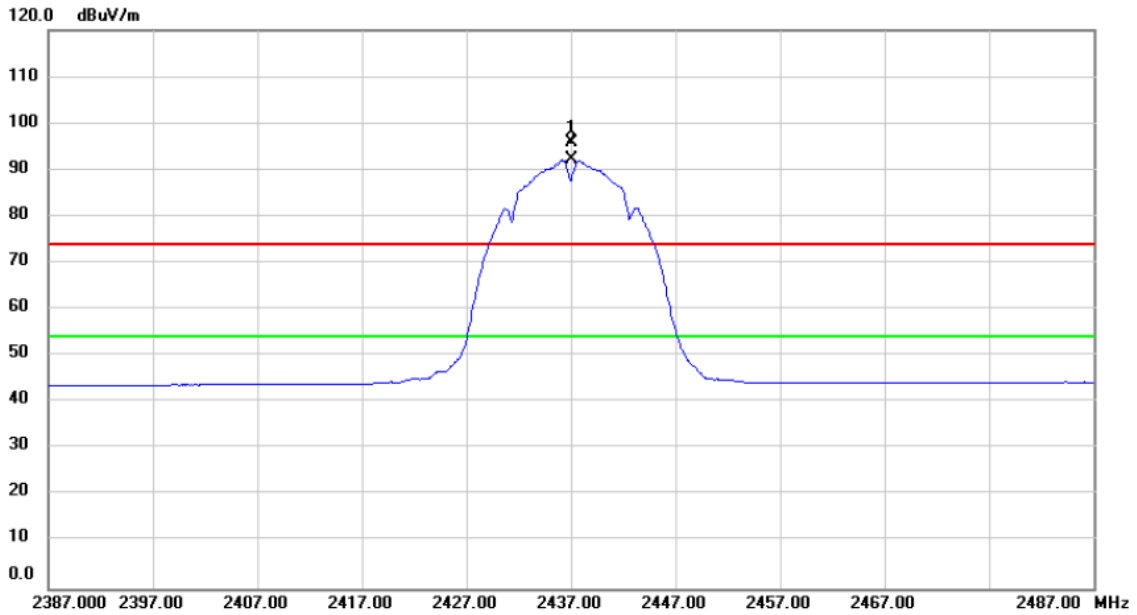

No.	Mk.	Freq.	Reading Level	Correct Factor	Measurement	Limit	Over	Detector	Comment
		MHz	dBuV	dB	dBuV/m	dBuV/m	dB		
1	X	2437.000	64.70	31.23	95.93	74.00	21.93	peak	No Limit
2	*	2437.000	60.91	31.23	92.14	54.00	38.14	AVG	No Limit

Orthogonal Axis :	X
Test Mode :	TX B Mode 2437MHz _ Antenna Type: Dipole

Vertical

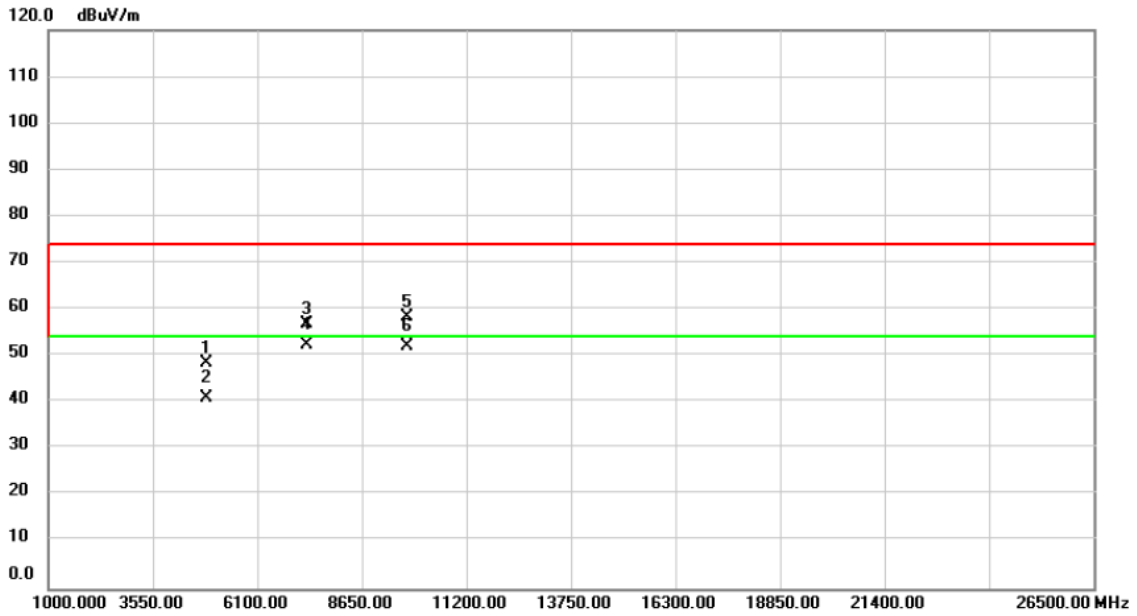

No. Mk.	Freq. MHz	Reading Level dBuV	Correct Factor dB	Measure- ment dBuV/m	Limit dBuV/m	Over dB	Detector	Comment
1	4874.000	59.60	-11.29	48.31	74.00	-25.69	peak	
2	4874.000	52.39	-11.29	41.10	54.00	-12.90	AVG	
3	7311.000	61.98	-5.13	56.85	74.00	-17.15	peak	
4 *	7311.000	57.46	-5.13	52.33	54.00	-1.67	AVG	
5	9748.000	57.58	0.90	58.48	74.00	-15.52	peak	
6	9748.000	51.07	0.90	51.97	54.00	-2.03	AVG	

Orthogonal Axis :	X
Test Mode :	TX B Mode 2437MHz _ Antenna Type: Dipole

Horizontal

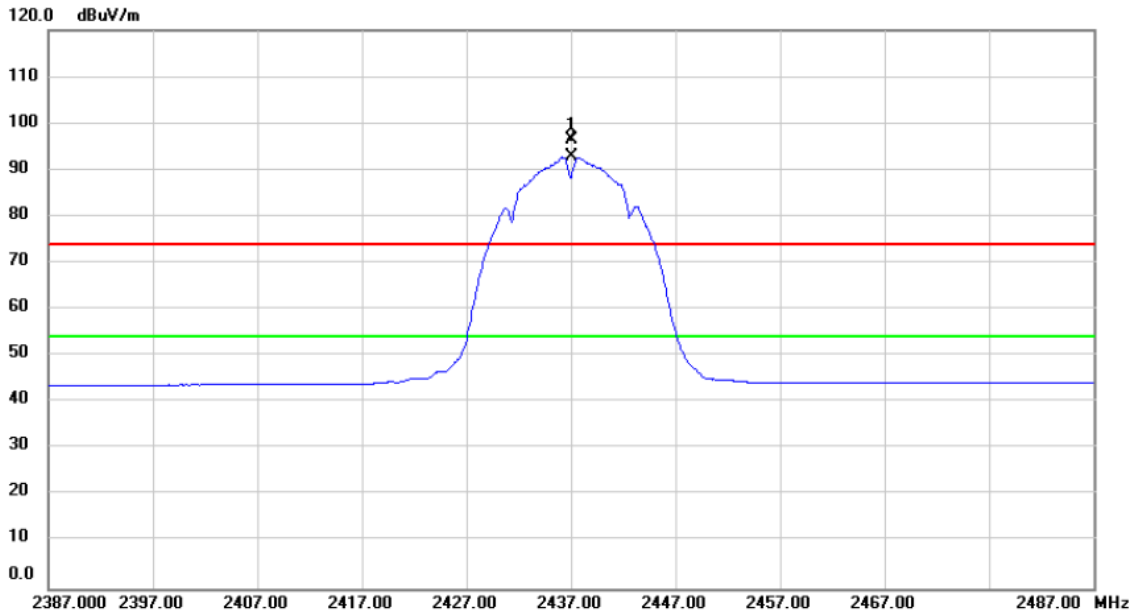

No.	Mk.	Freq.	Reading Level	Correct Factor	Measurement	Limit	Over	Detector	Comment
		MHz	dBuV	dB	dBuV/m	dBuV/m	dB		
1	X	2437.000	65.27	31.23	96.50	74.00	22.50	peak	No Limit
2	*	2437.000	61.50	31.23	92.73	54.00	38.73	AVG	No Limit

Orthogonal Axis :	X
Test Mode :	TX B Mode 2437MHz _ Antenna Type: Dipole

Horizontal

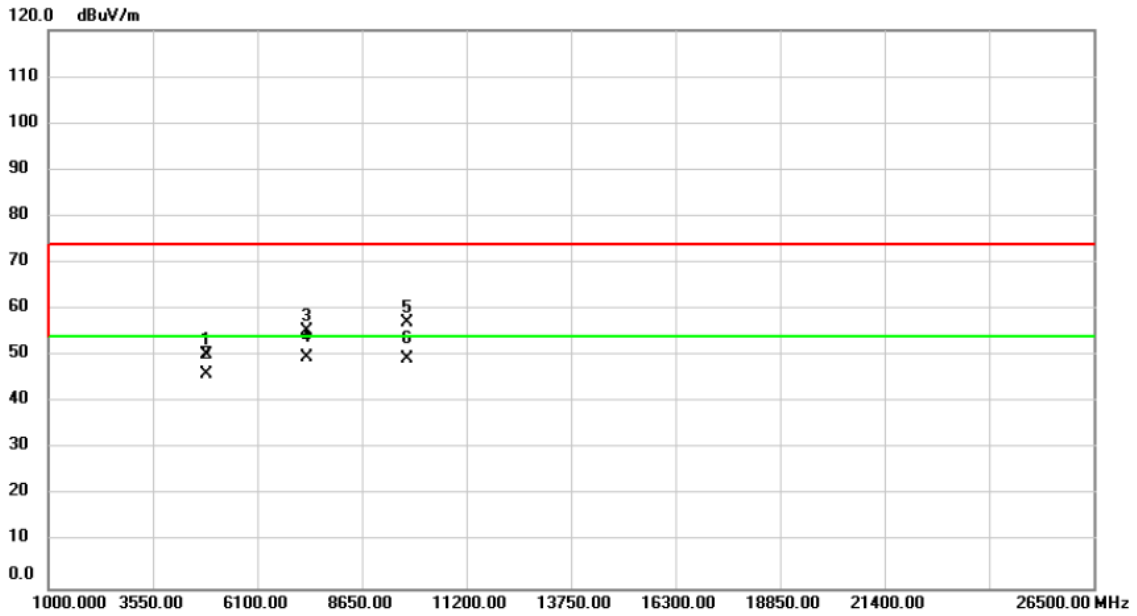

No.	Mk.	Freq. MHz	Reading Level dBuV	Correct Factor dB	Measure- ment dBuV/m	Limit dBuV/m	Over dB	Detector	Comment
1		4874.000	61.58	-11.29	50.29	74.00	-23.71	peak	
2		4874.000	57.42	-11.29	46.13	54.00	-7.87	AVG	
3		7311.000	60.51	-5.13	55.38	74.00	-18.62	peak	
4	*	7311.000	54.74	-5.13	49.61	54.00	-4.39	AVG	
5		9748.000	56.36	0.90	57.26	74.00	-16.74	peak	
6		9748.000	48.49	0.90	49.39	54.00	-4.61	AVG	

Orthogonal Axis :	X
Test Mode :	TX B Mode 2462MHz _ Antenna Type: Dipole

Vertical

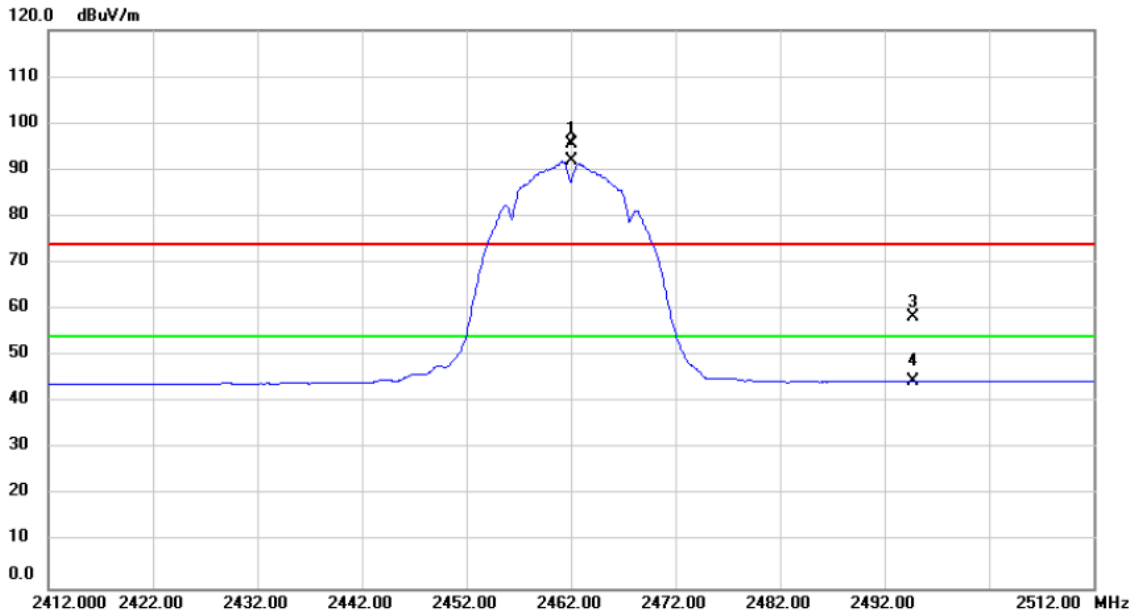

No.	Mk.	Freq.	Reading Level	Correct Factor	Measurement	Limit	Over	Detector	Comment
		MHz	dBuV	dB	dBuV/m	dBuV/m	dB		
1	X	2462.000	64.11	31.33	95.44	74.00	21.44	peak	No Limit
2	*	2462.000	60.50	31.33	91.83	54.00	37.83	AVG	No Limit
3		2494.700	27.04	31.46	58.50	74.00	-15.50	peak	
4		2494.700	13.14	31.46	44.60	54.00	-9.40	AVG	

Orthogonal Axis :	X
Test Mode :	TX B Mode 2462MHz _ Antenna Type: Dipole

Vertical

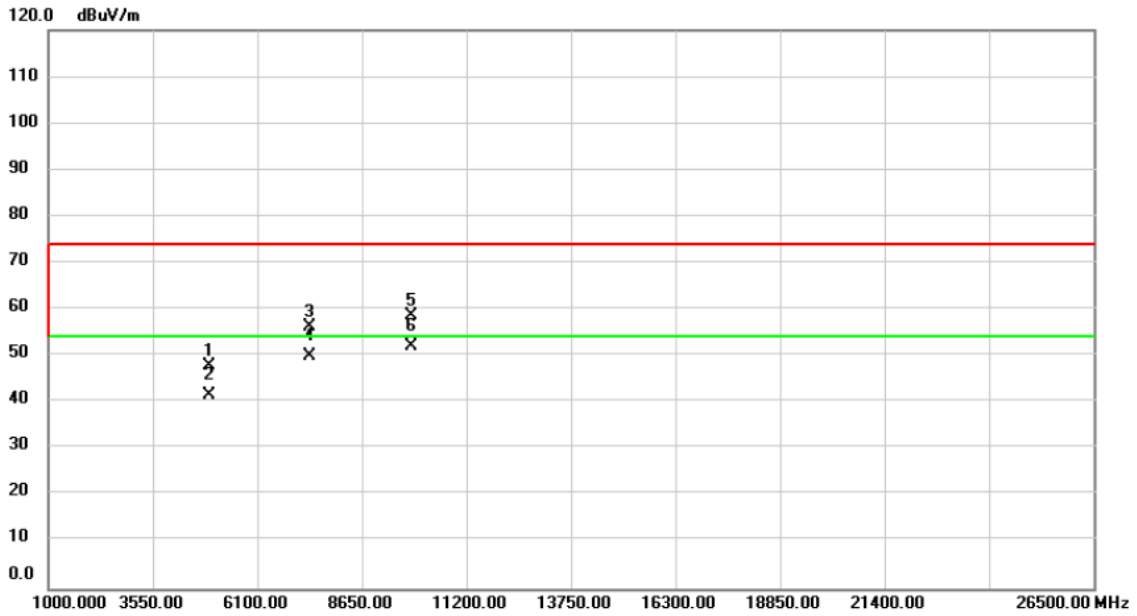

No.	Mk.	Freq.	Reading Level	Correct Factor	Measurement	Limit	Over	Detector	Comment
		MHz	dBuV	dB	dBuV/m	dBuV/m	dB		
1		4924.000	59.05	-11.22	47.83	74.00	-26.17	peak	
2		4924.000	52.85	-11.22	41.63	54.00	-12.37	AVG	
3		7386.000	61.09	-4.87	56.22	74.00	-17.78	peak	
4		7386.000	54.94	-4.87	50.07	54.00	-3.93	AVG	
5		9848.000	57.26	1.27	58.53	74.00	-15.47	peak	
6	*	9848.000	50.80	1.27	52.07	54.00	-1.93	AVG	

Orthogonal Axis :	X
Test Mode :	TX B Mode 2462MHz _ Antenna Type: Dipole

Horizontal

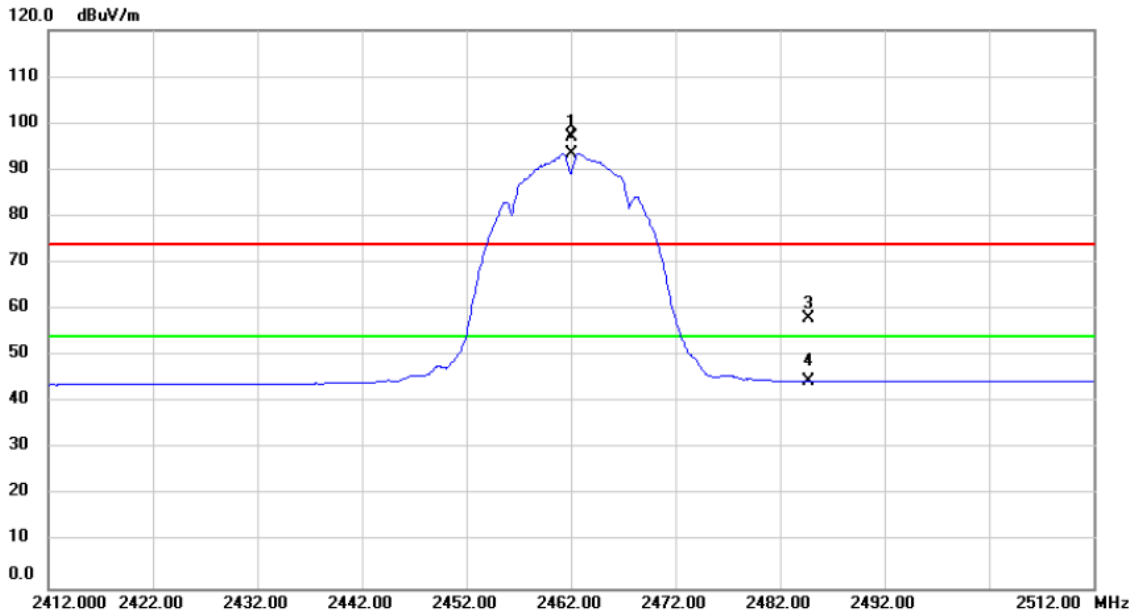

No.	Mk.	Freq.	Reading Level	Correct Factor	Measurement	Limit	Over	Detector	Comment
		MHz	dBuV	dB	dBuV/m	dBuV/m	dB		
1	X	2462.000	65.81	31.33	97.14	74.00	23.14	peak	No Limit
2	*	2462.000	62.14	31.33	93.47	54.00	39.47	AVG	No Limit
3		2484.726	26.51	31.42	57.93	74.00	-16.07	peak	
4		2484.726	13.17	31.42	44.59	54.00	-9.41	AVG	

Orthogonal Axis :	X
Test Mode :	TX B Mode 2462MHz _ Antenna Type: Dipole

Horizontal

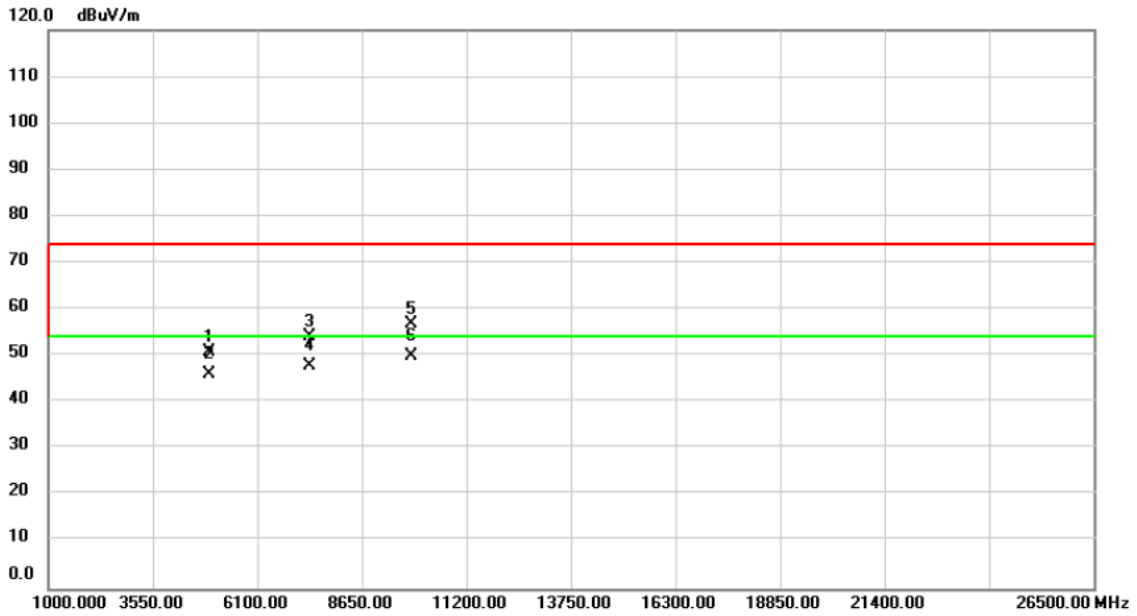

No.	Mk.	Freq. MHz	Reading Level dBuV	Correct Factor dB	Measure- ment dBuV/m	Limit dBuV/m	Over dB	Detector	Comment
1		4924.000	61.97	-11.22	50.75	74.00	-23.25	peak	
2		4924.000	57.13	-11.22	45.91	54.00	-8.09	AVG	
3		7386.000	59.05	-4.87	54.18	74.00	-19.82	peak	
4		7386.000	52.59	-4.87	47.72	54.00	-6.28	AVG	
5		9848.000	55.51	1.27	56.78	74.00	-17.22	peak	
6	*	9848.000	48.61	1.27	49.88	54.00	-4.12	AVG	

Orthogonal Axis :	X
Test Mode :	TX G Mode 2412MHz _ Antenna Type: Dipole

Vertical

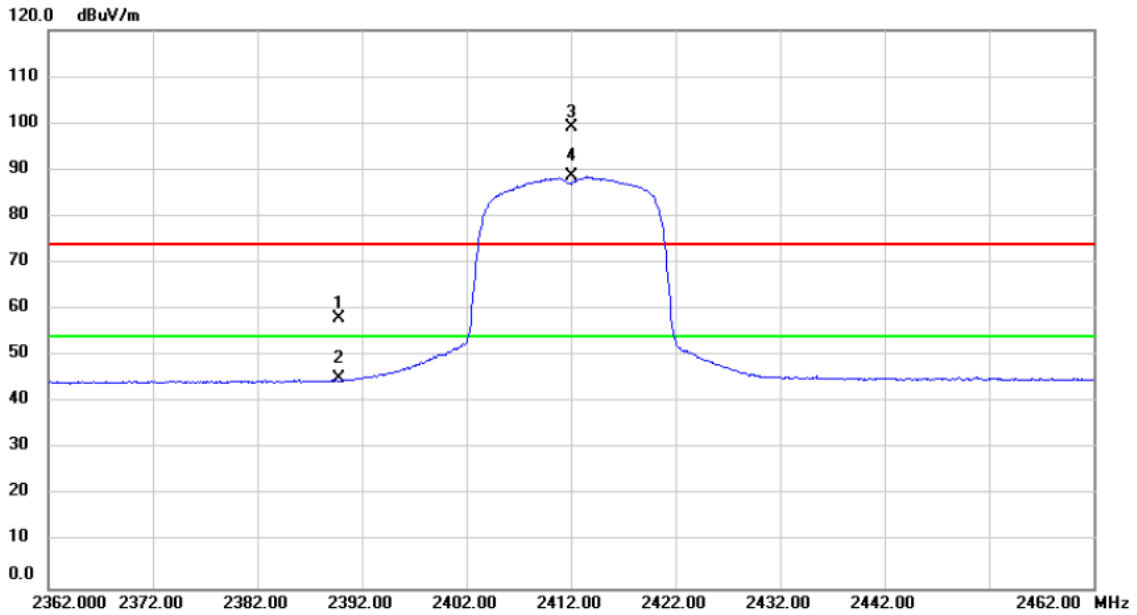

No.	Mk.	Freq.	Reading Level	Correct Factor	Measurement	Limit	Over	Detector	Comment
		MHz	dBuV	dB	dBuV/m	dBuV/m	dB		
1		2389.832	27.03	31.06	58.09	74.00	-15.91	peak	
2		2389.832	13.97	31.06	45.03	54.00	-8.97	AVG	
3	X	2412.000	68.05	31.14	99.19	74.00	25.19	peak	No Limit
4	*	2412.000	57.39	31.14	88.53	54.00	34.53	AVG	No Limit

Orthogonal Axis :	X
Test Mode :	TX G Mode 2412MHz _ Antenna Type: Dipole

Vertical

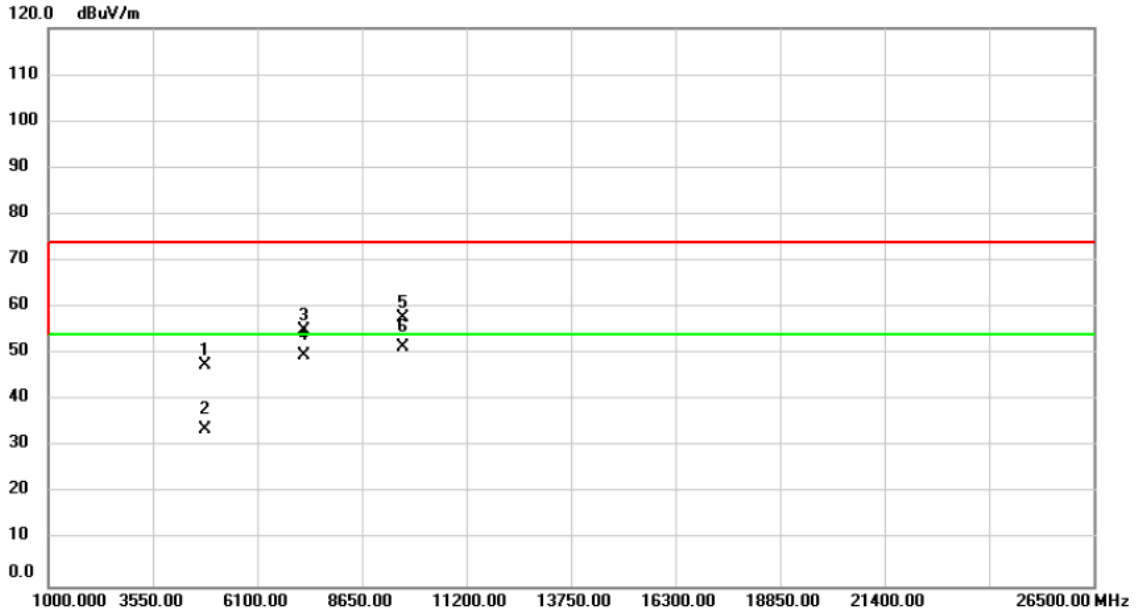

No.	Mk.	Freq. MHz	Reading Level dBuV	Correct Factor dB	Measure- ment dBuV/m	Limit dBuV/m	Over dB	Detector	Comment
1		4824.000	58.83	-11.37	47.46	74.00	-26.54	peak	
2		4824.000	45.27	-11.37	33.90	54.00	-20.10	AVG	
3		7236.000	60.56	-5.40	55.16	74.00	-18.84	peak	
4		7236.000	55.15	-5.40	49.75	54.00	-4.25	AVG	
5		9648.000	57.23	0.53	57.76	74.00	-16.24	peak	
6	*	9648.000	50.93	0.53	51.46	54.00	-2.54	AVG	

Orthogonal Axis :	X
Test Mode :	TX G Mode 2412MHz _ Antenna Type: Dipole

Horizontal

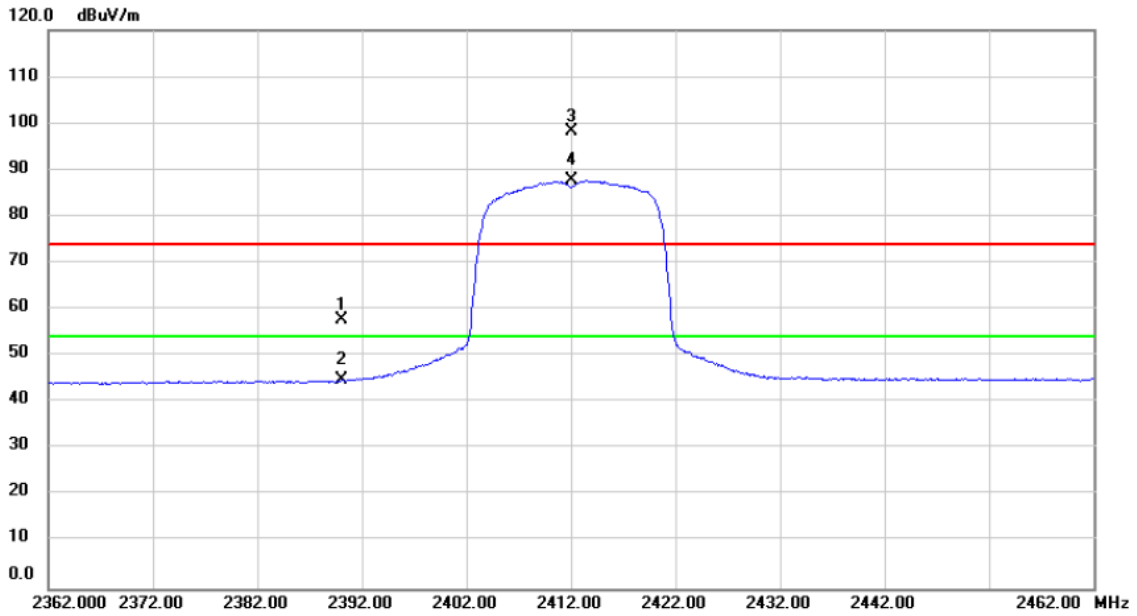

No.	Mk.	Freq. MHz	Reading Level dBuV	Correct Factor dB	Measure- ment dBuV/m	Limit dBuV/m	Over dB	Detector	Comment
1		2390.000	26.84	31.06	57.90	74.00	-16.10	peak	
2		2390.000	13.66	31.06	44.72	54.00	-9.28	AVG	
3	X	2412.000	67.02	31.14	98.16	74.00	24.16	peak	No Limit
4	*	2412.000	56.60	31.14	87.74	54.00	33.74	AVG	No Limit

Orthogonal Axis :	X
Test Mode :	TX G Mode 2412MHz _ Antenna Type: Dipole

Horizontal

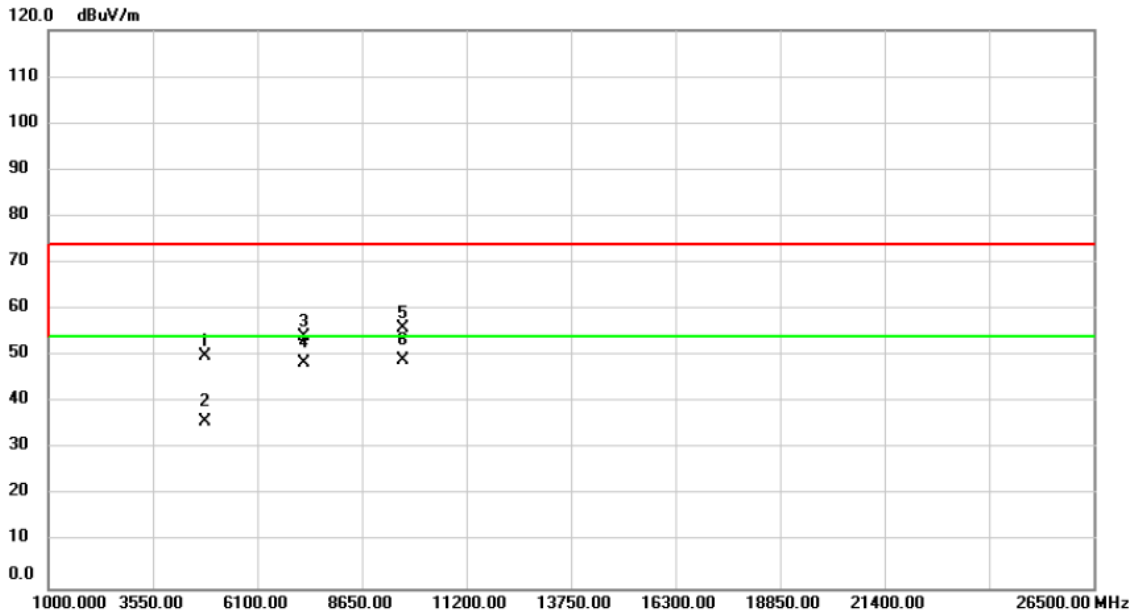

No.	Mk.	Freq.	Reading Level	Correct Factor	Measurement	Limit	Over	Detector	Comment
		MHz	dBuV	dB	dBuV/m	dBuV/m	dB		
1		4824.000	61.41	-11.37	50.04	74.00	-23.96	peak	
2		4824.000	47.27	-11.37	35.90	54.00	-18.10	AVG	
3		7236.000	59.45	-5.40	54.05	74.00	-19.95	peak	
4		7236.000	53.76	-5.40	48.36	54.00	-5.64	AVG	
5		9648.000	55.57	0.53	56.10	74.00	-17.90	peak	
6	*	9648.000	48.40	0.53	48.93	54.00	-5.07	AVG	

Orthogonal Axis :	X
Test Mode :	TX G Mode 2437MHz _ Antenna Type: Dipole

Vertical

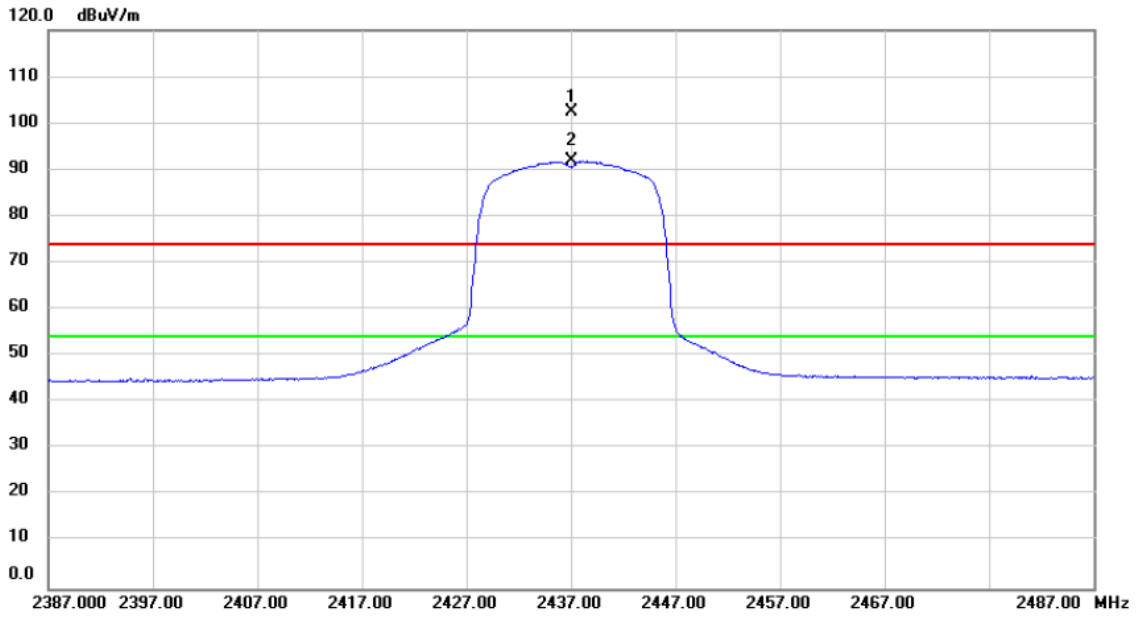

No.	Mk.	Freq.	Reading Level	Correct Factor	Measurement	Limit	Over	Detector	Comment
		MHz	dBuV	dB	dBuV/m	dBuV/m	dB		
1	X	2437.000	71.08	31.23	102.31	74.00	28.31	peak	No Limit
2	*	2437.000	60.67	31.23	91.90	54.00	37.90	AVG	No Limit

Orthogonal Axis :	X
Test Mode :	TX G Mode 2437MHz _ Antenna Type: Dipole

Vertical

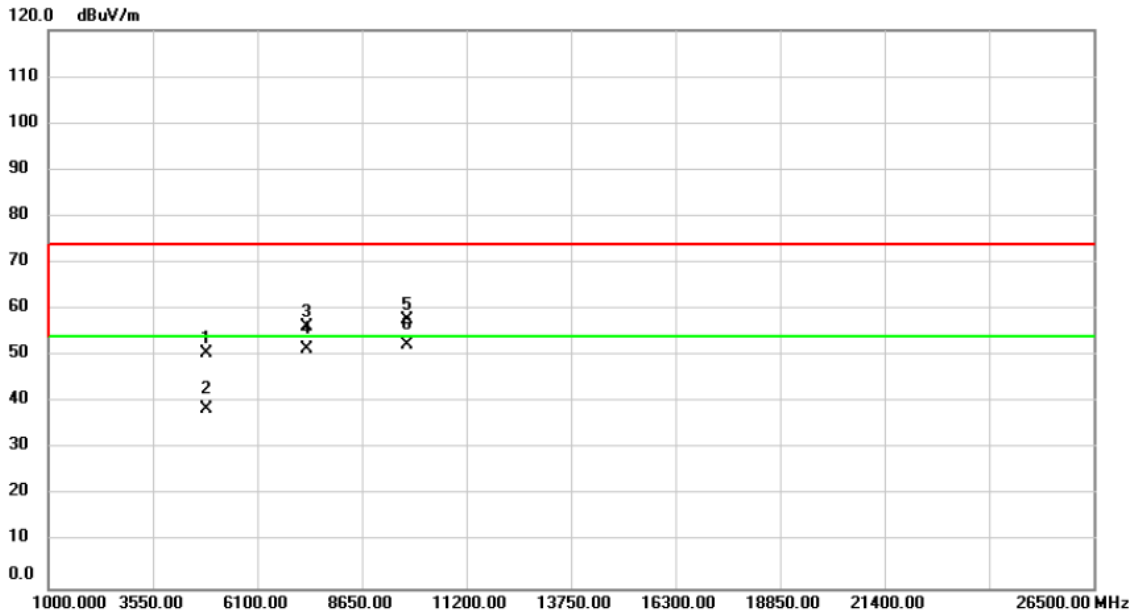

No.	Mk.	Freq.	Reading Level	Correct Factor	Measurement	Limit	Over	Detector	Comment
		MHz	dBuV	dB	dBuV/m	dBuV/m	dB		
1		4874.000	61.97	-11.29	50.68	74.00	-23.32	peak	
2		4874.000	49.87	-11.29	38.58	54.00	-15.42	AVG	
3		7311.000	61.36	-5.13	56.23	74.00	-17.77	peak	
4		7311.000	56.54	-5.13	51.41	54.00	-2.59	AVG	
5		9748.000	56.85	0.90	57.75	74.00	-16.25	peak	
6	*	9748.000	51.32	0.90	52.22	54.00	-1.78	AVG	

Orthogonal Axis :	X
Test Mode :	TX G Mode 2437MHz _ Antenna Type: Dipole

Horizontal

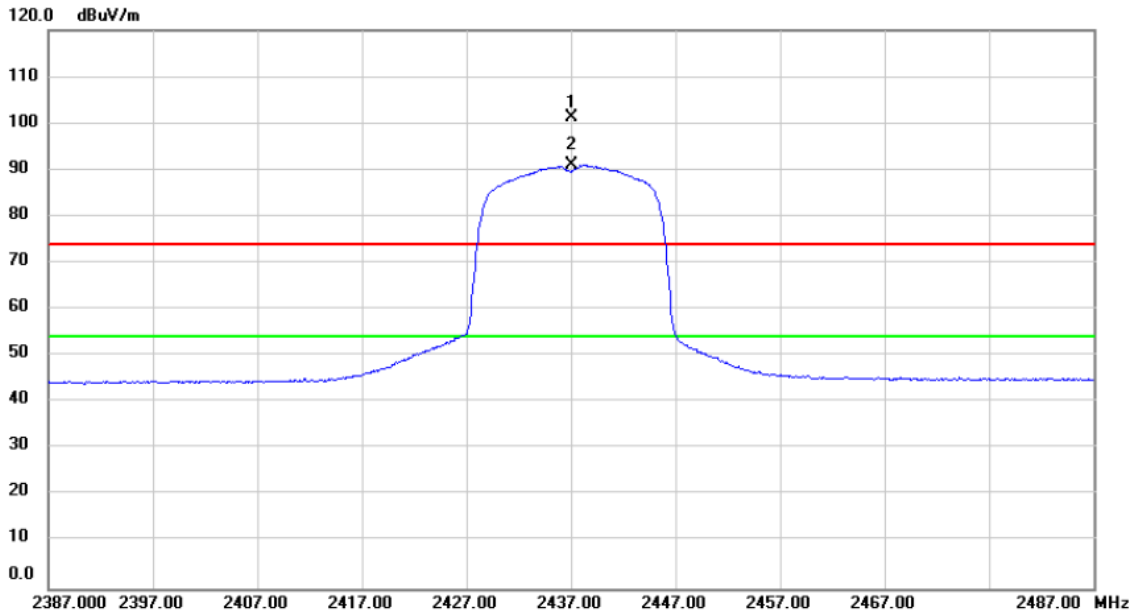

No.	Mk.	Freq.	Reading Level	Correct Factor	Measurement	Limit	Over	Detector	Comment
		MHz	dBuV	dB	dBuV/m	dBuV/m	dB		
1	X	2437.000	69.96	31.23	101.19	74.00	27.19	peak	No Limit
2	*	2437.000	59.82	31.23	91.05	54.00	37.05	AVG	No Limit

Orthogonal Axis :	X
Test Mode :	TX G Mode 2437MHz _ Antenna Type: Dipole

Horizontal

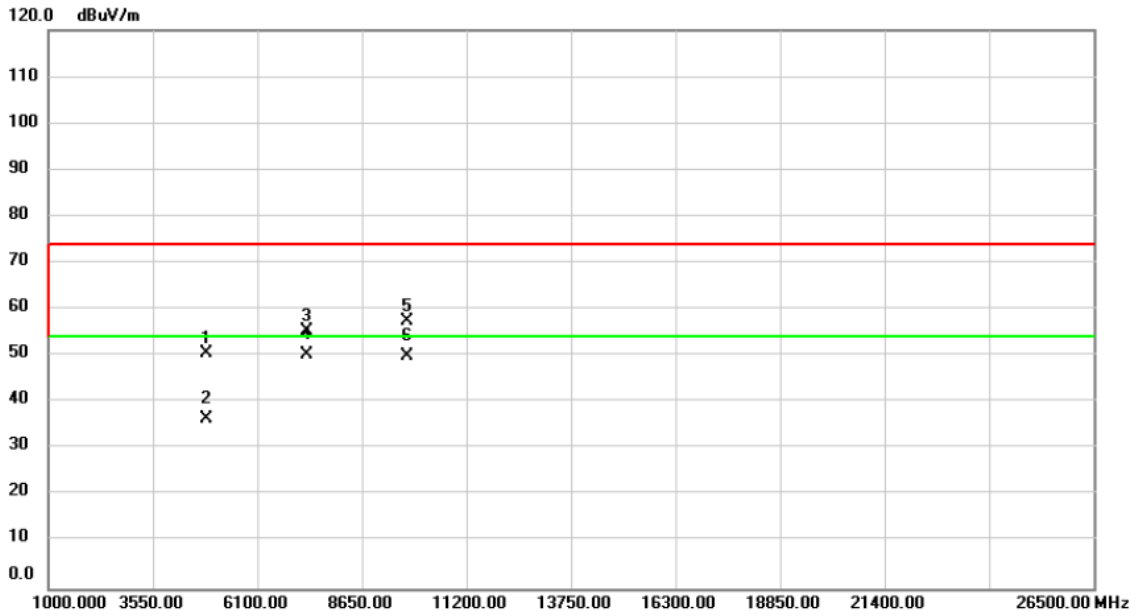

No. Mk.	Freq. MHz	Reading Level dBuV	Correct Factor dB	Measurement dBuV/m	Limit dBuV/m	Over dB	Detector	Comment
1	4874.000	61.82	-11.29	50.53	74.00	-23.47	peak	
2	4874.000	47.72	-11.29	36.43	54.00	-17.57	AVG	
3	7311.000	60.52	-5.13	55.39	74.00	-18.61	peak	
4 *	7311.000	55.51	-5.13	50.38	54.00	-3.62	AVG	
5	9748.000	56.58	0.90	57.48	74.00	-16.52	peak	
6	9748.000	49.08	0.90	49.98	54.00	-4.02	AVG	

Orthogonal Axis :	X
Test Mode :	TX G Mode 2462MHz _ Antenna Type: Dipole

Vertical

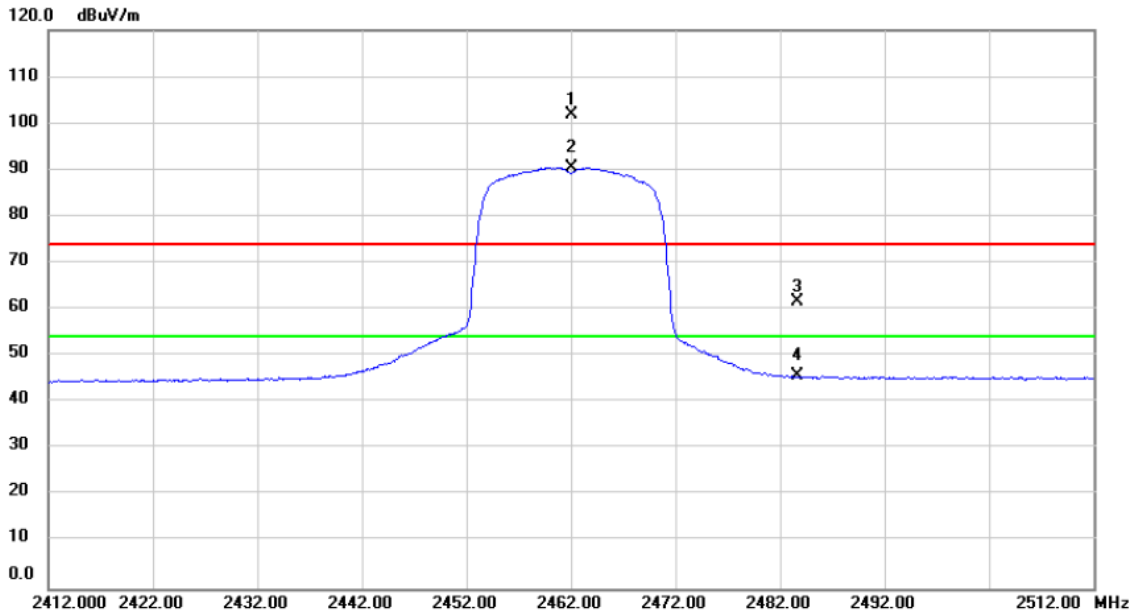

No.	Mk.	Freq.	Reading Level	Correct Factor	Measurement	Limit	Over	Detector	Comment
		MHz	dBuV	dB	dBuV/m	dBuV/m	dB		
1	X	2462.000	70.40	31.33	101.73	74.00	27.73	peak	No Limit
2	*	2462.000	59.23	31.33	90.56	54.00	36.56	AVG	No Limit
3		2483.700	30.18	31.41	61.59	74.00	-12.41	peak	
4		2483.700	14.35	31.41	45.76	54.00	-8.24	AVG	

Orthogonal Axis :	X
Test Mode :	TX G Mode 2462MHz _ Antenna Type: Dipole

Vertical

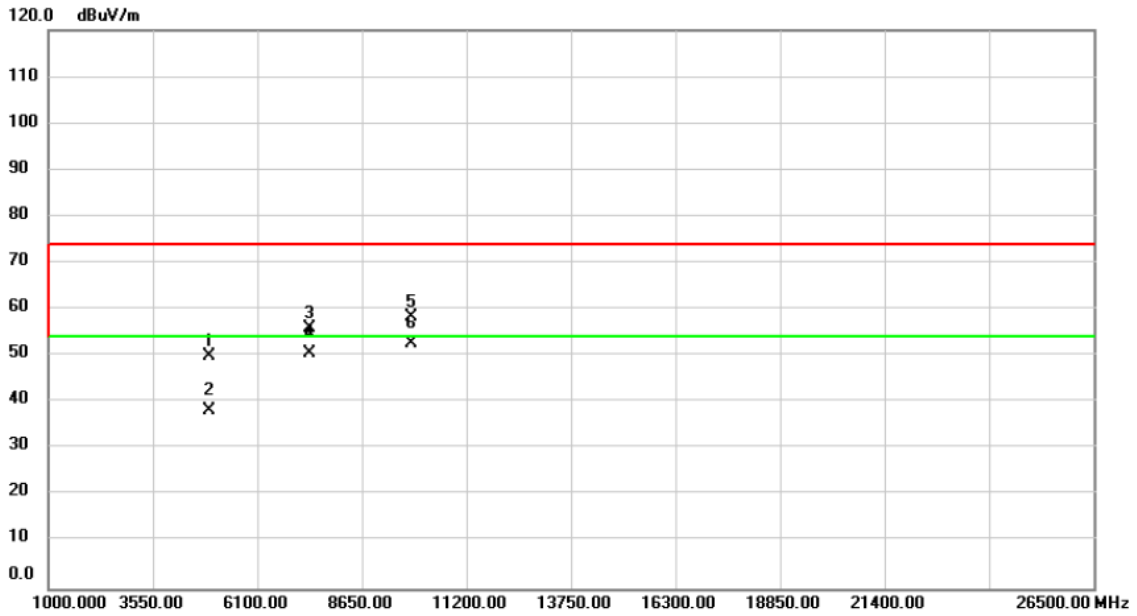

No.	Mk.	Freq. MHz	Reading Level dBuV	Correct Factor dB	Measure- ment dBuV/m	Limit dBuV/m	Over dB	Detector	Comment
1		4924.000	61.20	-11.22	49.98	74.00	-24.02	peak	
2		4924.000	49.55	-11.22	38.33	54.00	-15.67	AVG	
3		7386.000	60.81	-4.87	55.94	74.00	-18.06	peak	
4		7386.000	55.28	-4.87	50.41	54.00	-3.59	AVG	
5		9848.000	57.14	1.27	58.41	74.00	-15.59	peak	
6	*	9848.000	51.46	1.27	52.73	54.00	-1.27	AVG	

Orthogonal Axis :	X
Test Mode :	TX G Mode 2462MHz _ Antenna Type: Dipole

Horizontal

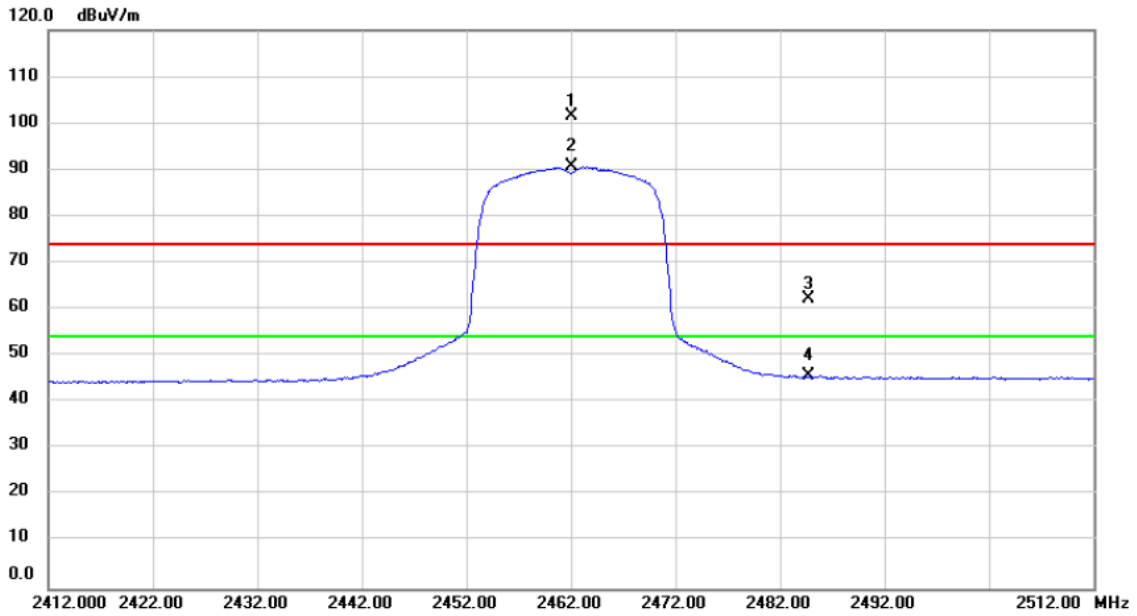

No.	Mk.	Freq.	Reading Level	Correct Factor	Measurement	Limit	Over	Detector	Comment
		MHz	dBuV	dB	dBuV/m	dBuV/m	dB		
1	X	2462.000	70.24	31.33	101.57	74.00	27.57	peak	No Limit
2	*	2462.000	59.36	31.33	90.69	54.00	36.69	AVG	No Limit
3		2484.754	30.84	31.42	62.26	74.00	-11.74	peak	
4		2484.754	14.35	31.42	45.77	54.00	-8.23	AVG	

Orthogonal Axis :	X
Test Mode :	TX G Mode 2462MHz _ Antenna Type: Dipole

Horizontal

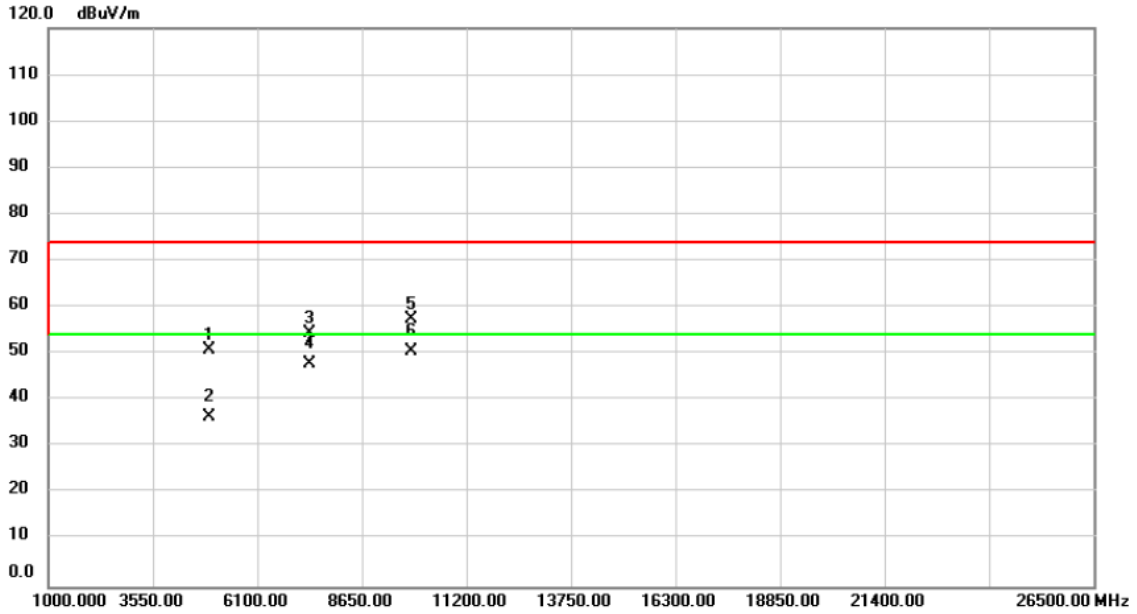

No. Mk.	Freq. MHz	Reading Level dBuV	Correct Factor dB	Measure- ment dBuV/m	Limit dBuV/m	Over dB	Detector	Comment
1	4924.000	62.07	-11.22	50.85	74.00	-23.15	peak	
2	4924.000	47.75	-11.22	36.53	54.00	-17.47	AVG	
3	7386.000	59.26	-4.87	54.39	74.00	-19.61	peak	
4	7386.000	52.66	-4.87	47.79	54.00	-6.21	AVG	
5	9848.000	56.33	1.27	57.60	74.00	-16.40	peak	
6 *	9848.000	49.41	1.27	50.68	54.00	-3.32	AVG	

Orthogonal Axis :	X
Test Mode :	TX N-20M Mode 2412MHz _ Antenna Type: Dipole

Vertical

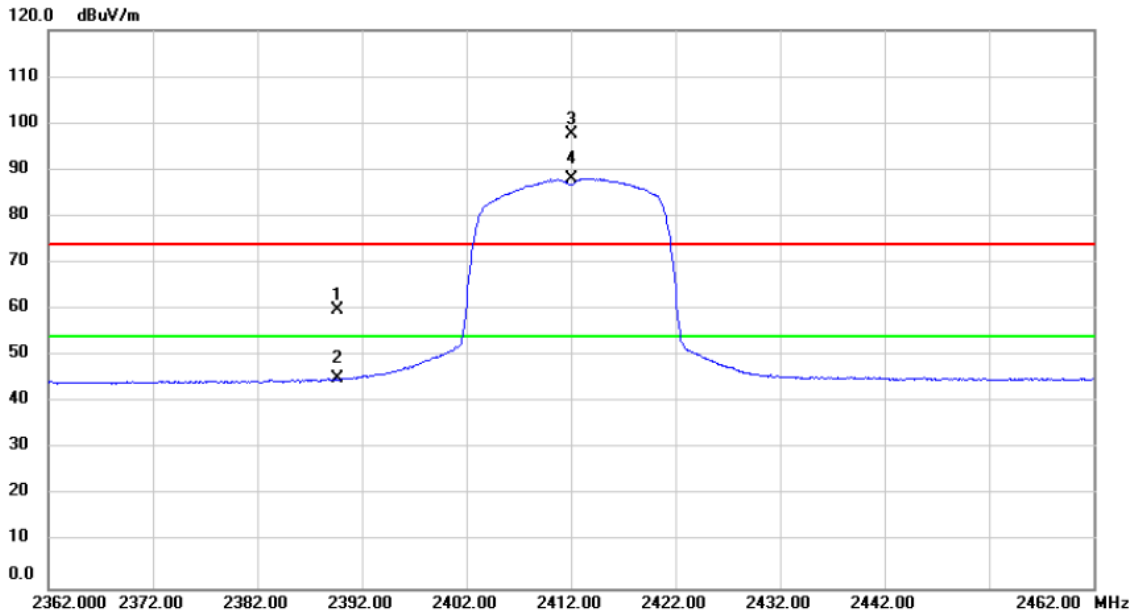

No.	Mk.	Freq. MHz	Reading Level dBuV	Correct Factor dB	Measure- ment dBuV/m	Limit dBuV/m	Over dB	Detector	Comment
1		2389.720	28.92	31.06	59.98	74.00	-14.02	peak	
2		2389.720	14.08	31.06	45.14	54.00	-8.86	AVG	
3	X	2412.000	66.37	31.14	97.51	74.00	23.51	peak	No Limit
4	*	2412.000	57.04	31.14	88.18	54.00	34.18	AVG	No Limit

Orthogonal Axis :	X
Test Mode :	TX N-20M Mode 2412MHz _ Antenna Type: Dipole

Vertical

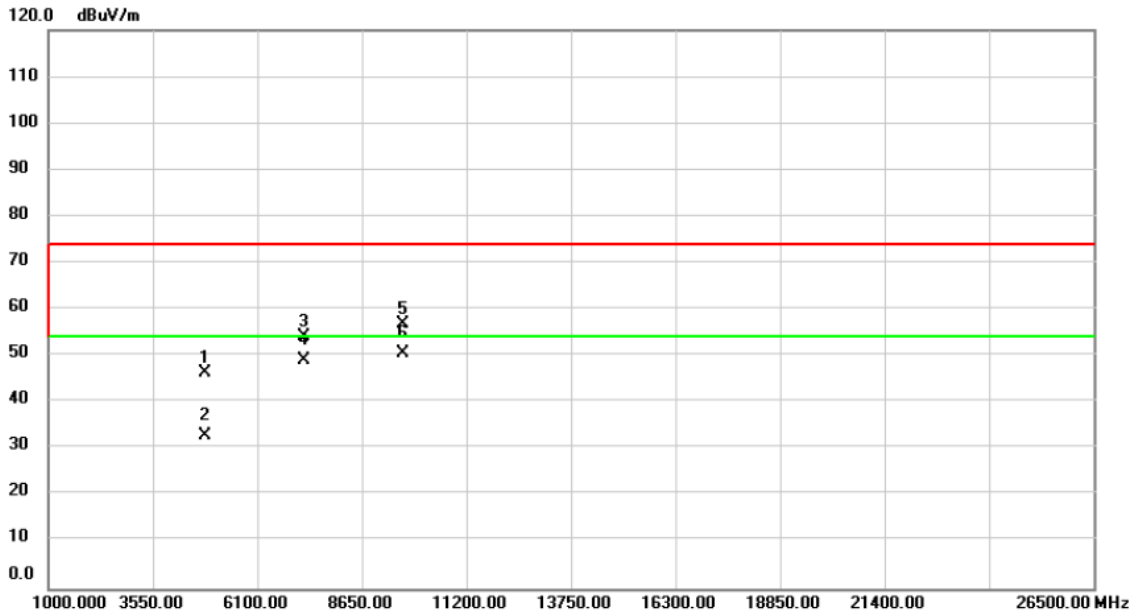

No. Mk.	Freq. MHz	Reading Level dBuV	Correct Factor dB	Measure- ment dBuV/m	Limit dBuV/m	Over dB	Detector	Comment
1	4824.000	57.76	-11.37	46.39	74.00	-27.61	peak	
2	4824.000	44.33	-11.37	32.96	54.00	-21.04	AVG	
3	7236.000	59.58	-5.40	54.18	74.00	-19.82	peak	
4	7236.000	54.36	-5.40	48.96	54.00	-5.04	AVG	
5	9648.000	56.45	0.53	56.98	74.00	-17.02	peak	
6 *	9648.000	50.11	0.53	50.64	54.00	-3.36	AVG	

Orthogonal Axis :	X
Test Mode :	TX N-20M Mode 2412MHz _ Antenna Type: Dipole

Horizontal

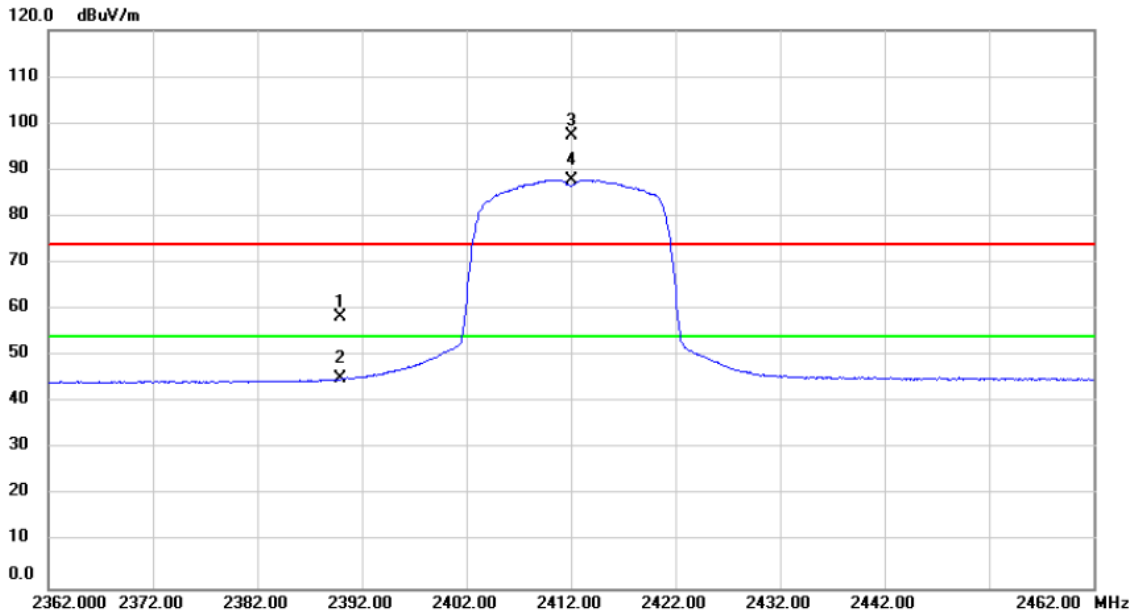

No.	Mk.	Freq. MHz	Reading Level dBuV	Correct Factor dB	Measure- ment dBuV/m	Limit dBuV/m	Over dB	Detector	Comment
1		2389.916	27.19	31.06	58.25	74.00	-15.75	peak	
2		2389.916	14.07	31.06	45.13	54.00	-8.87	AVG	
3	X	2412.000	66.25	31.14	97.39	74.00	23.39	peak	No Limit
4	*	2412.000	56.72	31.14	87.86	54.00	33.86	AVG	No Limit

Orthogonal Axis :	X
Test Mode :	TX N-20M Mode 2412MHz _ Antenna Type: Dipole

Horizontal

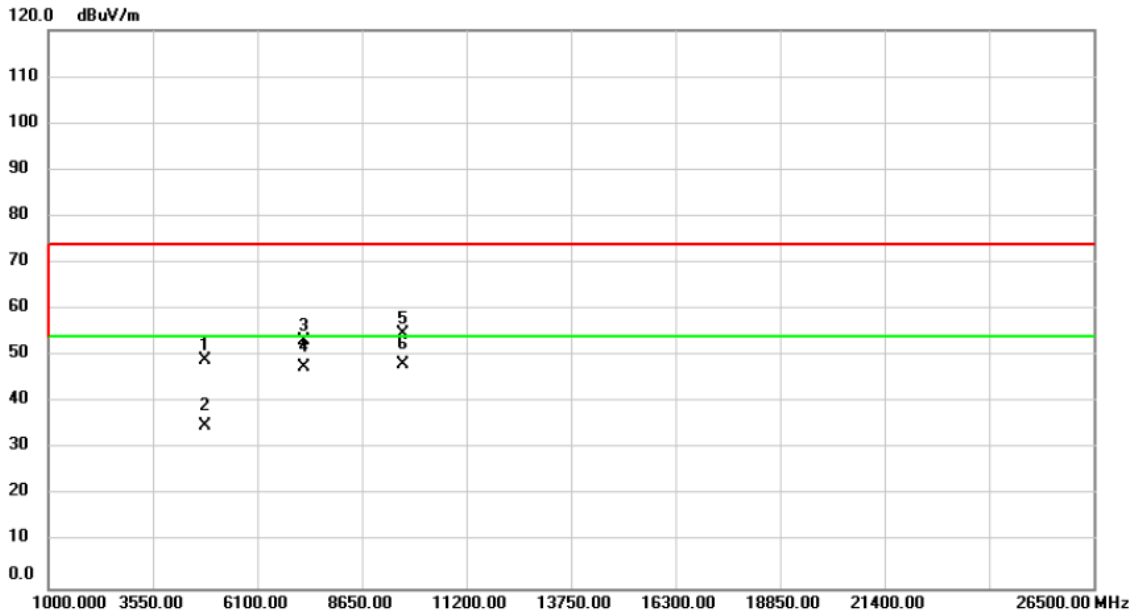

No.	Mk.	Freq.	Reading Level	Correct Factor	Measurement	Limit	Over	Detector	Comment
		MHz	dBuV	dB	dBuV/m	dBuV/m	dB		
1		4824.000	60.55	-11.37	49.18	74.00	-24.82	peak	
2		4824.000	46.34	-11.37	34.97	54.00	-19.03	AVG	
3		7236.000	58.63	-5.40	53.23	74.00	-20.77	peak	
4		7236.000	52.88	-5.40	47.48	54.00	-6.52	AVG	
5		9648.000	54.33	0.53	54.86	74.00	-19.14	peak	
6	*	9648.000	47.58	0.53	48.11	54.00	-5.89	AVG	

Orthogonal Axis :	X
Test Mode :	TX N-20M Mode 2437MHz _ Antenna Type: Dipole

Vertical

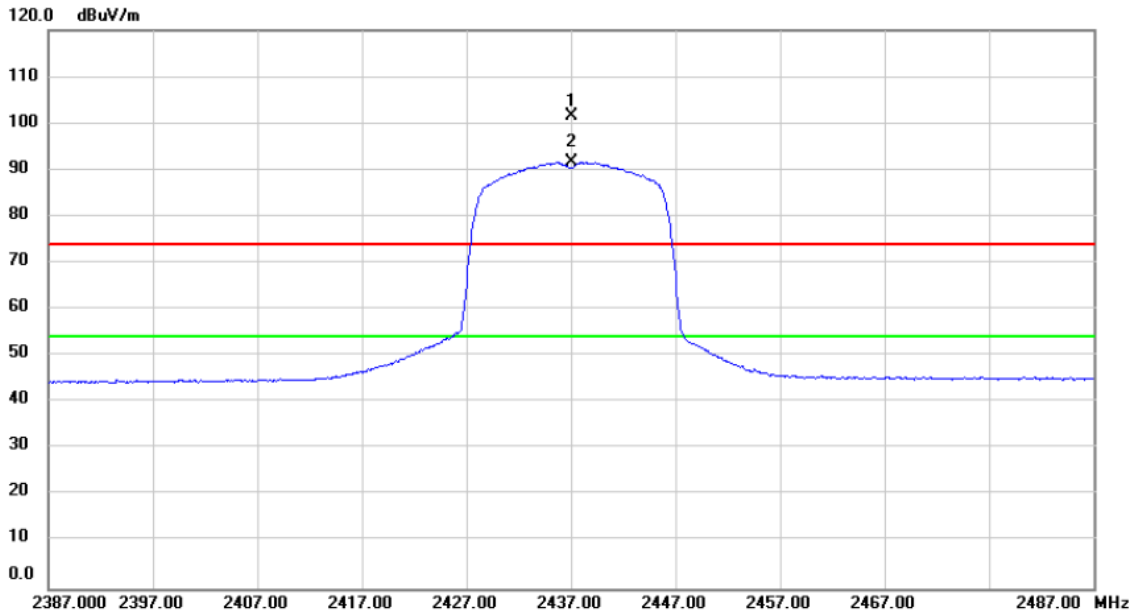

No.	Mk.	Freq.	Reading Level	Correct Factor	Measurement	Limit	Over	Detector	Comment
		MHz	dBuV	dB	dBuV/m	dBuV/m	dB		
1	X	2437.000	70.29	31.23	101.52	74.00	27.52	peak	No Limit
2	*	2437.000	60.40	31.23	91.63	54.00	37.63	AVG	No Limit

Orthogonal Axis :	X
Test Mode :	TX N-20M Mode 2437MHz _ Antenna Type: Dipole

Vertical

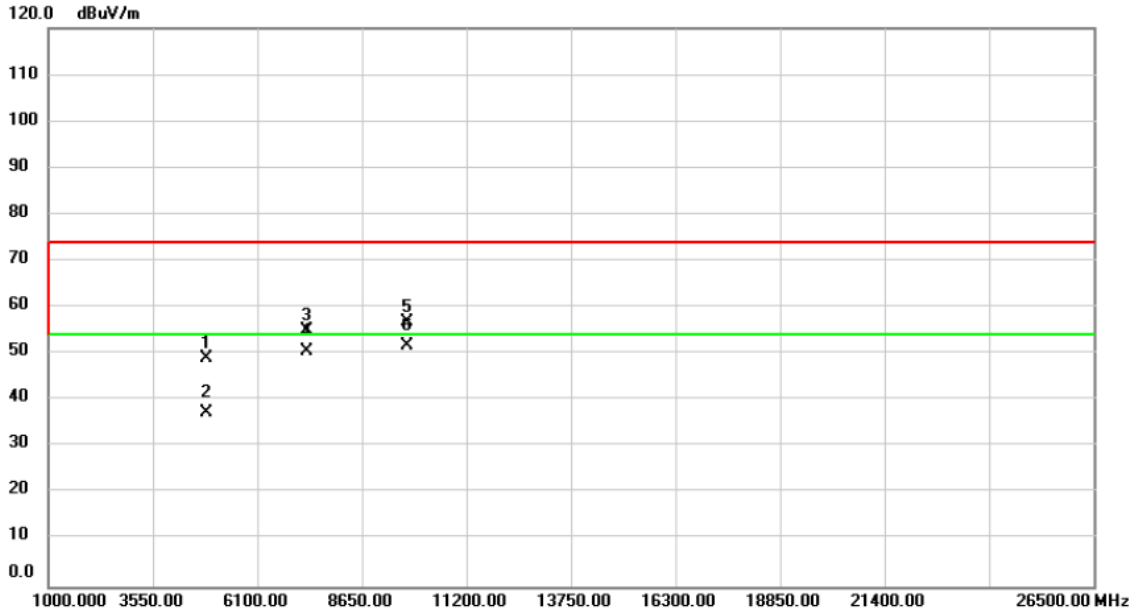

No.	Mk.	Freq.	Reading Level	Correct Factor	Measurement	Limit	Over	Detector	Comment
		MHz	dBuV	dB	dBuV/m	dBuV/m	dB		
1		4874.000	60.31	-11.29	49.02	74.00	-24.98	peak	
2		4874.000	48.76	-11.29	37.47	54.00	-16.53	AVG	
3		7311.000	60.25	-5.13	55.12	74.00	-18.88	peak	
4		7311.000	55.63	-5.13	50.50	54.00	-3.50	AVG	
5		9748.000	55.91	0.90	56.81	74.00	-17.19	peak	
6	*	9748.000	50.73	0.90	51.63	54.00	-2.37	AVG	

Orthogonal Axis :	X
Test Mode :	TX N-20M Mode 2437MHz _ Antenna Type: Dipole

Horizontal

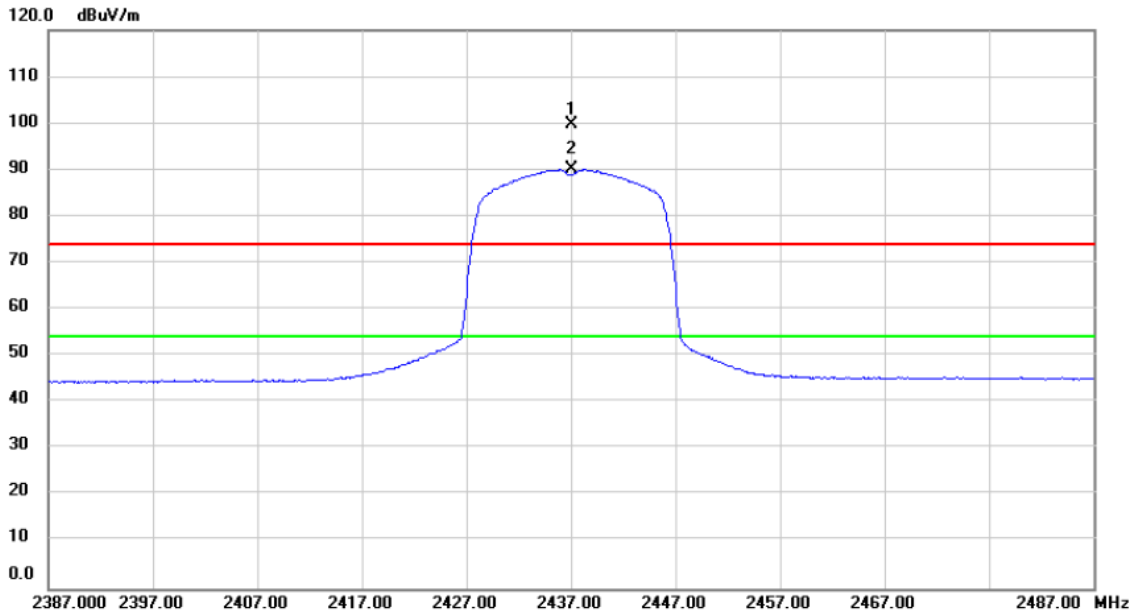

No.	Mk.	Freq.	Reading Level	Correct Factor	Measurement	Limit	Over	Detector	Comment
		MHz	dBuV	dB	dBuV/m	dBuV/m	dB		
1	X	2437.000	68.44	31.23	99.67	74.00	25.67	peak	No Limit
2	*	2437.000	58.83	31.23	90.06	54.00	36.06	AVG	No Limit

Orthogonal Axis :	X
Test Mode :	TX N-20M Mode 2437MHz _ Antenna Type: Dipole

Horizontal

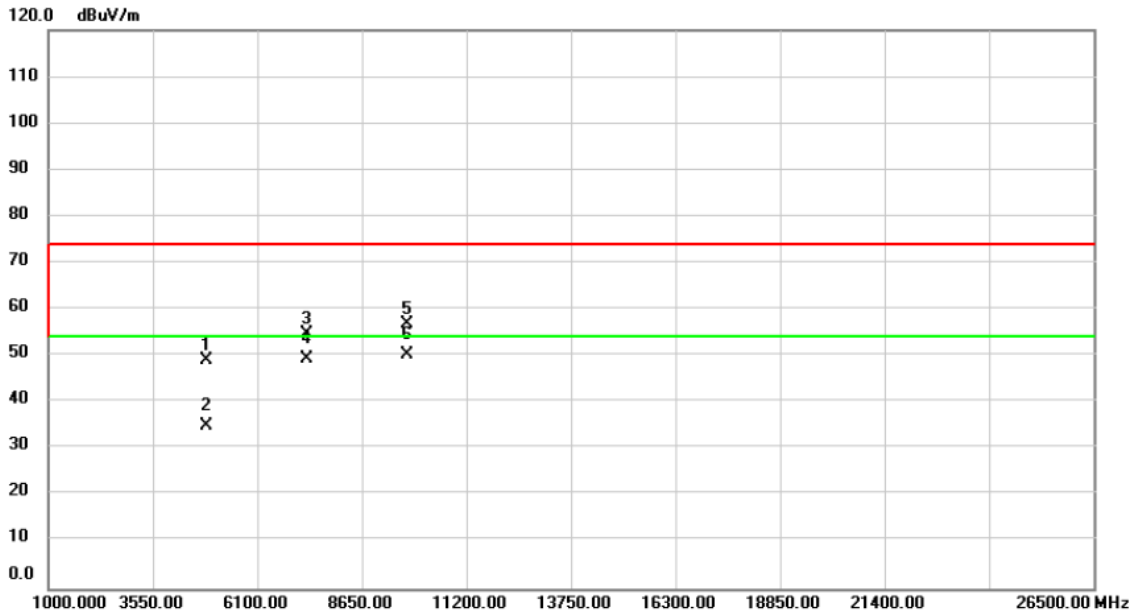

No.	Mk.	Freq.	Reading Level	Correct Factor	Measurement	Limit	Over	Detector	Comment
		MHz	dBuV	dB	dBuV/m	dBuV/m	dB		
1		4874.000	60.20	-11.29	48.91	74.00	-25.09	peak	
2		4874.000	46.14	-11.29	34.85	54.00	-19.15	AVG	
3		7311.000	59.84	-5.13	54.71	74.00	-19.29	peak	
4		7311.000	54.45	-5.13	49.32	54.00	-4.68	AVG	
5		9748.000	56.05	0.90	56.95	74.00	-17.05	peak	
6	*	9748.000	49.24	0.90	50.14	54.00	-3.86	AVG	

Orthogonal Axis :	X
Test Mode :	TX N-20M Mode 2462MHz _ Antenna Type: Dipole

Vertical

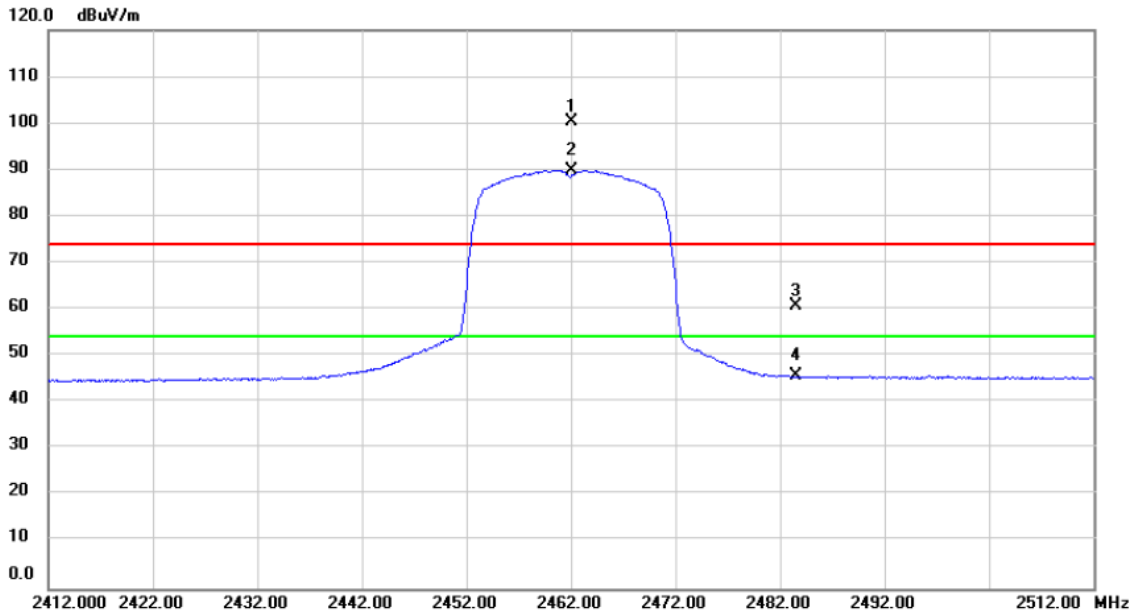

No.	Mk.	Freq. MHz	Reading Level dBuV	Correct Factor dB	Measure- ment dBuV/m	Limit dBuV/m	Over dB	Detector	Comment
1	X	2462.000	68.96	31.33	100.29	74.00	26.29	peak	No Limit
2	*	2462.000	58.52	31.33	89.85	54.00	35.85	AVG	No Limit
3		2483.528	29.46	31.41	60.87	74.00	-13.13	peak	
4		2483.528	14.36	31.41	45.77	54.00	-8.23	AVG	

Orthogonal Axis :	X
Test Mode :	TX N-20M Mode 2462MHz _ Antenna Type: Dipole

Vertical

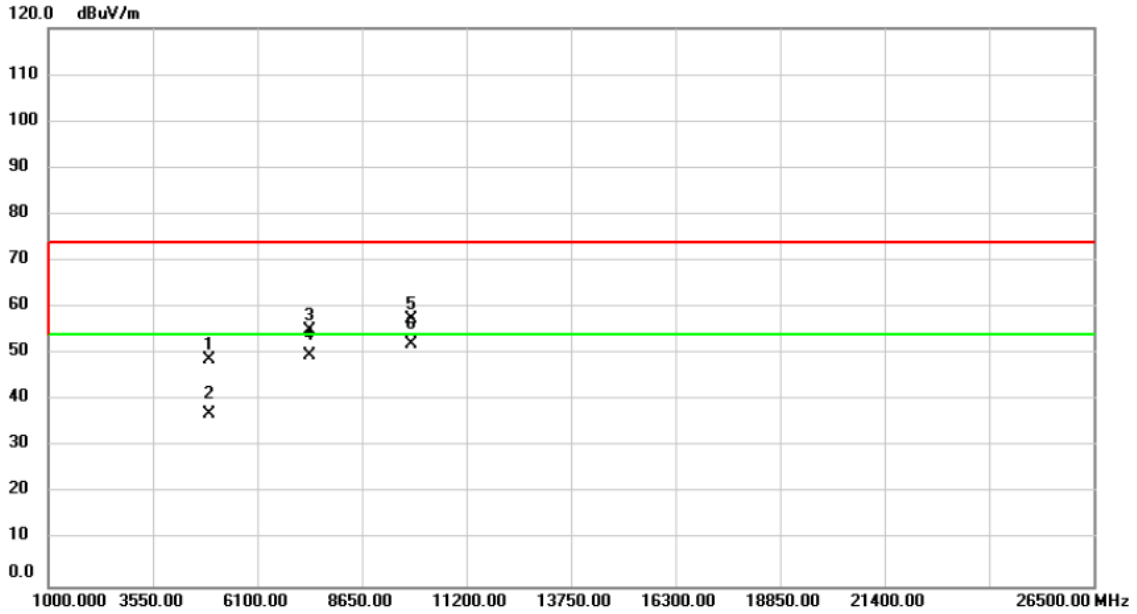

No.	Mk.	Freq.	Reading Level	Correct Factor	Measurement	Limit	Over	Detector	Comment
		MHz	dBuV	dB	dBuV/m	dBuV/m	dB		
1		4924.000	60.11	-11.22	48.89	74.00	-25.11	peak	
2		4924.000	48.37	-11.22	37.15	54.00	-16.85	AVG	
3		7386.000	59.87	-4.87	55.00	74.00	-19.00	peak	
4		7386.000	54.59	-4.87	49.72	54.00	-4.28	AVG	
5		9848.000	56.33	1.27	57.60	74.00	-16.40	peak	
6	*	9848.000	50.68	1.27	51.95	54.00	-2.05	AVG	

Orthogonal Axis :	X
Test Mode :	TX N-20M Mode 2462MHz _ Antenna Type: Dipole

Horizontal

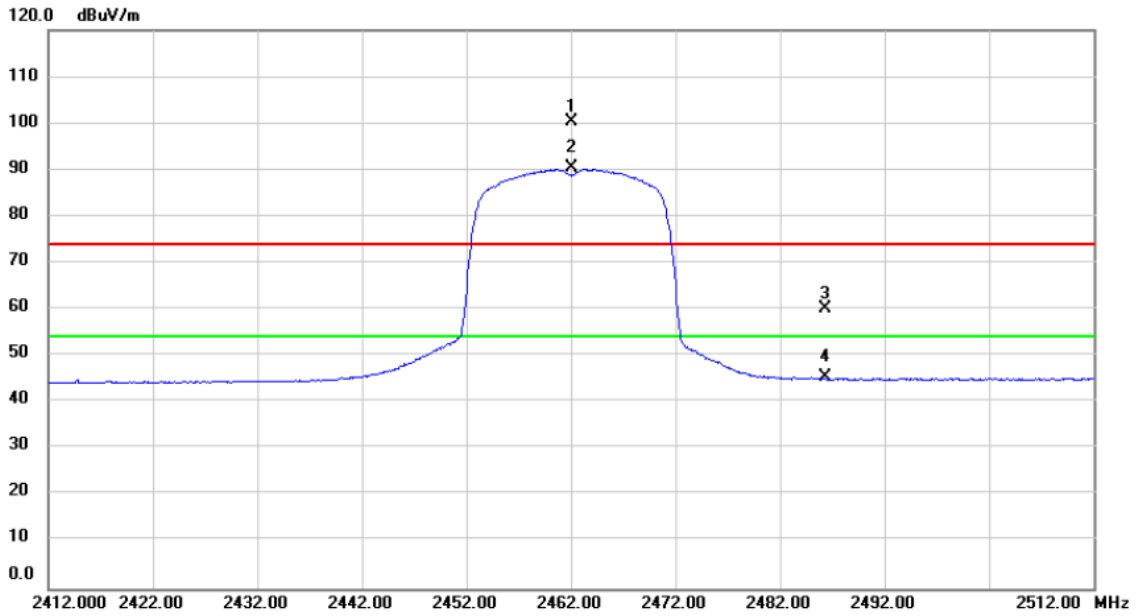

No.	Mk.	Freq.	Reading Level	Correct Factor	Measurement	Limit	Over	Detector	Comment
		MHz	dBuV	dB	dBuV/m	dBuV/m	dB		
1	X	2462.000	69.10	31.33	100.43	74.00	26.43	peak	No Limit
2	*	2462.000	59.11	31.33	90.44	54.00	36.44	AVG	No Limit
3		2486.350	28.62	31.42	60.04	74.00	-13.96	peak	
4		2486.350	14.11	31.42	45.53	54.00	-8.47	AVG	

Orthogonal Axis :	X
Test Mode :	TX N-20M Mode 2462MHz _ Antenna Type: Dipole

Horizontal

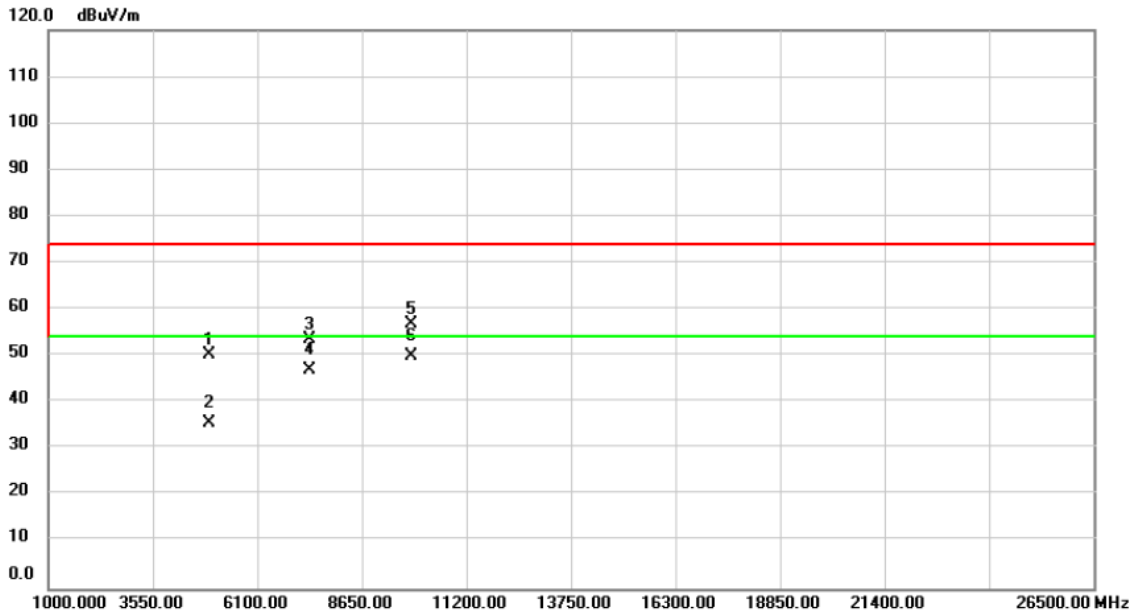

No.	Mk.	Freq. MHz	Reading Level dBuV	Correct Factor dB	Measure- ment dBuV/m	Limit dBuV/m	Over dB	Detector	Comment
1		4924.000	61.46	-11.22	50.24	74.00	-23.76	peak	
2		4924.000	46.63	-11.22	35.41	54.00	-18.59	AVG	
3		7386.000	58.56	-4.87	53.69	74.00	-20.31	peak	
4		7386.000	51.76	-4.87	46.89	54.00	-7.11	AVG	
5		9848.000	55.44	1.27	56.71	74.00	-17.29	peak	
6	*	9848.000	48.72	1.27	49.99	54.00	-4.01	AVG	

Orthogonal Axis :	X
Test Mode :	TX B Mode 2412MHz _ Antenna Type: PCB

Vertical

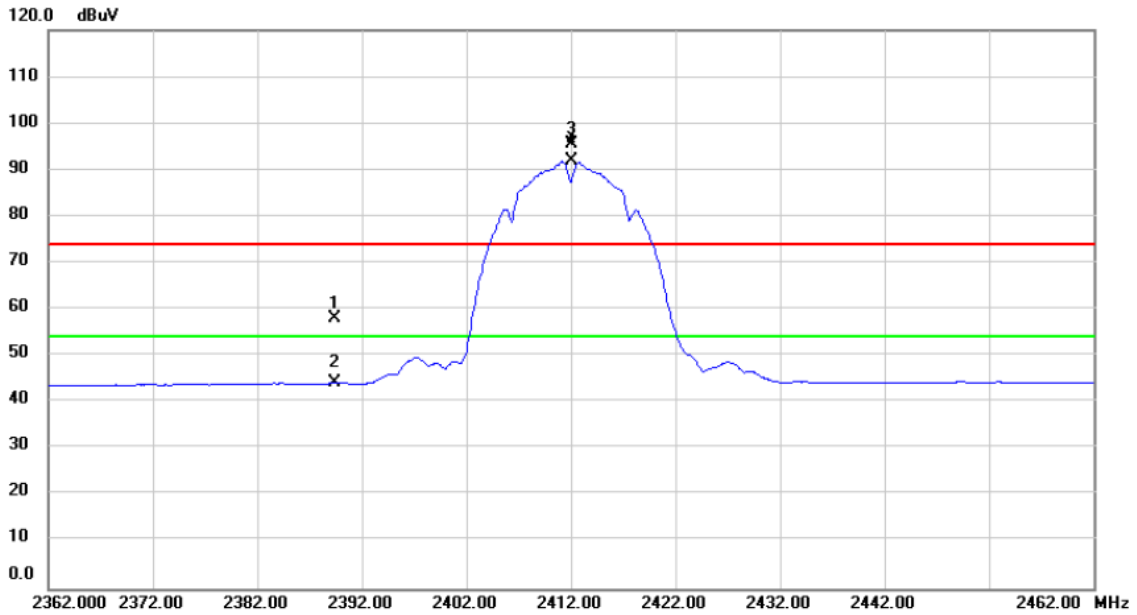

No.	Mk.	Freq. MHz	Reading Level dBuV	Correct Factor dB	Measure- ment dBuV	Limit dBuV	Over dB	Detector	Comment
1		2389.440	27.00	31.06	58.06	74.00	-15.94	peak	
2		2389.440	13.16	31.06	44.22	54.00	-9.78	AVG	
3	X	2412.000	64.26	31.14	95.40	74.00	21.40	peak	No Limit
4	*	2412.000	60.68	31.14	91.82	54.00	37.82	AVG	No Limit

Orthogonal Axis :	X
Test Mode :	TX B Mode 2412MHz _ Antenna Type: PCB

Vertical

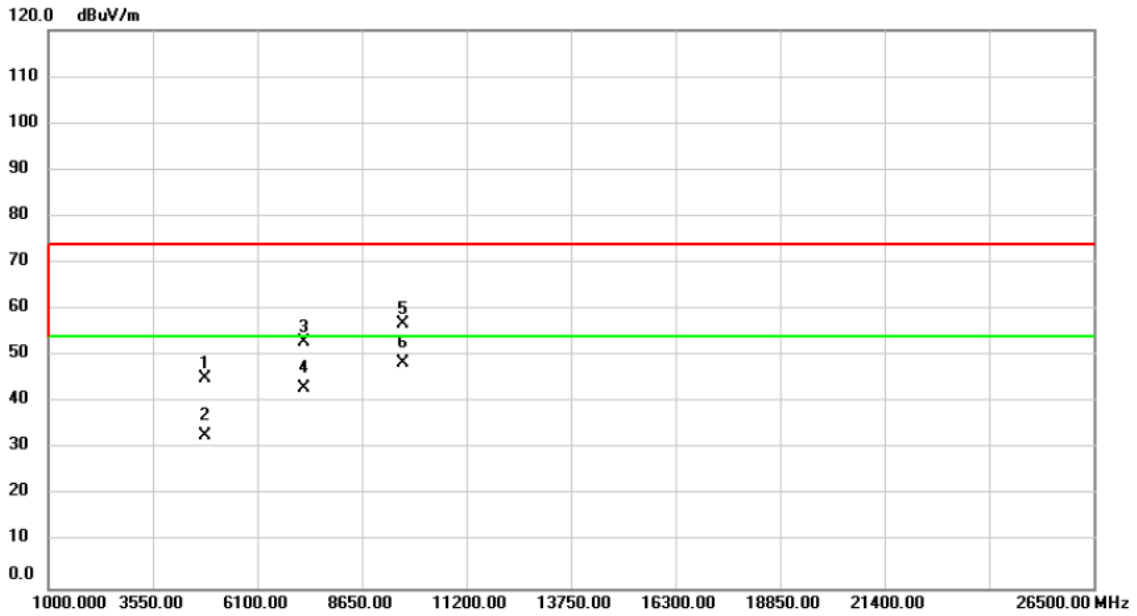

No. Mk.	Freq. MHz	Reading Level dBuV	Correct Factor dB	Measure- ment dBuV/m	Limit dBuV/m	Over dB	Detector	Comment
1	4824.000	56.56	-11.37	45.19	74.00	-28.81	peak	
2	4824.000	44.11	-11.37	32.74	54.00	-21.26	AVG	
3	7236.000	58.36	-5.40	52.96	74.00	-21.04	peak	
4	7236.000	48.32	-5.40	42.92	54.00	-11.08	AVG	
5	9648.000	56.38	0.53	56.91	74.00	-17.09	peak	
6 *	9648.000	48.00	0.53	48.53	54.00	-5.47	AVG	

Orthogonal Axis :	X
Test Mode :	TX B Mode 2412MHz _ Antenna Type: PCB

Horizontal

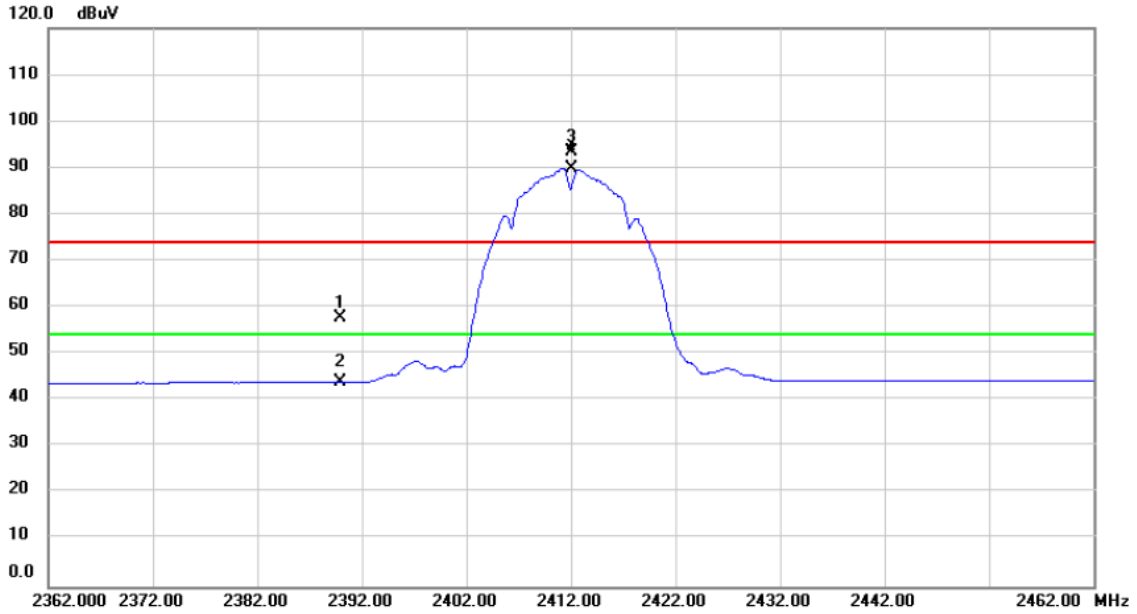

No.	Mk.	Freq.	Reading Level	Correct Factor	Measurement	Limit	Over	Detector	Comment
		MHz	dBuV	dB	dBuV	dBuV	dB		
1		2389.888	26.80	31.06	57.86	74.00	-16.14	peak	
2		2389.888	13.03	31.06	44.09	54.00	-9.91	AVG	
3	X	2412.000	62.41	31.14	93.55	74.00	19.55	peak	No Limit
4	*	2412.000	58.82	31.14	89.96	54.00	35.96	AVG	No Limit

Orthogonal Axis :	X
Test Mode :	TX B Mode 2412MHz _ Antenna Type: PCB

Horizontal

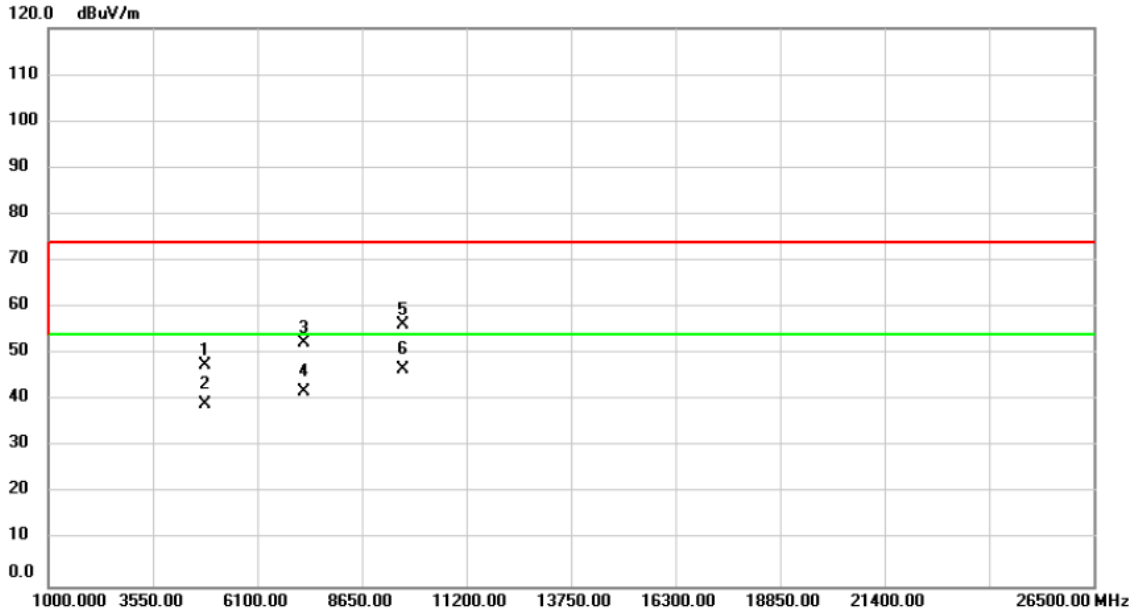

No.	Mk.	Freq.	Reading Level	Correct Factor	Measurement	Limit	Over	Detector	Comment
		MHz	dBuV	dB	dBuV/m	dBuV/m	dB		
1	X	4824.000	58.81	-11.37	47.44	74.00	-26.56	peak	
2	X	4824.000	50.42	-11.37	39.05	54.00	-14.95	AVG	
3	X	7236.000	57.74	-5.40	52.34	74.00	-21.66	peak	
4	X	7236.000	47.35	-5.40	41.95	54.00	-12.05	AVG	
5	X	9648.000	55.59	0.53	56.12	74.00	-17.88	peak	
6	X	9648.000	46.01	0.53	46.54	54.00	-7.46	AVG	

Orthogonal Axis :	X
Test Mode :	TX B Mode 2437MHz _ Antenna Type: PCB

Vertical

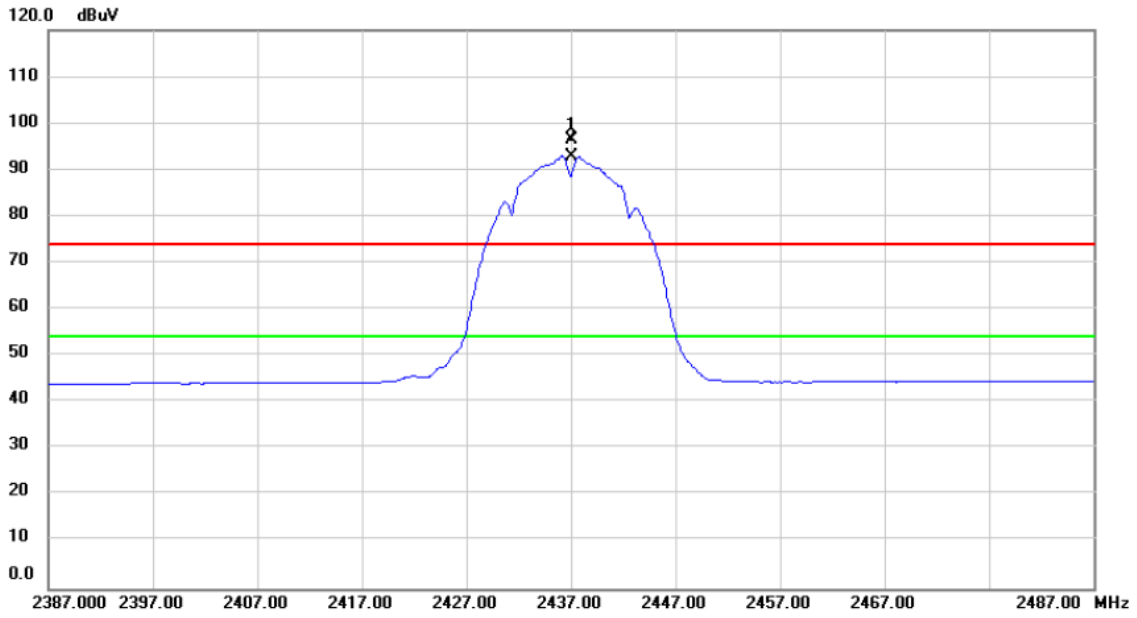

No.	Mk.	Freq.	Reading Level	Correct Factor	Measurement	Limit	Over	Detector	Comment
		MHz	dBuV	dB	dBuV	dBuV	dB		
1	X	2437.000	65.33	31.23	96.56	74.00	22.56	peak	No Limit
2	*	2437.000	61.77	31.23	93.00	54.00	39.00	AVG	No Limit

Orthogonal Axis :	X
Test Mode :	TX B Mode 2437MHz _ Antenna Type: PCB

Vertical

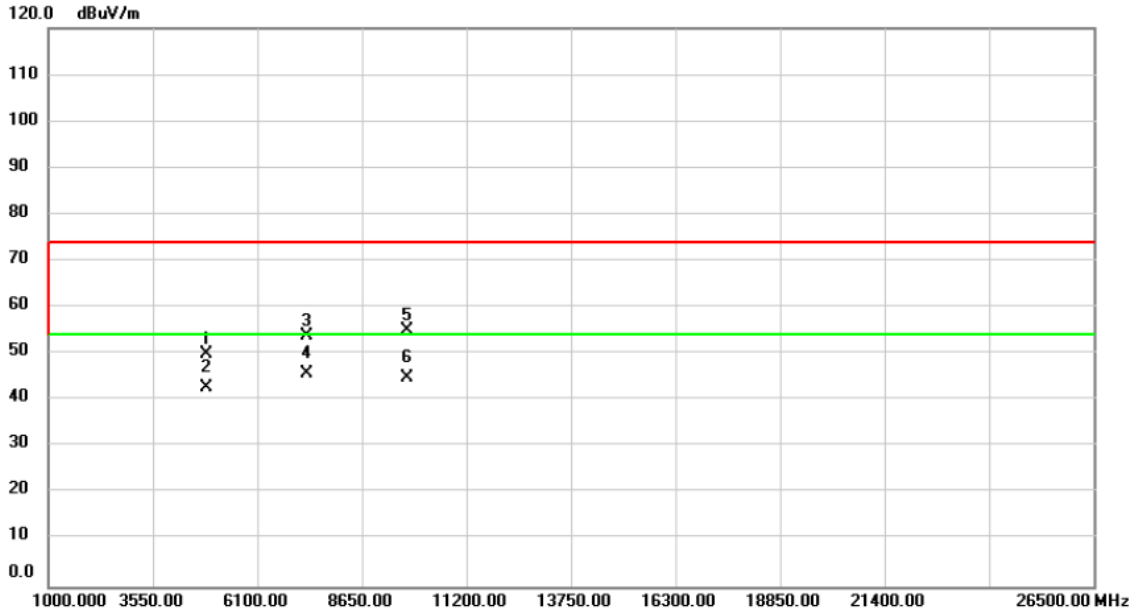

No. Mk.	Freq. MHz	Reading Level dBuV	Correct Factor dB	Measure- ment dBuV/m	Limit dBuV/m	Over dB	Detector	Comment
1	4874.000	61.15	-11.29	49.86	74.00	-24.14	peak	
2	4874.000	54.03	-11.29	42.74	54.00	-11.26	AVG	
3	7311.000	59.10	-5.13	53.97	74.00	-20.03	peak	
4 *	7311.000	50.96	-5.13	45.83	54.00	-8.17	AVG	
5	9748.000	54.01	0.90	54.91	74.00	-19.09	peak	
6	9748.000	44.03	0.90	44.93	54.00	-9.07	AVG	

Orthogonal Axis :	X
Test Mode :	TX B Mode 2437MHz _ Antenna Type: PCB

Horizontal

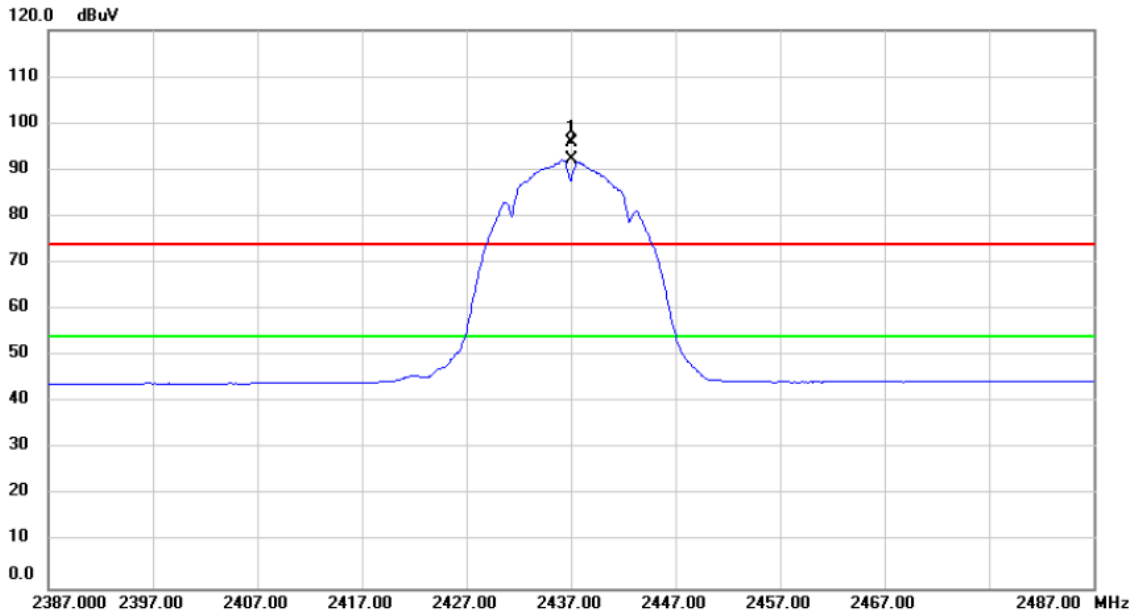

No.	Mk.	Freq.	Reading Level	Correct Factor	Measurement	Limit	Over	Detector	Comment
		MHz	dBuV	dB	dBuV	dBuV	dB		
1	X	2437.000	64.67	31.23	95.90	74.00	21.90	peak	No Limit
2	*	2437.000	60.99	31.23	92.22	54.00	38.22	AVG	No Limit

Orthogonal Axis :	X
Test Mode :	TX B Mode 2437MHz _ Antenna Type: PCB

Horizontal

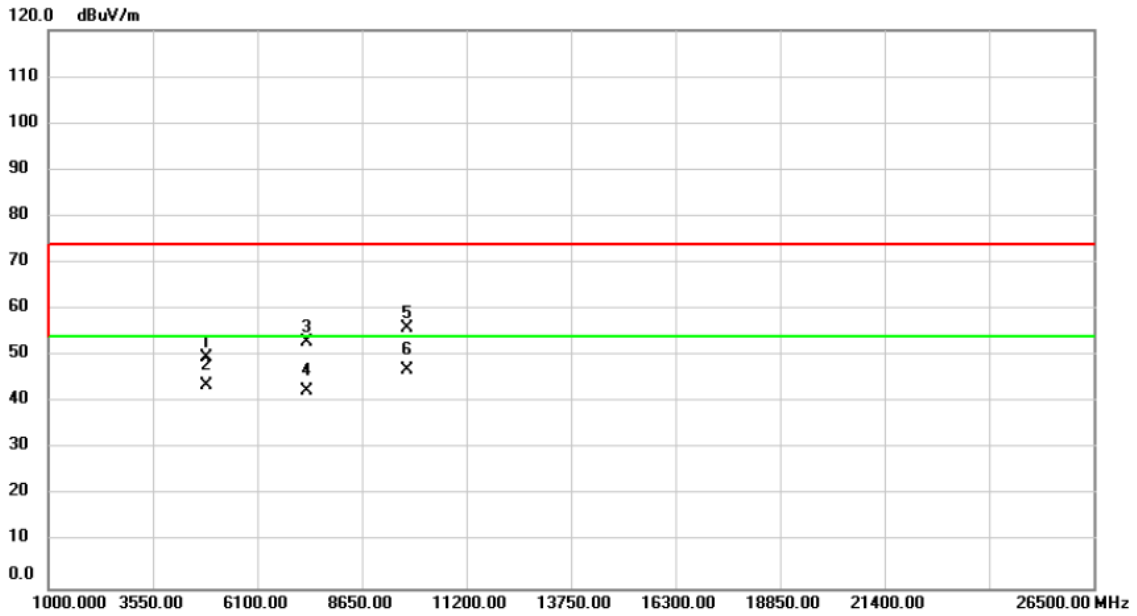

No.	Mk.	Freq.	Reading Level	Correct Factor	Measurement	Limit	Over	Detector	Comment
		MHz	dBuV	dB	dBuV/m	dBuV/m	dB		
1		4874.000	60.83	-11.29	49.54	74.00	-24.46	peak	
2		4874.000	54.93	-11.29	43.64	54.00	-10.36	AVG	
3		7311.000	57.97	-5.13	52.84	74.00	-21.16	peak	
4		7311.000	47.67	-5.13	42.54	54.00	-11.46	AVG	
5		9748.000	55.02	0.90	55.92	74.00	-18.08	peak	
6	*	9748.000	46.10	0.90	47.00	54.00	-7.00	AVG	

Orthogonal Axis :	X
Test Mode :	TX B Mode 2462MHz _ Antenna Type: PCB

Vertical

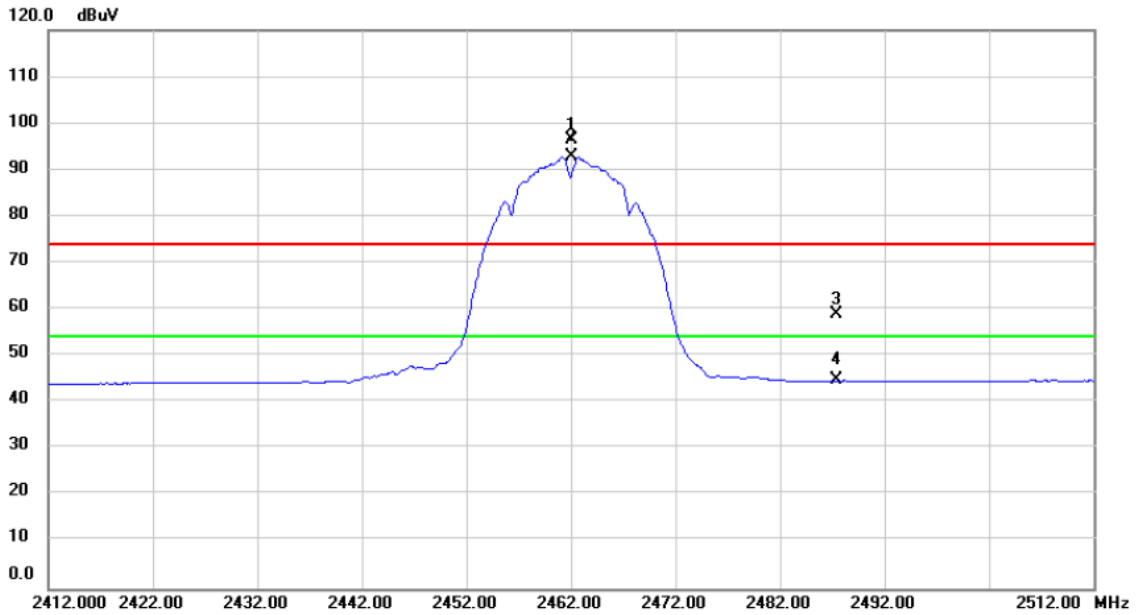

No.	Mk.	Freq.	Reading Level	Correct Factor	Measurement	Limit	Over	Detector	Comment
		MHz	dBuV	dB	dBuV	dBuV	dB		
1	X	2462.000	65.24	31.33	96.57	74.00	22.57	peak	No Limit
2	*	2462.000	61.40	31.33	92.73	54.00	38.73	AVG	No Limit
3		2487.378	27.67	31.42	59.09	74.00	-14.91	peak	
4		2487.378	13.30	31.42	44.72	54.00	-9.28	AVG	

Orthogonal Axis :	X
Test Mode :	TX B Mode 2462MHz _ Antenna Type: PCB

Vertical

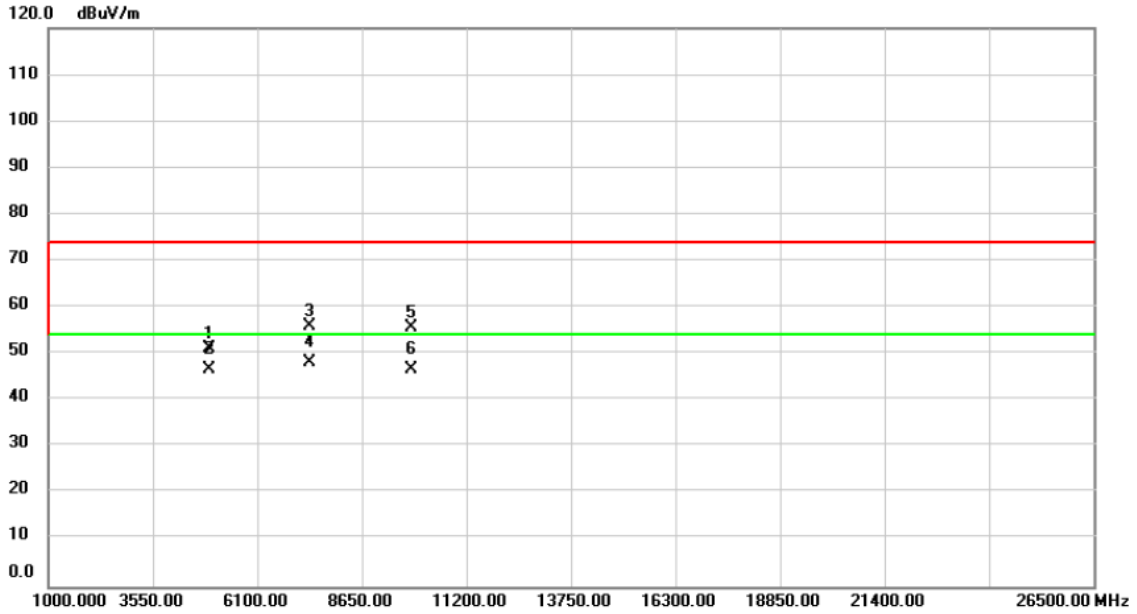

No. Mk.	Freq. MHz	Reading Level dBuV	Correct Factor dB	Measurement dBuV/m	Limit dBuV/m	Over dB	Detector	Comment
1	4924.000	62.52	-11.22	51.30	74.00	-22.70	peak	
2	4924.000	57.74	-11.22	46.52	54.00	-7.48	AVG	
3	7386.000	60.96	-4.87	56.09	74.00	-17.91	peak	
4 *	7386.000	53.17	-4.87	48.30	54.00	-5.70	AVG	
5	9848.000	54.37	1.27	55.64	74.00	-18.36	peak	
6	9848.000	45.24	1.27	46.51	54.00	-7.49	AVG	

Orthogonal Axis :	X
Test Mode :	TX B Mode 2462MHz _ Antenna Type: PCB

Horizontal

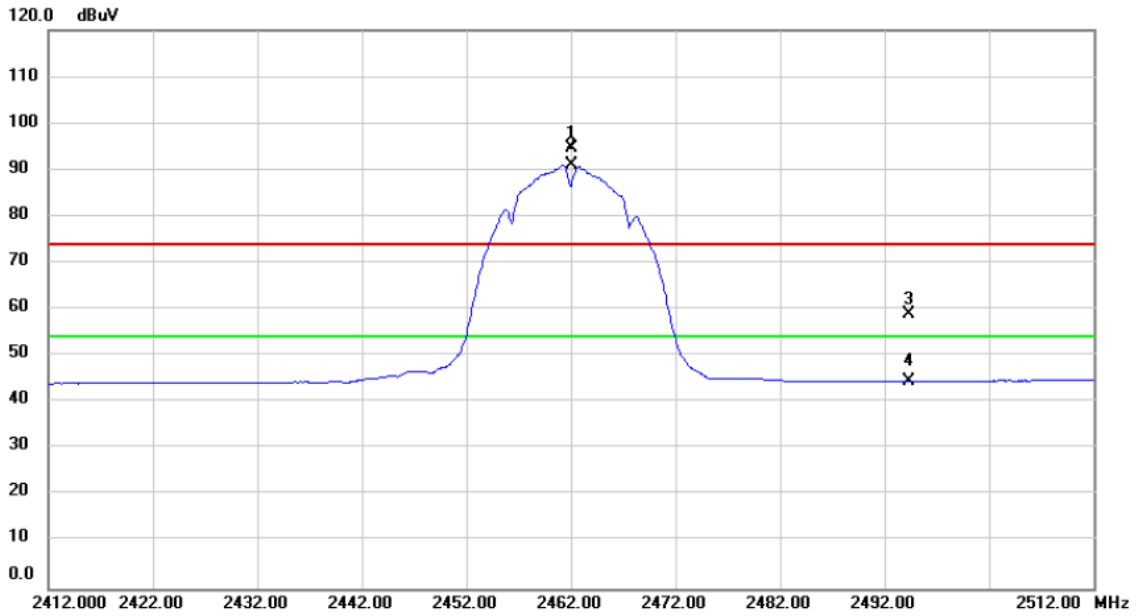

No.	Mk.	Freq.	Reading Level	Correct Factor	Measurement	Limit	Over	Detector	Comment
		MHz	dBuV	dB	dBuV	dBuV	dB		
1	X	2462.000	63.26	31.33	94.59	74.00	20.59	peak	No Limit
2	*	2462.000	59.69	31.33	91.02	54.00	37.02	AVG	No Limit
3		2494.330	27.55	31.45	59.00	74.00	-15.00	peak	
4		2494.330	13.23	31.45	44.68	54.00	-9.32	AVG	

Orthogonal Axis :	X
Test Mode :	TX B Mode 2462MHz _ Antenna Type: PCB

Horizontal

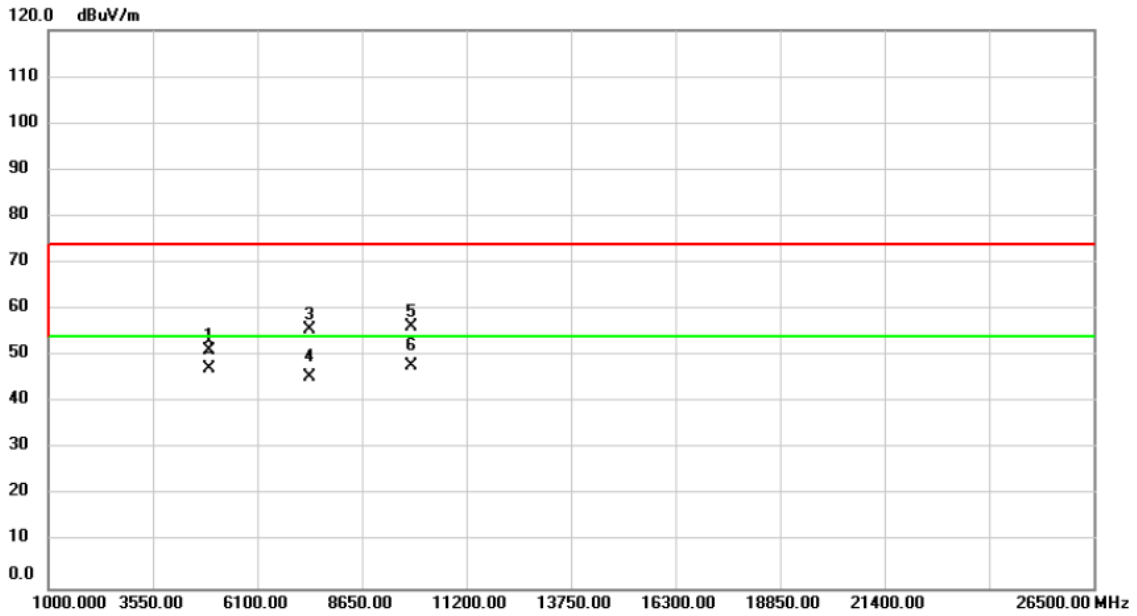

No.	Mk.	Freq.	Reading Level	Correct Factor	Measurement	Limit	Over	Detector	Comment
		MHz	dBuV	dB	dBuV/m	dBuV/m	dB		
1		4924.000	62.36	-11.22	51.14	74.00	-22.86	peak	
2		4924.000	58.59	-11.22	47.37	54.00	-6.63	AVG	
3		7384.000	60.65	-4.88	55.77	74.00	-18.23	peak	
4		7384.000	50.23	-4.88	45.35	54.00	-8.65	AVG	
5		9848.000	55.09	1.27	56.36	74.00	-17.64	peak	
6	*	9848.000	46.60	1.27	47.87	54.00	-6.13	AVG	

Orthogonal Axis :	X
Test Mode :	TX G Mode 2412MHz _ Antenna Type: PCB

Vertical

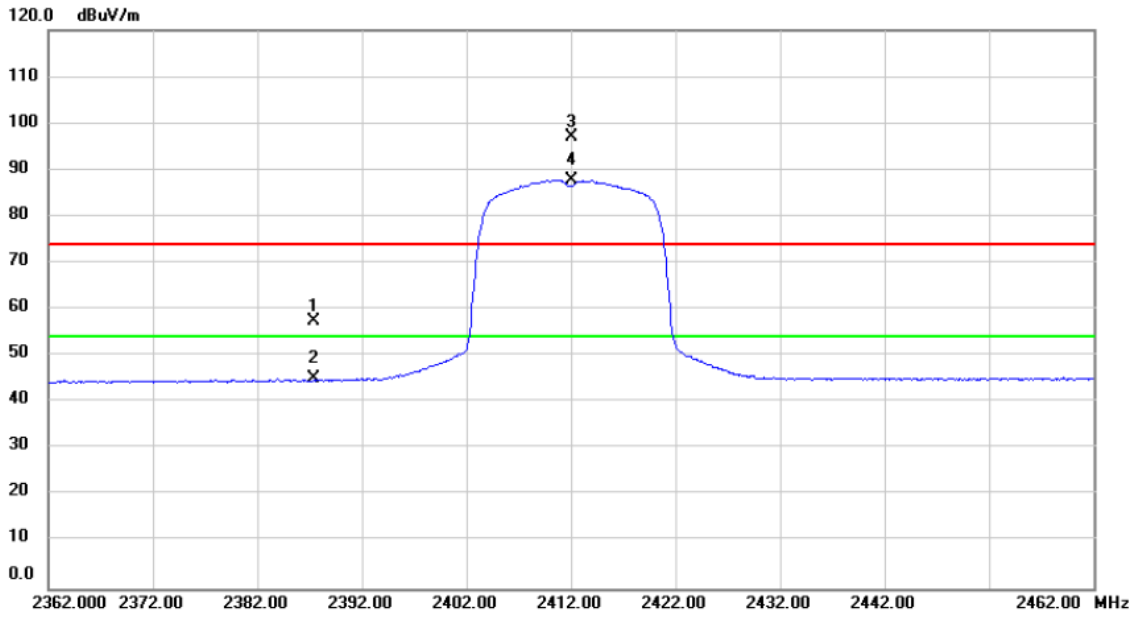

No.	Mk.	Freq.	Reading Level	Correct Factor	Measurement	Limit	Over	Detector	Comment
		MHz	dBuV	dB	dBuV/m	dBuV/m	dB		
1		2387.368	26.45	31.05	57.50	74.00	-16.50	peak	
2		2387.368	13.98	31.05	45.03	54.00	-8.97	AVG	
3	X	2412.000	65.91	31.14	97.05	74.00	23.05	peak	No Limit
4	*	2412.000	56.72	31.14	87.86	54.00	33.86	AVG	No Limit

Orthogonal Axis :	X
Test Mode :	TX G Mode 2412MHz _ Antenna Type: PCB

Vertical

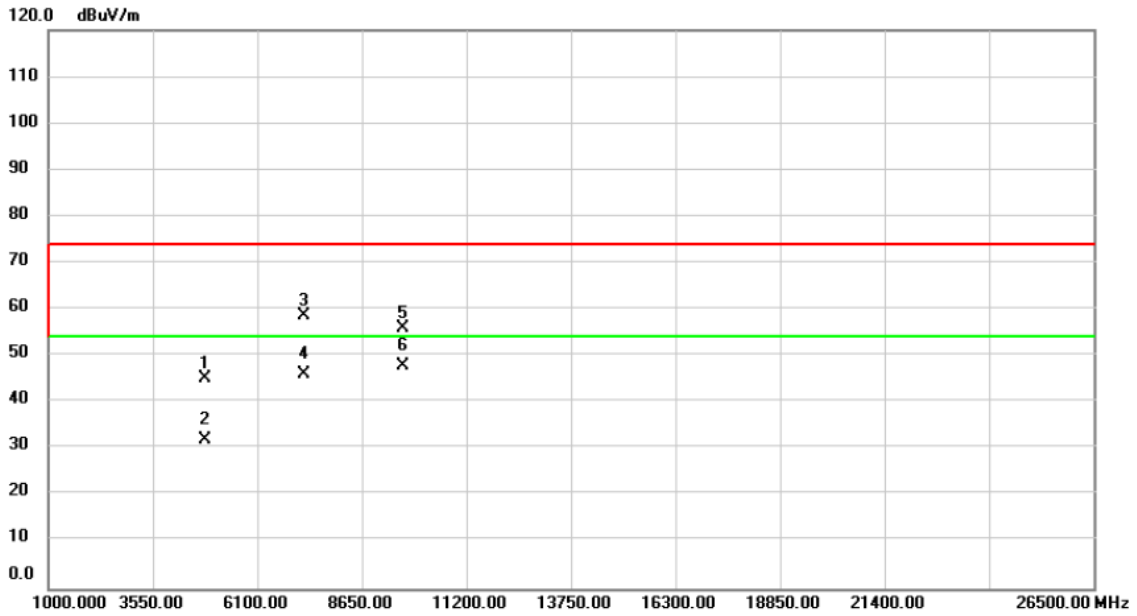

No. Mk.	Freq. MHz	Reading Level dBuV	Correct Factor dB	Measure- ment dBuV/m	Limit dBuV/m	Over dB	Detector	Comment
1	4824.000	56.43	-11.37	45.06	74.00	-28.94	peak	
2	4824.000	43.40	-11.37	32.03	54.00	-21.97	AVG	
3	7236.000	64.15	-5.40	58.75	74.00	-15.25	peak	
4	7236.000	51.42	-5.40	46.02	54.00	-7.98	AVG	
5	9648.000	55.30	0.53	55.83	74.00	-18.17	peak	
6 *	9648.000	47.44	0.53	47.97	54.00	-6.03	AVG	

Orthogonal Axis :	X
Test Mode :	TX G Mode 2412MHz _ Antenna Type: PCB

Horizontal

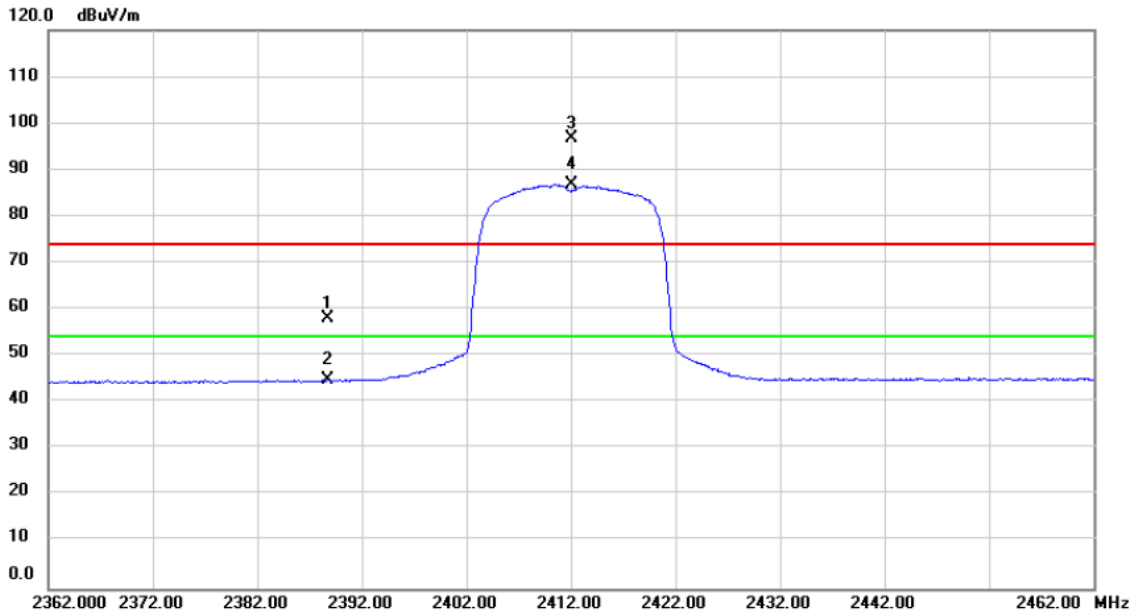

No.	Mk.	Freq.	Reading Level	Correct Factor	Measurement	Limit	Over	Detector	Comment
		MHz	dBuV	dB	dBuV/m	dBuV/m	dB		
1		2388.700	27.09	31.06	58.15	74.00	-15.85	peak	
2		2388.700	13.80	31.06	44.86	54.00	-9.14	AVG	
3	X	2412.000	65.55	31.14	96.69	74.00	22.69	peak	No Limit
4	*	2412.000	55.74	31.14	86.88	54.00	32.88	AVG	No Limit

Orthogonal Axis :	X
Test Mode :	TX G Mode 2412MHz _ Antenna Type: PCB

Horizontal

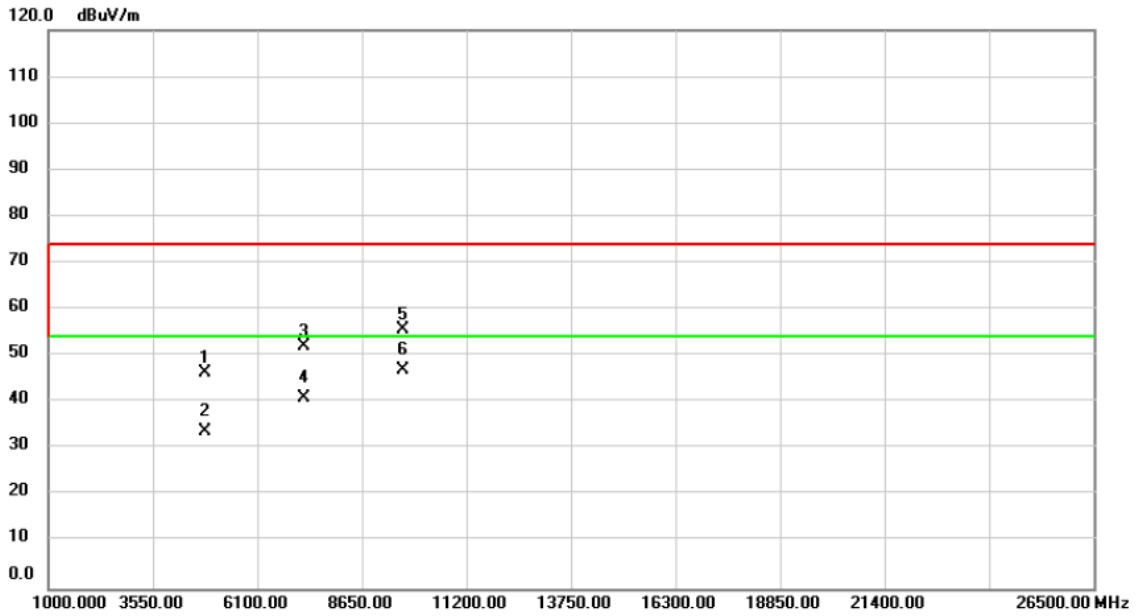

No.	Mk.	Freq. MHz	Reading Level dBuV	Correct Factor dB	Measure- ment dBuV/m	Limit dBuV/m	Over dB	Detector	Comment
1		4824.000	57.82	-11.37	46.45	74.00	-27.55	peak	
2		4824.000	45.11	-11.37	33.74	54.00	-20.26	AVG	
3		7236.000	57.34	-5.40	51.94	74.00	-22.06	peak	
4		7236.000	46.21	-5.40	40.81	54.00	-13.19	AVG	
5		9648.000	55.06	0.53	55.59	74.00	-18.41	peak	
6	*	9648.000	46.32	0.53	46.85	54.00	-7.15	AVG	

Orthogonal Axis :	X
Test Mode :	TX G Mode 2437MHz _ Antenna Type: PCB

Vertical

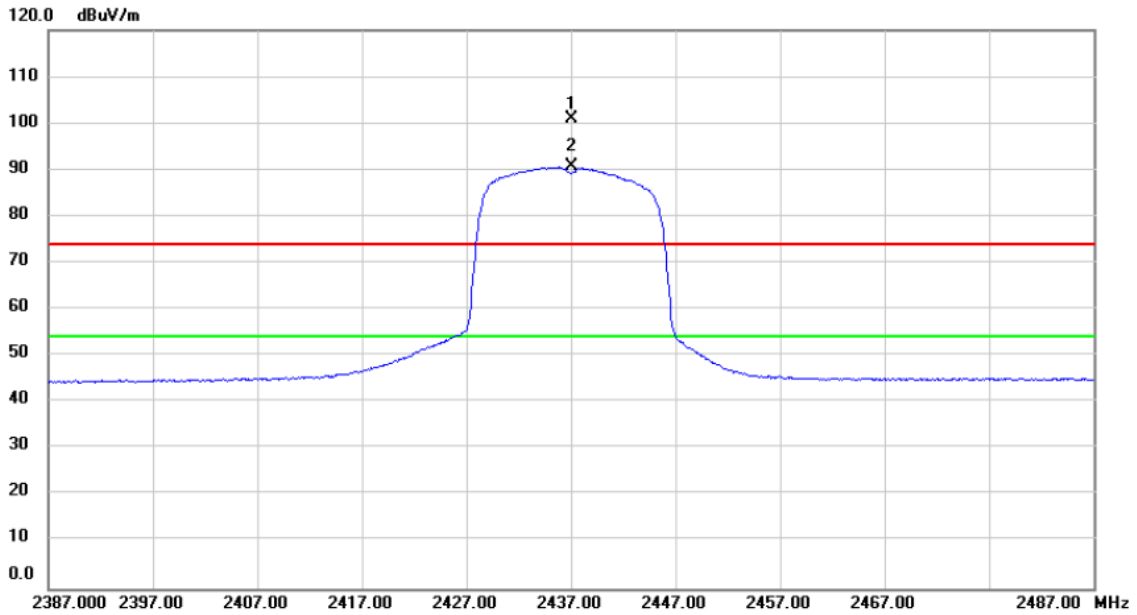

No.	Mk.	Freq.	Reading Level	Correct Factor	Measurement	Limit	Over	Detector	Comment
		MHz	dBuV	dB	dBuV/m	dBuV/m	dB		
1	X	2437.000	69.58	31.23	100.81	74.00	26.81	peak	No Limit
2	*	2437.000	59.45	31.23	90.68	54.00	36.68	AVG	No Limit

Orthogonal Axis :	X
Test Mode :	TX G Mode 2437MHz _ Antenna Type: PCB

Vertical

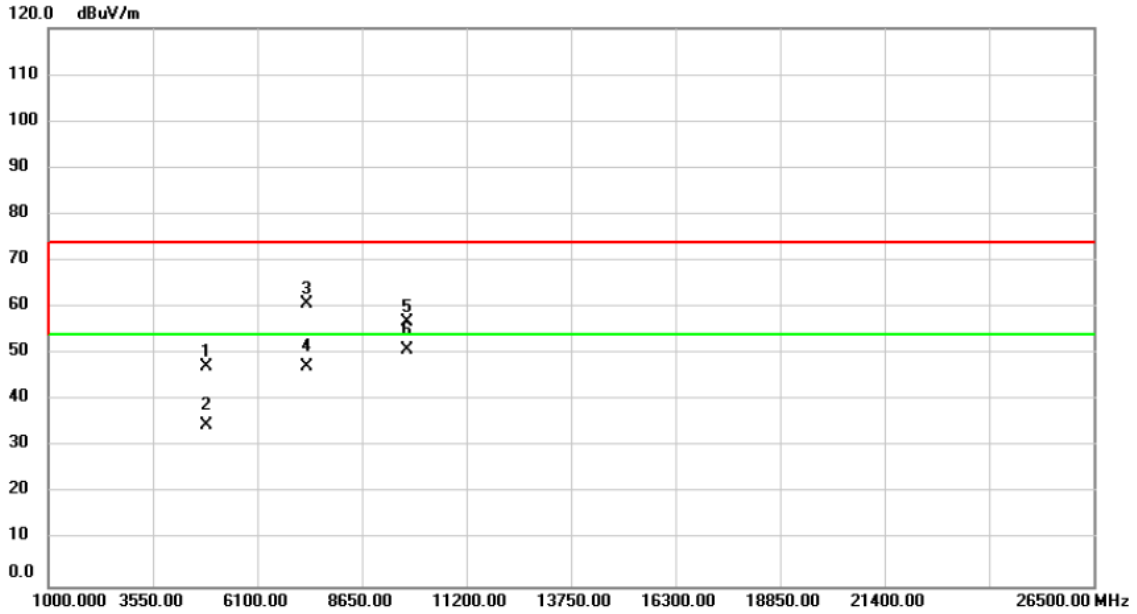

No.	Mk.	Freq.	Reading Level	Correct Factor	Measurement	Limit	Over	Detector	Comment
		MHz	dBuV	dB	dBuV/m	dBuV/m	dB		
1		4874.000	58.66	-11.29	47.37	74.00	-26.63	peak	
2		4874.000	45.80	-11.29	34.51	54.00	-19.49	AVG	
3		7311.000	65.97	-5.13	60.84	74.00	-13.16	peak	
4		7311.000	52.52	-5.13	47.39	54.00	-6.61	AVG	
5		9748.000	56.02	0.90	56.92	74.00	-17.08	peak	
6	*	9748.000	49.85	0.90	50.75	54.00	-3.25	AVG	

Orthogonal Axis :	X
Test Mode :	TX G Mode 2437MHz _ Antenna Type: PCB

Horizontal

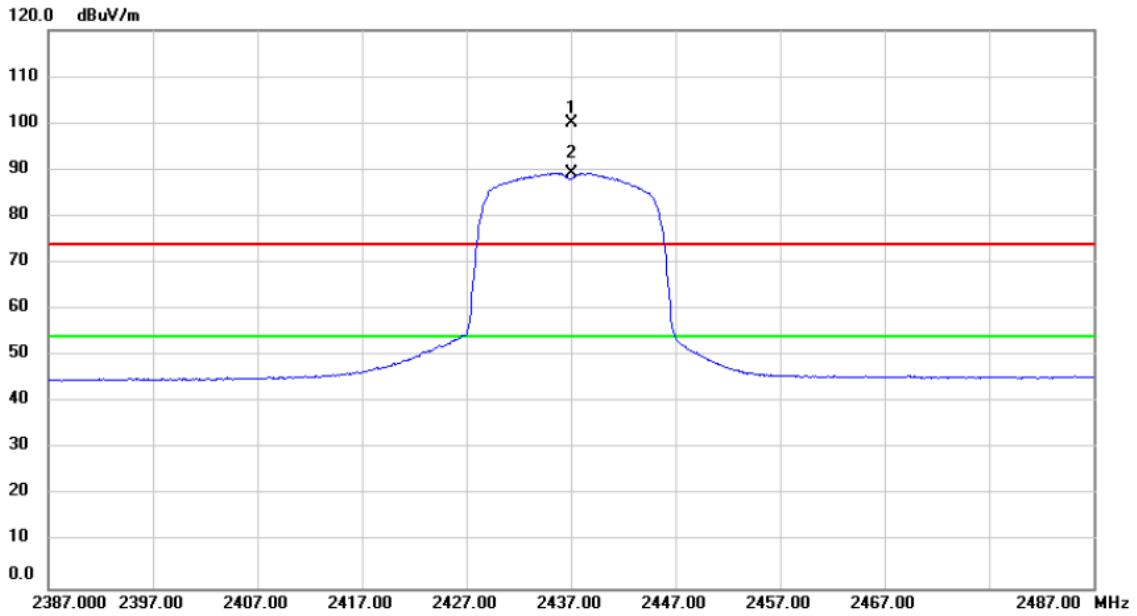

No.	Mk.	Freq.	Reading Level	Correct Factor	Measurement	Limit	Over	Detector	Comment
		MHz	dBuV	dB	dBuV/m	dBuV/m	dB		
1	X	2437.000	68.87	31.23	100.10	74.00	26.10	peak	No Limit
2	*	2437.000	58.11	31.23	89.34	54.00	35.34	AVG	No Limit

Orthogonal Axis :	X
Test Mode :	TX G Mode 2437MHz _ Antenna Type: PCB

Horizontal

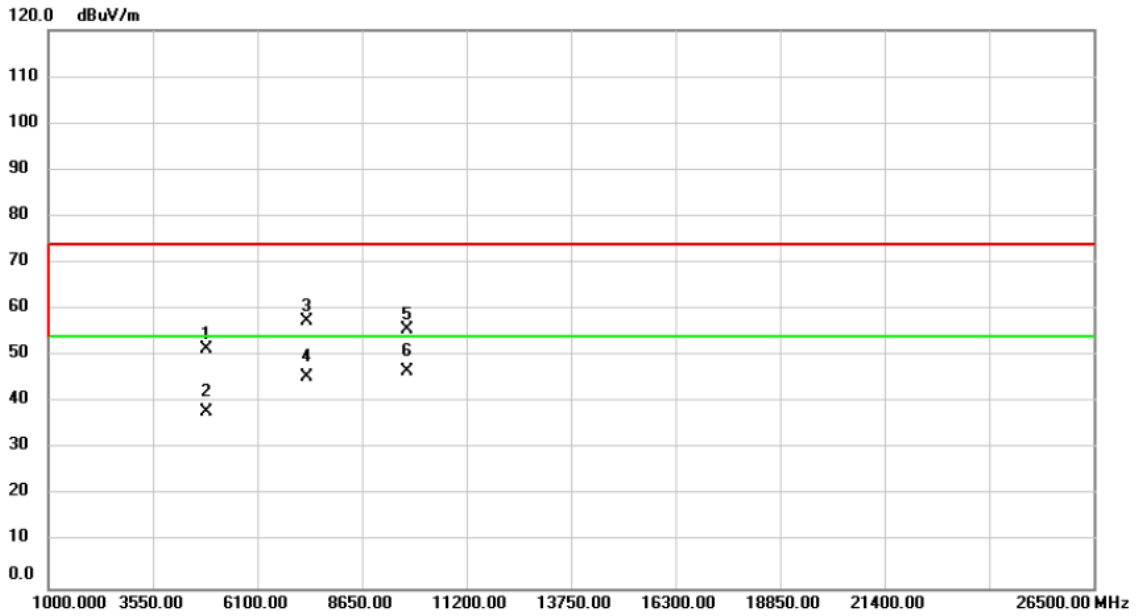

No.	Mk.	Freq.	Reading Level	Correct Factor	Measurement	Limit	Over	Detector	Comment
		MHz	dBuV	dB	dBuV/m	dBuV/m	dB		
1		4874.000	62.80	-11.29	51.51	74.00	-22.49	peak	
2		4874.000	49.33	-11.29	38.04	54.00	-15.96	AVG	
3		7311.000	62.50	-5.13	57.37	74.00	-16.63	peak	
4		7311.000	50.57	-5.13	45.44	54.00	-8.56	AVG	
5		9748.000	54.70	0.90	55.60	74.00	-18.40	peak	
6	*	9748.000	45.73	0.90	46.63	54.00	-7.37	AVG	

Orthogonal Axis :	X
Test Mode :	TX G Mode 2462MHz _ Antenna Type: PCB

Vertical

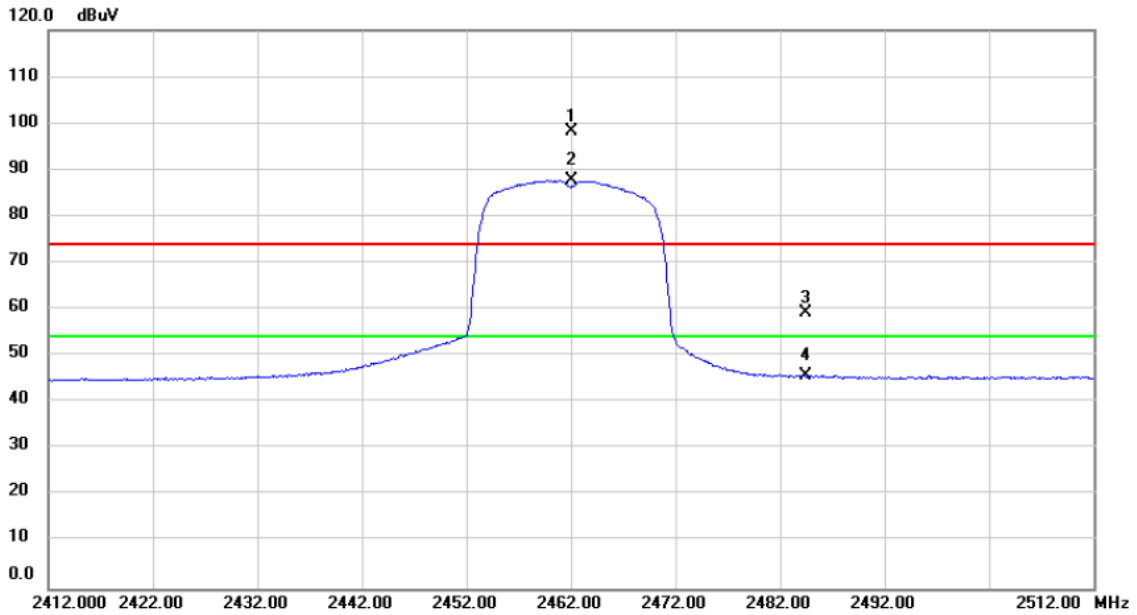

No.	Mk.	Freq.	Reading Level	Correct Factor	Measurement	Limit	Over	Detector	Comment
		MHz	dBuV	dB	dBuV	dBuV	dB		
1	X	2462.000	66.79	31.33	98.12	74.00	24.12	peak	No Limit
2	*	2462.000	56.39	31.33	87.72	54.00	33.72	AVG	No Limit
3		2484.526	27.75	31.42	59.17	74.00	-14.83	peak	
4		2484.526	14.35	31.42	45.77	54.00	-8.23	AVG	

Orthogonal Axis :	X
Test Mode :	TX G Mode 2462MHz _ Antenna Type: PCB

Vertical

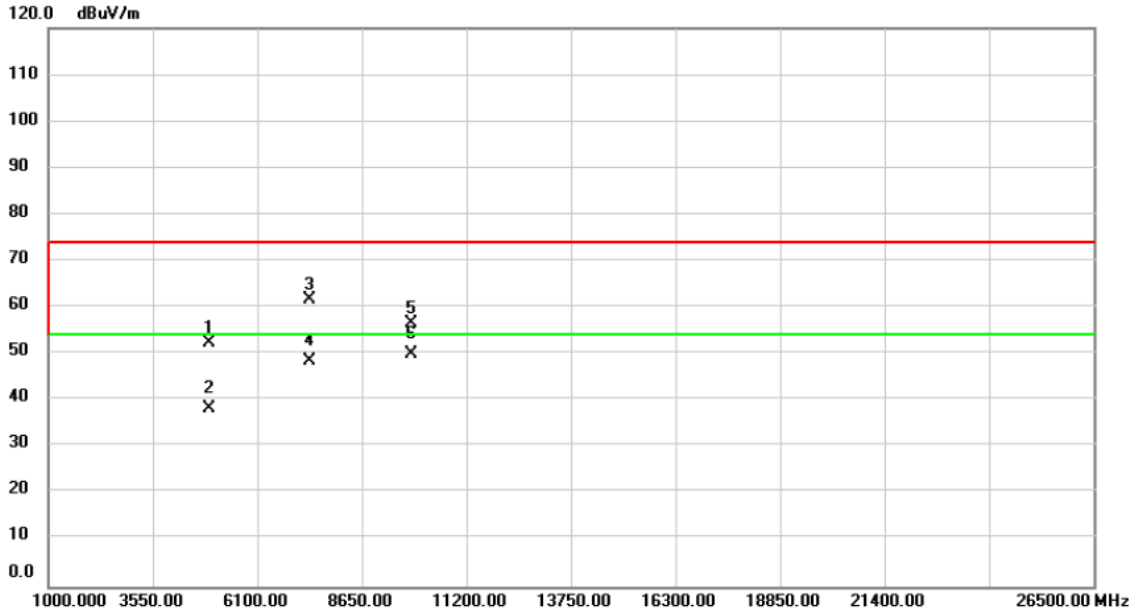

No.	Mk.	Freq. MHz	Reading Level dBuV	Correct Factor dB	Measure- ment dBuV/m	Limit dBuV/m	Over dB	Detector	Comment
1		4924.000	63.42	-11.22	52.20	74.00	-21.80	peak	
2		4924.000	49.44	-11.22	38.22	54.00	-15.78	AVG	
3		7386.000	66.57	-4.87	61.70	74.00	-12.30	peak	
4		7386.000	53.24	-4.87	48.37	54.00	-5.63	AVG	
5		9848.000	55.31	1.27	56.58	74.00	-17.42	peak	
6	*	9848.000	48.57	1.27	49.84	54.00	-4.16	AVG	

Orthogonal Axis :	X
Test Mode :	TX G Mode 2462MHz _ Antenna Type: PCB

Horizontal

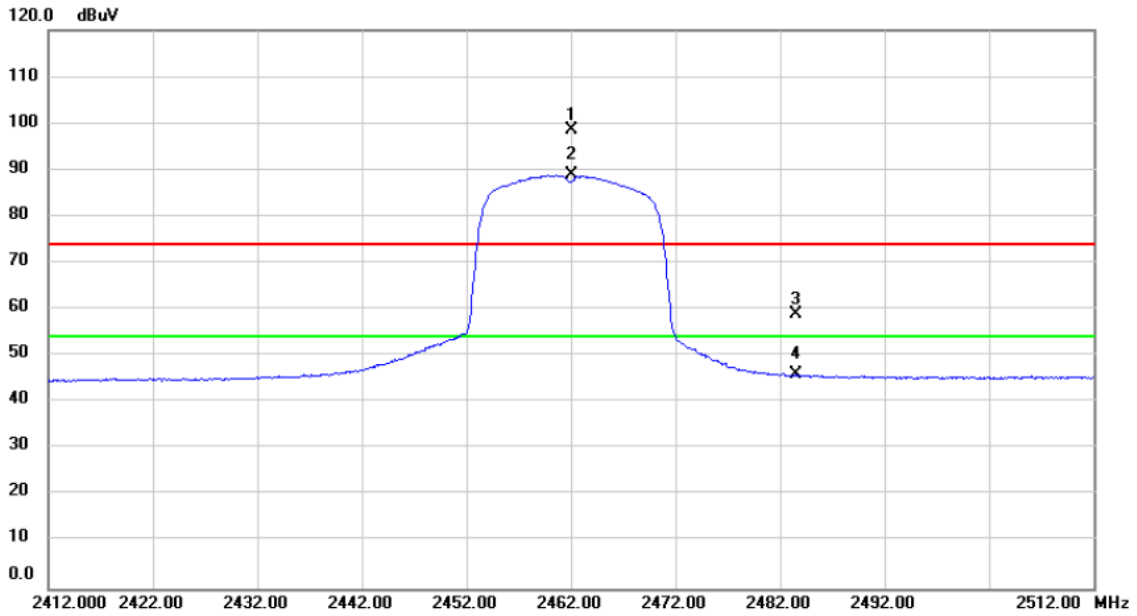

No.	Mk.	Freq.	Reading Level	Correct Factor	Measurement	Limit	Over	Detector	Comment
		MHz	dBuV	dB	dBuV	dBuV	dB		
1	X	2462.000	67.09	31.33	98.42	74.00	24.42	peak	No Limit
2	*	2462.000	57.52	31.33	88.85	54.00	34.85	AVG	No Limit
3		2483.600	27.66	31.41	59.07	74.00	-14.93	peak	
4		2483.600	14.52	31.41	45.93	54.00	-8.07	AVG	

Orthogonal Axis :	X
Test Mode :	TX G Mode 2462MHz _ Antenna Type: PCB

Horizontal

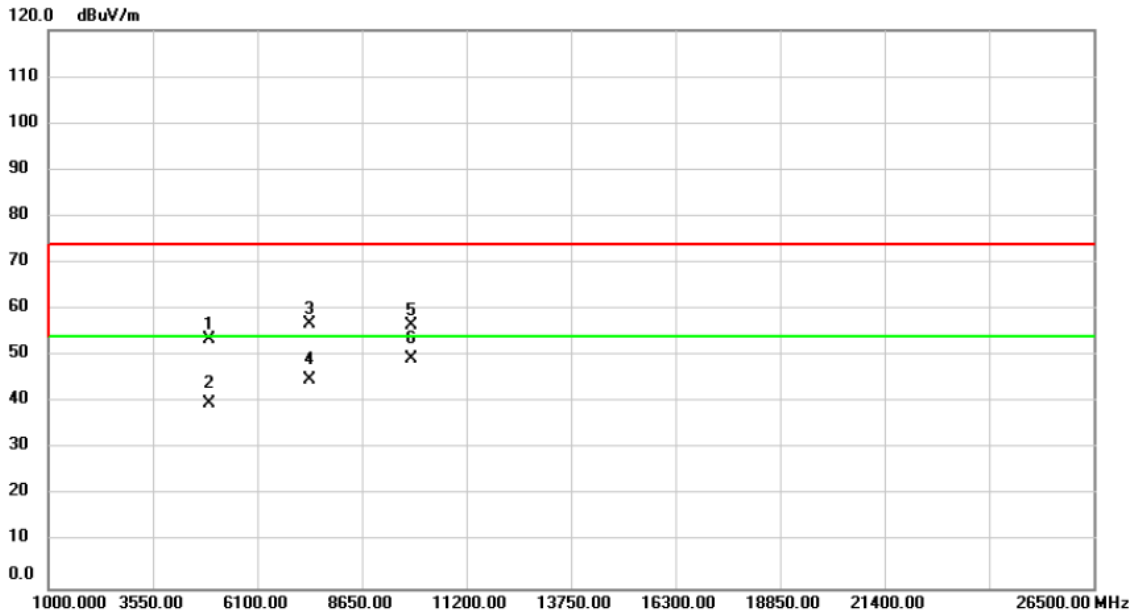

No.	Mk.	Freq. MHz	Reading Level dBuV	Correct Factor dB	Measure- ment dBuV/m	Limit dBuV/m	Over dB	Detector	Comment
1		4924.000	64.87	-11.22	53.65	74.00	-20.35	peak	
2		4924.000	50.92	-11.22	39.70	54.00	-14.30	AVG	
3		7386.000	61.69	-4.87	56.82	74.00	-17.18	peak	
4		7386.000	49.63	-4.87	44.76	54.00	-9.24	AVG	
5		9848.000	55.22	1.27	56.49	74.00	-17.51	peak	
6	*	9848.000	48.00	1.27	49.27	54.00	-4.73	AVG	

Orthogonal Axis :	X
Test Mode :	TX N-20M Mode 2412MHz _ Antenna Type: PCB

Vertical

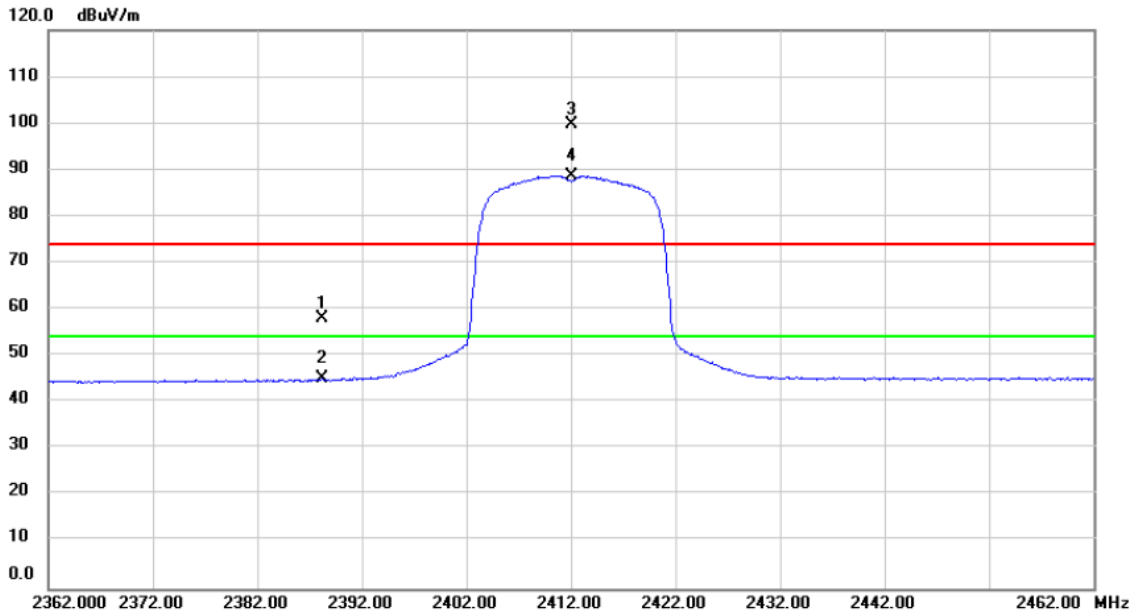

No.	Mk.	Freq. MHz	Reading Level dBuV	Correct Factor dB	Measure- ment dBuV/m	Limit dBuV/m	Over dB	Detector	Comment
1		2388.200	27.02	31.06	58.08	74.00	-15.92	peak	
2		2388.200	14.03	31.06	45.09	54.00	-8.91	AVG	
3	X	2412.000	68.56	31.14	99.70	74.00	25.70	peak	No Limit
4	*	2412.000	57.59	31.14	88.73	54.00	34.73	AVG	No Limit

Orthogonal Axis :	X
Test Mode :	TX N-20M Mode 2412MHz _ Antenna Type: PCB

Vertical

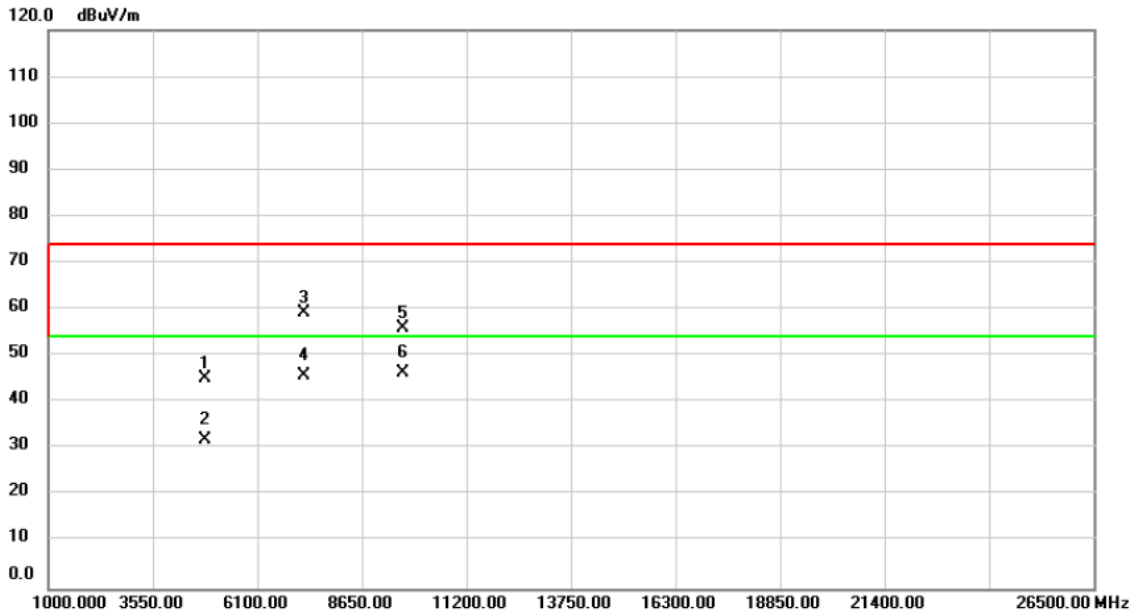

No.	Mk.	Freq.	Reading Level	Correct Factor	Measurement	Limit	Over	Detector	Comment
		MHz	dBuV	dB	dBuV/m	dBuV/m	dB		
1		4824.000	56.62	-11.37	45.25	74.00	-28.75	peak	
2		4824.000	43.29	-11.37	31.92	54.00	-22.08	AVG	
3		7236.000	64.59	-5.40	59.19	74.00	-14.81	peak	
4		7236.000	51.07	-5.40	45.67	54.00	-8.33	AVG	
5		9648.000	55.36	0.53	55.89	74.00	-18.11	peak	
6	*	9648.000	45.97	0.53	46.50	54.00	-7.50	AVG	

Orthogonal Axis :	X
Test Mode :	TX N-20M Mode 2412MHz _ Antenna Type: PCB

Horizontal

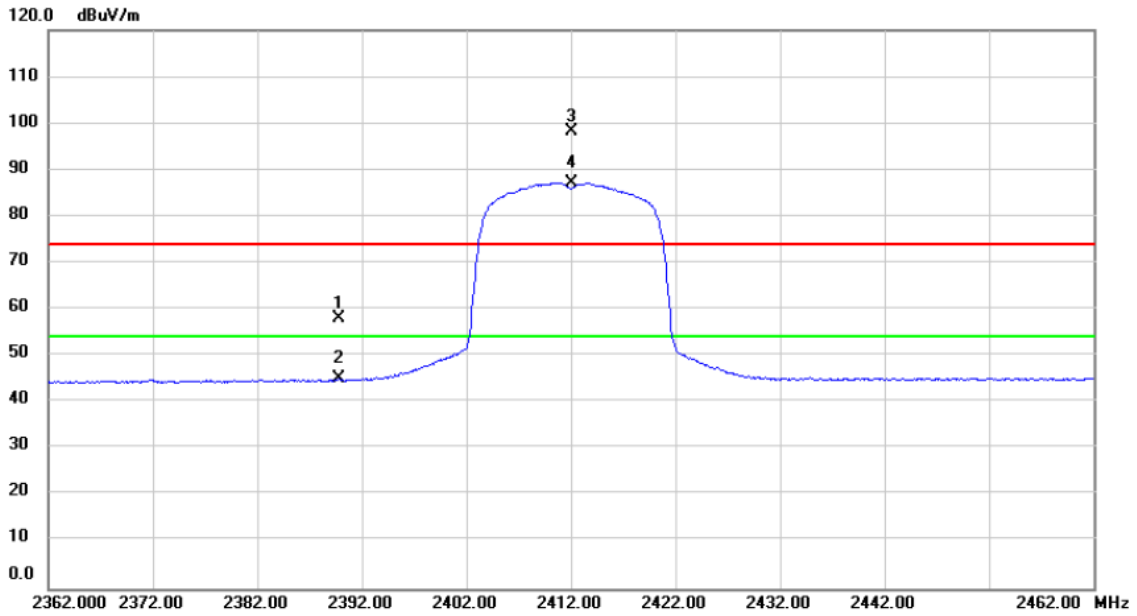

No.	Mk.	Freq.	Reading Level	Correct Factor	Measurement	Limit	Over	Detector	Comment
		MHz	dBuV	dB	dBuV/m	dBuV/m	dB		
1		2389.800	26.95	31.06	58.01	74.00	-15.99	peak	
2		2389.800	13.96	31.06	45.02	54.00	-8.98	AVG	
3	X	2412.000	67.19	31.14	98.33	74.00	24.33	peak	No Limit
4	*	2412.000	56.11	31.14	87.25	54.00	33.25	AVG	No Limit

Orthogonal Axis :	X
Test Mode :	TX N-20M Mode 2412MHz _ Antenna Type: PCB

Horizontal

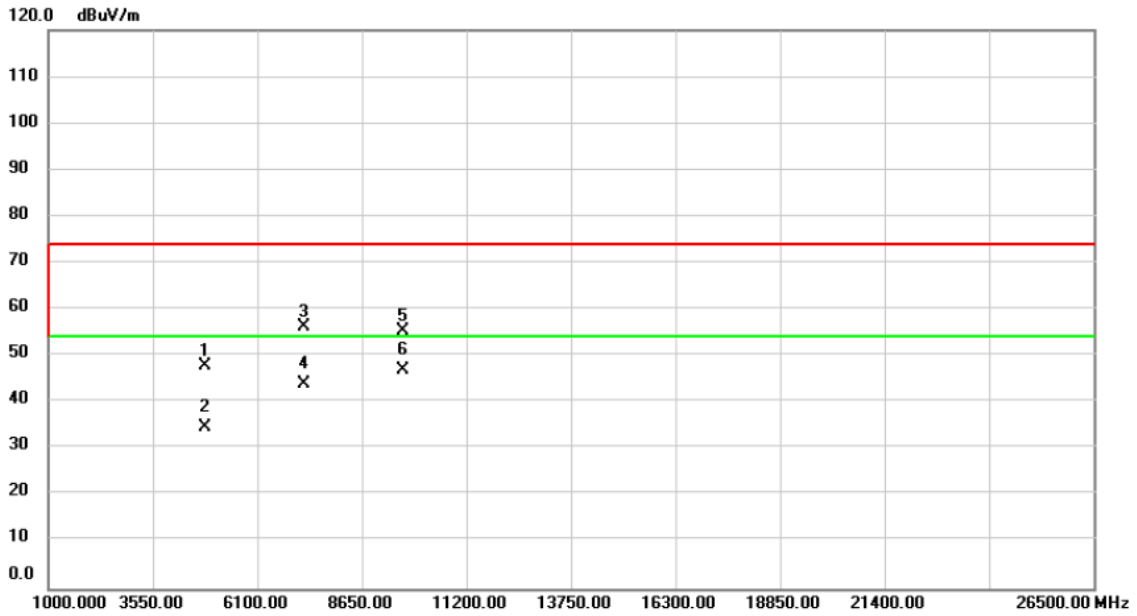

No.	Mk.	Freq.	Reading Level	Correct Factor	Measurement	Limit	Over	Detector	Comment
		MHz	dBuV	dB	dBuV/m	dBuV/m	dB		
1		4824.000	59.15	-11.37	47.78	74.00	-26.22	peak	
2		4824.000	45.97	-11.37	34.60	54.00	-19.40	AVG	
3		7236.000	61.55	-5.40	56.15	74.00	-17.85	peak	
4		7236.000	49.29	-5.40	43.89	54.00	-10.11	AVG	
5		9648.000	54.84	0.53	55.37	74.00	-18.63	peak	
6	*	9648.000	46.53	0.53	47.06	54.00	-6.94	AVG	

Orthogonal Axis :	X
Test Mode :	TX N-20M Mode 2437MHz _ Antenna Type: PCB

Vertical

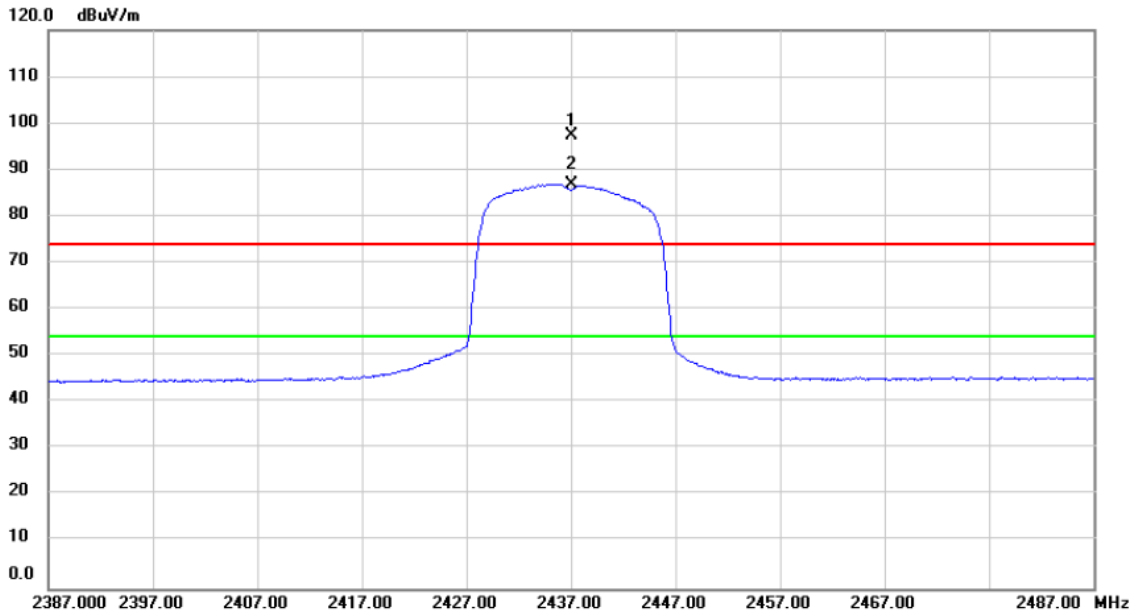

No.	Mk.	Freq.	Reading Level	Correct Factor	Measurement	Limit	Over	Detector	Comment
		MHz	dBuV	dB	dBuV/m	dBuV/m	dB		
1	X	2437.000	66.16	31.23	97.39	74.00	23.39	peak	No Limit
2	*	2437.000	55.69	31.23	86.92	54.00	32.92	AVG	No Limit

Orthogonal Axis :	X
Test Mode :	TX N-20M Mode 2437MHz _ Antenna Type: PCB

Vertical

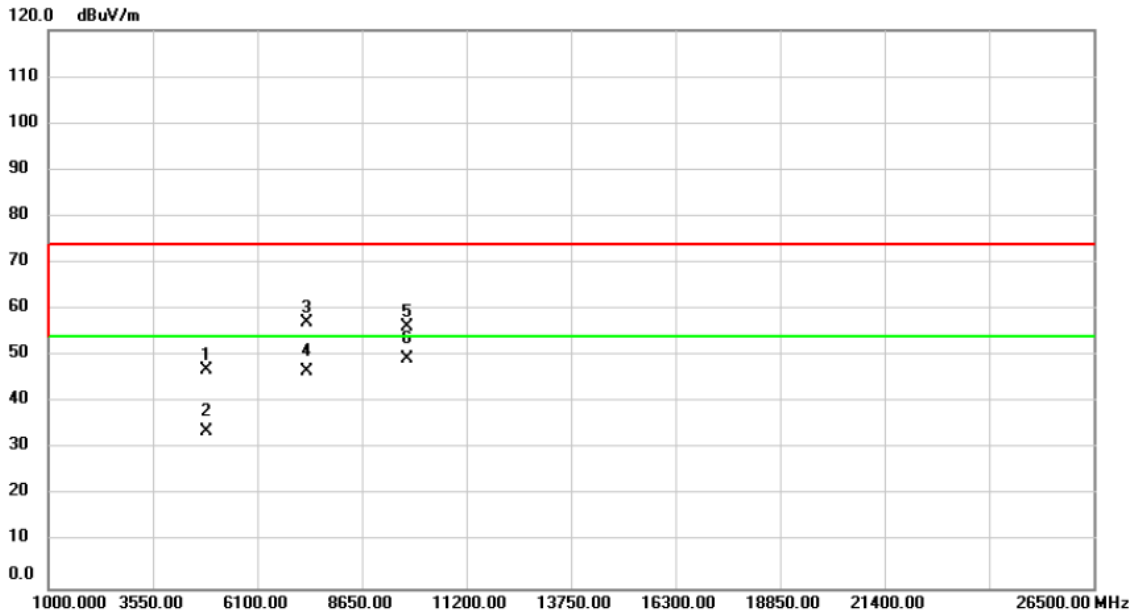

No. Mk.	Freq. MHz	Reading Level dBuV	Correct Factor dB	Measure- ment dBuV/m	Limit dBuV/m	Over dB	Detector	Comment
1	4874.000	58.31	-11.29	47.02	74.00	-26.98	peak	
2	4874.000	44.92	-11.29	33.63	54.00	-20.37	AVG	
3	7311.000	62.21	-5.13	57.08	74.00	-16.92	peak	
4	7311.000	51.65	-5.13	46.52	54.00	-7.48	AVG	
5	9748.000	55.30	0.90	56.20	74.00	-17.80	peak	
6 *	9748.000	48.44	0.90	49.34	54.00	-4.66	AVG	

Orthogonal Axis :	X
Test Mode :	TX N-20M Mode 2437MHz _ Antenna Type: PCB

Horizontal

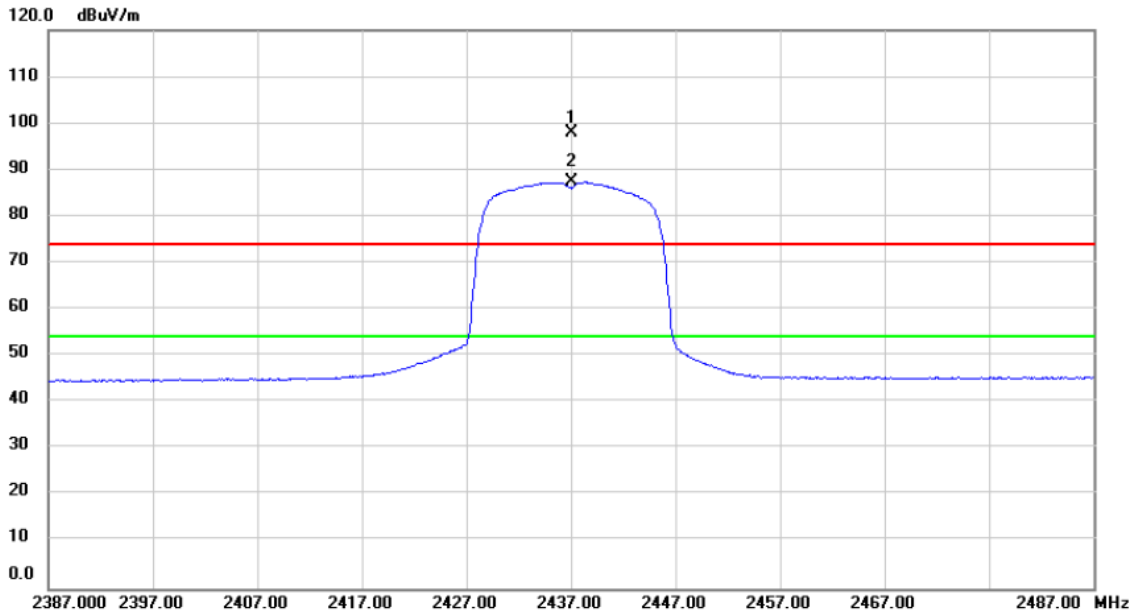

No.	Mk.	Freq.	Reading Level	Correct Factor	Measurement	Limit	Over	Detector	Comment
		MHz	dBuV	dB	dBuV/m	dBuV/m	dB		
1	X	2437.000	66.59	31.23	97.82	74.00	23.82	peak	No Limit
2	*	2437.000	56.15	31.23	87.38	54.00	33.38	AVG	No Limit

Orthogonal Axis :	X
Test Mode :	TX N-20M Mode 2437MHz _ Antenna Type: PCB

Horizontal

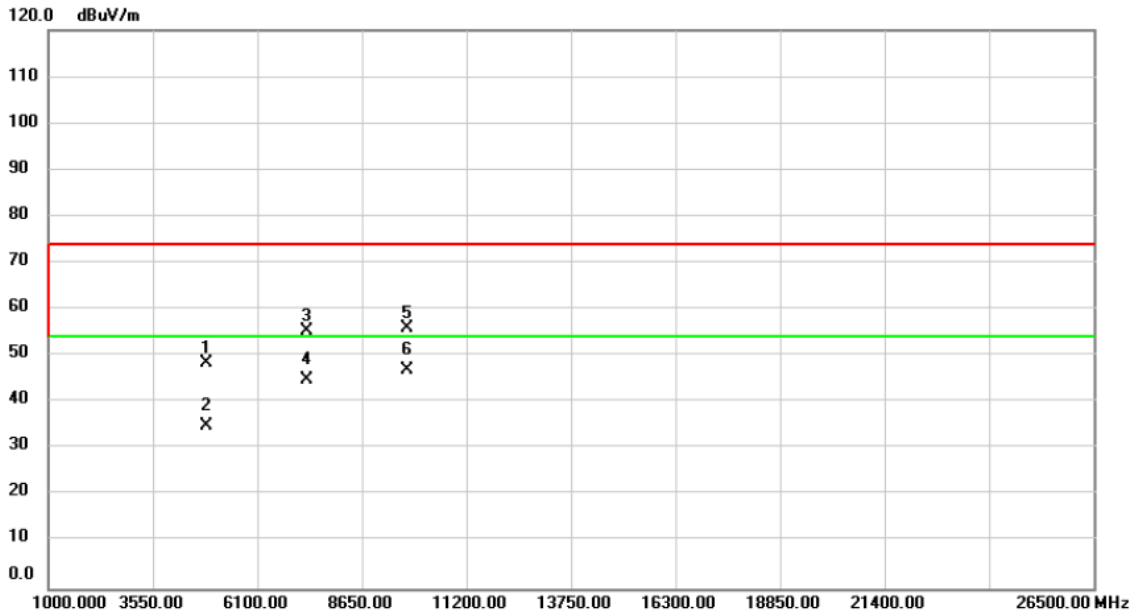

No.	Mk.	Freq.	Reading Level	Correct Factor	Measurement	Limit	Over	Detector	Comment
		MHz	dBuV	dB	dBuV/m	dBuV/m	dB		
1		4874.000	59.64	-11.29	48.35	74.00	-25.65	peak	
2		4874.000	46.22	-11.29	34.93	54.00	-19.07	AVG	
3		7311.000	60.58	-5.13	55.45	74.00	-18.55	peak	
4		7311.000	49.99	-5.13	44.86	54.00	-9.14	AVG	
5		9748.000	54.91	0.90	55.81	74.00	-18.19	peak	
6	*	9748.000	46.13	0.90	47.03	54.00	-6.97	AVG	

Orthogonal Axis :	X
Test Mode :	TX N-20M Mode 2462MHz _ Antenna Type: PCB

Vertical

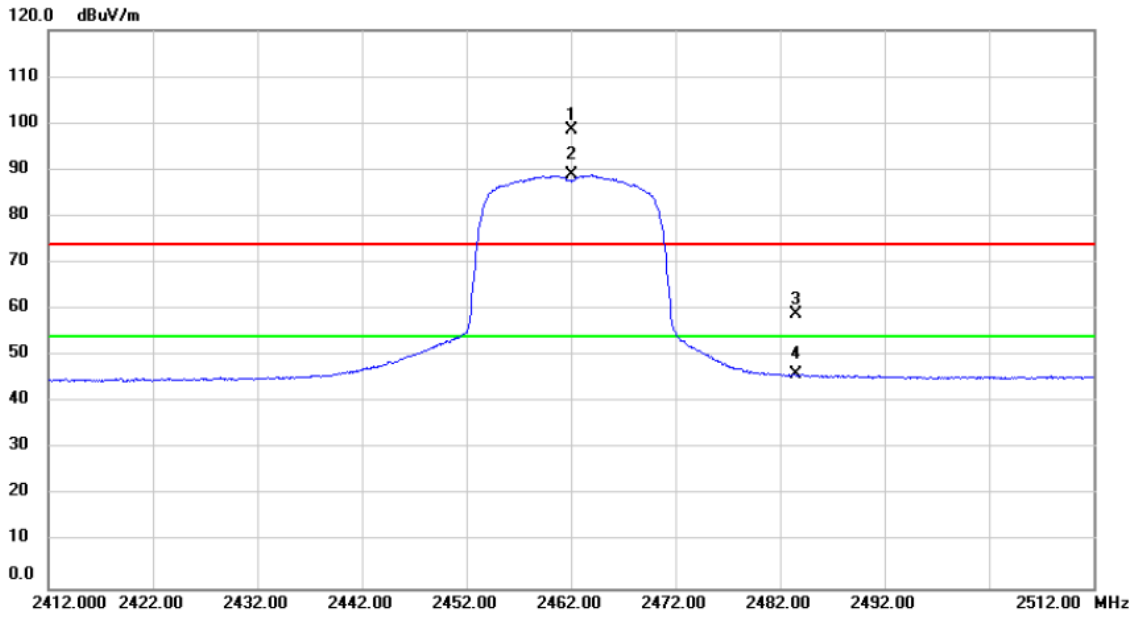

No.	Mk.	Freq.	Reading Level	Correct Factor	Measurement	Limit	Over	Detector	Comment
		MHz	dBuV	dB	dBuV/m	dBuV/m	dB		
1	X	2462.000	67.25	31.33	98.58	74.00	24.58	peak	No Limit
2	*	2462.000	57.62	31.33	88.95	54.00	34.95	AVG	No Limit
3		2483.500	27.46	31.41	58.87	74.00	-15.13	peak	
4		2483.500	14.62	31.41	46.03	54.00	-7.97	AVG	

Orthogonal Axis :	X
Test Mode :	TX N-20M Mode 2462MHz _ Antenna Type: PCB

Vertical

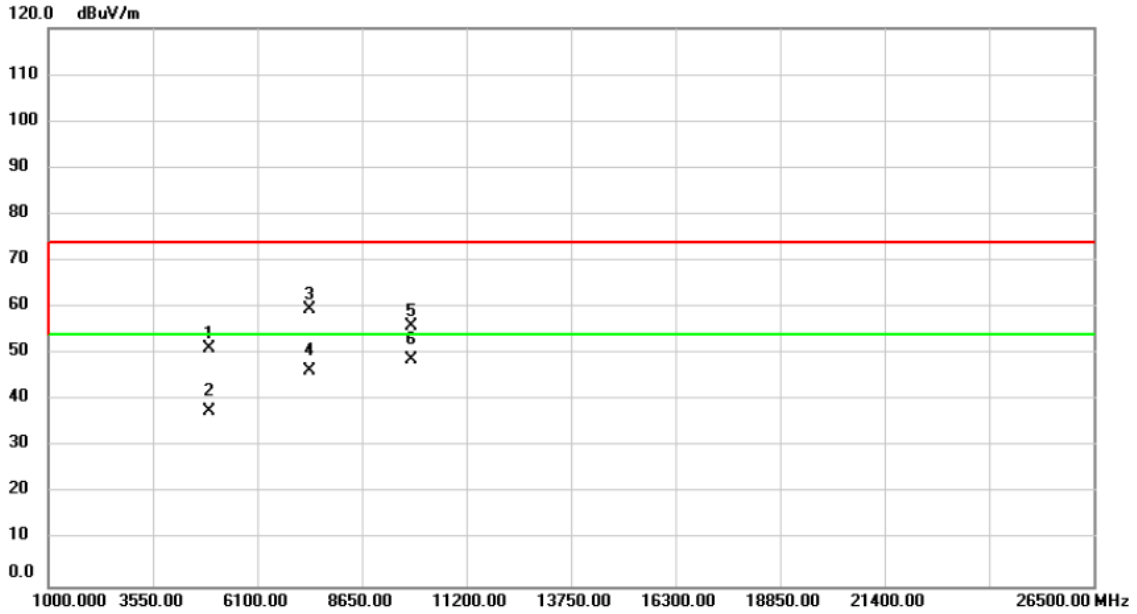

No. Mk.	Freq. MHz	Reading Level dBuV	Correct Factor dB	Measure- ment dBuV/m	Limit dBuV/m	Over dB	Detector	Comment
1	4924.000	62.33	-11.22	51.11	74.00	-22.89	peak	
2	4924.000	48.86	-11.22	37.64	54.00	-16.36	AVG	
3	7386.000	64.33	-4.87	59.46	74.00	-14.54	peak	
4	7386.000	51.33	-4.87	46.46	54.00	-7.54	AVG	
5	9848.000	54.69	1.27	55.96	74.00	-18.04	peak	
6 *	9848.000	47.49	1.27	48.76	54.00	-5.24	AVG	

Orthogonal Axis :	X
Test Mode :	TX N-20M Mode 2462MHz _ Antenna Type: PCB

Horizontal

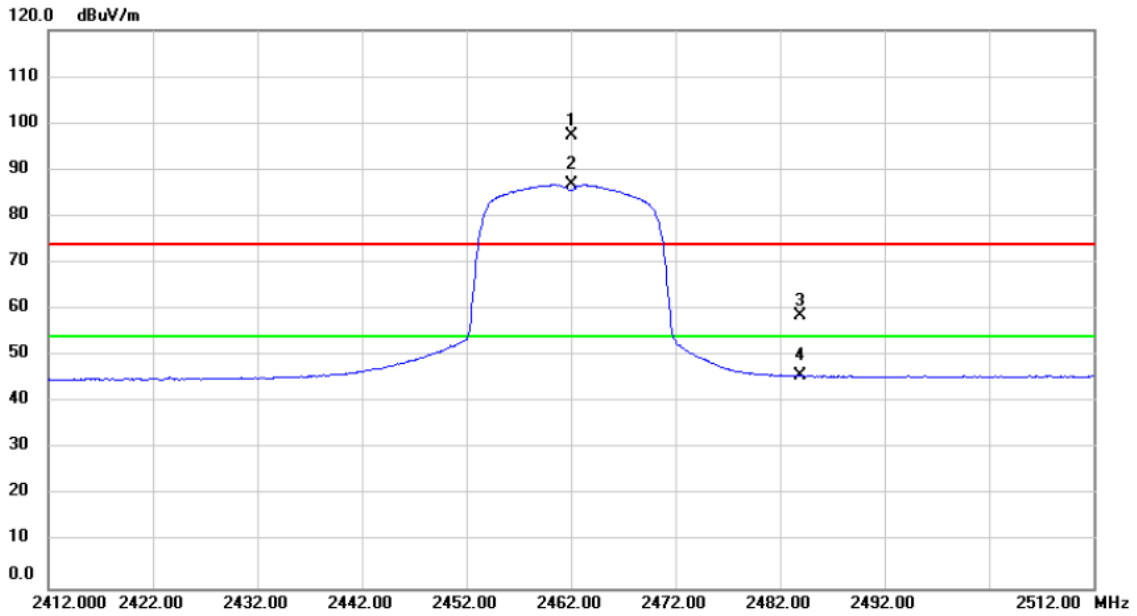

No.	Mk.	Freq.	Reading Level	Correct Factor	Measurement	Limit	Over	Detector	Comment
		MHz	dBuV	dB	dBuV/m	dBuV/m	dB		
1	X	2462.000	66.15	31.33	97.48	74.00	23.48	peak	No Limit
2	*	2462.000	55.50	31.33	86.83	54.00	32.83	AVG	No Limit
3		2483.900	27.20	31.41	58.61	74.00	-15.39	peak	
4		2483.900	14.37	31.41	45.78	54.00	-8.22	AVG	

Orthogonal Axis :	X
Test Mode :	TX N-20M Mode 2462MHz _ Antenna Type: PCB

Horizontal

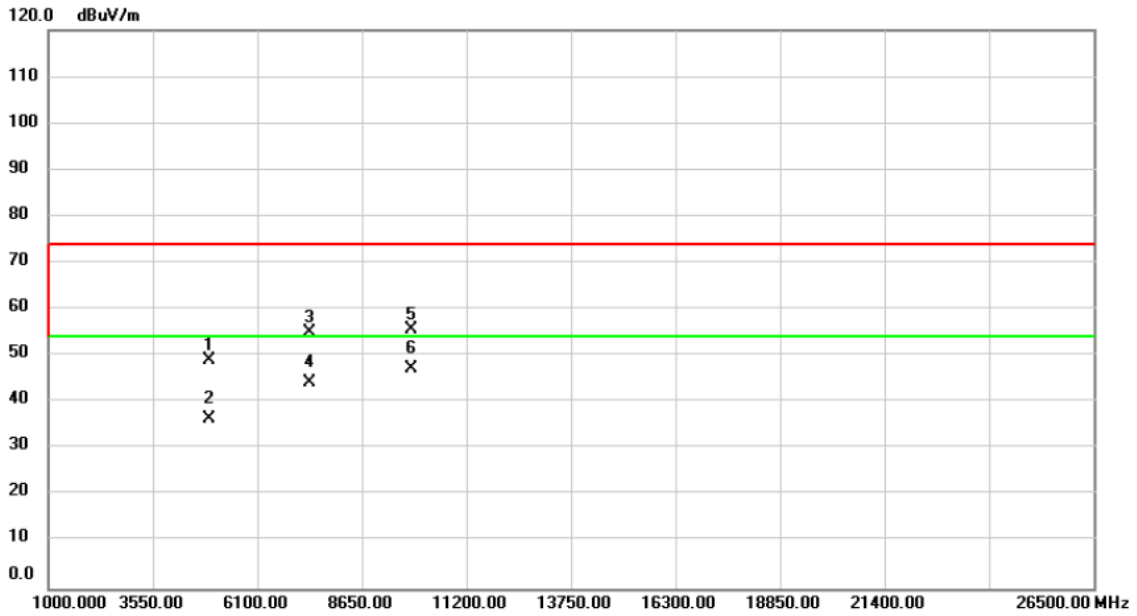

No.	Mk.	Freq. MHz	Reading Level dBuV	Correct Factor dB	Measure- ment dBuV/m	Limit dBuV/m	Over dB	Detector	Comment
1		4924.000	60.35	-11.22	49.13	74.00	-24.87	peak	
2		4924.000	47.77	-11.22	36.55	54.00	-17.45	AVG	
3		7386.000	59.92	-4.87	55.05	74.00	-18.95	peak	
4		7386.000	49.05	-4.87	44.18	54.00	-9.82	AVG	
5		9848.000	54.49	1.27	55.76	74.00	-18.24	peak	
6	*	9848.000	45.96	1.27	47.23	54.00	-6.77	AVG	