

FCC TEST REPORT

REPORT NO.: RF941220L19A

MODEL NO.: WPIR-300

RECEIVED: Dec. 21, 2005

TESTED: Dec. 22, 2005 ~ Jan. 03, 2006

ISSUED: Apr. 12, 2006

APPLICANT: SparkLAN Communications, Inc.

ADDRESS: 3Fl., No. 246, Sec. 1, Neihu Road., Neihu Chiu,
Taipei Taiwan 114, R.O.C.

ISSUED BY: Advance Data Technology Corporation

LAB ADDRESS: No. 47, 14th Ling, Chia Pau Tsuen, Lin Kou Hsiang
244, Taipei Hsien, Taiwan, R.O.C.

TEST LOCATION: No. 19, Hwa Ya 2nd Rd., Wen Hwa Tsuen, Kwei
Shan Hsiang, Taoyuan Hsien 333, Taiwan, R.O.C.

This test report consists of 64 pages in total. It may be duplicated completely for legal use with the approval of the applicant. It should not be reproduced except in full, without the written approval of our laboratory. The client should not use it to claim product endorsement by CNLA, A2LA or any government agencies. The test results in the report only apply to the tested sample.



No. 2177-01



TABLE OF CONTENTS

1.	CERTIFICATION	4
2.	SUMMARY OF TEST RESULTS	5
2.1	MEASUREMENT UNCERTAINTY	5
3.	GENERAL INFORMATION.....	6
3.1	GENERAL DESCRIPTION OF EUT	6
3.2	DESCRIPTION OF TEST MODES.....	7
3.2.1	CONFIGURATION OF SYSTEM UNDER TEST	7
3.2.2	TEST MODE APPLICABILITY AND TESTED CHANNEL DETAIL	8
3.2.3	GENERAL DESCRIPTION OF APPLIED STANDARDS.....	10
3.2.4	DESCRIPTION OF SUPPORT UNITS.....	10
4.	TEST TYPES AND RESULTS	11
4.1	CONDUCTED EMISSION MEASUREMENT	11
4.1.1	LIMITS OF CONDUCTED EMISSION MEASUREMENT	11
4.1.2	TEST INSTRUMENTS	11
4.1.3	TEST PROCEDURES.....	12
4.1.4	DEVIATION FROM TEST STANDARD	12
4.1.5	TEST SETUP	13
4.1.6	EUT OPERATING CONDITIONS	13
4.1.7	TEST RESULTS	14
4.2	RADIATED EMISSION MEASUREMENT	20
4.2.1	LIMITS OF RADIATED EMISSION MEASUREMENT	20
4.2.2	TEST INSTRUMENTS	21
4.2.4	DEVIATION FROM TEST STANDARD	23
4.2.5	TEST SETUP	23
4.2.6	EUT OPERATING CONDITIONS	23
4.2.7	TEST RESULTS	24
4.3	6dB BANDWIDTH MEASUREMENT	32
4.3.1	LIMITS OF 6dB BANDWIDTH MEASUREMENT	32
4.3.2	TEST INSTRUMENTS	32
4.3.3	TEST PROCEDURE.....	33
4.3.4	DEVIATION FROM TEST STANDARD	33
4.3.5	TEST SETUP	33
4.3.6	EUT OPERATING CONDITIONS	33
4.3.7	TEST RESULTS	34
4.4	MAXIMUM PEAK OUTPUT POWER	40
4.4.1	LIMITS OF MAXIMUM PEAK OUTPUT POWER MEASUREMENT	40
4.4.2	INSTRUMENTS	40
4.4.3	TEST PROCEDURES.....	41
4.4.4	DEVIATION FROM TEST STANDARD	41
4.4.5	TEST SETUP	41
4.4.6	EUT OPERATING CONDITIONS	41
4.4.7	TEST RESULTS	42
4.5	POWER SPECTRAL DENSITY MEASUREMENT	43
4.5.1	LIMITS OF POWER SPECTRAL DENSITY MEASUREMENT	43



4.5.2	TEST INSTRUMENTS.....	43
4.5.3	TEST PROCEDURE.....	44
4.5.4	DEVIATION FROM TEST STANDARD.....	44
4.5.5	TEST SETUP.....	44
4.5.6	EUT OPERATING CONDITION.....	44
4.5.7	TEST RESULTS.....	45
4.6	BAND EDGES MEASUREMENT.....	51
4.6.1	LIMITS OF BAND EDGES MEASUREMENT.....	51
4.6.2	TEST INSTRUMENTS.....	51
4.6.3	TEST PROCEDURE.....	51
4.6.4	DEVIATION FROM TEST STANDARD.....	51
4.6.5	EUT OPERATING CONDITION.....	51
4.6.6	TEST RESULTS.....	52
4.7	ANTENNA REQUIREMENT.....	60
4.7.1	STANDARD APPLICABLE.....	60
4.7.2	ANTENNA CONNECTED CONSTRUCTION.....	60
5.	PHOTOGRAPHS OF THE TEST CONFIGURATION.....	61
6.	INFORMATION ON THE TESTING LABORATORIES.....	63
	APPENDIX-A.....	A-1

2. SUMMARY OF TEST RESULTS

The EUT has been tested according to the following specifications:

APPLIED STANDARD: FCC Part 15, Subpart C			
STANDARD SECTION	TEST TYPE AND LIMIT	RESULT	REMARK
15.207	AC Power Conducted Emission	PASS	Meet the requirement of limit. Minimum passing margin is -7.91dB at 22.461MHz
15.247(a)(2)	Spectrum Bandwidth of a Direct Sequence Spread Spectrum System Limit: min. 500kHz	PASS	Meet the requirement of limit.
15.247(b)	Maximum Peak Output Power Limit: max. 30dBm	PASS	Meet the requirement of limit.
15.247(d)	Radiated Emissions Limit: Table 15.209	PASS	Meet the requirement of limit. Minimum passing margin is -1.08dB at 2483.50MHz
15.247(e)	Power Spectral Density Limit: max. 8dBm	PASS	Meet the requirement of limit.
15.247(d)	Band Edge Measurement Limit: 20dB less than the peak value of fundamental frequency	PASS	Meet the requirement of limit.

2.1 MEASUREMENT UNCERTAINTY

Where relevant, the following measurement uncertainty levels have been estimated for tests performed on the EUT as specified in CISPR 16-4:

MEASUREMENT	FREQUENCY	UNCERTAINTY
Conducted emissions	9kHz ~ 30MHz	2.44 dB
Radiated emissions	30MHz ~ 200MHz	3.73 dB
	200MHz ~ 1000MHz	3.74 dB
	1GHz ~ 18GHz	2.20 dB
	18GHz ~ 40GHz	1.88 dB

This uncertainty represents an expanded uncertainty expressed at approximately the 95% confidence level using a coverage factor of k=2.

3. GENERAL INFORMATION

3.1 GENERAL DESCRIPTION OF EUT

EUT	Wireless MIMO-G PCI Adapter
MODEL NO.	WPIR-300
FCC ID	RYK-WPIR300
POWER SUPPLY	3.3Vdc from host equipment
MODULATION TYPE	CCK, DQPSK, DBPSK for DSSS 64QAM, 16QAM, QPSK, BPSK for OFDM
RADIO TECHNOLOGY	DSSS, OFDM
TRANSFER RATE	802.11b: 11/5.5/2/1Mbps 802.11g: 54/48/36/24/18/12/9/6Mbps
FREQUENCY RANGE	2412MHz ~ 2462MHz
NUMBER OF CHANNEL	11
OUTPUT POWER	63.387mW
ANTENNA TYPE	Refer to Note 2 as below
DATA CABLE	NA
I/O PORTS	NA
ASSOCIATED DEVICES	NA

NOTE:

1. This is a duplicate report of RF941220L19, the difference is changing the model name, brand name, product name, applicant and outward appearance.
2. The following antenna was provided to this EUT.

ANT Type	Part No.	Gain (dBi)	Manufacture
Dipole	SDW0495A1	2.48	WANSHIH ELECTRONIC CO., LTD.

3. The EUT operates in the 2.4GHz frequency spectrum with throughput of up to 54Mbps.
4. The EUT complies with IEEE 802.11g standards and backwards compatible with IEEE 802.11b products.
5. The above EUT information was declared by manufacturer and for more detailed features description, please refer to the manufacturer's specifications or User's Manual.

3.2 DESCRIPTION OF TEST MODES

Eleven channels are provided to this EUT.

CHANNEL	FREQUENCY	CHANNEL	FREQUENCY
1	2412 MHz	7	2442 MHz
2	2417 MHz	8	2447 MHz
3	2422 MHz	9	2452 MHz
4	2427 MHz	10	2457 MHz
5	2432 MHz	11	2462 MHz
6	2437 MHz		

3.2.1 CONFIGURATION OF SYSTEM UNDER TEST

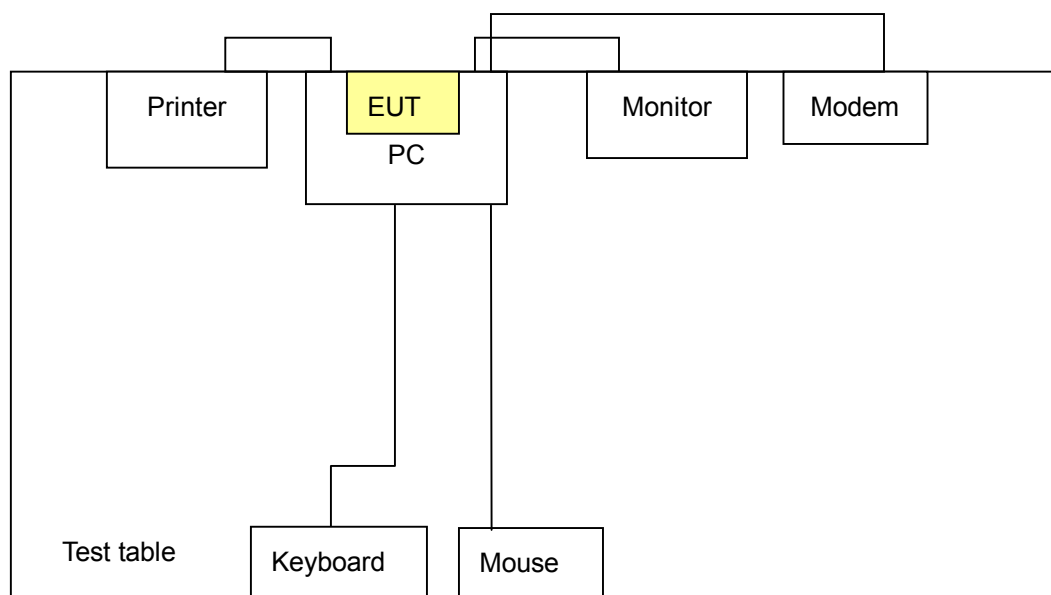

3.2.2 TEST MODE APPLICABILITY AND TESTED CHANNEL DETAIL

EUT CONFIGURE MODE	APPLICABLE TO				DESCRIPTION
	PLC	RE<1G	RE≥1G	APCM	
-	√	√	√	√	NA

Where **PLC**: Power Line Conducted Emission

RE<1G: Radiated Emission below 1GHz

RE≥1G: Radiated Emission above 1GHz

APCM: Antenna Port Conducted Measurement

POWER LINE CONDUCTED EMISSION TEST:

- Pre-Scan has been conducted to determine the worst-case mode from all possible combinations between available modulations, data rates and antenna ports (if EUT with antenna diversity architecture).
- Following channel(s) was (were) selected for the final test as listed below.

MODE	AVAILABLE CHANNEL	TESTED CHANNEL	MODULATION TECHNOLOGY	MODULATION TYPE	DATA RATE (Mbps)
802.11b	1 to 11	1, 6, 11	DSSS	DBPSK	1

RADIATED EMISSION TEST (BELOW 1 GHz):

- Pre-Scan has been conducted to determine the worst-case mode from all possible combinations between available modulations, data rates and antenna ports (if EUT with antenna diversity architecture).
- Following channel(s) was (were) selected for the final test as listed below.

MODE	AVAILABLE CHANNEL	TESTED CHANNEL	MODULATION TECHNOLOGY	MODULATION TYPE	DATA RATE (Mbps)
802.11g	1 to 11	11	OFDM	BPSK	6

RADIATED EMISSION TEST (ABOVE 1 GHz):

- Pre-Scan has been conducted to determine the worst-case mode from all possible combinations between available modulations, data rates and antenna ports (if EUT with antenna diversity architecture).
- Following channel(s) was (were) selected for the final test as listed below.

MODE	AVAILABLE CHANNEL	TESTED CHANNEL	MODULATION TECHNOLOGY	MODULATION TYPE	DATA RATE (Mbps)
802.11b	1 to 11	1, 6, 11	DSSS	DBPSK	1
802.11g	1 to 11	1, 6, 11	OFDM	BPSK	6

BANDEDGE MEASUREMENT:

- Pre-Scan has been conducted to determine the worst-case mode from all possible combinations between available modulations, data rates and antenna ports (if EUT with antenna diversity architecture).
- Following channel(s) was (were) selected for the final test as listed below.

MODE	AVAILABLE CHANNEL	TESTED CHANNEL	MODULATION TECHNOLOGY	MODULATION TYPE	DATA RATE (Mbps)
802.11b	1 to 11	1, 11	DSSS	DBPSK	1
802.11g	1 to 11	1, 11	OFDM	BPSK	6

ANTENNA PORT CONDUCTED MEASUREMENT:

- Pre-Scan has been conducted to determine the worst-case mode from all possible combinations between available modulations, data rates and antenna ports (if EUT with antenna diversity architecture).
- Following channel(s) was (were) selected for the final test as listed below.

MODE	AVAILABLE CHANNEL	TESTED CHANNEL	MODULATION TECHNOLOGY	MODULATION TYPE	DATA RATE (Mbps)
802.11b	1 to 11	1, 6, 11	DSSS	DBPSK	1
802.11g	1 to 11	1, 6, 11	OFDM	BPSK	6

3.2.3 GENERAL DESCRIPTION OF APPLIED STANDARDS

The EUT is a RF Product. According to the specifications of the manufacturer, it must comply with the requirements of the following standards:

FCC Part 15, Subpart C. (15.247)

ANSI C63.4- 2003

All test items have been performed and recorded as per the above standards.

NOTE: The EUT is also considered as a kind of computer peripheral, because the connection to computer is necessary for typical use. It has been verified to comply with the requirements of FCC Part 15, Subpart B, Class B (DoC). The test report has been issued separately.

3.2.4 DESCRIPTION OF SUPPORT UNITS

The EUT has been tested as an independent unit together with other necessary accessories or support units. The following support units or accessories were used to form a representative test configuration during the tests.

NO.	PRODUCT	BRAND	MODEL NO.	SERIAL NO.	FCC ID
1	PC	MSI	Hetis 865G Giga	3AS0119574	NA
2	PRINTER	EPSON	LQ-300+	DCGY047265	FCC DoC Approved
3	MODEM	ACEEX	1414V/3	0401008248	IFAXDM1414
4	LCD MONITOR	ACER	AL1721	ET.L0408.01040 4001F9PK00	FCC DoC Approved
5	MOUSE	DELL	MO56U0	516056250	FCC DoC Approved
6	Keyboard	DELL	SK-8110	MY-05N456- 71619-4B5-1034	FCC DoC Approved

NO.	SIGNAL CABLE DESCRIPTION OF THE ABOVE SUPPORT UNITS
1	NA
2	1.2m shielded cable without core.
3	1.2m shielded cable without core.
4	1.8m shielded cable without core.
5	1.8m shielded cable without core.
6	1.8m shielded cable without core.

NOTE: 1. All power cords of the above support units are non shielded (1.8m).

4. TEST TYPES AND RESULTS

4.1 CONDUCTED EMISSION MEASUREMENT

4.1.1 LIMITS OF CONDUCTED EMISSION MEASUREMENT

FREQUENCY OF EMISSION (MHz)	CONDUCTED LIMIT (dB μ V)	
	Quasi-peak	Average
0.15-0.5	66 to 56	56 to 46
0.5-5	56	46
5-30	60	50

- NOTE:**
1. The lower limit shall apply at the transition frequencies.
 2. The limit decreases in line with the logarithm of the frequency in the range of 0.15 to 0.50 MHz.
 3. All emanations from a class A/B digital device or system, including any network of conductors and apparatus connected thereto, shall not exceed the level of field strengths specified above.

4.1.2 TEST INSTRUMENTS

DESCRIPTION & MANUFACTURER	MODEL NO.	SERIAL NO.	CALIBRATED UNTIL
Test Receiver ROHDE & SCHWARZ	ESCS30	100288	Nov. 02, 2006
RF signal cable Woken	5D-FB	Cable-HyC02-01	Jan. 09, 2006
V-LISN SCHWARZBECK	NNBL 8226-2	8226-142	May. 02, 2006
LISN ROHDE & SCHWARZ	ESH3-Z5	100311	Jan. 20, 2006
Software ADT	ADT_Cond_V3	NA	NA

- NOTE:**
1. The calibration interval of the above test instruments is 12 months and the calibrations are traceable to NML/ROC and NIST/USA.
 2. The test was performed in HwaYa Shielded Room 3.
 3. The VCCI Site Registration No. is C-2047.

4.1.3 TEST PROCEDURES

- a. The EUT was placed 0.4 meters from the conducting wall of the shielded room with EUT being connected to the power mains through a line impedance stabilization network (LISN). Other support units were connected to the power mains through another LISN. The two LISNs provide 50 ohm/ 50uH of coupling impedance for the measuring instrument.
- b. Both lines of the power mains connected to the EUT were checked for maximum conducted interference.
- c. The frequency range from 150kHz to 30MHz was searched. Emission levels under (Limit - 20dB) was not recorded.

4.1.4 DEVIATION FROM TEST STANDARD

No deviation

4.1.5 TEST SETUP

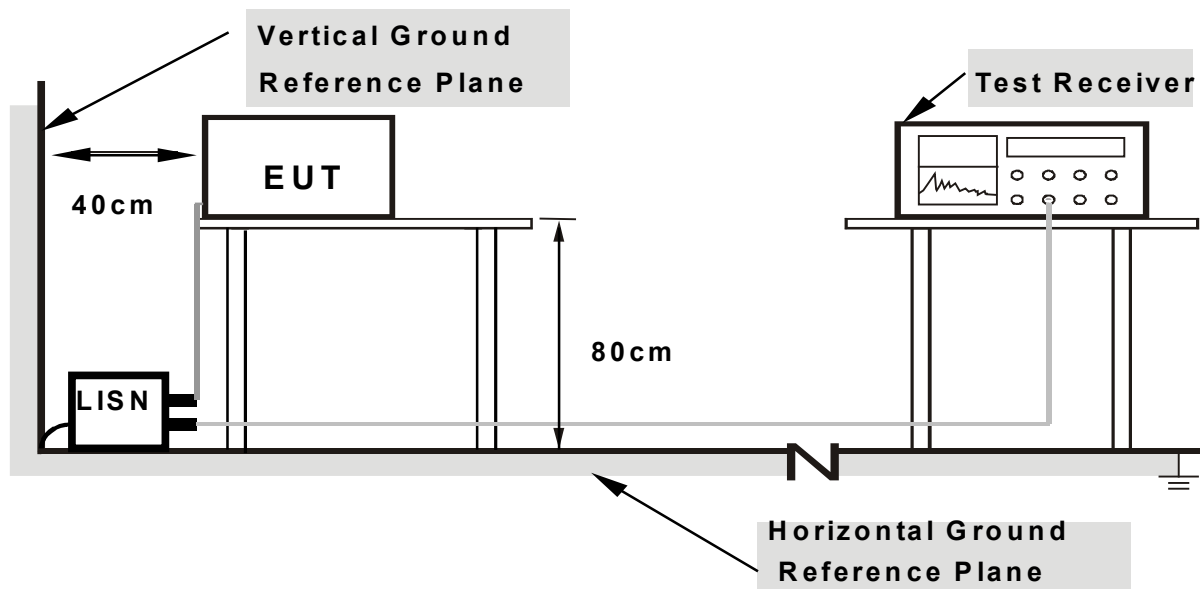

- Note:**
1. Support units were connected to second LISN.
 2. Both of LISNs (AMN) are 80 cm from EUT and at least 80 from other units and other metal planes

For the actual test configuration, please refer to the related item – Photographs of the Test Configuration.

4.1.6 EUT OPERATING CONDITIONS

- a. Connected the EUT into Personal Compute placed on a testing table.
- b. The Personal Compute system ran a test program (provided by manufacturer) to enable EUT under transmission condition continuously at specific channel frequency.
- c. The Personal Computer system sent "H" messages to monitor.
- d. The Personal Compute system sent "H" messages to modem.
- e. The Personal Compute system sent "H" messages to printer, and the printer printed them on paper.
- f. Steps c ~ e were repeated.

4.1.7 TEST RESULTS

CONDUCTED WORST-CASE DATA

EUT TEST CONDITION		MEASUREMENT DETAIL	
CHANNEL	Channel 1	PHASE	Line 1
MODULATION TYPE	BPSK	6dB BANDWIDTH	9 kHz
TRANSFER RATE	1Mbps	ENVIRONMENTAL CONDITIONS	25deg. C, 65%RH, 991hPa
TESTED BY	Jay Hsu	INPUT POWER (SYSTEM)	120Vac, 60 Hz

No	Freq. [MHz]	Corr. Factor (dB)	Reading Value [dB (uV)]		Emission Level [dB (uV)]		Limit [dB (uV)]		Margin (dB)	
			Q.P.	AV.	Q.P.	AV.	Q.P.	AV.	Q.P.	AV.
			1	0.320	0.12	32.65	-	32.77	-	59.70
2	0.443	0.13	34.35	-	34.48	-	57.01	47.01	-22.53	-
3	1.012	0.23	34.69	-	34.92	-	56.00	46.00	-21.08	-
4	2.402	0.26	34.00	-	34.26	-	56.00	46.00	-21.74	-
5	3.789	0.29	32.99	-	33.28	-	56.00	46.00	-22.72	-
6	21.605	1.09	43.74	-	44.83	-	60.00	50.00	-15.17	-

- REMARKS:**
1. Q.P. and AV. are abbreviations of quasi-peak and average individually.
 2. "-": The Quasi-peak reading value also meets average limit and measurement with the average detector is unnecessary.
 3. The emission levels of other frequencies were very low against the limit.
 4. Margin value = Emission level - Limit value
 5. Correction factor = Insertion loss + Cable loss
 6. Emission Level = Correction Factor + Reading Value.

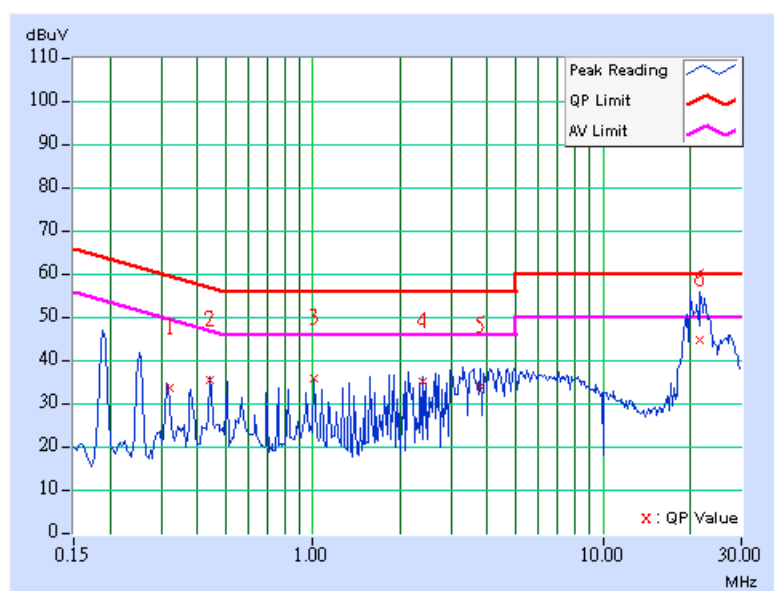

EUT TEST CONDITION		MEASUREMENT DETAIL	
CHANNEL	Channel 1	PHASE	Line 2
MODULATION TYPE	BPSK	6dB BANDWIDTH	9 kHz
TRANSFER RATE	1Mbps	ENVIRONMENTAL CONDITIONS	25deg. C, 65%RH, 991hPa
TESTED BY	Jay Hsu	INPUT POWER (SYSTEM)	120Vac, 60 Hz

No	Freq. [MHz]	Corr. Factor (dB)	Reading Value		Emission Level		Limit		Margin	
			[dB (uV)]		[dB (uV)]		[dB (uV)]		(dB)	
			Q.P.	AV.	Q.P.	AV.	Q.P.	AV.	Q.P.	AV.
1	0.318	0.12	32.87	-	32.99	-	59.76	49.76	-26.77	-
2	0.703	0.18	31.67	-	31.85	-	56.00	46.00	-24.15	-
3	1.210	0.23	27.04	-	27.27	-	56.00	46.00	-28.73	-
4	2.270	0.26	30.81	-	31.07	-	56.00	46.00	-24.93	-
5	3.527	0.28	27.42	-	27.70	-	56.00	46.00	-28.30	-
6	21.871	1.07	40.86	-	41.93	-	60.00	50.00	-18.07	-

- REMARKS:**
1. Q.P. and AV. are abbreviations of quasi-peak and average individually.
 2. "-": The Quasi-peak reading value also meets average limit and measurement with the average detector is unnecessary.
 3. The emission levels of other frequencies were very low against the limit.
 4. Margin value = Emission level - Limit value
 5. Correction factor = Insertion loss + Cable loss
 6. Emission Level = Correction Factor + Reading Value.

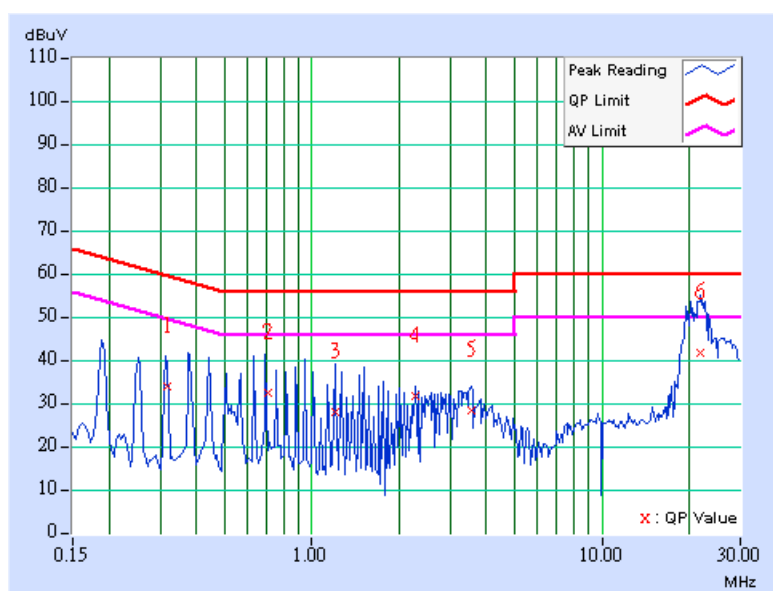

EUT TEST CONDITION		MEASUREMENT DETAIL	
CHANNEL	Channel 6	PHASE	Line 1
MODULATION TYPE	BPSK	6dB BANDWIDTH	9 kHz
TRANSFER RATE	1Mbps	ENVIRONMENTAL CONDITIONS	25deg. C, 65%RH, 991hPa
TESTED BY	Jay Hsu	INPUT POWER (SYSTEM)	120Vac, 60 Hz

No	Freq. [MHz]	Corr. Factor (dB)	Reading Value [dB (uV)]		Emission Level [dB (uV)]		Limit [dB (uV)]		Margin (dB)	
			Q.P.	AV.	Q.P.	AV.	Q.P.	AV.	Q.P.	AV.
			1	0.509	0.14	36.23	-	36.37	-	56.00
2	1.461	0.24	34.29	-	34.53	-	56.00	46.00	-21.47	-
3	2.035	0.25	34.45	-	34.70	-	56.00	46.00	-21.30	-
4	3.309	0.28	33.72	-	34.00	-	56.00	46.00	-22.00	-
5	9.620	0.43	24.80	-	25.23	-	60.00	50.00	-34.77	-
6	22.461	1.14	50.95	40.15	52.09	41.29	60.00	50.00	-7.91	-8.71

- REMARKS:**
1. Q.P. and AV. are abbreviations of quasi-peak and average individually.
 2. "-": The Quasi-peak reading value also meets average limit and measurement with the average detector is unnecessary.
 3. The emission levels of other frequencies were very low against the limit.
 4. Margin value = Emission level - Limit value
 5. Correction factor = Insertion loss + Cable loss
 6. Emission Level = Correction Factor + Reading Value.

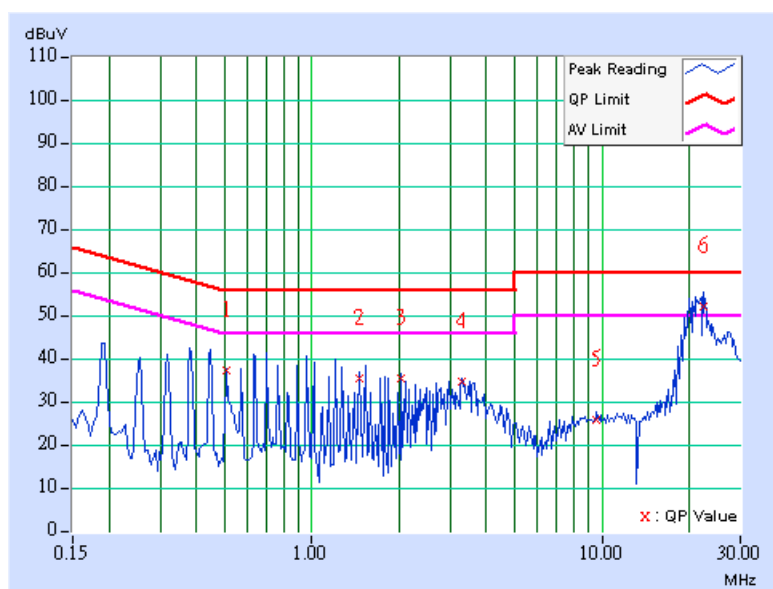

EUT TEST CONDITION		MEASUREMENT DETAIL	
CHANNEL	Channel 6	PHASE	Line 2
MODULATION TYPE	BPSK	6dB BANDWIDTH	9 kHz
TRANSFER RATE	1Mbps	ENVIRONMENTAL CONDITIONS	25deg. C, 65%RH, 991hPa
TESTED BY	Jay Hsu	INPUT POWER (SYSTEM)	120Vac, 60 Hz

No	Freq. [MHz]	Corr. Factor (dB)	Reading Value		Emission Level		Limit		Margin	
			[dB (uV)]		[dB (uV)]		[dB (uV)]		(dB)	
			Q.P.	AV.	Q.P.	AV.	Q.P.	AV.	Q.P.	AV.
1	0.318	0.12	34.91	-	35.03	-	59.76	49.76	-24.73	-
2	0.447	0.13	34.81	-	34.94	-	56.93	46.93	-21.99	-
3	1.020	0.23	35.01	-	35.24	-	56.00	46.00	-20.76	-
4	3.250	0.28	36.18	-	36.46	-	56.00	46.00	-19.54	-
5	4.969	0.33	37.56	-	37.89	-	56.00	46.00	-18.11	-
6	22.422	1.09	49.65	38.67	50.74	39.76	60.00	50.00	-9.26	-10.24

- REMARKS:**
1. Q.P. and AV. are abbreviations of quasi-peak and average individually.
 2. "-": The Quasi-peak reading value also meets average limit and measurement with the average detector is unnecessary.
 3. The emission levels of other frequencies were very low against the limit.
 4. Margin value = Emission level - Limit value
 5. Correction factor = Insertion loss + Cable loss
 6. Emission Level = Correction Factor + Reading Value.

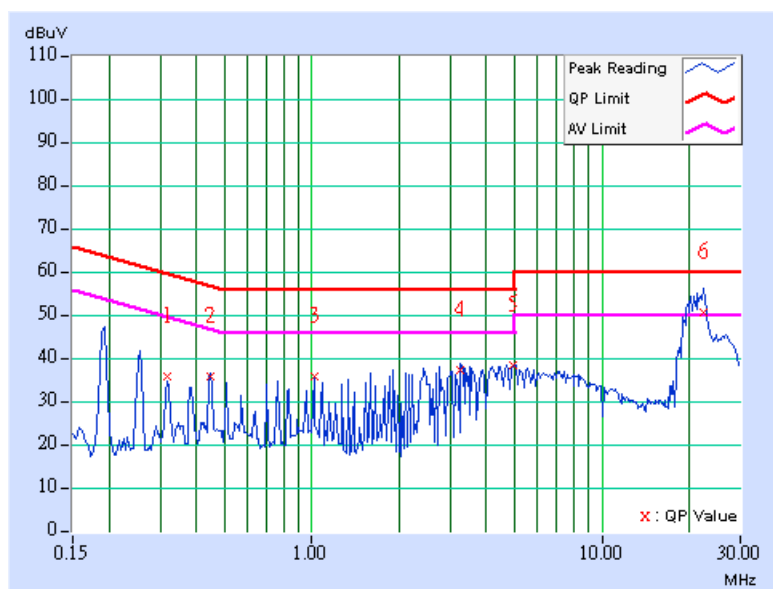

EUT TEST CONDITION		MEASUREMENT DETAIL	
CHANNEL	Channel 11	PHASE	Line 1
MODULATION TYPE	BPSK	6dB BANDWIDTH	9 kHz
TRANSFER RATE	1Mbps	ENVIRONMENTAL CONDITIONS	25deg. C, 65%RH, 991hPa
TESTED BY	Jay Hsu	INPUT POWER (SYSTEM)	120Vac, 60 Hz

No	Freq. [MHz]	Corr. Factor (dB)	Reading Value		Emission Level		Limit		Margin	
			[dB (uV)]		[dB (uV)]		[dB (uV)]		(dB)	
			Q.P.	AV.	Q.P.	AV.	Q.P.	AV.	Q.P.	AV.
1	0.318	0.12	32.59	-	32.71	-	59.76	49.76	-27.05	-
2	0.514	0.14	32.06	-	32.20	-	56.00	46.00	-23.80	-
3	1.340	0.24	34.64	-	34.88	-	56.00	46.00	-21.12	-
4	3.005	0.27	35.86	-	36.13	-	56.00	46.00	-19.87	-
5	4.795	0.31	37.02	-	37.33	-	56.00	46.00	-18.67	-
6	21.977	1.11	43.61	-	44.72	-	60.00	50.00	-15.28	-

- REMARKS:**
1. Q.P. and AV. are abbreviations of quasi-peak and average individually.
 2. "-": The Quasi-peak reading value also meets average limit and measurement with the average detector is unnecessary.
 3. The emission levels of other frequencies were very low against the limit.
 4. Margin value = Emission level - Limit value
 5. Correction factor = Insertion loss + Cable loss
 6. Emission Level = Correction Factor + Reading Value.

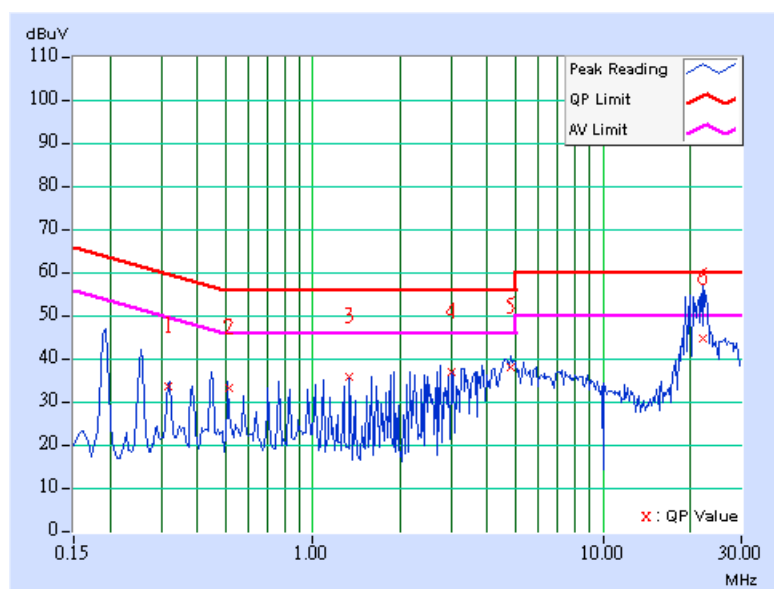

EUT TEST CONDITION		MEASUREMENT DETAIL	
CHANNEL	Channel 11	PHASE	Line 2
MODULATION TYPE	BPSK	6dB BANDWIDTH	9 kHz
TRANSFER RATE	1Mbps	ENVIRONMENTAL CONDITIONS	25deg. C, 65%RH, 991hPa
TESTED BY	Jay Hsu	INPUT POWER (SYSTEM)	120Vac, 60 Hz

No	Freq. [MHz]	Corr. Factor (dB)	Reading Value		Emission Level		Limit		Margin	
			[dB (uV)]		[dB (uV)]		[dB (uV)]		(dB)	
			Q.P.	AV.	Q.P.	AV.	Q.P.	AV.	Q.P.	AV.
1	0.318	0.12	32.71	-	32.83	-	59.76	49.76	-26.93	-
2	0.447	0.13	35.01	-	35.14	-	56.93	46.93	-21.79	-
3	1.020	0.23	34.20	-	34.43	-	56.00	46.00	-21.57	-
4	2.426	0.26	36.89	-	37.15	-	56.00	46.00	-18.85	-
5	4.980	0.33	37.13	-	37.46	-	56.00	46.00	-18.54	-
6	21.836	1.06	49.62	38.96	50.68	40.02	60.00	50.00	-9.32	-9.98

- REMARKS:**
1. Q.P. and AV. are abbreviations of quasi-peak and average individually.
 2. "-": The Quasi-peak reading value also meets average limit and measurement with the average detector is unnecessary.
 3. The emission levels of other frequencies were very low against the limit.
 4. Margin value = Emission level - Limit value
 5. Correction factor = Insertion loss + Cable loss
 6. Emission Level = Correction Factor + Reading Value.

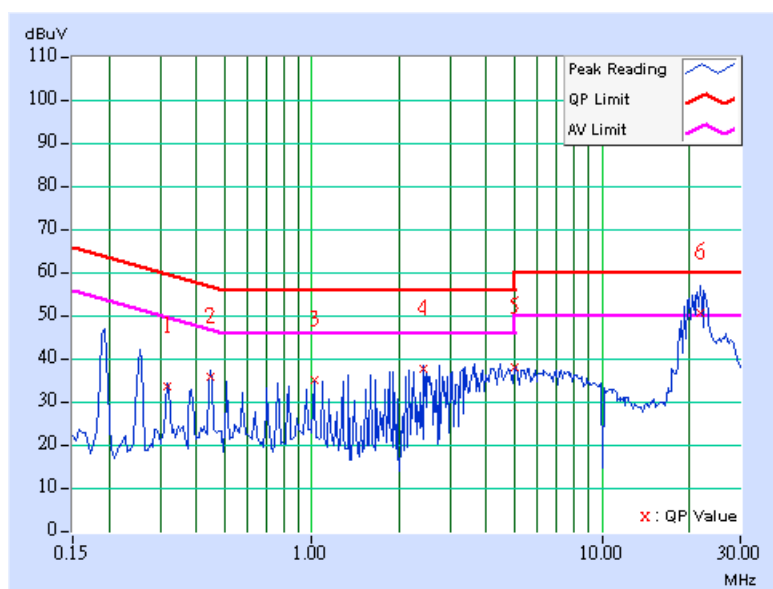

4.2 RADIATED EMISSION MEASUREMENT

4.2.1 LIMITS OF RADIATED EMISSION MEASUREMENT

Emissions radiated outside of the specified bands, shall be according to the general radiated limits in 15.209 as following:

FREQUENCIES (MHz)	FIELD STRENGTH (microvolts/meter)	MEASUREMENT DISTANCE (meters)
0.009 ~ 0.490	2400/F(kHz)	300
0.490 ~ 1.705	24000/F(kHz)	30
1.705 ~ 30.0	30	30
30 ~ 88	100	3
88 ~ 216	150	3
216 ~ 960	200	3
Above 960	500	3

NOTE:

1. The lower limit shall apply at the transition frequencies.
2. Emission level (dBuV/m) = 20 log Emission level (uV/m).
3. As shown in 15.35(b), for frequencies above 1000MHz, the field strength limits are based on average detector, however, the peak field strength of any emission shall not exceed the maximum permitted average limits, specified above by more than 20dB under any condition of modulation.



4.2.2 TEST INSTRUMENTS

DESCRIPTION & MANUFACTURER	MODEL NO.	SERIAL NO.	CALIBRATED UNTIL
Test Receiver ROHDE & SCHWARZ	ESIB7	100188	Dec. 20, 2006
Spectrum Analyzer ROHDE & SCHWARZ	FSP40	100039	Nov. 27, 2006
BILOG Antenna SCHWARZBECK	VULB9168	9168-157	Jan. 22, 2006
HORN Antenna EMCO	3117	00034130	Jan. 01, 2007
HORN Antenna SCHWARZBECK	BBHA 9170	BBHA 9170241	Feb. 23, 2006
Preamplifier Agilent	8449B	3008A01961	Oct. 23, 2006
Preamplifier Agilent	8447D	2944A10629	Oct. 27, 2006
RF signal cable HUBER+SUHNER	SUCOFLEX 104	218182/4	Feb. 17, 2006
RF signal cable HUBER+SUHNER	SUCOFLEX 104	218194/4	Feb. 17, 2006
Software ADT.	ADT_Radiated_V5.14	NA	NA
Antenna Tower ADT.	AT100	AT93021702	NA
Turn Table ADT.	TT100.	TT93021702	NA
Controller ADT.	SC100.	SC93021702	NA

- NOTE:**
1. The calibration interval of the above test instruments is 12 months and the calibrations are traceable to NML/ROC and NIST/USA.
 2. The test was performed in HwaYa Chamber 1.
 3. The horn antenna and HP preamplifier (model: 8449B) are used only for the measurement of emission frequency above 1GHz if tested.
 4. The IC Site Registration No. is IC4924-2.

4.2.3 TEST PROCEDURES

- a. The EUT was placed on the top of a rotating table 0.8 meters above the ground at a 3 meter semi-anechoic chamber. The table was rotated 360 degrees to determine the position of the highest radiation.
- b. The EUT was set 3 meters away from the interference-receiving antenna, which was mounted on the top of a variable-height antenna tower.
- c. The antenna is a broadband antenna, and its height is varied from one meter to four meters above the ground to determine the maximum value of the field strength. Both horizontal and vertical polarizations of the antenna are set to make the measurement.
- d. For each suspected emission, the EUT was arranged to its worst case and then the antenna was tuned to heights from 1 meter to 4 meters and the rotatable table was turned from 0 degrees to 360 degrees to find the maximum reading.
- e. The test-receiver system was set to Peak Detect Function and Specified Bandwidth with Maximum Hold Mode.
- f. If the emission level of the EUT in peak mode was lower than the limit specified, then testing could be stopped and the peak values of the EUT would be reported. Otherwise the emissions would be re-tested one by one using peak, quasi-peak method or average method as specified and then reported in data sheet.

NOTE:

1. The resolution bandwidth and video bandwidth of test receiver/spectrum analyzer is 120kHz for Quasi-peak detection at frequency below 1GHz.
2. The resolution bandwidth and video bandwidth of test receiver/spectrum analyzer is 1 MHz for Peak detection (PK) at frequency above 1GHz.
3. The resolution bandwidth of test receiver/spectrum analyzer is 1 MHz and the video bandwidth is 10 Hz for Average detection (AV) at frequency above 1GHz.

4.2.4 DEVIATION FROM TEST STANDARD

No deviation

4.2.5 TEST SETUP

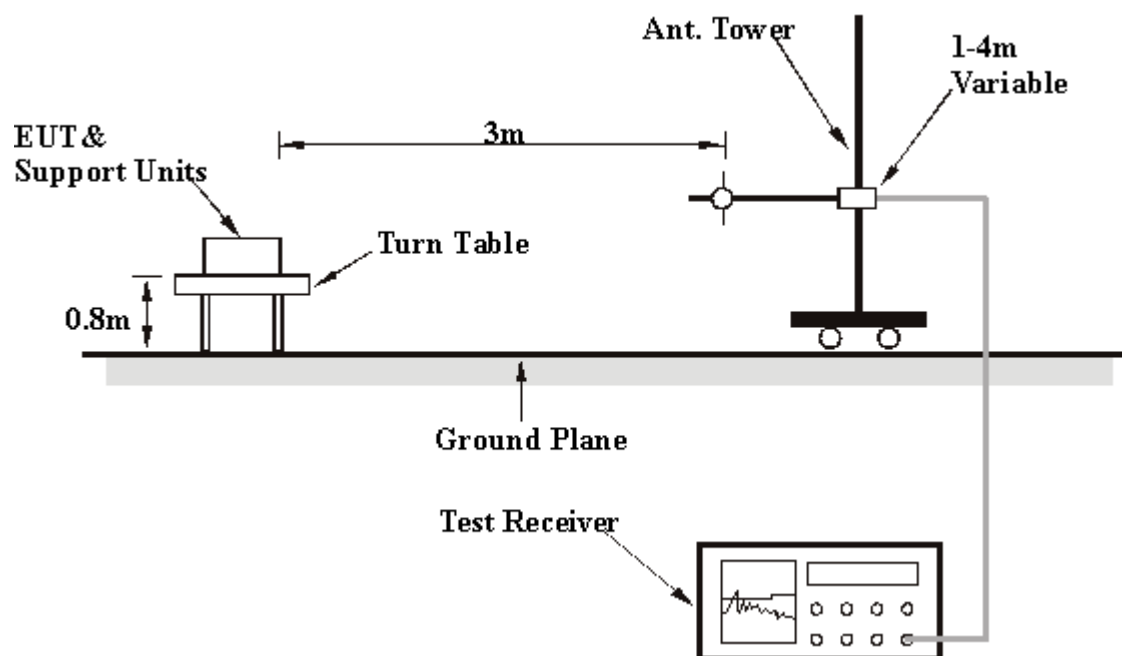

For the actual test configuration, please refer to the related item – Photographs of the Test Configuration.

4.2.6 EUT OPERATING CONDITIONS

Same as 4.1.6

4.2.7 TEST RESULTS

RADIATED WORST-CASE DATA: BELOW 1GHz

EUT TEST CONDITION		MEASUREMENT DETAIL	
CHANNEL	Channel 11	FREQUENCY RANGE	Below 1000MHz
MODULATION TYPE	BPSK	DETECTOR FUNCTION	Quasi-Peak
TRANSFER RATE	6Mbps	ENVIRONMENTAL CONDITIONS	21deg. C, 71%RH, 991hPa
TESTED BY	Match Tsui	INPUT POWER (SYSTEM)	120Vac, 60 Hz

ANTENNA POLARITY & TEST DISTANCE: HORIZONTAL AT 3 M								
No.	Freq. (MHz)	Emission Level (dBuV/m)	Limit (dBuV/m)	Margin (dB)	Antenna Height (m)	Table Angle (Degree)	Raw Value (dBuV)	Correction Factor (dB/m)
1	140.80	25.67 QP	43.50	-17.83	2.00 H	106	12.75	12.92
2	482.93	41.34 QP	46.00	-4.66	2.00 H	118	21.57	19.77
3	496.53	37.75 QP	46.00	-8.25	1.50 H	265	17.61	20.13
4	533.47	30.00 QP	46.00	-16.00	1.00 H	256	9.02	20.98
5	675.37	28.20 QP	46.00	-17.80	1.50 H	214	4.38	23.82
6	743.41	27.83 QP	46.00	-18.17	2.00 H	169	2.79	25.04
7	768.68	27.35 QP	46.00	-18.65	1.50 H	49	2.07	25.28
8	811.44	27.20 QP	46.00	-18.80	1.50 H	184	1.38	25.82
9	875.59	29.91 QP	46.00	-16.09	1.00 H	130	3.09	26.82
10	902.81	27.80 QP	46.00	-18.20	1.00 H	235	1.10	26.70
11	933.91	28.39 QP	46.00	-17.61	1.00 H	235	0.88	27.52

- REMARKS:**
1. Emission level(dBuV/m)=Raw Value(dBuV) + Correction Factor(dB/m)
 2. Correction Factor(dB/m) = Antenna Factor (dB/m) + Cable Factor (dB)
 3. The other emission levels were very low against the limit.
 4. Margin value = Emission level – Limit value.



EUT TEST CONDITION		MEASUREMENT DETAIL	
CHANNEL	Channel 11	FREQUENCY RANGE	Below 1000MHz
MODULATION TYPE	BPSK	DETECTOR FUNCTION	Quasi-Peak
TRANSFER RATE	6Mbps	ENVIRONMENTAL CONDITIONS	21deg. C, 71%RH, 991hPa
TESTED BY	Match Tsui	INPUT POWER (SYSTEM)	120Vac, 60 Hz

ANTENNA POLARITY & TEST DISTANCE: VERTICAL AT 3 M								
No.	Freq. (MHz)	Emission Level (dBuV/m)	Limit (dBuV/m)	Margin (dB)	Antenna Height (m)	Table Angle (Degree)	Raw Value (dBuV)	Correction Factor (dB/m)
1	57.21	26.10 QP	40.00	-13.90	1.00 V	157	12.91	13.18
2	64.99	33.55 QP	40.00	-6.45	1.00 V	331	20.96	12.59
3	119.42	33.23 QP	43.50	-10.27	1.25 V	127	21.50	11.74
4	156.35	30.39 QP	43.50	-13.11	1.00 V	157	17.25	13.13
5	171.90	28.51 QP	43.50	-14.99	1.25 V	103	15.99	12.52
6	482.93	38.56 QP	46.00	-7.44	1.25 V	127	18.79	19.77
7	496.53	36.28 QP	46.00	-9.72	1.00 V	142	16.15	20.13
8	811.44	32.17 QP	46.00	-13.83	1.00 V	157	6.35	25.82
9	875.59	34.01 QP	46.00	-11.99	1.25 V	313	7.19	26.82
10	879.48	31.78 QP	46.00	-14.22	1.00 V	331	4.99	26.79
11	933.91	34.55 QP	46.00	-11.45	1.00 V	214	7.03	27.52

- REMARKS:**
1. Emission level(dBuV/m)=Raw Value(dBuV) + Correction Factor(dB/m)
 2. Correction Factor(dB/m) = Antenna Factor (dB/m) + Cable Factor (dB)
 3. The other emission levels were very low against the limit.
 4. Margin value = Emission level – Limit value.

802.11b DSSS MODULATION

EUT TEST CONDITION		MEASUREMENT DETAIL	
CHANNEL	Channel 1	FREQUENCY RANGE	1 ~ 25GHz
MODULATION TYPE	DBPSK	DETECTOR FUNCTION	Peak (PK) Average (AV)
TRANSFER RATE	1Mbps	ENVIRONMENTAL CONDITIONS	25deg. C, 65%RH, 991hPa
TESTED BY	Jay Hsu	INPUT POWER (SYSTEM)	120Vac, 60 Hz

ANTENNA POLARITY & TEST DISTANCE: HORIZONTAL AT 3 M

No.	Freq. (MHz)	Emission Level (dBuV/m)	Limit (dBuV/m)	Margin (dB)	Antenna Height (m)	Table Angle (Degree)	Raw Value (dBuV)	Correction Factor (dB/m)
1	1608.00	49.80 PK	74.00	-24.20	1.08 H	328	21.35	28.45
1	1608.00	47.75 AV	54.00	-6.25	1.08 H	328	19.30	28.45
2	2386.00	54.07 PK	74.00	-19.93	1.00 H	62	23.30	30.77
2	2386.00	44.97 AV	54.00	-9.03	1.00 H	62	14.20	30.77
3	*2412.00	100.08 PK			1.00 H	61	69.21	30.87
3	*2412.00	97.03 AV			1.00 H	61	66.16	30.87
4	3216.00	45.48 PK	74.00	-28.52	1.06 H	319	12.76	32.72
4	3216.00	37.73 AV	54.00	-16.27	1.06 H	319	5.01	32.72
5	4824.00	46.71 PK	74.00	-27.29	1.13 H	37	10.37	36.34
5	4824.00	37.03 AV	54.00	-16.97	1.13 H	37	0.69	36.34

ANTENNA POLARITY & TEST DISTANCE: VERTICAL AT 3 M

No.	Freq. (MHz)	Emission Level (dBuV/m)	Limit (dBuV/m)	Margin (dB)	Antenna Height (m)	Table Angle (Degree)	Raw Value (dBuV)	Correction Factor (dB/m)
1	1608.00	49.85 PK	74.00	-24.15	1.09 V	345	21.40	28.45
1	1608.00	47.68 AV	54.00	-6.32	1.09 V	345	19.23	28.45
2	2386.00	62.35 PK	74.00	-11.65	1.30 V	327	31.58	30.77
2	2386.00	52.73 AV	54.00	-1.27	1.30 V	327	21.96	30.77
3	*2412.00	107.39 PK			1.00 V	360	76.52	30.87
3	*2412.00	104.34 AV			1.00 V	360	73.47	30.87
4	3216.00	49.79 PK	74.00	-24.21	1.08 V	25	17.07	32.72
4	3216.00	45.15 AV	54.00	-8.85	1.08 V	25	12.43	32.72
5	4824.00	48.56 PK	74.00	-25.44	1.10 V	328	12.22	36.34
5	4824.00	44.25 AV	54.00	-9.75	1.10 V	328	7.91	36.34

- REMARKS:**
1. Emission level(dBuV/m)=Raw Value(dBuV) + Correction Factor(dB/m)
 2. Correction Factor(dB/m) = Antenna Factor (dB/m) + Cable Factor (dB)
 3. The other emission levels were very low against the limit.
 4. Margin value = Emission level – Limit value.
 5. “ * “: Fundamental frequency.



EUT TEST CONDITION		MEASUREMENT DETAIL	
CHANNEL	Channel 6	FREQUENCY RANGE	1 ~ 25GHz
MODULATION TYPE	DBPSK	DETECTOR FUNCTION	Peak (PK) Average (AV)
TRANSFER RATE	1Mbps	ENVIRONMENTAL CONDITIONS	25deg. C, 65%RH, 991hPa
TESTED BY	Jay Hsu	INPUT POWER (SYSTEM)	120Vac, 60 Hz

ANTENNA POLARITY & TEST DISTANCE: HORIZONTAL AT 3 M								
No.	Freq. (MHz)	Emission Level (dBuV/m)	Limit (dBuV/m)	Margin (dB)	Antenna Height (m)	Table Angle (Degree)	Raw Value (dBuV)	Correction Factor (dB/m)
1	1624.00	51.67 PK	74.00	-22.33	1.08 H	326	23.18	28.49
1	1624.00	50.28 AV	54.00	-3.72	1.08 H	326	21.79	28.49
2	*2437.00	102.03 PK			1.15 H	35	71.07	30.96
2	*2437.00	98.71 AV			1.15 H	35	67.75	30.96
3	3248.00	44.95 PK	74.00	-29.05	1.04 H	323	12.20	32.75
3	3248.00	38.54 AV	54.00	-15.46	1.04 H	323	5.79	32.75
4	4874.00	48.91 PK	74.00	-25.09	1.12 H	78	12.43	36.48
4	4874.00	42.19 AV	54.00	-11.81	1.12 H	78	5.71	36.48

ANTENNA POLARITY & TEST DISTANCE: VERTICAL AT 3 M								
No.	Freq. (MHz)	Emission Level (dBuV/m)	Limit (dBuV/m)	Margin (dB)	Antenna Height (m)	Table Angle (Degree)	Raw Value (dBuV)	Correction Factor (dB/m)
1	1624.00	52.36 PK	74.00	-21.64	1.46 V	356	23.87	28.49
1	1624.00	50.83 AV	54.00	-3.17	1.46 V	356	22.34	28.49
2	*2437.00	109.87 PK			1.30 V	76	78.91	30.96
2	*2437.00	106.68 AV			1.30 V	76	75.72	30.96
3	3248.00	47.68 PK	74.00	-26.32	1.08 V	321	14.93	32.75
3	3248.00	43.13 AV	54.00	-10.87	1.08 V	321	10.38	32.75
4	4874.00	54.88 PK	74.00	-19.12	1.08 V	329	18.40	36.48
4	4874.00	52.54 AV	54.00	-1.46	1.08 V	329	16.06	36.48

- REMARKS:**
1. Emission level(dBuV/m)=Raw Value(dBuV) + Correction Factor(dB/m)
 2. Correction Factor(dB/m) = Antenna Factor (dB/m) + Cable Factor (dB)
 3. The other emission levels were very low against the limit.
 4. Margin value = Emission level – Limit value.
 5. " * ": Fundamental frequency.

EUT TEST CONDITION		MEASUREMENT DETAIL	
CHANNEL	Channel 11	FREQUENCY RANGE	1 ~ 25GHz
MODULATION TYPE	DBPSK	DETECTOR FUNCTION	Peak (PK) Average (AV)
TRANSFER RATE	1Mbps	ENVIRONMENTAL CONDITIONS	25deg. C, 65%RH, 991hPa
TESTED BY	Jay Hsu	INPUT POWER (SYSTEM)	120Vac, 60 Hz

ANTENNA POLARITY & TEST DISTANCE: HORIZONTAL AT 3 M								
No.	Freq. (MHz)	Emission Level (dBuV/m)	Limit (dBuV/m)	Margin (dB)	Antenna Height (m)	Table Angle (Degree)	Raw Value (dBuV)	Correction Factor (dB/m)
1	1642.00	42.70 PK	74.00	-31.30	1.07 H	320	14.16	28.54
1	1642.00	38.36 AV	54.00	-15.64	1.07 H	320	9.82	28.54
2	*2462.00	99.39 PK			1.18 H	45	68.33	31.06
2	*2462.00	96.26 AV			1.18 H	45	65.20	31.06
3	2483.50	56.65 PK	74.00	-17.35	1.14 H	46	25.51	31.14
3	2483.50	46.13 AV	54.00	-7.87	1.14 H	46	14.99	31.14
4	3282.00	45.52 PK	74.00	-28.48	1.04 H	323	12.74	32.78
4	3282.00	38.79 AV	54.00	-15.21	1.04 H	323	6.01	32.78
5	4924.00	46.65 PK	74.00	-27.35	1.29 H	353	10.02	36.63
5	4924.00	37.68 AV	54.00	-16.32	1.29 H	353	1.05	36.63

ANTENNA POLARITY & TEST DISTANCE: VERTICAL AT 3 M								
No.	Freq. (MHz)	Emission Level (dBuV/m)	Limit (dBuV/m)	Margin (dB)	Antenna Height (m)	Table Angle (Degree)	Raw Value (dBuV)	Correction Factor (dB/m)
1	1642.00	43.64 PK	74.00	-30.36	1.41 V	345	15.10	28.54
1	1642.00	39.39 AV	54.00	-14.61	1.41 V	345	10.85	28.54
2	*2462.00	107.04 PK			1.16 V	28	75.98	31.06
2	*2462.00	103.90 AV			1.16 V	28	72.84	31.06
3	2483.50	60.54 PK	74.00	-13.46	1.22 V	77	29.40	31.14
3	2483.50	52.92 AV	54.00	-1.08	1.22 V	77	21.78	31.14
4	3282.00	48.83 PK	74.00	-25.17	1.03 V	24	16.05	32.78
4	3282.00	44.59 AV	54.00	-9.41	1.03 V	24	11.81	32.78
5	4924.00	50.66 PK	74.00	-23.34	1.03 V	341	14.03	36.63
5	4924.00	46.25 AV	54.00	-7.75	1.03 V	341	9.62	36.63

- REMARKS:**
1. Emission level(dBuV/m)=Raw Value(dBuV) + Correction Factor(dB/m)
 2. Correction Factor(dB/m) = Antenna Factor (dB/m) + Cable Factor (dB)
 3. The other emission levels were very low against the limit.
 4. Margin value = Emission level – Limit value.
 5. “ * “: Fundamental frequency.



802.11g OFDM MODULATION

EUT TEST CONDITION		MEASUREMENT DETAIL	
CHANNEL	Channel 1	FREQUENCY RANGE	1 ~ 25GHz
MODULATION TYPE	BPSK	DETECTOR FUNCTION	Peak (PK) Average (AV)
TRANSFER RATE	6Mbps	ENVIRONMENTAL CONDITIONS	25deg. C, 65%RH, 991hPa
TESTED BY	Jay Hsu	INPUT POWER (SYSTEM)	120Vac, 60 Hz

ANTENNA POLARITY & TEST DISTANCE: HORIZONTAL AT 3 M								
No.	Freq. (MHz)	Emission Level (dBuV/m)	Limit (dBuV/m)	Margin (dB)	Antenna Height (m)	Table Angle (Degree)	Raw Value (dBuV)	Correction Factor (dB/m)
1	1608.00	45.57 PK	74.00	-28.43	1.00 H	145	17.12	28.45
1	1608.00	33.24 AV	54.00	-20.76	1.00 H	145	4.79	28.45
2	2390.00	54.39 PK	74.00	-19.61	1.00 H	61	23.61	30.78
2	2390.00	44.79 AV	54.00	-9.21	1.00 H	61	14.01	30.78
3	*2412.00	103.41 PK			1.00 H	61	72.54	30.87
3	*2412.00	93.11 AV			1.00 H	61	62.24	30.87
4	3216.00	45.95 PK	74.00	-28.05	1.08 H	322	13.23	32.72
4	3216.00	37.45 AV	54.00	-16.55	1.08 H	322	4.73	32.72
5	4824.00	46.18 PK	74.00	-27.82	1.08 H	24	9.84	36.34
5	4824.00	33.59 AV	54.00	-20.41	1.08 H	24	-2.75	36.34

ANTENNA POLARITY & TEST DISTANCE: VERTICAL AT 3 M								
No.	Freq. (MHz)	Emission Level (dBuV/m)	Limit (dBuV/m)	Margin (dB)	Antenna Height (m)	Table Angle (Degree)	Raw Value (dBuV)	Correction Factor (dB/m)
1	1608.00	46.71 PK	74.00	-27.29	1.26 V	23	18.26	28.45
1	1608.00	34.32 AV	54.00	-19.68	1.26 V	23	5.87	28.45
2	2390.00	63.13 PK	74.00	-10.87	1.35 V	73	32.35	30.78
2	2390.00	50.70 AV	54.00	-3.30	1.35 V	73	19.92	30.78
3	*2412.00	109.58 PK			1.32 V	74	78.71	30.87
3	*2412.00	99.48 AV			1.32 V	74	68.61	30.87
4	3216.00	49.56 PK	74.00	-24.44	1.03 V	357	16.84	32.72
4	3216.00	45.56 AV	54.00	-8.44	1.03 V	357	12.84	32.72
5	4824.00	48.34 PK	74.00	-25.66	1.00 V	325	12.00	36.34
5	4824.00	35.41 AV	54.00	-18.59	1.00 V	325	-0.93	36.34

- REMARKS:**
1. Emission level(dBuV/m)=Raw Value(dBuV) + Correction Factor(dB/m)
 2. Correction Factor(dB/m) = Antenna Factor (dB/m) + Cable Factor (dB)
 3. The other emission levels were very low against the limit.
 4. Margin value = Emission level – Limit value.
 5. " * ": Fundamental frequency.

EUT TEST CONDITION		MEASUREMENT DETAIL	
CHANNEL	Channel 6	FREQUENCY RANGE	1 ~ 25GHz
MODULATION TYPE	BPSK	DETECTOR FUNCTION	Peak (PK) Average (AV)
TRANSFER RATE	6Mbps	ENVIRONMENTAL CONDITIONS	25deg. C, 65%RH, 991hPa
TESTED BY	Jay Hsu	INPUT POWER (SYSTEM)	120Vac, 60 Hz

ANTENNA POLARITY & TEST DISTANCE: HORIZONTAL AT 3 M								
No.	Freq. (MHz)	Emission Level (dBuV/m)	Limit (dBuV/m)	Margin (dB)	Antenna Height (m)	Table Angle (Degree)	Raw Value (dBuV)	Correction Factor (dB/m)
1	1624.00	41.57 PK	74.00	-32.43	1.03 H	155	13.08	28.49
1	1624.00	29.65 AV	54.00	-24.35	1.03 H	155	1.16	28.49
2	*2437.00	103.96 PK			1.01 H	75	73.00	30.96
2	*2437.00	93.57 AV			1.01 H	75	62.61	30.96
3	3248.00	43.25 PK	74.00	-30.75	1.11 H	345	10.50	32.75
3	3248.00	37.01 AV	54.00	-16.99	1.11 H	345	4.26	32.75
4	4874.00	47.53 PK	74.00	-26.47	1.25 H	47	11.05	36.48
4	4874.00	34.77 AV	54.00	-19.23	1.25 H	47	-1.71	36.48

ANTENNA POLARITY & TEST DISTANCE: VERTICAL AT 3 M								
No.	Freq. (MHz)	Emission Level (dBuV/m)	Limit (dBuV/m)	Margin (dB)	Antenna Height (m)	Table Angle (Degree)	Raw Value (dBuV)	Correction Factor (dB/m)
1	1624.00	44.54 PK	74.00	-29.46	1.46 V	350	16.05	28.49
1	1624.00	32.30 AV	54.00	-21.70	1.46 V	350	3.81	28.49
2	*2437.00	109.91 PK			1.00 V	42	78.95	30.96
2	*2437.00	99.61 AV			1.00 V	42	68.65	30.96
3	3248.00	46.50 PK	74.00	-27.50	1.50 V	200	13.75	32.75
3	3248.00	40.21 AV	54.00	-13.79	1.50 V	200	7.46	32.75
4	4874.00	48.23 PK	74.00	-25.77	1.26 V	67	11.75	36.48
4	4874.00	35.31 AV	54.00	-18.69	1.26 V	67	-1.17	36.48

- REMARKS:**
1. Emission level(dBuV/m)=Raw Value(dBuV) + Correction Factor(dB/m)
 2. Correction Factor(dB/m) = Antenna Factor (dB/m) + Cable Factor (dB)
 3. The other emission levels were very low against the limit.
 4. Margin value = Emission level – Limit value.
 5. " * ": Fundamental frequency.

EUT TEST CONDITION		MEASUREMENT DETAIL	
CHANNEL	Channel 11	FREQUENCY RANGE	1 ~ 25GHz
MODULATION TYPE	BPSK	DETECTOR FUNCTION	Peak (PK) Average (AV)
TRANSFER RATE	6Mbps	ENVIRONMENTAL CONDITIONS	25deg. C, 65%RH, 991hPa
TESTED BY	Jay Hsu	INPUT POWER (SYSTEM)	120Vac, 60 Hz

ANTENNA POLARITY & TEST DISTANCE: HORIZONTAL AT 3 M

No.	Freq. (MHz)	Emission Level (dBuV/m)	Limit (dBuV/m)	Margin (dB)	Antenna Height (m)	Table Angle (Degree)	Raw Value (dBuV)	Correction Factor (dB/m)
1	1642.00	45.86 PK	74.00	-28.14	1.00 H	153	17.32	28.54
1	1642.00	33.28 AV	54.00	-20.72	1.00 H	153	4.74	28.54
2	*2462.00	102.78 PK			1.23 H	27	71.72	31.06
2	*2462.00	92.69 AV			1.23 H	27	61.63	31.06
3	2483.50	53.21 PK	74.00	-20.79	1.15 H	78	22.07	31.14
3	2483.50	43.15 AV	54.00	-10.85	1.15 H	78	12.01	31.14
4	3282.00	45.52 PK	74.00	-28.48	1.10 H	356	12.74	32.78
4	3282.00	41.57 AV	54.00	-12.43	1.10 H	356	8.79	32.78
5	4924.00	46.52 PK	74.00	-27.48	1.00 H	67	9.89	36.63
5	4924.00	32.83 AV	54.00	-21.17	1.00 H	67	-3.80	36.63

ANTENNA POLARITY & TEST DISTANCE: VERTICAL AT 3 M

No.	Freq. (MHz)	Emission Level (dBuV/m)	Limit (dBuV/m)	Margin (dB)	Antenna Height (m)	Table Angle (Degree)	Raw Value (dBuV)	Correction Factor (dB/m)
1	1642.00	47.18 PK	74.00	-26.82	1.37 V	45	18.64	28.54
1	1642.00	35.25 AV	54.00	-18.75	1.37 V	45	6.71	28.54
2	*2462.00	110.07 PK			1.26 V	74	79.01	31.06
2	*2462.00	98.93 AV			1.26 V	74	67.87	31.06
3	2483.50	62.50 PK	74.00	-11.50	1.27 V	80	31.36	31.14
3	2483.50	51.64 AV	54.00	-2.36	1.27 V	80	20.50	31.14
4	3282.00	48.53 PK	74.00	-25.47	1.10 V	310	15.75	32.78
4	3282.00	44.67 AV	54.00	-9.33	1.10 V	310	11.89	32.78
5	4924.00	49.20 PK	74.00	-24.80	1.01 V	330	12.57	36.63
5	4924.00	36.12 AV	54.00	-17.88	1.01 V	330	-0.51	36.63

- REMARKS:**
1. Emission level(dBuV/m)=Raw Value(dBuV) + Correction Factor(dB/m)
 2. Correction Factor(dB/m) = Antenna Factor (dB/m) + Cable Factor (dB)
 3. The other emission levels were very low against the limit.
 4. Margin value = Emission level – Limit value.
 5. “ * “: Fundamental frequency.



4.3 6dB BANDWIDTH MEASUREMENT

4.3.1 LIMITS OF 6dB BANDWIDTH MEASUREMENT

The minimum of 6dB Bandwidth Measurement is 0.5 MHz.

4.3.2 TEST INSTRUMENTS

DESCRIPTION & MANUFACTURER	MODEL NO.	SERIAL NO.	CALIBRATED UNTIL
SPECTRUM ANALYZER	FSEK 30	100049	Aug. 14, 2006

NOTE: The calibration interval of the above test instruments is 12 months and the calibrations are traceable to NML/ROC and NIST/USA.

4.3.3 TEST PROCEDURE

The transmitter output was connected to the spectrum analyzer through an attenuator. The bandwidth of the fundamental frequency was measured by spectrum analyzer with 100kHz RBW and 100kHz VBW. The 6dB bandwidth is defined as the total spectrum the power of which is higher than peak power minus 6dB.

4.3.4 DEVIATION FROM TEST STANDARD

No deviation

4.3.5 TEST SETUP

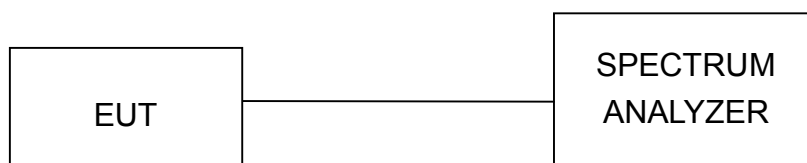

4.3.6 EUT OPERATING CONDITIONS

The software provided by client to enable the EUT under transmission condition continuously at lowest, middle and highest channel frequencies individually.



4.3.7 TEST RESULTS

802.11b DSSS MODULATION

MODULATION TYPE	DBPSK	TRANSFER RATE	1Mbps
INPUT POWER (SYSTEM)	120Vac, 60 Hz	ENVIRONMENTAL CONDITIONS	23deg. C, 63%RH, 991hPa
TESTED BY	Long Chen		

CHANNEL	CHANNEL FREQUENCY (MHz)	6dB BANDWIDTH (MHz)	MINIMUM LIMIT (MHz)	PASS/FAIL
1	2412	12.16	0.5	PASS
6	2437	13.08	0.5	PASS
11	2462	12.08	0.5	PASS

CH1

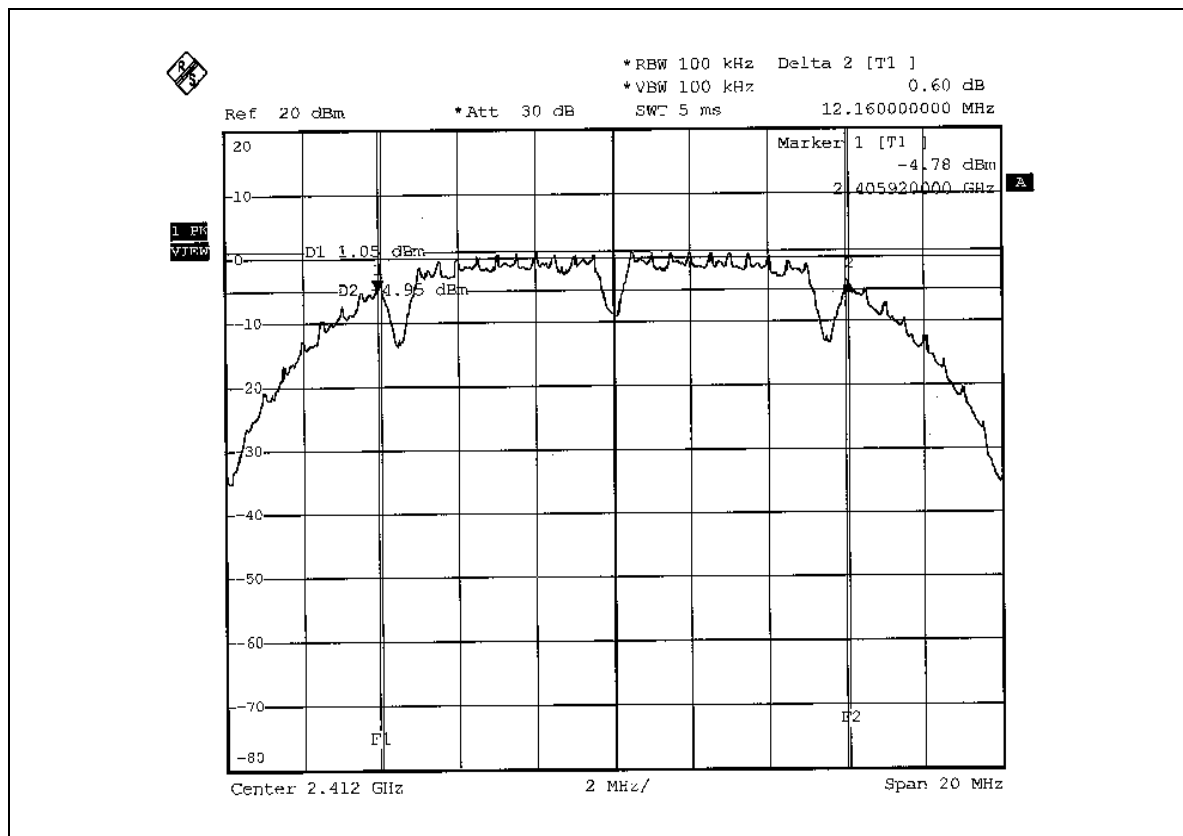

CH6

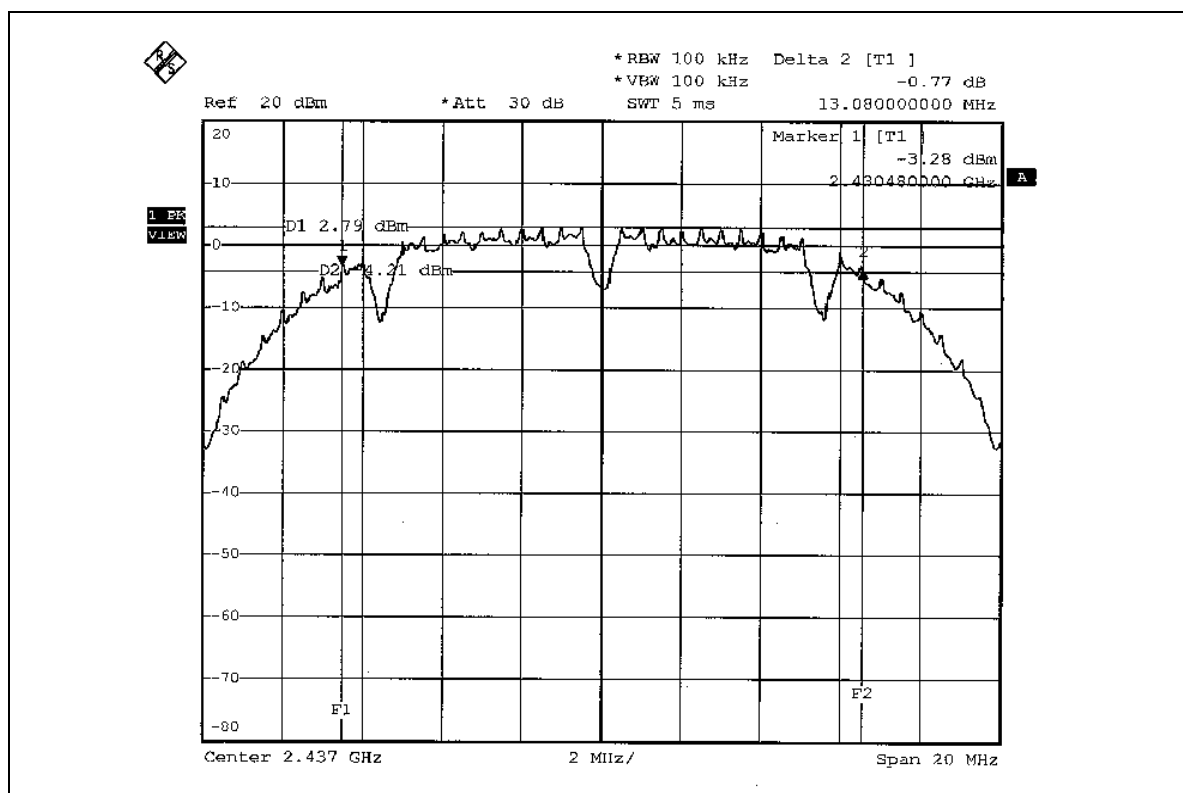

CH11

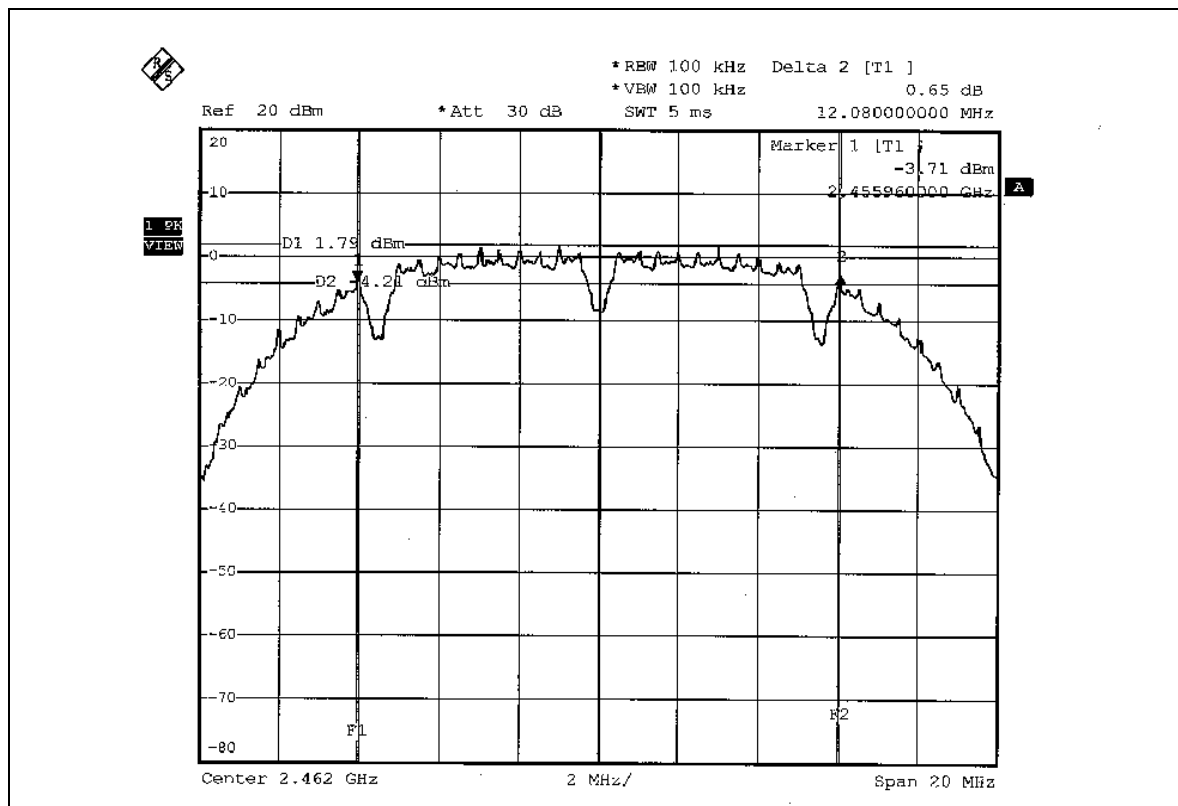



802.11g OFDM MODULATION

MODULATION TYPE	BPSK	TRANSFER RATE	6Mbps
INPUT POWER (SYSTEM)	120Vac, 60 Hz	ENVIRONMENTAL CONDITIONS	23deg. C, 63%RH, 991hPa
TESTED BY	Long Chen		

CHANNEL	CHANNEL FREQUENCY (MHz)	6dB BANDWIDTH (MHz)	MINIMUM LIMIT (MHz)	PASS/FAIL
1	2412	16.40	0.5	PASS
6	2437	16.36	0.5	PASS
11	2462	16.36	0.5	PASS

CH1

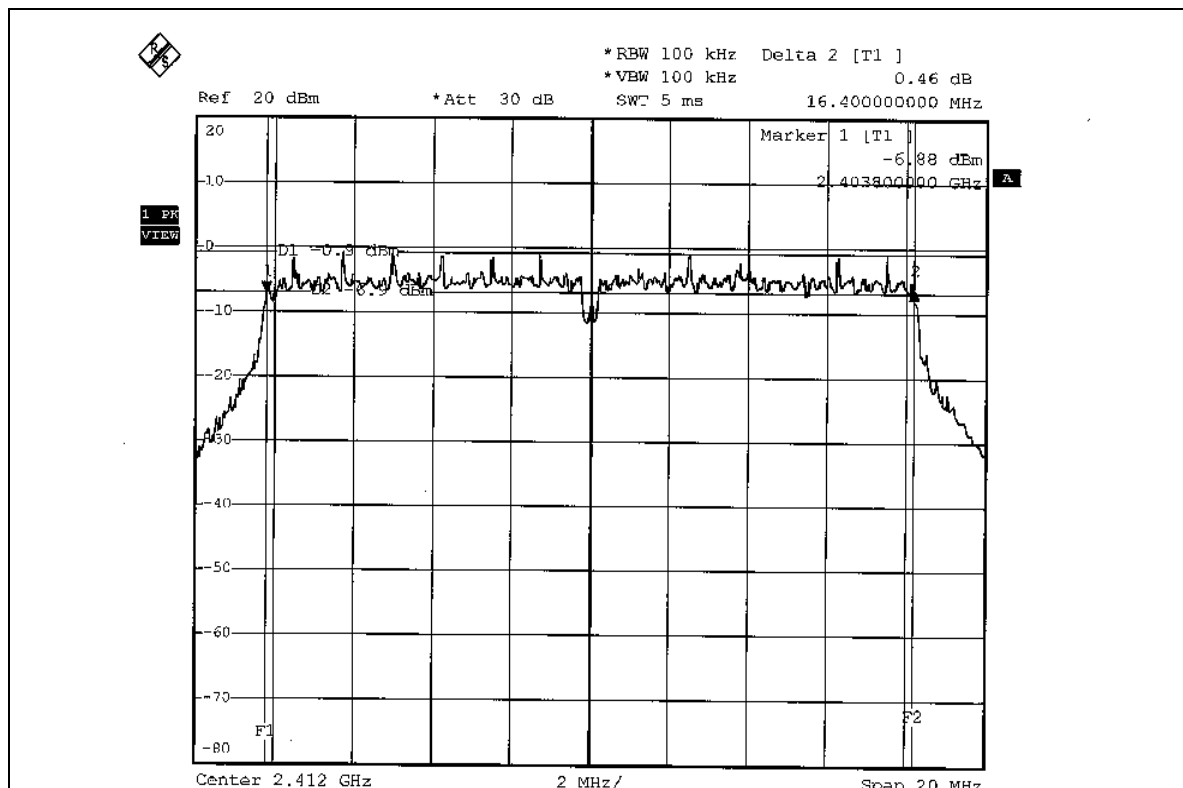

CH6

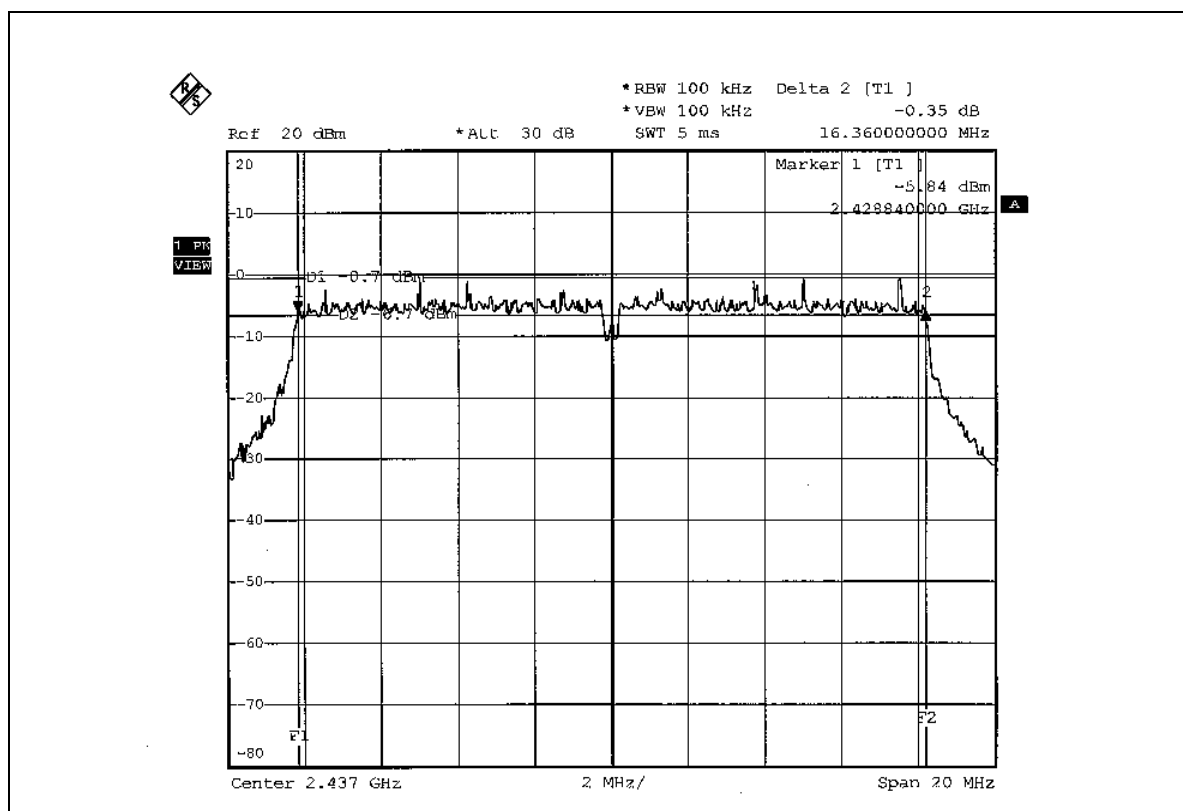

CH11

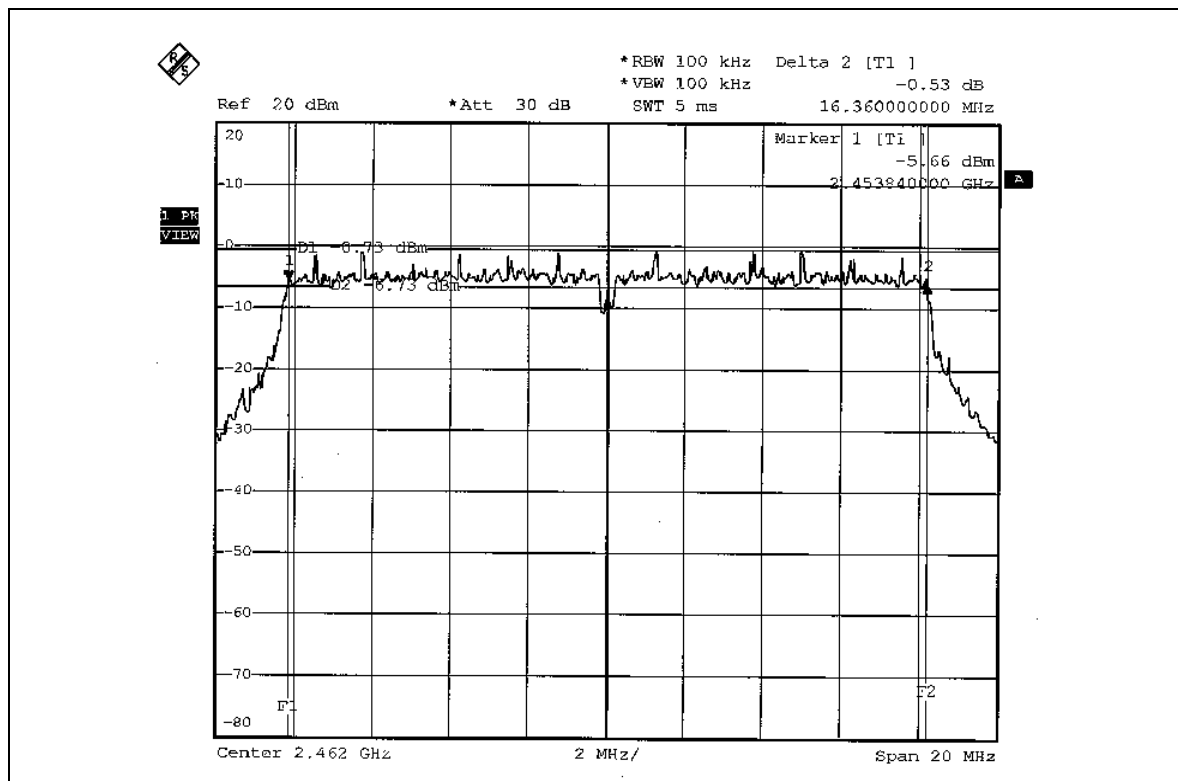



4.4 MAXIMUM PEAK OUTPUT POWER

4.4.1 LIMITS OF MAXIMUM PEAK OUTPUT POWER MEASUREMENT

The Maximum Peak Output Power Measurement is 30dBm.

4.4.2 INSTRUMENTS

DESCRIPTION & MANUFACTURER	MODEL NO.	SERIAL NO.	CALIBRATED UNTIL
R&S SPECTRUM ANALYZER	FSEK30	100049	Aug. 14, 2006
AGILENT SIGNAL GENERATOR	E8257C	MY43320668	Dec. 06, 2006
DIGITAL RT OSCILLOSCOPE	TDS1012	C037299	Nov. 28, 2006
NARDA DETECTOR	4503A	FSCM99899	NA

NOTE: The calibration interval of the above test instruments is 12 months and the calibrations are traceable to NML/ROC and NIST/USA.

4.4.3 TEST PROCEDURES

1. A detector was used on the output port of the EUT. An oscilloscope was used to read the response of the detector.
2. Replaced the EUT by the signal generator. The center frequency of the S.G was adjusted to the center frequency of the measured channel.
3. Adjusted the power to have the same reading on oscilloscope. Record the power level.

4.4.4 DEVIATION FROM TEST STANDARD

No deviation

4.4.5 TEST SETUP



4.4.6 EUT OPERATING CONDITIONS

Same as Item 4.3.6

4.4.7 TEST RESULTS

802.11b DSSS MODULATION

MODULATION TYPE	DBPSK	TRANSFER RATE	1Mbps
INPUT POWER (SYSTEM)	120Vac, 60 Hz	ENVIRONMENTAL CONDITIONS	23deg. C, 63%RH, 991hPa
TESTED BY	Long Chen		

CHANNEL	CHANNEL FREQUENCY (MHz)	PEAK POWER OUTPUT (mW)	PEAK POWER OUTPUT (dBm)	PEAK POWER LIMIT (dBm)	PASS/FAIL
1	2412	39.994	16.02	30	PASS
6	2437	63.387	18.02	30	PASS
11	2462	40.087	16.03	30	PASS

802.11g OFDM MODULATION

MODULATION TYPE	BPSK	TRANSFER RATE	6Mbps
INPUT POWER (SYSTEM)	120Vac, 60 Hz	ENVIRONMENTAL CONDITIONS	23deg. C, 63%RH, 991hPa
TESTED BY	Long Chen		

CHANNEL	CHANNEL FREQUENCY (MHz)	PEAK POWER OUTPUT (mW)	PEAK POWER OUTPUT (dBm)	PEAK POWER LIMIT (dBm)	PASS/FAIL
1	2412	40.272	16.05	30	PASS
6	2437	40.179	16.04	30	PASS
11	2462	39.994	16.02	30	PASS



4.5 POWER SPECTRAL DENSITY MEASUREMENT

4.5.1 LIMITS OF POWER SPECTRAL DENSITY MEASUREMENT

The Maximum of Power Spectral Density Measurement is 8dBm.

4.5.2 TEST INSTRUMENTS

DESCRIPTION & MANUFACTURER	MODEL NO.	SERIAL NO.	CALIBRATED UNTIL
R&S SPECTRUM ANALYZER	FSEK30	100049	Aug. 14, 2006

NOTE: The calibration interval of the above test instruments is 12 months and the calibrations are traceable to NML/ROC and NIST/USA.

4.5.3 TEST PROCEDURE

The transmitter output was connected to the spectrum analyzer through an attenuator, the bandwidth of the fundamental frequency was measured with the spectrum analyzer using 3kHz RBW and 30kHz VBW, set sweep time = span/3kHz. The power spectral density was measured and recorded.

The sweep time is allowed to be longer than span/3kHz for a full response of the mixer in the spectrum analyzer.

4.5.4 DEVIATION FROM TEST STANDARD

No deviation

4.5.5 TEST SETUP

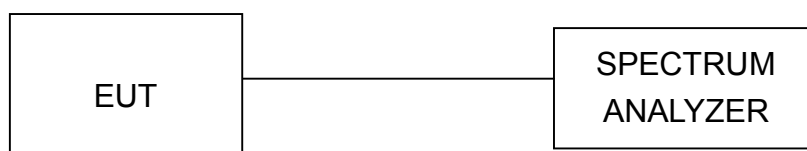

4.5.6 EUT OPERATING CONDITION

Same as Item 4.3.6



4.5.7 TEST RESULTS

802.11b DSSS MODULATION

MODULATION TYPE	DBPSK	TRANSFER RATE	1Mbps
INPUT POWER (SYSTEM)	120Vac, 60 Hz	ENVIRONMENTAL CONDITIONS	23deg. C, 63%RH, 991hPa
TESTED BY	Long Chen		

CHANNEL	CHANNEL FREQUENCY (MHz)	RF POWER LEVEL IN 3kHz BW (dBm)	MAXIMUM LIMIT (dBm)	PASS/FAIL
1	2412	-13.95	8	PASS
6	2437	-11.99	8	PASS
11	2462	-13.99	8	PASS

CH1

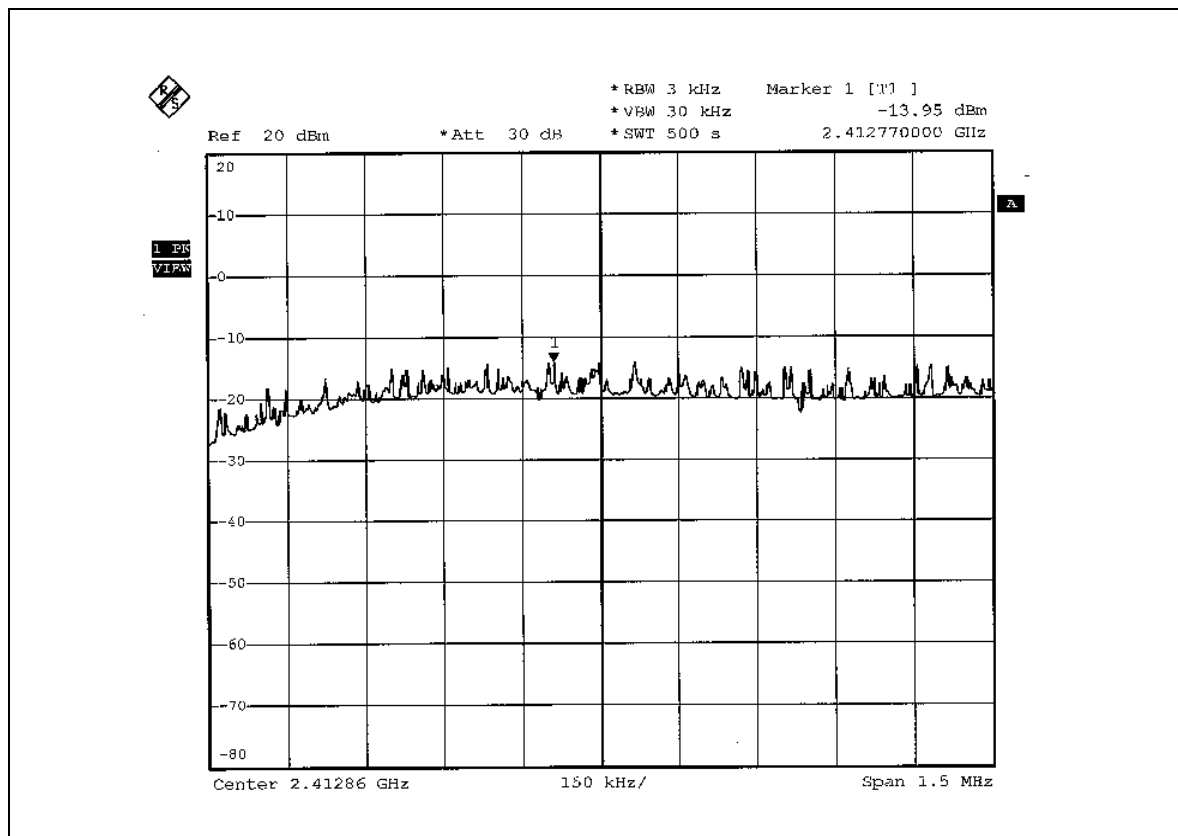

CH6

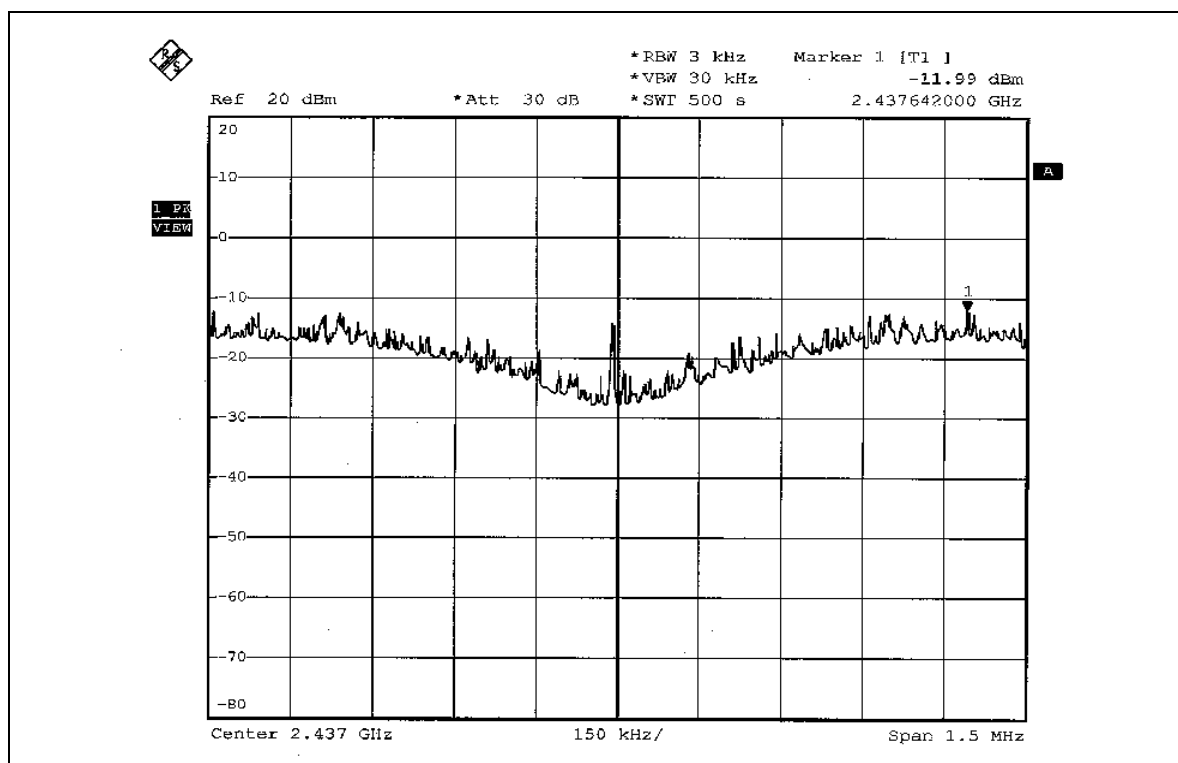

CH11

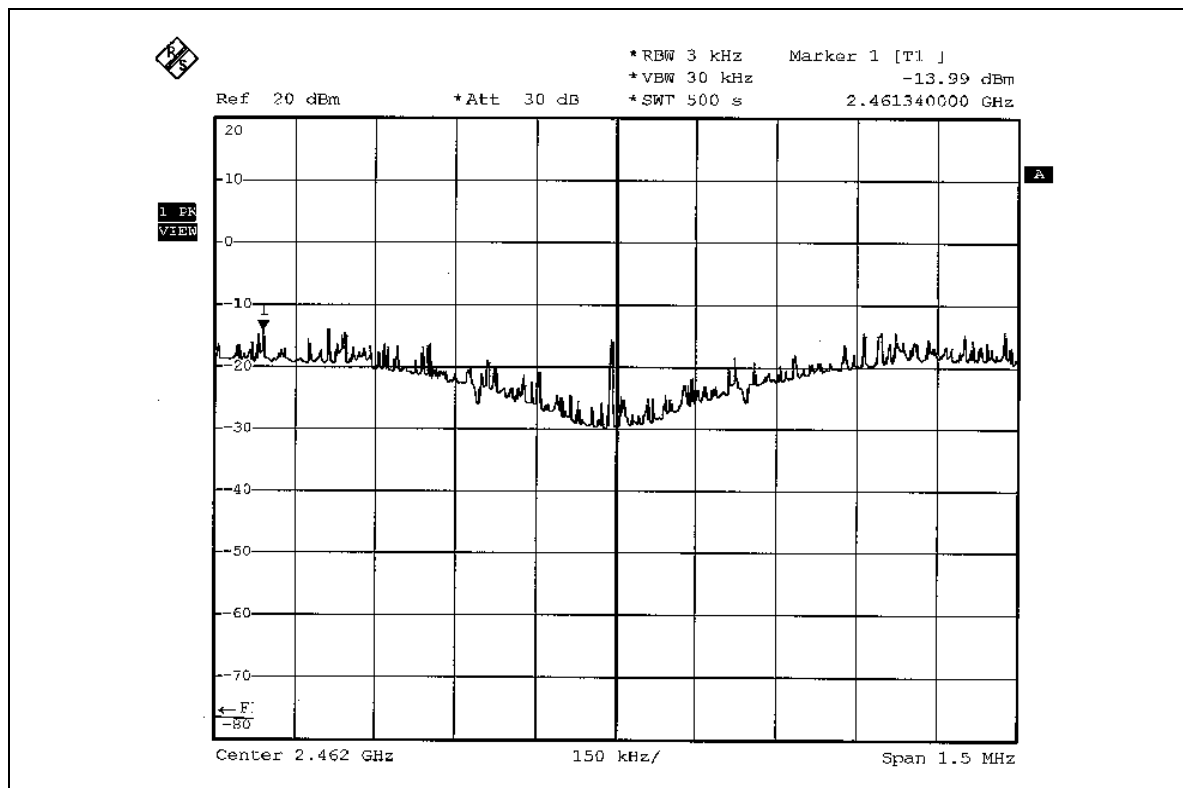



802.11g OFDM MODULATION

MODULATION TYPE	BPSK	TRANSFER RATE	6Mbps
INPUT POWER (SYSTEM)	120Vac, 60 Hz	ENVIRONMENTAL CONDITIONS	23deg. C, 63%RH, 991hPa
TESTED BY	Long Chen		

CHANNEL	CHANNEL FREQUENCY (MHz)	RF POWER LEVEL IN 3kHz BW (dBm)	MAXIMUM LIMIT (dBm)	PASS/FAIL
1	2412	-14.39	8	PASS
6	2437	-14.25	8	PASS
11	2462	-14.28	8	PASS

CH1

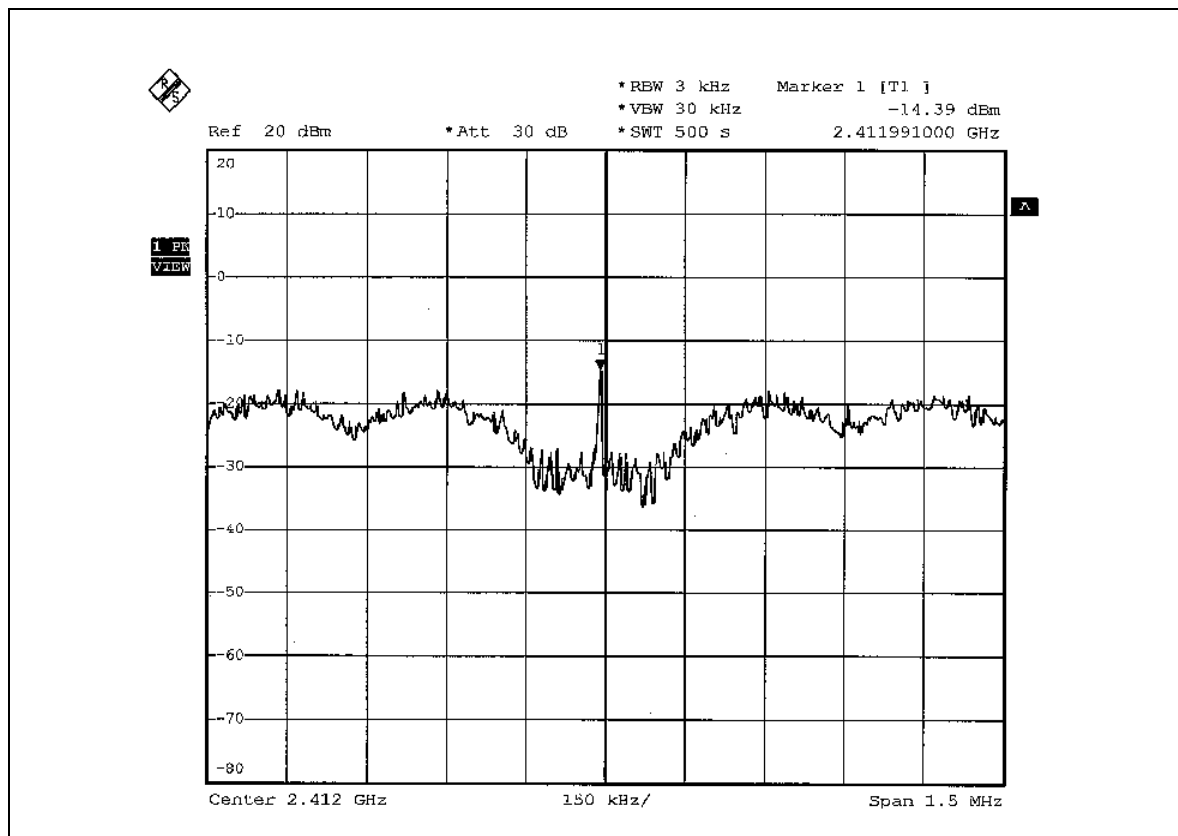

CH6

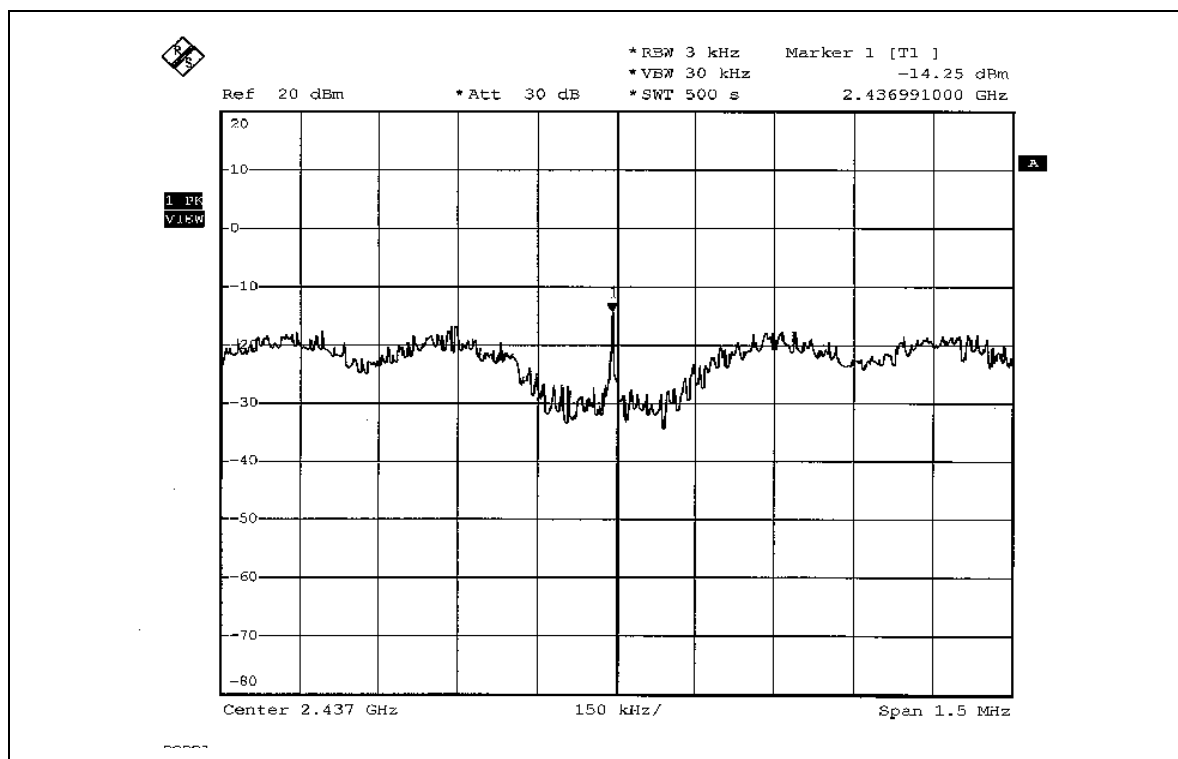



4.6 BAND EDGES MEASUREMENT

4.6.1 LIMITS OF BAND EDGES MEASUREMENT

Below -20dB of the highest emission level of operating band (in 100kHz Resolution Bandwidth).

4.6.2 TEST INSTRUMENTS

DESCRIPTION & MANUFACTURER	MODEL NO.	SERIAL NO.	CALIBRATED UNTIL
R&S SPECTRUM ANALYZER	FSEK30	100049	Aug. 14, 2006

NOTE: The calibration interval of the above test instruments is 12 months and the calibrations are traceable to NML/ROC and NIST/USA.

4.6.3 TEST PROCEDURE

The transmitter output was connected to the spectrum analyzer via a low lose cable. Set both RBW and VBW of spectrum analyzer to 100 kHz and 100 kHz with suitable frequency span including 100 MHz bandwidth from band edge. The band edges was measured and recorded.

The spectrum plots (Peak RBW=VBW=100kHz; Average RBW=1MHz, VBW=10Hz) are attached on the following pages.

4.6.4 DEVIATION FROM TEST STANDARD

No deviation

4.6.5 EUT OPERATING CONDITION

Same as Item 4.3.6

4.6.6 TEST RESULTS

The spectrum plots are attached on the following 12 images. D1 line indicates the highest level, and D2 line indicates the 20dB offset below D1. It shows compliance with the requirement in part 15.247(d).

802.11b DSSS MODULATION

NOTE 1:

The band edge emission plot on page 53 show 47.09dBc delta between carrier maximum power and local maximum emission in restrict band (2.3892GHz). The emission of carrier strength list in the test result of channel 1 at the item 4.2.7 is 107.39dBuV/m (Peak), so the maximum field strength in restrict band is $107.39 - 47.09 = 60.30$ dBuV/m, which is under 74dBuV/m limit.

The band edge emission plot on page 53 show 56.86dBc delta between carrier maximum power and local maximum emission in restrict band (2.3900GHz). The emission of carrier strength list in the test result of channel 1 at the item 4.2.7 is 104.34dBuV/m (Average), so the maximum field strength in restrict band is $104.34 - 56.86 = 47.48$ dBuV/m, which is under 54dBuV/m limit.

NOTE 2:

The band edge emission plot on the page 54 show 49.09dBc delta between carrier maximum power and local maximum emission in restrict band (2.4881GHz). The emission of carrier strength list in the test result of channel 11 at the item 4.2.7 is 107.04BuV/m (Peak), so the maximum field strength in restrict band is $107.04 - 49.09 = 57.95$ dBuV/m, which is under 74dBuV/m limit.

The band edge emission plot on the page 55 show 56.78dBc delta between carrier maximum power and local maximum emission in restrict band (2.4835GHz). The emission of carrier strength list in the test result of channel 11 at the item 4.2.7 is 103.90dBuV/m (Average), so the maximum field strength in restrict band is $103.90 - 56.78 = 47.12$ dBuV/m, which is under 54dBuV/m limit.

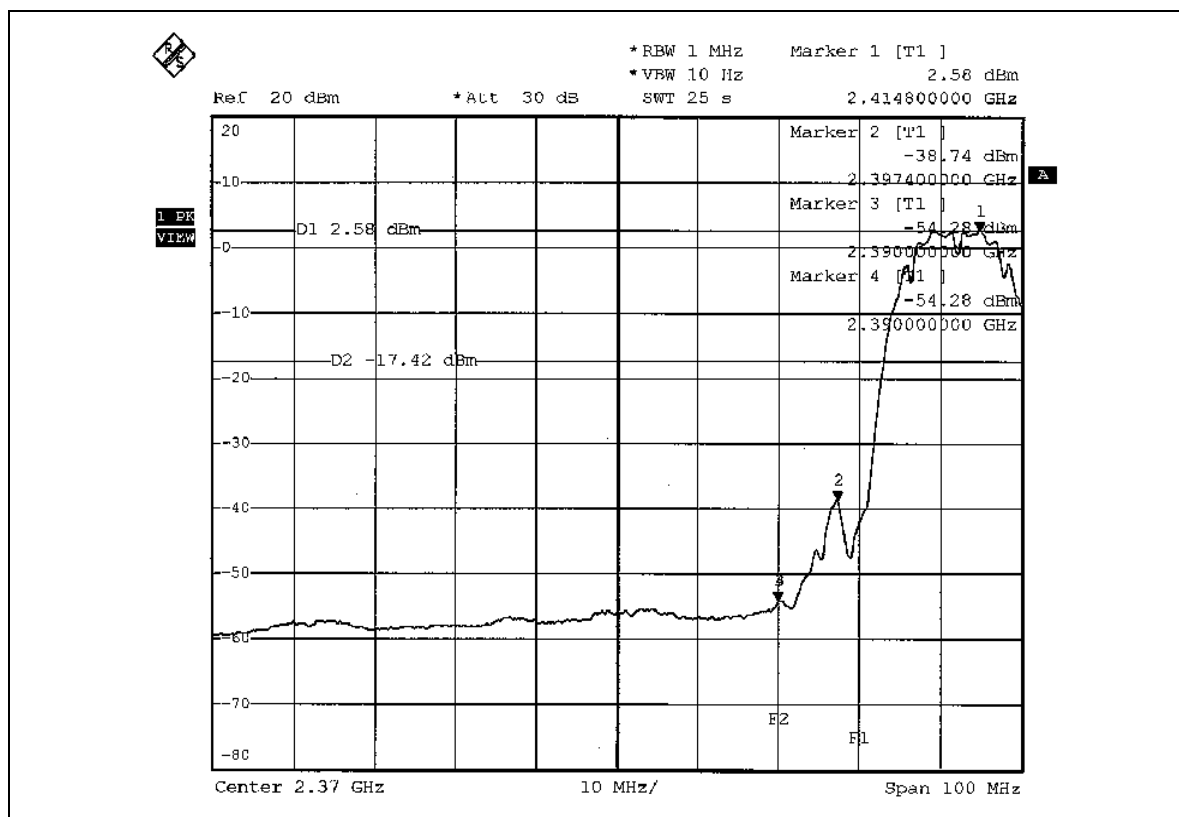
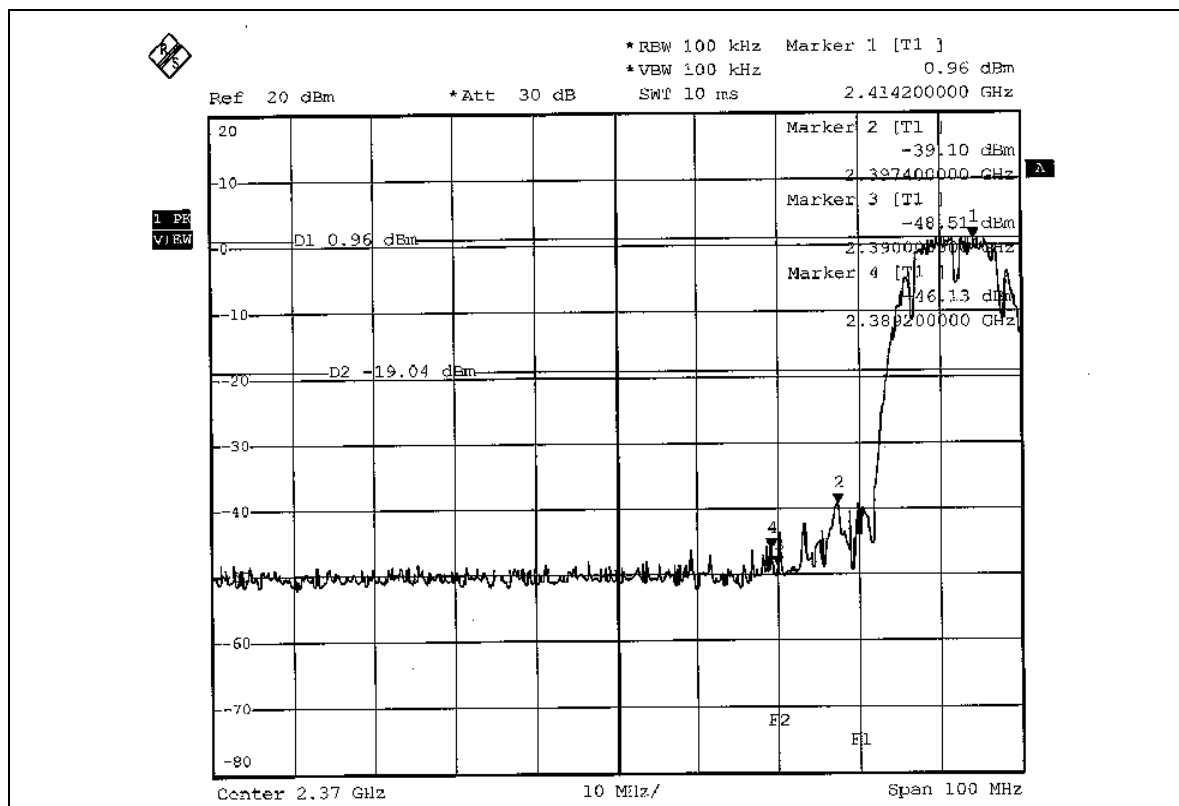

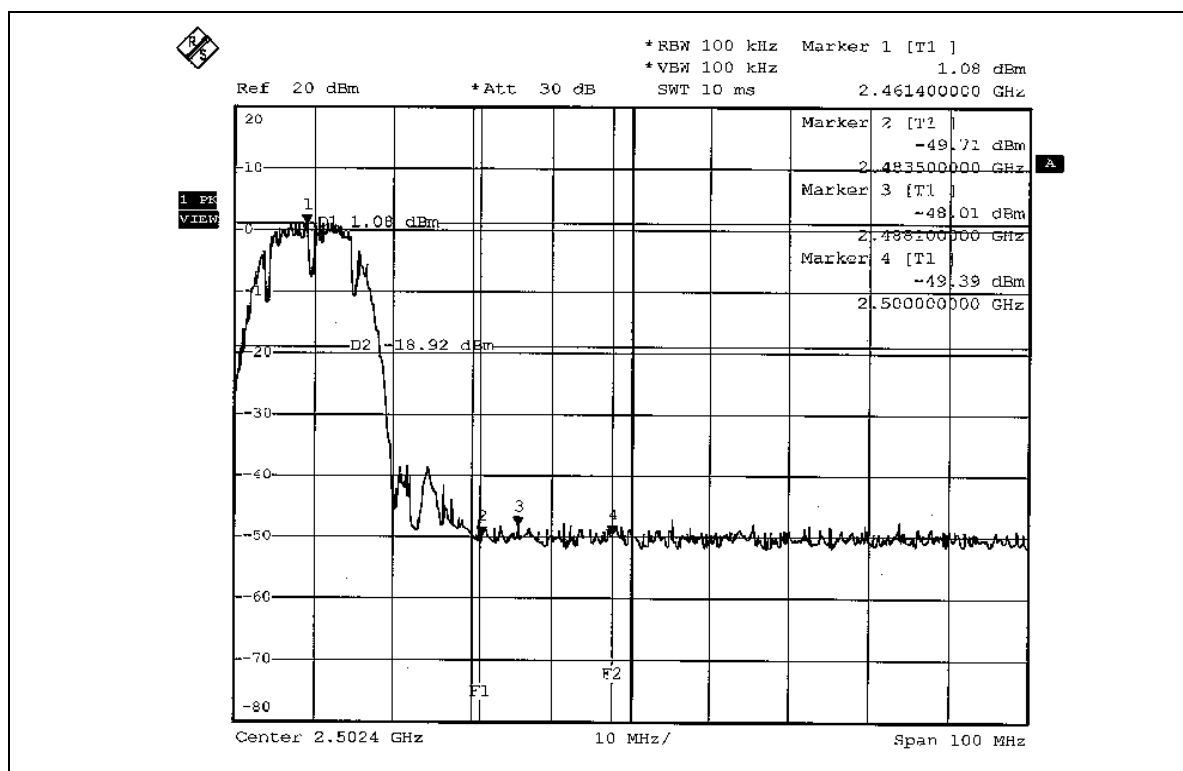
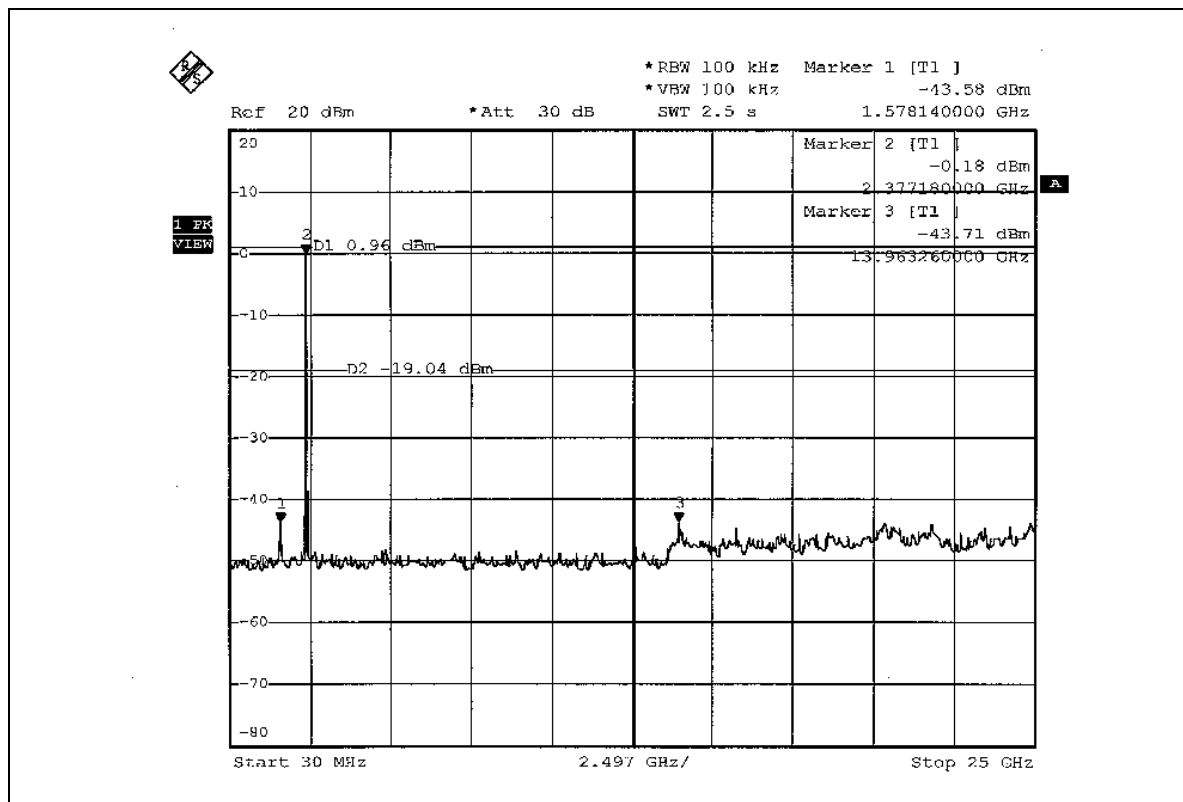

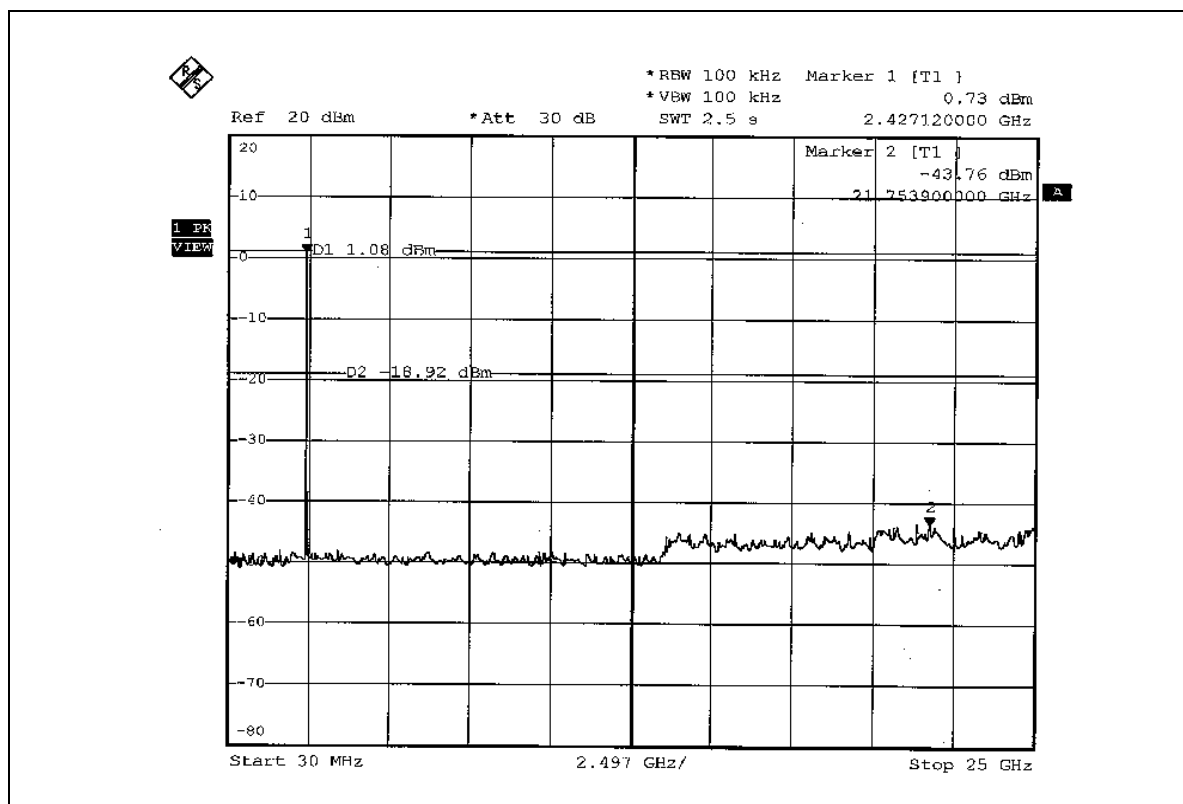
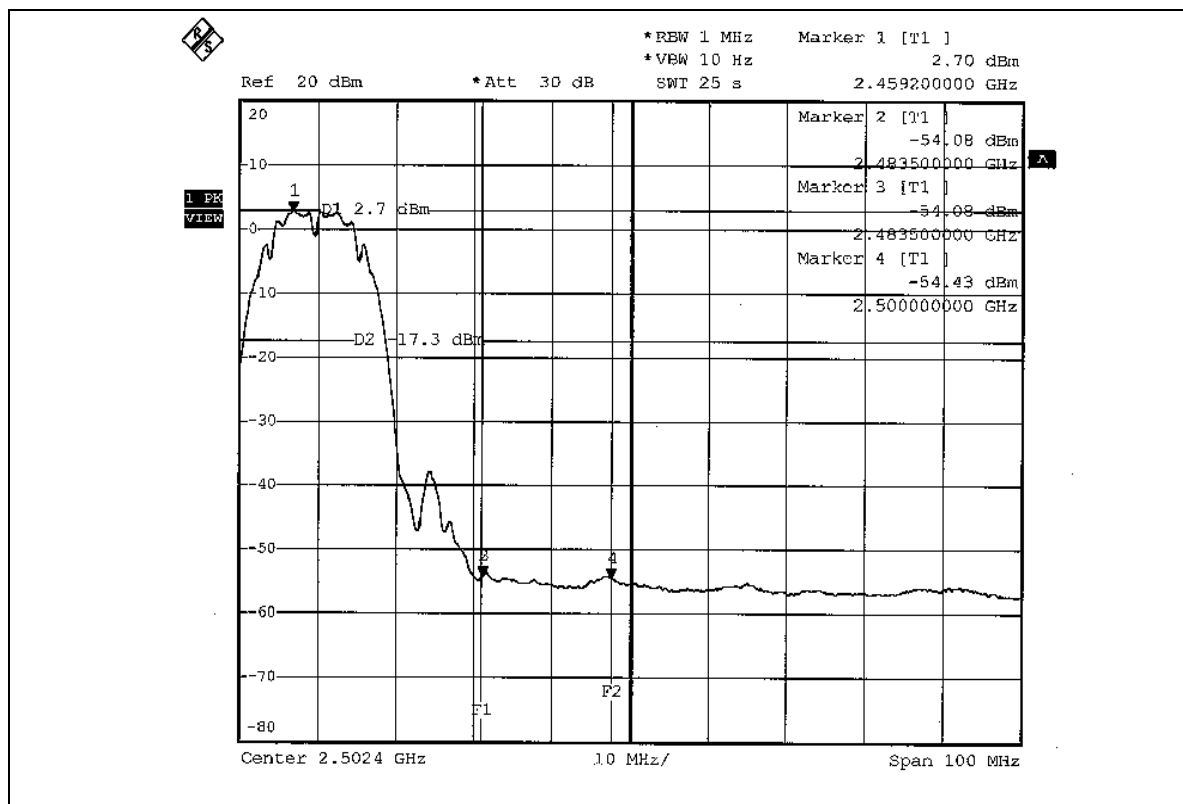

802.11g OFDM MODULATION

NOTE 1:

The band edge emission plot on page 57 show 46.98dBc delta between carrier maximum power and local maximum emission in restrict band (2.3700GHz). The emission of carrier strength list in the test result of channel 1 at the item 4.2.7 is 109.58dBuV/m (Peak), so the maximum field strength in restrict band is $109.58 - 46.98 = 62.60$ dBuV/m, which is under 74dBuV/m limit.

The band edge emission plot on page 57 show 52.69dBc delta between carrier maximum power and local maximum emission in restrict band (2.3900GHz). The emission of carrier strength list in the test result of channel 1 at the item 4.2.7 is 99.48dBuV/m (Average), so the maximum field strength in restrict band is $99.48 - 52.69 = 46.79$ dBuV/m, which is under 54dBuV/m limit.

NOTE 2:

The band edge emission plot on the page 58 show 46.68dBc delta between carrier maximum power and local maximum emission in restrict band (2.4933GHz). The emission of carrier strength list in the test result of channel 11 at the item 4.2.7 is 110.07dBuV/m (Peak), so the maximum field strength in restrict band is $110.07 - 46.68 = 57.38$ dBuV/m, which is under 74dBuV/m limit.

The band edge emission plot on the page 59 show 51.55dBc delta between carrier maximum power and local maximum emission in restrict band (2.4835GHz). The emission of carrier strength list in the test result of channel 11 at the item 4.2.7 is 98.93dBuV/m (Average), so the maximum field strength in restrict band is $98.93 - 51.55 = 47.38$ dBuV/m, which is under 54dBuV/m limit.

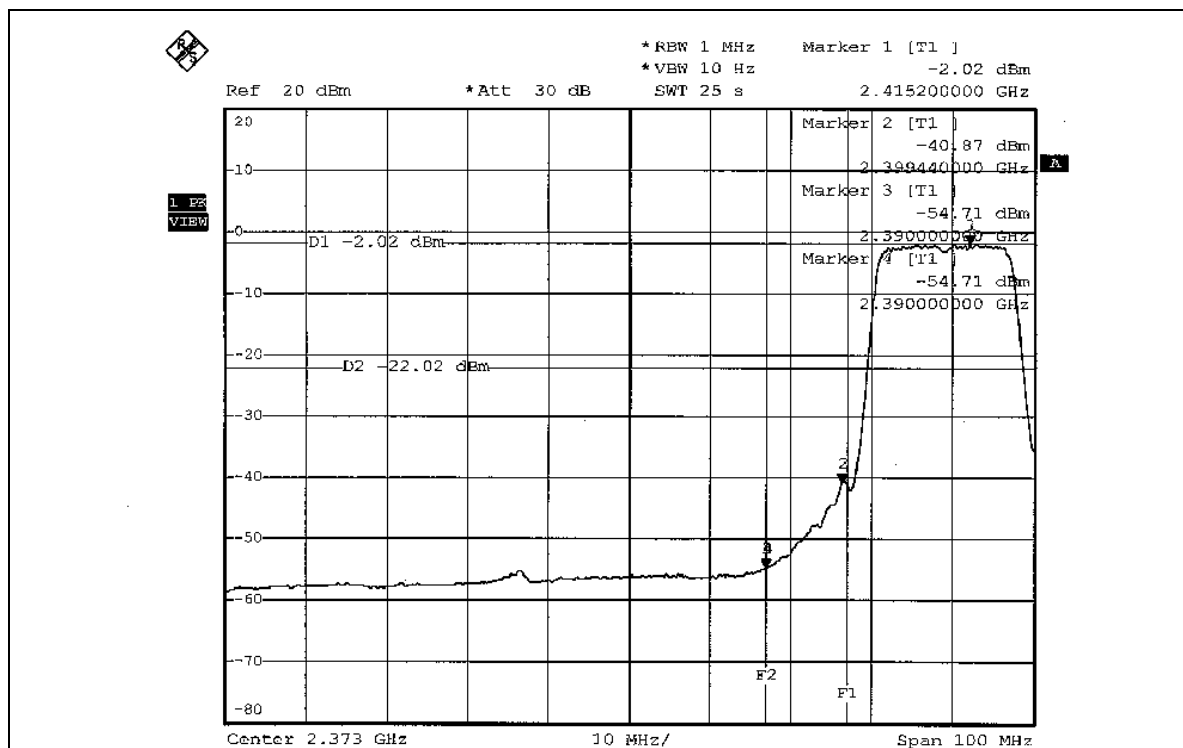
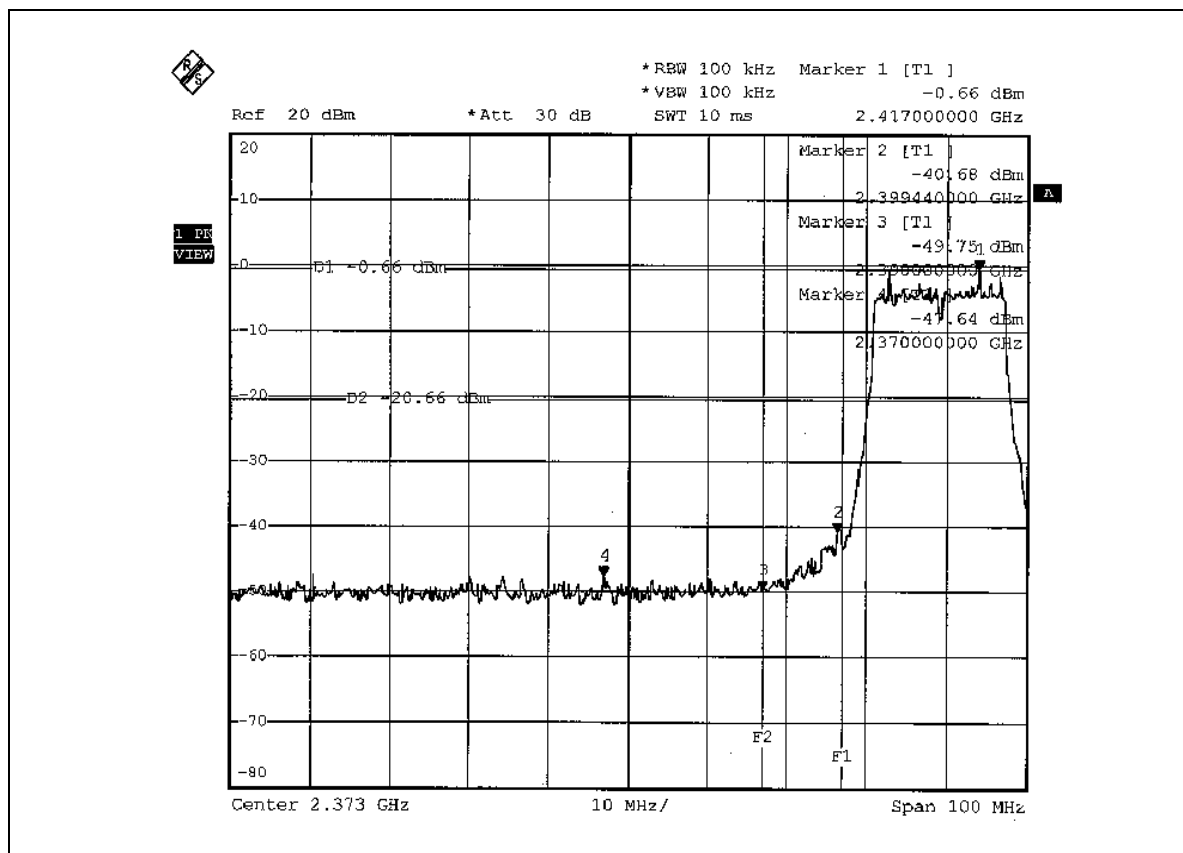

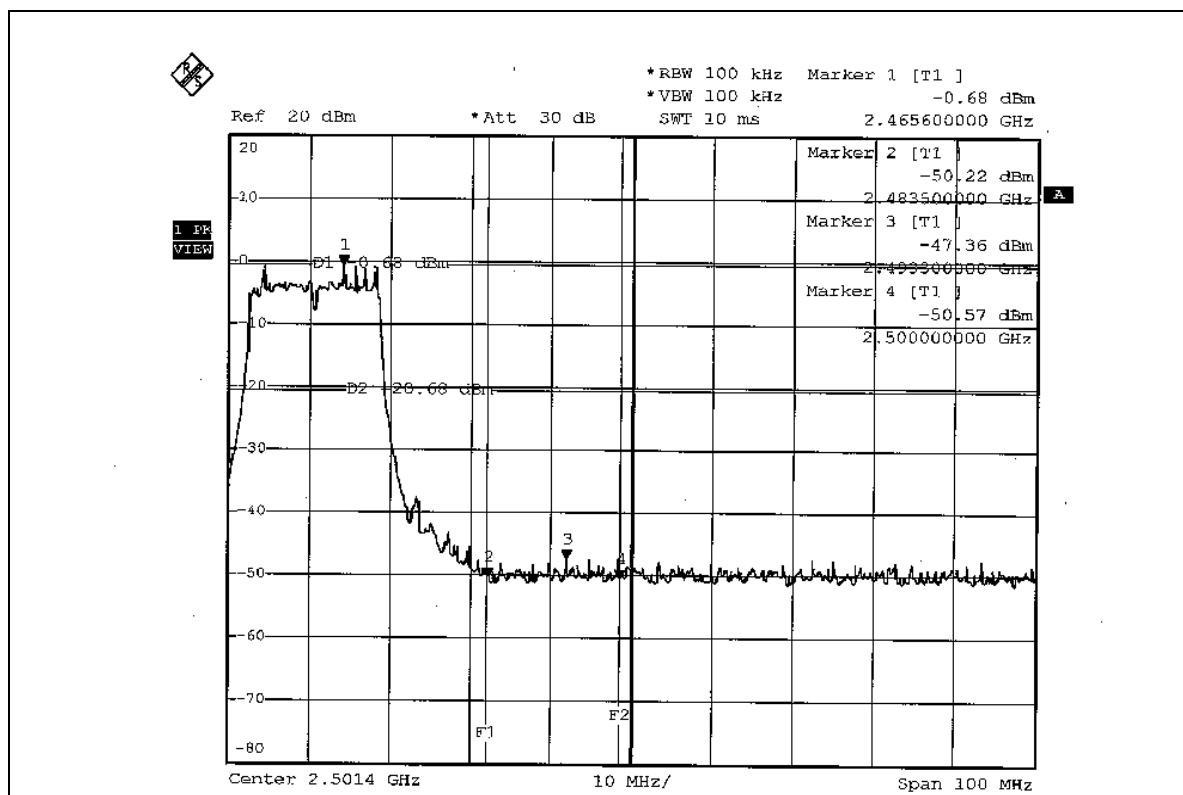
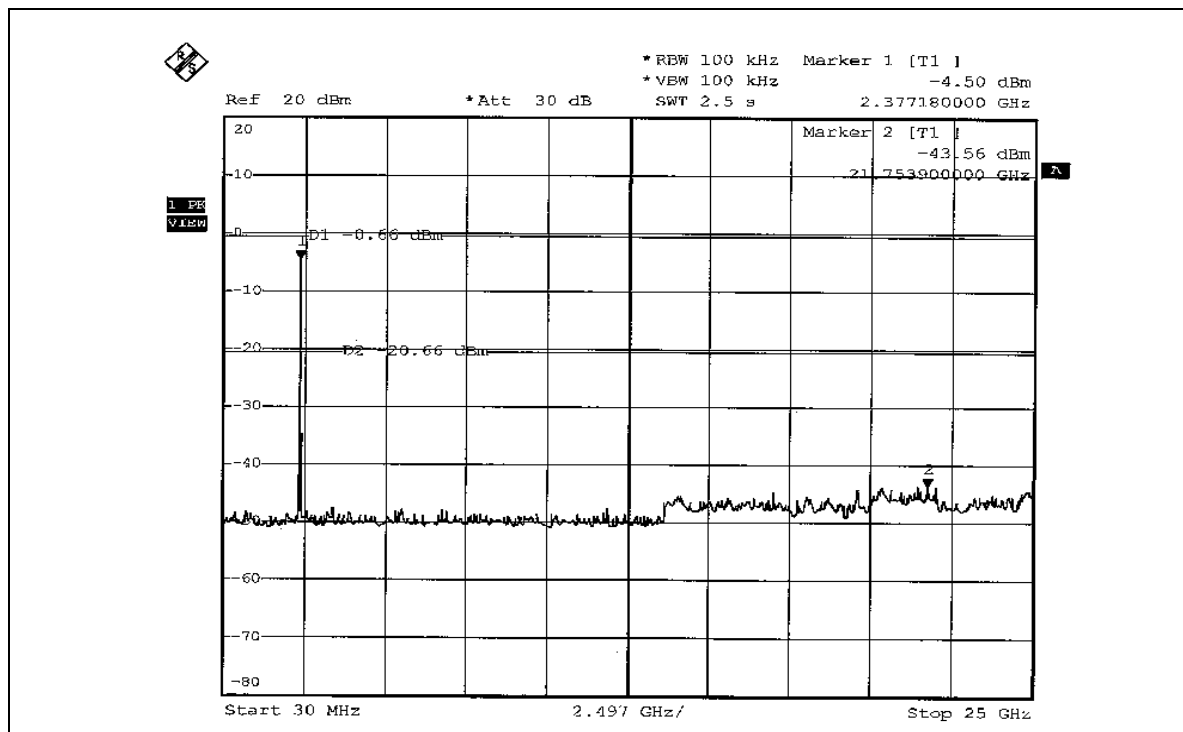

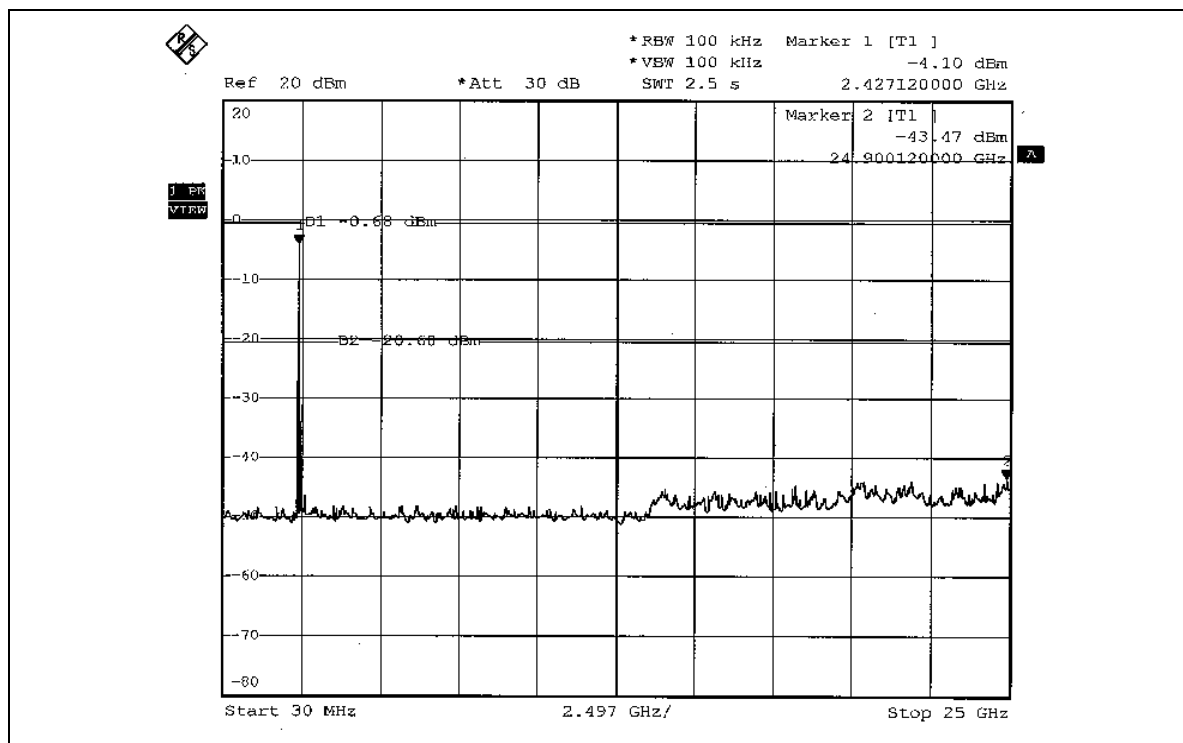
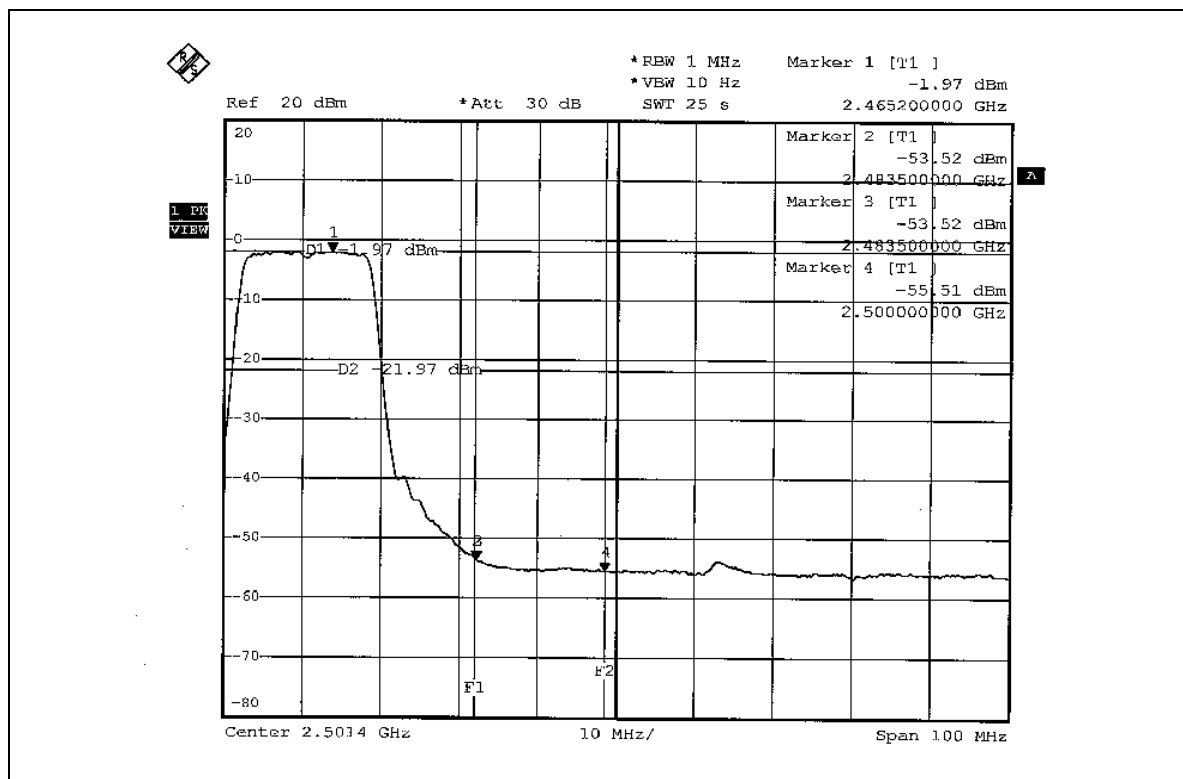



4.7 ANTENNA REQUIREMENT

4.7.1 STANDARD APPLICABLE

For intentional device, according to FCC 47 CFR Section 15.203, an intentional radiator shall be designed to ensure that no antenna other than that furnished by the responsible party shall be used with the device. And according to FCC 47 CFR Section 15.247 (b), if transmitting antennas of directional gain greater than 6dBi are used, the power shall be reduced by the amount in dB that the directional gain of the antenna exceeds 6dBi.

4.7.2 ANTENNA CONNECTED CONSTRUCTION

The antenna used in this product is Dipole antenna with Reverse SMA antenna connector. The maximum Gain of the antenna is 2.48dBi.

5. PHOTOGRAPHS OF THE TEST CONFIGURATION

CONDUCTED EMISSION TEST



RADIATED EMISSION TEST

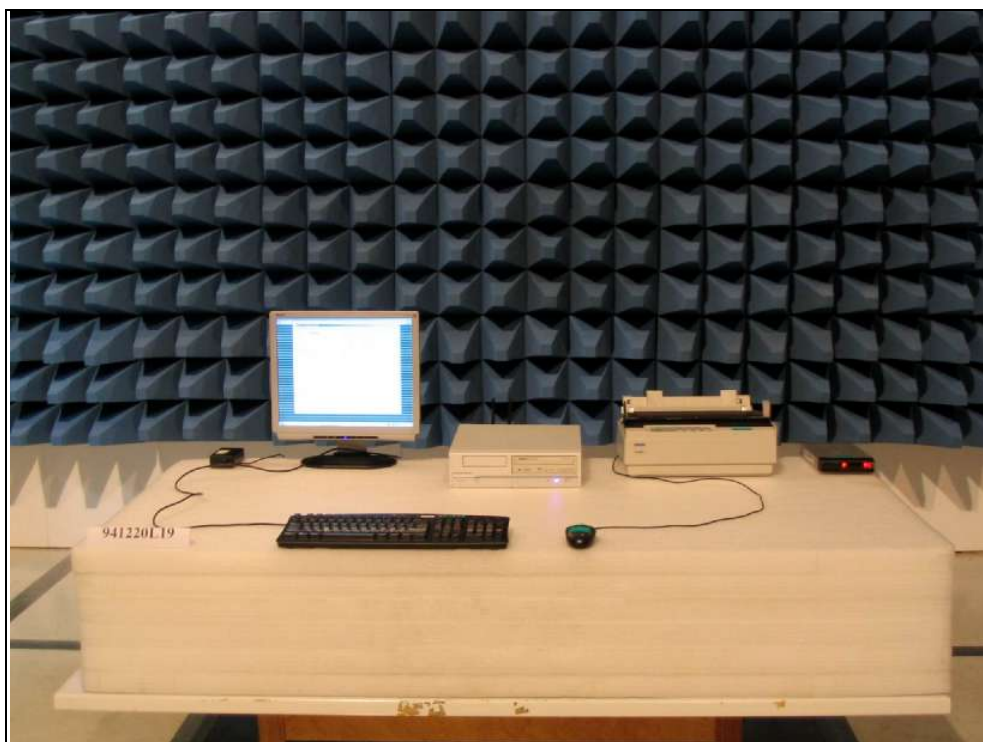



6. INFORMATION ON THE TESTING LABORATORIES

We, ADT Corp., were founded in 1988 to provide our best service in EMC, Radio, Telecom and Safety consultation. Our laboratories are accredited and approved by the following approval agencies according to ISO/IEC 17025.

USA	FCC, UL, A2LA
Germany	TUV Rheinland
Japan	VCCI
Norway	NEMKO
Canada	INDUSTRY CANADA , CSA
R.O.C.	CNLA, BSMI, DGT
Netherlands	Telefication
Singapore	PSB , GOST-ASIA(MOU)
Russia	CERTIS(MOU)

Copies of accreditation certificates of our laboratories obtained from approval agencies can be downloaded from our web site:

www.adt.com.tw/index.5/phtml. If you have any comments, please feel free to contact us at the following:

Linko EMC/RF Lab:

Tel: 886-2-26052180

Fax: 886-2-26051924

Hsin Chu EMC/RF Lab:

Tel: 886-3-5935343

Fax: 886-3-5935342

Hwa Ya EMC/RF/Safety Telecom Lab:

Tel: 886-3-3183232

Fax: 886-3-3185050

Linko RF Lab.

Tel: 886-3-3270910

Fax: 886-3-3270892

Web Site: www.adt.com.tw

The address and road map of all our labs can be found in our web site also.



APPENDIX-A

MODIFICATIONS RECORDERS FOR ENGINEERING CHANGES TO THE EUT BY THE LAB

No any modifications are made to the EUT by the lab during the test.