

FCC Test Report

FCC ID : RYK-WPEQ256ACNI
Equipment : 802.11ac/b/g/n Mini PCIe Module
Model No. : WPEQ-256ACNI
Brand Name : SparkLAN
Applicant : SparkLAN Communications, Inc.
Address : 8F., No.257, Sec. 2, Tiding Blvd., Neihu
District, Taipei City 11493, Taiwan.
Standard : 47 CFR FCC Part 15.407
Received Date : Nov. 20, 2015
Tested Date : Nov. 20, 2015 ~ Jan. 15, 2016

We, International Certification Corp., would like to declare that the tested sample has been evaluated and in compliance with the requirement of the above standards. The test results contained in this report refer exclusively to the product. It may be duplicated completely for legal use with the approval of the applicant. It shall not be reproduced except in full without the written approval of our laboratory.

Approved & Reviewed by:



Gary Chang / Manager



Table of Contents

1	GENERAL DESCRIPTION	5
1.1	Information.....	5
1.2	Local Support Equipment List	8
1.3	Test Setup Chart	8
1.4	The Equipment List	9
1.5	Testing Applied Standards	10
1.6	Measurement Uncertainty	10
2	TEST CONFIGURATION	11
2.1	Testing Condition	11
2.2	The Worst Test Modes and Channel Details	12
3	TRANSMITTER TEST RESULTS.....	13
3.1	Conducted Emissions.....	13
3.2	Emission Bandwidth	18
3.3	RF Output Power	21
3.4	Peak Power Spectral Density	23
3.5	Transmitter Radiated and Band Edge Emissions	27
3.6	Frequency Stability.....	70
4	TEST LABORATORY INFORMATION	73

Release Record

Report No.	Version	Description	Issued Date
FR610401AN	Rev. 01	Initial issue	Mar. 15, 2016

Summary of Test Results

FCC Rules	Test Items	Measured	Result
15.207	Conducted Emissions	[dBuV]: 0.153MHz 51.96 (Margin -13.86dB) - QP	Pass
15.407(b) 15.209	Radiated Emissions	[dBuV/m at 3m]: 6986.00MHz 68.07 (Margin -0.13dB) - PK	Pass
15.407(a)	Emission Bandwidth	Meet the requirement of limit	Pass
15.407(e)	6dB bandwidth	Meet the requirement of limit	Pass
15.407(a)	RF Output Power	Max Power [dBm]: 5150-5250MHz: 22.78 5725-5850MHz: 18.26	Pass
15.407(a)	Peak Power Spectral Density	Meet the requirement of limit	Pass
15.407(g)	Frequency Stability	Meet the requirement of limit	Pass
15.203	Antenna Requirement	Meet the requirement of limit	Pass

1 General Description

1.1 Information

1.1.1 Specification of the Equipment under Test (EUT)

RF General Information					
Frequency Range (MHz)	IEEE Std. 802.11	Ch. Freq. (MHz)	Channel Number	Transmit Chains (N _{TX})	Data Rate / MCS
5150-5250	a	5180-5240	36-48 [4]	2	6-54 Mbps
5150-5250	n (HT20)	5180-5240	36-48 [4]	2	MCS 0-15
5150-5250	n (HT40)	5190-5230	38-46 [2]	2	MCS 0-15
5150-5250	ac (VHT20)	5180-5240	36-48 [4]	2	MCS 0-8
5150-5250	ac (VHT40)	5190-5230	38-46 [2]	2	MCS 0-9
5150-5250	ac (VHT80)	5210	42 [1]	2	MCS 0-9

Note 1: RF output power specifies that Maximum Conducted Output Power.
 Note 2: 802.11a/n/ac uses a combination of OFDM-BPSK, QPSK, 16QAM, 64QAM, 256QAM modulation.

RF General Information					
Frequency Range (MHz)	IEEE Std. 802.11	Ch. Freq. (MHz)	Channel Number	Transmit Chains (N _{TX})	Data Rate / MCS
5725-5850	a	5745-5825	149-165 [5]	2	6-54 Mbps
5725-5850	n (HT20)	5745-5825	149-165 [5]	2	MCS 0-15
5725-5850	n (HT40)	5755-5795	151-159 [2]	2	MCS 0-15
5725-5850	ac (VHT20)	5745-5825	149-165 [5]	2	MCS 0-8
5725-5850	ac (VHT40)	5755-5795	151-159 [2]	2	MCS 0-9
5725-5850	ac (VHT80)	5775	155 [1]	2	MCS 0-9

Note 1: RF output power specifies that Maximum Conducted Output Power.
 Note 2: 802.11a/n/ac uses a combination of OFDM-BPSK, QPSK, 16QAM, 64QAM, 256QAM modulation.

1.1.2 Antenna Details

Ant. No.	Brand	Model	Type	Connector	Antenna Gain (dBi)		
					2400~2483.5MHz	5150~5250MHz	5725~5850MHz
1	Long Cheng Tech. Int'l Co., Ltd.	DB B-SMA THIN PADDLE Ant. GEC6200	Dipole	RP-SMA	3	5	5
2	Wanshih Electronic Co., Ltd.	R3410110203	Dipole	RP-SMA	2	2	2
3	Long Cheng Tech. Int'l Co., Ltd.	FDBX_F41150-I3B	Dipole	IPEX	2	2.5	2.5

Note: Antenna 1 with highest gain was chosen for final test

1.1.3 Power Supply Type of Equipment under Test (EUT)

Power Supply Type	3.3Vdc from host
--------------------------	------------------

1.1.4 Accessories

N/A

1.1.5 Channel List

For Frequency band 5150-5250 MHz			
802.11 a / HT20 / VHT20		HT40 / VHT40	
Channel	Frequency(MHz)	Channel	Frequency(MHz)
36	5180	38	5190
40	5200	46	5230
44	5220	VHT 80	
48	5240	42	5210

For Frequency band 5725~5850 MHz			
802.11 a / HT20 / VHT20		HT40 / VHT40	
Channel	Frequency(MHz)	Channel	Frequency(MHz)
149	5745	151	5755
153	5765	159	5795
157	5785	VHT80	
161	5805	155	5775
165	5825	---	---

1.1.6 Test Tool and Duty Cycle

Test Tool	ART2-GUI, V2.3		
Duty Cycle and Duty Factor	Mode	Duty cycle (%)	Duty factor (dB)
	11a	100.00%	0.00
	VHT20	100.00%	0.00
	VHT40	100.00%	0.00
	VHT80	100.00%	0.00

1.1.7 Power Setting

For Frequency band 5150-5250 MHz		
Modulation Mode	Test Frequency (MHz)	Power Set
11a	5180	16.5
11a	5200	18
11a	5240	20
HT20	5180	16.5
HT20	5200	17
HT20	5240	20
HT40	5190	13
HT40	5230	19
VHT20	5180	16.5
VHT20	5200	17
VHT20	5240	20
VHT40	5190	13
VHT40	5230	19
VHT80	5210	12

For Frequency band 5725~5850 MHz		
Modulation Mode	Test Frequency (MHz)	Power Set
11a	5745	16
11a	5785	15
11a	5825	14.5
HT20	5745	15.5
HT20	5785	15
HT20	5825	14.5
HT40	5755	14.5
HT40	5795	15
VHT20	5745	15.5
VHT20	5785	15
VHT20	5825	14.5
VHT40	5755	14.5
VHT40	5795	15
VHT80	5775	12

1.2 Local Support Equipment List

Support Equipment List					
No.	Equipment	Brand	Model	FCC ID	Signal cable / Length (m)
1	Notebook	DELL	Latitude E6430	DoC	---
2	Fixture	---	---	---	---

Note: Fixture was provided by applicant.

1.3 Test Setup Chart

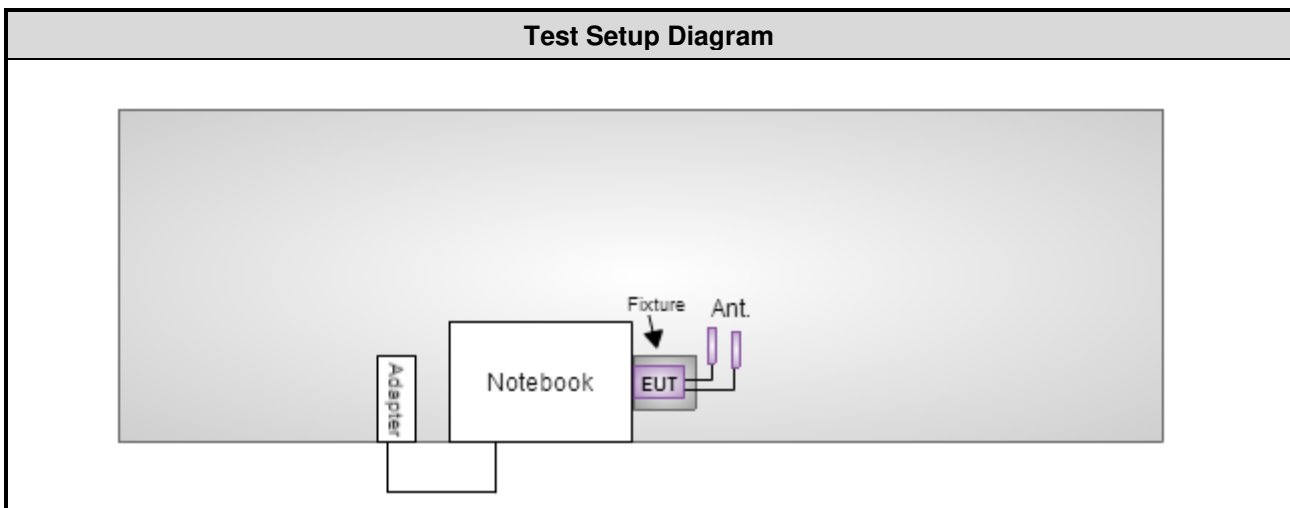

1.4 The Equipment List

Test Item	Conducted Emission				
Test Site	Conduction room 1 / (CO01-WS)				
Tested Date	Jan. 14, 2016				
Instrument	Manufacturer	Model No.	Serial No.	Calibration Date	Calibration Until
EMC Receiver	R&S	ESCS 30	100169	Oct. 21, 2015	Oct. 20, 2016
LISN	SCHWARZBECK	Schwarzbeck 8127	8127-667	Nov. 13, 2015	Nov. 12, 2016
LISN (Support Unit)	SCHWARZBECK	Schwarzbeck 8127	8127-666	Nov. 26, 2015	Nov. 25, 2016
RF Cable-CON	EMC	EMCCFD300-BM-BM-6000	50821	Dec. 21, 2015	Dec. 20, 2016
50 ohm terminal (Support Unit)	NA	50	04	Apr. 15, 2015	Apr. 14, 2016
Measurement Software	AUDIX	e3	6.120210k	NA	NA

Note: Calibration Interval of instruments listed above is one year.

Test Item	Radiated Emission				
Test Site	966 chamber 2 / (03CH02-WS)				
Tested Date	Nov. 27 ~ Dec. 08, 2015				
Instrument	Manufacturer	Model No.	Serial No.	Calibration Date	Calibration Until
Spectrum Analyzer	R&S	FSV40	101499	Dec. 31, 2014	Dec. 30, 2015
Receiver	R&S	ESR3	101657	Jan. 15, 2015	Jan. 14, 2016
Bilog Antenna	SCHWARZBECK	VULB9168	VULB9168-523	Nov. 09, 2015	Nov. 08, 2016
Horn Antenna 1G-18G	SCHWARZBECK	BBHA 9120 D	BBHA 9120 D 1095	Oct. 07, 2015	Oct. 06, 2016
Horn Antenna 18G-40G	SCHWARZBECK	BBHA 9170	BBHA 9170517	Nov. 04, 2015	Nov. 03, 2016
Loop Antenna	R&S	HFH2-Z2	11900	Nov. 16, 2015	Nov. 15, 2016
Preamplifier	Burgeon	BPA-530	100218	Nov. 03, 2015	Nov. 02, 2016
Preamplifier	Agilent	83017A	MY39501309	Sep. 22, 2015	Sep. 21, 2016
Preamplifier	EMC	EMC184045B	980192	Sep. 01, 2015	Aug. 31, 2016
RF Cable	HUBER+SUHNER	SUCOFLEX104	MY16140/4	Dec. 16, 2014	Dec. 15, 2015
RF Cable	HUBER+SUHNER	SUCOFLEX104	MY16018/4	Dec. 16, 2014	Dec. 15, 2015
RF Cable	HUBER+SUHNER	SUCOFLEX104	MY16015/4	Dec. 16, 2014	Dec. 15, 2015
LF cable 3M	Woken	CFD400NL-LW	CFD400NL-003	Dec. 16, 2014	Dec. 15, 2015
LF cable 10M	EMCC	CFD400-E	CFD400-001	Jun. 17, 2015	Jun. 16, 2016
Measurement Software	AUDIX	e3	6.120210g	NA	NA

Note: Calibration Interval of instruments listed above is one year.

Test Item	RF Conducted				
Test Site	(TH01-WS)				
Tested Date	Jan. 15, 2016				
Instrument	Manufacturer	Model No.	Serial No.	Calibration Date	Calibration Until
Spectrum Analyzer	R&S	FSV40	101063	Feb. 03, 2015	Feb. 02, 2016
TEMP&HUMIDITY CHAMBER	GIANT FORCE	GCT-225-40-SP-SD	MAF1212-002	Nov. 27, 2015	Nov. 26, 2016
Power Meter	Anritsu	ML2495A	1241002	Sep. 21, 2015	Sep. 20, 2016
Power Sensor	Anritsu	MA2411B	1207366	Sep. 21, 2015	Sep. 20, 2016
DC POWER SOURCE	GW INSTRON	GPC-3060D	EM884797	Oct. 20, 2015	Oct. 19, 2016
Measurement Software	Sporton	Sporton_1	1.3.30	NA	NA
Note: Calibration Interval of instruments listed above is one year.					

1.5 Testing Applied Standards

According to the specification of EUT, the EUT must comply with following standards and KDB documents.

47 CFR FCC Part 15.407

ANSI C63.10-2013

FCC KDB 789033 D02 General UNII Test Procedures New Rules v01r01

FCC KDB 644545 D03 Guidance for IEEE 802.11ac New Rules v01

FCC KDB 662911 D01 Multiple Transmitter Output v02r01

FCC KDB 412172 D01 Determining ERP and EIRP v01r01

1.6 Measurement Uncertainty

ISO/IEC 17025 requires that an estimate of the measurement uncertainties associated with the emissions test results be included in the report. The measurement uncertainties given below are based on a 95% confidence level (based on a coverage factor (k=2))

Measurement Uncertainty	
Parameters	Uncertainty
Bandwidth	±34.134 Hz
Conducted power	±0.808 dB
Frequency error	±34.134 Hz
Power density	±0.463 dB
Conducted emission	±2.670 dB
AC conducted emission	±2.92 dB
Radiated emission ≤ 1GHz	±3.87 dB
Radiated emission > 1GHz	±5.60 dB
Time	±0.1%
Temperature	±0.6 °C

2 Test Configuration

2.1 Testing Condition

Test Item	Test Site	Ambient Condition	Tested By
AC Conduction	CO01-WS	17°C / 61%	Sky Huang
Radiated Emissions	03CH02-WS	20-23°C / 61-65%	Warren Lee Anderson Hung Morgan Chen
RF Conducted	TH01-WS	22°C / 61-64%	Alex Huang

➤ FCC site registration No.: 657002

➤ IC site registration No.: 10807A-2

2.2 The Worst Test Modes and Channel Details

For Frequency band 5150-5250 MHz				
Test item	Modulation Mode	Test Frequency (MHz)	Data Rate (Mbps) / MCS	Test Configuration
Conducted Emissions	VHT20	5240	MCS 0	---
Radiated Emissions ≤ 1 GHz	VHT20	5240	MCS 0	---
RF Output Power	11a	5180 / 5200 / 5240	6 Mbps	---
	HT20	5180 / 5200 / 5240	MCS 0	
	HT40	5190 / 5230	MCS 0	
	VHT20	5180 / 5200 / 5240	MCS 0	
	VHT40	5190 / 5230	MCS 0	
	VHT80	5210	MCS 0	
Radiated Emissions > 1 GHz Emission Bandwidth Peak Power Spectral Density	11a	5180 / 5200 / 5240	6 Mbps	---
	VHT20	5180 / 5200 / 5240	MCS 0	
	VHT40	5190 / 5230	MCS 0	
	VHT80	5210	MCS 0	
Frequency Stability	Un-modulation	5200	---	---

For Frequency band 5725-5850 MHz				
Test item	Modulation Mode	Test Frequency (MHz)	Data Rate (Mbps) / MCS	Test Configuration
Conducted Emissions	11a	5745	6 Mbps	---
Radiated Emissions ≤ 1 GHz	11a	5745	6 Mbps	---
RF Output Power	11a	5745 / 5785 / 5825	6 Mbps	---
	HT20	5745 / 5785 / 5825	MCS 0	
	HT40	5755 / 5795	MCS 0	
	VHT20	5745 / 5785 / 5825	MCS 0	
	VHT40	5755 / 5795	MCS 0	
	VHT80	5775	MCS 0	
Radiated Emissions > 1 GHz Emission Bandwidth 6dB bandwidth Peak Power Spectral Density	11a	5745 / 5785 / 5825	6 Mbps	---
	VHT20	5745 / 5785 / 5825	MCS 0	
	VHT40	5755 / 5795	MCS 0	
	VHT80	5775	MCS 0	
Frequency Stability	Un-modulation	5785	---	---

3 Transmitter Test Results

3.1 Conducted Emissions

3.1.1 Limit of Conducted Emissions

Conducted Emissions Limit		
Frequency Emission (MHz)	Quasi-Peak	Average
0.15-0.5	66 - 56 *	56 - 46 *
0.5-5	56	46
5-30	60	50

Note 1: * Decreases with the logarithm of the frequency.

3.1.2 Test Procedures

1. The device is placed on a test table, raised 80 cm above the reference ground plane. The vertical conducting plane is located 40 cm to the rear of the device.
2. The device is connected to line impedance stabilization network (LISN) and other accessories are connected to other LISN. Measured levels of AC power line conducted emission are across the 50 Ω LISN port.
3. AC conducted emission measurements is made over frequency range from 150 kHz to 30 MHz.
4. This measurement was performed with AC 120V / 60Hz.

3.1.3 Test Setup

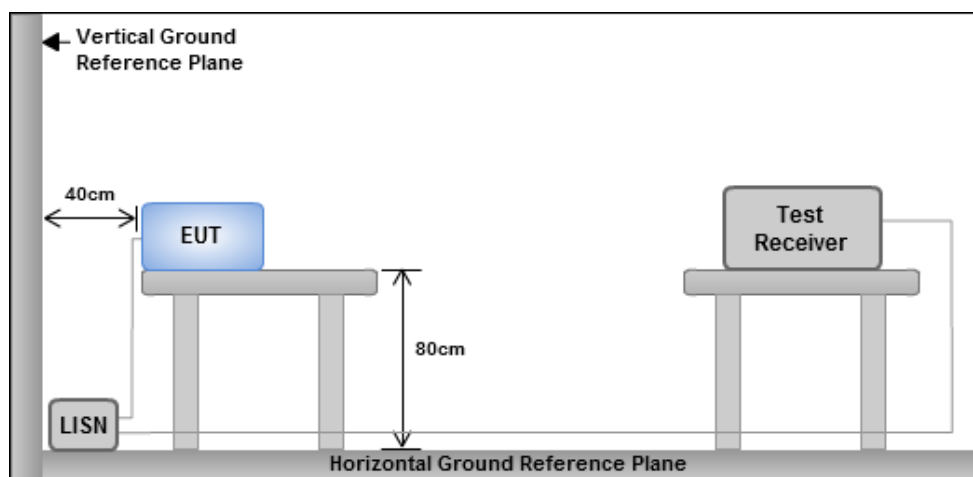

- Note: 1. Support units were connected to second LISN.
 2. Both of LISNs (AMN) are 80 cm from EUT and at least 80 cm from other units and other metal planes

3.1.4 Test Result of Conducted Emissions

Modulation	VHT20	Test Freq. (MHz)	5240
Power Phase	Line		

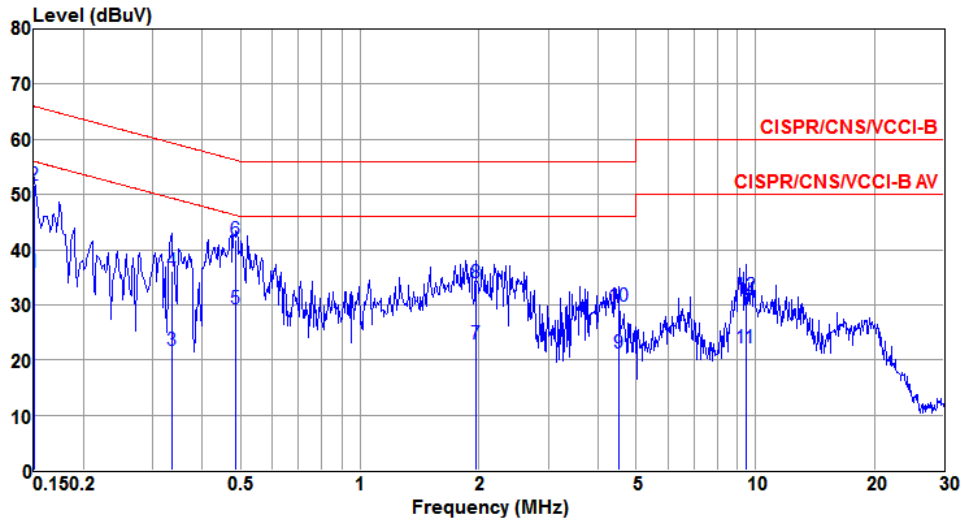

	Freq MHz	Level dBuV	Limit Line dBuV	Over Limit dB	Read Level dBuV	LISN factor dB	cable loss dB	Remark
1	0.151	35.98	55.96	-19.98	35.85	0.11	0.02	Average
2@	0.151	51.67	65.96	-14.29	51.54	0.11	0.02	QP
3	0.334	21.81	49.35	-27.54	21.66	0.12	0.03	Average
4	0.334	36.02	59.35	-23.33	35.87	0.12	0.03	QP
5	0.486	29.27	46.23	-16.96	29.10	0.13	0.04	Average
6	0.486	41.86	56.23	-14.37	41.69	0.13	0.04	QP
7	1.959	22.85	46.00	-23.15	22.61	0.16	0.08	Average
8	1.959	34.02	56.00	-21.98	33.78	0.16	0.08	QP
9	4.525	21.24	46.00	-24.76	20.91	0.20	0.13	Average
10	4.525	29.66	56.00	-26.34	29.33	0.20	0.13	QP
11	9.451	22.19	50.00	-27.81	21.79	0.24	0.16	Average
12	9.451	31.67	60.00	-28.33	31.27	0.24	0.16	QP

Note 1: Level (dBuV) = Read Level (dBuV) + LISN Factor (dB) + Cable Loss (dB).
 2: Over Limit (dB) = Level (dBuV) – Limit Line (dBuV).

Modulation	VHT20	Test Freq. (MHz)	5240
Power Phase	Neutral		

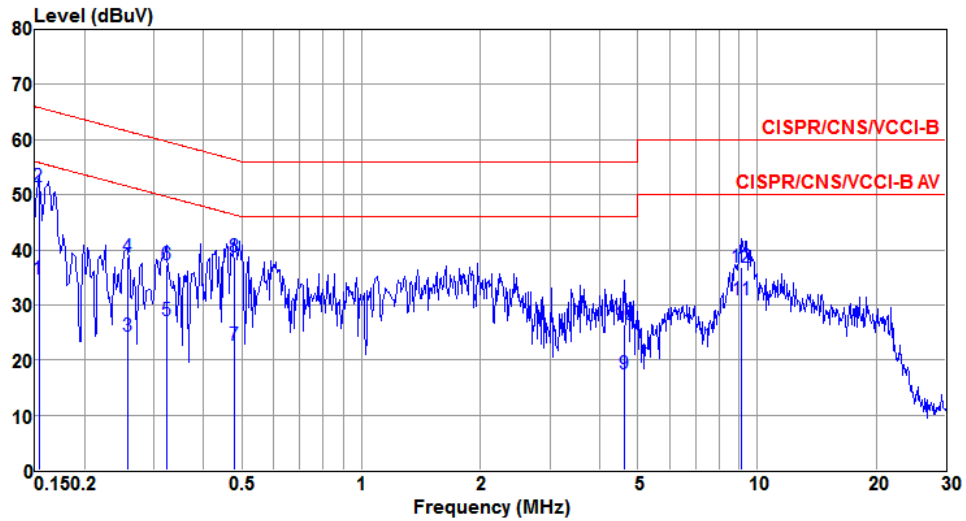

	Freq MHz	Level dBuV	Limit Line dBuV	Over Limit dB	Read Level dBuV	LISN factor dB	cable loss dB	Remark
1	0.153	34.72	55.82	-21.10	34.57	0.13	0.02	Average
2@	0.153	51.55	65.82	-14.27	51.40	0.13	0.02	QP
3	0.256	24.43	51.56	-27.13	24.30	0.11	0.02	Average
4	0.256	38.71	61.56	-22.85	38.58	0.11	0.02	QP
5	0.322	27.23	49.66	-22.43	27.07	0.13	0.03	Average
6	0.322	37.20	59.66	-22.46	37.04	0.13	0.03	QP
7	0.479	22.63	46.36	-23.73	22.45	0.14	0.04	Average
8	0.479	38.66	56.36	-17.70	38.48	0.14	0.04	QP
9	4.622	17.57	46.00	-28.43	17.25	0.19	0.13	Average
10	4.622	26.33	56.00	-29.67	26.01	0.19	0.13	QP
11	9.156	30.90	50.00	-19.10	30.48	0.26	0.16	Average
12	9.156	36.75	60.00	-23.25	36.33	0.26	0.16	QP

Note 1: Level (dBuV) = Read Level (dBuV) + LISN Factor (dB) + Cable Loss (dB).
 2: Over Limit (dB) = Level (dBuV) – Limit Line (dBuV).

Modulation	11a	Test Freq. (MHz)	5745
Power Phase	Line		

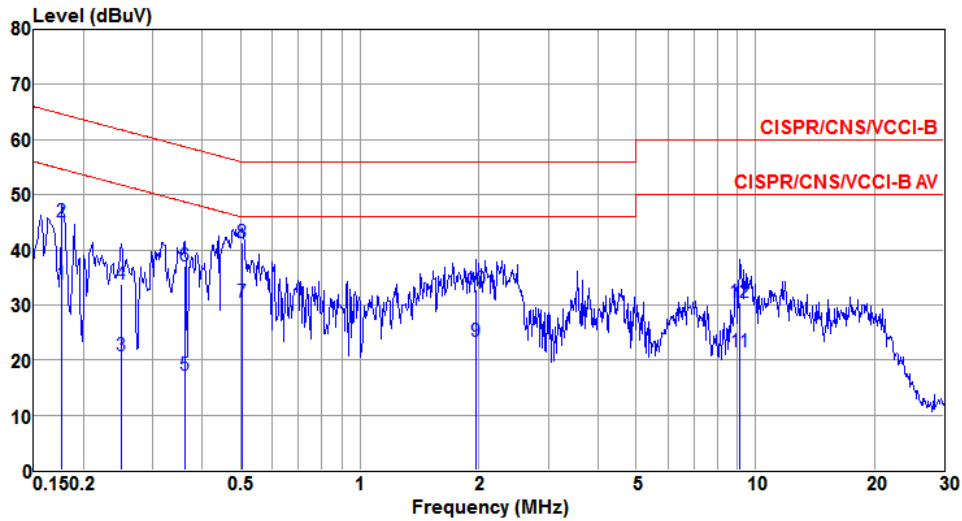

	Freq MHz	Level dBuV	Limit Line dBuV	Over Limit dB	Read Level dBuV	LISN factor dB	cable loss dB	Remark
1	0.177	33.76	54.64	-20.88	33.63	0.11	0.02	Average
2	0.177	45.00	64.64	-19.64	44.87	0.11	0.02	QP
3	0.249	20.77	51.78	-31.01	20.63	0.12	0.02	Average
4	0.249	33.81	61.78	-27.97	33.67	0.12	0.02	QP
5	0.361	17.26	48.69	-31.43	17.10	0.13	0.03	Average
6	0.361	37.03	58.69	-21.66	36.87	0.13	0.03	QP
7	0.505	30.36	46.00	-15.64	30.19	0.13	0.04	Average
8@	0.505	41.31	56.00	-14.69	41.14	0.13	0.04	QP
9	1.959	23.32	46.00	-22.68	23.08	0.16	0.08	Average
10	1.959	32.74	56.00	-23.26	32.50	0.16	0.08	QP
11	9.156	21.59	50.00	-28.41	21.19	0.24	0.16	Average
12	9.156	30.53	60.00	-29.47	30.13	0.24	0.16	QP

Note 1: Level (dBuV) = Read Level (dBuV) + LISN Factor (dB) + Cable Loss (dB).
 2: Over Limit (dB) = Level (dBuV) – Limit Line (dBuV).

Modulation	11a	Test Freq. (MHz)	5745
Power Phase	Neutral		

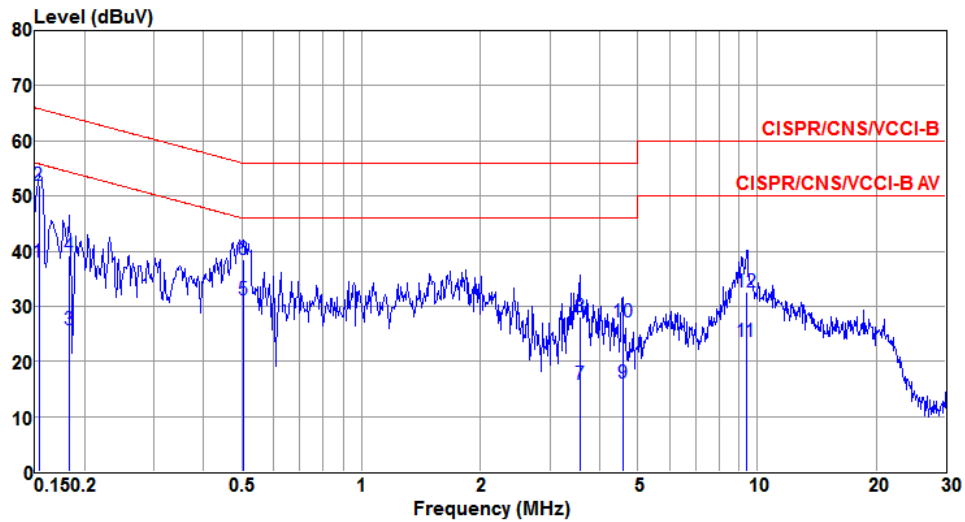

	Freq MHz	Level dBuV	Limit Line dBuV	Over Limit dB	Read Level dBuV	LISN factor dB	cable loss dB	Remark
1	0.153	38.08	55.82	-17.74	37.93	0.13	0.02	Average
2@	0.153	51.96	65.82	-13.86	51.81	0.13	0.02	QP
3	0.183	25.81	54.33	-28.52	25.68	0.11	0.02	Average
4	0.183	39.20	64.33	-25.13	39.07	0.11	0.02	QP
5	0.505	31.07	46.00	-14.93	30.89	0.14	0.04	Average
6	0.505	38.50	56.00	-17.50	38.32	0.14	0.04	QP
7	3.565	15.84	46.00	-30.16	15.56	0.17	0.11	Average
8	3.565	28.19	56.00	-27.81	27.91	0.17	0.11	QP
9	4.574	16.05	46.00	-29.95	15.74	0.18	0.13	Average
10	4.574	27.16	56.00	-28.84	26.85	0.18	0.13	QP
11	9.401	23.55	50.00	-26.45	23.13	0.26	0.16	Average
12	9.401	32.64	60.00	-27.36	32.22	0.26	0.16	QP

Note 1: Level (dBuV) = Read Level (dBuV) + LISN Factor (dB) + Cable Loss (dB).
 2: Over Limit (dB) = Level (dBuV) – Limit Line (dBuV).

3.2 Emission Bandwidth

3.2.1 Limit of Emission bandwidth

Within the 5.725-5.85 GHz band, the minimum 6 dB bandwidth of U-NII devices shall be at least 500 kHz.

3.2.2 Test Procedures

26dB Bandwidth

1. Set RBW = approximately 1% of the emission bandwidth.
2. Set the VBW > RBW, Detector = Peak.
3. Trace mode = max hold.
4. Measure the maximum width of the emission that is 26 dB down from the peak of the emission.

Occupied Bandwidth

1. Set RBW = 1 % to 5 % of the OBW
2. Set VBW \geq 3 RBW
3. Sample detection and single sweep mode shall be used
4. Use the 99 % power bandwidth function of the instrument

6dB Bandwidth

1. Set RBW = 100kHz, VBW = 300kHz
2. Detector = Peak, Trace mode = max hold.
3. Allow the trace to stabilize.
4. Measure the maximum width of the emission that is constrained by the frequencies associated with the two outermost amplitude points (upper and lower frequencies) that are attenuated by 6 dB relative to the maximum level measured in the fundamental emission

3.2.3 Test Setup

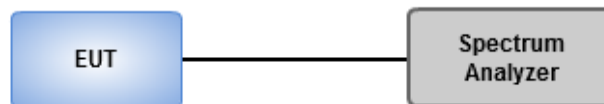

3.2.4 Test Result of Emission Bandwidth

For Frequency band 5150-5250 MHz										
Emission Bandwidth										
Mode	N _{TX}	Freq. (MHz)	26dB Bandwidth (MHz)				99% Bandwidth (MHz)			
			Chain 0	Chain 1	Chain 2	Chain 3	Chain 0	Chain 1	Chain 2	Chain 3
11a	2	5180	22.78	23.19	---	---	16.88	16.74	---	---
11a	2	5200	33.84	29.42	---	---	17.26	16.95	---	---
11a	2	5240	45.00	39.93	---	---	18.92	17.38	---	---
VHT20	2	5180	26.03	24.93	---	---	17.96	17.97	---	---
VHT20	2	5200	35.94	33.77	---	---	18.17	18.04	---	---
VHT20	2	5240	46.52	43.41	---	---	19.39	18.46	---	---
VHT40	2	5190	47.30	47.30	---	---	36.90	36.90	---	---
VHT40	2	5230	75.25	57.97	---	---	37.48	37.24	---	---
VHT80	2	5210	92.99	90.44	---	---	76.68	76.72	---	---

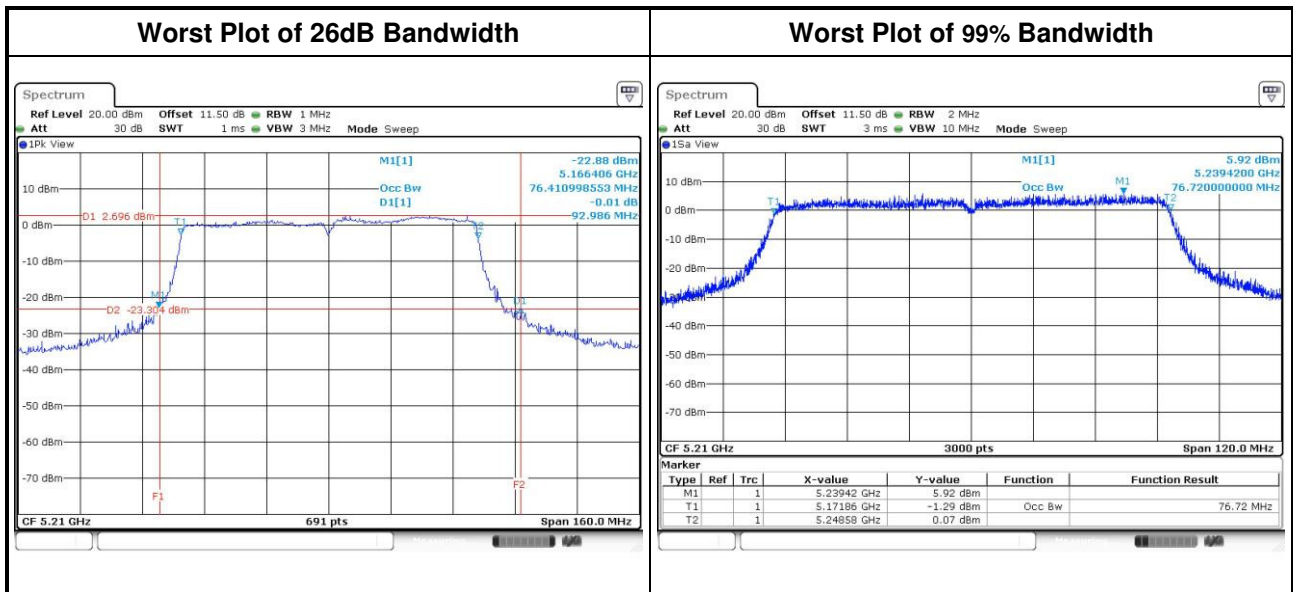

For Frequency band 5725-5850 MHz											
Emission Bandwidth											
Mode	N _{TX}	Freq. (MHz)	OBW Bandwidth (MHz)				6dB Bandwidth (MHz)				6dB BW Limit (MHz)
			Chain 0	Chain 1	Chain 2	Chain 3	Chain 0	Chain 1	Chain 2	Chain 3	
11a	2	5745	16.99	16.77	---	---	16.29	16.35	---	---	0.5
11a	2	5785	16.89	16.71	---	---	16.35	16.46	---	---	0.5
11a	2	5825	16.83	16.69	---	---	16.35	16.41	---	---	0.5
VHT20	2	5745	18.02	17.94	---	---	17.62	17.57	---	---	0.5
VHT20	2	5785	18.03	17.90	---	---	17.57	17.57	---	---	0.5
VHT20	2	5825	17.99	17.87	---	---	17.57	17.57	---	---	0.5
VHT40	2	5755	36.72	36.96	---	---	36.06	36.41	---	---	0.5
VHT40	2	5795	36.80	36.76	---	---	36.06	36.41	---	---	0.5
VHT80	2	5775	76.72	76.72	---	---	76.52	76.06	---	---	0.5

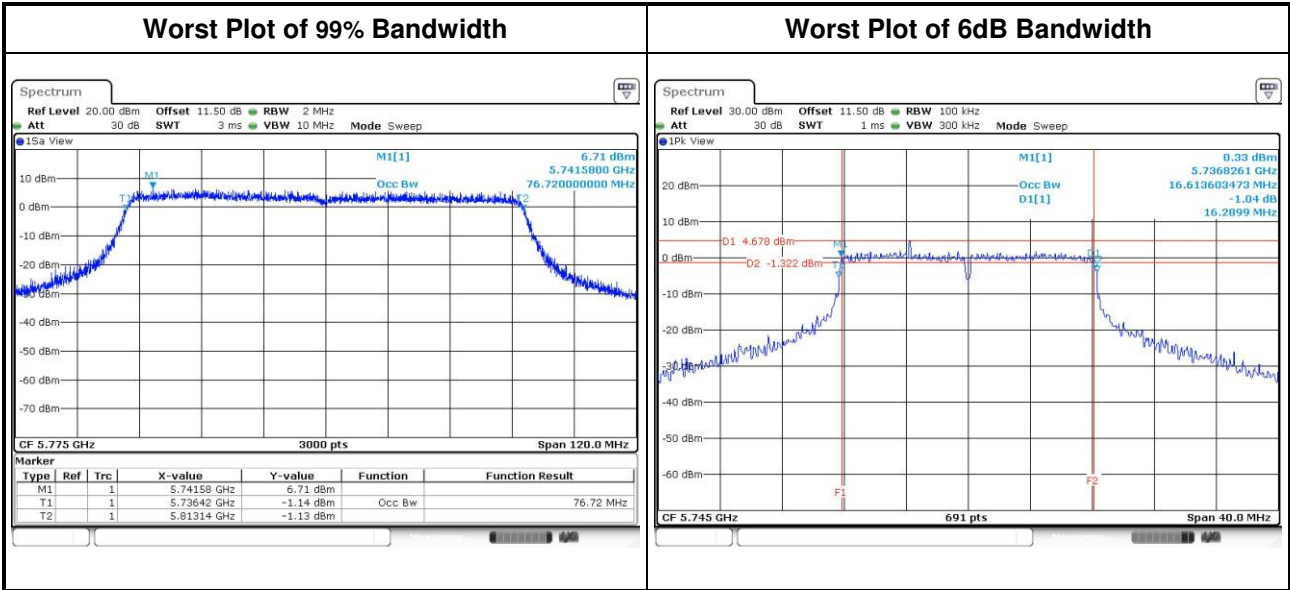

3.3 RF Output Power

3.3.1 Limit of RF Output Power

Frequency band 5150-5250 MHz	
Operating Mode	Limit
<input type="checkbox"/> Outdoor access point	Conducted Power: 1 W The maximum e.i.r.p. at any elevation angle above 30 degrees as measured from the horizon must not exceed 125 mW (21 dBm)
<input checked="" type="checkbox"/> Indoor access point	Conducted Power: 1 W
<input type="checkbox"/> Fixed point-to-point access points	Conducted Power: 1 W
<input type="checkbox"/> Mobile and portable client devices	Conducted Power: 250 mW

Frequency Band (MHz)	Limit
<input type="checkbox"/> 5250 ~ 5350	250mW or 11dBm+10 log B
<input type="checkbox"/> 5470 ~ 5725	250mW or 11dBm+10 log B
<input checked="" type="checkbox"/> 5725 ~ 5850	1 W

Note: "B" is the 26dB emission bandwidth in MHz.

3.3.2 Test Procedures

- Method PM-G (Measurement using a gated RF average power meter)**
 - Measurements may is performed using a wideband gated RF power meter provided that the gate parameters are adjusted such that the power is measured only when the EUT is transmitting at its maximum power control level. Since the measurement is made only during the ON time of the transmitter, no duty cycle correction factor is required.

3.3.3 Test Setup

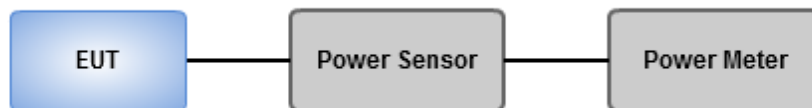

3.3.4 Test Result of Maximum Conducted Output Power

For Frequency band 5150-5250 MHz									
Mode	N _{TX}	Freq. (MHz)	Conducted Power (dBm)				Total Power (mW)	Total Power (dBm)	Limit (dBm)
			Chain 0	Chain 1	Chain 2	Chain 3			
11a	2	5180	15.21	16.09	---	---	73.834	18.68	30.00
11a	2	5200	17.04	17.71	---	---	109.603	20.40	30.00
11a	2	5240	19.67	19.72	---	---	186.439	22.71	30.00
HT20	2	5180	15.11	14.61	---	---	61.341	17.88	30.00
HT20	2	5200	16.15	16.83	---	---	89.405	19.51	30.00
HT20	2	5240	19.73	19.58	---	---	184.754	22.67	30.00
HT40	2	5190	11.65	10.98	---	---	27.153	14.34	30.00
HT40	2	5230	19.04	18.92	---	---	158.151	21.99	30.00
VHT20	2	5180	15.13	14.73	---	---	62.300	17.94	30.00
VHT20	2	5200	16.27	16.97	---	---	92.138	19.64	30.00
VHT20	2	5240	19.87	19.67	---	---	189.734	22.78	30.00
VHT40	2	5190	11.74	11.01	---	---	27.546	14.40	30.00
VHT40	2	5230	19.12	18.97	---	---	160.544	22.06	30.00
VHT80	2	5210	10.03	9.55	---	---	19.085	12.81	30.00

For Frequency band 5725-5850 MHz									
Mode	N _{TX}	Freq. (MHz)	Conducted Power (dBm)				Total Power (mW)	Total Power (dBm)	Limit (dBm)
			Chain 0	Chain 1	Chain 2	Chain 3			
11a	2	5745	15.37	15.13	---	---	67.019	18.26	30.00
11a	2	5785	14.21	13.75	---	---	50.077	17.00	30.00
11a	2	5825	13.57	12.84	---	---	41.982	16.23	30.00
HT20	2	5745	15.03	14.49	---	---	59.961	17.78	30.00
HT20	2	5785	14.26	13.65	---	---	49.843	16.98	30.00
HT20	2	5825	13.73	12.98	---	---	43.466	16.38	30.00
HT40	2	5755	12.43	12.24	---	---	34.248	15.35	30.00
HT40	2	5795	12.98	12.42	---	---	37.319	15.72	30.00
VHT20	2	5745	15.11	14.52	---	---	60.748	17.84	30.00
VHT20	2	5785	14.31	13.75	---	---	50.691	17.05	30.00
VHT20	2	5825	13.84	13.04	---	---	44.348	16.47	30.00
VHT40	2	5755	12.52	12.31	---	---	34.886	15.43	30.00
VHT40	2	5795	13.05	12.46	---	---	37.803	15.78	30.00
VHT80	2	5775	10.12	9.35	---	---	18.890	12.76	30.00

3.4 Peak Power Spectral Density

3.4.1 Limit of Peak Power Spectral Density

Frequency band 5150-5250 MHz		
Operating Mode		Limit
<input type="checkbox"/>	Outdoor access point	17 dBm / MHz
<input checked="" type="checkbox"/>	Indoor access point	17 dBm / MHz
<input type="checkbox"/>	Fixed point-to-point access points	17 dBm / MHz
<input type="checkbox"/>	Mobile and portable client devices	11 dBm / MHz

Frequency Band (MHz)		Limit
<input type="checkbox"/>	5250 ~ 5350	11 dBm / MHz
<input type="checkbox"/>	5470 ~ 5725	11 dBm / MHz
<input checked="" type="checkbox"/>	5725 ~ 5850	30 dBm / 500 kHz

3.4.2 Test Procedures

For 5150 ~ 5250 MHz

Method SA-1

1. Set RBW = 1 MHz, VBW = 3 MHz, Sweep time = auto, Detector = RMS.
2. Trace average 100 traces.
3. Use the peak marker function to determine the maximum amplitude level.

Method SA-2 Alternative

1. Set RBW = 1 MHz, VBW = 3 MHz, Detector = RMS.
2. Set sweep time $\geq 10 * (\text{number of points in sweep}) * (\text{total on/off period of the transmitted signal})$.
3. Perform a single sweep.
4. Use the peak marker function to determine the maximum amplitude level.
5. Add $10 \log(1/x)$, where x is the duty cycle.

For 5725 ~ 5850 MHz

Method SA-1

1. Set RBW = 500 kHz, VBW = 2 MHz, Sweep time = auto, Detector = RMS.
2. Trace average 100 traces.
3. Use the peak marker function to determine the maximum amplitude level.

Method SA-2 Alternative

1. Set RBW = 500 kHz, VBW = 2 MHz, Detector = RMS.
2. Set sweep time $\geq 10 * (\text{number of points in sweep}) * (\text{total on/off period of the transmitted signal})$.
3. Perform a single sweep.
4. Use the peak marker function to determine the maximum amplitude level.
5. Add $10 \log(1/x)$, where x is the duty cycle.

3.4.3 Test Setup

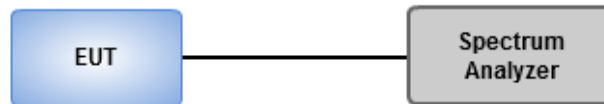

3.4.4 Test Result of Peak Power Spectral Density

For Frequency band 5150-5250 MHz						
Condition			Peak Power Spectral Density (dBm/MHz)			
Modulation Mode	N _{TX}	Freq. (MHz)	PPSD w/o D.F (dBm/MHz)	Duty Factor (dB)	PPSD with D.F (dBm/MHz)	PPSD Limit (dBm/MHz)
11a	2	5180	5.80	0.00	5.80	14.99
11a	2	5200	9.51	0.00	9.51	14.99
11a	2	5240	10.71	0.00	10.71	14.99
VHT20	2	5180	5.76	0.00	5.76	14.99
VHT20	2	5200	8.50	0.00	8.50	14.99
VHT20	2	5240	10.68	0.00	10.68	14.99
VHT40	2	5190	-0.62	0.00	-0.62	14.99
VHT40	2	5230	5.54	0.00	5.54	14.99
VHT80	2	5210	-4.40	0.00	-4.40	14.99

Note:

1. D.F is duty factor.
2. Test result is bin-by-bin summing measured value of each TX port.
3. Directional gain = $5 + 10 \cdot \log(2/1) = 8.01 \text{ dBi} > 6 \text{ dBi}$.
Limit shall be reduced to $17 \text{ dBm} - (8.01 \text{ dBi} - 6 \text{ dBi}) = 14.99 \text{ dBm}$.

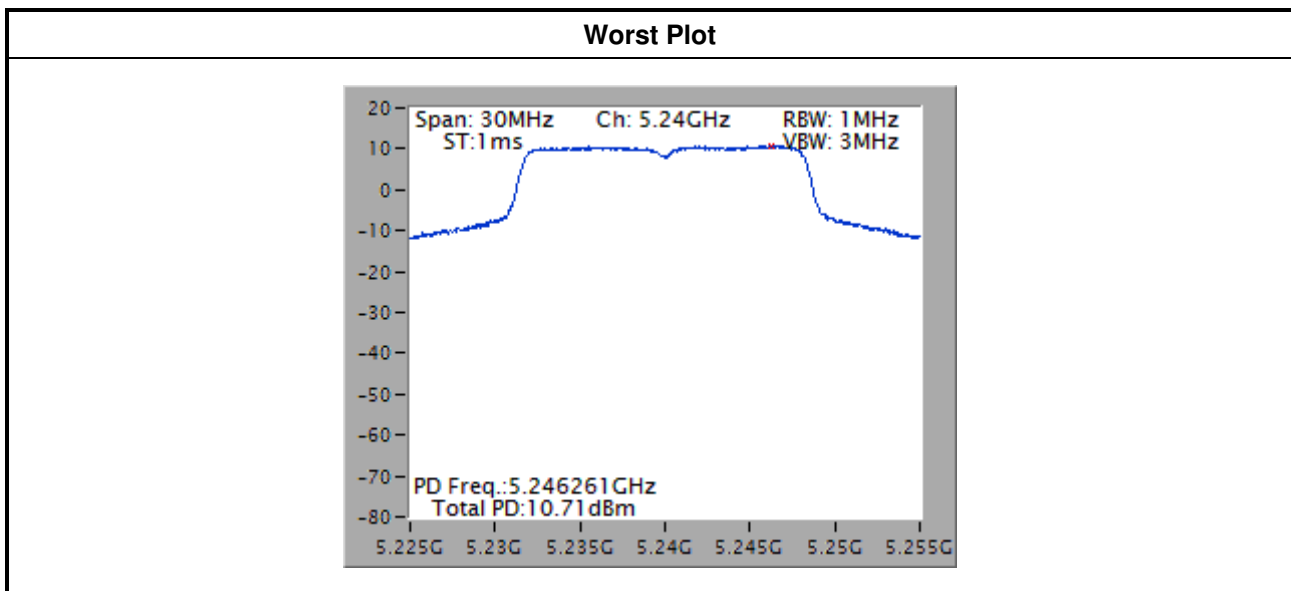

For Frequency band 5725-5850 MHz						
Condition			Peak Power Spectral Density (dBm/500kHz)			
Modulation Mode	N _{TX}	Freq. (MHz)	PPSD w/o D.F (dBm/500kHz)	Duty Factor (dB)	PPSD with D.F (dBm/500kHz)	PPSD Limit (dBm/500kHz)
11a	2	5745	4.50	0.00	4.50	27.99
11a	2	5785	3.30	0.00	3.30	27.99
11a	2	5825	2.31	0.00	2.31	27.99
VHT20	2	5745	3.59	0.00	3.59	27.99
VHT20	2	5785	2.75	0.00	2.75	27.99
VHT20	2	5825	2.17	0.00	2.17	27.99
VHT40	2	5755	-1.12	0.00	-1.12	27.99
VHT40	2	5795	-0.85	0.00	-0.85	27.99
VHT80	2	5775	-6.97	0.00	-6.97	27.99

Note:

1. D.F is duty factor.
2. Test result is bin-by-bin summing measured value of each TX port.
3. Directional gain = $5 + 10 \cdot \log(2/1) = 8.01 \text{ dBi} > 6 \text{ dBi}$.
Limit shall be reduced to $30 \text{ dBm} - (8.01 \text{ dBi} - 6 \text{ dBi}) = 27.99 \text{ dBm}$.

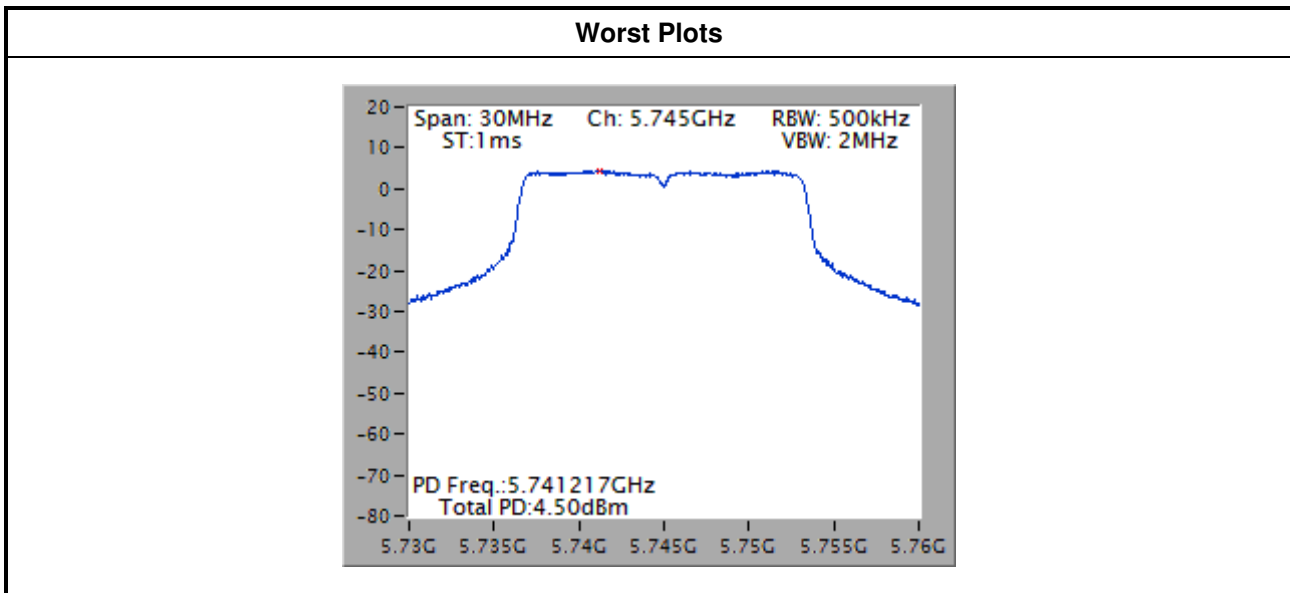

3.5 Transmitter Radiated and Band Edge Emissions

3.5.1 Limit of Transmitter Radiated and Band Edge Emissions

Restricted Band Emissions Limit			
Frequency Range (MHz)	Field Strength (uV/m)	Field Strength (dBuV/m)	Measure Distance (m)
0.009~0.490	2400/F(kHz)	48.5 - 13.8	300
0.490~1.705	24000/F(kHz)	33.8 - 23	30
1.705~30.0	30	29	30
30~88	100	40	3
88~216	150	43.5	3
216~960	200	46	3
Above 960	500	54	3

Note 1:
Qusai-Peak value is measured for frequency below 1GHz except for 9–90 kHz, 110–490 kHz frequency band. Peak and average value are measured for frequency above 1GHz. The limit on average radio frequency emission is as above table. The limit on peak radio frequency emissions is 20 dB above the maximum permitted average emission limit

Note 2:
Measurements may be performed at a distance other than what is specified provided. When performing measurements at a distance other than that specified, the results shall be extrapolated to the specified distance using an extrapolation factor as below, Frequency at or above 30 MHz: 20 dB/decade Frequency below 30 MHz: 40 dB/decade.

Un-restricted band emissions above 1GHz Limit	
Operating Band	Limit
5.15 - 5.25 GHz	e.i.r.p. -27 dBm [68.2 dBuV/m@3m]
5.725 - 5.850 GHz	5.715 5.725 GHz: e.i.r.p. -17 dBm [78.2 dBuV/m@3m] 5.85 5.86 GHz: e.i.r.p. -17 dBm [78.2 dBuV/m@3m] Other un-restricted band: e.i.r.p. -27 dBm [68.2 dBuV/m@3m]

Note 1: Measurements may be performed at a distance other than the limit distance provided they are not performed in the near field and the emissions to be measured can be detected by the measurement equipment. When performing measurements at a distance other than that specified, the results shall be extrapolated to the specified distance using an extrapolation factor of 20 dB/decade (inverse of linear distance for field-strength measurements, inverse of linear distance-squared for power-density measurements).

3.5.2 Test Procedures

1. Measurement is made at a semi-anechoic chamber that incorporates a turntable allowing a EUT rotation of 360°. A continuously-rotating, remotely-controlled turntable is installed at the test site to support the EUT and facilitate determination of the direction of maximum radiation for each EUT emission frequency. The EUT is placed at test table. For emissions testing at or below 1 GHz, the table height is 80 cm above the reference ground plane. For emission measurements above 1 GHz, the table height is 1.5 m
2. Measurement is made with the antenna positioned in both the horizontal and vertical planes of polarization. The measurement antenna is varied in height (1 m ~ 4m) above the reference ground plane to obtain the maximum signal strength. Distance between EUT and antenna is 3 m.
3. This investigation is performed with the EUT rotated 360°, the antenna height scanned between 1 m and 4 m, and the antenna rotated to repeat the measurements for both the horizontal and vertical antenna polarizations.

Note:

1. 120kHz measurement bandwidth of test receiver and Quasi-peak detector is for radiated emission below 1GHz.
2. RBW=1MHz, VBW=3MHz and Peak detector is for peak measured value of radiated emission above 1GHz.
3. RBW=1MHz, VBW=1/T and Peak detector is for average measured value of radiated emission above 1GHz.

3.5.3 Test Setup

Radiated Emissions below 1 GHz

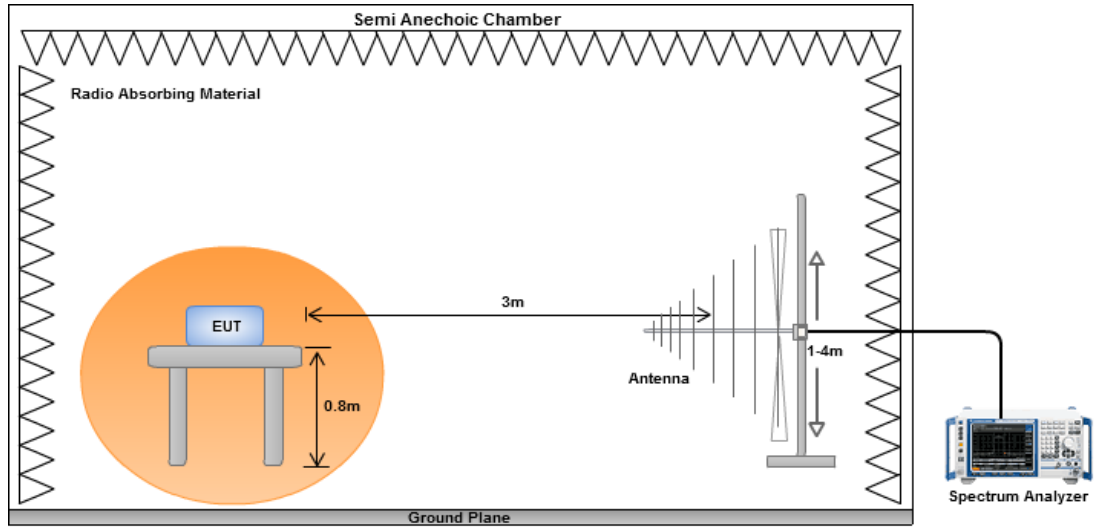

Radiated Emissions above 1 GHz

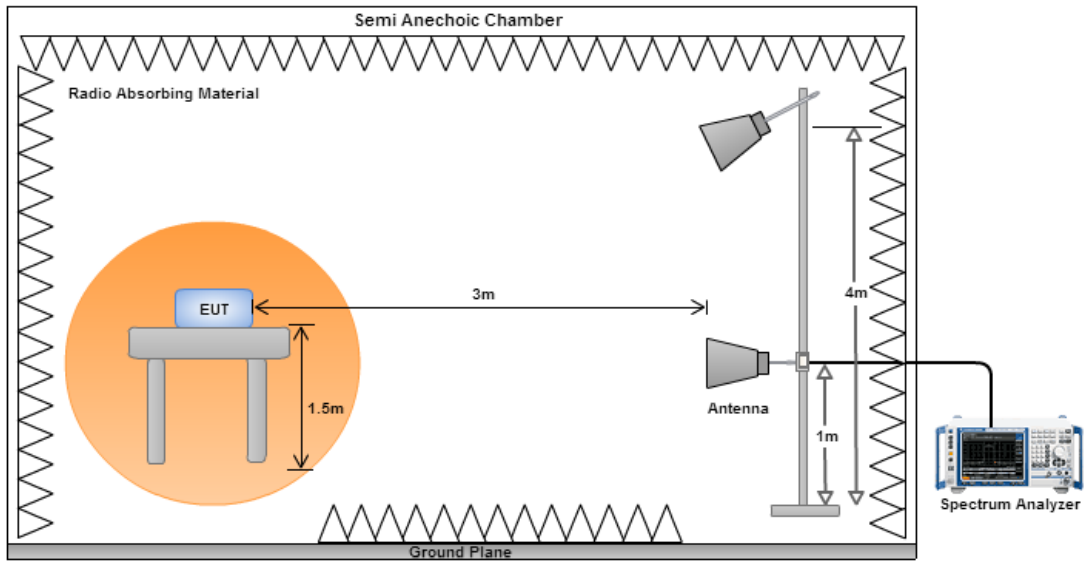

3.5.4 Transmitter Radiated Unwanted Emissions (Below 1GHz)

Modulation	VHT20	Test Freq. (MHz)	5240
Polarization	Horizontal		

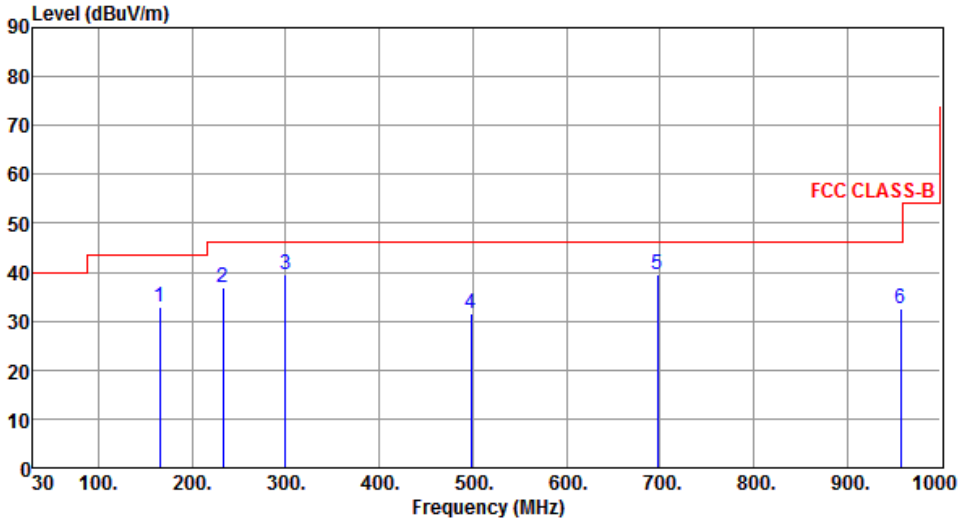

	Freq. MHz	Emission level dBuV/m	Limit dBuV/m	Margin dB	SA reading dBuV	Factor dB	Remark	ANT High cm	Turn Table deg
1	165.80	32.87	43.50	-10.63	44.68	-11.81	Peak	---	---
2	232.73	36.85	46.00	-9.15	50.47	-13.62	Peak	---	---
3	299.66	39.46	46.00	-6.54	50.57	-11.11	Peak	---	---
4	498.51	31.64	46.00	-14.36	38.21	-6.57	Peak	---	---
5	697.36	39.52	46.00	-6.48	42.82	-3.30	Peak	---	---
6	957.32	32.67	46.00	-13.33	32.63	0.04	Peak	---	---

Note 1: Emission Level (dBuV/m) = SA Reading (dBuV/m) + Factor* (dB)
*Factor includes antenna factor , cable loss and amplifier gain
Note 2: Margin (dB) = Emission level (dBuV/m) – Limit (dBuV/m).
Note 3: All spurious emissions below 30MHz are more than 20 dB below the limit.

Modulation	VHT20	Test Freq. (MHz)	5240
Polarization	Vertical		

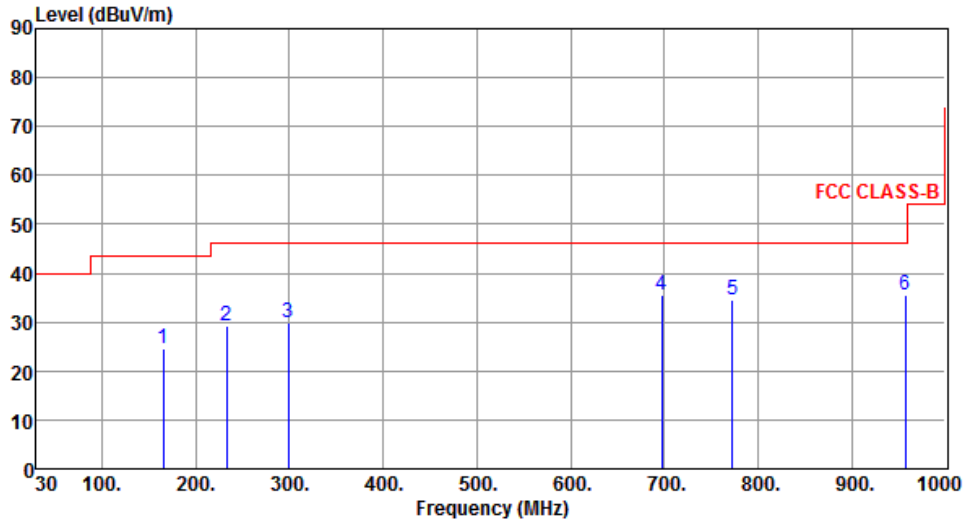

	Freq. MHz	Emission level dBuV/m	Limit dBuV/m	Margin dB	SA reading dBuV	Factor dB	Remark	ANT High cm	Turn Table deg
1	165.80	24.71	43.50	-18.79	36.56	-11.85	Peak	---	---
2	232.73	29.28	46.00	-16.72	42.89	-13.61	Peak	---	---
3	298.69	29.88	46.00	-16.12	41.02	-11.14	Peak	---	---
4	697.36	35.50	46.00	-10.50	38.75	-3.25	Peak	---	---
5	773.02	34.58	46.00	-11.42	36.73	-2.15	Peak	---	---
6	957.32	35.54	46.00	-10.46	35.40	0.14	Peak	---	---

Note 1: Emission Level (dBuV/m) = SA Reading (dBuV/m) + Factor* (dB)

*Factor includes antenna factor , cable loss and amplifier gain

Note 2: Margin (dB) = Emission level (dBuV/m) – Limit (dBuV/m).

Note 3: All spurious emissions below 30MHz are more than 20 dB below the limit.

Modulation	11a	Test Freq. (MHz)	5745
Polarization	Horizontal		

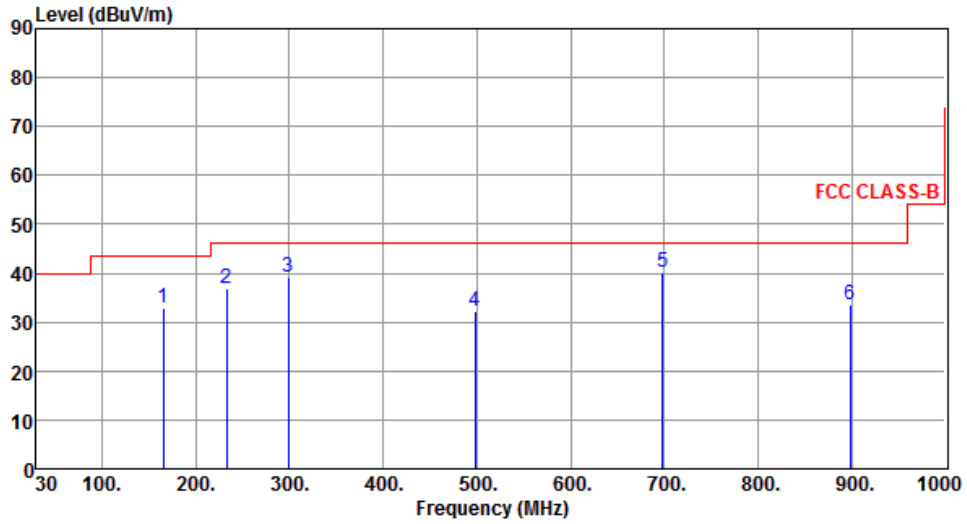

	Freq. MHz	Emission level dBuV/m	Limit dBuV/m	Margin dB	SA reading dBuV	Factor dB	Remark	ANT High cm	Turn Table deg
1	165.80	33.03	43.50	-10.47	44.88	-11.85	Peak	---	---
2	232.73	36.71	46.00	-9.29	50.32	-13.61	Peak	---	---
3	298.69	39.17	46.00	-6.83	50.31	-11.14	Peak	---	---
4	498.51	32.36	46.00	-13.64	38.90	-6.54	Peak	---	---
5	698.33	40.18	46.00	-5.82	43.40	-3.22	Peak	---	---
6	898.15	33.56	46.00	-12.44	34.16	-0.60	Peak	---	---

Note 1: Emission Level (dBuV/m) = SA Reading (dBuV/m) + Factor* (dB)

*Factor includes antenna factor , cable loss and amplifier gain

Note 2: Margin (dB) = Emission level (dBuV/m) – Limit (dBuV/m).

Note 3: All spurious emissions below 30MHz are more than 20 dB below the limit.

Modulation	11a	Test Freq. (MHz)	5745
Polarization	Vertical		

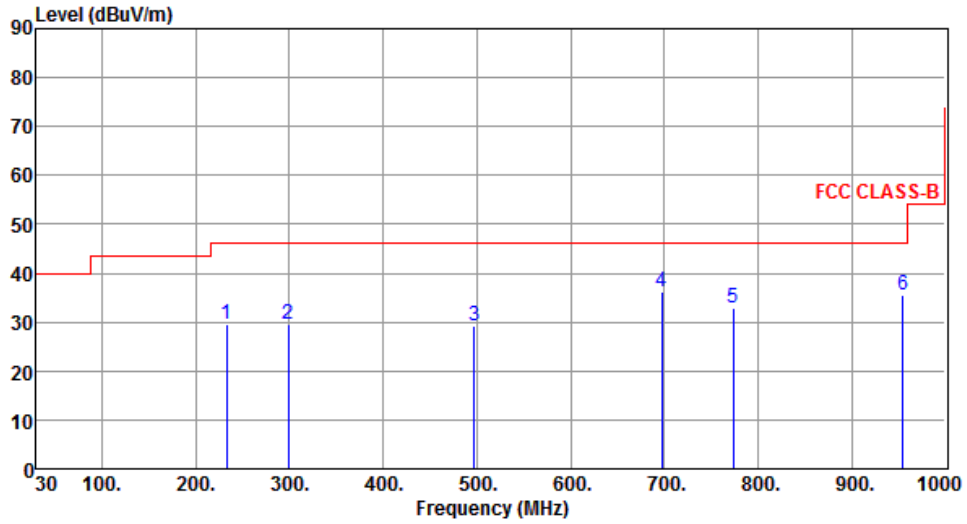

	Freq. MHz	Emission level dBuV/m	Limit dBuV/m	Margin dB	SA reading dBuV	Factor dB	Remark	ANT High cm	Turn Table deg
1	232.73	29.40	46.00	-16.60	43.01	-13.61	Peak	---	---
2	298.69	29.47	46.00	-16.53	40.61	-11.14	Peak	---	---
3	497.54	29.25	46.00	-16.75	35.80	-6.55	Peak	---	---
4	697.36	36.12	46.00	-9.88	39.37	-3.25	Peak	---	---
5	773.99	32.98	46.00	-13.02	35.12	-2.14	Peak	---	---
6	954.41	35.60	46.00	-10.40	35.50	0.10	Peak	---	---

Note 1: Emission Level (dBuV/m) = SA Reading (dBuV/m) + Factor* (dB)

*Factor includes antenna factor , cable loss and amplifier gain

Note 2: Margin (dB) = Emission level (dBuV/m) – Limit (dBuV/m).

Note 3: All spurious emissions below 30MHz are more than 20 dB below the limit.

3.5.5 Transmitter Radiated Unwanted Emissions (Above 1GHz) for 11a

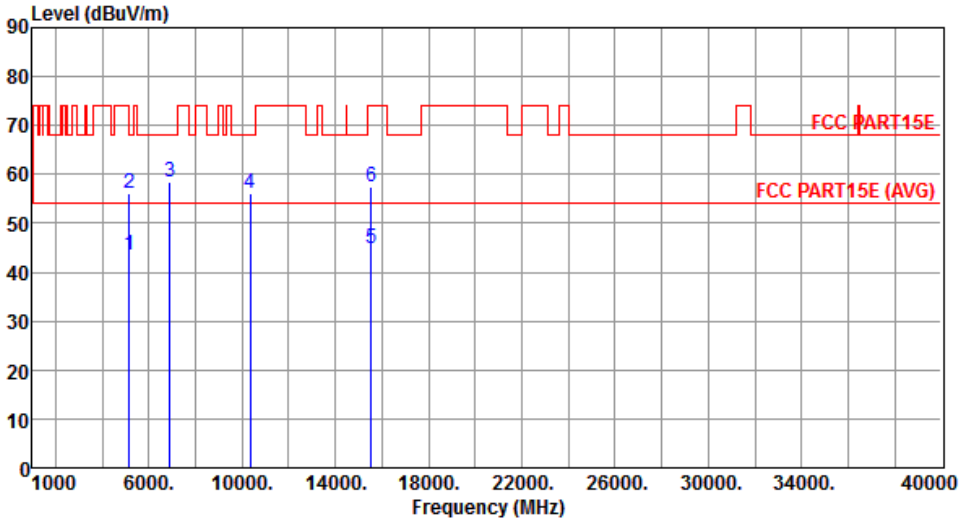
Modulation	11a	Test Freq. (MHz)	5180						
Polarization	Horizontal								
									
	Freq.	Emission level	Limit	Margin	SA reading	Factor	Remark	ANT High	Turn Table
	MHz	dBuV/m	dBuV/m	dB	dBuV	dB		cm	deg
1	5150.00	43.52	54.00	-10.48	37.79	5.73	Average	100	38
2	5150.00	56.09	74.00	-17.91	50.36	5.73	Peak	100	38
3	6906.00	58.43	68.20	-9.77	49.21	9.22	Peak	326	75
4	10360.00	56.25	68.20	-11.95	41.76	14.49	Peak	267	67
5	15540.00	44.84	54.00	-9.16	28.14	16.70	Average	267	267
6	15540.00	57.32	74.00	-16.68	40.62	16.70	Peak	267	267

Note 1: Emission Level (dBuV/m) = SA Reading (dBuV/m) + Factor* (dB)
*Factor includes antenna factor , cable loss and amplifier gain
Note 2: Margin (dB) = Emission level (dBuV/m) – Limit (dBuV/m).

Modulation	11a	Test Freq. (MHz)	5180
Polarization	Vertical		

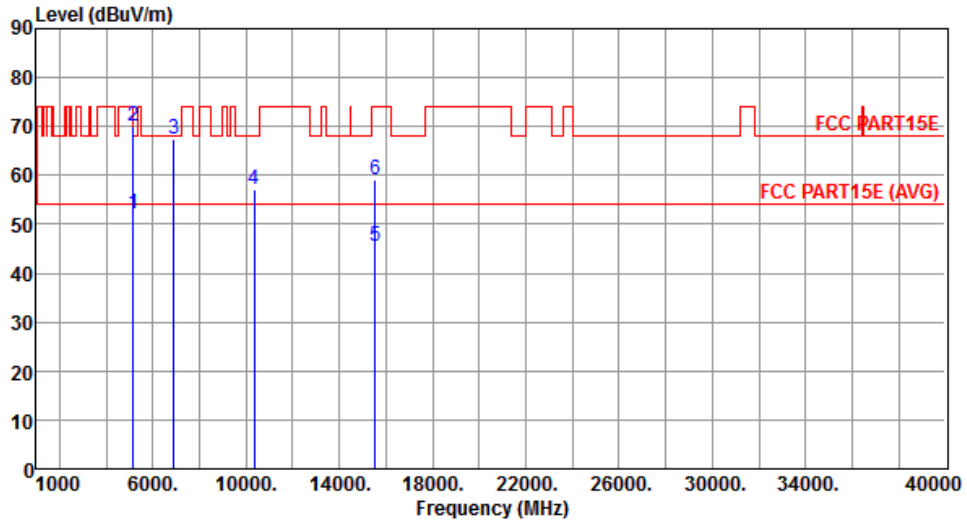

	Freq. MHz	Emission level dBuV/m	Limit dBuV/m	Margin dB	SA reading dBuV	Factor dB	Remark	ANT High cm	Turn Table deg
1	5150.00	52.07	54.00	-1.93	46.34	5.73	Average	147	176
2	5150.00	70.13	74.00	-3.87	64.40	5.73	Peak	147	176
3	6906.00	67.29	68.20	-0.91	58.07	9.22	Peak	350	113
4	10360.00	56.96	68.20	-11.24	42.47	14.49	Peak	188	150
5	15540.00	45.44	54.00	-8.56	28.74	16.70	Average	174	237
6	15540.00	59.08	74.00	-14.92	42.38	16.70	Peak	174	237

Note 1: Emission Level (dBuV/m) = SA Reading (dBuV/m) + Factor* (dB)

*Factor includes antenna factor , cable loss and amplifier gain

Note 2: Margin (dB) = Emission level (dBuV/m) – Limit (dBuV/m).

Modulation	11a	Test Freq. (MHz)	5200
Polarization	Horizontal		

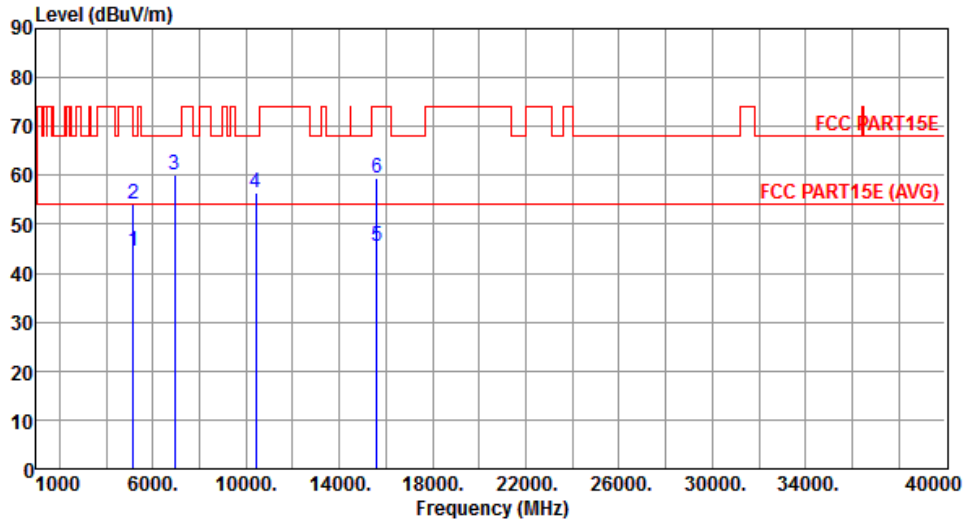

	Freq. MHz	Emission level dBuV/m	Limit dBuV/m	Margin dB	SA reading dBuV	Factor dB	Remark	ANT High cm	Turn Table deg
1	5150.00	44.43	54.00	-9.57	38.70	5.73	Average	357	316
2	5150.00	53.99	74.00	-20.01	48.26	5.73	Peak	357	316
3	6933.00	60.26	68.20	-7.94	50.95	9.31	Peak	100	35
4	10400.00	56.51	68.20	-11.69	41.93	14.58	Peak	320	296
5	15600.00	45.35	54.00	-8.65	28.77	16.58	Average	100	77
6	15600.00	59.30	74.00	-14.70	42.72	16.58	Peak	400	76

Note 1: Emission Level (dBuV/m) = SA Reading (dBuV/m) + Factor* (dB)

*Factor includes antenna factor , cable loss and amplifier gain

Note 2: Margin (dB) = Emission level (dBuV/m) – Limit (dBuV/m).

Modulation	11a	Test Freq. (MHz)	5200
Polarization	Vertical		

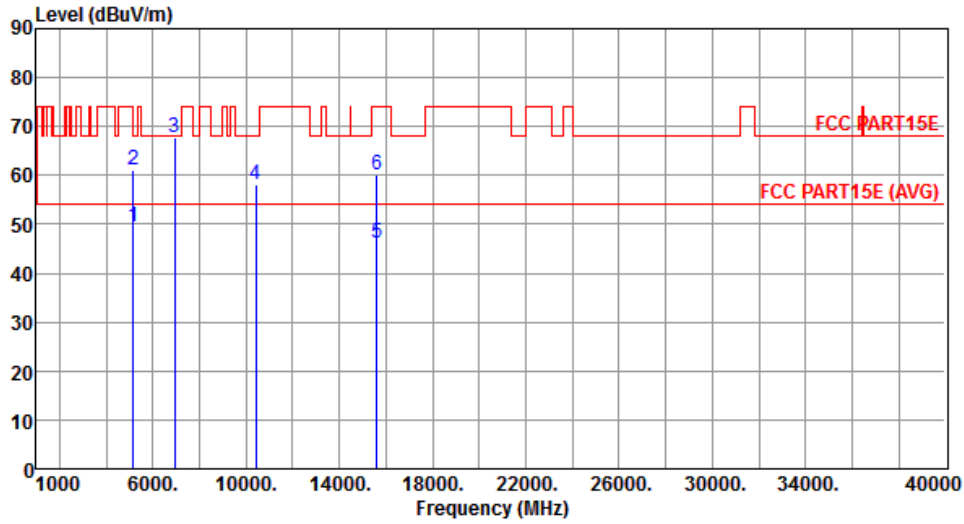

	Freq. MHz	Emission level dBuV/m	Limit dBuV/m	Margin dB	SA reading dBuV	Factor dB	Remark	ANT High cm	Turn Table deg
1	5150.00	49.63	54.00	-4.37	43.90	5.73	Average	144	172
2	5150.00	61.17	74.00	-12.83	55.44	5.73	Peak	144	172
3	6933.00	67.86	68.20	-0.34	58.55	9.31	Peak	391	123
4	10400.00	58.07	68.20	-10.13	43.49	14.58	Peak	340	142
5	15600.00	46.29	54.00	-7.71	29.71	16.58	Average	391	123
6	15600.00	60.03	74.00	-13.97	43.45	16.58	Peak	391	123

Note 1: Emission Level (dBuV/m) = SA Reading (dBuV/m) + Factor* (dB)

*Factor includes antenna factor , cable loss and amplifier gain

Note 2: Margin (dB) = Emission level (dBuV/m) – Limit (dBuV/m).

Modulation	11a	Test Freq. (MHz)	5240
Polarization	Horizontal		

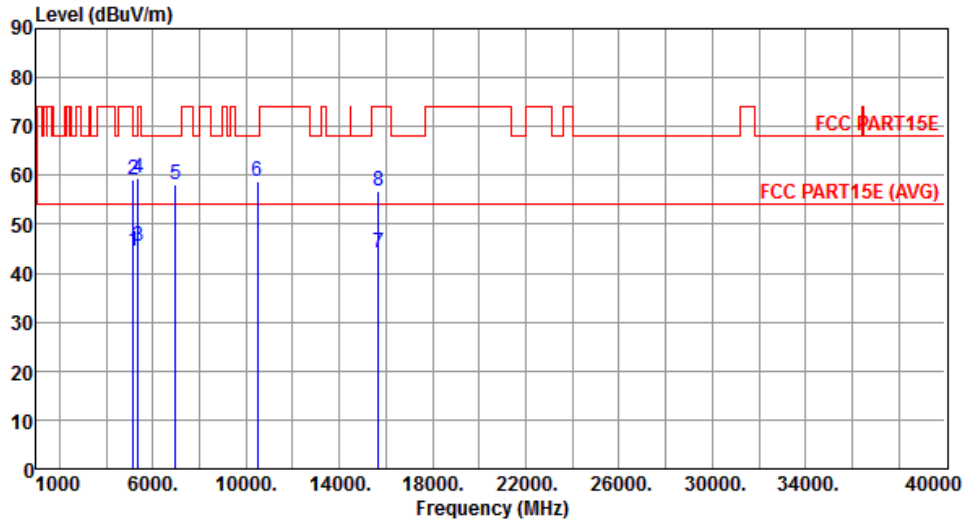

	Freq. MHz	Emission level dBuV/m	Limit dBuV/m	Margin dB	SA reading dBuV	Factor dB	Remark	ANT High cm	Turn Table deg
1	5150.00	44.38	54.00	-9.62	38.65	5.73	Average	294	224
2	5150.00	59.04	74.00	-14.96	53.31	5.73	Peak	294	224
3	5350.00	45.61	54.00	-8.39	39.65	5.96	Average	294	224
4	5350.00	59.44	74.00	-14.56	53.48	5.96	Peak	294	224
5	6986.00	58.04	68.20	-10.16	48.57	9.47	Peak	236	226
6	10480.00	58.77	68.20	-9.43	43.99	14.78	Peak	268	80
7	15660.00	44.25	54.00	-9.75	27.80	16.45	Average	167	191
8	15660.00	56.65	74.00	-17.35	40.20	16.45	Peak	167	191

Note 1: Emission Level (dBuV/m) = SA Reading (dBuV/m) + Factor* (dB)

*Factor includes antenna factor , cable loss and amplifier gain

Note 2: Margin (dB) = Emission level (dBuV/m) – Limit (dBuV/m).

Modulation	11a	Test Freq. (MHz)	5240
Polarization	Vertical		

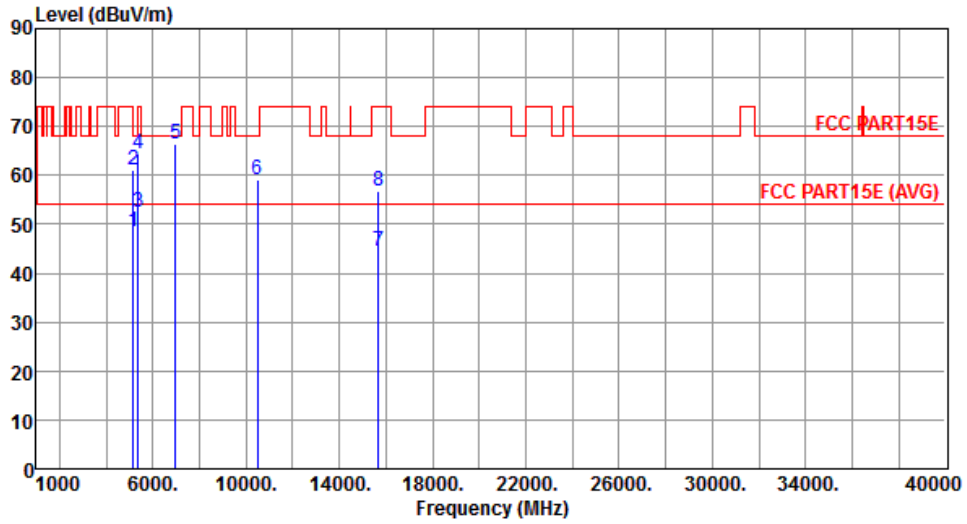

	Freq. MHz	Emission level dBuV/m	Limit dBuV/m	Margin dB	SA reading dBuV	Factor dB	Remark	ANT High cm	Turn Table deg
1	5150.00	48.45	54.00	-5.55	42.72	5.73	Average	204	51
2	5150.00	61.23	74.00	-12.77	55.50	5.73	Peak	204	51
3	5350.00	52.48	54.00	-1.52	46.52	5.96	Average	204	51
4	5350.00	64.57	74.00	-9.43	58.61	5.96	Peak	204	51
5	6986.00	66.49	68.20	-1.71	57.02	9.47	Peak	310	110
6	10480.00	59.14	68.20	-9.06	44.36	14.78	Peak	355	143
7	15660.00	44.53	54.00	-9.47	28.08	16.45	Average	137	108
8	15660.00	56.89	74.00	-17.11	40.44	16.45	Peak	137	108

Note 1: Emission Level (dBuV/m) = SA Reading (dBuV/m) + Factor* (dB)

*Factor includes antenna factor , cable loss and amplifier gain

Note 2: Margin (dB) = Emission level (dBuV/m) – Limit (dBuV/m).

Modulation	11a	Test Freq. (MHz)	5745
Polarization	Horizontal		

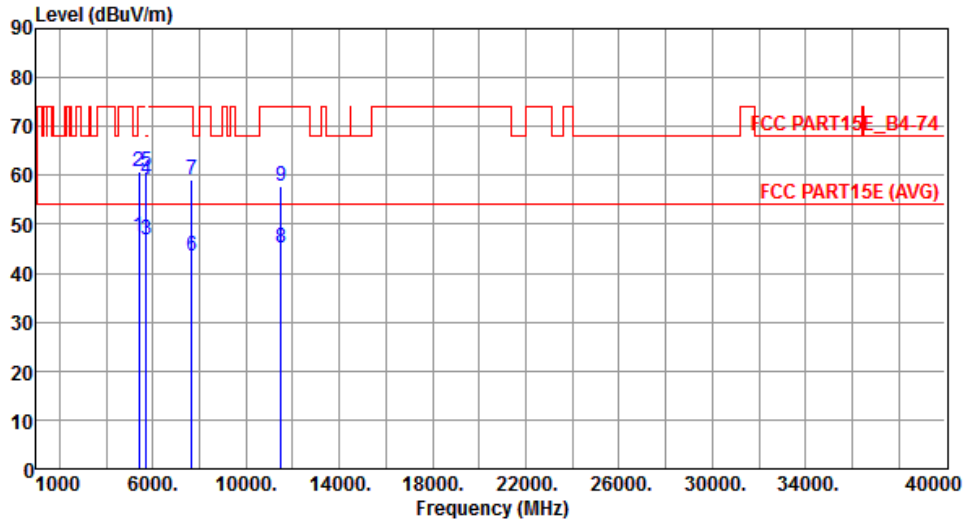

	Freq. MHz	Emission level dBuV/m	Limit dBuV/m	Margin dB	SA reading dBuV	Factor dB	Remark	ANT High cm	Turn Table deg
1	5400.00	47.46	54.00	-6.54	41.46	6.00	Average	264	235
2	5400.00	60.86	74.00	-13.14	54.86	6.00	Peak	264	235
3	5715.00	46.69	54.00	-7.31	40.08	6.61	Average	264	235
4	5715.00	59.20	74.00	-14.80	52.59	6.61	Peak	264	235
5	5725.00	60.82	78.20	-17.38	54.20	6.62	Peak	264	235
6	7660.00	43.63	54.00	-10.37	33.19	10.44	Average	209	243
7	7660.00	58.95	74.00	-15.05	48.51	10.44	Peak	209	243
8	11490.00	45.15	54.00	-8.85	29.12	16.03	Average	336	309
9	11490.00	57.93	74.00	-16.07	41.90	16.03	Peak	336	309

Note 1: Emission Level (dBuV/m) = SA Reading (dBuV/m) + Factor* (dB)

*Factor includes antenna factor , cable loss and amplifier gain

Note 2: Margin (dB) = Emission level (dBuV/m) – Limit (dBuV/m).

Modulation	11a	Test Freq. (MHz)	5745
Polarization	Vertical		

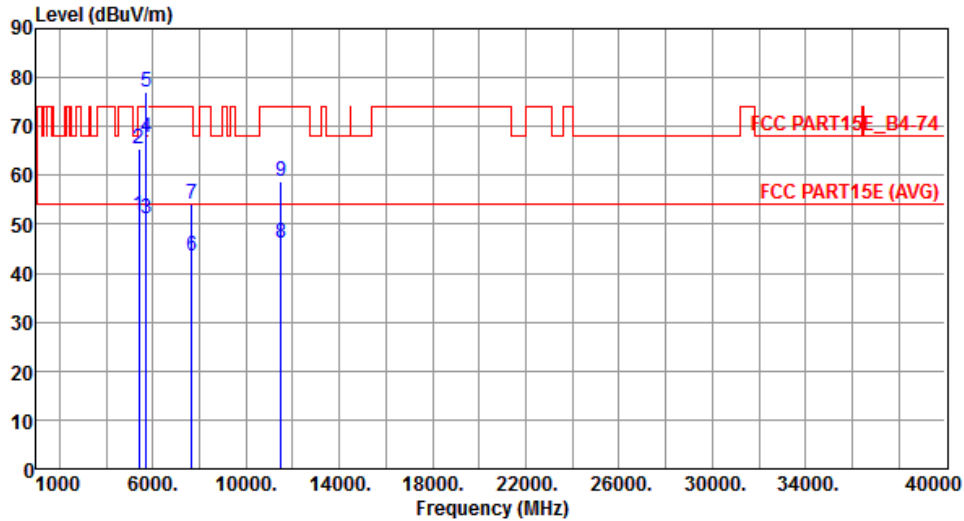

	Freq. MHz	Emission level dBuV/m	Limit dBuV/m	Margin dB	SA reading dBuV	Factor dB	Remark	ANT High cm	Turn Table deg
1	5400.00	51.95	54.00	-2.05	45.95	6.00	Average	228	18
2	5400.00	65.50	74.00	-8.50	59.50	6.00	Peak	228	18
3	5715.00	51.14	54.00	-2.86	44.53	6.61	Average	229	18
4	5715.00	67.83	74.00	-6.17	61.22	6.61	Peak	229	18
5	5725.00	77.05	78.20	-1.15	70.43	6.62	Peak	229	18
6	7660.00	43.46	54.00	-10.54	33.02	10.44	Average	211	208
7	7660.00	54.09	74.00	-19.91	43.65	10.44	Peak	211	208
8	11490.00	46.04	54.00	-7.96	30.01	16.03	Average	301	265
9	11490.00	58.92	74.00	-15.08	42.89	16.03	Peak	301	265

Note 1: Emission Level (dBuV/m) = SA Reading (dBuV/m) + Factor* (dB)

*Factor includes antenna factor , cable loss and amplifier gain

Note 2: Margin (dB) = Emission level (dBuV/m) – Limit (dBuV/m).

Modulation	11a	Test Freq. (MHz)	5785
Polarization	Horizontal		

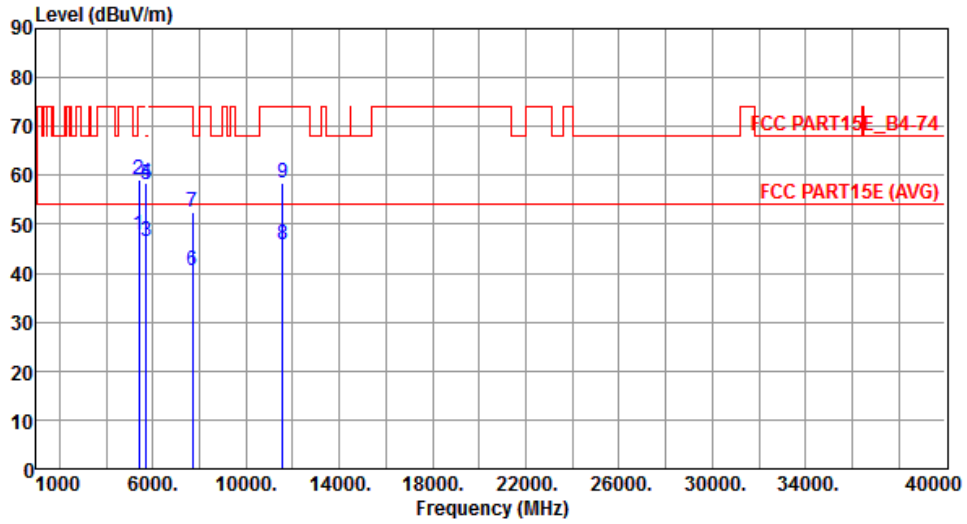

	Freq. MHz	Emission level dBuV/m	Limit dBuV/m	Margin dB	SA reading dBuV	Factor dB	Remark	ANT High cm	Turn Table deg
1	5400.00	47.83	54.00	-6.17	41.83	6.00	Average	298	258
2	5400.00	59.12	74.00	-14.88	53.12	6.00	Peak	298	258
3	5715.00	46.39	54.00	-7.61	39.78	6.61	Average	298	258
4	5715.00	58.32	74.00	-15.68	51.71	6.61	Peak	298	258
5	5725.00	57.99	78.20	-20.21	51.37	6.62	Peak	298	258
6	7713.00	40.41	54.00	-13.59	29.89	10.52	Average	164	267
7	7713.00	52.44	74.00	-21.56	41.92	10.52	Peak	164	267
8	11570.00	45.93	54.00	-8.07	30.01	15.92	Average	375	254
9	11570.00	58.43	74.00	-15.57	42.51	15.92	Peak	375	254

Note 1: Emission Level (dBuV/m) = SA Reading (dBuV/m) + Factor* (dB)

*Factor includes antenna factor , cable loss and amplifier gain

Note 2: Margin (dB) = Emission level (dBuV/m) – Limit (dBuV/m).

Modulation	11a	Test Freq. (MHz)	5785
Polarization	Vertical		

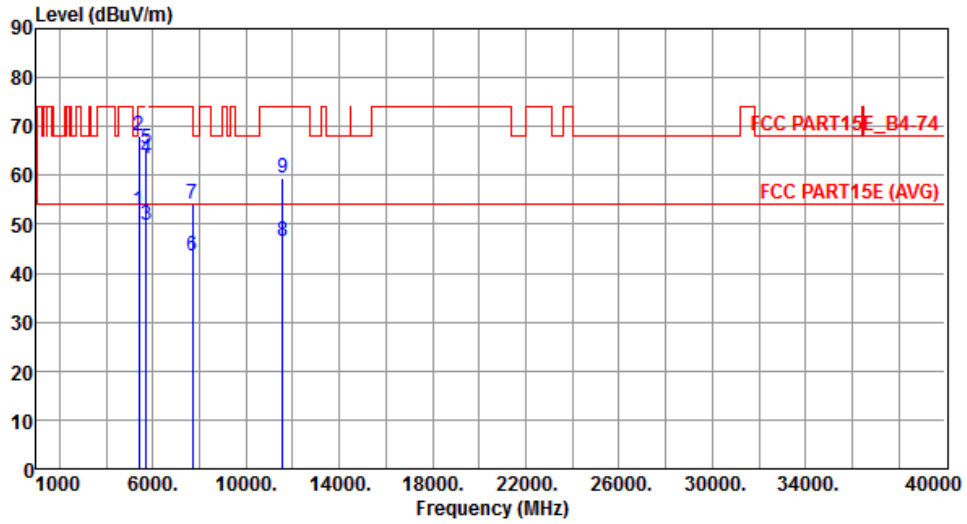

	Freq. MHz	Emission level dBuV/m	Limit dBuV/m	Margin dB	SA reading dBuV	Factor dB	Remark	ANT High cm	Turn Table deg
1	5400.00	52.88	54.00	-1.12	46.88	6.00	Average	209	149
2	5400.00	68.02	74.00	-5.98	62.02	6.00	Peak	209	149
3	5715.00	49.65	54.00	-4.35	43.04	6.61	Average	209	149
4	5715.00	63.59	74.00	-10.41	56.98	6.61	Peak	209	148
5	5725.00	65.39	78.20	-12.81	58.77	6.62	Peak	209	149
6	7713.00	43.47	54.00	-10.53	32.95	10.52	Average	362	232
7	7713.00	54.00	74.00	-20.00	43.48	10.52	Peak	362	232
8	11570.00	46.55	54.00	-7.45	30.63	15.92	Average	215	122
9	11570.00	59.61	74.00	-14.39	43.69	15.92	Peak	215	122

Note 1: Emission Level (dBuV/m) = SA Reading (dBuV/m) + Factor* (dB)

*Factor includes antenna factor , cable loss and amplifier gain

Note 2: Margin (dB) = Emission level (dBuV/m) – Limit (dBuV/m).

Modulation	11a	Test Freq. (MHz)	5825
Polarization	Horizontal		

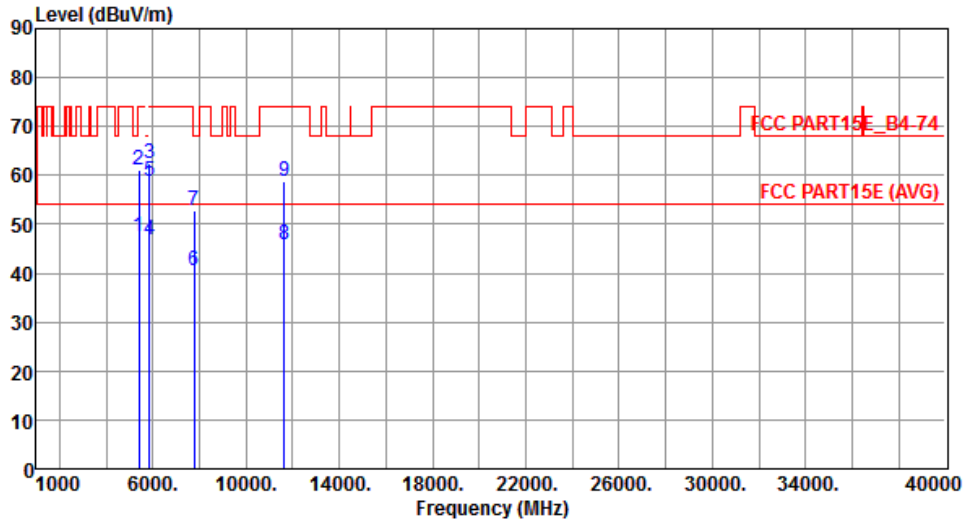

	Freq. MHz	Emission level dBuV/m	Limit dBuV/m	Margin dB	SA reading dBuV	Factor dB	Remark	ANT High cm	Turn Table deg
1	5400.00	47.51	54.00	-6.49	41.51	6.00	Average	315	230
2	5400.00	61.15	74.00	-12.85	55.15	6.00	Peak	315	230
3	5850.00	62.42	78.20	-15.78	55.56	6.86	Peak	315	230
4	5860.00	46.88	54.00	-7.12	40.01	6.87	Average	315	230
5	5860.00	58.75	74.00	-15.25	51.88	6.87	Peak	315	230
6	7766.00	40.61	54.00	-13.39	29.98	10.63	Average	176	172
7	7766.00	52.64	68.20	-15.56	42.01	10.63	Peak	176	172
8	11650.00	45.68	54.00	-8.32	29.88	15.80	Average	333	332
9	11650.00	58.69	74.00	-15.31	42.89	15.80	Peak	333	332

Note 1: Emission Level (dBuV/m) = SA Reading (dBuV/m) + Factor* (dB)

*Factor includes antenna factor , cable loss and amplifier gain

Note 2: Margin (dB) = Emission level (dBuV/m) – Limit (dBuV/m).

Modulation	11a	Test Freq. (MHz)	5825
Polarization	Vertical		

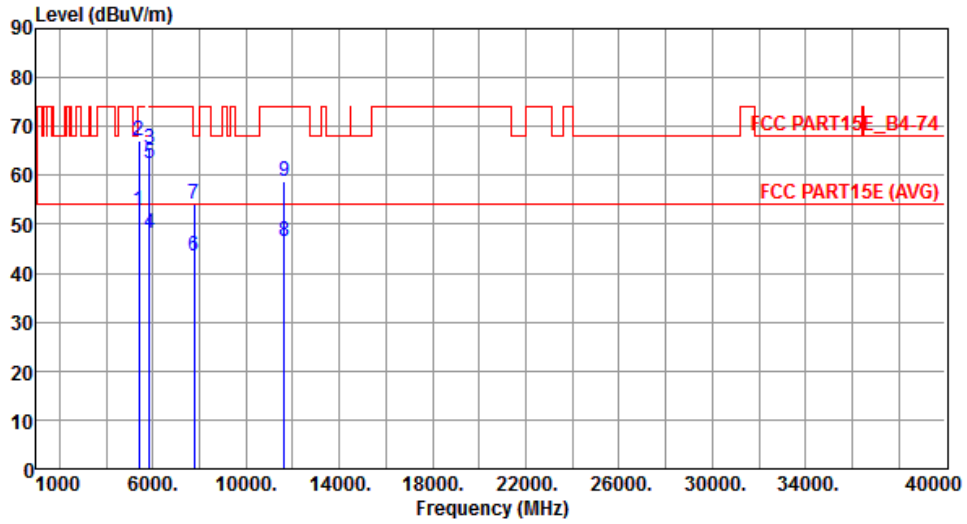

	Freq. MHz	Emission level dBuV/m	Limit dBuV/m	Margin dB	SA reading dBuV	Factor dB	Remark	ANT High cm	Turn Table deg
1	5400.00	52.78	54.00	-1.22	46.78	6.00	Average	209	148
2	5400.00	67.10	74.00	-6.90	61.10	6.00	Peak	209	148
3	5850.00	65.40	78.20	-12.80	58.54	6.86	Peak	209	122
4	5860.00	48.17	54.00	-5.83	41.30	6.87	Average	209	122
5	5860.00	62.45	74.00	-11.55	55.58	6.87	Peak	209	122
6	7766.00	43.51	54.00	-10.49	32.88	10.63	Average	199	196
7	7766.00	54.20	68.20	-14.00	43.57	10.63	Peak	199	196
8	11650.00	46.36	54.00	-7.64	30.56	15.80	Average	305	277
9	11650.00	58.81	74.00	-15.19	43.01	15.80	Peak	305	277

Note 1: Emission Level (dBuV/m) = SA Reading (dBuV/m) + Factor* (dB)

*Factor includes antenna factor , cable loss and amplifier gain

Note 2: Margin (dB) = Emission level (dBuV/m) – Limit (dBuV/m).

3.5.6 Transmitter Radiated Unwanted Emissions (Above 1GHz) for VHT20

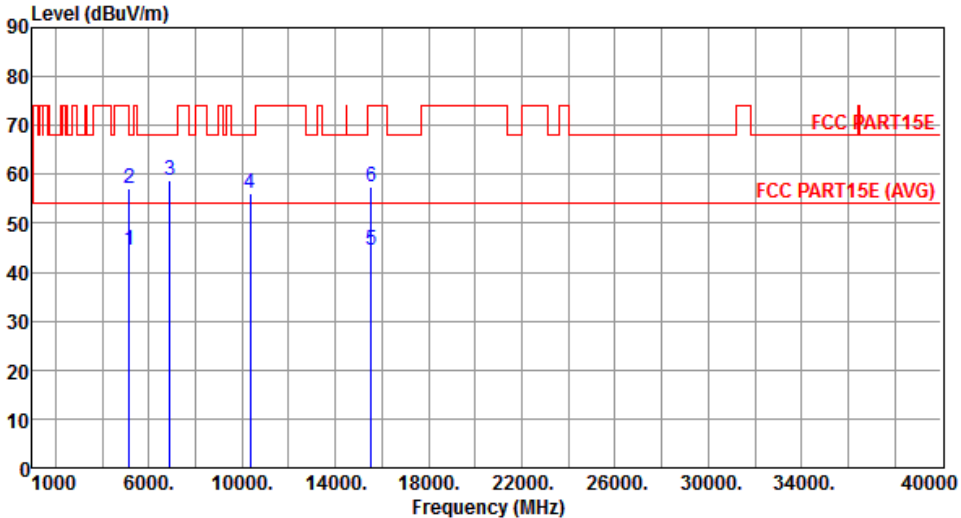
Modulation	VHT20	Test Freq. (MHz)	5180						
Polarization	Horizontal								
									
	Freq.	Emission level	Limit	Margin	SA reading	Factor	Remark	ANT High	Turn Table
	MHz	dBuV/m	dBuV/m	dB	dBuV	dB		cm	deg
1	5150.00	44.57	54.00	-9.43	38.84	5.73	Average	100	31
2	5150.00	57.13	74.00	-16.87	51.40	5.73	Peak	100	31
3	6906.00	58.71	68.20	-9.49	49.49	9.22	Peak	322	71
4	10360.00	56.12	68.20	-12.08	41.63	14.49	Peak	263	63
5	15540.00	44.64	54.00	-9.36	27.94	16.70	Average	269	296
6	15540.00	57.48	74.00	-16.52	40.78	16.70	Peak	269	296
<p>Note 1: Emission Level (dBuV/m) = SA Reading (dBuV/m) + Factor* (dB) *Factor includes antenna factor , cable loss and amplifier gain Note 2: Margin (dB) = Emission level (dBuV/m) – Limit (dBuV/m).</p>									

Modulation	VHT20	Test Freq. (MHz)	5180
Polarization	Vertical		

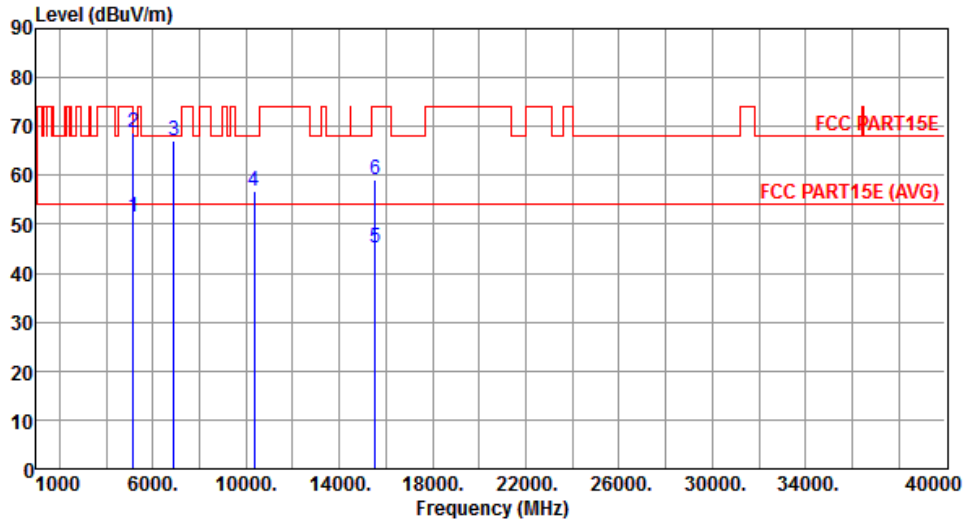

	Freq. MHz	Emission level dBuV/m	Limit dBuV/m	Margin dB	SA reading dBuV	Factor dB	Remark	ANT High cm	Turn Table deg
1	5150.00	51.50	54.00	-2.50	45.77	5.73	Average	147	176
2	5150.00	68.87	74.00	-5.13	63.14	5.73	Peak	180	14
3	6906.00	67.10	68.20	-1.10	57.88	9.22	Peak	319	59
4	10360.00	56.64	68.20	-11.56	42.15	14.49	Peak	183	155
5	15540.00	45.27	54.00	-8.73	28.57	16.70	Average	163	247
6	15540.00	59.18	74.00	-14.82	42.48	16.70	Peak	163	247

Note 1: Emission Level (dBuV/m) = SA Reading (dBuV/m) + Factor* (dB)

*Factor includes antenna factor , cable loss and amplifier gain

Note 2: Margin (dB) = Emission level (dBuV/m) – Limit (dBuV/m).

Modulation	VHT20	Test Freq. (MHz)	5200
Polarization	Horizontal		

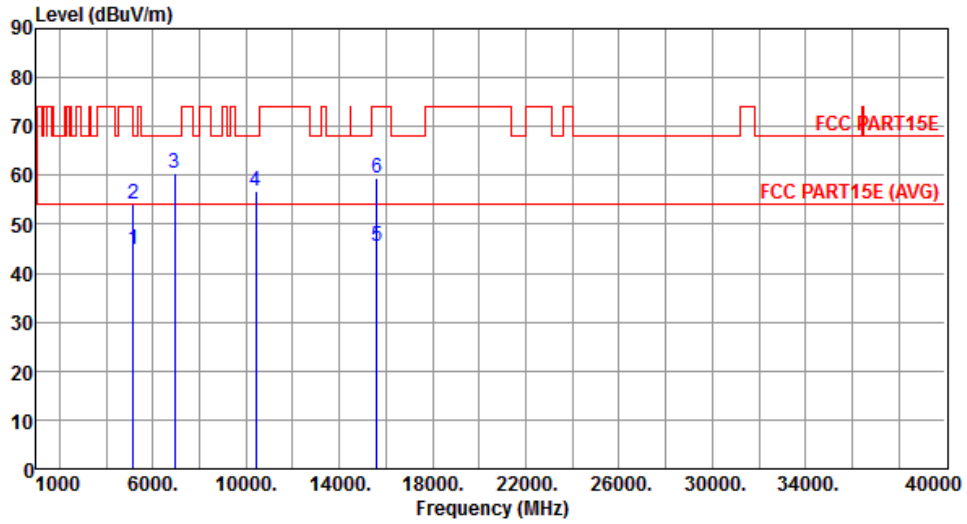

	Freq. MHz	Emission level dBuV/m	Limit dBuV/m	Margin dB	SA reading dBuV	Factor dB	Remark	ANT High cm	Turn Table deg
1	5150.00	44.72	54.00	-9.28	38.99	5.73	Average	351	312
2	5150.00	54.23	74.00	-19.77	48.50	5.73	Peak	351	312
3	6933.00	60.44	68.20	-7.76	51.13	9.31	Peak	103	48
4	10400.00	56.72	68.20	-11.48	42.14	14.58	Peak	325	298
5	15600.00	45.43	54.00	-8.57	28.85	16.58	Average	179	77
6	15600.00	59.41	74.00	-14.59	42.83	16.58	Peak	179	77

Note 1: Emission Level (dBuV/m) = SA Reading (dBuV/m) + Factor* (dB)

*Factor includes antenna factor , cable loss and amplifier gain

Note 2: Margin (dB) = Emission level (dBuV/m) – Limit (dBuV/m).

Modulation	VHT20	Test Freq. (MHz)	5200
Polarization	Vertical		

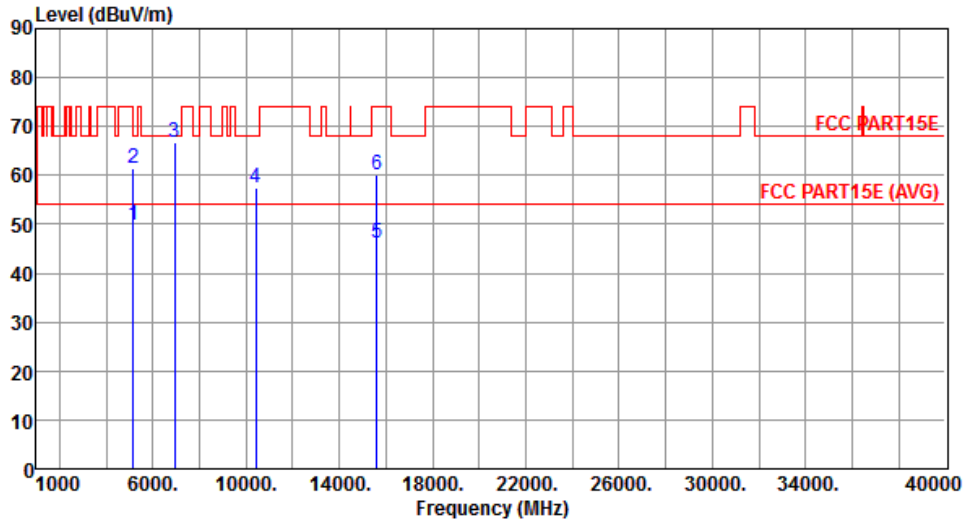

	Freq. MHz	Emission level dBuV/m	Limit dBuV/m	Margin dB	SA reading dBuV	Factor dB	Remark	ANT High cm	Turn Table deg
1	5150.00	49.97	54.00	-4.03	44.24	5.73	Average	149	168
2	5150.00	61.32	74.00	-12.68	55.59	5.73	Peak	149	168
3	6933.00	66.90	68.20	-1.30	57.59	9.31	Peak	312	59
4	10400.00	57.57	68.20	-10.63	42.99	14.58	Peak	347	148
5	15600.00	46.11	54.00	-7.89	29.53	16.58	Average	388	124
6	15600.00	60.10	74.00	-13.90	43.52	16.58	Peak	388	124

Note 1: Emission Level (dBuV/m) = SA Reading (dBuV/m) + Factor* (dB)

*Factor includes antenna factor , cable loss and amplifier gain

Note 2: Margin (dB) = Emission level (dBuV/m) – Limit (dBuV/m).

Modulation	VHT20	Test Freq. (MHz)	5240
Polarization	Horizontal		

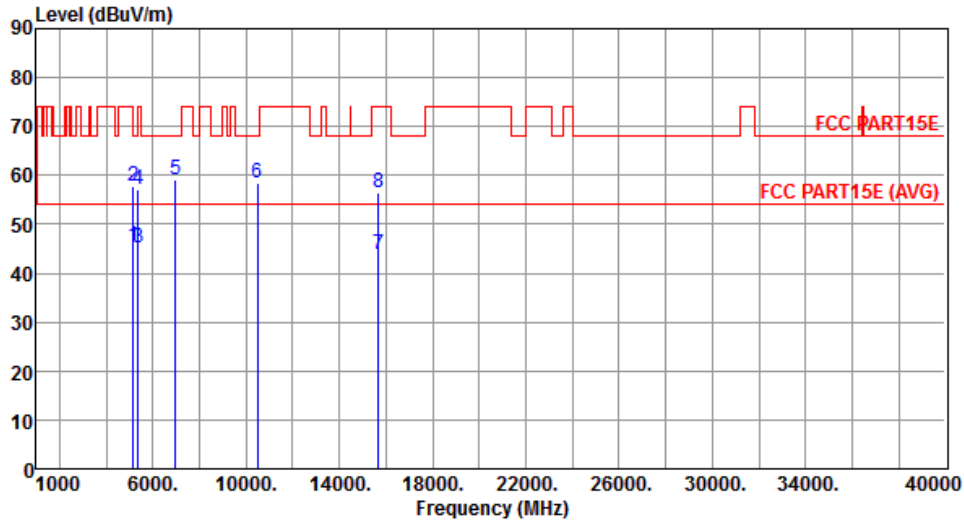

	Freq. MHz	Emission level dBuV/m	Limit dBuV/m	Margin dB	SA reading dBuV	Factor dB	Remark	ANT High cm	Turn Table deg
1	5150.00	45.63	54.00	-8.37	39.90	5.73	Average	288	219
2	5150.00	57.72	74.00	-16.28	51.99	5.73	Peak	288	219
3	5350.00	45.31	54.00	-8.69	39.35	5.96	Average	288	219
4	5350.00	57.17	74.00	-16.83	51.21	5.96	Peak	288	219
5	6986.00	58.98	68.20	-9.22	49.51	9.47	Peak	231	224
6	10480.00	58.42	68.20	-9.78	43.64	14.78	Peak	261	89
7	15660.00	43.97	54.00	-10.03	27.52	16.45	Average	166	198
8	15660.00	56.33	74.00	-17.67	39.88	16.45	Peak	166	198

Note 1: Emission Level (dBuV/m) = SA Reading (dBuV/m) + Factor* (dB)

*Factor includes antenna factor , cable loss and amplifier gain

Note 2: Margin (dB) = Emission level (dBuV/m) – Limit (dBuV/m).

Modulation	VHT20	Test Freq. (MHz)	5240
Polarization	Vertical		

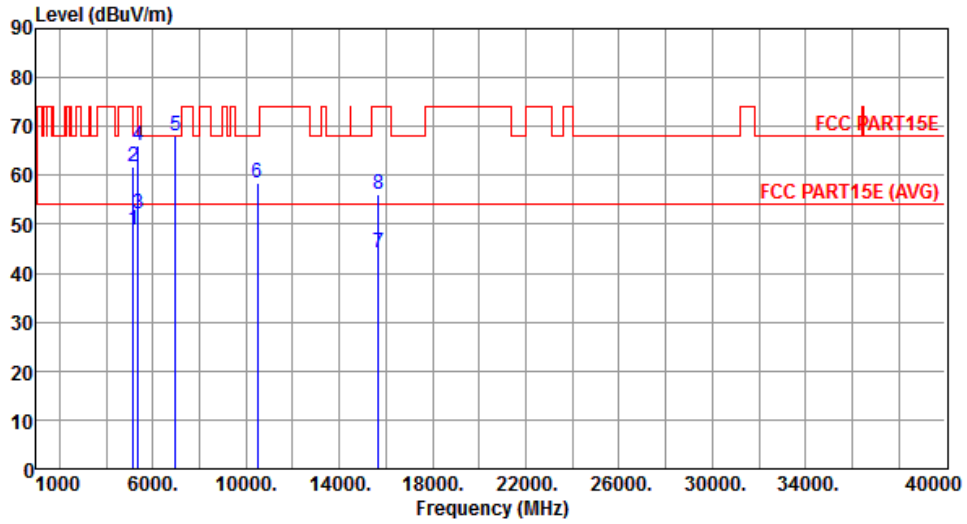

	Freq. MHz	Emission level dBuV/m	Limit dBuV/m	Margin dB	SA reading dBuV	Factor dB	Remark	ANT High cm	Turn Table deg
1	5150.00	48.80	54.00	-5.20	43.07	5.73	Average	204	51
2	5150.00	61.67	74.00	-12.33	55.94	5.73	Peak	204	51
3	5350.00	52.22	54.00	-1.78	46.26	5.96	Average	204	51
4	5350.00	65.97	74.00	-8.03	60.01	5.96	Peak	204	51
5	6986.00	68.07	68.20	-0.13	58.60	9.47	Peak	310	58
6	10480.00	58.42	68.20	-9.78	43.64	14.78	Peak	345	149
7	15660.00	44.06	54.00	-9.94	27.61	16.45	Average	132	108
8	15660.00	56.28	74.00	-17.72	39.83	16.45	Peak	132	108

Note 1: Emission Level (dBuV/m) = SA Reading (dBuV/m) + Factor* (dB)

*Factor includes antenna factor , cable loss and amplifier gain

Note 2: Margin (dB) = Emission level (dBuV/m) – Limit (dBuV/m).

Modulation	VHT20	Test Freq. (MHz)	5745
Polarization	Horizontal		

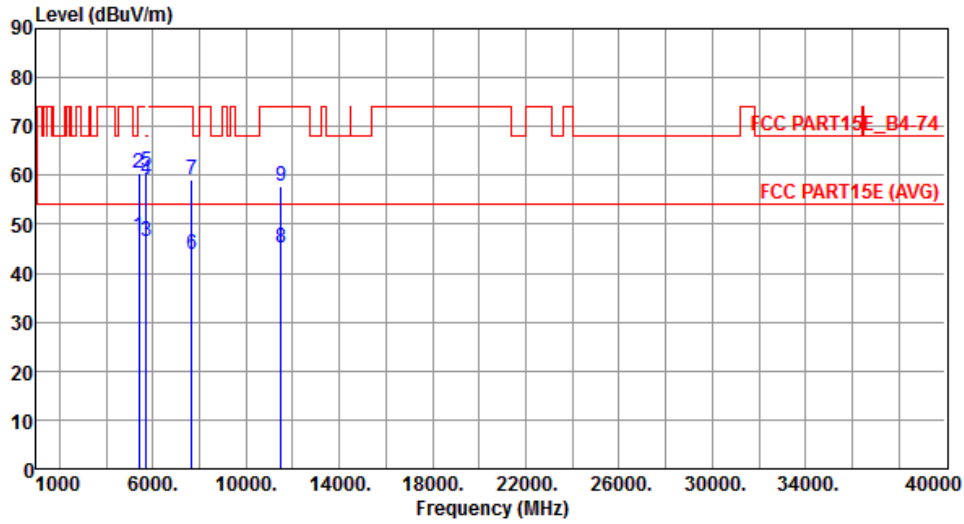

	Freq. MHz	Emission level dBuV/m	Limit dBuV/m	Margin dB	SA reading dBuV	Factor dB	Remark	ANT High cm	Turn Table deg
1	5400.00	47.38	54.00	-6.62	41.38	6.00	Average	273	246
2	5400.00	60.59	74.00	-13.41	54.59	6.00	Peak	273	246
3	5715.00	46.66	54.00	-7.34	40.05	6.61	Average	273	246
4	5715.00	59.22	74.00	-14.78	52.61	6.61	Peak	273	246
5	5725.00	60.91	78.20	-17.29	54.29	6.62	Peak	273	246
6	7660.00	43.71	54.00	-10.29	33.27	10.44	Average	325	313
7	7660.00	59.01	74.00	-14.99	48.57	10.44	Peak	325	313
8	11490.00	45.05	54.00	-8.95	29.02	16.03	Average	299	347
9	11490.00	57.82	74.00	-16.18	41.79	16.03	Peak	299	347

Note 1: Emission Level (dBuV/m) = SA Reading (dBuV/m) + Factor* (dB)

*Factor includes antenna factor , cable loss and amplifier gain

Note 2: Margin (dB) = Emission level (dBuV/m) – Limit (dBuV/m).

Modulation	VHT20	Test Freq. (MHz)	5745
Polarization	Vertical		

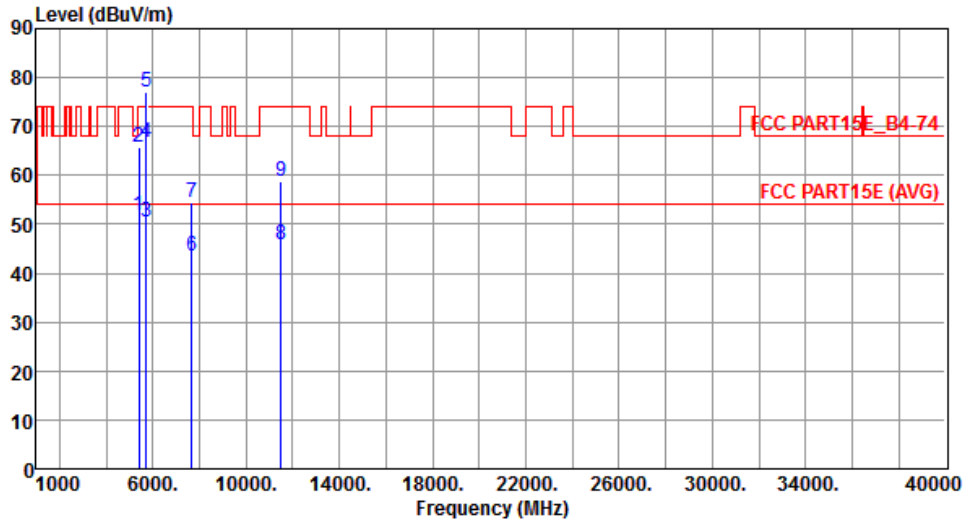

	Freq. MHz	Emission level dBuV/m	Limit dBuV/m	Margin dB	SA reading dBuV	Factor dB	Remark	ANT High cm	Turn Table deg
1	5400.00	51.74	54.00	-2.26	45.74	6.00	Average	206	13
2	5400.00	65.63	74.00	-8.37	59.63	6.00	Peak	206	13
3	5715.00	50.62	54.00	-3.38	44.01	6.61	Average	225	58
4	5715.00	66.61	74.00	-7.39	60.00	6.61	Peak	225	58
5	5725.00	77.18	78.20	-1.02	70.56	6.62	Peak	225	58
6	7660.00	43.53	54.00	-10.47	33.09	10.44	Average	222	289
7	7660.00	54.61	74.00	-19.39	44.17	10.44	Peak	222	289
8	11490.00	45.79	54.00	-8.21	29.76	16.03	Average	309	291
9	11490.00	58.71	74.00	-15.29	42.68	16.03	Peak	309	291

Note 1: Emission Level (dBuV/m) = SA Reading (dBuV/m) + Factor* (dB)

*Factor includes antenna factor , cable loss and amplifier gain

Note 2: Margin (dB) = Emission level (dBuV/m) – Limit (dBuV/m).

Modulation	VHT20	Test Freq. (MHz)	5785
Polarization	Horizontal		

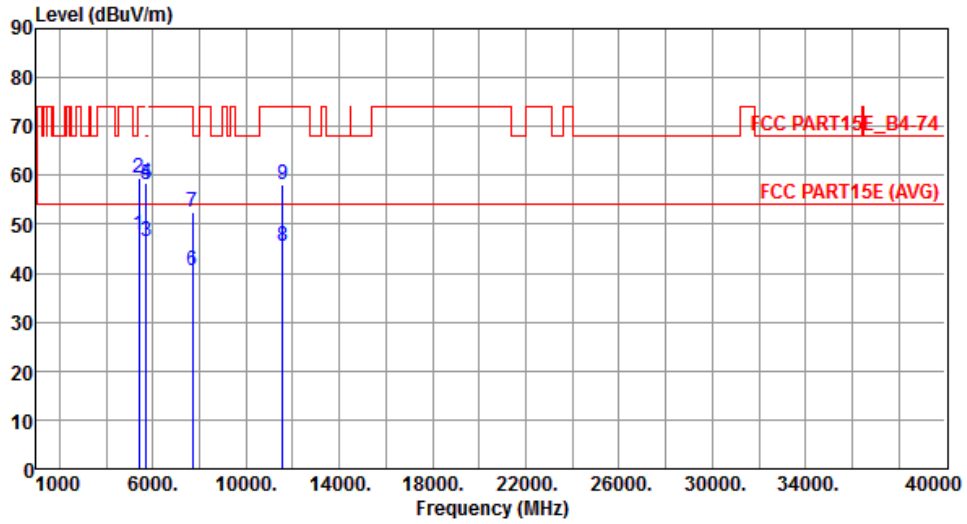

	Freq. MHz	Emission level dBuV/m	Limit dBuV/m	Margin dB	SA reading dBuV	Factor dB	Remark	ANT High cm	Turn Table deg
1	5400.00	47.95	54.00	-6.05	41.95	6.00	Average	301	266
2	5400.00	59.32	74.00	-14.68	53.32	6.00	Peak	301	266
3	5715.00	46.42	54.00	-7.58	39.81	6.61	Average	301	266
4	5715.00	58.49	74.00	-15.51	51.88	6.61	Peak	301	266
5	5725.00	58.17	78.20	-20.03	51.55	6.62	Peak	301	266
6	7713.00	40.53	54.00	-13.47	30.01	10.52	Average	171	277
7	7713.00	52.59	74.00	-21.41	42.07	10.52	Peak	171	277
8	11570.00	45.62	54.00	-8.38	29.70	15.92	Average	381	243
9	11570.00	58.03	74.00	-15.97	42.11	15.92	Peak	381	243

Note 1: Emission Level (dBuV/m) = SA Reading (dBuV/m) + Factor* (dB)

*Factor includes antenna factor , cable loss and amplifier gain

Note 2: Margin (dB) = Emission level (dBuV/m) – Limit (dBuV/m).

Modulation	VHT20	Test Freq. (MHz)	5785
Polarization	Vertical		

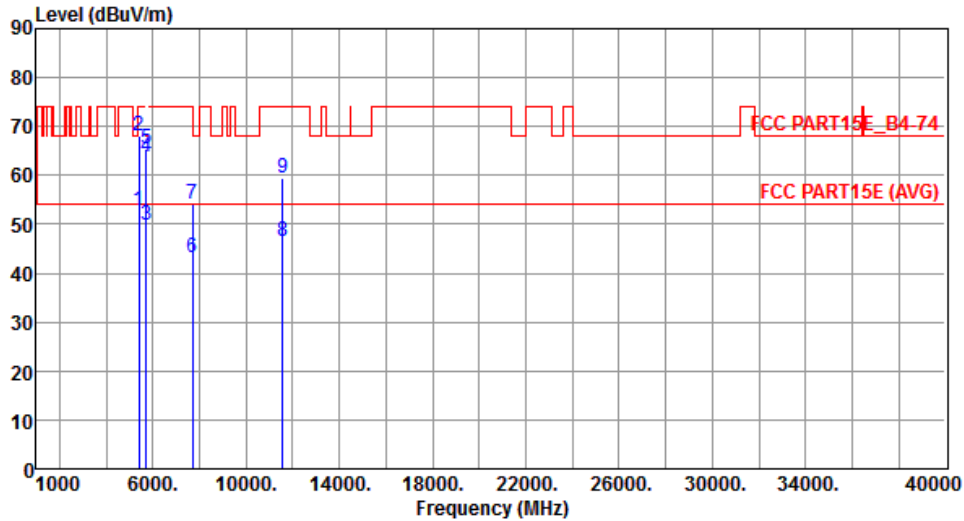

	Freq. MHz	Emission level dBuV/m	Limit dBuV/m	Margin dB	SA reading dBuV	Factor dB	Remark	ANT High cm	Turn Table deg
1	5400.00	52.91	54.00	-1.09	46.91	6.00	Average	209	149
2	5400.00	68.19	74.00	-5.81	62.19	6.00	Peak	209	149
3	5715.00	49.71	54.00	-4.29	43.10	6.61	Average	209	149
4	5715.00	63.71	74.00	-10.29	57.10	6.61	Peak	209	148
5	5725.00	65.52	78.20	-12.68	58.90	6.62	Peak	209	149
6	7713.00	43.33	54.00	-10.67	32.81	10.52	Average	370	251
7	7713.00	54.11	74.00	-19.89	43.59	10.52	Peak	370	251
8	11570.00	46.39	54.00	-7.61	30.47	15.92	Average	222	131
9	11570.00	59.57	74.00	-14.43	43.65	15.92	Peak	215	122

Note 1: Emission Level (dBuV/m) = SA Reading (dBuV/m) + Factor* (dB)

*Factor includes antenna factor , cable loss and amplifier gain

Note 2: Margin (dB) = Emission level (dBuV/m) – Limit (dBuV/m).

Modulation	VHT20	Test Freq. (MHz)	5825
Polarization	Horizontal		

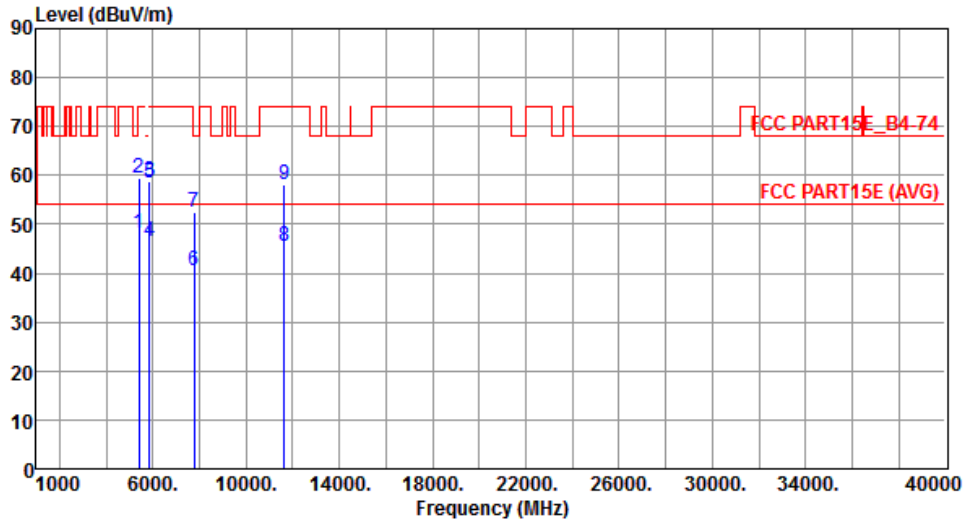

	Freq. MHz	Emission level dBuV/m	Limit dBuV/m	Margin dB	SA reading dBuV	Factor dB	Remark	ANT High cm	Turn Table deg
1	5400.00	48.03	54.00	-5.97	42.03	6.00	Average	293	243
2	5400.00	59.45	74.00	-14.55	53.45	6.00	Peak	293	243
3	5850.00	58.73	78.20	-19.47	51.87	6.86	Peak	293	243
4	5860.00	46.51	54.00	-7.49	39.64	6.87	Average	293	243
5	5860.00	58.58	74.00	-15.42	51.71	6.87	Peak	293	243
6	7766.00	40.61	54.00	-13.39	29.98	10.63	Average	173	311
7	7766.00	52.63	68.20	-15.57	42.00	10.63	Peak	173	311
8	11650.00	45.57	54.00	-8.43	29.77	15.80	Average	359	258
9	11650.00	57.99	74.00	-16.01	42.19	15.80	Peak	359	258

Note 1: Emission Level (dBuV/m) = SA Reading (dBuV/m) + Factor* (dB)

*Factor includes antenna factor , cable loss and amplifier gain

Note 2: Margin (dB) = Emission level (dBuV/m) – Limit (dBuV/m).

Modulation	VHT20	Test Freq. (MHz)	5825
Polarization	Vertical		

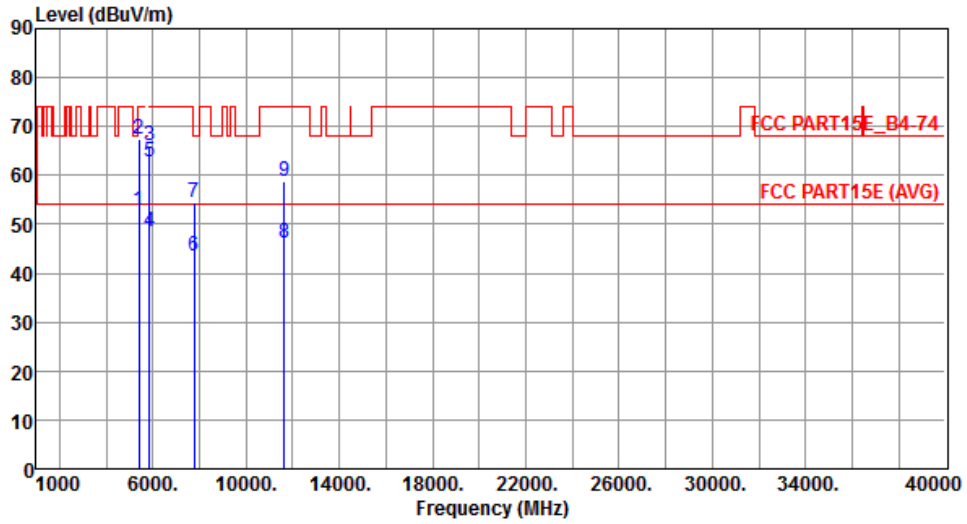

	Freq. MHz	Emission level dBuV/m	Limit dBuV/m	Margin dB	SA reading dBuV	Factor dB	Remark	ANT High cm	Turn Table deg
1	5400.00	52.88	54.00	-1.12	46.88	6.00	Average	205	146
2	5400.00	67.39	74.00	-6.61	61.39	6.00	Peak	205	146
3	5850.00	65.99	78.20	-12.21	59.13	6.86	Peak	218	125
4	5860.00	48.60	54.00	-5.40	41.73	6.87	Average	218	125
5	5860.00	62.93	74.00	-11.07	56.06	6.87	Peak	218	125
6	7766.00	43.63	54.00	-10.37	33.00	10.63	Average	293	237
7	7766.00	54.51	68.20	-13.69	43.88	10.63	Peak	293	237
8	11650.00	46.29	54.00	-7.71	30.49	15.80	Average	312	272
9	11650.00	58.67	74.00	-15.33	42.87	15.80	Peak	312	272

Note 1: Emission Level (dBuV/m) = SA Reading (dBuV/m) + Factor* (dB)

*Factor includes antenna factor , cable loss and amplifier gain

Note 2: Margin (dB) = Emission level (dBuV/m) – Limit (dBuV/m).

3.5.7 Transmitter Radiated Unwanted Emissions (Above 1GHz) for VHT40

Modulation	VHT40	Test Freq. (MHz)	5190
Polarization	Horizontal		

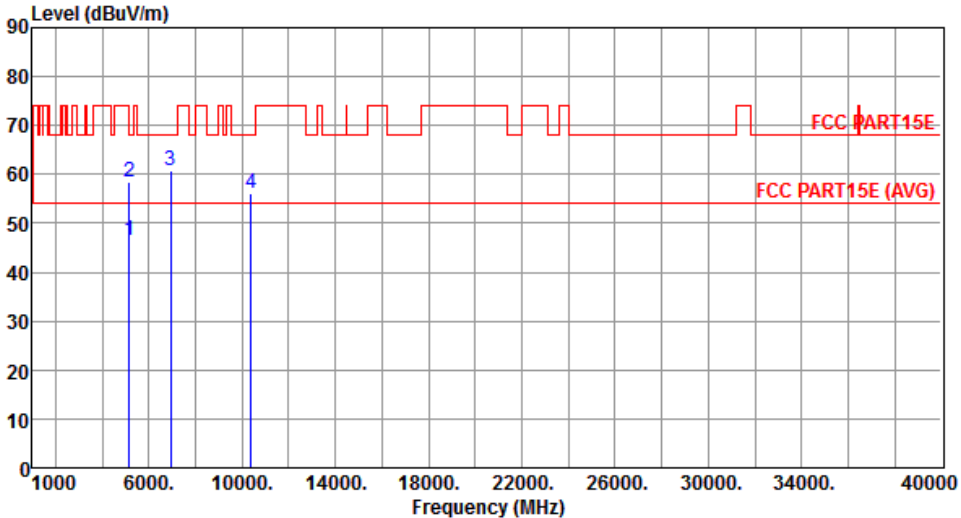

	Freq. MHz	Emission level dBuV/m	Limit dBuV/m	Margin dB	SA reading dBuV	Factor dB	Remark	ANT High cm	Turn Table deg
1	5150.00	46.36	54.00	-7.64	40.63	5.73	Average	258	9
2	5150.00	58.46	74.00	-15.54	52.73	5.73	Peak	258	9
3	6920.00	60.66	68.20	-7.54	51.39	9.27	Peak	358	345
4	10380.00	56.28	68.20	-11.92	41.75	14.53	Peak	322	22

Note 1: Emission Level (dBuV/m) = SA Reading (dBuV/m) + Factor* (dB)
*Factor includes antenna factor , cable loss and amplifier gain
Note 2: Margin (dB) = Emission level (dBuV/m) – Limit (dBuV/m).

Modulation	VHT40	Test Freq. (MHz)	5190
Polarization	Vertical		

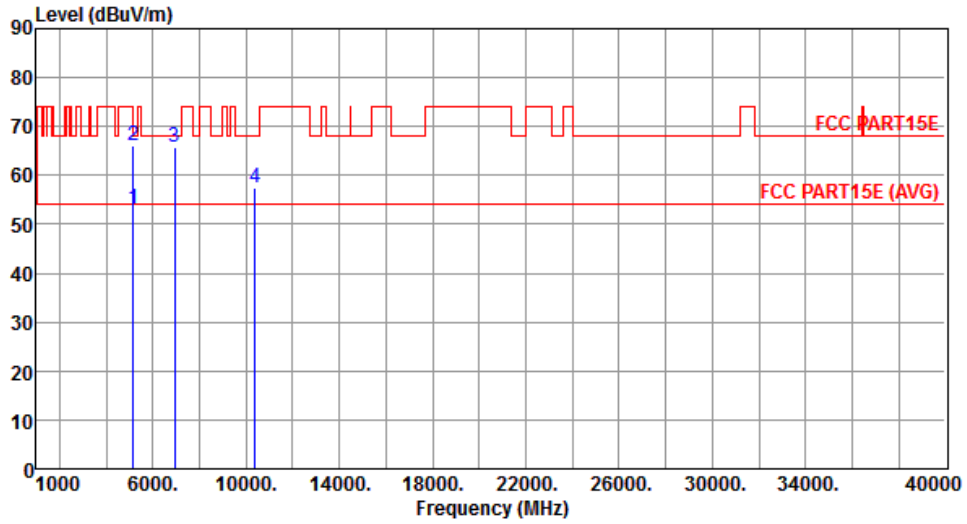

	Freq. MHz	Emission level dBuV/m	Limit dBuV/m	Margin dB	SA reading dBuV	Factor dB	Remark	ANT High cm	Turn Table deg
1	5150.00	52.99	54.00	-1.01	47.26	5.73	Average	189	176
2	5150.00	66.23	74.00	-7.77	60.50	5.73	Peak	189	176
3	6920.00	65.63	68.20	-2.57	56.36	9.27	Peak	186	118
4	10380.00	57.42	68.20	-10.78	42.89	14.53	Peak	186	118

Note 1: Emission Level (dBuV/m) = SA Reading (dBuV/m) + Factor* (dB)

*Factor includes antenna factor , cable loss and amplifier gain

Note 2: Margin (dB) = Emission level (dBuV/m) – Limit (dBuV/m).

Modulation	VHT40	Test Freq. (MHz)	5230
Polarization	Horizontal		

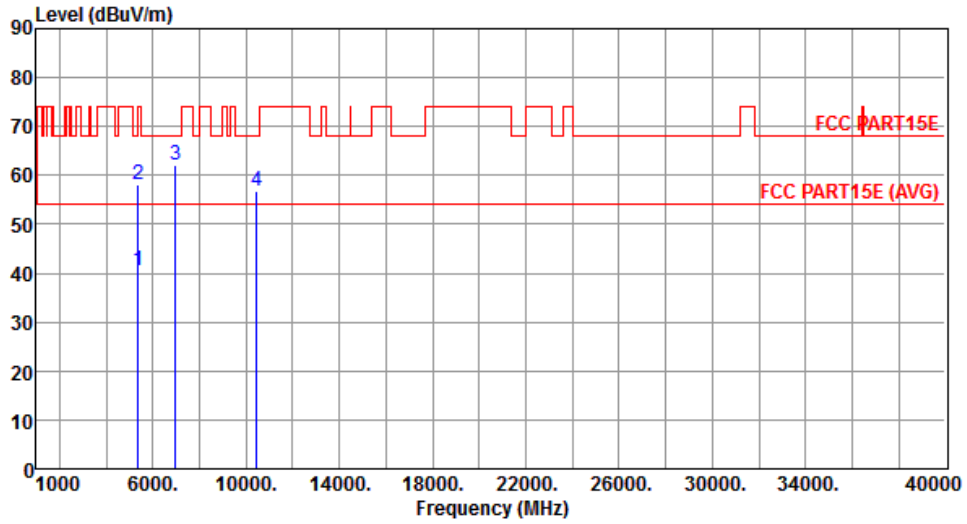

	Freq. MHz	Emission level dBuV/m	Limit dBuV/m	Margin dB	SA reading dBuV	Factor dB	Remark	ANT High cm	Turn Table deg
1	5350.00	40.56	54.00	-13.44	34.60	5.96	Average	325	19
2	5350.00	58.08	74.00	-15.92	52.12	5.96	Peak	325	19
3	6973.00	62.25	68.20	-5.95	52.82	9.43	Peak	285	352
4	10460.00	56.71	68.20	-11.49	41.98	14.73	Peak	232	229

Note 1: Emission Level (dBuV/m) = SA Reading (dBuV/m) + Factor* (dB)

*Factor includes antenna factor , cable loss and amplifier gain

Note 2: Margin (dB) = Emission level (dBuV/m) – Limit (dBuV/m).

Modulation	VHT40	Test Freq. (MHz)	5230
Polarization	Vertical		

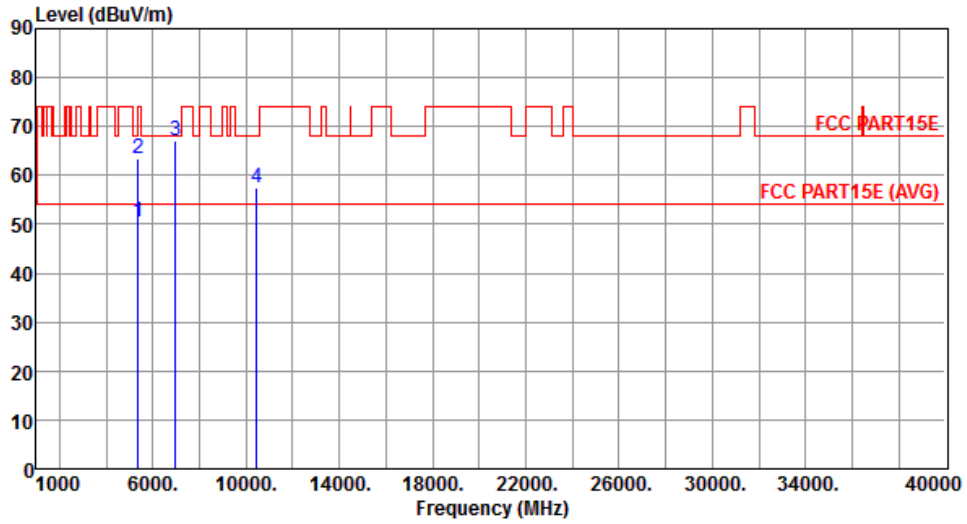

	Freq. MHz	Emission level dBuV/m	Limit dBuV/m	Margin dB	SA reading dBuV	Factor dB	Remark	ANT High cm	Turn Table deg
1	5350.00	50.35	54.00	-3.65	44.39	5.96	Average	219	237
2	5350.00	63.54	74.00	-10.46	57.58	5.96	Peak	219	237
3	6973.00	67.18	68.20	-1.02	57.75	9.43	Peak	339	240
4	10460.00	57.57	68.20	-10.63	42.84	14.73	Peak	219	237

Note 1: Emission Level (dBuV/m) = SA Reading (dBuV/m) + Factor* (dB)

*Factor includes antenna factor , cable loss and amplifier gain

Note 2: Margin (dB) = Emission level (dBuV/m) – Limit (dBuV/m).

Modulation	VHT40	Test Freq. (MHz)	5755
Polarization	Horizontal		

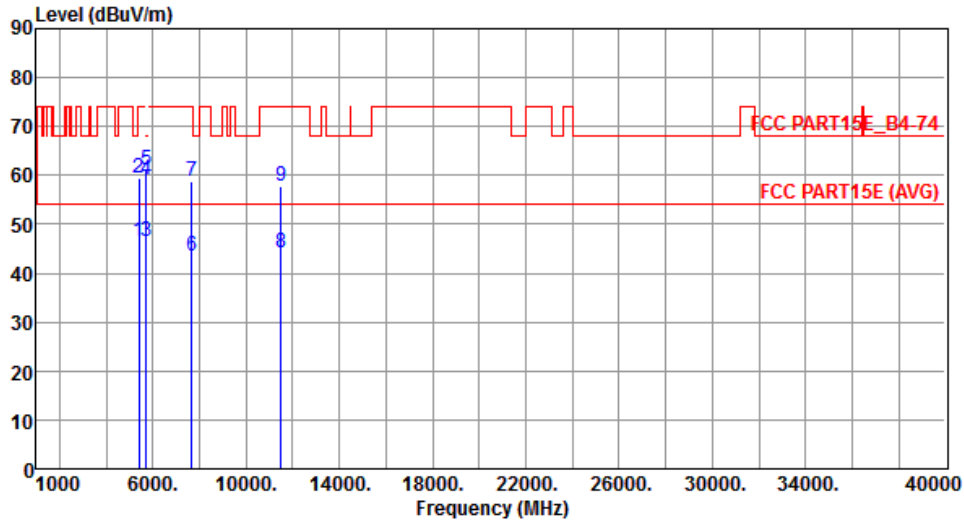

	Freq. MHz	Emission level dBuV/m	Limit dBuV/m	Margin dB	SA reading dBuV	Factor dB	Remark	ANT High cm	Turn Table deg
1	5400.00	46.37	54.00	-7.63	40.37	6.00	Average	270	108
2	5400.00	59.36	74.00	-14.64	53.36	6.00	Peak	270	108
3	5715.00	46.64	54.00	-7.36	40.03	6.61	Average	253	231
4	5715.00	59.17	74.00	-14.83	52.56	6.61	Peak	253	231
5	5725.00	60.99	78.20	-17.21	54.37	6.62	Peak	253	231
6	7673.00	43.64	54.00	-10.36	33.19	10.45	Average	255	356
7	7673.00	58.91	74.00	-15.09	48.46	10.45	Peak	255	356
8	11510.00	44.01	54.00	-9.99	28.00	16.01	Average	240	321
9	11510.00	57.71	74.00	-16.29	41.70	16.01	Peak	240	321

Note 1: Emission Level (dBuV/m) = SA Reading (dBuV/m) + Factor* (dB)

*Factor includes antenna factor , cable loss and amplifier gain

Note 2: Margin (dB) = Emission level (dBuV/m) – Limit (dBuV/m).

Modulation	VHT40	Test Freq. (MHz)	5755
Polarization	Vertical		

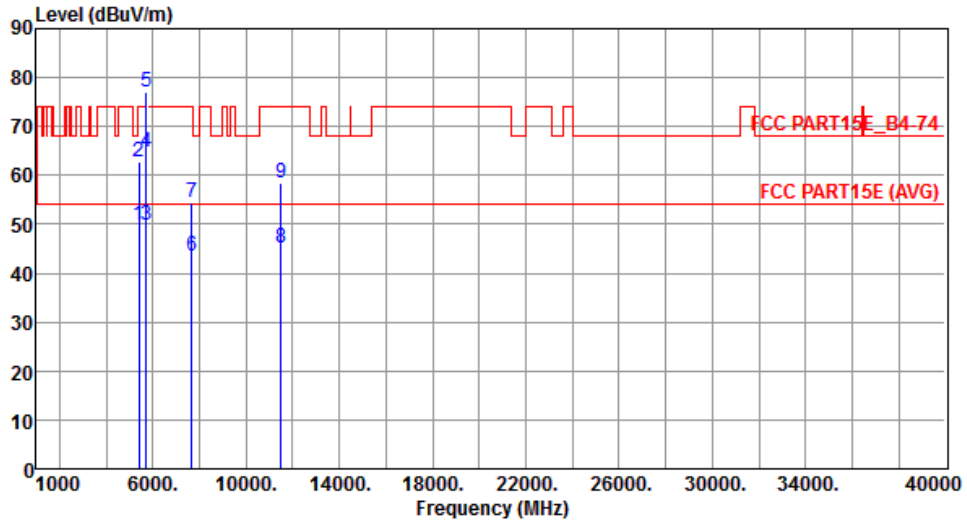

	Freq. MHz	Emission level dBuV/m	Limit dBuV/m	Margin dB	SA reading dBuV	Factor dB	Remark	ANT High cm	Turn Table deg
1	5400.00	49.69	54.00	-4.31	43.69	6.00	Average	206	20
2	5400.00	62.65	74.00	-11.35	56.65	6.00	Peak	206	20
3	5715.00	49.94	54.00	-4.06	43.33	6.61	Average	205	128
4	5715.00	64.77	74.00	-9.23	58.16	6.61	Peak	205	128
5	5725.00	77.04	78.20	-1.16	70.42	6.62	Peak	205	128
6	7673.00	43.43	54.00	-10.57	32.98	10.45	Average	212	284
7	7673.00	54.46	74.00	-19.54	44.01	10.45	Peak	212	284
8	11510.00	45.14	54.00	-8.86	29.13	16.01	Average	255	342
9	11510.00	58.35	74.00	-15.65	42.34	16.01	Peak	255	342

Note 1: Emission Level (dBuV/m) = SA Reading (dBuV/m) + Factor* (dB)

*Factor includes antenna factor , cable loss and amplifier gain

Note 2: Margin (dB) = Emission level (dBuV/m) – Limit (dBuV/m).

Modulation	VHT40	Test Freq. (MHz)	5795
Polarization	Horizontal		

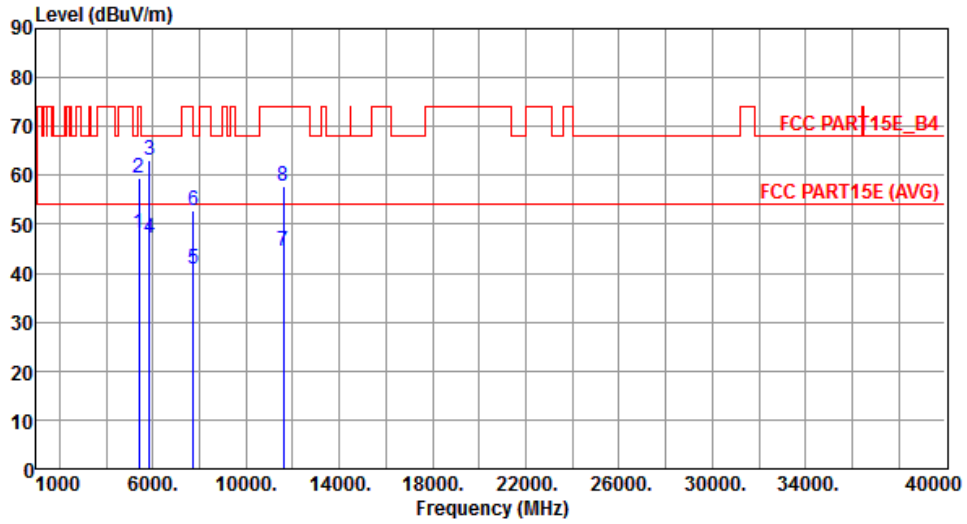

	Freq. MHz	Emission level dBuV/m	Limit dBuV/m	Margin dB	SA reading dBuV	Factor dB	Remark	ANT High cm	Turn Table deg
1	5400.00	48.12	54.00	-5.88	42.12	6.00	Average	253	265
2	5400.00	59.53	74.00	-14.47	53.53	6.00	Peak	253	265
3	5850.00	63.16	78.20	-15.04	56.30	6.86	Peak	253	265
4	5860.00	47.15	68.20	-21.05	40.28	6.87	Peak	253	265
5	7726.00	40.73	54.00	-13.27	30.18	10.55	Average	227	305
6	7726.00	52.81	74.00	-21.19	42.26	10.55	Peak	227	305
7	11590.00	44.44	54.00	-9.56	28.55	15.89	Average	312	332
8	11590.00	57.88	74.00	-16.12	41.99	15.89	Peak	312	332

Note 1: Emission Level (dBuV/m) = SA Reading (dBuV/m) + Factor* (dB)

*Factor includes antenna factor , cable loss and amplifier gain

Note 2: Margin (dB) = Emission level (dBuV/m) – Limit (dBuV/m).

Modulation	VHT40	Test Freq. (MHz)	5795
Polarization	Vertical		

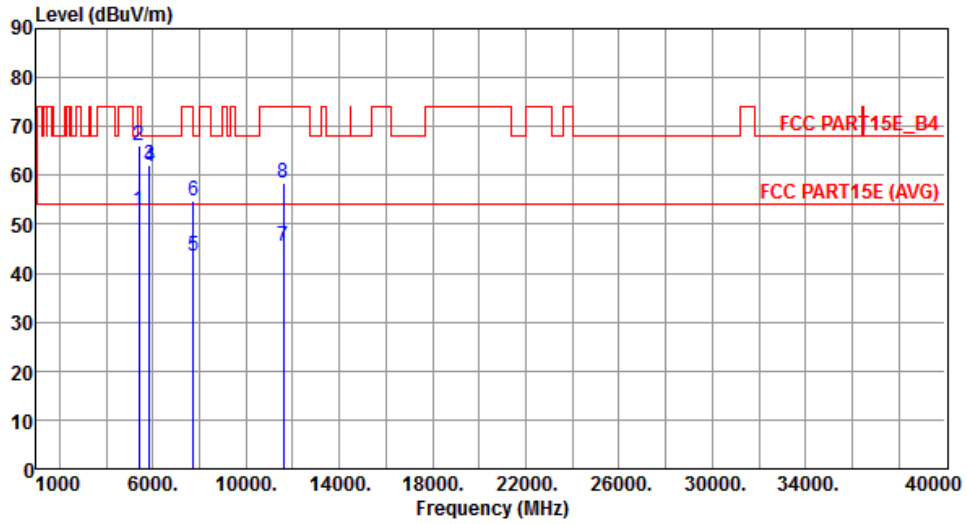

	Freq. MHz	Emission level dBuV/m	Limit dBuV/m	Margin dB	SA reading dBuV	Factor dB	Remark	ANT High cm	Turn Table deg
1	5400.00	52.66	54.00	-1.34	46.66	6.00	Average	210	188
2	5400.00	65.95	74.00	-8.05	59.95	6.00	Peak	210	188
3	5850.00	61.98	78.20	-16.22	55.12	6.86	Peak	212	52
4	5860.00	61.68	68.20	-6.52	54.81	6.87	Peak	212	52
5	7726.00	43.51	54.00	-10.49	32.96	10.55	Average	325	347
6	7726.00	54.88	74.00	-19.12	44.33	10.55	Peak	325	347
7	11590.00	45.52	54.00	-8.48	29.63	15.89	Average	279	347
8	11590.00	58.44	74.00	-15.56	42.55	15.89	Peak	279	347

Note 1: Emission Level (dBuV/m) = SA Reading (dBuV/m) + Factor* (dB)

*Factor includes antenna factor , cable loss and amplifier gain

Note 2: Margin (dB) = Emission level (dBuV/m) – Limit (dBuV/m).

3.5.8 Transmitter Radiated Unwanted Emissions (Above 1GHz) for VHT80

Modulation	VHT80	Test Freq. (MHz)	5210
Polarization	Horizontal		

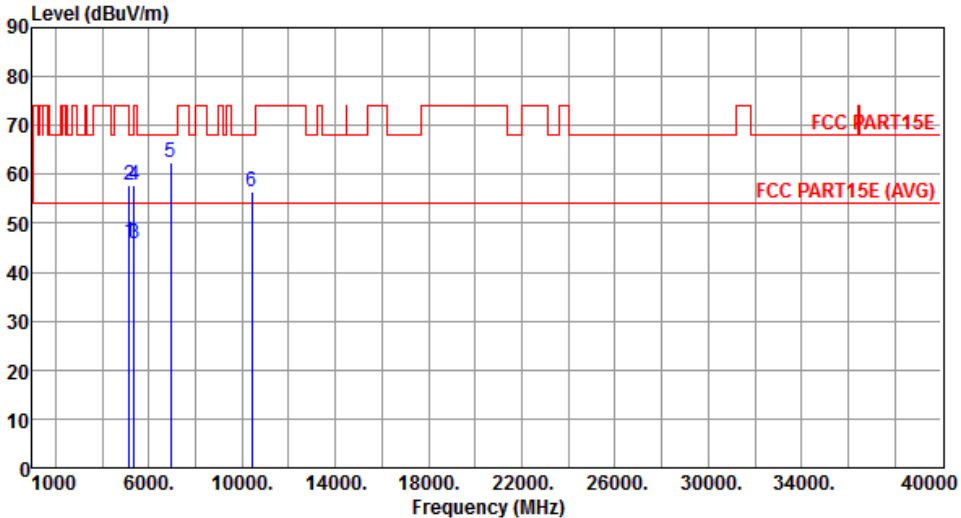

	Freq. MHz	Emission level dBuV/m	Limit dBuV/m	Margin dB	SA reading dBuV	Factor dB	Remark	ANT High cm	Turn Table deg
1	5150.00	46.32	54.00	-7.68	40.59	5.73	Average	249	7
2	5150.00	57.91	74.00	-16.09	52.18	5.73	Peak	249	7
3	5350.00	45.98	54.00	-8.02	40.02	5.96	Average	249	7
4	5350.00	57.71	74.00	-16.29	51.75	5.96	Peak	249	7
5	6946.00	62.34	68.20	-5.86	53.00	9.34	Peak	333	351
6	10420.00	56.43	68.20	-11.77	41.81	14.62	Peak	100	325

Note 1: Emission Level (dBuV/m) = SA Reading (dBuV/m) + Factor* (dB)
*Factor includes antenna factor , cable loss and amplifier gain
Note 2: Margin (dB) = Emission level (dBuV/m) – Limit (dBuV/m).

Modulation	VHT80	Test Freq. (MHz)	5210
Polarization	Vertical		

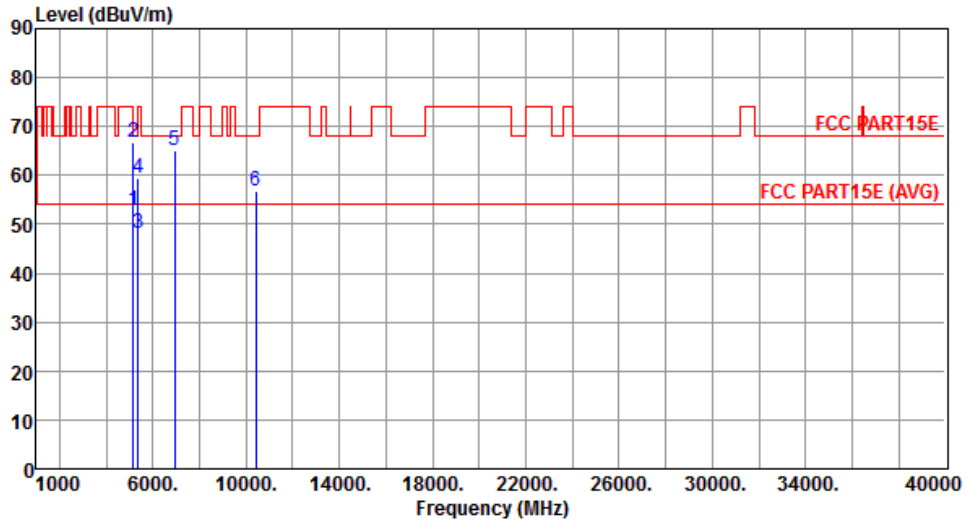

	Freq. MHz	Emission level dBuV/m	Limit dBuV/m	Margin dB	SA reading dBuV	Factor dB	Remark	ANT High cm	Turn Table deg
1	5150.00	52.85	54.00	-1.15	47.12	5.73	Average	215	184
2	5150.00	66.73	74.00	-7.27	61.00	5.73	Peak	215	184
3	5350.00	48.05	54.00	-5.95	42.09	5.96	Average	229	182
4	5350.00	59.41	74.00	-14.59	53.45	5.96	Peak	229	182
5	6946.00	65.00	68.20	-3.20	55.66	9.34	Peak	271	2
6	10420.00	56.83	68.20	-11.37	42.21	14.62	Peak	271	2

Note 1: Emission Level (dBuV/m) = SA Reading (dBuV/m) + Factor* (dB)

*Factor includes antenna factor , cable loss and amplifier gain

Note 2: Margin (dB) = Emission level (dBuV/m) – Limit (dBuV/m).

Modulation	VHT80	Test Freq. (MHz)	5775
Polarization	Horizontal		

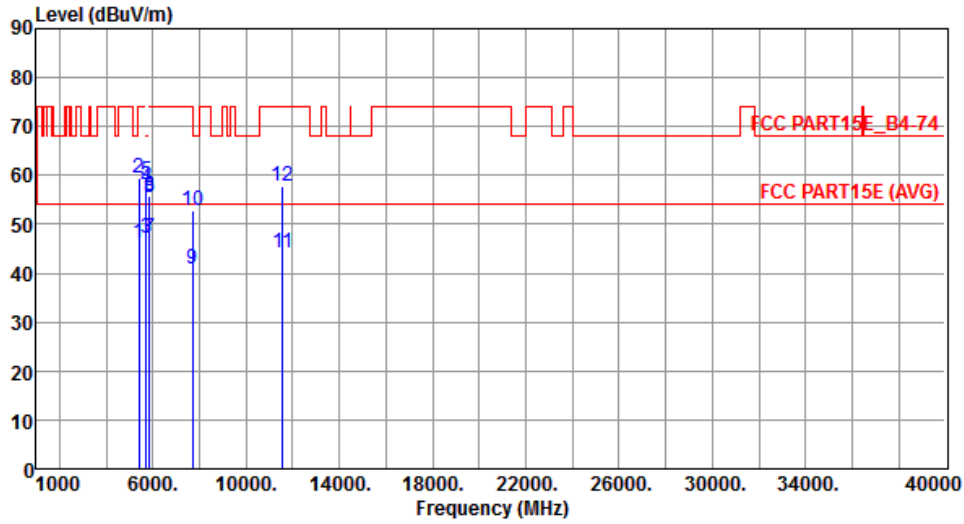

	Freq. MHz	Emission level dBuV/m	Limit dBuV/m	Margin dB	SA reading dBuV	Factor dB	Remark	ANT High cm	Turn Table deg
1	5400.00	46.31	54.00	-7.69	40.31	6.00	Average	271	168
2	5400.00	59.37	74.00	-14.63	53.37	6.00	Peak	271	168
3	5715.00	47.16	54.00	-6.84	40.55	6.61	Average	262	19
4	5715.00	57.33	74.00	-16.67	50.72	6.61	Peak	262	19
5	5725.00	58.86	78.20	-19.34	52.24	6.62	Peak	262	19
6	5850.00	55.85	78.20	-22.35	48.99	6.86	Peak	262	19
7	5860.00	47.00	54.00	-7.00	40.13	6.87	Average	262	19
8	5860.00	55.47	74.00	-18.53	48.60	6.87	Peak	262	19
9	7700.00	40.82	54.00	-13.18	30.32	10.50	Average	296	345
10	7700.00	52.91	74.00	-21.09	42.41	10.50	Peak	296	345
11	11550.00	44.17	54.00	-9.83	28.22	15.95	Average	315	39
12	11550.00	57.81	74.00	-16.19	41.86	15.95	Peak	315	39

Note 1: Emission Level (dBuV/m) = SA Reading (dBuV/m) + Factor* (dB)

*Factor includes antenna factor , cable loss and amplifier gain

Note 2: Margin (dB) = Emission level (dBuV/m) – Limit (dBuV/m).

Modulation	VHT80	Test Freq. (MHz)	5775
Polarization	Vertical		

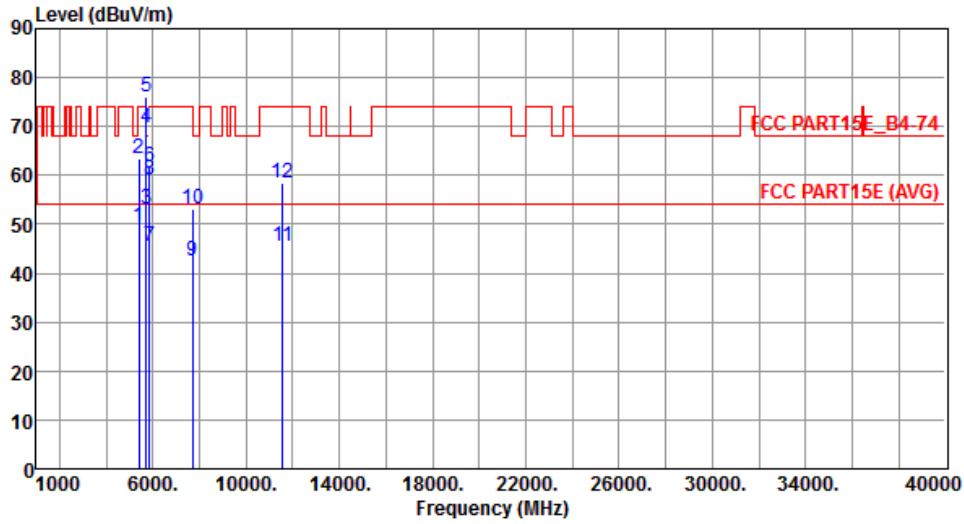

	Freq. MHz	Emission level dBuV/m	Limit dBuV/m	Margin dB	SA reading dBuV	Factor dB	Remark	ANT High cm	Turn Table deg
1	5400.00	49.63	54.00	-4.37	43.63	6.00	Average	220	189
2	5400.00	63.30	74.00	-10.70	57.30	6.00	Peak	220	189
3	5715.00	52.98	54.00	-1.02	46.37	6.61	Average	225	229
4	5715.00	69.73	74.00	-4.27	63.12	6.61	Peak	225	229
5	5725.00	76.13	78.20	-2.07	69.51	6.62	Peak	225	229
6	5850.00	61.71	78.20	-16.49	54.85	6.86	Peak	225	229
7	5860.00	45.40	54.00	-8.60	38.53	6.87	Average	225	229
8	5860.00	58.95	74.00	-15.05	52.08	6.87	Peak	225	229
9	7700.00	42.62	54.00	-11.38	32.12	10.50	Average	325	246
10	7700.00	53.05	74.00	-20.95	42.55	10.50	Peak	325	246
11	11550.00	45.35	54.00	-8.65	29.40	15.95	Average	310	32
12	11550.00	58.34	74.00	-15.66	42.39	15.95	Peak	310	32

Note 1: Emission Level (dBuV/m) = SA Reading (dBuV/m) + Factor* (dB)

*Factor includes antenna factor , cable loss and amplifier gain

Note 2: Margin (dB) = Emission level (dBuV/m) – Limit (dBuV/m).

3.6 Frequency Stability

3.6.1 Limit of Frequency Stability

Manufacturers of U-NII devices are responsible for ensuring frequency stability such that an emission is maintained within the band of operation under all conditions of normal operation as specified in the user's manual.

3.6.2 Test Procedures

1. The EUT is installed in an environment test chamber with external power source.
2. Set the chamber to operate at 50 centigrade and external power source to output at nominal voltage of EUT.
3. A sufficient stabilization period at each temperature is used prior to each frequency measurement.
4. When temperature is stabled, measure the frequency stability.
5. The test shall be performed under -40 to 85 centigrade and 85 to 115 percent of the nominal voltage. Change setting of chamber and external power source to complete all conditions.

3.6.3 Test Setup

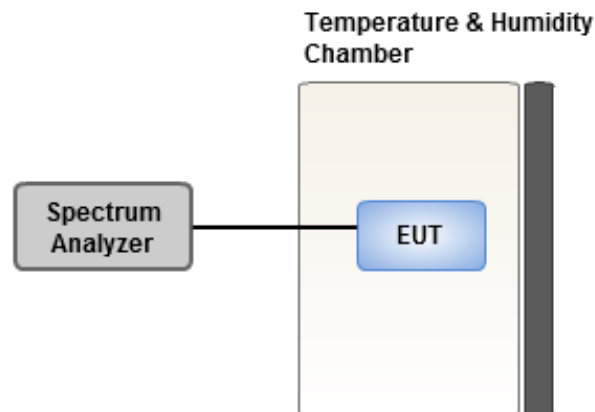

3.6.4 Test Result of Frequency Stability

Frequency: 5200 MHz	Frequency Drift (ppm)			
	0 minute	2 minutes	5 minutes	10 minutes
T20°CVmax	0.41	0.33	0.34	0.30
T20°CVmin	0.00	0.39	-0.37	-0.21
T85°CVnom	1.06	0.81	1.21	1.81
T80°CVnom	0.21	0.21	-0.24	0.21
T70°CVnom	0.02	0.34	0.37	0.56
T60°CVnom	0.03	0.18	-0.06	-0.01
T50°CVnom	1.21	1.55	1.90	1.42
T40°CVnom	-0.03	0.15	0.11	0.65
T30°CVnom	0.22	-0.09	0.12	0.35
T20°CVnom	0.05	0.81	0.62	0.08
T10°CVnom	1.06	1.06	1.41	0.98
T0°CVnom	0.10	0.69	-0.05	0.73
T-10°CVnom	0.06	-0.07	0.68	0.13
T-20°CVnom	0.09	0.13	0.63	0.24
T-30°CVnom	-0.10	-0.05	0.32	-0.25
T-40°CVnom	-0.13	0.37	-0.36	0.72
Vnom [Vac]: 120		Vmax [Vac]: 138		Vmin [Vac]: 102
Tnom [°C]: 20		Tmax [°C]: 85		Tmin [°C]: -40

Frequency: 5785 MHz	Frequency Drift (ppm)			
Temperature (°C)	0 minute	2 minutes	5 minutes	10 minutes
T20°CVmax	0.46	0.34	0.67	0.64
T20°CVmin	-0.13	-0.08	-0.30	-0.08
T85°CVnom	0.79	1.23	1.01	0.73
T80°CVnom	0.59	0.52	0.38	0.30
T70°CVnom	0.32	0.87	-0.02	0.86
T60°CVnom	0.19	0.53	-0.18	0.27
T50°CVnom	0.77	0.95	1.40	0.62
T40°CVnom	-0.01	-0.19	0.48	0.25
T30°CVnom	0.19	0.62	0.58	0.60
T20°CVnom	0.13	0.16	0.17	0.57
T10°CVnom	1.12	0.91	1.37	1.00
T0°CVnom	0.85	1.04	1.15	1.18
T-10°CVnom	0.52	0.28	0.05	0.55
T-20°CVnom	0.47	0.38	0.94	1.06
T-30°CVnom	0.08	0.57	0.08	-0.40
T-40°CVnom	-0.51	-0.83	-0.16	-0.44
Vnom [Vac]: 120		Vmax [Vac]: 138		Vmin [Vac]: 102
Tnom [°C]: 20		Tmax [°C]: 85		Tmin [°C]: -40

4 Test laboratory information

Established in 2012, ICC provides foremost EMC & RF Testing and advisory consultation services by our skilled engineers and technicians. Our services employ a wide variety of advanced edge test equipment and one of the widest certification extents in the business.

International Certification Corp, it is our definitive objective is to institute long term, trust-based associations with our clients. The expectation we set up with our clients is based on outstanding service, practical expertise and devotion to a certified value structure. Our passion is to grant our clients with best EMC / RF services by oriented knowledgeable and accommodating staff.

Our Test sites are located at Linkou District and Kwei Shan Hsiang. Location map can be found on our website <http://www.icertifi.com.tw>.

Linkou

Tel: 886-2-2601-1640

No. 30-2, Ding Fwu Tsuen, Lin Kou
District, New Taipei City, Taiwan,
R.O.C.

Kwei Shan

Tel: 886-3-271-8666

No. 3-1, Lane 6, Wen San 3rd
St., Kwei Shan Hsiang, Tao Yuan
Hsien 333, Taiwan, R.O.C.

Kwei Shan Site II

Tel: 886-3-271-8640

No. 14-1, Lane 19, Wen San 3rd
St., Kwei Shan Hsiang, Tao Yuan
Hsien 333, Taiwan, R.O.C.

If you have any suggestion, please feel free to contact us as below information

Tel: 886-3-271-8666

Fax: 886-3-318-0155

Email: ICC_Service@icertifi.com.tw

==END==