

FCC Test Report (WLAN)

Report No.: RF190626E05-1

FCC ID: RYK-WPEA251ACNIBT

Test Model: WPEA-251ACNI(BT)

Received Date: June 26, 2019

Test Date: July 22 to 25, 2019

Issued Date: Nov. 06, 2019

Applicant: SparkLAN Communications, Inc.

Address: 8F., No.257, Sec. 2, Tiding Blvd., Neihu District, Taipei City 11493, Taiwan (R.O.C.)

Issued By: Bureau Veritas Consumer Products Services (H.K.) Ltd., Taoyuan Branch
Hsin Chu Laboratory

Lab Address: E-2, No.1, Li Hsin 1st Road, Hsinchu Science Park, Hsinchu City 300, Taiwan.

Test Location: E-2, No.1, Li Hsin 1st Road, Hsinchu Science Park, Hsinchu City 300, Taiwan.

**FCC Registration /
Designation Number:** 723255 / TW2022



This report is for your exclusive use. Any copying or replication of this report to or for any other person or entity, or use of our name or trademark, is permitted only with our prior written permission. This report sets forth our findings solely with respect to the test samples identified herein. The results set forth in this report are not indicative or representative of the quality or characteristics of the lot from which a test sample was taken or any similar or identical product unless specifically and expressly noted. Our report includes all of the tests requested by you and the results thereof based upon the information that you provided to us. You have 60 days from date of issuance of this report to notify us of any material error or omission caused by our negligence, provided, however, that such notice shall be in writing and shall specifically address the issue you wish to raise. A failure to raise such issue within the prescribed time shall constitute your unqualified acceptance of the completeness of this report, the tests conducted and the correctness of the report contents. Unless specific mention, the uncertainty of measurement has been explicitly taken into account to declare the compliance or non-compliance to the specification. The report must not be used by the client to claim product certification, approval, or endorsement by TAF or any government agencies.

Table of Contents

Release Control Record	4
1 Certificate of Conformity	5
2 Summary of Test Results	6
2.1 Measurement Uncertainty	6
2.2 Modification Record	6
3 General Information	7
3.1 General Description of EUT	7
3.2 Description of Test Modes	9
3.2.1 Test Mode Applicability and Tested Channel Detail	11
3.3 Duty Cycle of Test Signal	13
3.4 Description of Support Units	14
3.4.1 Configuration of System under Test	14
3.5 General Description of Applied Standard	15
4 Test Types and Results	16
4.1 Radiated Emission and Bandedge Measurement	16
4.1.1 Limits of Radiated Emission and Bandedge Measurement	16
4.1.2 Test Instruments	17
4.1.3 Test Procedure	19
4.1.4 Deviation from Test Standard	19
4.1.5 Test Setup	20
4.1.6 EUT Operating Condition	21
4.1.7 Test Results	22
4.2 Conducted Emission Measurement	66
4.2.1 Limits of Conducted Emission Measurement	66
4.2.2 Test Instruments	66
4.2.3 Test Procedure	67
4.2.4 Deviation from Test Standard	67
4.2.5 Test Setup	67
4.2.6 EUT Operating Condition	67
4.2.7 Test Results	68
4.3 Transmit Power Measurement	70
4.3.1 Limits of Transmit Power Measurement	70
4.3.2 Test Setup	70
4.3.3 Test Instruments	71
4.3.4 Test Procedure	71
4.3.5 Deviation from Test Standard	71
4.3.6 EUT Operating Condition	71
4.3.7 Test Results	72
4.4 Occupied Bandwidth Measurement	80
4.4.1 Test Setup	80
4.4.2 Test Instruments	80
4.4.3 Test Procedure	80
4.4.4 Test Results	81
4.5 Peak Power Spectral Density Measurement	86
4.5.1 Limits of Peak Power Spectral Density Measurement	86
4.5.2 Test Setup	86
4.5.3 Test Instruments	86
4.5.4 Test Procedure	86
4.5.5 Deviation from Test Standard	87
4.5.6 EUT Operating Condition	87
4.5.7 Test Results	88
4.6 Frequency Stability Measurement	95
4.6.1 Limits of Frequency Stability Measurement	95

4.6.2	Test Setup.....	95
4.6.3	Test Instruments	95
4.6.4	Test Procedure	95
4.6.5	Deviation from Test Standard	95
4.6.6	EUT Operating Condition	95
4.6.7	Test Results	96
4.7	6dB Bandwidth Measurement	97
4.7.1	Limits of 6dB Bandwidth Measurement.....	97
4.7.2	Test Setup.....	97
4.7.3	Test Instruments	97
4.7.4	Test Procedure	97
4.7.5	Deviation from Test Standard	97
4.7.6	EUT Operating Condition	97
4.7.7	Test Results	98
5	Pictures of Test Arrangements.....	100
	Annex A- Radiated Out of Band Emission (OOBE) Measurement (For U-NII-3 band).....	101
	Appendix – Information of the Testing Laboratories	104

Release Control Record

Issue No.	Description	Date Issued
RF190626E05-1	Original release.	Nov. 06, 2019

1 Certificate of Conformity

Product: 802.11ac/b/g/n Wi-Fi+BT Module

Brand: Sparklan

Test Model: WPEA-251ACNI(BT)

Sample Status: ENGINEERING SAMPLE

Applicant: SparkLAN Communications, Inc.

Test Date: July 22 to 25, 2019

Standard: 47 CFR FCC Part 15, Subpart E (Section 15.407)
ANSI C63.10: 2013

The above equipment has been tested by **Bureau Veritas Consumer Products Services (H.K.) Ltd., Taoyuan Branch**, and found compliance with the requirement of the above standards. The test record, data evaluation & Equipment Under Test (EUT) configurations represented herein are true and accurate accounts of the measurements of the sample's EMC characteristics under the conditions specified in this report.

Prepared by : Wendy Wu , **Date:** Nov. 06, 2019
Wendy Wu / Specialist

Approved by : Clark Lin , **Date:** Nov. 06, 2019
Clark Lin / Technical Manager

2 Summary of Test Results

47 CFR FCC Part 15, Subpart E (Section 15.407)			
FCC Clause	Test Item	Result	Remarks
15.407(b)(6)	AC Power Conducted Emissions	Pass	Meet the requirement of limit. Minimum passing margin is -6.32dB at 0.44297MHz.
15.407(b) (1/2/3/4(i/ii)/6)	Radiated Emissions & Band Edge Measurement*	Pass	Meet the requirement of limit. Minimum passing margin is -0.1dB at 5725.00MHz.
15.407(a)(1/2/3)	Max Average Transmit Power	Pass	Meet the requirement of limit.
---	Occupied Bandwidth Measurement	-	Reference only.
15.407(a)(1/2/3)	Peak Power Spectral Density	Pass	Meet the requirement of limit.
15.407(e)	6dB bandwidth	Pass	Meet the requirement of limit. (U-NII-3 Band only)
15.407(g)	Frequency Stability	Pass	Meet the requirement of limit.
15.203	Antenna Requirement	Pass	Antenna connector is IPEX MHF 1 not a standard connector.

*For U-NII-3 band compliance with rule part 15.407(b)(4)(i), the OOB test plots were recorded in Annex A.

Note:

Determining compliance based on the results of the compliance measurement, not taking into account measurement instrumentation uncertainty.

2.1 Measurement Uncertainty

Where relevant, the following measurement uncertainty levels have been estimated for tests performed on the EUT as specified in CISPR 16-4-2:

Measurement	Frequency	Expanded Uncertainty (k=2) (\pm)
Conducted Emissions at mains ports	150kHz ~ 30MHz	1.8 dB
Radiated Emissions up to 1 GHz	30MHz ~ 1GHz	4.8 dB
Radiated Emissions above 1 GHz	1GHz ~ 6GHz	5.0 dB
	6GHz ~ 18GHz	5.0 dB
	18GHz ~ 40GHz	5.3 dB

2.2 Modification Record

There were no modifications required for compliance.

3 General Information

3.1 General Description of EUT

Product	802.11ac/b/g/n Wi-Fi+BT Module
Brand	Sparklan
Test Model	WPEA-251ACNI(BT)
Status of EUT	ENGINEERING SAMPLE
Power Supply Rating	3.3Vdc from host equipment
Modulation Type	CCK, DQPSK, DBPSK for DSSS 64QAM, 16QAM, QPSK, BPSK for OFDM 256QAM for OFDM in 11ac mode
Modulation Technology	DSSS,OFDM
Transfer Rate	802.11b: up to 11Mbps 802.11a/g: up to 54Mbps 802.11n: up to 300Mbps 802.11ac: up to 866.7Mbps
Operating Frequency	2.4GHz: 2.412 ~ 2.462GHz 5GHz: 5.18~ 5.24GHz, 5.26GHz ~ 5.32GHz, 5.50GHz ~ 5.72GHz, 5.745 ~ 5.825GHz
Number of Channel	2.4GHz: 802.11b, 802.11g, 802.11n (HT20): 11 802.11n (HT40): 7 5GHz: 802.11a, 802.11n (HT20), 802.11ac (VHT20): 25 802.11n (HT40), 802.11ac (VHT40): 12 802.11ac (VHT80): 6
Output Power	2.4GHz: 371.591 mW 5.18 ~ 5.24GHz: 45.406 mW 5.26 ~ 5.32GHz: 43.668 mW 5.5 ~ 5.72GHz: 46.392 mW 5.745 ~ 5.825GHz: 46.658 mW
Antenna Type	Refer to Note
Antenna Connector	Refer to Note
Accessory Device	NA
Data Cable Supplied	NA

Note:

1. Simultaneously transmission condition.

Condition	Technology	
1	WLAN 5GHz	Bluetooth

Note: The emission of the simultaneous operation has been evaluated and no non-compliance was found.

2. The antennas provided to the EUT, please refer to the following table:

Ant. Set	Transmitter Circuit	Brand	Model	Ant. Type	2.4GHz Gain with cable loss (dBi)	5GHz Gain with cable loss (dBi)	Connector Type
1	Chain (0) Chain (1)	Sparklan	AD-300N	Dipole	3	5	RP-SMA
2	Chain (0) Chain (1)	Sparklan	AD-103AG	Dipole	2.02	2.03	
3	Chain (0) Chain (1)	Sparklan	AD-302N	Dipole	3	2	
4	Chain (0) Chain (1)	Sparklan	AD-303N	Dipole	3	3	

Note: Max. gain was selected for final test.

3. The EUT incorporates a MIMO function.

2.4GHz Band		
MODULATION MODE	TX & RX CONFIGURATION	
802.11b	2TX	2RX
802.11g	2TX	2RX
802.11n (HT20)	2TX	2RX
802.11n (HT40)	2TX	2RX
5GHz Band		
MODULATION MODE	TX & RX CONFIGURATION	
802.11a	2TX	2RX
802.11n (HT20)	2TX	2RX
802.11n (HT40)	2TX	2RX
802.11ac (VHT20)	2TX	2RX
802.11ac (VHT40)	2TX	2RX
802.11ac (VHT80)	2TX	2RX

Note: The modulation and bandwidth are similar for 802.11n mode for 20MHz (40MHz) and 802.11ac mode for 20MHz (40MHz), therefore investigated worst case to representative mode in test report.

4. The above EUT information is declared by manufacturer and for more detailed features description, please refers to the manufacturer's specifications or user's manual.

3.2 Description of Test Modes

FOR 5180 ~ 5240MHz

4 channels are provided for 802.11a, 802.11n (HT20), 802.11ac (VHT20):

Channel	Frequency	Channel	Frequency
36	5180 MHz	44	5220 MHz
40	5200 MHz	48	5240 MHz

2 channels are provided for 802.11n (HT40), 802.11ac (VHT40):

Channel	Frequency	Channel	Frequency
38	5190 MHz	46	5230 MHz

1 channel is provided for 802.11ac (VHT80):

Channel	Frequency
42	5210 MHz

FOR 5260 ~ 5320MHz

4 channels are provided for 802.11a, 802.11n (HT20), 802.11ac (VHT20):

Channel	Frequency	Channel	Frequency
52	5260 MHz	60	5300 MHz
56	5280 MHz	64	5320 MHz

2 channels are provided for 802.11n (HT40), 802.11ac (VHT40):

Channel	Frequency	Channel	Frequency
54	5270 MHz	62	5310 MHz

1 channel is provided for 802.11ac (VHT80):

Channel	Frequency
58	5290 MHz

FOR 5500 ~ 5720MHz

12 channels are provided for 802.11a, 802.11n (HT20), 802.11ac (VHT20):

Channel	Frequency	Channel	Frequency
100	5500 MHz	124	5620 MHz
104	5520 MHz	128	5640 MHz
108	5540 MHz	132	5660 MHz
112	5560 MHz	136	5680 MHz
116	5580 MHz	140	5700 MHz
120	5600 MHz	144	5720 MHz

6 channels are provided for 802.11n (HT40), 802.11ac (VHT40):

Channel	Frequency	Channel	Frequency
102	5510 MHz	126	5630 MHz
110	5550 MHz	134	5670 MHz
118	5590 MHz	142	5710 MHz

3 channels are provided for 802.11ac (VHT80):

Channel	Frequency	Channel	Frequency
106	5530 MHz	138	5690 MHz
122	5610 MHz		

FOR 5745 ~ 5825MHz:

5 channels are provided for 802.11a, 802.11n (HT20), 802.11ac (VHT20):

Channel	Frequency	Channel	Frequency
149	5745 MHz	161	5805 MHz
153	5765 MHz	165	5825 MHz
157	5785 MHz		

2 channels are provided for 802.11n (HT40), 802.11ac (VHT40):

Channel	Frequency	Channel	Frequency
151	5755 MHz	159	5795 MHz

1 channel is provided for 802.11ac (VHT80):

Channel	Frequency
155	5775 MHz

3.2.1 Test Mode Applicability and Tested Channel Detail

EUT Configure Mode	Applicable To				Description
	RE≥1G	RE<1G	PLC	APCM	
-	√	√	√	√	-

Where **RE≥1G**: Radiated Emission above 1GHz
RE<1G: Radiated Emission below 1GHz
PLC: Power Line Conducted Emission
APCM: Antenna Port Conducted Measurement

Radiated Emission Test (Above 1GHz):

- Pre-Scan has been conducted to determine the worst-case mode from all possible combinations between available modulations, data rates and antenna ports (if EUT with antenna diversity architecture).
- Following channel(s) was (were) selected for the final test as listed below.

Mode	FREQ. Band (MHz)	Available Channel	Tested Channel	Modulation Technology	Modulation Type	Data Rate (Mbps)
802.11a	5180-5240	36 to 48	36, 40, 48	OFDM	BPSK	6
802.11ac (VHT20)		36 to 48	36, 40, 48	OFDM	BPSK	6.5
802.11ac (VHT40)		38 to 46	38, 46	OFDM	BPSK	13.5
802.11ac (VHT80)		42	42	OFDM	BPSK	29.3
802.11a	5260-5320	52 to 64	52, 60, 64	OFDM	BPSK	6
802.11ac (VHT20)		52 to 64	52, 60, 64	OFDM	BPSK	6.5
802.11ac (VHT40)		54 to 62	54, 62	OFDM	BPSK	13.5
802.11ac (VHT80)		58	58	OFDM	BPSK	29.3
802.11a	5500-5720	100 to 144	100, 116, 140, 144	OFDM	BPSK	6
802.11ac (VHT20)		100 to 144	100, 116, 140, 144	OFDM	BPSK	6.5
802.11ac (VHT40)		102 to 142	102, 110, 134, 142	OFDM	BPSK	13.5
802.11ac (VHT80)		106 to 138	106, 122, 138	OFDM	BPSK	29.3
802.11a	5745-5825	149 to 165	149, 157, 165	OFDM	BPSK	6
802.11ac (VHT20)		149 to 165	149, 157, 165	OFDM	BPSK	6.5
802.11ac (VHT40)		151 to 159	151, 159	OFDM	BPSK	13.5
802.11ac (VHT80)		155	155	OFDM	BPSK	29.3

Radiated Emission Test (Below 1GHz):

- Pre-Scan has been conducted to determine the worst-case mode from all possible combinations between available modulations, data rates and antenna ports (if EUT with antenna diversity architecture).
- Following channel(s) was (were) selected for the final test as listed below.

Mode	FREQ. Band (MHz)	Available Channel	Tested Channel	Modulation Technology	Modulation Type	Data Rate (Mbps)
802.11a	5180-5320 5500-5720 5745-5825	36 to 64 100 to 144 149 to 165	157	OFDM	BPSK	6

Power Line Conducted Emission Test:

- Pre-Scan has been conducted to determine the worst-case mode from all possible combinations between available modulations, data rates and antenna ports (if EUT with antenna diversity architecture).
- Following channel(s) was (were) selected for the final test as listed below.

Mode	FREQ. Band (MHz)	Available Channel	Tested Channel	Modulation Technology	Modulation Type	Data Rate (Mbps)
802.11a	5180-5320 5500-5720 5745-5825	36 to 64 100 to 144 149 to 165	157	OFDM	BPSK	6

Antenna Port Conducted Measurement:

- This item includes all test value of each mode, but only includes spectrum plot of worst value of each mode.
- Pre-Scan has been conducted to determine the worst-case mode from all possible combinations between available modulations, data rates and antenna ports (if EUT with antenna diversity architecture).
- Following channel(s) was (were) selected for the final test as listed below.

Mode	FREQ. Band (MHz)	Available Channel	Tested Channel	Modulation Technology	Modulation Type	Data Rate (Mbps)
802.11a	5180-5240	36 to 48	36, 40, 48	OFDM	BPSK	6
802.11ac (VHT20)		36 to 48	36, 40, 48	OFDM	BPSK	6.5
802.11ac (VHT40)		38 to 46	38, 46	OFDM	BPSK	13.5
802.11ac (VHT80)		42	42	OFDM	BPSK	29.3
802.11a	5260-5320	52 to 64	52, 60, 64	OFDM	BPSK	6
802.11ac (VHT20)		52 to 64	52, 60, 64	OFDM	BPSK	6.5
802.11ac (VHT40)		54 to 62	54, 62	OFDM	BPSK	13.5
802.11ac (VHT80)		58	58	OFDM	BPSK	29.3
802.11a	5500-5720	100 to 144	100, 116, 140, 144	OFDM	BPSK	6
802.11ac (VHT20)		100 to 144	100, 116, 140, 144	OFDM	BPSK	6.5
802.11ac (VHT40)		102 to 142	102, 110, 134, 142	OFDM	BPSK	13.5
802.11ac (VHT80)		106 to 138	106, 122, 138	OFDM	BPSK	29.3
802.11a	5745-5825	149 to 165	149, 157, 165	OFDM	BPSK	6
802.11ac (VHT20)		149 to 165	149, 157, 165	OFDM	BPSK	6.5
802.11ac (VHT40)		151 to 159	151, 159	OFDM	BPSK	13.5
802.11ac (VHT80)		155	155	OFDM	BPSK	29.3

Test Condition:

Applicable To	Environmental Conditions	Input Power (system)	Tested By
RE \geq 1G	25deg. C, 65%RH	120Vac, 60Hz	Tank Wu
RE $<$ 1G	25deg. C, 65%RH	120Vac, 60Hz	Nelson Teng
PLC	24deg. C, 75%RH	120Vac, 60Hz	Andy Ho
APCM	25deg. C, 60%RH	120Vac, 60Hz	Jyunchun Lin

3.3 Duty Cycle of Test Signal

If duty cycle of test signal is < 98%, duty factor shall be considered.

802.11a: Duty cycle = 2.027 ms/2.134 ms = 0.95, Duty factor = $10 * \log(1/\text{Duty cycle}) = 0.22$

802.11ac (VHT20): Duty cycle = 1.898 ms/2.009 ms = 0.943, Duty factor = $10 * \log(1/\text{Duty cycle}) = 0.25$

802.11ac (VHT40): Duty cycle = 0.935 ms/1.044 ms = 0.896, Duty factor = $10 * \log(1/\text{Duty cycle}) = 0.48$

802.11ac (VHT80): Duty cycle = 0.457 ms/0.558 ms = 0.819, Duty factor = $10 * \log(1/\text{Duty cycle}) = 0.87$

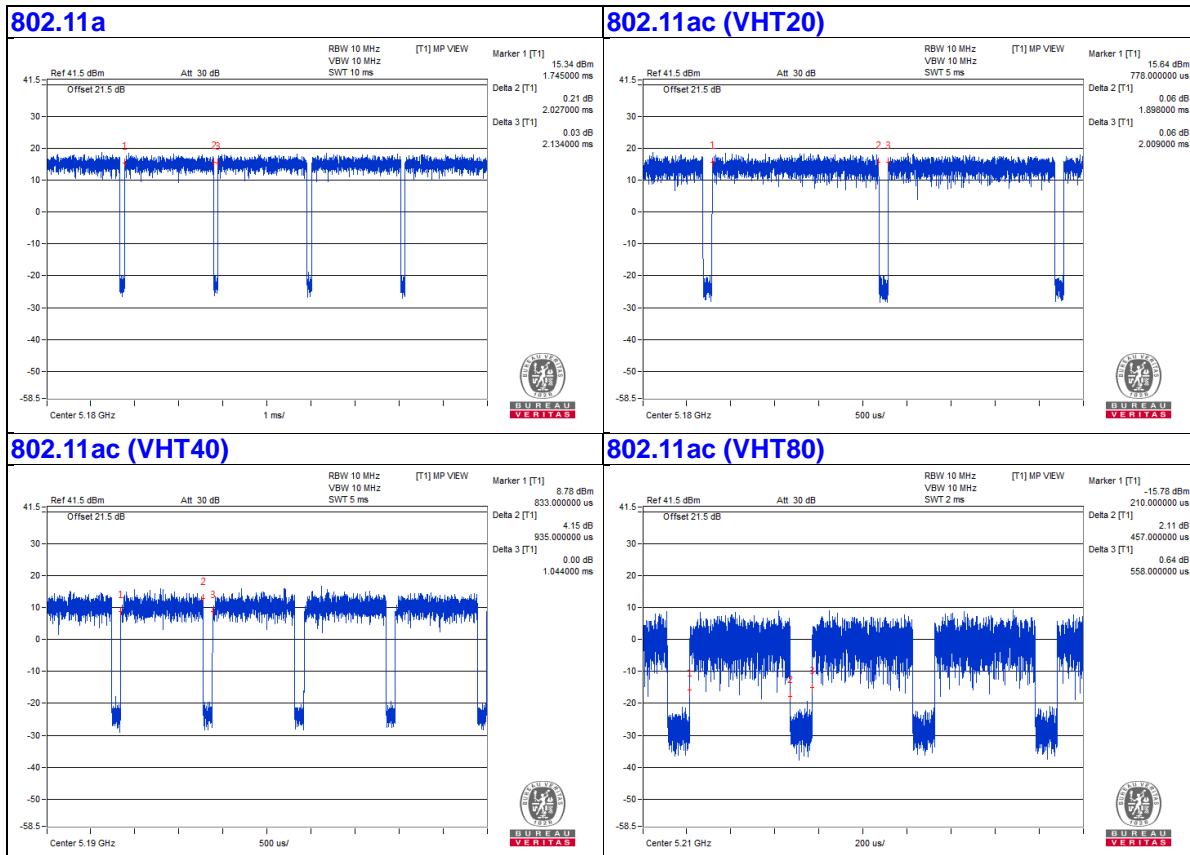

3.4 Description of Support Units

The EUT has been tested as an independent unit together with other necessary accessories or support units. The following support units or accessories were used to form a representative test configuration during the tests.

ID	Product	Brand	Model No.	Serial No.	FCC ID	Remarks
A.	Adapter	DELL	LA65NS2-01	NA	NA	Provided by Lab
B.	Laptop	DELL	E5430	GM1SKV1	FCC DoC	Provided by Lab
C.	Test Tool	Sparklan	NA	NA	NA	Supplied by client

ID	Descriptions	Qty.	Length (m)	Shielding (Yes/No)	Cores (Qty.)	Remarks
1.	DC Cable	1	1.8	No	1	Provided by Lab
2.	AC Cable	1	0.8	No	0	Provided by Lab

Note: The core(s) is(are) originally attached to the cable(s).

3.4.1 Configuration of System under Test

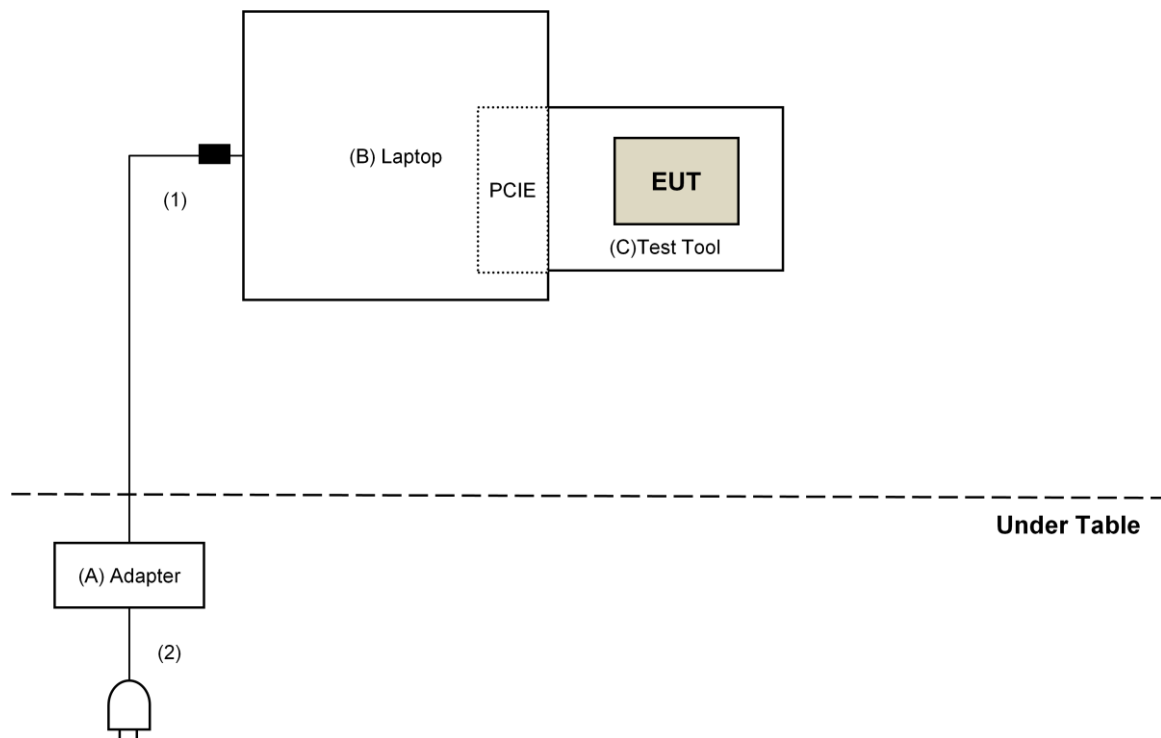

3.5 General Description of Applied Standard

The EUT is a RF Product. According to the specifications of the manufacturer, it must comply with the requirements of the following standards:

FCC Part 15, Subpart E (15.407)

KDB 789033 D02 General UNII Test Procedure New Rules v02r01

KDB 662911 D01 Multiple Transmitter Output v02r01

ANSI C63.10-2013

All test items have been performed and recorded as per the above standards.

4 Test Types and Results

4.1 Radiated Emission and Bandedge Measurement

4.1.1 Limits of Radiated Emission and Bandedge Measurement

Radiated emissions which fall in the restricted bands must comply with the radiated emission limits specified as below table.

Frequencies (MHz)	Field Strength (microvolts/meter)	Measurement Distance (meters)
0.009 ~ 0.490	2400/F(kHz)	300
0.490 ~ 1.705	24000/F(kHz)	30
1.705 ~ 30.0	30	30
30 ~ 88	100	3
88 ~ 216	150	3
216 ~ 960	200	3
Above 960	500	3

NOTE:

1. The lower limit shall apply at the transition frequencies.
2. Emission level (dBuV/m) = 20 log Emission level (uV/m).
3. For frequencies above 1000MHz, the field strength limits are based on average detector, however, the peak field strength of any emission shall not exceed the maximum permitted average limits, specified above by more than 20dB under any condition of modulation.

Limits of unwanted emission out of the restricted bands

Applicable To		Limit	
789033 D02 General UNII Test Procedure New Rules v02r01		Field Strength at 3m	
		PK:74 (dBuV/m)	AV:54 (dBuV/m)
Frequency Band	Applicable To	EIRP Limit	Equivalent Field Strength at 3m
5150~5250 MHz	15.407(b)(1)	PK:-27 (dBm/MHz)	PK:68.2(dBuV/m)
5250~5350 MHz	15.407(b)(2)		
5470~5725 MHz	15.407(b)(3)		
5725~5850 MHz	<input checked="" type="checkbox"/> 15.407(b)(4)(i)	PK:-27 (dBm/MHz) ^{*1} PK:10 (dBm/MHz) ^{*2} PK:15.6 (dBm/MHz) ^{*3} PK:27 (dBm/MHz) ^{*4}	PK: 68.2(dBuV/m) ^{*1} PK:105.2 (dBuV/m) ^{*2} PK: 110.8(dBuV/m) ^{*3} PK:122.2 (dBuV/m) ^{*4}
	<input type="checkbox"/> 15.407(b)(4)(ii)	Emission limits in section 15.247(d)	
^{*1} beyond 75 MHz or more above of the band edge.		^{*2} below the band edge increasing linearly to 10 dBm/MHz at 25 MHz above.	
^{*3} below the band edge increasing linearly to a level of 15.6 dBm/MHz at 5 MHz above.		^{*4} from 5 MHz above or below the band edge increasing linearly to a level of 27 dBm/MHz at the band edge.	

Note:

The following formula is used to convert the equipment isotropic radiated power (eirp) to field strength:

$$E = \frac{1000000\sqrt{30P}}{3} \mu\text{V/m, where P is the eirp (Watts).}$$

4.1.2 Test Instruments

DESCRIPTION & MANUFACTURER	MODEL NO.	SERIAL NO.	CALIBRATED DATE	CALIBRATED UNTIL
Test Receiver ESR7 R&S	ESR7	102026	Apr. 24, 2019	Apr. 23, 2020
Spectrum Analyzer Keysight	N9030B	MY57141948	May 25, 2019	May 24, 2020
Pre-Amplifier EMCI	EMC001340	980142	Jan. 25, 2019	Jan. 24, 2020
Loop Antenna Electro-Metrics	EM-6879	269	Sep. 07, 2018	Sep. 06, 2019
RF Cable	NA	LOOPCAB-001	Jan. 14, 2019	Jan. 13, 2020
RF Cable	NA	LOOPCAB-002	Jan. 14, 2019	Jan. 13, 2020
Pre-Amplifier EMCI	EMC330N	980538	Apr. 30, 2019	Apr. 29, 2020
Trilog Broadband Antenna SCHWARZBECK	VULB9168	9168-0842	Nov. 21, 2018	Nov. 20, 2019
RF Cable	8D	966-5-1	May 03, 2019	May 02, 2020
RF Cable	8D	966-5-2	May 03, 2019	May 02, 2020
RF Cable	8D	966-5-3	May 03, 2019	May 02, 2020
Fixed attenuator Mini-Circuits	UNAT-5+	PAD-ATT5-02	Jan. 28, 2019	Jan. 27, 2020
Horn_Antenna SCHWARZBECK	BBHA 9120D	9120D-1819	Nov. 25, 2018	Nov. 24, 2019
Pre-Amplifier EMCI	EMC12630SE	980509	May 03, 2019	May 02, 2020
RF Cable EMCI	EMC104-SM-SM-1500	180503	May 03, 2019	May 02, 2020
RF Cable EMCI	EMC104-SM-SM-2000	180501	May 03, 2019	May 02, 2020
RF Cable EMCI	EMC104-SM-SM-6000	180505	May 03, 2019	May 02, 2020
Pre-Amplifier EMCI	EMC184045SE	980387	Jan. 28, 2019	Jan. 27, 2020
Horn_Antenna SCHWARZBECK	BBHA 9170	BBHA9170519	Nov. 25, 2018	Nov. 24, 2019
RF Cable	EMC102-KM-KM-1200	160924	Jan. 28, 2019	Jan. 27, 2020
RF Cable	EMC102-KM-KM-1200	160925	Jan. 28, 2019	Jan. 27, 2020
Software	ADT_Radiated_V8.7.08	NA	NA	NA
Boresight Antenna Tower & Turn Table Max-Full	MF-7802BS	MF780208530	NA	NA
Spectrum Analyzer R&S	FSV40	100964	June 04, 2019	June 03, 2020
Power meter Anritsu	ML2495A	1014008	May 13, 2019	May 12, 2020
Power sensor Anritsu	MA2411B	0917122	May 13, 2019	May 12, 2020
Fixed Attenuator Mini-Circuits	MDCS18N-10	MDCS18N-10-01	Apr. 15, 2019	Apr. 14, 2020
DC Power Supply Topward	6603D	795558	NA	NA
Temperature & Humidity Chamber Giant Force	GTH-150-40-SP-AR	MAA0812-008	Jan. 09, 2019	Jan. 08, 2020
True RMS Clamp Meter FLUKE	325	31130711WS	May 21, 2019	May 20, 2020

Note:

1. The calibration interval of the above test instruments is 12 months and the calibrations are traceable to NML/ROC and NIST/USA.
2. The test was performed in 966 Chamber No. 5.
3. Loop antenna was used for all emissions below 30 MHz.
4. Tested Date: July 22 to 24, 2019

4.1.3 Test Procedure

For Radiated emission below 30MHz

- a. The EUT was placed on the top of a rotating table 0.8 meters above the ground at a 3 meter chamber room. The table was rotated 360 degrees to determine the position of the highest radiation.
- b. The EUT was set 3 meters away from the interference-receiving antenna, which was mounted on the top of a variable-height antenna tower.
- c. Parallel, perpendicular, and ground-parallel orientations of the antenna are set to make the measurement.
- d. For each suspected emission, the EUT was arranged to its worst case and the rotatable table was turned from 0 degrees to 360 degrees to find the maximum reading.
- e. The test-receiver system was set to Quasi-Peak Detect Function and Specified Bandwidth with Maximum Hold Mode.

Note:

1. The resolution bandwidth and video bandwidth of test receiver/spectrum analyzer is 9kHz at frequency below 30MHz.

For Radiated emission above 30MHz

- a. The EUT was placed on the top of a rotating table 0.8 meters (for 30MHz ~ 1GHz) / 1.5 meters (for above 1GHz) above the ground at 3 meter chamber room for test. The table was rotated 360 degrees to determine the position of the highest radiation.
- b. The EUT was set 3 meters away from the interference-receiving antenna, which was mounted on the top of a variable-height antenna tower.
- c. The height of antenna is varied from one meter to four meters above the ground to determine the maximum value of the field strength. Both horizontal and vertical polarizations of the antenna are set to make the measurement.
- d. For each suspected emission, the EUT was arranged to its worst case and then the antenna was tuned to heights from 1 meter to 4 meters and the rotatable table was turned from 0 degrees to 360 degrees to find the maximum reading.
- e. The test-receiver system was set to quasi-peak detect function and specified bandwidth with maximum hold mode when the test frequency is below 1 GHz.
- f. The test-receiver system was set to peak and average detects function and specified bandwidth with maximum hold mode when the test frequency is above 1 GHz. If the peak reading value also meets average limit, measurement with the average detector is unnecessary.

Note:

1. The resolution bandwidth and video bandwidth of test receiver/spectrum analyzer is 120kHz for Quasi-peak detection (QP) at frequency below 1GHz.
2. The resolution bandwidth of test receiver/spectrum analyzer is 1 MHz and the video bandwidth is 3 MHz for Peak detection (PK) at frequency above 1GHz.
3. The resolution bandwidth of test receiver/spectrum analyzer is 1MHz and the video bandwidth is $\geq 1/T$ (Duty cycle < 98%) or 10Hz (Duty cycle $\geq 98\%$) for Average detection (AV) at frequency above 1GHz.
4. All modes of operation were investigated and the worst-case emissions are reported.

4.1.4 Deviation from Test Standard

No deviation.

4.1.5 Test Setup

For Radiated emission below 30MHz

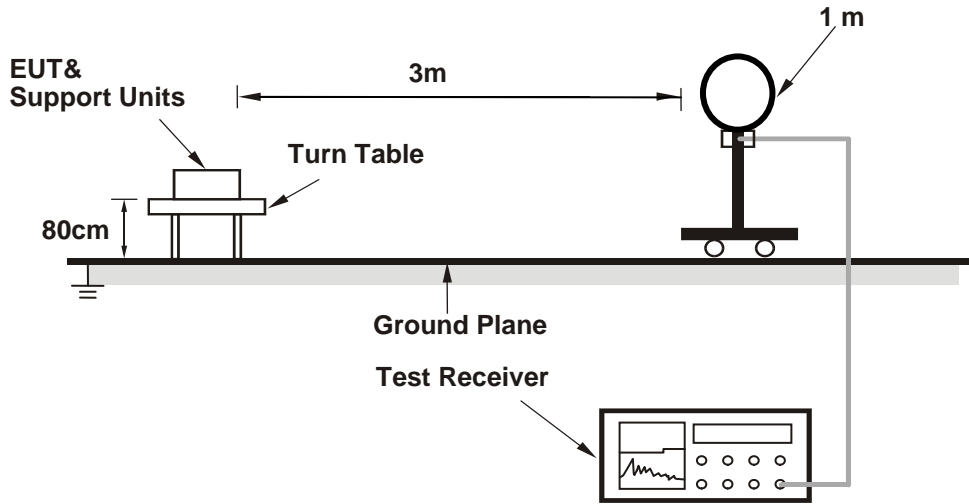

For Radiated emission 30MHz to 1GHz

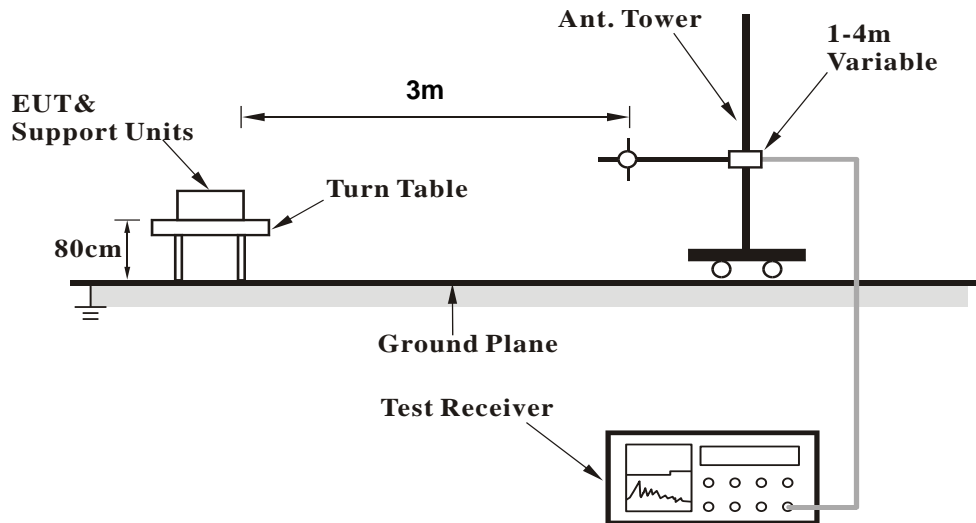

For Radiated emission above 1GHz

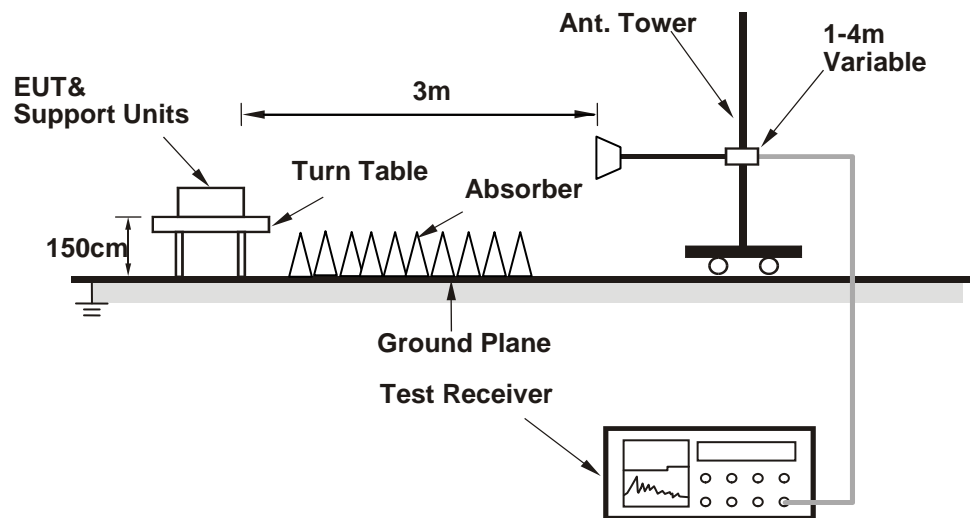

For the actual test configuration, please refer to the attached file (Test Setup Photo).

4.1.6 EUT Operating Condition

- a. Placed the EUT on the testing table.
- b. Controlling software (QRCT V3.0.187.0) has been activated to set the EUT under transmission condition continuously at specific channel frequency.

4.1.7 Test Results

Above 1GHz Data:

802.11a

CHANNEL	TX Channel 36	DETECTOR FUNCTION	Peak (PK)
FREQUENCY RANGE	1GHz ~ 40GHz		Average (AV)

ANTENNA POLARITY & TEST DISTANCE: HORIZONTAL AT 3 M

NO.	FREQ. (MHz)	EMISSION LEVEL (dBuV/m)	LIMIT (dBuV/m)	MARGIN (dB)	ANTENNA HEIGHT (m)	TABLE ANGLE (Degree)	RAW VALUE (dBuV)	CORRECTION FACTOR (dB/m)
1	5150.00	51.1 PK	74.0	-22.9	3.34 H	204	49.0	2.1
2	5150.00	39.2 AV	54.0	-14.8	3.34 H	204	37.1	2.1
3	*5180.00	98.0 PK			3.34 H	204	96.2	1.8
4	*5180.00	87.6 AV			3.34 H	204	85.8	1.8
5	#10360.00	49.7 PK	68.2	-18.5	1.61 H	310	37.6	12.1
6	15540.00	45.6 PK	74.0	-28.4	1.41 H	333	33.4	12.2
7	15540.00	33.3 AV	54.0	-20.7	1.41 H	333	21.1	12.2

ANTENNA POLARITY & TEST DISTANCE: VERTICAL AT 3 M

NO.	FREQ. (MHz)	EMISSION LEVEL (dBuV/m)	LIMIT (dBuV/m)	MARGIN (dB)	ANTENNA HEIGHT (m)	TABLE ANGLE (Degree)	RAW VALUE (dBuV)	CORRECTION FACTOR (dB/m)
1	5150.00	61.2 PK	74.0	-12.8	2.02 V	173	59.1	2.1
2	5150.00	50.5 AV	54.0	-3.5	2.02 V	173	48.4	2.1
3	*5180.00	111.5 PK			2.02 V	173	109.7	1.8
4	*5180.00	102.3 AV			2.02 V	173	100.5	1.8
5	#10360.00	49.6 PK	68.2	-18.6	1.44 V	186	37.5	12.1
6	15540.00	48.5 PK	74.0	-25.5	1.50 V	265	36.3	12.2
7	15540.00	35.3 AV	54.0	-18.7	1.50 V	265	23.1	12.2

REMARKS:

1. Emission Level(dBuV/m) = Raw Value(dBuV) + Correction Factor(dB/m)
2. Correction Factor(dB/m) = Antenna Factor(dB/m) + Cable Factor(dB) – Pre-Amplifier Factor(dB)
3. Margin value = Emission Level – Limit value
4. The other emission levels were very low against the limit.
5. " * ": Fundamental frequency.
6. " # ": The radiated frequency is out of the restricted band.

CHANNEL	TX Channel 40	DETECTOR FUNCTION	Peak (PK)
FREQUENCY RANGE	1GHz ~ 40GHz		Average (AV)

ANTENNA POLARITY & TEST DISTANCE: HORIZONTAL AT 3 M

NO.	FREQ. (MHz)	EMISSION LEVEL (dBuV/m)	LIMIT (dBuV/m)	MARGIN (dB)	ANTENNA HEIGHT (m)	TABLE ANGLE (Degree)	RAW VALUE (dBuV)	CORRECTION FACTOR (dB/m)
1	*5200.00	96.4 PK			3.36 H	205	94.7	1.7
2	*5200.00	87.2 AV			3.36 H	205	85.5	1.7
3	#10400.00	49.8 PK	68.2	-18.4	1.56 H	313	37.4	12.4
4	15600.00	45.4 PK	74.0	-28.6	1.33 H	338	33.4	12.0
5	15600.00	33.0 AV	54.0	-21.0	1.33 H	338	21.0	12.0

ANTENNA POLARITY & TEST DISTANCE: VERTICAL AT 3 M

NO.	FREQ. (MHz)	EMISSION LEVEL (dBuV/m)	LIMIT (dBuV/m)	MARGIN (dB)	ANTENNA HEIGHT (m)	TABLE ANGLE (Degree)	RAW VALUE (dBuV)	CORRECTION FACTOR (dB/m)
1	*5200.00	111.8 PK			1.99 V	177	110.1	1.7
2	*5200.00	102.5 AV			1.99 V	177	100.8	1.7
3	#10400.00	53.6 PK	68.2	-14.6	3.01 V	6	41.2	12.4
4	15600.00	48.3 PK	74.0	-25.7	1.50 V	360	36.3	12.0
5	15600.00	35.7 AV	54.0	-18.3	1.50 V	360	23.7	12.0

REMARKS:

1. Emission Level(dBuV/m) = Raw Value(dBuV) + Correction Factor(dB/m)
2. Correction Factor(dB/m) = Antenna Factor(dB/m) + Cable Factor(dB) – Pre-Amplifier Factor(dB)
3. Margin value = Emission Level – Limit value
4. The other emission levels were very low against the limit.
5. " * ": Fundamental frequency.
6. " # ": The radiated frequency is out of the restricted band.

CHANNEL	TX Channel 48	DETECTOR FUNCTION	Peak (PK)
FREQUENCY RANGE	1GHz ~ 40GHz		Average (AV)

ANTENNA POLARITY & TEST DISTANCE: HORIZONTAL AT 3 M

NO.	FREQ. (MHz)	EMISSION LEVEL (dBuV/m)	LIMIT (dBuV/m)	MARGIN (dB)	ANTENNA HEIGHT (m)	TABLE ANGLE (Degree)	RAW VALUE (dBuV)	CORRECTION FACTOR (dB/m)
1	*5240.00	95.6 PK			3.53 H	207	94.2	1.4
2	*5240.00	86.7 AV			3.53 H	207	85.3	1.4
3	5350.00	49.4 PK	74.0	-24.6	3.53 H	207	47.9	1.5
4	5350.00	37.1 AV	54.0	-16.9	3.53 H	207	35.6	1.5
5	#10480.00	49.7 PK	68.2	-18.5	1.61 H	320	36.9	12.8
6	15720.00	45.6 PK	74.0	-28.4	1.36 H	322	34.0	11.6
7	15720.00	32.8 AV	54.0	-21.2	1.36 H	322	21.2	11.6

ANTENNA POLARITY & TEST DISTANCE: VERTICAL AT 3 M

NO.	FREQ. (MHz)	EMISSION LEVEL (dBuV/m)	LIMIT (dBuV/m)	MARGIN (dB)	ANTENNA HEIGHT (m)	TABLE ANGLE (Degree)	RAW VALUE (dBuV)	CORRECTION FACTOR (dB/m)
1	*5240.00	109.9 PK			2.07 V	172	108.5	1.4
2	*5240.00	101.1 AV			2.07 V	172	99.7	1.4
3	5350.00	59.3 PK	74.0	-14.7	2.07 V	172	57.8	1.5
4	5350.00	47.1 AV	54.0	-6.9	2.07 V	172	45.6	1.5
5	#10480.00	50.8 PK	68.2	-17.4	1.02 V	119	38.0	12.8
6	15720.00	49.4 PK	74.0	-24.6	1.25 V	151	37.8	11.6
7	15720.00	35.8 AV	54.0	-18.2	1.25 V	151	24.2	11.6

REMARKS:

- Emission Level(dBuV/m) = Raw Value(dBuV) + Correction Factor(dB/m)
- Correction Factor(dB/m) = Antenna Factor(dB/m) + Cable Factor(dB) – Pre-Amplifier Factor(dB)
- Margin value = Emission Level – Limit value
- The other emission levels were very low against the limit.
- " * ": Fundamental frequency.
- " # ": The radiated frequency is out of the restricted band.

CHANNEL	TX Channel 52	DETECTOR FUNCTION	Peak (PK)
FREQUENCY RANGE	1GHz ~ 40GHz		Average (AV)

ANTENNA POLARITY & TEST DISTANCE: HORIZONTAL AT 3 M

NO.	FREQ. (MHz)	EMISSION LEVEL (dBuV/m)	LIMIT (dBuV/m)	MARGIN (dB)	ANTENNA HEIGHT (m)	TABLE ANGLE (Degree)	RAW VALUE (dBuV)	CORRECTION FACTOR (dB/m)
1	5150.00	50.7 PK	74.0	-23.3	2.79 H	183	48.6	2.1
2	5150.00	38.5 AV	54.0	-15.5	2.79 H	183	36.4	2.1
3	*5260.00	96.3 PK			2.79 H	183	95.0	1.3
4	*5260.00	86.4 AV			2.79 H	183	85.1	1.3
5	5350.00	49.6 PK	74.0	-24.4	2.79 H	183	48.1	1.5
6	5350.00	37.4 AV	54.0	-16.6	2.79 H	183	35.9	1.5
7	#10520.00	49.1 PK	68.2	-19.1	1.59 H	324	36.3	12.8
8	15780.00	45.7 PK	74.0	-28.3	1.36 H	326	34.0	11.7
9	15780.00	32.8 AV	54.0	-21.2	1.36 H	326	21.1	11.7

ANTENNA POLARITY & TEST DISTANCE: VERTICAL AT 3 M

NO.	FREQ. (MHz)	EMISSION LEVEL (dBuV/m)	LIMIT (dBuV/m)	MARGIN (dB)	ANTENNA HEIGHT (m)	TABLE ANGLE (Degree)	RAW VALUE (dBuV)	CORRECTION FACTOR (dB/m)
1	5150.00	59.8 PK	74.0	-14.2	2.00 V	171	57.7	2.1
2	5150.00	47.9 AV	54.0	-6.1	2.00 V	171	45.8	2.1
3	*5260.00	110.1 PK			2.00 V	171	108.8	1.3
4	*5260.00	101.2 AV			2.00 V	171	99.9	1.3
5	5350.00	58.9 PK	74.0	-15.1	2.00 V	171	57.4	1.5
6	5350.00	47.1 AV	54.0	-6.9	2.00 V	171	45.6	1.5
7	#10520.00	52.1 PK	68.2	-16.1	1.08 V	71	39.3	12.8
8	15780.00	48.4 PK	74.0	-25.6	1.30 V	132	36.7	11.7
9	15780.00	35.2 AV	54.0	-18.8	1.30 V	132	23.5	11.7

REMARKS:

1. Emission Level(dBuV/m) = Raw Value(dBuV) + Correction Factor(dB/m)
2. Correction Factor(dB/m) = Antenna Factor(dB/m) + Cable Factor(dB) – Pre-Amplifier Factor(dB)
3. Margin value = Emission Level – Limit value
4. The other emission levels were very low against the limit.
5. " * ": Fundamental frequency.
6. " # ": The radiated frequency is out of the restricted band.

CHANNEL	TX Channel 60	DETECTOR FUNCTION	Peak (PK)
FREQUENCY RANGE	1GHz ~ 40GHz		Average (AV)

ANTENNA POLARITY & TEST DISTANCE: HORIZONTAL AT 3 M

NO.	FREQ. (MHz)	EMISSION LEVEL (dBuV/m)	LIMIT (dBuV/m)	MARGIN (dB)	ANTENNA HEIGHT (m)	TABLE ANGLE (Degree)	RAW VALUE (dBuV)	CORRECTION FACTOR (dB/m)
1	*5300.00	95.1 PK			3.29 H	202	93.7	1.4
2	*5300.00	86.9 AV			3.29 H	202	85.5	1.4
3	10600.00	49.7 PK	74.0	-24.3	1.57 H	324	36.6	13.1
4	10600.00	38.2 AV	54.0	-15.8	1.57 H	324	25.1	13.1
5	15900.00	45.7 PK	74.0	-28.3	1.35 H	334	34.2	11.5
6	15900.00	33.1 AV	54.0	-20.9	1.35 H	334	21.6	11.5

ANTENNA POLARITY & TEST DISTANCE: VERTICAL AT 3 M

NO.	FREQ. (MHz)	EMISSION LEVEL (dBuV/m)	LIMIT (dBuV/m)	MARGIN (dB)	ANTENNA HEIGHT (m)	TABLE ANGLE (Degree)	RAW VALUE (dBuV)	CORRECTION FACTOR (dB/m)
1	*5300.00	111.4 PK			2.01 V	179	110.0	1.4
2	*5300.00	102.1 AV			2.01 V	179	100.7	1.4
3	10600.00	49.4 PK	74.0	-24.6	1.53 V	325	36.3	13.1
4	10600.00	38.2 AV	54.0	-15.8	1.53 V	325	25.1	13.1
5	15900.00	45.4 PK	74.0	-28.6	1.35 V	338	33.9	11.5
6	15900.00	32.7 AV	54.0	-21.3	1.35 V	338	21.2	11.5

REMARKS:

1. Emission Level(dBuV/m) = Raw Value(dBuV) + Correction Factor(dB/m)
2. Correction Factor(dB/m) = Antenna Factor(dB/m) + Cable Factor(dB) – Pre-Amplifier Factor(dB)
3. Margin value = Emission Level – Limit value
4. The other emission levels were very low against the limit.
5. " * ": Fundamental frequency.

CHANNEL	TX Channel 64	DETECTOR FUNCTION	Peak (PK)
FREQUENCY RANGE	1GHz ~ 40GHz		Average (AV)

ANTENNA POLARITY & TEST DISTANCE: HORIZONTAL AT 3 M

NO.	FREQ. (MHz)	EMISSION LEVEL (dBuV/m)	LIMIT (dBuV/m)	MARGIN (dB)	ANTENNA HEIGHT (m)	TABLE ANGLE (Degree)	RAW VALUE (dBuV)	CORRECTION FACTOR (dB/m)
1	*5320.00	95.0 PK			3.77 H	214	93.5	1.5
2	*5320.00	85.9 AV			3.77 H	214	84.4	1.5
3	5350.00	51.2 PK	74.0	-22.8	3.77 H	214	49.7	1.5
4	5350.00	37.6 AV	54.0	-16.4	3.77 H	214	36.1	1.5
5	10640.00	49.2 PK	74.0	-24.8	1.58 H	309	36.0	13.2
6	10640.00	37.8 AV	54.0	-16.2	1.58 H	309	24.6	13.2
7	15960.00	45.8 PK	74.0	-28.2	1.38 H	346	34.3	11.5
8	15960.00	32.9 AV	54.0	-21.1	1.38 H	346	21.4	11.5

ANTENNA POLARITY & TEST DISTANCE: VERTICAL AT 3 M

NO.	FREQ. (MHz)	EMISSION LEVEL (dBuV/m)	LIMIT (dBuV/m)	MARGIN (dB)	ANTENNA HEIGHT (m)	TABLE ANGLE (Degree)	RAW VALUE (dBuV)	CORRECTION FACTOR (dB/m)
1	*5320.00	110.3 PK			2.09 V	171	108.8	1.5
2	*5320.00	101.2 AV			2.09 V	171	99.7	1.5
3	5350.00	65.2 PK	74.0	-8.8	2.09 V	171	63.7	1.5
4	5350.00	48.3 AV	54.0	-5.7	2.09 V	171	46.8	1.5
5	10640.00	54.1 PK	74.0	-19.9	1.30 V	69	40.9	13.2
6	10640.00	41.3 AV	54.0	-12.7	1.30 V	69	28.1	13.2
7	15960.00	47.7 PK	74.0	-26.3	1.09 V	81	36.2	11.5
8	15960.00	34.7 AV	54.0	-19.3	1.09 V	81	23.2	11.5

REMARKS:

1. Emission Level(dBuV/m) = Raw Value(dBuV) + Correction Factor(dB/m)
2. Correction Factor(dB/m) = Antenna Factor(dB/m) + Cable Factor(dB) – Pre-Amplifier Factor(dB)
3. Margin value = Emission Level – Limit value
4. The other emission levels were very low against the limit.
5. " * ": Fundamental frequency.

CHANNEL	TX Channel 100	DETECTOR FUNCTION	Peak (PK)
FREQUENCY RANGE	1GHz ~ 40GHz		Average (AV)

ANTENNA POLARITY & TEST DISTANCE: HORIZONTAL AT 3 M

NO.	FREQ. (MHz)	EMISSION LEVEL (dBuV/m)	LIMIT (dBuV/m)	MARGIN (dB)	ANTENNA HEIGHT (m)	TABLE ANGLE (Degree)	RAW VALUE (dBuV)	CORRECTION FACTOR (dB/m)
1	5460.00	50.6 PK	74.0	-23.4	2.31 H	164	48.7	1.9
2	5460.00	37.4 AV	54.0	-16.6	2.31 H	164	35.5	1.9
3	#5470.00	50.2 PK	68.2	-18.0	2.31 H	164	48.3	1.9
4	*5500.00	93.3 PK			2.31 H	164	91.4	1.9
5	*5500.00	83.7 AV			2.31 H	164	81.8	1.9
6	11000.00	49.3 PK	74.0	-24.7	1.55 H	320	35.7	13.6
7	11000.00	38.1 AV	54.0	-15.9	1.55 H	320	24.5	13.6
8	#16500.00	45.8 PK	68.2	-22.4	1.36 H	320	31.6	14.2

ANTENNA POLARITY & TEST DISTANCE: VERTICAL AT 3 M

NO.	FREQ. (MHz)	EMISSION LEVEL (dBuV/m)	LIMIT (dBuV/m)	MARGIN (dB)	ANTENNA HEIGHT (m)	TABLE ANGLE (Degree)	RAW VALUE (dBuV)	CORRECTION FACTOR (dB/m)
1	5460.00	60.9 PK	74.0	-13.1	2.19 V	173	59.0	1.9
2	5460.00	41.0 AV	54.0	-13.0	2.19 V	173	39.1	1.9
3	#5470.00	67.5 PK	68.2	-0.7	2.19 V	173	65.6	1.9
4	*5500.00	106.9 PK			2.19 V	173	105.0	1.9
5	*5500.00	97.8 AV			2.19 V	173	95.9	1.9
6	11000.00	52.7 PK	74.0	-21.3	3.71 V	98	39.1	13.6
7	11000.00	41.0 AV	54.0	-13.0	3.71 V	98	27.4	13.6
8	#16500.00	48.8 PK	68.2	-19.4	1.50 V	179	34.6	14.2

REMARKS:

1. Emission Level(dBuV/m) = Raw Value(dBuV) + Correction Factor(dB/m)
2. Correction Factor(dB/m) = Antenna Factor(dB/m) + Cable Factor(dB) – Pre-Amplifier Factor(dB)
3. Margin value = Emission Level – Limit value
4. The other emission levels were very low against the limit.
5. " * ": Fundamental frequency.
6. " # ": The radiated frequency is out of the restricted band.

CHANNEL	TX Channel 116	DETECTOR FUNCTION	Peak (PK)
FREQUENCY RANGE	1GHz ~ 40GHz		Average (AV)

ANTENNA POLARITY & TEST DISTANCE: HORIZONTAL AT 3 M

NO.	FREQ. (MHz)	EMISSION LEVEL (dBuV/m)	LIMIT (dBuV/m)	MARGIN (dB)	ANTENNA HEIGHT (m)	TABLE ANGLE (Degree)	RAW VALUE (dBuV)	CORRECTION FACTOR (dB/m)
1	*5580.00	97.2 PK			2.52 H	143	95.1	2.1
2	*5580.00	87.9 AV			2.52 H	143	85.8	2.1
3	11160.00	49.2 PK	74.0	-24.8	1.54 H	309	36.5	12.7
4	11160.00	37.9 AV	54.0	-16.1	1.54 H	309	25.2	12.7
5	#16740.00	45.8 PK	68.2	-22.4	1.37 H	335	29.9	15.9

ANTENNA POLARITY & TEST DISTANCE: VERTICAL AT 3 M

NO.	FREQ. (MHz)	EMISSION LEVEL (dBuV/m)	LIMIT (dBuV/m)	MARGIN (dB)	ANTENNA HEIGHT (m)	TABLE ANGLE (Degree)	RAW VALUE (dBuV)	CORRECTION FACTOR (dB/m)
1	*5580.00	111.8 PK			2.02 V	177	109.7	2.1
2	*5580.00	102.6 AV			2.02 V	177	100.5	2.1
3	11160.00	55.3 PK	74.0	-18.7	3.04 V	50	42.6	12.7
4	11160.00	44.0 AV	54.0	-10.0	3.04 V	50	31.3	12.7
5	#16740.00	50.8 PK	68.2	-17.4	1.50 V	116	34.9	15.9

REMARKS:

1. Emission Level(dBuV/m) = Raw Value(dBuV) + Correction Factor(dB/m)
2. Correction Factor(dB/m) = Antenna Factor(dB/m) + Cable Factor(dB) – Pre-Amplifier Factor(dB)
3. Margin value = Emission Level – Limit value
4. The other emission levels were very low against the limit.
5. " * ": Fundamental frequency.
6. " # ": The radiated frequency is out of the restricted band.

CHANNEL	TX Channel 140	DETECTOR FUNCTION	Peak (PK)
FREQUENCY RANGE	1GHz ~ 40GHz		Average (AV)

ANTENNA POLARITY & TEST DISTANCE: HORIZONTAL AT 3 M

NO.	FREQ. (MHz)	EMISSION LEVEL (dBuV/m)	LIMIT (dBuV/m)	MARGIN (dB)	ANTENNA HEIGHT (m)	TABLE ANGLE (Degree)	RAW VALUE (dBuV)	CORRECTION FACTOR (dB/m)
1	*5700.00	93.5 PK			2.25 H	130	91.3	2.2
2	*5700.00	83.7 AV			2.25 H	130	81.5	2.2
3	#5725.00	55.8 PK	68.2	-12.4	2.25 H	130	53.6	2.2
4	11400.00	49.8 PK	74.0	-24.2	1.52 H	336	36.3	13.5
5	11400.00	38.4 AV	54.0	-15.6	1.52 H	336	24.9	13.5
6	#17100.00	45.5 PK	68.2	-22.7	1.34 H	329	28.7	16.8

ANTENNA POLARITY & TEST DISTANCE: VERTICAL AT 3 M

NO.	FREQ. (MHz)	EMISSION LEVEL (dBuV/m)	LIMIT (dBuV/m)	MARGIN (dB)	ANTENNA HEIGHT (m)	TABLE ANGLE (Degree)	RAW VALUE (dBuV)	CORRECTION FACTOR (dB/m)
1	*5700.00	106.0 PK			2.18 V	172	103.8	2.2
2	*5700.00	96.6 AV			2.18 V	172	94.4	2.2
3	#5725.00	67.2 PK	68.2	-1.0	2.18 V	172	65.0	2.2
4	11400.00	51.3 PK	74.0	-22.7	1.34 V	51	37.8	13.5
5	11400.00	40.0 AV	54.0	-14.0	1.34 V	51	26.5	13.5
6	#17100.00	51.1 PK	68.2	-17.1	1.34 V	51	34.3	16.8

REMARKS:

1. Emission Level(dBuV/m) = Raw Value(dBuV) + Correction Factor(dB/m)
2. Correction Factor(dB/m) = Antenna Factor(dB/m) + Cable Factor(dB) – Pre-Amplifier Factor(dB)
3. Margin value = Emission Level – Limit value
4. The other emission levels were very low against the limit.
5. " * ": Fundamental frequency.
6. " # ": The radiated frequency is out of the restricted band.

CHANNEL	TX Channel 144	DETECTOR FUNCTION	Peak (PK)
FREQUENCY RANGE	1GHz ~ 40GHz		Average (AV)

ANTENNA POLARITY & TEST DISTANCE: HORIZONTAL AT 3 M

NO.	FREQ. (MHz)	EMISSION LEVEL (dBuV/m)	LIMIT (dBuV/m)	MARGIN (dB)	ANTENNA HEIGHT (m)	TABLE ANGLE (Degree)	RAW VALUE (dBuV)	CORRECTION FACTOR (dB/m)
1	#5470.00	51.0 PK	68.2	-17.2	2.25 H	124	49.1	1.9
2	*5720.00	96.1 PK			2.25 H	124	93.9	2.2
3	*5720.00	86.1 AV			2.25 H	124	83.9	2.2
4	#5850.00	57.5 PK	68.2	-10.7	2.25 H	124	54.9	2.6
5	11440.00	49.8 PK	74.0	-24.2	1.57 H	328	36.1	13.7
6	11440.00	38.2 AV	54.0	-15.8	1.57 H	328	24.5	13.7
7	#17160.00	45.5 PK	68.2	-22.7	1.32 H	330	28.2	17.3

ANTENNA POLARITY & TEST DISTANCE: VERTICAL AT 3 M

NO.	FREQ. (MHz)	EMISSION LEVEL (dBuV/m)	LIMIT (dBuV/m)	MARGIN (dB)	ANTENNA HEIGHT (m)	TABLE ANGLE (Degree)	RAW VALUE (dBuV)	CORRECTION FACTOR (dB/m)
1	#5470.00	51.6 PK	68.2	-16.6	2.13 V	183	49.7	1.9
2	*5720.00	112.6 PK			2.13 V	183	110.4	2.2
3	*5720.00	103.4 AV			2.13 V	183	101.2	2.2
4	#5850.00	57.3 PK	68.2	-10.9	2.13 V	183	54.7	2.6
5	11440.00	57.7 PK	74.0	-16.3	3.21 V	73	44.0	13.7
6	11440.00	46.6 AV	54.0	-7.4	3.21 V	73	32.9	13.7
7	#17160.00	51.6 PK	68.2	-16.6	1.29 V	67	34.3	17.3

REMARKS:

1. Emission Level(dBuV/m) = Raw Value(dBuV) + Correction Factor(dB/m)
2. Correction Factor(dB/m) = Antenna Factor(dB/m) + Cable Factor(dB) – Pre-Amplifier Factor(dB)
3. Margin value = Emission Level – Limit value
4. The other emission levels were very low against the limit.
5. " * ": Fundamental frequency.
6. " # ": The radiated frequency is out of the restricted band.

CHANNEL	TX Channel 149	DETECTOR FUNCTION	Peak (PK)
FREQUENCY RANGE	1GHz ~ 40GHz		Average (AV)

ANTENNA POLARITY & TEST DISTANCE: HORIZONTAL AT 3 M

NO.	FREQ. (MHz)	EMISSION LEVEL (dBuV/m)	LIMIT (dBuV/m)	MARGIN (dB)	ANTENNA HEIGHT (m)	TABLE ANGLE (Degree)	RAW VALUE (dBuV)	CORRECTION FACTOR (dB/m)
1	#5554.09	51.6 PK	68.2	-16.6	1.44 H	39	49.6	2.0
2	*5745.00	95.9 PK			1.44 H	39	93.6	2.3
3	*5745.00	86.1 AV			1.44 H	39	83.8	2.3
4	#5980.81	52.7 PK	68.2	-15.5	1.44 H	39	49.8	2.9
5	11490.00	49.1 PK	74.0	-24.9	1.54 H	329	35.0	14.1
6	11490.00	37.8 AV	54.0	-16.2	1.54 H	329	23.7	14.1
7	#17235.00	45.5 PK	68.2	-22.7	1.34 H	344	27.8	17.7

ANTENNA POLARITY & TEST DISTANCE: VERTICAL AT 3 M

NO.	FREQ. (MHz)	EMISSION LEVEL (dBuV/m)	LIMIT (dBuV/m)	MARGIN (dB)	ANTENNA HEIGHT (m)	TABLE ANGLE (Degree)	RAW VALUE (dBuV)	CORRECTION FACTOR (dB/m)
1	#5583.35	58.3 PK	68.2	-9.9	1.89 V	14	56.2	2.1
2	*5745.00	112.0 PK			1.89 V	14	109.7	2.3
3	*5745.00	103.0 AV			1.89 V	14	100.7	2.3
4	#5946.88	61.5 PK	68.2	-6.7	1.89 V	14	58.6	2.9
5	11490.00	57.7 PK	74.0	-16.3	3.26 V	69	43.6	14.1
6	11490.00	46.3 AV	54.0	-7.7	3.26 V	69	32.2	14.1
7	#17235.00	51.6 PK	68.2	-16.6	1.33 V	53	33.9	17.7

REMARKS:

1. Emission Level(dBuV/m) = Raw Value(dBuV) + Correction Factor(dB/m)
2. Correction Factor(dB/m) = Antenna Factor(dB/m) + Cable Factor(dB) – Pre-Amplifier Factor(dB)
3. Margin value = Emission Level – Limit value
4. The other emission levels were very low against the limit.
5. " * ": Fundamental frequency.
6. " # ": The radiated frequency is out of the restricted band.

CHANNEL	TX Channel 157	DETECTOR FUNCTION	Peak (PK)
FREQUENCY RANGE	1GHz ~ 40GHz		Average (AV)

ANTENNA POLARITY & TEST DISTANCE: HORIZONTAL AT 3 M

NO.	FREQ. (MHz)	EMISSION LEVEL (dBuV/m)	LIMIT (dBuV/m)	MARGIN (dB)	ANTENNA HEIGHT (m)	TABLE ANGLE (Degree)	RAW VALUE (dBuV)	CORRECTION FACTOR (dB/m)
1	#5618.32	51.4 PK	68.2	-16.8	1.53 H	44	49.3	2.1
2	*5785.00	94.5 PK			1.53 H	44	92.1	2.4
3	*5785.00	86.5 AV			1.53 H	44	84.1	2.4
4	#6024.20	52.5 PK	68.2	-15.7	1.53 H	44	49.7	2.8
5	11570.00	50.0 PK	74.0	-24.0	1.59 H	338	35.9	14.1
6	11570.00	38.7 AV	54.0	-15.3	1.59 H	338	24.6	14.1
7	#17355.00	45.9 PK	68.2	-22.3	1.38 H	348	27.6	18.3

ANTENNA POLARITY & TEST DISTANCE: VERTICAL AT 3 M

NO.	FREQ. (MHz)	EMISSION LEVEL (dBuV/m)	LIMIT (dBuV/m)	MARGIN (dB)	ANTENNA HEIGHT (m)	TABLE ANGLE (Degree)	RAW VALUE (dBuV)	CORRECTION FACTOR (dB/m)
1	#5560.60	59.5 PK	68.2	-8.7	1.97 V	10	57.5	2.0
2	*5785.00	111.4 PK			1.97 V	10	109.0	2.4
3	*5785.00	102.5 AV			1.97 V	10	100.1	2.4
4	#5995.83	60.3 PK	68.2	-7.9	1.97 V	10	57.4	2.9
5	11570.00	56.6 PK	74.0	-17.4	1.30 V	67	42.5	14.1
6	11570.00	43.5 AV	54.0	-10.5	1.30 V	67	29.4	14.1
7	#17355.00	53.9 PK	68.2	-14.3	1.38 V	143	35.6	18.3

REMARKS:

1. Emission Level(dBuV/m) = Raw Value(dBuV) + Correction Factor(dB/m)
2. Correction Factor(dB/m) = Antenna Factor(dB/m) + Cable Factor(dB) – Pre-Amplifier Factor(dB)
3. Margin value = Emission Level – Limit value
4. The other emission levels were very low against the limit.
5. " * ": Fundamental frequency.
6. " # ": The radiated frequency is out of the restricted band.

CHANNEL	TX Channel 165	DETECTOR FUNCTION	Peak (PK)
FREQUENCY RANGE	1GHz ~ 40GHz		Average (AV)

ANTENNA POLARITY & TEST DISTANCE: HORIZONTAL AT 3 M

NO.	FREQ. (MHz)	EMISSION LEVEL (dBuV/m)	LIMIT (dBuV/m)	MARGIN (dB)	ANTENNA HEIGHT (m)	TABLE ANGLE (Degree)	RAW VALUE (dBuV)	CORRECTION FACTOR (dB/m)
1	#5622.76	51.7 PK	68.2	-16.5	1.49 H	40	49.6	2.1
2	*5825.00	95.0 PK			1.49 H	40	92.5	2.5
3	*5825.00	85.7 AV			1.49 H	40	83.2	2.5
4	#6000.10	53.6 PK	68.2	-14.6	1.49 H	40	50.7	2.9
5	11650.00	55.0 PK	74.0	-19.0	1.22 H	359	41.1	13.9
6	11650.00	42.9 AV	54.0	-11.1	1.22 H	359	29.0	13.9
7	#17475.00	52.4 PK	68.2	-15.8	1.33 H	326	32.9	19.5

ANTENNA POLARITY & TEST DISTANCE: VERTICAL AT 3 M

NO.	FREQ. (MHz)	EMISSION LEVEL (dBuV/m)	LIMIT (dBuV/m)	MARGIN (dB)	ANTENNA HEIGHT (m)	TABLE ANGLE (Degree)	RAW VALUE (dBuV)	CORRECTION FACTOR (dB/m)
1	#5635.69	58.8 PK	68.2	-9.4	2.09 V	10	56.8	2.0
2	*5825.00	112.1 PK			2.09 V	10	109.6	2.5
3	*5825.00	102.8 AV			2.09 V	10	100.3	2.5
4	#5982.43	60.2 PK	68.2	-8.0	2.09 V	10	57.3	2.9
5	11650.00	55.1 PK	74.0	-18.9	1.33 V	323	41.2	13.9
6	11650.00	43.4 AV	54.0	-10.6	1.33 V	323	29.5	13.9
7	#17475.00	52.6 PK	68.2	-15.6	1.62 V	275	33.1	19.5

REMARKS:

1. Emission Level(dBuV/m) = Raw Value(dBuV) + Correction Factor(dB/m)
2. Correction Factor(dB/m) = Antenna Factor(dB/m) + Cable Factor(dB) – Pre-Amplifier Factor(dB)
3. Margin value = Emission Level – Limit value
4. The other emission levels were very low against the limit.
5. " * ": Fundamental frequency.
6. " # ": The radiated frequency is out of the restricted band.

802.11ac (VHT20)

CHANNEL	TX Channel 36	DETECTOR FUNCTION	Peak (PK)
FREQUENCY RANGE	1GHz ~ 40GHz		Average (AV)

ANTENNA POLARITY & TEST DISTANCE: HORIZONTAL AT 3 M								
NO.	FREQ. (MHz)	EMISSION LEVEL (dBuV/m)	LIMIT (dBuV/m)	MARGIN (dB)	ANTENNA HEIGHT (m)	TABLE ANGLE (Degree)	RAW VALUE (dBuV)	CORRECTION FACTOR (dB/m)
1	5150.00	50.6 PK	74.0	-23.4	2.37 H	196	48.5	2.1
2	5150.00	39.4 AV	54.0	-14.6	2.37 H	196	37.3	2.1
3	*5180.00	96.7 PK			2.37 H	196	94.9	1.8
4	*5180.00	87.0 AV			2.37 H	196	85.2	1.8
5	#10360.00	49.4 PK	68.2	-18.8	1.52 H	335	37.3	12.1
6	15540.00	46.0 PK	74.0	-28.0	1.40 H	324	33.8	12.2
7	15540.00	33.3 AV	54.0	-20.7	1.40 H	324	21.1	12.2

ANTENNA POLARITY & TEST DISTANCE: VERTICAL AT 3 M								
NO.	FREQ. (MHz)	EMISSION LEVEL (dBuV/m)	LIMIT (dBuV/m)	MARGIN (dB)	ANTENNA HEIGHT (m)	TABLE ANGLE (Degree)	RAW VALUE (dBuV)	CORRECTION FACTOR (dB/m)
1	5150.00	61.8 PK	74.0	-12.2	2.00 V	160	59.7	2.1
2	5150.00	50.9 AV	54.0	-3.1	2.00 V	160	48.8	2.1
3	*5180.00	111.5 PK			2.00 V	160	109.7	1.8
4	*5180.00	102.5 AV			2.00 V	160	100.7	1.8
5	#10360.00	50.2 PK	68.2	-18.0	1.47 V	315	38.1	12.1
6	15540.00	45.7 PK	74.0	-28.3	1.38 V	344	33.5	12.2
7	15540.00	32.9 AV	54.0	-21.1	1.38 V	344	20.7	12.2

REMARKS:

1. Emission Level(dBuV/m) = Raw Value(dBuV) + Correction Factor(dB/m)
2. Correction Factor(dB/m) = Antenna Factor(dB/m) + Cable Factor(dB) – Pre-Amplifier Factor(dB)
3. Margin value = Emission Level – Limit value
4. The other emission levels were very low against the limit.
5. " * ": Fundamental frequency.
6. " # ": The radiated frequency is out of the restricted band.

CHANNEL	TX Channel 40	DETECTOR FUNCTION	Peak (PK)
FREQUENCY RANGE	1GHz ~ 40GHz		Average (AV)

ANTENNA POLARITY & TEST DISTANCE: HORIZONTAL AT 3 M

NO.	FREQ. (MHz)	EMISSION LEVEL (dBuV/m)	LIMIT (dBuV/m)	MARGIN (dB)	ANTENNA HEIGHT (m)	TABLE ANGLE (Degree)	RAW VALUE (dBuV)	CORRECTION FACTOR (dB/m)
1	*5200.00	93.4 PK			1.67 H	116	91.7	1.7
2	*5200.00	83.5 AV			1.67 H	116	81.8	1.7
3	#10400.00	49.6 PK	68.2	-18.6	1.58 H	331	37.2	12.4
4	15600.00	45.9 PK	74.0	-28.1	1.30 H	322	33.9	12.0
5	15600.00	33.4 AV	54.0	-20.6	1.30 H	322	21.4	12.0

ANTENNA POLARITY & TEST DISTANCE: VERTICAL AT 3 M

NO.	FREQ. (MHz)	EMISSION LEVEL (dBuV/m)	LIMIT (dBuV/m)	MARGIN (dB)	ANTENNA HEIGHT (m)	TABLE ANGLE (Degree)	RAW VALUE (dBuV)	CORRECTION FACTOR (dB/m)
1	*5200.00	111.5 PK			2.01 V	157	109.8	1.7
2	*5200.00	102.4 AV			2.01 V	157	100.7	1.7
3	#10400.00	48.9 PK	68.2	-19.3	1.53 V	312	36.5	12.4
4	15600.00	45.6 PK	74.0	-28.4	1.34 V	337	33.6	12.0
5	15600.00	33.1 AV	54.0	-20.9	1.34 V	337	21.1	12.0

REMARKS:

1. Emission Level(dBuV/m) = Raw Value(dBuV) + Correction Factor(dB/m)
2. Correction Factor(dB/m) = Antenna Factor(dB/m) + Cable Factor(dB) – Pre-Amplifier Factor(dB)
3. Margin value = Emission Level – Limit value
4. The other emission levels were very low against the limit.
5. " * ": Fundamental frequency.
6. " # ": The radiated frequency is out of the restricted band.

CHANNEL	TX Channel 48	DETECTOR FUNCTION	Peak (PK)
FREQUENCY RANGE	1GHz ~ 40GHz		Average (AV)

ANTENNA POLARITY & TEST DISTANCE: HORIZONTAL AT 3 M

NO.	FREQ. (MHz)	EMISSION LEVEL (dBuV/m)	LIMIT (dBuV/m)	MARGIN (dB)	ANTENNA HEIGHT (m)	TABLE ANGLE (Degree)	RAW VALUE (dBuV)	CORRECTION FACTOR (dB/m)
1	*5240.00	94.3 PK			1.35 H	116	92.9	1.4
2	*5240.00	86.2 AV			1.35 H	116	84.8	1.4
3	5350.00	48.8 PK	74.0	-25.2	1.35 H	116	47.3	1.5
4	5350.00	36.4 AV	54.0	-17.6	1.35 H	116	34.9	1.5
5	#10480.00	49.6 PK	68.2	-18.6	1.50 H	322	36.8	12.8
6	15720.00	46.3 PK	74.0	-27.7	1.38 H	323	34.7	11.6
7	15720.00	33.5 AV	54.0	-20.5	1.38 H	323	21.9	11.6

ANTENNA POLARITY & TEST DISTANCE: VERTICAL AT 3 M

NO.	FREQ. (MHz)	EMISSION LEVEL (dBuV/m)	LIMIT (dBuV/m)	MARGIN (dB)	ANTENNA HEIGHT (m)	TABLE ANGLE (Degree)	RAW VALUE (dBuV)	CORRECTION FACTOR (dB/m)
1	*5240.00	110.5 PK			2.04 V	167	109.1	1.4
2	*5240.00	101.5 AV			2.04 V	167	100.1	1.4
3	5350.00	59.0 PK	74.0	-15.0	2.04 V	167	57.5	1.5
4	5350.00	47.0 AV	54.0	-7.0	2.04 V	167	45.5	1.5
5	#10480.00	49.0 PK	68.2	-19.2	1.53 V	332	36.2	12.8
6	15720.00	45.4 PK	74.0	-28.6	1.40 V	347	33.8	11.6
7	15720.00	32.6 AV	54.0	-21.4	1.40 V	347	21.0	11.6

REMARKS:

1. Emission Level(dBuV/m) = Raw Value(dBuV) + Correction Factor(dB/m)
2. Correction Factor(dB/m) = Antenna Factor(dB/m) + Cable Factor(dB) – Pre-Amplifier Factor(dB)
3. Margin value = Emission Level – Limit value
4. The other emission levels were very low against the limit.
5. " * ": Fundamental frequency.
6. " # ": The radiated frequency is out of the restricted band.

CHANNEL	TX Channel 52	DETECTOR FUNCTION	Peak (PK)
FREQUENCY RANGE	1GHz ~ 40GHz		Average (AV)

ANTENNA POLARITY & TEST DISTANCE: HORIZONTAL AT 3 M

NO.	FREQ. (MHz)	EMISSION LEVEL (dBuV/m)	LIMIT (dBuV/m)	MARGIN (dB)	ANTENNA HEIGHT (m)	TABLE ANGLE (Degree)	RAW VALUE (dBuV)	CORRECTION FACTOR (dB/m)
1	5150.00	49.3 PK	74.0	-24.7	1.18 H	114	47.2	2.1
2	5150.00	37.8 AV	54.0	-16.2	1.18 H	114	35.7	2.1
3	*5260.00	92.9 PK			1.18 H	114	91.6	1.3
4	*5260.00	84.9 AV			1.18 H	114	83.6	1.3
5	#10520.00	50.0 PK	68.2	-18.2	1.55 H	349	37.2	12.8
6	15780.00	45.8 PK	74.0	-28.2	1.35 H	314	34.1	11.7
7	15780.00	33.3 AV	54.0	-20.7	1.35 H	314	21.6	11.7

ANTENNA POLARITY & TEST DISTANCE: VERTICAL AT 3 M

NO.	FREQ. (MHz)	EMISSION LEVEL (dBuV/m)	LIMIT (dBuV/m)	MARGIN (dB)	ANTENNA HEIGHT (m)	TABLE ANGLE (Degree)	RAW VALUE (dBuV)	CORRECTION FACTOR (dB/m)
1	5150.00	59.8 PK	74.0	-14.2	2.00 V	171	57.7	2.1
2	5150.00	48.2 AV	54.0	-5.8	2.00 V	171	46.1	2.1
3	*5260.00	110.1 PK			2.00 V	171	108.8	1.3
4	*5260.00	101.2 AV			2.00 V	171	99.9	1.3
5	#10520.00	49.4 PK	68.2	-18.8	1.48 V	313	36.6	12.8
6	15780.00	45.6 PK	74.0	-28.4	1.33 V	333	33.9	11.7
7	15780.00	33.0 AV	54.0	-21.0	1.33 V	333	21.3	11.7

REMARKS:

1. Emission Level(dBuV/m) = Raw Value(dBuV) + Correction Factor(dB/m)
2. Correction Factor(dB/m) = Antenna Factor(dB/m) + Cable Factor(dB) – Pre-Amplifier Factor(dB)
3. Margin value = Emission Level – Limit value
4. The other emission levels were very low against the limit.
5. " * ": Fundamental frequency.
6. " # ": The radiated frequency is out of the restricted band.

CHANNEL	TX Channel 60	DETECTOR FUNCTION	Peak (PK)
FREQUENCY RANGE	1GHz ~ 40GHz		Average (AV)

ANTENNA POLARITY & TEST DISTANCE: HORIZONTAL AT 3 M

NO.	FREQ. (MHz)	EMISSION LEVEL (dBuV/m)	LIMIT (dBuV/m)	MARGIN (dB)	ANTENNA HEIGHT (m)	TABLE ANGLE (Degree)	RAW VALUE (dBuV)	CORRECTION FACTOR (dB/m)
1	*5300.00	92.4 PK			1.48 H	113	91.0	1.4
2	*5300.00	84.5 AV			1.48 H	113	83.1	1.4
3	10600.00	49.7 PK	74.0	-24.3	1.54 H	328	36.6	13.1
4	10600.00	38.5 AV	54.0	-15.5	1.54 H	328	25.4	13.1
5	15900.00	45.9 PK	74.0	-28.1	1.45 H	330	34.4	11.5
6	15900.00	33.2 AV	54.0	-20.8	1.45 H	330	21.7	11.5

ANTENNA POLARITY & TEST DISTANCE: VERTICAL AT 3 M

NO.	FREQ. (MHz)	EMISSION LEVEL (dBuV/m)	LIMIT (dBuV/m)	MARGIN (dB)	ANTENNA HEIGHT (m)	TABLE ANGLE (Degree)	RAW VALUE (dBuV)	CORRECTION FACTOR (dB/m)
1	*5300.00	111.4 PK			2.01 V	141	110.0	1.4
2	*5300.00	102.1 AV			2.01 V	141	100.7	1.4
3	10600.00	49.9 PK	74.0	-24.1	1.48 V	313	36.8	13.1
4	10600.00	38.7 AV	54.0	-15.3	1.48 V	313	25.6	13.1
5	15900.00	45.6 PK	74.0	-28.4	1.32 V	323	34.1	11.5
6	15900.00	32.9 AV	54.0	-21.1	1.32 V	323	21.4	11.5

REMARKS:

1. Emission Level(dBuV/m) = Raw Value(dBuV) + Correction Factor(dB/m)
2. Correction Factor(dB/m) = Antenna Factor(dB/m) + Cable Factor(dB) – Pre-Amplifier Factor(dB)
3. Margin value = Emission Level – Limit value
4. The other emission levels were very low against the limit.
5. " * ": Fundamental frequency.

CHANNEL	TX Channel 64	DETECTOR FUNCTION	Peak (PK)
FREQUENCY RANGE	1GHz ~ 40GHz		Average (AV)

ANTENNA POLARITY & TEST DISTANCE: HORIZONTAL AT 3 M

NO.	FREQ. (MHz)	EMISSION LEVEL (dBuV/m)	LIMIT (dBuV/m)	MARGIN (dB)	ANTENNA HEIGHT (m)	TABLE ANGLE (Degree)	RAW VALUE (dBuV)	CORRECTION FACTOR (dB/m)
1	*5320.00	92.8 PK			1.50 H	246	91.3	1.5
2	*5320.00	84.4 AV			1.50 H	246	82.9	1.5
3	5350.00	50.1 PK	74.0	-23.9	1.50 H	246	48.6	1.5
4	5350.00	37.6 AV	54.0	-16.4	1.50 H	246	36.1	1.5
5	10640.00	49.2 PK	74.0	-24.8	1.49 H	346	36.0	13.2
6	10640.00	38.2 AV	54.0	-15.8	1.49 H	346	25.0	13.2
7	15960.00	46.4 PK	74.0	-27.6	1.38 H	323	34.9	11.5
8	15960.00	33.4 AV	54.0	-20.6	1.38 H	323	21.9	11.5

ANTENNA POLARITY & TEST DISTANCE: VERTICAL AT 3 M

NO.	FREQ. (MHz)	EMISSION LEVEL (dBuV/m)	LIMIT (dBuV/m)	MARGIN (dB)	ANTENNA HEIGHT (m)	TABLE ANGLE (Degree)	RAW VALUE (dBuV)	CORRECTION FACTOR (dB/m)
1	*5320.00	110.5 PK			2.04 V	166	109.0	1.5
2	*5320.00	101.3 AV			2.04 V	166	99.8	1.5
3	5350.00	65.1 PK	74.0	-8.9	2.04 V	166	63.6	1.5
4	5350.00	48.3 AV	54.0	-5.7	2.04 V	166	46.8	1.5
5	10640.00	49.4 PK	74.0	-24.6	1.48 V	317	36.2	13.2
6	10640.00	38.0 AV	54.0	-16.0	1.48 V	317	24.8	13.2
7	15960.00	45.5 PK	74.0	-28.5	1.40 V	326	34.0	11.5
8	15960.00	32.9 AV	54.0	-21.1	1.40 V	326	21.4	11.5

REMARKS:

1. Emission Level(dBuV/m) = Raw Value(dBuV) + Correction Factor(dB/m)
2. Correction Factor(dB/m) = Antenna Factor(dB/m) + Cable Factor(dB) – Pre-Amplifier Factor(dB)
3. Margin value = Emission Level – Limit value
4. The other emission levels were very low against the limit.
5. " * ": Fundamental frequency.

CHANNEL	TX Channel 100	DETECTOR FUNCTION	Peak (PK)
FREQUENCY RANGE	1GHz ~ 40GHz		Average (AV)

ANTENNA POLARITY & TEST DISTANCE: HORIZONTAL AT 3 M

NO.	FREQ. (MHz)	EMISSION LEVEL (dBuV/m)	LIMIT (dBuV/m)	MARGIN (dB)	ANTENNA HEIGHT (m)	TABLE ANGLE (Degree)	RAW VALUE (dBuV)	CORRECTION FACTOR (dB/m)
1	#5470.00	53.0 PK	68.2	-15.2	1.37 H	246	51.1	1.9
2	*5500.00	88.7 PK			1.37 H	246	86.8	1.9
3	*5500.00	81.0 AV			1.37 H	246	79.1	1.9
4	11000.00	49.4 PK	74.0	-24.6	1.56 H	326	35.8	13.6
5	11000.00	38.2 AV	54.0	-15.8	1.56 H	326	24.6	13.6
6	#16500.00	46.6 PK	68.2	-21.6	1.42 H	314	32.4	14.2

ANTENNA POLARITY & TEST DISTANCE: VERTICAL AT 3 M

NO.	FREQ. (MHz)	EMISSION LEVEL (dBuV/m)	LIMIT (dBuV/m)	MARGIN (dB)	ANTENNA HEIGHT (m)	TABLE ANGLE (Degree)	RAW VALUE (dBuV)	CORRECTION FACTOR (dB/m)
1	#5470.00	67.8 PK	68.2	-0.4	2.20 V	161	65.9	1.9
2	*5500.00	106.8 PK			2.20 V	161	104.9	1.9
3	*5500.00	97.5 AV			2.20 V	161	95.6	1.9
4	11000.00	49.8 PK	74.0	-24.2	1.56 V	315	36.2	13.6
5	11000.00	38.5 AV	54.0	-15.5	1.56 V	315	24.9	13.6
6	#16500.00	45.4 PK	68.2	-22.8	1.39 V	325	31.2	14.2

REMARKS:

1. Emission Level(dBuV/m) = Raw Value(dBuV) + Correction Factor(dB/m)
2. Correction Factor(dB/m) = Antenna Factor(dB/m) + Cable Factor(dB) – Pre-Amplifier Factor(dB)
3. Margin value = Emission Level – Limit value
4. The other emission levels were very low against the limit.
5. " * ": Fundamental frequency.
6. " # ": The radiated frequency is out of the restricted band.

CHANNEL	TX Channel 116	DETECTOR FUNCTION	Peak (PK)
FREQUENCY RANGE	1GHz ~ 40GHz		Average (AV)

ANTENNA POLARITY & TEST DISTANCE: HORIZONTAL AT 3 M

NO.	FREQ. (MHz)	EMISSION LEVEL (dBuV/m)	LIMIT (dBuV/m)	MARGIN (dB)	ANTENNA HEIGHT (m)	TABLE ANGLE (Degree)	RAW VALUE (dBuV)	CORRECTION FACTOR (dB/m)
1	*5580.00	93.2 PK			1.06 H	99	91.1	2.1
2	*5580.00	85.5 AV			1.06 H	99	83.4	2.1
3	11160.00	49.0 PK	74.0	-25.0	1.47 H	328	36.3	12.7
4	11160.00	37.8 AV	54.0	-16.2	1.47 H	328	25.1	12.7
5	#16740.00	45.3 PK	68.2	-22.9	1.44 H	335	29.4	15.9

ANTENNA POLARITY & TEST DISTANCE: VERTICAL AT 3 M

NO.	FREQ. (MHz)	EMISSION LEVEL (dBuV/m)	LIMIT (dBuV/m)	MARGIN (dB)	ANTENNA HEIGHT (m)	TABLE ANGLE (Degree)	RAW VALUE (dBuV)	CORRECTION FACTOR (dB/m)
1	*5580.00	111.4 PK			1.96 V	160	109.3	2.1
2	*5580.00	102.1 AV			1.96 V	160	100.0	2.1
3	11160.00	49.7 PK	74.0	-24.3	1.52 V	336	37.0	12.7
4	11160.00	38.5 AV	54.0	-15.5	1.52 V	336	25.8	12.7
5	#16740.00	45.3 PK	68.2	-22.9	1.40 V	339	29.4	15.9

REMARKS:

1. Emission Level(dBuV/m) = Raw Value(dBuV) + Correction Factor(dB/m)
2. Correction Factor(dB/m) = Antenna Factor(dB/m) + Cable Factor(dB) – Pre-Amplifier Factor(dB)
3. Margin value = Emission Level – Limit value
4. The other emission levels were very low against the limit.
5. " * ": Fundamental frequency.
6. " # ": The radiated frequency is out of the restricted band.

CHANNEL	TX Channel 140	DETECTOR FUNCTION	Peak (PK)
FREQUENCY RANGE	1GHz ~ 40GHz		Average (AV)

ANTENNA POLARITY & TEST DISTANCE: HORIZONTAL AT 3 M

NO.	FREQ. (MHz)	EMISSION LEVEL (dBuV/m)	LIMIT (dBuV/m)	MARGIN (dB)	ANTENNA HEIGHT (m)	TABLE ANGLE (Degree)	RAW VALUE (dBuV)	CORRECTION FACTOR (dB/m)
1	*5700.00	86.6 PK			1.05 H	97	84.4	2.2
2	*5700.00	78.5 AV			1.05 H	97	76.3	2.2
3	#5725.00	62.9 PK	68.2	-5.3	1.05 H	97	60.7	2.2
4	11400.00	49.5 PK	74.0	-24.5	1.47 H	336	36.0	13.5
5	11400.00	38.1 AV	54.0	-15.9	1.47 H	336	24.6	13.5
6	#17100.00	46.3 PK	68.2	-21.9	1.34 H	321	29.5	16.8

ANTENNA POLARITY & TEST DISTANCE: VERTICAL AT 3 M

NO.	FREQ. (MHz)	EMISSION LEVEL (dBuV/m)	LIMIT (dBuV/m)	MARGIN (dB)	ANTENNA HEIGHT (m)	TABLE ANGLE (Degree)	RAW VALUE (dBuV)	CORRECTION FACTOR (dB/m)
1	*5700.00	105.4 PK			2.08 V	174	103.2	2.2
2	*5700.00	96.0 AV			2.08 V	174	93.8	2.2
3	#5725.00	68.0 PK	68.2	-0.2	2.08 V	174	65.8	2.2
4	11400.00	49.1 PK	74.0	-24.9	1.50 V	312	35.6	13.5
5	11400.00	38.1 AV	54.0	-15.9	1.50 V	312	24.6	13.5
6	#17100.00	45.2 PK	68.2	-23.0	1.35 V	337	28.4	16.8

REMARKS:

1. Emission Level(dBuV/m) = Raw Value(dBuV) + Correction Factor(dB/m)
2. Correction Factor(dB/m) = Antenna Factor(dB/m) + Cable Factor(dB) – Pre-Amplifier Factor(dB)
3. Margin value = Emission Level – Limit value
4. The other emission levels were very low against the limit.
5. " * ": Fundamental frequency.
6. " # ": The radiated frequency is out of the restricted band.

CHANNEL	TX Channel 144	DETECTOR FUNCTION	Peak (PK)
FREQUENCY RANGE	1GHz ~ 40GHz		Average (AV)

ANTENNA POLARITY & TEST DISTANCE: HORIZONTAL AT 3 M

NO.	FREQ. (MHz)	EMISSION LEVEL (dBuV/m)	LIMIT (dBuV/m)	MARGIN (dB)	ANTENNA HEIGHT (m)	TABLE ANGLE (Degree)	RAW VALUE (dBuV)	CORRECTION FACTOR (dB/m)
1	#5470.00	51.3 PK	68.2	-16.9	1.03 H	111	49.4	1.9
2	*5720.00	95.9 PK			1.03 H	111	93.7	2.2
3	*5720.00	86.5 AV			1.03 H	111	84.3	2.2
4	#5850.00	57.2 PK	68.2	-11.0	1.03 H	111	54.6	2.6
5	11440.00	49.5 PK	74.0	-24.5	1.49 H	357	35.8	13.7
6	11440.00	38.1 AV	54.0	-15.9	1.49 H	357	24.4	13.7
7	#17160.00	45.6 PK	68.2	-22.6	1.37 H	347	28.3	17.3

ANTENNA POLARITY & TEST DISTANCE: VERTICAL AT 3 M

NO.	FREQ. (MHz)	EMISSION LEVEL (dBuV/m)	LIMIT (dBuV/m)	MARGIN (dB)	ANTENNA HEIGHT (m)	TABLE ANGLE (Degree)	RAW VALUE (dBuV)	CORRECTION FACTOR (dB/m)
1	#5470.00	51.3 PK	68.2	-16.9	2.11 V	198	49.4	1.9
2	*5720.00	111.4 PK			2.11 V	198	109.2	2.2
3	*5720.00	102.8 AV			2.11 V	198	100.6	2.2
4	#5850.00	57.4 PK	68.2	-10.8	2.11 V	198	54.8	2.6
5	11440.00	49.4 PK	74.0	-24.6	1.45 V	334	35.7	13.7
6	11440.00	38.6 AV	54.0	-15.4	1.45 V	334	24.9	13.7
7	#17160.00	45.6 PK	68.2	-22.6	1.30 V	336	28.3	17.3

REMARKS:

1. Emission Level(dBuV/m) = Raw Value(dBuV) + Correction Factor(dB/m)
2. Correction Factor(dB/m) = Antenna Factor(dB/m) + Cable Factor(dB) – Pre-Amplifier Factor(dB)
3. Margin value = Emission Level – Limit value
4. The other emission levels were very low against the limit.
5. " * ": Fundamental frequency.
6. " # ": The radiated frequency is out of the restricted band.

CHANNEL	TX Channel 149	DETECTOR FUNCTION	Peak (PK)
FREQUENCY RANGE	1GHz ~ 40GHz		Average (AV)

ANTENNA POLARITY & TEST DISTANCE: HORIZONTAL AT 3 M

NO.	FREQ. (MHz)	EMISSION LEVEL (dBuV/m)	LIMIT (dBuV/m)	MARGIN (dB)	ANTENNA HEIGHT (m)	TABLE ANGLE (Degree)	RAW VALUE (dBuV)	CORRECTION FACTOR (dB/m)
1	#5560.83	50.7 PK	68.2	-17.5	1.46 H	40	48.7	2.0
2	*5745.00	95.6 PK			1.46 H	40	93.3	2.3
3	*5745.00	86.3 AV			1.46 H	40	84.0	2.3
4	#5990.18	52.2 PK	68.2	-16.0	1.46 H	40	49.3	2.9
5	11490.00	49.6 PK	74.0	-24.4	1.47 H	346	35.5	14.1
6	11490.00	38.4 AV	54.0	-15.6	1.47 H	346	24.3	14.1
7	#17235.00	45.7 PK	68.2	-22.5	1.41 H	338	28.0	17.7

ANTENNA POLARITY & TEST DISTANCE: VERTICAL AT 3 M

NO.	FREQ. (MHz)	EMISSION LEVEL (dBuV/m)	LIMIT (dBuV/m)	MARGIN (dB)	ANTENNA HEIGHT (m)	TABLE ANGLE (Degree)	RAW VALUE (dBuV)	CORRECTION FACTOR (dB/m)
1	#5609.02	58.7 PK	68.2	-9.5	1.90 V	13	56.6	2.1
2	*5745.00	111.6 PK			1.90 V	13	109.3	2.3
3	*5745.00	102.8 AV			1.90 V	13	100.5	2.3
4	#5998.97	60.2 PK	68.2	-8.0	1.90 V	13	57.3	2.9
5	11490.00	49.3 PK	74.0	-24.7	1.48 V	328	35.2	14.1
6	11490.00	38.3 AV	54.0	-15.7	1.48 V	328	24.2	14.1
7	#17235.00	45.4 PK	68.2	-22.8	1.29 V	351	27.7	17.7

REMARKS:

1. Emission Level(dBuV/m) = Raw Value(dBuV) + Correction Factor(dB/m)
2. Correction Factor(dB/m) = Antenna Factor(dB/m) + Cable Factor(dB) – Pre-Amplifier Factor(dB)
3. Margin value = Emission Level – Limit value
4. The other emission levels were very low against the limit.
5. " * ": Fundamental frequency.
6. " # ": The radiated frequency is out of the restricted band.

CHANNEL	TX Channel 157	DETECTOR FUNCTION	Peak (PK)
FREQUENCY RANGE	1GHz ~ 40GHz		Average (AV)

ANTENNA POLARITY & TEST DISTANCE: HORIZONTAL AT 3 M

NO.	FREQ. (MHz)	EMISSION LEVEL (dBuV/m)	LIMIT (dBuV/m)	MARGIN (dB)	ANTENNA HEIGHT (m)	TABLE ANGLE (Degree)	RAW VALUE (dBuV)	CORRECTION FACTOR (dB/m)
1	#5596.10	50.8 PK	68.2	-17.4	1.57 H	40	48.7	2.1
2	*5785.00	95.8 PK			1.57 H	40	93.4	2.4
3	*5785.00	86.7 AV			1.57 H	40	84.3	2.4
4	#5992.05	52.5 PK	68.2	-15.7	1.57 H	40	49.6	2.9
5	11570.00	49.8 PK	74.0	-24.2	1.53 H	343	35.7	14.1
6	11570.00	38.3 AV	54.0	-15.7	1.53 H	343	24.2	14.1
7	#17355.00	45.6 PK	68.2	-22.6	1.36 H	311	27.3	18.3

ANTENNA POLARITY & TEST DISTANCE: VERTICAL AT 3 M

NO.	FREQ. (MHz)	EMISSION LEVEL (dBuV/m)	LIMIT (dBuV/m)	MARGIN (dB)	ANTENNA HEIGHT (m)	TABLE ANGLE (Degree)	RAW VALUE (dBuV)	CORRECTION FACTOR (dB/m)
1	#5596.30	59.0 PK	68.2	-9.2	2.10 V	7	56.9	2.1
2	*5785.00	111.4 PK			2.10 V	7	109.0	2.4
3	*5785.00	102.5 AV			2.10 V	7	100.1	2.4
4	#5956.23	59.9 PK	68.2	-8.3	2.10 V	7	57.0	2.9
5	11570.00	48.9 PK	74.0	-25.1	1.54 V	333	34.8	14.1
6	11570.00	37.9 AV	54.0	-16.1	1.54 V	333	23.8	14.1
7	#17355.00	45.1 PK	68.2	-23.1	1.31 V	327	26.8	18.3

REMARKS:

1. Emission Level(dBuV/m) = Raw Value(dBuV) + Correction Factor(dB/m)
2. Correction Factor(dB/m) = Antenna Factor(dB/m) + Cable Factor(dB) – Pre-Amplifier Factor(dB)
3. Margin value = Emission Level – Limit value
4. The other emission levels were very low against the limit.
5. " * ": Fundamental frequency.
6. " # ": The radiated frequency is out of the restricted band.

CHANNEL	TX Channel 165	DETECTOR FUNCTION	Peak (PK)
FREQUENCY RANGE	1GHz ~ 40GHz		Average (AV)

ANTENNA POLARITY & TEST DISTANCE: HORIZONTAL AT 3 M

NO.	FREQ. (MHz)	EMISSION LEVEL (dBuV/m)	LIMIT (dBuV/m)	MARGIN (dB)	ANTENNA HEIGHT (m)	TABLE ANGLE (Degree)	RAW VALUE (dBuV)	CORRECTION FACTOR (dB/m)
1	#5597.45	52.1 PK	68.2	-16.1	1.55 H	43	50.0	2.1
2	*5825.00	95.1 PK			1.55 H	43	92.6	2.5
3	*5825.00	86.0 AV			1.55 H	43	83.5	2.5
4	#5994.14	52.5 PK	68.2	-15.7	1.55 H	43	49.6	2.9
5	11650.00	49.3 PK	74.0	-24.7	1.49 H	333	35.4	13.9
6	11650.00	38.0 AV	54.0	-16.0	1.49 H	333	24.1	13.9
7	#17475.00	46.7 PK	68.2	-21.5	1.45 H	313	27.2	19.5

ANTENNA POLARITY & TEST DISTANCE: VERTICAL AT 3 M

NO.	FREQ. (MHz)	EMISSION LEVEL (dBuV/m)	LIMIT (dBuV/m)	MARGIN (dB)	ANTENNA HEIGHT (m)	TABLE ANGLE (Degree)	RAW VALUE (dBuV)	CORRECTION FACTOR (dB/m)
1	#5632.49	59.4 PK	68.2	-8.8	2.02 V	10	57.4	2.0
2	*5825.00	111.4 PK			2.02 V	10	108.9	2.5
3	*5825.00	102.4 AV			2.02 V	10	99.9	2.5
4	#5948.36	60.4 PK	68.2	-7.8	2.02 V	10	57.5	2.9
5	11650.00	49.1 PK	74.0	-24.9	1.53 V	321	35.2	13.9
6	11650.00	38.0 AV	54.0	-16.0	1.53 V	321	24.1	13.9
7	#17475.00	45.5 PK	68.2	-22.7	1.41 V	346	26.0	19.5

REMARKS:

- Emission Level(dBuV/m) = Raw Value(dBuV) + Correction Factor(dB/m)
- Correction Factor(dB/m) = Antenna Factor(dB/m) + Cable Factor(dB) – Pre-Amplifier Factor(dB)
- Margin value = Emission Level – Limit value
- The other emission levels were very low against the limit.
- " * ": Fundamental frequency.
- " # ": The radiated frequency is out of the restricted band.

802.11ac (VHT40)

CHANNEL	TX Channel 38	DETECTOR FUNCTION	Peak (PK)
FREQUENCY RANGE	1GHz ~ 40GHz		Average (AV)

ANTENNA POLARITY & TEST DISTANCE: HORIZONTAL AT 3 M								
NO.	FREQ. (MHz)	EMISSION LEVEL (dBuV/m)	LIMIT (dBuV/m)	MARGIN (dB)	ANTENNA HEIGHT (m)	TABLE ANGLE (Degree)	RAW VALUE (dBuV)	CORRECTION FACTOR (dB/m)
1	5150.00	50.5 PK	74.0	-23.5	1.05 H	67	48.4	2.1
2	5150.00	41.2 AV	54.0	-12.8	1.05 H	67	39.1	2.1
3	*5190.00	90.8 PK			1.05 H	67	89.0	1.8
4	*5190.00	82.5 AV			1.05 H	67	80.7	1.8
5	5350.00	49.0 PK	74.0	-25.0	1.05 H	67	47.5	1.5
6	5350.00	37.9 AV	54.0	-16.1	1.05 H	67	36.4	1.5
7	#10380.00	50.1 PK	68.2	-18.1	1.49 H	337	37.8	12.3
8	15570.00	46.6 PK	74.0	-27.4	1.50 H	315	34.4	12.2
9	15570.00	33.9 AV	54.0	-20.1	1.50 H	315	21.7	12.2

ANTENNA POLARITY & TEST DISTANCE: VERTICAL AT 3 M								
NO.	FREQ. (MHz)	EMISSION LEVEL (dBuV/m)	LIMIT (dBuV/m)	MARGIN (dB)	ANTENNA HEIGHT (m)	TABLE ANGLE (Degree)	RAW VALUE (dBuV)	CORRECTION FACTOR (dB/m)
1	5150.00	68.3 PK	74.0	-5.7	2.15 V	174	66.2	2.1
2	5150.00	53.4 AV	54.0	-0.6	2.15 V	174	51.3	2.1
3	*5190.00	105.6 PK			2.15 V	174	103.8	1.8
4	*5190.00	96.0 AV			2.15 V	174	94.2	1.8
5	5350.00	54.9 PK	74.0	-19.1	2.15 V	174	53.4	1.5
6	5350.00	37.8 AV	54.0	-16.2	2.15 V	174	36.3	1.5
7	#10380.00	49.0 PK	68.2	-19.2	1.52 V	329	36.7	12.3
8	15570.00	45.0 PK	74.0	-29.0	1.33 V	328	32.8	12.2
9	15570.00	32.3 AV	54.0	-21.7	1.33 V	328	20.1	12.2

REMARKS:

1. Emission Level(dBuV/m) = Raw Value(dBuV) + Correction Factor(dB/m)
2. Correction Factor(dB/m) = Antenna Factor(dB/m) + Cable Factor(dB) – Pre-Amplifier Factor(dB)
3. Margin value = Emission Level – Limit value
4. The other emission levels were very low against the limit.
5. " * ": Fundamental frequency.
6. " # ": The radiated frequency is out of the restricted band.

CHANNEL	TX Channel 46	DETECTOR FUNCTION	Peak (PK)
FREQUENCY RANGE	1GHz ~ 40GHz		Average (AV)

ANTENNA POLARITY & TEST DISTANCE: HORIZONTAL AT 3 M

NO.	FREQ. (MHz)	EMISSION LEVEL (dBuV/m)	LIMIT (dBuV/m)	MARGIN (dB)	ANTENNA HEIGHT (m)	TABLE ANGLE (Degree)	RAW VALUE (dBuV)	CORRECTION FACTOR (dB/m)
1	*5230.00	90.4 PK			1.05 H	67	88.9	1.5
2	*5230.00	81.8 AV			1.05 H	67	80.3	1.5
3	5350.00	48.5 PK	74.0	-25.5	1.05 H	67	47.0	1.5
4	5350.00	37.7 AV	54.0	-16.3	1.05 H	67	36.2	1.5
5	#10460.00	49.1 PK	68.2	-19.1	1.53 H	345	36.4	12.7
6	15690.00	46.6 PK	74.0	-27.4	1.50 H	321	35.0	11.6
7	15690.00	34.0 AV	54.0	-20.0	1.50 H	321	22.4	11.6

ANTENNA POLARITY & TEST DISTANCE: VERTICAL AT 3 M

NO.	FREQ. (MHz)	EMISSION LEVEL (dBuV/m)	LIMIT (dBuV/m)	MARGIN (dB)	ANTENNA HEIGHT (m)	TABLE ANGLE (Degree)	RAW VALUE (dBuV)	CORRECTION FACTOR (dB/m)
1	*5230.00	107.2 PK			2.08 V	173	105.7	1.5
2	*5230.00	97.9 AV			2.08 V	173	96.4	1.5
3	5350.00	54.2 PK	74.0	-19.8	2.08 V	173	52.7	1.5
4	5350.00	38.4 AV	54.0	-15.6	2.08 V	173	36.9	1.5
5	#10460.00	49.2 PK	68.2	-19.0	1.57 V	333	36.5	12.7
6	15690.00	45.1 PK	74.0	-28.9	1.33 V	329	33.5	11.6
7	15690.00	32.5 AV	54.0	-21.5	1.33 V	329	20.9	11.6

REMARKS:

1. Emission Level(dBuV/m) = Raw Value(dBuV) + Correction Factor(dB/m)
2. Correction Factor(dB/m) = Antenna Factor(dB/m) + Cable Factor(dB) – Pre-Amplifier Factor(dB)
3. Margin value = Emission Level – Limit value
4. The other emission levels were very low against the limit.
5. " * ": Fundamental frequency.
6. " # ": The radiated frequency is out of the restricted band.

CHANNEL	TX Channel 54	DETECTOR FUNCTION	Peak (PK)
FREQUENCY RANGE	1GHz ~ 40GHz		Average (AV)

ANTENNA POLARITY & TEST DISTANCE: HORIZONTAL AT 3 M

NO.	FREQ. (MHz)	EMISSION LEVEL (dBuV/m)	LIMIT (dBuV/m)	MARGIN (dB)	ANTENNA HEIGHT (m)	TABLE ANGLE (Degree)	RAW VALUE (dBuV)	CORRECTION FACTOR (dB/m)
1	*5270.00	90.5 PK			2.60 H	324	89.2	1.3
2	*5270.00	82.7 AV			2.60 H	324	81.4	1.3
3	5350.00	48.5 PK	74.0	-25.5	2.60 H	324	47.0	1.5
4	5350.00	37.8 AV	54.0	-16.2	2.60 H	324	36.3	1.5
5	#10540.00	49.1 PK	68.2	-19.1	1.53 H	343	36.2	12.9
6	15810.00	46.4 PK	74.0	-27.6	1.45 H	298	34.7	11.7
7	15810.00	33.5 AV	54.0	-20.5	1.45 H	298	21.8	11.7

ANTENNA POLARITY & TEST DISTANCE: VERTICAL AT 3 M

NO.	FREQ. (MHz)	EMISSION LEVEL (dBuV/m)	LIMIT (dBuV/m)	MARGIN (dB)	ANTENNA HEIGHT (m)	TABLE ANGLE (Degree)	RAW VALUE (dBuV)	CORRECTION FACTOR (dB/m)
1	*5270.00	107.2 PK			2.10 V	173	105.9	1.3
2	*5270.00	98.5 AV			2.10 V	173	97.2	1.3
3	5350.00	56.1 PK	74.0	-17.9	2.10 V	173	54.6	1.5
4	5350.00	40.7 AV	54.0	-13.3	2.10 V	173	39.2	1.5
5	#10540.00	48.9 PK	68.2	-19.3	1.53 V	319	36.0	12.9
6	15810.00	45.2 PK	74.0	-28.8	1.40 V	333	33.5	11.7
7	15810.00	32.6 AV	54.0	-21.4	1.40 V	333	20.9	11.7

REMARKS:

- Emission Level(dBuV/m) = Raw Value(dBuV) + Correction Factor(dB/m)
- Correction Factor(dB/m) = Antenna Factor(dB/m) + Cable Factor(dB) – Pre-Amplifier Factor(dB)
- Margin value = Emission Level – Limit value
- The other emission levels were very low against the limit.
- " * ": Fundamental frequency.
- " # ": The radiated frequency is out of the restricted band.

CHANNEL	TX Channel 62	DETECTOR FUNCTION	Peak (PK)
FREQUENCY RANGE	1GHz ~ 40GHz		Average (AV)

ANTENNA POLARITY & TEST DISTANCE: HORIZONTAL AT 3 M

NO.	FREQ. (MHz)	EMISSION LEVEL (dBuV/m)	LIMIT (dBuV/m)	MARGIN (dB)	ANTENNA HEIGHT (m)	TABLE ANGLE (Degree)	RAW VALUE (dBuV)	CORRECTION FACTOR (dB/m)
1	*5310.00	92.4 PK			2.68 H	323	91.0	1.4
2	*5310.00	84.9 AV			2.68 H	323	83.5	1.4
3	5350.00	51.5 PK	74.0	-22.5	2.68 H	323	50.0	1.5
4	5350.00	39.2 AV	54.0	-14.8	2.68 H	323	37.7	1.5
5	10620.00	48.6 PK	74.0	-25.4	1.49 H	341	35.5	13.1
6	10620.00	37.6 AV	54.0	-16.4	1.49 H	341	24.5	13.1
7	15930.00	46.6 PK	74.0	-27.4	1.45 H	304	35.1	11.5
8	15930.00	33.9 AV	54.0	-20.1	1.45 H	304	22.4	11.5

ANTENNA POLARITY & TEST DISTANCE: VERTICAL AT 3 M

NO.	FREQ. (MHz)	EMISSION LEVEL (dBuV/m)	LIMIT (dBuV/m)	MARGIN (dB)	ANTENNA HEIGHT (m)	TABLE ANGLE (Degree)	RAW VALUE (dBuV)	CORRECTION FACTOR (dB/m)
1	*5310.00	107.1 PK			2.13 V	172	105.7	1.4
2	*5310.00	98.9 AV			2.13 V	172	97.5	1.4
3	5350.00	72.8 PK	74.0	-1.2	2.13 V	172	71.3	1.5
4	5350.00	50.2 AV	54.0	-3.8	2.13 V	172	48.7	1.5
5	10620.00	49.4 PK	74.0	-24.6	1.47 V	326	36.3	13.1
6	10620.00	38.4 AV	54.0	-15.6	1.47 V	326	25.3	13.1
7	15930.00	45.9 PK	74.0	-28.1	1.36 V	349	34.4	11.5
8	15930.00	33.1 AV	54.0	-20.9	1.36 V	349	21.6	11.5

REMARKS:

1. Emission Level(dBuV/m) = Raw Value(dBuV) + Correction Factor(dB/m)
2. Correction Factor(dB/m) = Antenna Factor(dB/m) + Cable Factor(dB) – Pre-Amplifier Factor(dB)
3. Margin value = Emission Level – Limit value
4. The other emission levels were very low against the limit.
5. " * ": Fundamental frequency.

CHANNEL	TX Channel 102	DETECTOR FUNCTION	Peak (PK)
FREQUENCY RANGE	1GHz ~ 40GHz		Average (AV)

ANTENNA POLARITY & TEST DISTANCE: HORIZONTAL AT 3 M

NO.	FREQ. (MHz)	EMISSION LEVEL (dBuV/m)	LIMIT (dBuV/m)	MARGIN (dB)	ANTENNA HEIGHT (m)	TABLE ANGLE (Degree)	RAW VALUE (dBuV)	CORRECTION FACTOR (dB/m)
1	5460.00	49.8 PK	74.0	-24.2	2.70 H	323	47.9	1.9
2	5460.00	36.8 AV	54.0	-17.2	2.70 H	323	34.9	1.9
3	#5470.00	53.1 PK	68.2	-15.1	2.70 H	323	51.2	1.9
4	*5510.00	87.8 PK			2.70 H	323	85.9	1.9
5	*5510.00	80.2 AV			2.70 H	323	78.3	1.9
6	11020.00	49.6 PK	74.0	-24.4	1.44 H	341	36.2	13.4
7	11020.00	38.5 AV	54.0	-15.5	1.44 H	341	25.1	13.4
8	#16530.00	47.1 PK	68.2	-21.1	1.43 H	304	32.6	14.5

ANTENNA POLARITY & TEST DISTANCE: VERTICAL AT 3 M

NO.	FREQ. (MHz)	EMISSION LEVEL (dBuV/m)	LIMIT (dBuV/m)	MARGIN (dB)	ANTENNA HEIGHT (m)	TABLE ANGLE (Degree)	RAW VALUE (dBuV)	CORRECTION FACTOR (dB/m)
1	5460.00	63.7 PK	74.0	-10.3	2.11 V	173	61.8	1.9
2	5460.00	42.0 AV	54.0	-12.0	2.11 V	173	40.1	1.9
3	#5470.00	67.9 PK	68.2	-0.3	2.11 V	173	66.0	1.9
4	*5510.00	102.1 PK			2.11 V	173	100.2	1.9
5	*5510.00	93.0 AV			2.11 V	173	91.1	1.9
6	11020.00	49.2 PK	74.0	-24.8	1.58 V	319	35.8	13.4
7	11020.00	37.8 AV	54.0	-16.2	1.58 V	319	24.4	13.4
8	#16530.00	45.3 PK	68.2	-22.9	1.34 V	326	30.8	14.5

REMARKS:

1. Emission Level(dBuV/m) = Raw Value(dBuV) + Correction Factor(dB/m)
2. Correction Factor(dB/m) = Antenna Factor(dB/m) + Cable Factor(dB) – Pre-Amplifier Factor(dB)
3. Margin value = Emission Level – Limit value
4. The other emission levels were very low against the limit.
5. " * ": Fundamental frequency.
6. " # ": The radiated frequency is out of the restricted band.

CHANNEL	TX Channel 110	DETECTOR FUNCTION	Peak (PK)
FREQUENCY RANGE	1GHz ~ 40GHz		Average (AV)

ANTENNA POLARITY & TEST DISTANCE: HORIZONTAL AT 3 M

NO.	FREQ. (MHz)	EMISSION LEVEL (dBuV/m)	LIMIT (dBuV/m)	MARGIN (dB)	ANTENNA HEIGHT (m)	TABLE ANGLE (Degree)	RAW VALUE (dBuV)	CORRECTION FACTOR (dB/m)
1	*5550.00	89.4 PK			1.50 H	244	87.4	2.0
2	*5550.00	80.2 AV			1.50 H	244	78.2	2.0
3	11100.00	49.1 PK	74.0	-24.9	1.45 H	344	36.2	12.9
4	11100.00	37.7 AV	54.0	-16.3	1.45 H	344	24.8	12.9
5	#16650.00	46.4 PK	68.2	-21.8	1.40 H	318	31.2	15.2

ANTENNA POLARITY & TEST DISTANCE: VERTICAL AT 3 M

NO.	FREQ. (MHz)	EMISSION LEVEL (dBuV/m)	LIMIT (dBuV/m)	MARGIN (dB)	ANTENNA HEIGHT (m)	TABLE ANGLE (Degree)	RAW VALUE (dBuV)	CORRECTION FACTOR (dB/m)
1	*5550.00	107.3 PK			2.11 V	175	105.3	2.0
2	*5550.00	99.3 AV			2.11 V	175	97.3	2.0
3	11100.00	49.9 PK	74.0	-24.1	1.50 V	332	37.0	12.9
4	11100.00	38.5 AV	54.0	-15.5	1.50 V	332	25.6	12.9
5	#16650.00	45.7 PK	68.2	-22.5	1.31 V	348	30.5	15.2

REMARKS:

1. Emission Level(dBuV/m) = Raw Value(dBuV) + Correction Factor(dB/m)
2. Correction Factor(dB/m) = Antenna Factor(dB/m) + Cable Factor(dB) – Pre-Amplifier Factor(dB)
3. Margin value = Emission Level – Limit value
4. The other emission levels were very low against the limit.
5. " * ": Fundamental frequency.
6. " # ": The radiated frequency is out of the restricted band.

CHANNEL	TX Channel 134	DETECTOR FUNCTION	Peak (PK)
FREQUENCY RANGE	1GHz ~ 40GHz		Average (AV)

ANTENNA POLARITY & TEST DISTANCE: HORIZONTAL AT 3 M

NO.	FREQ. (MHz)	EMISSION LEVEL (dBuV/m)	LIMIT (dBuV/m)	MARGIN (dB)	ANTENNA HEIGHT (m)	TABLE ANGLE (Degree)	RAW VALUE (dBuV)	CORRECTION FACTOR (dB/m)
1	*5670.00	80.4 PK			1.33 H	246	78.3	2.1
2	*5670.00	79.6 AV			1.33 H	246	77.5	2.1
3	#5725.00	41.3 PK	68.2	-26.9	1.33 H	246	39.1	2.2
4	11340.00	49.4 PK	74.0	-24.6	1.50 H	346	36.4	13.0
5	11340.00	38.1 AV	54.0	-15.9	1.50 H	346	25.1	13.0
6	#17010.00	46.9 PK	68.2	-21.3	1.42 H	305	30.0	16.9

ANTENNA POLARITY & TEST DISTANCE: VERTICAL AT 3 M

NO.	FREQ. (MHz)	EMISSION LEVEL (dBuV/m)	LIMIT (dBuV/m)	MARGIN (dB)	ANTENNA HEIGHT (m)	TABLE ANGLE (Degree)	RAW VALUE (dBuV)	CORRECTION FACTOR (dB/m)
1	*5670.00	108.4 PK			1.78 V	14	106.3	2.1
2	*5670.00	98.7 AV			1.78 V	14	96.6	2.1
3	#5725.00	68.1 PK	68.2	-0.1	1.78 V	14	65.9	2.2
4	11340.00	49.3 PK	74.0	-24.7	1.52 V	311	36.3	13.0
5	11340.00	37.9 AV	54.0	-16.1	1.52 V	311	24.9	13.0
6	#17010.00	45.0 PK	68.2	-23.2	1.35 V	340	28.1	16.9

REMARKS:

1. Emission Level(dBuV/m) = Raw Value(dBuV) + Correction Factor(dB/m)
2. Correction Factor(dB/m) = Antenna Factor(dB/m) + Cable Factor(dB) – Pre-Amplifier Factor(dB)
3. Margin value = Emission Level – Limit value
4. The other emission levels were very low against the limit.
5. " * ": Fundamental frequency.
6. " # ": The radiated frequency is out of the restricted band.

CHANNEL	TX Channel 142	DETECTOR FUNCTION	Peak (PK)
FREQUENCY RANGE	1GHz ~ 40GHz		Average (AV)

ANTENNA POLARITY & TEST DISTANCE: HORIZONTAL AT 3 M

NO.	FREQ. (MHz)	EMISSION LEVEL (dBuV/m)	LIMIT (dBuV/m)	MARGIN (dB)	ANTENNA HEIGHT (m)	TABLE ANGLE (Degree)	RAW VALUE (dBuV)	CORRECTION FACTOR (dB/m)
1	#5470.00	50.9 PK	68.2	-17.3	1.36 H	255	49.0	1.9
2	*5710.00	91.8 PK			1.36 H	255	89.6	2.2
3	*5710.00	82.9 AV			1.36 H	255	80.7	2.2
4	#5850.00	63.5 PK	68.2	-4.7	1.36 H	255	60.9	2.6
5	11420.00	49.2 PK	74.0	-24.8	1.52 H	335	35.6	13.6
6	11420.00	37.8 AV	54.0	-16.2	1.52 H	335	24.2	13.6
7	#17130.00	46.6 PK	68.2	-21.6	1.39 H	295	29.5	17.1

ANTENNA POLARITY & TEST DISTANCE: VERTICAL AT 3 M

NO.	FREQ. (MHz)	EMISSION LEVEL (dBuV/m)	LIMIT (dBuV/m)	MARGIN (dB)	ANTENNA HEIGHT (m)	TABLE ANGLE (Degree)	RAW VALUE (dBuV)	CORRECTION FACTOR (dB/m)
1	#5470.00	50.9 PK	68.2	-17.3	2.14 V	13	49.0	1.9
2	*5710.00	108.4 PK			2.14 V	13	106.2	2.2
3	*5710.00	98.4 AV			2.14 V	13	96.2	2.2
4	#5850.00	63.6 PK	68.2	-4.6	2.14 V	13	61.0	2.6
5	11420.00	49.5 PK	74.0	-24.5	1.55 V	311	35.9	13.6
6	11420.00	38.4 AV	54.0	-15.6	1.55 V	311	24.8	13.6
7	#17130.00	44.9 PK	68.2	-23.3	1.38 V	312	27.8	17.1

REMARKS:

1. Emission Level(dBuV/m) = Raw Value(dBuV) + Correction Factor(dB/m)
2. Correction Factor(dB/m) = Antenna Factor(dB/m) + Cable Factor(dB) – Pre-Amplifier Factor(dB)
3. Margin value = Emission Level – Limit value
4. The other emission levels were very low against the limit.
5. " * ": Fundamental frequency.
6. " # ": The radiated frequency is out of the restricted band.

CHANNEL	TX Channel 151	DETECTOR FUNCTION	Peak (PK)
FREQUENCY RANGE	1GHz ~ 40GHz		Average (AV)

ANTENNA POLARITY & TEST DISTANCE: HORIZONTAL AT 3 M

NO.	FREQ. (MHz)	EMISSION LEVEL (dBuV/m)	LIMIT (dBuV/m)	MARGIN (dB)	ANTENNA HEIGHT (m)	TABLE ANGLE (Degree)	RAW VALUE (dBuV)	CORRECTION FACTOR (dB/m)
1	#5592.00	52.0 PK	68.2	-16.2	1.42 H	41	49.9	2.1
2	*5755.00	91.7 PK			1.42 H	41	89.4	2.3
3	*5755.00	83.0 AV			1.42 H	41	80.7	2.3
4	#5960.81	52.3 PK	68.2	-15.9	1.42 H	41	49.4	2.9
5	11510.00	49.1 PK	74.0	-24.9	1.53 H	317	35.0	14.1
6	11510.00	38.1 AV	54.0	-15.9	1.53 H	317	24.0	14.1
7	#17265.00	47.0 PK	68.2	-21.2	1.41 H	310	29.2	17.8

ANTENNA POLARITY & TEST DISTANCE: VERTICAL AT 3 M

NO.	FREQ. (MHz)	EMISSION LEVEL (dBuV/m)	LIMIT (dBuV/m)	MARGIN (dB)	ANTENNA HEIGHT (m)	TABLE ANGLE (Degree)	RAW VALUE (dBuV)	CORRECTION FACTOR (dB/m)
1	#5646.45	56.5 PK	68.2	-11.7	2.09 V	13	54.5	2.0
2	*5755.00	108.3 PK			2.09 V	13	106.0	2.3
3	*5755.00	98.4 AV			2.09 V	13	96.1	2.3
4	#5983.63	51.3 PK	68.2	-16.9	2.09 V	13	48.4	2.9
5	11510.00	49.2 PK	74.0	-24.8	1.58 V	311	35.1	14.1
6	11510.00	38.2 AV	54.0	-15.8	1.58 V	311	24.1	14.1
7	#17265.00	44.9 PK	68.2	-23.3	1.33 V	328	27.1	17.8

REMARKS:

1. Emission Level(dBuV/m) = Raw Value(dBuV) + Correction Factor(dB/m)
2. Correction Factor(dB/m) = Antenna Factor(dB/m) + Cable Factor(dB) – Pre-Amplifier Factor(dB)
3. Margin value = Emission Level – Limit value
4. The other emission levels were very low against the limit.
5. " * ": Fundamental frequency.
6. " # ": The radiated frequency is out of the restricted band.

CHANNEL	TX Channel 159	DETECTOR FUNCTION	Peak (PK)
FREQUENCY RANGE	1GHz ~ 40GHz		Average (AV)

ANTENNA POLARITY & TEST DISTANCE: HORIZONTAL AT 3 M

NO.	FREQ. (MHz)	EMISSION LEVEL (dBuV/m)	LIMIT (dBuV/m)	MARGIN (dB)	ANTENNA HEIGHT (m)	TABLE ANGLE (Degree)	RAW VALUE (dBuV)	CORRECTION FACTOR (dB/m)
1	#5552.57	50.9 PK	68.2	-17.3	1.56 H	40	48.9	2.0
2	*5795.00	91.5 PK			1.56 H	40	89.0	2.5
3	*5795.00	82.5 AV			1.56 H	40	80.0	2.5
4	#5986.32	51.5 PK	68.2	-16.7	1.56 H	40	48.6	2.9
5	11590.00	49.5 PK	74.0	-24.5	1.55 H	324	35.4	14.1
6	11590.00	38.2 AV	54.0	-15.8	1.55 H	324	24.1	14.1
7	#17385.00	46.9 PK	68.2	-21.3	1.44 H	313	28.4	18.5

ANTENNA POLARITY & TEST DISTANCE: VERTICAL AT 3 M

NO.	FREQ. (MHz)	EMISSION LEVEL (dBuV/m)	LIMIT (dBuV/m)	MARGIN (dB)	ANTENNA HEIGHT (m)	TABLE ANGLE (Degree)	RAW VALUE (dBuV)	CORRECTION FACTOR (dB/m)
1	#5649.49	60.3 PK	68.2	-7.9	1.81 V	11	58.3	2.0
2	*5795.00	108.6 PK			1.81 V	11	106.1	2.5
3	*5795.00	98.7 AV			1.81 V	11	96.2	2.5
4	#5936.01	56.5 PK	68.2	-11.7	1.81 V	11	53.7	2.8
5	11590.00	49.5 PK	74.0	-24.5	1.59 V	319	35.4	14.1
6	11590.00	38.6 AV	54.0	-15.4	1.59 V	319	24.5	14.1
7	#17385.00	45.1 PK	68.2	-23.1	1.38 V	349	26.6	18.5

REMARKS:

1. Emission Level(dBuV/m) = Raw Value(dBuV) + Correction Factor(dB/m)
2. Correction Factor(dB/m) = Antenna Factor(dB/m) + Cable Factor(dB) – Pre-Amplifier Factor(dB)
3. Margin value = Emission Level – Limit value
4. The other emission levels were very low against the limit.
5. " * ": Fundamental frequency.
6. " # ": The radiated frequency is out of the restricted band.

802.11ac (VHT80)

CHANNEL	TX Channel 42	DETECTOR FUNCTION	Peak (PK)
FREQUENCY RANGE	1GHz ~ 40GHz		Average (AV)

ANTENNA POLARITY & TEST DISTANCE: HORIZONTAL AT 3 M

NO.	FREQ. (MHz)	EMISSION LEVEL (dBuV/m)	LIMIT (dBuV/m)	MARGIN (dB)	ANTENNA HEIGHT (m)	TABLE ANGLE (Degree)	RAW VALUE (dBuV)	CORRECTION FACTOR (dB/m)
1	5150.00	49.1 PK	74.0	-24.9	1.22 H	324	47.0	2.1
2	5150.00	37.4 AV	54.0	-16.6	1.22 H	324	35.3	2.1
3	*5210.00	83.4 PK			1.22 H	324	81.8	1.6
4	*5210.00	71.4 AV			1.22 H	324	69.8	1.6
5	5350.00	48.7 PK	74.0	-25.3	1.22 H	324	47.2	1.5
6	5350.00	35.8 AV	54.0	-18.2	1.22 H	324	34.3	1.5
7	#10420.00	51.3 PK	68.2	-16.9	1.44 H	330	38.9	12.4
8	15630.00	47.9 PK	74.0	-26.1	1.49 H	267	36.1	11.8
9	15630.00	35.3 AV	54.0	-18.7	1.49 H	267	23.5	11.8

ANTENNA POLARITY & TEST DISTANCE: VERTICAL AT 3 M

NO.	FREQ. (MHz)	EMISSION LEVEL (dBuV/m)	LIMIT (dBuV/m)	MARGIN (dB)	ANTENNA HEIGHT (m)	TABLE ANGLE (Degree)	RAW VALUE (dBuV)	CORRECTION FACTOR (dB/m)
1	5150.00	63.5 PK	74.0	-10.5	1.97 V	12	61.4	2.1
2	5150.00	53.4 AV	54.0	-0.6	1.97 V	12	51.3	2.1
3	*5210.00	100.3 PK			1.97 V	12	98.7	1.6
4	*5210.00	90.1 AV			1.97 V	12	88.5	1.6
5	5350.00	56.3 PK	74.0	-17.7	1.97 V	12	54.8	1.5
6	5350.00	40.1 AV	54.0	-13.9	1.97 V	12	38.6	1.5
7	#10420.00	50.6 PK	68.2	-17.6	1.54 V	104	38.2	12.4
8	15630.00	49.6 PK	74.0	-24.4	1.48 V	111	37.8	11.8
9	15630.00	35.4 AV	54.0	-18.6	1.48 V	111	23.6	11.8

REMARKS:

- Emission Level(dBuV/m) = Raw Value(dBuV) + Correction Factor(dB/m)
- Correction Factor(dB/m) = Antenna Factor(dB/m) + Cable Factor(dB) – Pre-Amplifier Factor(dB)
- Margin value = Emission Level – Limit value
- The other emission levels were very low against the limit.
- " * ": Fundamental frequency.
- " # ": The radiated frequency is out of the restricted band.

CHANNEL	TX Channel 58	DETECTOR FUNCTION	Peak (PK)
FREQUENCY RANGE	1GHz ~ 40GHz		Average (AV)

ANTENNA POLARITY & TEST DISTANCE: HORIZONTAL AT 3 M

NO.	FREQ. (MHz)	EMISSION LEVEL (dBuV/m)	LIMIT (dBuV/m)	MARGIN (dB)	ANTENNA HEIGHT (m)	TABLE ANGLE (Degree)	RAW VALUE (dBuV)	CORRECTION FACTOR (dB/m)
1	5150.00	49.1 PK	74.0	-24.9	1.50 H	114	47.0	2.1
2	5150.00	36.5 AV	54.0	-17.5	1.50 H	114	34.4	2.1
3	*5290.00	84.9 PK			1.50 H	114	83.5	1.4
4	*5290.00	72.6 AV			1.50 H	114	71.2	1.4
5	5350.00	49.4 PK	74.0	-24.6	1.50 H	114	47.9	1.5
6	5350.00	36.6 AV	54.0	-17.4	1.50 H	114	35.1	1.5
7	#10580.00	50.7 PK	68.2	-17.5	1.47 H	197	37.8	12.9
8	15870.00	46.5 PK	74.0	-27.5	1.56 H	161	34.9	11.6
9	15870.00	34.2 AV	54.0	-19.8	1.56 H	161	22.6	11.6

ANTENNA POLARITY & TEST DISTANCE: VERTICAL AT 3 M

NO.	FREQ. (MHz)	EMISSION LEVEL (dBuV/m)	LIMIT (dBuV/m)	MARGIN (dB)	ANTENNA HEIGHT (m)	TABLE ANGLE (Degree)	RAW VALUE (dBuV)	CORRECTION FACTOR (dB/m)
1	5150.00	57.1 PK	74.0	-16.9	1.98 V	12	55.0	2.1
2	5150.00	42.7 AV	54.0	-11.3	1.98 V	12	40.6	2.1
3	*5290.00	102.6 PK			1.98 V	12	101.2	1.4
4	*5290.00	92.3 AV			1.98 V	12	90.9	1.4
5	5350.00	64.9 PK	74.0	-9.1	1.98 V	12	63.4	1.5
6	5350.00	51.5 AV	54.0	-2.5	1.98 V	12	50.0	1.5
7	#10580.00	50.6 PK	68.2	-17.6	1.50 V	184	37.7	12.9
8	15870.00	47.8 PK	74.0	-26.2	1.54 V	158	36.2	11.6
9	15870.00	34.3 AV	54.0	-19.7	1.54 V	158	22.7	11.6

REMARKS:

1. Emission Level(dBuV/m) = Raw Value(dBuV) + Correction Factor(dB/m)
2. Correction Factor(dB/m) = Antenna Factor(dB/m) + Cable Factor(dB) – Pre-Amplifier Factor(dB)
3. Margin value = Emission Level – Limit value
4. The other emission levels were very low against the limit.
5. " * ": Fundamental frequency.
6. " # ": The radiated frequency is out of the restricted band.

CHANNEL	TX Channel 106	DETECTOR FUNCTION	Peak (PK)
FREQUENCY RANGE	1GHz ~ 40GHz		Average (AV)

ANTENNA POLARITY & TEST DISTANCE: HORIZONTAL AT 3 M

NO.	FREQ. (MHz)	EMISSION LEVEL (dBuV/m)	LIMIT (dBuV/m)	MARGIN (dB)	ANTENNA HEIGHT (m)	TABLE ANGLE (Degree)	RAW VALUE (dBuV)	CORRECTION FACTOR (dB/m)
1	5460.00	50.2 PK	74.0	-23.8	1.40 H	245	48.3	1.9
2	5460.00	37.0 AV	54.0	-17.0	1.40 H	245	35.1	1.9
3	#5470.00	52.9 PK	68.2	-15.3	1.40 H	245	51.0	1.9
4	*5530.00	84.7 PK			1.40 H	245	82.7	2.0
5	*5530.00	72.0 AV			1.40 H	245	70.0	2.0
6	#5725.00	49.0 PK	68.2	-19.2	1.40 H	245	46.8	2.2
7	11060.00	49.3 PK	74.0	-24.7	1.44 H	343	36.1	13.2
8	11060.00	37.8 AV	54.0	-16.2	1.44 H	343	24.6	13.2
9	#16590.00	46.3 PK	68.2	-21.9	1.50 H	311	31.5	14.8

ANTENNA POLARITY & TEST DISTANCE: VERTICAL AT 3 M

NO.	FREQ. (MHz)	EMISSION LEVEL (dBuV/m)	LIMIT (dBuV/m)	MARGIN (dB)	ANTENNA HEIGHT (m)	TABLE ANGLE (Degree)	RAW VALUE (dBuV)	CORRECTION FACTOR (dB/m)
1	5460.00	64.9 PK	74.0	-9.1	1.98 V	10	63.0	1.9
2	5460.00	51.1 AV	54.0	-2.9	1.98 V	10	49.2	1.9
3	#5470.00	68.0 PK	68.2	-0.2	1.98 V	10	66.1	1.9
4	*5530.00	100.8 PK			1.98 V	10	98.8	2.0
5	*5530.00	91.0 AV			1.98 V	10	89.0	2.0
6	#5725.00	53.0 PK	68.2	-15.2	1.98 V	10	50.8	2.2
7	11060.00	50.3 PK	74.0	-23.7	1.50 V	167	37.1	13.2
8	11060.00	38.6 AV	54.0	-15.4	1.50 V	167	25.4	13.2
9	#16590.00	50.6 PK	68.2	-17.6	1.47 V	218	35.8	14.8

REMARKS:

1. Emission Level(dBuV/m) = Raw Value(dBuV) + Correction Factor(dB/m)
2. Correction Factor(dB/m) = Antenna Factor(dB/m) + Cable Factor(dB) – Pre-Amplifier Factor(dB)
3. Margin value = Emission Level – Limit value
4. The other emission levels were very low against the limit.
5. " * ": Fundamental frequency.
6. " # ": The radiated frequency is out of the restricted band.

CHANNEL	TX Channel 122	DETECTOR FUNCTION	Peak (PK)
FREQUENCY RANGE	1GHz ~ 40GHz		Average (AV)

ANTENNA POLARITY & TEST DISTANCE: HORIZONTAL AT 3 M

NO.	FREQ. (MHz)	EMISSION LEVEL (dBuV/m)	LIMIT (dBuV/m)	MARGIN (dB)	ANTENNA HEIGHT (m)	TABLE ANGLE (Degree)	RAW VALUE (dBuV)	CORRECTION FACTOR (dB/m)
1	5460.00	48.9 PK	74.0	-25.1	1.40 H	99	47.0	1.9
2	5460.00	35.8 AV	54.0	-18.2	1.40 H	99	33.9	1.9
3	#5470.00	49.7 PK	68.2	-18.5	1.40 H	99	47.8	1.9
4	*5610.00	85.1 PK			1.40 H	99	83.0	2.1
5	*5610.00	72.7 AV			1.40 H	99	70.6	2.1
6	#5725.00	49.1 PK	68.2	-19.1	1.40 H	99	46.9	2.2
7	11220.00	49.6 PK	74.0	-24.4	1.48 H	346	37.0	12.6
8	11220.00	38.3 AV	54.0	-15.7	1.48 H	346	25.7	12.6
9	#16830.00	47.0 PK	68.2	-21.2	1.41 H	315	30.7	16.3

ANTENNA POLARITY & TEST DISTANCE: VERTICAL AT 3 M

NO.	FREQ. (MHz)	EMISSION LEVEL (dBuV/m)	LIMIT (dBuV/m)	MARGIN (dB)	ANTENNA HEIGHT (m)	TABLE ANGLE (Degree)	RAW VALUE (dBuV)	CORRECTION FACTOR (dB/m)
1	5460.00	57.3 PK	74.0	-16.7	1.99 V	14	55.4	1.9
2	5460.00	42.8 AV	54.0	-11.2	1.99 V	14	40.9	1.9
3	#5470.00	61.2 PK	68.2	-7.0	1.99 V	14	59.3	1.9
4	*5610.00	104.4 PK			1.99 V	14	102.3	2.1
5	*5610.00	93.1 AV			1.99 V	14	91.0	2.1
6	#5725.00	59.8 PK	68.2	-8.4	1.99 V	14	57.6	2.2
7	11220.00	50.5 PK	74.0	-23.5	1.53 V	191	37.9	12.6
8	11220.00	38.5 AV	54.0	-15.5	1.53 V	191	25.9	12.6
9	#16830.00	50.7 PK	68.2	-17.5	1.48 V	154	34.4	16.3

REMARKS:

1. Emission Level(dBuV/m) = Raw Value(dBuV) + Correction Factor(dB/m)
2. Correction Factor(dB/m) = Antenna Factor(dB/m) + Cable Factor(dB) – Pre-Amplifier Factor(dB)
3. Margin value = Emission Level – Limit value
4. The other emission levels were very low against the limit.
5. " * ": Fundamental frequency.
6. " # ": The radiated frequency is out of the restricted band.

CHANNEL	TX Channel 138	DETECTOR FUNCTION	Peak (PK)
FREQUENCY RANGE	1GHz ~ 40GHz		Average (AV)

ANTENNA POLARITY & TEST DISTANCE: HORIZONTAL AT 3 M

NO.	FREQ. (MHz)	EMISSION LEVEL (dBuV/m)	LIMIT (dBuV/m)	MARGIN (dB)	ANTENNA HEIGHT (m)	TABLE ANGLE (Degree)	RAW VALUE (dBuV)	CORRECTION FACTOR (dB/m)
1	#5470.00	53.5 PK	68.2	-14.7	1.36 H	106	51.6	1.9
2	*5690.00	85.0 PK			1.36 H	106	82.9	2.1
3	*5690.00	72.3 AV			1.36 H	106	70.2	2.1
4	#5850.00	64.4 PK	68.2	-3.8	1.36 H	106	61.8	2.6
5	11380.00	49.7 PK	74.0	-24.3	1.43 H	357	36.4	13.3
6	11380.00	38.4 AV	54.0	-15.6	1.43 H	357	25.1	13.3
7	#17070.00	46.3 PK	68.2	-21.9	1.46 H	320	29.4	16.9

ANTENNA POLARITY & TEST DISTANCE: VERTICAL AT 3 M

NO.	FREQ. (MHz)	EMISSION LEVEL (dBuV/m)	LIMIT (dBuV/m)	MARGIN (dB)	ANTENNA HEIGHT (m)	TABLE ANGLE (Degree)	RAW VALUE (dBuV)	CORRECTION FACTOR (dB/m)
1	#5470.00	53.1 PK	68.2	-15.1	1.93 V	24	51.2	1.9
2	*5690.00	104.5 PK			1.93 V	24	102.4	2.1
3	*5690.00	93.5 AV			1.93 V	24	91.4	2.1
4	#5850.00	64.6 PK	68.2	-3.6	1.93 V	24	62.0	2.6
5	11380.00	50.6 PK	74.0	-23.4	1.57 V	180	37.3	13.3
6	11380.00	38.3 AV	54.0	-15.7	1.57 V	180	25.0	13.3
7	#17070.00	50.9 PK	68.2	-17.3	1.53 V	147	34.0	16.9

REMARKS:

1. Emission Level(dBuV/m) = Raw Value(dBuV) + Correction Factor(dB/m)
2. Correction Factor(dB/m) = Antenna Factor(dB/m) + Cable Factor(dB) – Pre-Amplifier Factor(dB)
3. Margin value = Emission Level – Limit value
4. The other emission levels were very low against the limit.
5. " * ": Fundamental frequency.
6. " # ": The radiated frequency is out of the restricted band.

CHANNEL	TX Channel 155	DETECTOR FUNCTION	Peak (PK)
FREQUENCY RANGE	1GHz ~ 40GHz		Average (AV)

ANTENNA POLARITY & TEST DISTANCE: HORIZONTAL AT 3 M

NO.	FREQ. (MHz)	EMISSION LEVEL (dBuV/m)	LIMIT (dBuV/m)	MARGIN (dB)	ANTENNA HEIGHT (m)	TABLE ANGLE (Degree)	RAW VALUE (dBuV)	CORRECTION FACTOR (dB/m)
1	#5590.82	51.7 PK	68.2	-16.5	1.55 H	46	49.6	2.1
2	*5775.00	87.5 PK			1.55 H	46	85.1	2.4
3	*5775.00	79.0 AV			1.55 H	46	76.6	2.4
4	#5984.75	51.9 PK	68.2	-16.3	1.55 H	46	49.0	2.9
5	11550.00	48.9 PK	74.0	-25.1	1.55 H	319	34.7	14.2
6	11550.00	37.7 AV	54.0	-16.3	1.55 H	319	23.5	14.2
7	#17325.00	46.0 PK	68.2	-22.2	1.50 H	328	27.9	18.1

ANTENNA POLARITY & TEST DISTANCE: VERTICAL AT 3 M

NO.	FREQ. (MHz)	EMISSION LEVEL (dBuV/m)	LIMIT (dBuV/m)	MARGIN (dB)	ANTENNA HEIGHT (m)	TABLE ANGLE (Degree)	RAW VALUE (dBuV)	CORRECTION FACTOR (dB/m)
1	#5648.79	60.7 PK	68.2	-7.5	2.00 V	10	58.7	2.0
2	*5775.00	103.7 PK			2.00 V	10	101.3	2.4
3	*5775.00	92.8 AV			2.00 V	10	90.4	2.4
4	#5928.22	54.0 PK	68.2	-14.2	2.00 V	10	51.3	2.7
5	11550.00	52.2 PK	74.0	-21.8	1.55 V	55	38.0	14.2
6	11550.00	40.6 AV	54.0	-13.4	1.55 V	55	26.4	14.2
7	#17325.00	52.7 PK	68.2	-15.5	1.49 V	74	34.6	18.1

REMARKS:

- Emission Level(dBuV/m) = Raw Value(dBuV) + Correction Factor(dB/m)
- Correction Factor(dB/m) = Antenna Factor(dB/m) + Cable Factor(dB) – Pre-Amplifier Factor(dB)
- Margin value = Emission Level – Limit value
- The other emission levels were very low against the limit.
- " * ": Fundamental frequency.
- " # ": The radiated frequency is out of the restricted band.

Below 1GHz Data:

802.11a

CHANNEL	TX Channel 157	DETECTOR FUNCTION	Quasi-Peak (QP)
FREQUENCY RANGE	9kHz ~ 1GHz		

ANTENNA POLARITY & TEST DISTANCE: HORIZONTAL AT 3 M								
NO.	FREQ. (MHz)	EMISSION LEVEL (dBuV/m)	LIMIT (dBuV/m)	MARGIN (dB)	ANTENNA HEIGHT (m)	TABLE ANGLE (Degree)	RAW VALUE (dBuV)	CORRECTION FACTOR (dB/m)
1	166.24	41.5 QP	43.5	-2.0	2.00 H	197	54.7	-13.2
2	186.13	40.2 QP	43.5	-3.3	2.00 H	1	55.4	-15.2
3	239.97	40.0 QP	46.0	-6.0	1.00 H	357	54.2	-14.2
4	399.10	33.0 QP	46.0	-13.0	1.00 H	340	43.0	-10.0
5	697.01	42.3 QP	46.0	-3.7	1.00 H	264	46.3	-4.0
6	896.20	40.1 QP	46.0	-5.9	1.50 H	254	41.6	-1.5

REMARKS:

1. Emission Level(dBuV/m) = Raw Value(dBuV) + Correction Factor(dB/m)
2. Correction Factor(dB/m) = Antenna Factor(dB/m) + Cable Factor(dB) – Pre-Amplifier Factor(dB)
3. Margin value = Emission Level – Limit value
4. The other emission levels were very low against the limit of frequency range 30MHz~1000MHz.
5. The emission levels were very low against the limit of frequency range 9kHz~30MHz: the amplitude of spurious emissions attenuated more than 20 dB below the permissible value to be report.

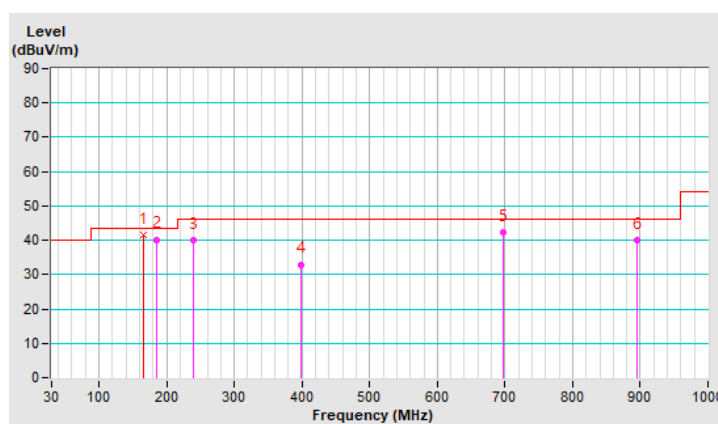

CHANNEL	TX Channel 157	DETECTOR FUNCTION	Quasi-Peak (QP)
FREQUENCY RANGE	9kHz ~ 1GHz		

ANTENNA POLARITY & TEST DISTANCE: VERTICAL AT 3 M

NO.	FREQ. (MHz)	EMISSION LEVEL (dBuV/m)	LIMIT (dBuV/m)	MARGIN (dB)	ANTENNA HEIGHT (m)	TABLE ANGLE (Degree)	RAW VALUE (dBuV)	CORRECTION FACTOR (dB/m)
1	30.53	36.0 QP	40.0	-4.0	1.00 V	310	50.6	-14.6
2	166.24	36.3 QP	43.5	-7.2	1.00 V	307	49.5	-13.2
3	199.13	34.4 QP	43.5	-9.1	2.00 V	122	50.0	-15.6
4	298.75	40.2 QP	46.0	-5.8	1.50 V	291	52.6	-12.4
5	665.19	31.4 QP	46.0	-14.6	2.00 V	243	36.1	-4.7
6	898.00	36.6 QP	46.0	-9.4	2.50 V	283	38.1	-1.5

REMARKS:

1. Emission Level(dBuV/m) = Raw Value(dBuV) + Correction Factor(dB/m)
2. Correction Factor(dB/m) = Antenna Factor(dB/m) + Cable Factor(dB) – Pre-Amplifier Factor(dB)
3. Margin value = Emission Level – Limit value
4. The other emission levels were very low against the limit of frequency range 30MHz~1000MHz.
5. The emission levels were very low against the limit of frequency range 9kHz~30MHz: the amplitude of spurious emissions attenuated more than 20 dB below the permissible value to be report.

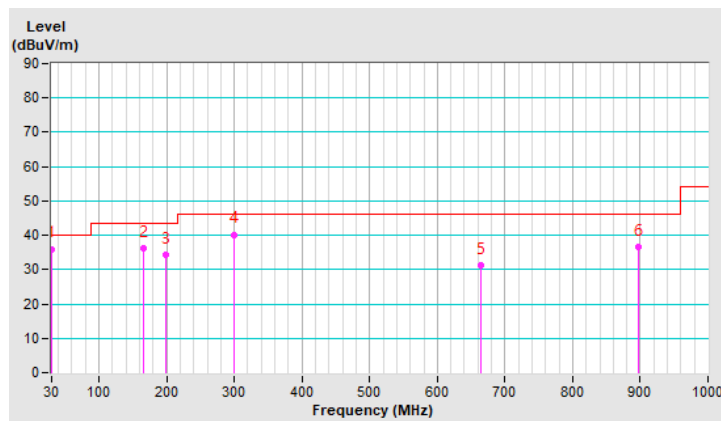

4.2 Conducted Emission Measurement

4.2.1 Limits of Conducted Emission Measurement

Frequency (MHz)	Conducted Limit (dBuV)	
	Quasi-peak	Average
0.15 - 0.5	66 - 56	56 - 46
0.50 - 5.0	56	46
5.0 - 30.0	60	50

Note: 1. The lower limit shall apply at the transition frequencies.

2. The limit decreases in line with the logarithm of the frequency in the range of 0.15 to 0.50MHz.

4.2.2 Test Instruments

DESCRIPTION & MANUFACTURER	MODEL NO.	SERIAL NO.	CALIBRATED DATE	CALIBRATED UNTIL
Test Receiver R&S	ESCS 30	847124/029	Oct. 24, 2018	Oct. 23, 2019
Line-Impedance Stabilization Network (for EUT) R&S	ESH3-Z5	848773/004	Oct. 22, 2018	Oct. 21, 2019
Line-Impedance Stabilization Network (for Peripheral) R&S	ESH3-Z5	835239/001	Mar. 17, 2019	Mar. 16, 2020
50 ohms Terminator	N/A	3	Oct. 22, 2018	Oct. 21, 2019
RF Cable	5D-FB	COCCAB-001	Sep. 28, 2018	Sep. 27, 2019
Fixed attenuator EMCI	STI02-2200-10	003	Mar. 14, 2019	Mar. 13, 2020
Software BVADT	BVADT_Cond_ V7.3.7.4	NA	NA	NA

Note:

1. The calibration interval of the above test instruments are 12 months and the calibrations are traceable to NML/ROC and NIST/USA.
2. The test was performed in Conduction 1.
3. Tested Date: July 25, 2019

4.2.3 Test Procedure

- The EUT was placed 0.4 meters from the conducting wall of the shielded room with EUT being connected to the power mains through a line impedance stabilization network (LISN). Other support units were connected to the power mains through another LISN. The two LISNs provide 50 ohm/ 50uH of coupling impedance for the measuring instrument.
- Both lines of the power mains connected to the EUT were checked for maximum conducted interference.
- The frequency range from 150kHz to 30MHz was searched. Emission levels under (Limit - 20dB) was not recorded.

NOTE: All modes of operation were investigated and the worst-case emissions are reported.

4.2.4 Deviation from Test Standard

No deviation.

4.2.5 Test Setup

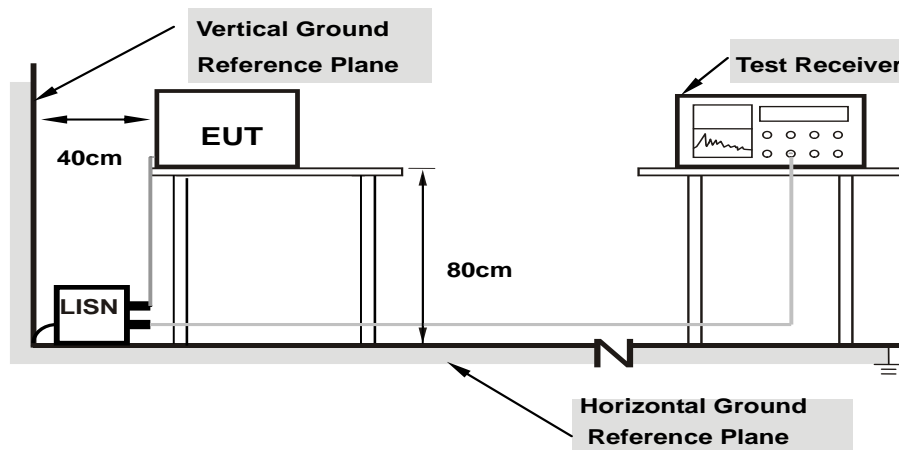

Note: 1.Support units were connected to second LISN.

For the actual test configuration, please refer to the attached file (Test Setup Photo).

4.2.6 EUT Operating Condition

Same as 4.1.6.

4.2.7 Test Results

Phase	Line (L)	Detector Function	Quasi-Peak (QP) / Average (AV)
-------	----------	-------------------	--------------------------------

No	Freq. [MHz]	Corr.	Reading Value		Emission Level		Limit		Margin	
		Factor (dB)	[dB (uV)]		[dB (uV)]		[dB (uV)]		(dB)	
			Q.P.	AV.	Q.P.	AV.	Q.P.	AV.	Q.P.	AV.
1	0.15000	9.94	49.39	36.72	59.33	46.66	66.00	56.00	-6.67	-9.34
2	0.16562	9.95	47.58	36.26	57.53	46.21	65.18	55.18	-7.65	-8.97
3	0.20078	9.95	41.40	30.17	51.35	40.12	63.58	53.58	-12.23	-13.46
4	0.26719	9.95	37.20	24.19	47.15	34.14	61.20	51.20	-14.05	-17.06
5	0.44297	9.96	40.34	30.73	50.30	40.69	57.01	47.01	-6.71	-6.32
6	0.53672	9.97	27.95	13.69	37.92	23.66	56.00	46.00	-18.08	-22.34
7	1.77344	10.05	24.35	15.54	34.40	25.59	56.00	46.00	-21.60	-20.41

REMARKS:

1. Q.P. and AV. are abbreviations of quasi-peak and average individually.
2. The emission levels of other frequencies were very low against the limit.
3. Margin value = Emission level - Limit value
4. Correction factor = Insertion loss + Cable loss
5. Emission Level = Correction Factor + Reading Value.

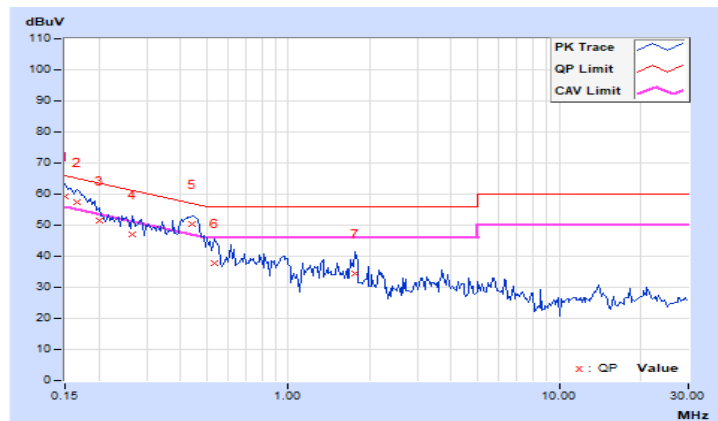

Phase	Neutral (N)	Detector Function	Quasi-Peak (QP) / Average (AV)
-------	-------------	-------------------	--------------------------------

No	Freq. [MHz]	Corr. Factor	Reading Value [dB (uV)]		Emission Level [dB (uV)]		Limit [dB (uV)]		Margin (dB)	
		(dB)	Q.P.	AV.	Q.P.	AV.	Q.P.	AV.	Q.P.	AV.
	1	0.15000	9.92	49.41	37.07	59.33	46.99	66.00	56.00	-6.67
2	0.18125	9.93	44.08	31.29	54.01	41.22	64.43	54.43	-10.42	-13.21
3	0.27500	9.93	38.17	27.37	48.10	37.30	60.97	50.97	-12.87	-13.67
4	0.43906	9.94	40.29	30.20	50.23	40.14	57.08	47.08	-6.85	-6.94
5	0.50547	9.95	31.18	19.96	41.13	29.91	56.00	46.00	-14.87	-16.09
6	1.75391	10.02	24.43	15.12	34.45	25.14	56.00	46.00	-21.55	-20.86
7	14.48438	10.55	21.09	11.87	31.64	22.42	60.00	50.00	-28.36	-27.58

REMARKS:

1. Q.P. and AV. are abbreviations of quasi-peak and average individually.
2. The emission levels of other frequencies were very low against the limit.
3. Margin value = Emission level - Limit value
4. Correction factor = Insertion loss + Cable loss
5. Emission Level = Correction Factor + Reading Value.

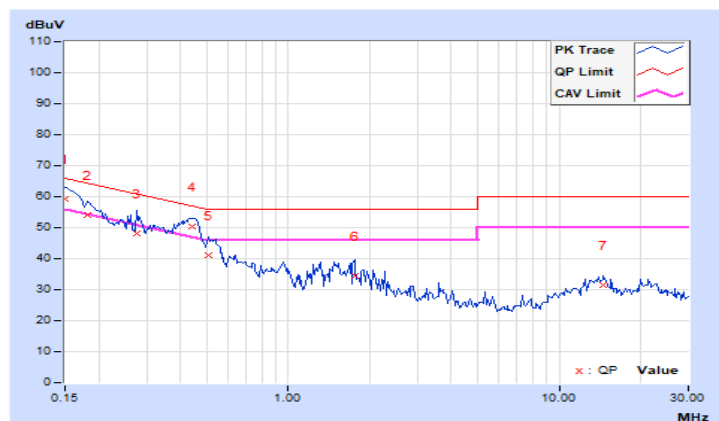

4.3 Transmit Power Measurement

4.3.1 Limits of Transmit Power Measurement

Operation Band	EUT Category		Limit
U-NII-1		Outdoor Access Point	1 Watt (30 dBm) (Max. e.i.r.p \leq 125mW(21 dBm) at any elevation angle above 30 degrees as measured from the horizon)
		Fixed point-to-point Access Point	1 Watt (30 dBm)
		Indoor Access Point	1 Watt (30 dBm)
	√	Client device	250mW (24 dBm)
U-NII-2A	√		250mW (24 dBm) or 11 dBm+10 log B*
U-NII-2C	√		250mW (24 dBm) or 11 dBm+10 log B*
U-NII-3	√		1 Watt (30 dBm)

*B is the 26 dB emission bandwidth in megahertz

Per KDB 662911 Method of conducted output power measurement on IEEE 802.11 devices,

Array Gain = 0 dB (i.e., no array gain) for $N_{ANT} \leq 4$;

Array Gain = 0 dB (i.e., no array gain) for channel widths ≥ 40 MHz for any N_{ANT} ;

Array Gain = $5 \log(N_{ANT}/N_{SS})$ dB or 3 dB, whichever is less for 20-MHz channel widths with $N_{ANT} \geq 5$.

For power measurements on all other devices: Array Gain = $10 \log(N_{ANT}/N_{SS})$ dB.

4.3.2 Test Setup

FOR POWER OUTPUT MEASUREMENT

For channel straddling 5725MHz:

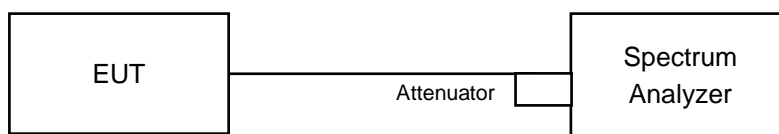

For other channels:

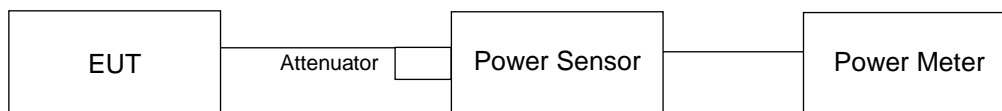

FOR 26dB OCCUPIED BANDWIDTH

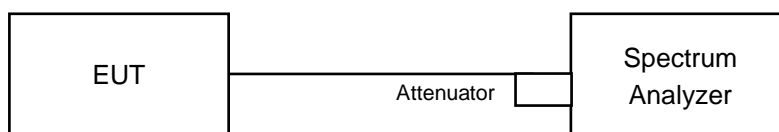

4.3.3 Test Instruments

Refer to section 4.1.2 to get information of above instrument.

4.3.4 Test Procedure

FOR POWER OUTPUT MEASUREMENT

For other channels:

Method PM is used to perform output power measurement, trigger and gating function of wide band power meter is enabled to measure max output power of TX on burst. Duty factor is not added to measured value.

For channel straddling 5725MHz:

Follow FCC KDB 789033 UNII test procedure:

Method SA-2

1. Set span to encompass the emission bandwidth (EBW) of the signal.
2. Set RBW =1MHz.
3. Set the VBW $\geq 3 \times$ RBW.
4. Number of points in sweep ≥ 2 Span / RBW.
5. Sweep time = auto.
6. Detector = RMS.
7. Trace average at least 100 traces in power averaging mode
8. Compute power by integrating the spectrum across the 26 dB EBW of the signal.
9. Duty factor need added to measured value (duty cycle < 98 percent).

FOR 26dB OCCUPIED BANDWIDTH

1. Set RBW = approximately 1% of the emission bandwidth.
2. Set the VBW > RBW.
3. Detector = Peak.
4. Trace mode = max hold.
5. Measure the maximum width of the emission that is 26 dB down from the peak of the emission. Compare this with the RBW setting of the analyzer. Readjust RBW and repeat measurement as needed until the RBW/EBW ratio is approximately 1%.

4.3.5 Deviation from Test Standard

No deviation.

4.3.6 EUT Operating Condition

The software provided by client to enable the EUT under transmission condition continuously at lowest, middle and highest channel frequencies individually.

4.3.7 Test Results

802.11a

POWER OUTPUT

Chan.	Chan. Freq. (MHz)	Maximum Conducted Power (dBm)		Total Power (mW)	Total Power (dBm)	Limit (dBm)	Pass / Fail
		Chain 0	Chain 1				
36	5180	13.09	13.24	41.456	16.18	24.00	Pass
40	5200	13.14	13.47	42.839	16.32	24.00	Pass
48	5240	13.13	13.37	42.286	16.26	24.00	Pass
52	5260	13.28	13.50	43.668	16.40	23.94	Pass
60	5300	13.20	13.14	41.499	16.18	23.92	Pass
64	5320	13.53	13.23	43.58	16.39	24.00	Pass
100	5500	9.89	8.56	16.928	12.29	23.92	Pass
116	5580	13.26	13.04	41.321	16.16	23.89	Pass
140	5700	7.82	4.66	8.977	9.53	23.86	Pass
*144 (U-NII-2C Band)	5720	8.93	8.71	16.051	12.06	22.68	Pass
*144 (U-NII-3 Band)	5720	1.42	1.21	2.851	4.55	30.00	Pass
149	5745	13.87	13.27	45.61	16.59	30.00	Pass
157	5785	13.95	13.39	46.658	16.69	30.00	Pass
165	5825	13.98	13.13	45.562	16.59	30.00	Pass

Note: * Test was performed in accordance with Measurement follow FCC KDB 789033 UNII test procedure Method SA-2 and use spectrum analyzer test.

The Total Power for the straddle channel:

Chan.	Chan. Freq. (MHz)	Average Power (mW)	Average Power (dBm)
144	5720	18.902	12.77

Note: The total power was calculated through formula and record the value for reference only.

26dB OCCUPIED BANDWIDTH

Channel	Frequency (MHz)	26dBc Bandwidth (MHz)	
		Chain 0	Chain 1
52	5260	19.95	19.71
60	5300	19.60	19.93
64	5320	19.97	20.26
100	5500	19.61	19.72
116	5580	22.90	19.46
140	5700	19.65	19.33
144 (U-NII-2C Band)	5720	14.74	15.01

Note: For U-NII-2A, U-NII-2C Band output power limitation is determined based on 26dBc bandwidth

Power Limit = 11dBm + 10logB < U-NII-2A, U-NII-2C >			
Channel Number	Freq.(MHz)	Min. B(MHz)	Determined Conducted Limit (dBm)
52	5260	19.71	23.94 < 24
60	5300	19.60	23.92 < 24
64	5320	19.97	24 = 24
100	5500	19.61	23.92 < 24
116	5580	19.46	23.89 < 24
140	5700	19.33	23.86 < 24
144 (U-NII-2C Band)	5720	14.74	22.68 < 24

802.11ac (VHT20)
POWER OUTPUT

Chan.	Chan. Freq. (MHz)	Maximum Conducted Power (dBm)		Total Power (mW)	Total Power (dBm)	Limit (dBm)	Pass / Fail
		Chain 0	Chain 1				
36	5180	13.09	13.53	42.912	16.33	24.00	Pass
40	5200	13.26	13.84	45.394	16.57	24.00	Pass
48	5240	13.33	13.78	45.406	16.57	24.00	Pass
52	5260	13.29	13.32	42.808	16.32	24.00	Pass
60	5300	13.34	13.12	42.089	16.24	24.00	Pass
64	5320	13.26	13.04	41.321	16.16	24.00	Pass
100	5500	13.00	8.22	26.59	14.25	24.00	Pass
116	5580	13.84	13.46	46.392	16.66	24.00	Pass
140	5700	6.97	4.11	7.553	8.78	24.00	Pass
*144 (U-NII-2C Band)	5720	8.48	8.39	14.765	11.69	22.82	Pass
*144 (U-NII-3 Band)	5720	1.45	1.16	2.86	4.56	30.00	Pass
149	5745	13.68	13.21	44.276	16.46	30.00	Pass
157	5785	13.93	13.20	45.61	16.59	30.00	Pass
165	5825	13.93	13.09	45.087	16.54	30.00	Pass

Note: * Test was performed in accordance with Measurement follow FCC KDB 789033 UNII test procedure Method SA-2 and use spectrum analyzer test.

The Total Power for the straddle channel:

Chan.	Chan. Freq. (MHz)	Average Power (mW)	Average Power (dBm)
144	5720	17.625	12.46

Note: The total power was calculated through formula and record the value for reference only.

26dB OCCUPIED BANDWIDTH

Channel	Frequency (MHz)	26dBc Bandwidth (MHz)	
		Chain 0	Chain 1
52	5260	20.57	20.38
60	5300	20.45	20.47
64	5320	20.50	20.80
100	5500	20.60	21.05
116	5580	22.87	22.07
140	5700	20.80	20.40
144 (U-NII-2C Band)	5720	15.36	15.23

Note: For U-NII-2A, U-NII-2C Band output power limitation is determined based on 26dBc bandwidth

Power Limit = 11dBm + 10logB < U-NII-2A, U-NII-2C >			
Channel Number	Freq.(MHz)	Min. B(MHz)	Determined Conducted Limit (dBm)
52	5260	20.38	24.09 > 24
60	5300	20.45	24.1 > 24
64	5320	20.50	24.11 > 24
100	5500	20.60	24.13 > 24
116	5580	22.07	24.43 > 24
140	5700	20.40	24.09 > 24
144 (U-NII-2C Band)	5720	15.23	22.82 < 24

802.11ac (VHT40)
POWER OUTPUT

Chan.	Chan. Freq. (MHz)	Maximum Conducted Power (dBm)		Total Power (mW)	Total Power (dBm)	Limit (dBm)	Pass / Fail
		Chain 0	Chain 1				
38	5190	12.05	12.52	33.897	15.30	24.00	Pass
46	5230	12.22	12.67	35.165	15.46	24.00	Pass
54	5270	12.40	12.29	34.321	15.36	24.00	Pass
62	5310	1.00	12.57	19.331	12.86	24.00	Pass
102	5510	8.68	7.26	12.7	11.04	24.00	Pass
110	5550	12.20	12.05	32.628	15.14	24.00	Pass
134	5670	12.31	12.15	33.428	15.24	24.00	Pass
*142 (U-NII-2C Band)	5710	7.06	6.77	10.982	10.41	24.00	Pass
*142 (U-NII-3 Band)	5710	-5.20	-5.72	0.6363	-1.96	30.00	Pass
151	5755	12.95	12.43	37.222	15.71	30.00	Pass
159	5795	12.00	12.06	31.918	15.04	30.00	Pass

Note: * Test was performed in accordance with Measurement follow FCC KDB 789033 UNII test procedure Method SA-2 and use spectrum analyzer test.

The Total Power for the straddle channel:

Chan.	Chan. Freq. (MHz)	Average Power (mW)	Average Power (dBm)
142	5710	11.6183	10.65

Note: The total power was calculated through formula and record the value for reference only.

26dB OCCUPIED BANDWIDTH

Channel	Frequency (MHz)	26dBc Bandwidth (MHz)	
		Chain 0	Chain 1
54	5270	45.91	51.67
62	5310	42.39	45.19
102	5510	50.94	43.88
110	5550	44.68	44.38
134	5670	42.07	47.09
142 (U-NII-2C Band)	5710	36.06	41.03

Note: For U-NII-2A, U-NII-2C Band output power limitation is determined based on 26dBc bandwidth

Power Limit = 11dBm + 10logB < U-NII-2A, U-NII-2C >			
Channel Number	Freq.(MHz)	Min. B(MHz)	Determined Conducted Limit (dBm)
54	5270	45.91	27.61 > 24
62	5310	42.39	27.27 > 24
102	5510	43.88	27.42 > 24
110	5550	44.38	27.47 > 24
134	5670	42.07	27.23 > 24
142 (U-NII-2C Band)	5710	36.06	26.57 > 24

802.11ac (VHT80)

POWER OUTPUT

Chan.	Chan. Freq. (MHz)	Maximum Conducted Power (dBm)		Total Power (mW)	Total Power (dBm)	Limit (dBm)	Pass / Fail
		Chain 0	Chain 1				
42	5210	11.79	9.55	24.117	13.82	24.00	Pass
58	5290	11.74	11.69	29.685	14.73	24.00	Pass
106	5530	9.42	8.16	15.296	11.85	24.00	Pass
122	5610	11.25	11.21	26.548	14.24	24.00	Pass
*138 (U-NII-2C Band)	5690	5.89	4.16	7.922	8.99	24.00	Pass
*138 (U-NII-3 Band)	5690	-12.46	-11.61	0.15357	-8.14	30.00	Pass
155	5775	11.41	11.08	26.659	14.26	30.00	Pass

Note: * Test was performed in accordance with Measurement follow FCC KDB 789033 UNII test procedure Method SA-2 and use spectrum analyzer test.

The Total Power for the straddle channel:

Chan.	Chan. Freq. (MHz)	Average Power (mW)	Average Power (dBm)
138	5690	8.07557	9.07

Note: The total power was calculated through formula and record the value for reference only.

26dB OCCUPIED BANDWIDTH

Channel	Frequency (MHz)	26dBc Bandwidth (MHz)	
		Chain 0	Chain 1
58	5290	82.31	82.75
106	5530	82.39	81.08
122	5610	83.30	82.47
138 (U-NII-2C Band)	5690	77.02	76.75

Note: For U-NII-2A, U-NII-2C Band output power limitation is determined based on 26dBc bandwidth

Power Limit = 11dBm + 10logB < U-NII-2A, U-NII-2C >			
Channel Number	Freq.(MHz)	Min. B(MHz)	Determined Conducted Limit (dBm)
58	5290	82.31	30.15 > 24
106	5530	81.08	30.08 > 24
122	5610	82.47	30.16 > 24
138 (U-NII-2C Band)	5690	76.75	29.85 > 24

Spectrum Plot of Worst Value

802.11a_Chain 0 / CH144 (U-NII-2C)

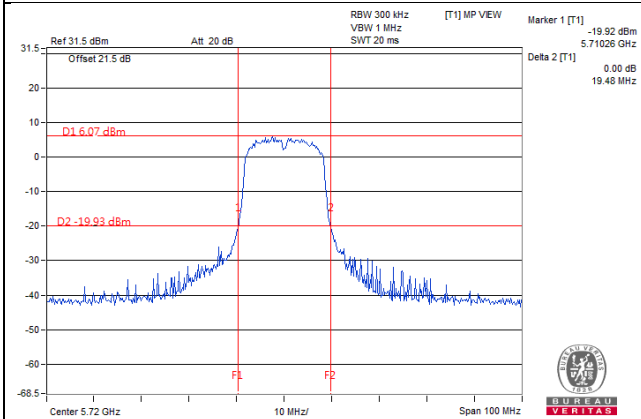

802.11ac (VHT20)_Chain 1 / CH144 (U-NII-2C)

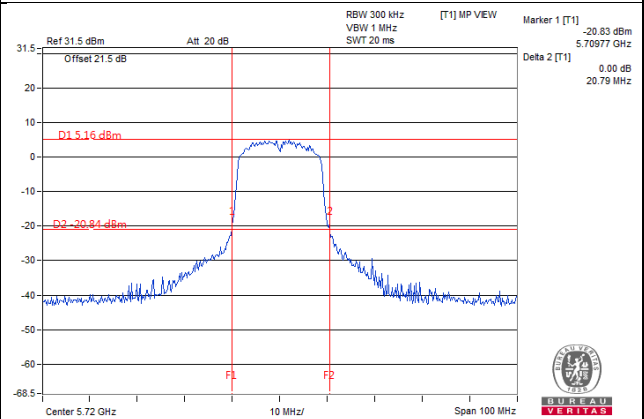

802.11ac (VHT40)_Chain 0 / CH142 (U-NII-2C)

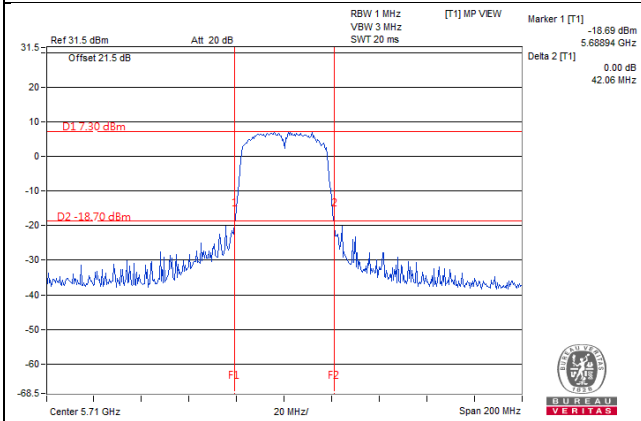

802.11ac (VHT80)_Chain 1 / CH138 (U-NII-2C)

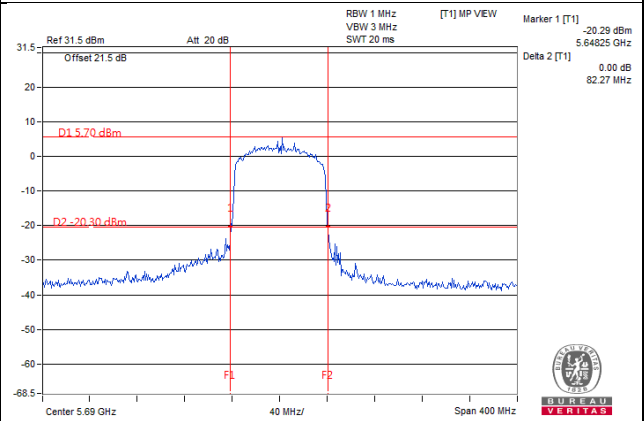

Note:

- For CH144 (U-NII-2C) = 5725MHz - Marker 1
- For CH142 (U-NII-2C) = 5725MHz - Marker 1
- For CH138 (U-NII-2C) = 5725MHz - Marker 1

4.4 Occupied Bandwidth Measurement

4.4.1 Test Setup

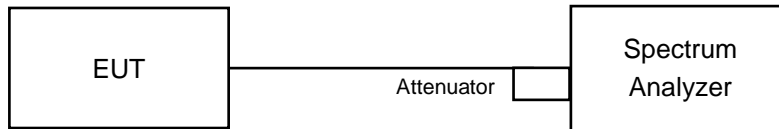

4.4.2 Test Instruments

Refer to section 4.1.2 to get information of above instrument.

4.4.3 Test Procedure

The transmitter output was connected to the spectrum analyzer through an attenuator. The bandwidth of the fundamental frequency was measured by spectrum analyzer with resolution bandwidth in the range of 1% to 5% of the anticipated emission bandwidth, and a video bandwidth at least 3x the resolution bandwidth and set the detector to SAMPLE. The width of a frequency band such that, below the lower and above the upper frequency limits, the mean powers emitted are each equal to a specified percentage 0.5% of the total mean power of a given emission.

4.4.4 Test Results

802.11a

Channel	Channel Frequency (MHz)	Occupied Bandwidth (MHz)	
		Chain 0	Chain 1
36	5180	16.44	16.44
40	5200	16.44	16.44
48	5240	16.44	16.32
52	5260	16.32	16.32
60	5300	16.32	16.32
64	5320	16.32	16.56
100	5500	16.44	16.32
116	5580	16.44	16.32
140	5700	16.32	16.32
144 (U-NII-2C Band)	5720	13.28	13.28
144 (U-NII-3 Band)	5720	3.16	3.16
149	5745	16.32	16.32
157	5785	16.44	16.44
165	5825	16.32	16.44

802.11ac (VHT20)

Channel	Channel Frequency (MHz)	Occupied Bandwidth (MHz)	
		Chain 0	Chain 1
36	5180	17.52	17.52
40	5200	17.52	17.52
48	5240	17.40	17.52
52	5260	17.52	17.52
60	5300	17.52	17.52
64	5320	17.52	17.52
100	5500	17.52	17.64
116	5580	17.52	17.52
140	5700	17.64	17.52
144 (U-NII-2C Band)	5720	13.76	13.88
144 (U-NII-3 Band)	5720	3.64	3.64
149	5745	17.52	17.52
157	5785	17.52	17.52
165	5825	17.40	17.52

802.11ac (VHT40)

Channel	Channel Frequency (MHz)	Occupied Bandwidth (MHz)	
		Chain 0	Chain 1
38	5190	36.00	36.24
46	5230	36.00	36.00
54	5270	36.24	36.00
62	5310	36.00	36.00
102	5510	36.24	36.24
110	5550	36.24	36.00
134	5670	36.00	36.00
142 (U-NII-2C Band)	5710	33.24	33.24
142 (U-NII-3 Band)	5710	3.00	2.76
151	5755	36.00	36.00
159	5795	36.00	36.24

802.11ac (VHT80)

Channel	Channel Frequency (MHz)	Occupied Bandwidth (MHz)	
		Chain 0	Chain 1
42	5210	75.36	74.88
58	5290	74.88	74.88
106	5530	74.88	74.88
122	5610	74.88	74.88
138 (U-NII-2C Band)	5690	72.92	72.92
138 (U-NII-3 Band)	5690	1.96	1.96
155	5775	75.36	74.88

Spectrum Plot of Max. Value

802.11a_Chain 1 / CH64

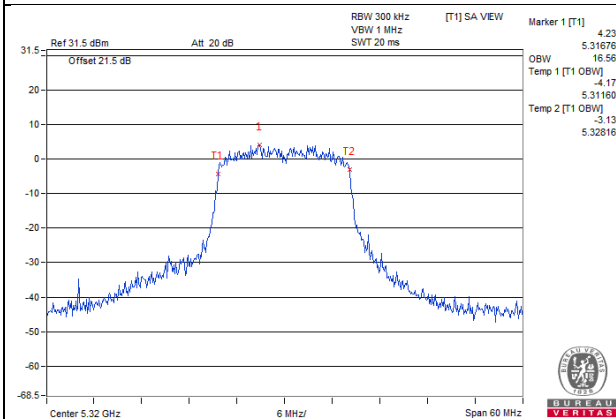

802.11ac (VHT20)_Chain 0 / CH140

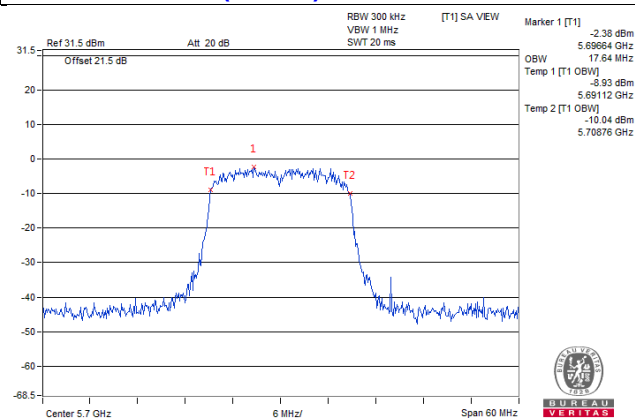

802.11ac (VHT40)_Chain 1 / CH38

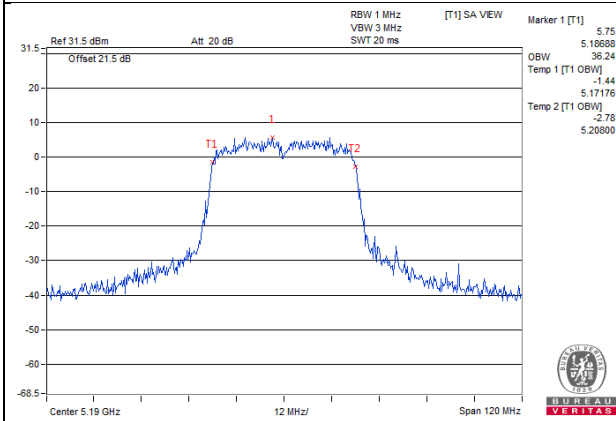

802.11ac (VHT80)_Chain 0 / CH42

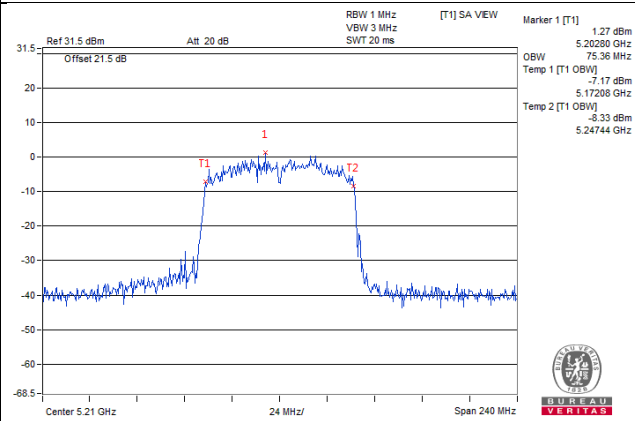

Spectrum Plot for near by DFS band
(DFS is required, if 99% OCP straddle into U-NII-2A band)

802.11a_Chain 0 / CH48

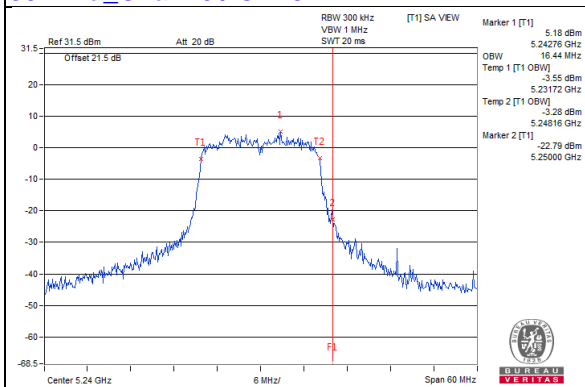

802.11a_Chain 1 / CH48

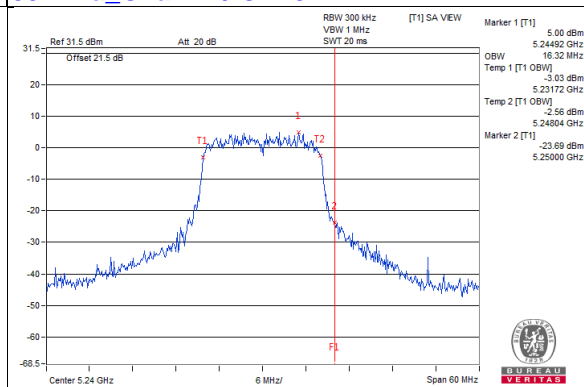

802.11ac (VHT20)_Chain 0 / CH48

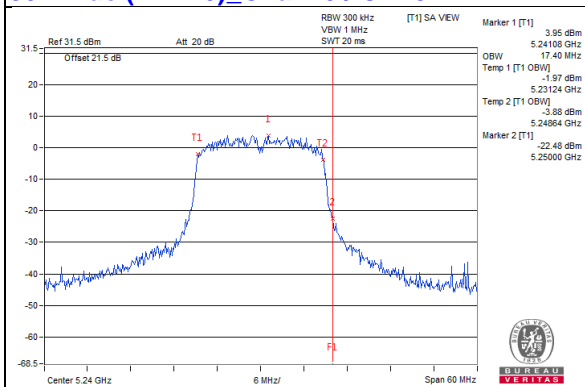

802.11ac (VHT20)_Chain 1 / CH48

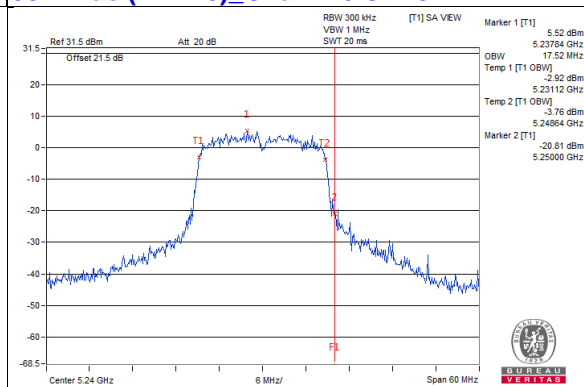

802.11ac (VHT40)_Chain 0 / CH46

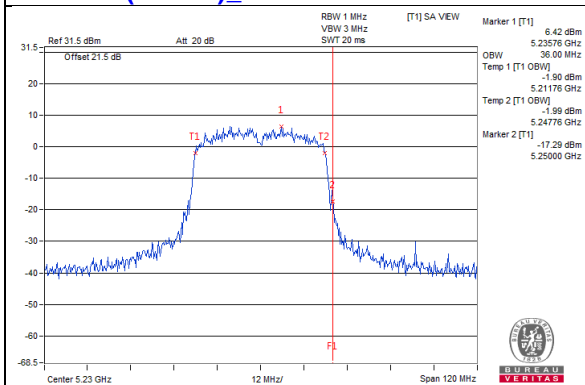

802.11ac (VHT40)_Chain 1 / CH46

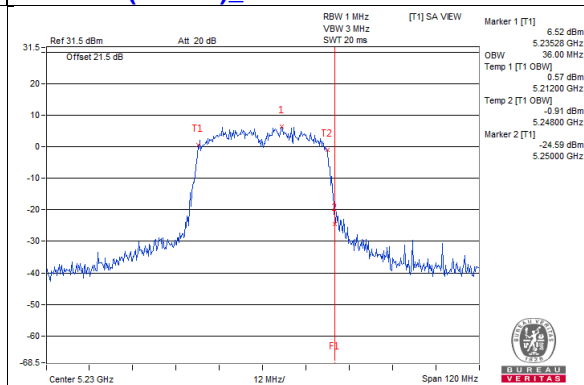

802.11ac (VHT80)_Chain 0 / CH42

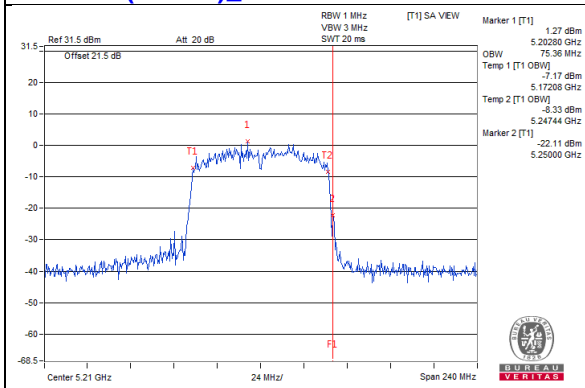

802.11ac (VHT80)_Chain 1 / CH42

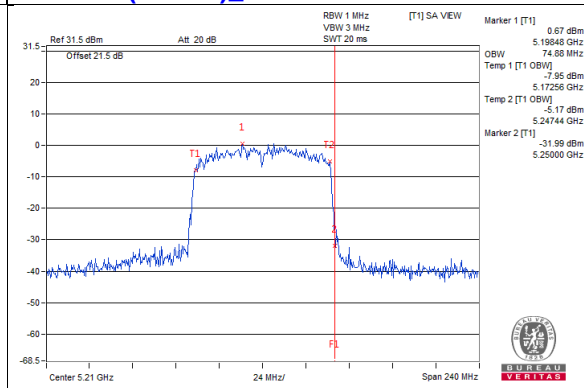

Spectrum Plot for near by DFS band
 (DFS is required, if 99% OCP straddle into U-NII-2C band)

802.11a_Chain 0 / CH149

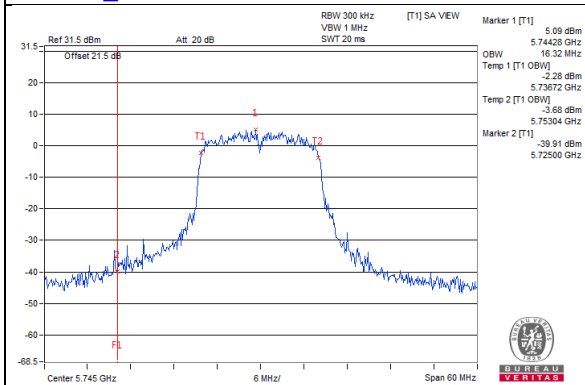

802.11a_Chain 1 / CH149

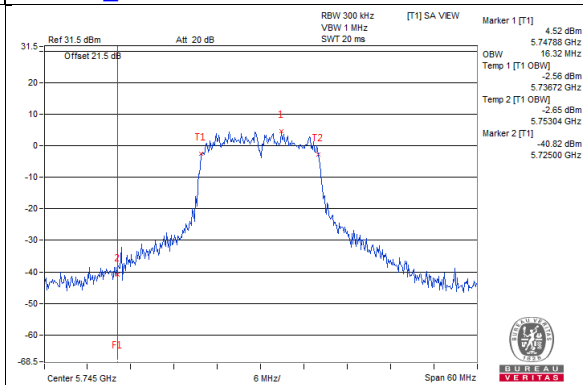

802.11ac (VHT20)_Chain 0 / CH149

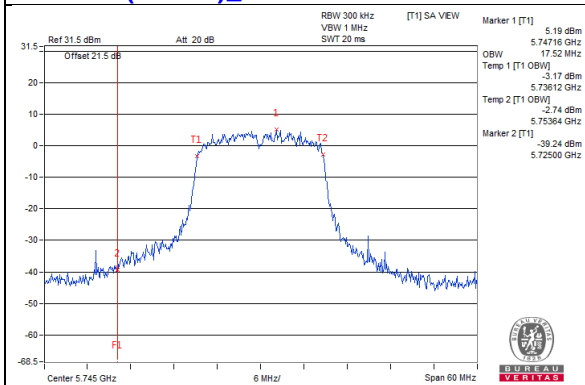

802.11ac (VHT20)_Chain 1 / CH149

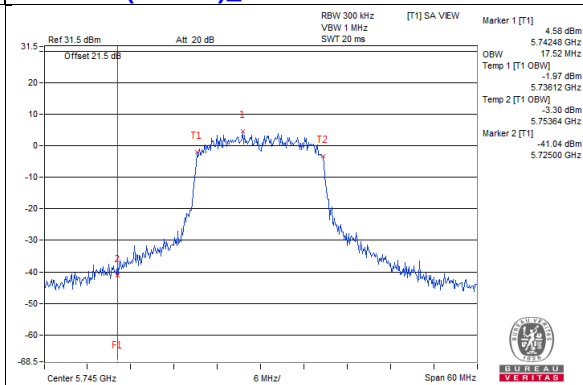

802.11ac (VHT40)_Chain 0 / CH151

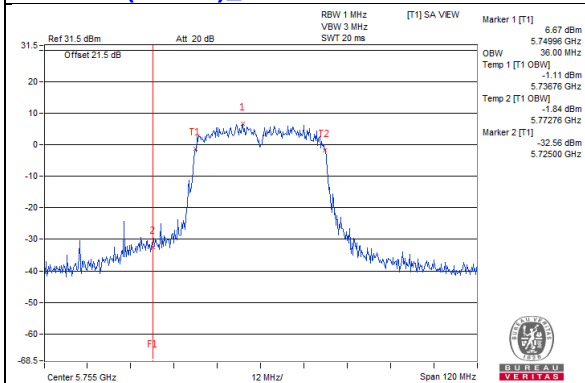

802.11ac (VHT40)_Chain 1 / CH151

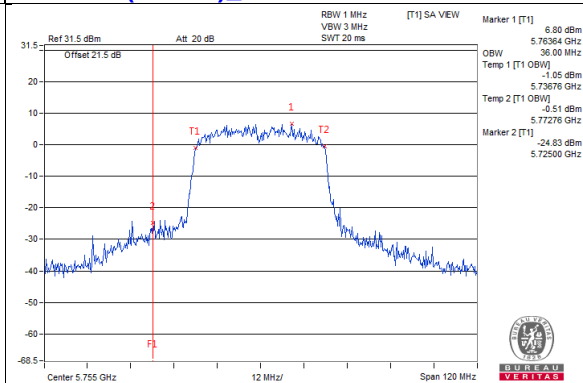

802.11ac (VHT80)_Chain 0 / CH155

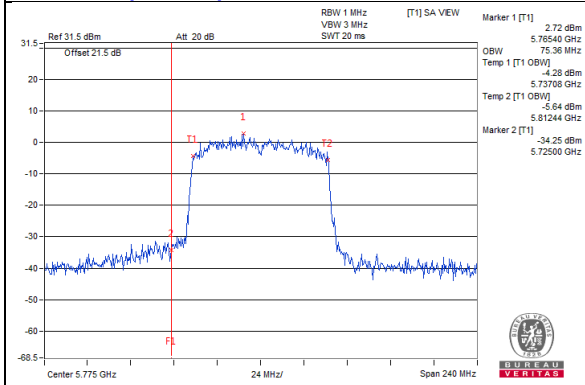

802.11ac (VHT80)_Chain 1 / CH155

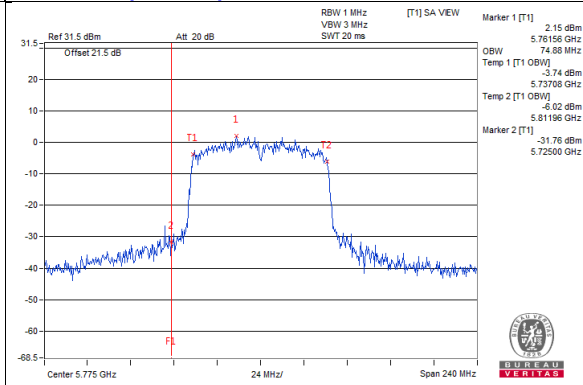

4.5 Peak Power Spectral Density Measurement

4.5.1 Limits of Peak Power Spectral Density Measurement

Operation Band	EUT Category		Limit
U-NII-1		Outdoor Access Point	17dBm/ MHz
		Fixed point-to-point Access Point	
		Indoor Access Point	
	√	Client device	11dBm/ MHz
U-NII-2A		√	11dBm/ MHz
U-NII-2C		√	11dBm/ MHz
U-NII-3		√	30dBm/ 500kHz

4.5.2 Test Setup

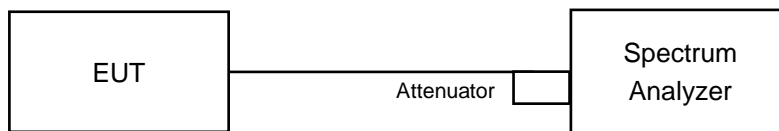

4.5.3 Test Instruments

Refer to section 4.1.2 to get information of above instrument.

4.5.4 Test Procedure

For U-NII-1, U-NII-2A, U-NII-2C band:

Using method SA-2

1. Set span to encompass the entire emission bandwidth (EBW) of the signal.
2. Set RBW = 1 MHz, Set VBW ≥ 3 MHz, Detector = RMS
3. Sweep time = auto, trigger set to "free run".
4. Trace average at least 100 traces in power averaging mode.
5. Record the max value and add 10 log (1/duty cycle)

For U-NII-3 band:

1. Set span to encompass the entire emission bandwidth (EBW) of the signal.
2. Set RBW = 300 kHz, Set VBW ≥ 1 MHz, Detector = RMS
3. Use the peak marker function to determine the maximum power level in any 300 kHz band segment within the fundamental EBW.
4. Scale the observed power level to an equivalent value in 500 kHz by adjusting (reducing) the measured power by a bandwidth correction factor (BWCF) where $BWCF = 10\log(500\text{ kHz}/300\text{ kHz})$
5. Sweep time = auto, trigger set to "free run".
6. Trace average at least 100 traces in power averaging mode.
7. Record the max value and add 10 log (1/duty cycle)

4.5.5 Deviation from Test Standard

No deviation.

4.5.6 EUT Operating Condition

Same as Item 4.3.6.

4.5.7 Test Results

For U-NII-1, U-NII-2A, U-NII-2C:

802.11a

Chan.	Chan. Freq. (MHz)	PSD W/O Duty Factor (dBm/MHz)		Duty Factor (dB)	Total PSD With Duty Factor (dBm/MHz)	MAX. Limit (dBm/MHz)	Pass / Fail
		Chain 0	Chain 1				
36	5180	-0.91	0.14	0.22	2.88	8.99	Pass
40	5200	-0.01	0.03	0.22	3.24	8.99	Pass
48	5240	0.22	0.49	0.22	3.59	8.99	Pass
52	5260	0.05	0.11	0.22	3.31	8.99	Pass
60	5300	-0.98	-0.03	0.22	2.75	8.99	Pass
64	5320	0.26	0.15	0.22	3.44	8.99	Pass
100	5500	-3.44	-4.18	0.22	-0.56	8.99	Pass
116	5580	0.07	-0.09	0.22	3.22	8.99	Pass
140	5700	-6.03	-7.52	0.22	-3.48	8.99	Pass
144 (U-NII-2C Band)	5720	-0.08	-0.07	0.22	3.16	8.99	Pass

- Note: 1. Method a) of power density measurement of KDB 662911 is using for calculating total power density. Total power density is summing entire spectra across corresponding frequency bins on the various outputs by computer.
2. The directional gain = $5\text{dBi} + 10\log(2) = 8.01\text{dBi} > 6\text{dBi}$, so the power density limit shall be reduced to $11 - (8.01 - 6) = 8.99\text{dBm}$.
3. Refer to section 3.3 for duty cycle spectrum plot.

802.11ac (VHT20)

Chan.	Chan. Freq. (MHz)	PSD W/O Duty Factor (dBm/MHz)		Duty Factor (dB)	Total PSD With Duty Factor (dBm/MHz)	MAX. Limit (dBm/MHz)	Pass / Fail
		Chain 0	Chain 1				
36	5180	-0.38	-0.45	0.25	2.85	8.99	Pass
40	5200	0.21	-0.04	0.25	3.35	8.99	Pass
48	5240	0.00	-0.44	0.25	3.05	8.99	Pass
52	5260	0.01	-0.24	0.25	3.15	8.99	Pass
60	5300	-0.97	-0.72	0.25	2.42	8.99	Pass
64	5320	-1.28	-0.51	0.25	2.38	8.99	Pass
100	5500	-4.02	-4.81	0.25	-1.14	8.99	Pass
116	5580	0.35	0.07	0.25	3.47	8.99	Pass
140	5700	-6.76	-10.06	0.25	-4.84	8.99	Pass
144 (U-NII-2C Band)	5720	-0.61	-0.83	0.25	2.54	8.99	Pass

- Note: 1. Method a) of power density measurement of KDB 662911 is using for calculating total power density. Total power density is summing entire spectra across corresponding frequency bins on the various outputs by computer.
2. The directional gain = $5\text{dBi} + 10\log(2) = 8.01\text{dBi} > 6\text{dBi}$, so the power density limit shall be reduced to $11 - (8.01 - 6) = 8.99\text{dBm}$.
3. Refer to section 3.3 for duty cycle spectrum plot.

802.11ac (VHT40)

Chan.	Chan. Freq. (MHz)	PSD W/O Duty Factor (dBm/MHz)		Duty Factor (dB)	Total PSD With Duty Factor (dBm/MHz)	MAX. Limit (dBm/MHz)	Pass / Fail
		Chain 0	Chain 1				
38	5190	-4.06	-7.81	0.48	-2.05	8.99	Pass
46	5230	-4.40	-4.68	0.48	-1.05	8.99	Pass
54	5270	-5.42	-4.67	0.48	-1.54	8.99	Pass
62	5310	-3.95	-5.01	0.48	-0.96	8.99	Pass
102	5510	-8.21	-11.61	0.48	-6.10	8.99	Pass
110	5550	-5.01	-6.38	0.48	-2.15	8.99	Pass
134	5670	-5.58	-5.73	0.48	-2.16	8.99	Pass
142 (U-NII-2C Band)	5710	-4.39	-4.54	0.48	-0.97	8.99	Pass

- Note: 1. Method a) of power density measurement of KDB 662911 is using for calculating total power density. Total power density is summing entire spectra across corresponding frequency bins on the various outputs by computer.
2. The directional gain = $5\text{dBi} + 10\log(2) = 8.01\text{dBi} > 6\text{dBi}$, so the power density limit shall be reduced to $11 - (8.01 - 6) = 8.99\text{dBm}$.
3. Refer to section 3.3 for duty cycle spectrum plot.

802.11ac (VHT80)

Chan.	Chan. Freq. (MHz)	PSD W/O Duty Factor (dBm/MHz)		Duty Factor (dB)	Total PSD With Duty Factor (dBm/MHz)	MAX. Limit (dBm/MHz)	Pass / Fail
		Chain 0	Chain 1				
42	5210	-12.84	-11.29	0.87	-8.12	8.99	Pass
58	5290	-11.00	-10.63	0.87	-6.93	8.99	Pass
106	5530	-12.40	-13.80	0.87	-9.16	8.99	Pass
122	5610	-9.84	-9.87	0.87	-5.97	8.99	Pass
138 (U-NII-2C Band)	5690	-11.99	-8.98	0.87	-6.35	8.99	Pass

- Note: 1. Method a) of power density measurement of KDB 662911 is using for calculating total power density. Total power density is summing entire spectra across corresponding frequency bins on the various outputs by computer.
2. The directional gain = $5\text{dBi} + 10\log(2) = 8.01\text{dBi} > 6\text{dBi}$, so the power density limit shall be reduced to $11 - (8.01 - 6) = 8.99\text{dBm}$.
3. Refer to section 3.3 for duty cycle spectrum plot.

Spectrum Plot of Worst Value

802.11a_Chain 1 / CH48

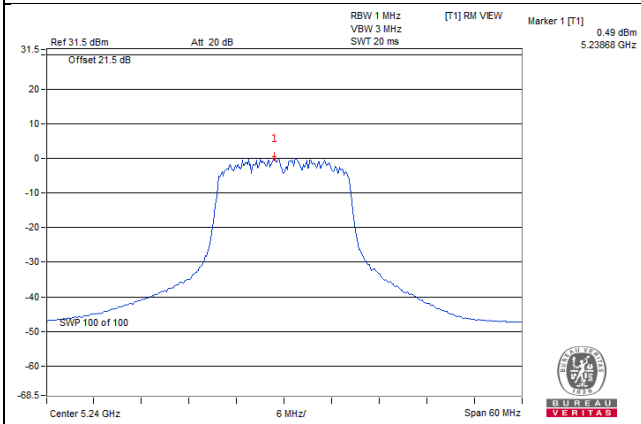

802.11ac (VHT20)_Chain 0 / CH116

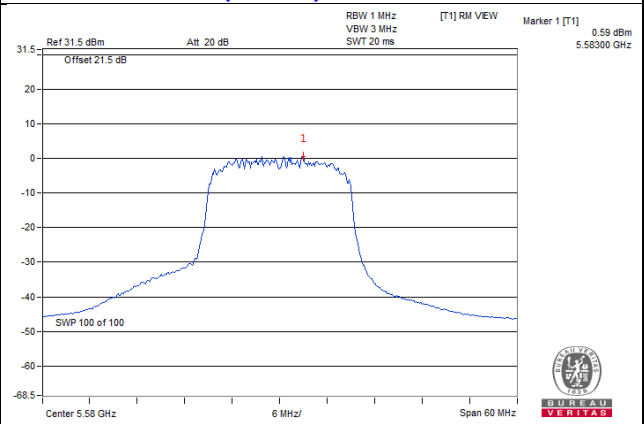

802.11ac (VHT40)_Chain 0 / CH62

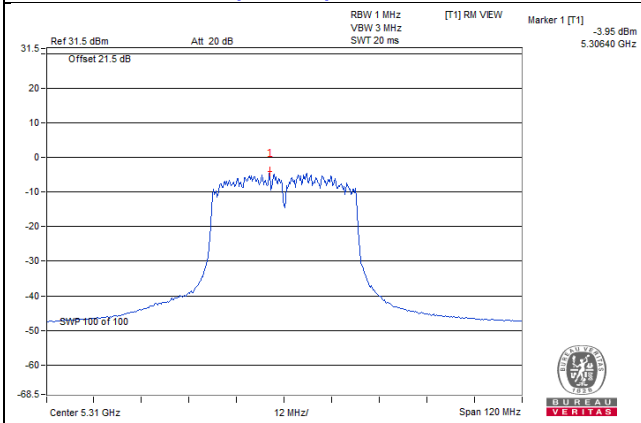

802.11ac (VHT80)_Chain 1 / CH138 (U-NII-2C)

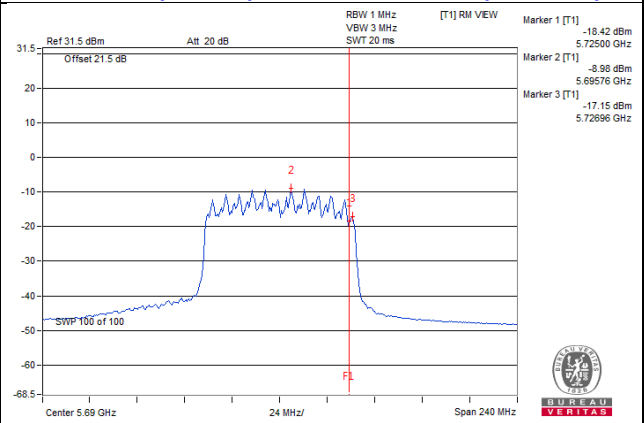

For U-NII-3:
802.11a

Chan.	Freq. (MHz)	PSD W/O Duty Factor (dBm/300kHz)		Duty Factor (dB)	Total PSD With Duty Factor		Total PSD With Duty Factor (dBm/500kHz)	Limit (dBm/500kHz)	Pass /Fail
		Chain 0	Chain 1		mW/300kHz	dBm/300kHz			
144 (U-NII-3 Band)	5720	-9.63	-10.37	0.22	0.21132	-6.75	-4.53	27.99	Pass
149	5745	-8.09	-8.36	0.22	0.317	-4.99	-2.77	27.99	Pass
157	5785	-7.85	-8.08	0.22	0.3365	-4.73	-2.51	27.99	Pass
165	5825	-7.32	-8.76	0.22	0.3352	-4.75	-2.53	27.99	Pass

- Note: 1. Method b) Measure and sum spectral maxima across the outputs of KDB 662911 is using for calculating total power density.
2. The directional gain = $5\text{dBi} + 10\log(2) = 8.01\text{dBi} > 6\text{dBi}$, so the power density limit shall be reduced to $30 - (8.01 - 6) = 27.99\text{dBm}$.
3. Refer to section 3.3 for duty cycle spectrum plot.

802.11ac (VHT20)

Chan.	Freq. (MHz)	PSD W/O Duty Factor (dBm/300kHz)		Duty Factor (dB)	Total PSD With Duty Factor		Total PSD With Duty Factor (dBm/500kHz)	Limit (dBm/500kHz)	Pass /Fail
		Chain 0	Chain 1		mW/300kHz	dBm/300kHz			
144 (U-NII-3 Band)	5720	-9.77	-10.49	0.25	0.20616	-6.86	-4.64	27.99	Pass
149	5745	-7.55	-8.62	0.25	0.3315	-4.80	-2.58	27.99	Pass
157	5785	-8.04	-8.43	0.25	0.3182	-4.97	-2.75	27.99	Pass
165	5825	-7.38	-9.35	0.25	0.3164	-5.00	-2.78	27.99	Pass

- Note: 1. Method b) Measure and sum spectral maxima across the outputs of KDB 662911 is using for calculating total power density.
2. The directional gain = $5\text{dBi} + 10\log(2) = 8.01\text{dBi} > 6\text{dBi}$, so the power density limit shall be reduced to $30 - (8.01 - 6) = 27.99\text{dBm}$.
3. Refer to section 3.3 for duty cycle spectrum plot.

802.11ac (VHT40)

Chan.	Freq. (MHz)	PSD W/O Duty Factor (dBm/300kHz)		Duty Factor (dB)	Total PSD With Duty Factor		Total PSD With Duty Factor (dBm/500kHz)	Limit (dBm/500kHz)	Pass /Fail
		Chain 0	Chain 1		mW/300kHz	dBm/300kHz			
142 (U-NII-3 Band)	5710	-15.71	-16.17	0.48	0.05695	-12.45	-10.23	27.99	Pass
151	5755	-12.67	-13.11	0.48	0.11494	-9.40	-7.18	27.99	Pass
159	5795	-13.14	-13.78	0.48	0.10095	-9.96	-7.74	27.99	Pass

- Note: 1. Method b) Measure and sum spectral maxima across the outputs of KDB 662911 is using for calculating total power density.
2. The directional gain = $5\text{dBi} + 10\log(2) = 8.01\text{dBi} > 6\text{dBi}$, so the power density limit shall be reduced to $30 - (8.01 - 6) = 27.99\text{dBm}$.
3. Refer to section 3.3 for duty cycle spectrum plot.

802.11ac (VHT80)

Chan.	Freq. (MHz)	PSD W/O Duty Factor (dBm/300kHz)		Duty Factor (dB)	Total PSD With Duty Factor		Total PSD With Duty Factor (dBm/500kHz)	Limit (dBm/500kHz)	Pass /Fail
		Chain 0	Chain 1		mW/300kHz	dBm/300kHz			
138 (U-NII-3 Band)	5690	-21.04	-22.92	0.87	0.015843	-18.00	-15.78	27.99	Pass
155	5775	-17.14	-17.31	0.87	0.04627	-13.35	-11.13	27.99	Pass

- Note: 1. Method b) Measure and sum spectral maxima across the outputs of KDB 662911 is using for calculating total power density.
2. The directional gain = $5\text{dBi} + 10\log(2) = 8.01\text{dBi} > 6\text{dBi}$, so the power density limit shall be reduced to $30 - (8.01 - 6) = 27.99\text{dBm}$.
3. Refer to section 3.3 for duty cycle spectrum plot.

Spectrum Plot of Worst Value

802.11a_Chain 0 / CH165

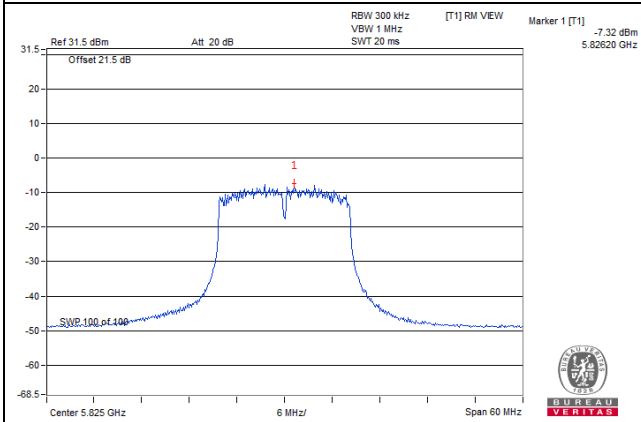

802.11ac (VHT20)_Chain 0 / CH165

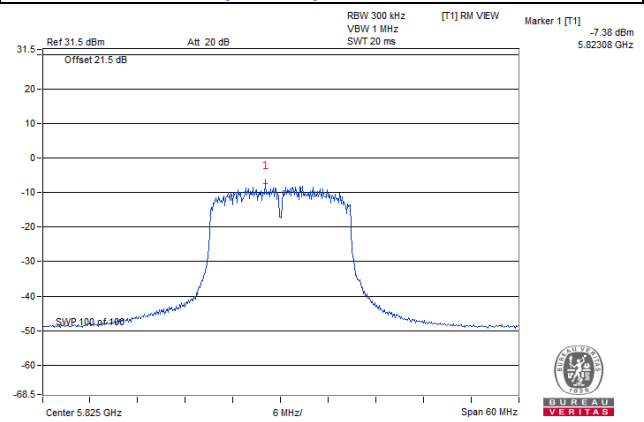

802.11ac (VHT40)_Chain 0 / CH151

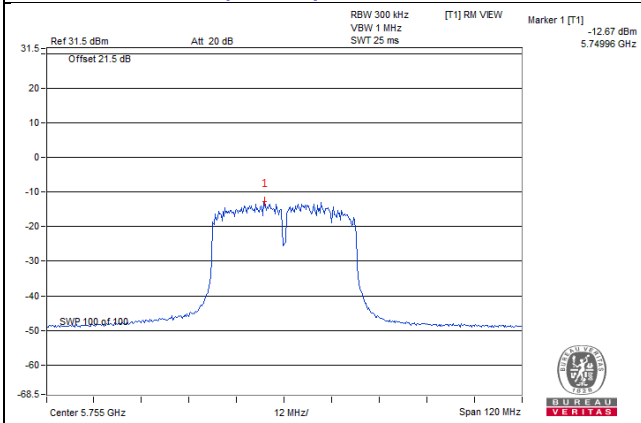

802.11ac (VHT80)_Chain 0 / CH155

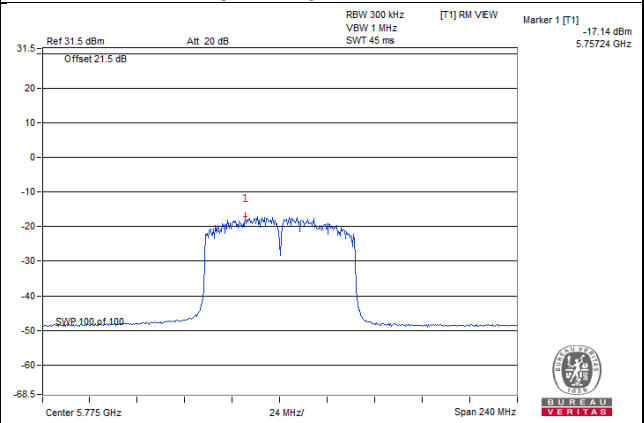

4.6 Frequency Stability Measurement

4.6.1 Limits of Frequency Stability Measurement

The frequency of the carrier signal shall be maintained within band of operation

4.6.2 Test Setup

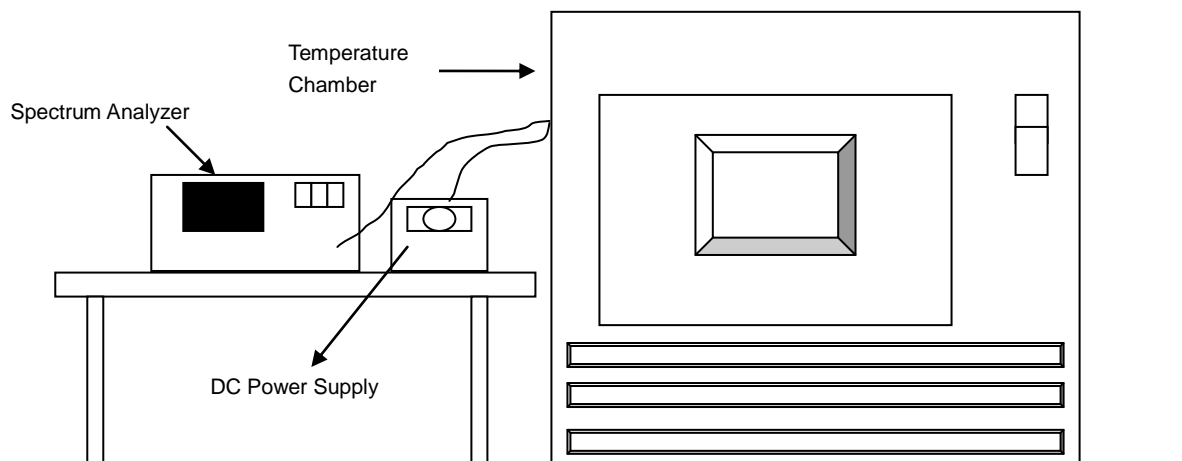

4.6.3 Test Instruments

Refer to section 4.1.2 to get information of above instrument.

4.6.4 Test Procedure

- The EUT was placed inside the environmental test chamber and powered by nominal DC voltage.
- Turn the EUT on and couple its output to a spectrum analyzer.
- Turn the EUT off and set the chamber to the highest temperature specified.
- Allow sufficient time (approximately 30 min) for the temperature of the chamber to stabilize, turn the EUT on and measure the operating frequency after 2, 5, and 10 Minutes.
- Repeat step (d) with the temperature chamber set to the next desired temperature until measurements down to the lowest specified temperature have been completed.
- The test chamber was allowed to stabilize at +20 degree C for a minimum of 30 Minutes. The supply voltage was then adjusted on the EUT from 85% to 115% and the frequency record.

4.6.5 Deviation from Test Standard

No deviation.

4.6.6 EUT Operating Condition

Set the EUT transmit at un-modulation mode to test frequency stability.

4.6.7 Test Results

Frequency Stability Versus Temp.									
Operating Frequency: 5180 MHz									
TEMP. (°C)	Power Supply (Vdc)	0 Minute		2 Minutes		5 Minutes		10 Minutes	
		Measured Frequency (MHz)	Pass/Fail	Measured Frequency (MHz)	Pass/Fail	Measured Frequency (MHz)	Pass/Fail	Measured Frequency (MHz)	Pass/Fail
85	3.3	5180.0115	PASS	5180.0103	PASS	5180.0116	PASS	5180.0099	PASS
80	3.3	5180.0024	PASS	5180.0017	PASS	5180.0023	PASS	5180.0017	PASS
70	3.3	5180.0096	PASS	5180.0073	PASS	5180.0067	PASS	5180.0088	PASS
60	3.3	5179.9908	PASS	5179.9908	PASS	5179.9901	PASS	5179.9941	PASS
50	3.3	5180.0127	PASS	5180.0125	PASS	5180.0136	PASS	5180.0148	PASS
40	3.3	5179.9802	PASS	5179.9819	PASS	5179.9811	PASS	5179.9778	PASS
30	3.3	5180.025	PASS	5180.0246	PASS	5180.0258	PASS	5180.0258	PASS
20	3.3	5180.0069	PASS	5180.0078	PASS	5180.0052	PASS	5180.0068	PASS
10	3.3	5179.9901	PASS	5179.9917	PASS	5179.9905	PASS	5179.9895	PASS
0	3.3	5180.0078	PASS	5180.008	PASS	5180.0101	PASS	5180.0081	PASS
-10	3.3	5180.0206	PASS	5180.0212	PASS	5180.0215	PASS	5180.0182	PASS
-20	3.3	5179.9961	PASS	5179.997	PASS	5179.9952	PASS	5179.9972	PASS
-30	3.3	5179.9975	PASS	5180.0003	PASS	5179.9973	PASS	5179.9961	PASS
-40	3.3	5179.9778	PASS	5179.978	PASS	5179.9754	PASS	5179.9759	PASS

Frequency Stability Versus Voltage									
Operating Frequency: 5180 MHz									
TEMP. (°C)	Power Supply (Vdc)	0 Minute		2 Minutes		5 Minutes		10 Minutes	
		Measured Frequency (MHz)	Pass/Fail	Measured Frequency (MHz)	Pass/Fail	Measured Frequency (MHz)	Pass/Fail	Measured Frequency (MHz)	Pass/Fail
20	3.795	5180.0072	PASS	5180.0077	PASS	5180.0051	PASS	5180.0068	PASS
	3.3	5180.0069	PASS	5180.0078	PASS	5180.0052	PASS	5180.0068	PASS
	2.805	5180.007	PASS	5180.0071	PASS	5180.0049	PASS	5180.007	PASS

4.7 6dB Bandwidth Measurement

4.7.1 Limits of 6dB Bandwidth Measurement

The minimum of 6dB Bandwidth Measurement is 0.5MHz.

4.7.2 Test Setup

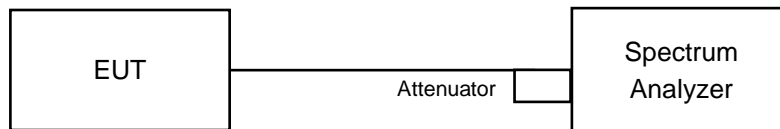

4.7.3 Test Instruments

Refer to section 4.1.2 to get information of above instrument.

4.7.4 Test Procedure

MEASUREMENT PROCEDURE REF

- Set resolution bandwidth (RBW) = 100kHz
- Set the video bandwidth (VBW) $\geq 3 \times$ RBW, Detector = Peak.
- Trace mode = max hold.
- Sweep = auto couple.
- Measure the maximum width of the emission that is constrained by the frequencies associated with the two amplitude points (upper and lower) that are attenuated by 6 dB relative to the maximum level measured in the fundamental emission.

4.7.5 Deviation from Test Standard

No deviation.

4.7.6 EUT Operating Condition

The software provided by client to enable the EUT under transmission condition continuously at lowest, middle and highest channel frequencies individually.

4.7.7 Test Results

802.11a

Channel	Frequency (MHz)	6dB Bandwidth (MHz)		Minimum Limit (MHz)	Pass / Fail
		Chain 0	Chain 1		
144 (U-NII-3 Band)	5720	2.54	2.50	0.5	Pass
149	5745	15.16	15.17	0.5	Pass
157	5785	15.16	15.09	0.5	Pass
165	5825	15.22	15.20	0.5	Pass

802.11ac (VHT20)

Channel	Frequency (MHz)	6dB Bandwidth (MHz)		Minimum Limit (MHz)	Pass / Fail
		Chain 0	Chain 1		
144 (U-NII-3 Band)	5720	2.53	2.54	0.5	Pass
149	5745	15.19	15.19	0.5	Pass
157	5785	15.20	15.16	0.5	Pass
165	5825	15.20	15.16	0.5	Pass

802.11ac (VHT40)

Channel	Frequency (MHz)	6dB Bandwidth (MHz)		Minimum Limit (MHz)	Pass / Fail
		Chain 0	Chain 1		
142 (U-NII-3 Band)	5710	2.54	2.53	0.5	Pass
151	5755	35.20	35.16	0.5	Pass
159	5795	35.18	35.18	0.5	Pass

802.11ac (VHT80)

Channel	Frequency (MHz)	6dB Bandwidth (MHz)		Minimum Limit (MHz)	Pass / Fail
		Chain 0	Chain 1		
138 (U-NII-3 Band)	5690	2.61	1.42	0.5	Pass
155	5775	75.25	72.71	0.5	Pass

Spectrum Plot of Worst Value

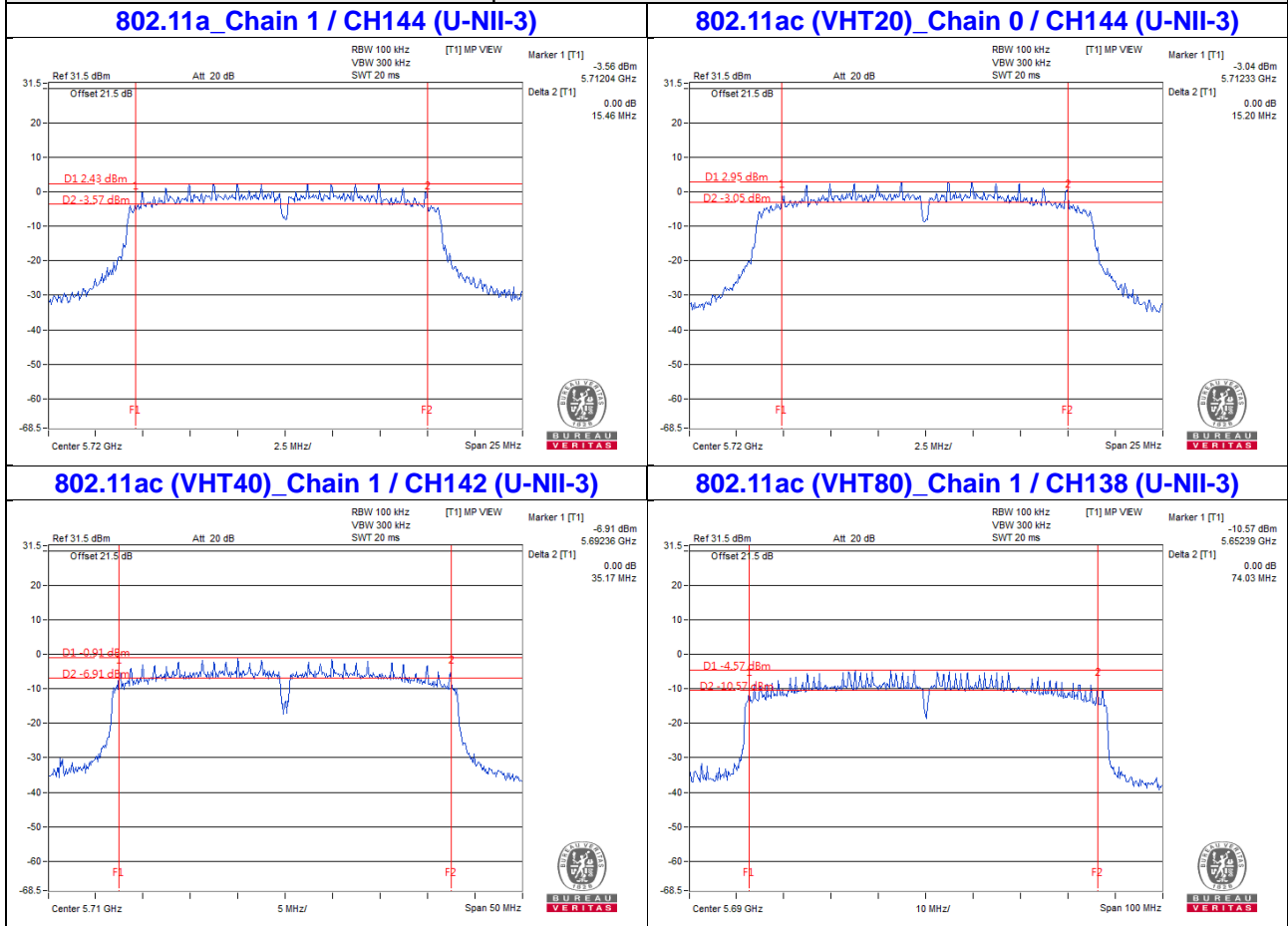

Note: The 6dB bandwidth above 5725MHz = Marker 1 + Delta 2 - 5725MHz

5 Pictures of Test Arrangements

Please refer to the attached file (Test Setup Photo).

Annex A- Radiated Out of Band Emission (OOBE) Measurement (For U-NII-3 band)

802.11a

CH 149 5745 MHz

Horizontal

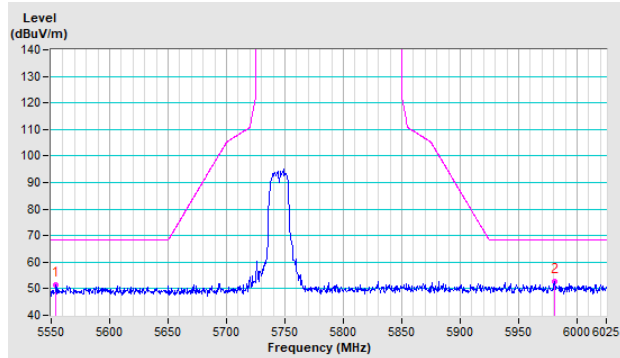

Vertical

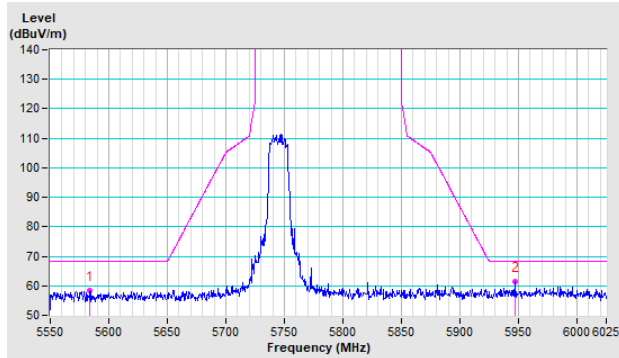

CH 157 5785 MHz

Horizontal

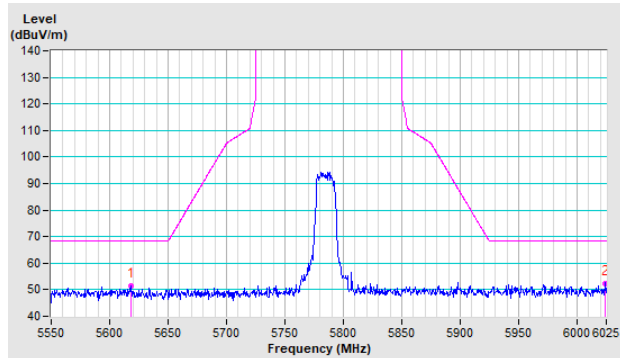

Vertical

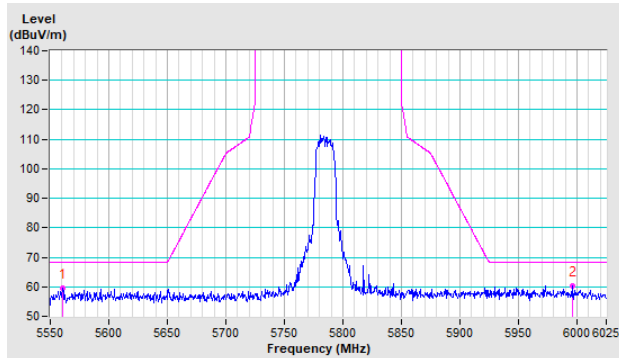

CH 165 5825 MHz

Horizontal

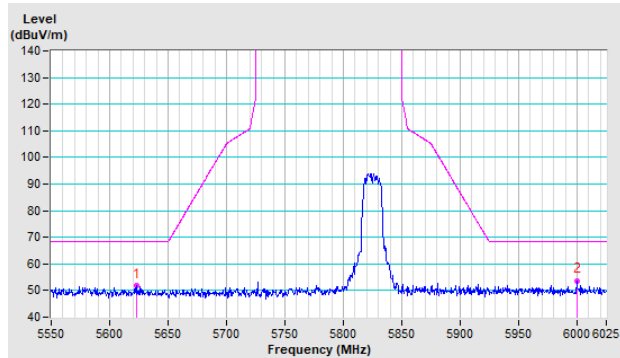

Vertical

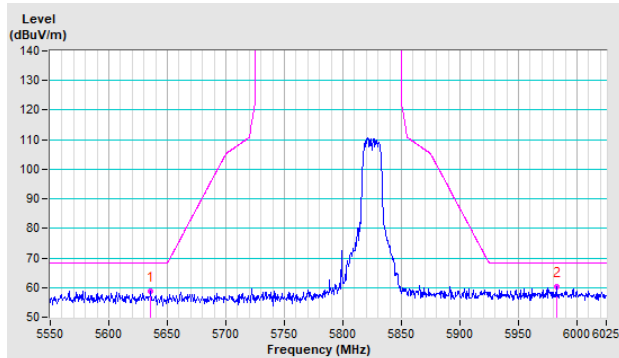

802.11ac (VHT20)

CH 149 5745 MHz

Horizontal

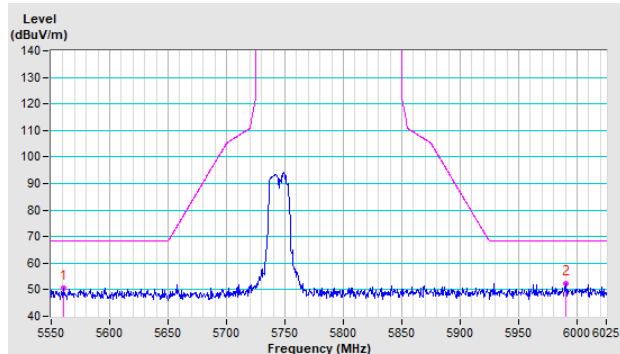

Vertical

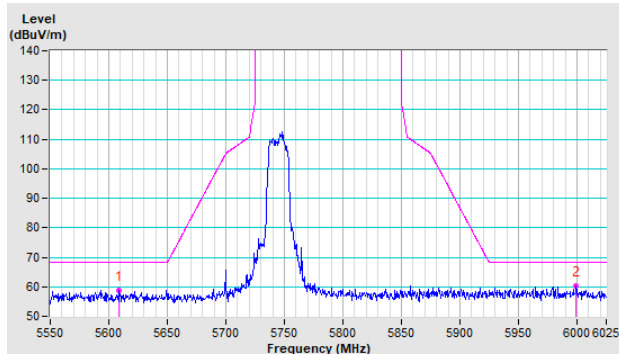

CH 157 5785 MHz

Horizontal

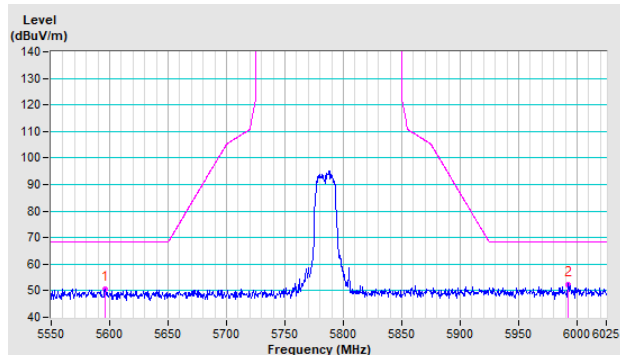

Vertical

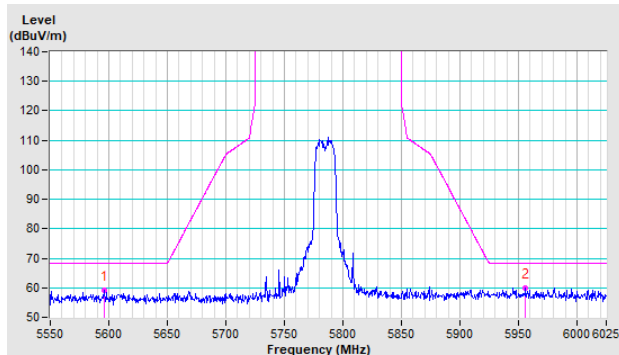

CH 165 5825 MHz

Horizontal

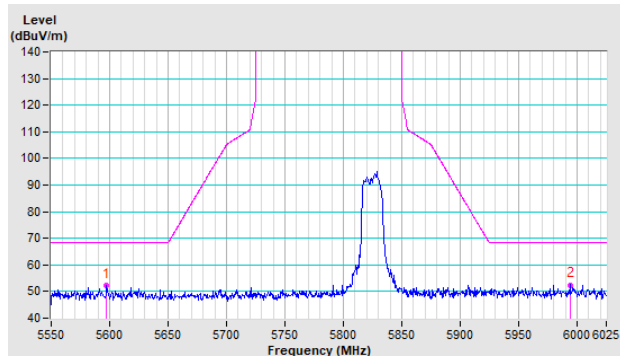

Vertical

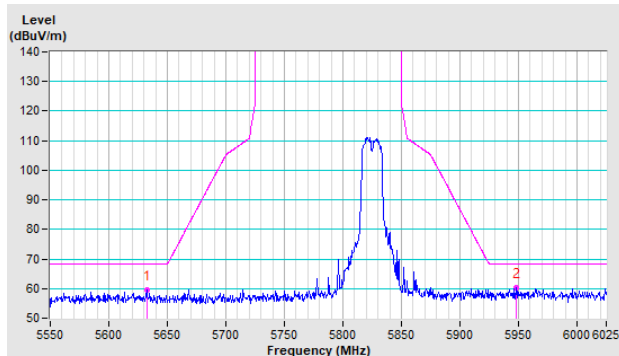

802.11ac (VHT40)

CH 151 5755 MHz

Horizontal

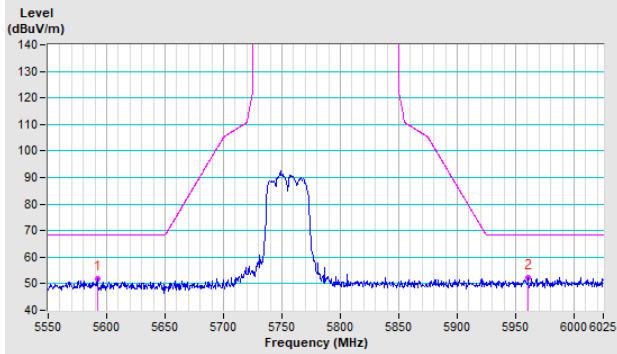

Vertical

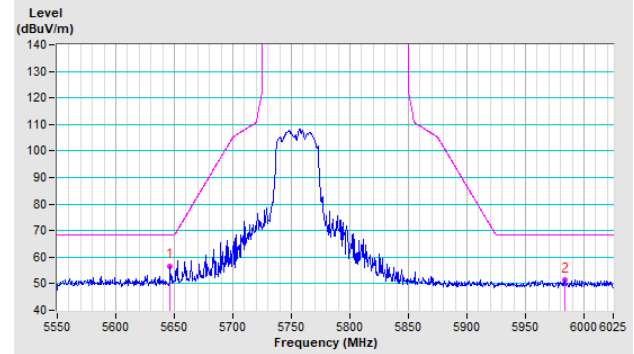

CH 159 5795 MHz

Horizontal

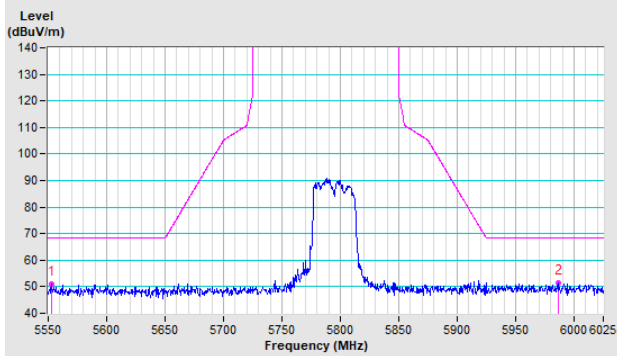

Vertical

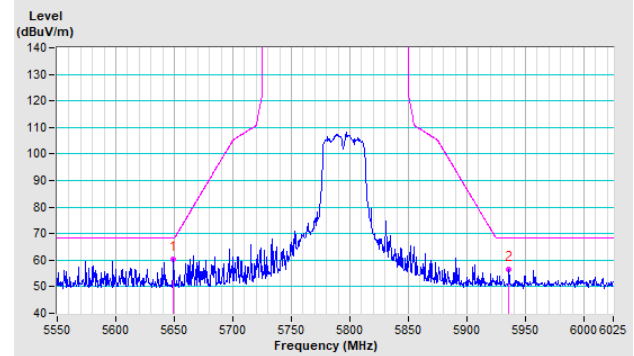

802.11ac (VHT80)

CH 155 5775 MHz

Horizontal

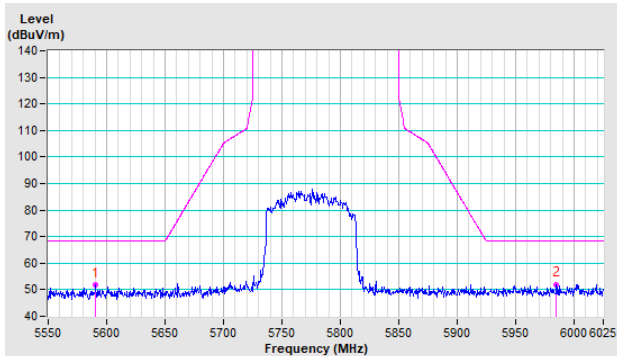

Vertical

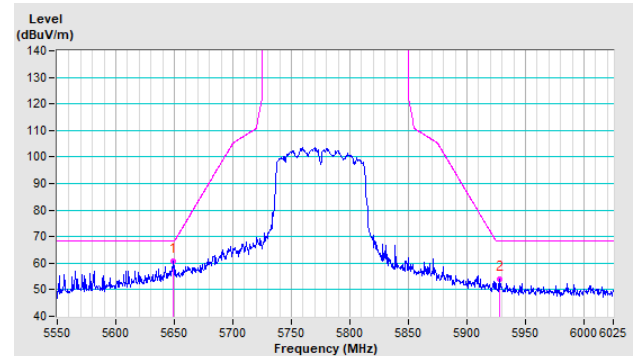

Appendix – Information of the Testing Laboratories

We, Bureau Veritas Consumer Products Services (H.K.) Ltd., Taoyuan Branch, were founded in 1988 to provide our best service in EMC, Radio, Telecom and Safety consultation. Our laboratories are FCC recognized accredited test firms and accredited according to ISO/IEC 17025.

If you have any comments, please feel free to contact us at the following:

Lin Kou EMC/RF Lab

Tel: 886-2-26052180

Fax: 886-2-26051924

Hsin Chu EMC/RF/Telecom Lab

Tel: 886-3-6668565

Fax: 886-3-6668323

Hwa Ya EMC/RF/Safety Lab

Tel: 886-3-3183232

Fax: 886-3-3270892

Email: service.adt@tw.bureauveritas.com

Web Site: www.bureauveritas-adt.com

The address and road map of all our labs can be found in our web site also.

--- END ---