



Test report No. : 4789558396-US-R1-V0
Page : 1 of 393
Issued date : Mar. 16, 2021
FCC ID : RYK-WNFB266AXIBT

RADIO TEST REPORT

Product : IEEE 802.11ax/ac/a/b/g/n 2x2 WiFi with Bluetooth5.0 Combo Module

Model Name : WNFB-266AXI(BT)

Series Model : AP12275_M2

FCC ID : RYK-WNFB266AXIBT

Test Regulation : FCC 47 CFR Part 15 Subpart E (Section 15.407)

Received Date : Jul. 22, 2020

Test Date : Feb. 1, 2021 ~ Feb. 24, 2021

Issued Date : Mar. 16, 2021

Applicant : SparkLAN Communications, Inc.
8F., No.257, Sec. 2, Tiding Blvd., Neihu District, Taipei City 11493,
Taiwan (R.O.C.)

Issued By : Underwriters Laboratories Taiwan Co., Ltd.
Building B and Building E, No. 372-7, Sec. 4, Zhongxing Rd.,
Zhudong Township, Hsinchu County, Taiwan



The results reported herein have been performed in accordance with the laboratory's terms of accreditation. This report shall not be reproduced except in full without the written approval of the Laboratory. The results in this report are responsible of the test sample(s) provided by the client only and are not to be used to indicate applicability to other similar products.

Underwriters Laboratories Taiwan Co., Ltd.

Building B and Building E, No. 372-7, Sec. 4, Zhongxing Rd., Zhudong Township, Hsinchu County, Taiwan
Telephone :+886-2-7737-3000
Facsimile (FAX) :+886-3-583-7948

Doc No: 17-EM-F0878 / 5.0



Test report No. : 4789558396-US-R1-V0
Page : 2 of 393
Issued date : Mar. 16, 2021
FCC ID : RYK-WNFB266AXIBT

REVISION HISTORY

Original Test Report No.: 4789558396-US-R1-V0

Rev.	Test report No.	Date	Page revised	Contents
Original	4789558396-US-R1-V0	Mar. 16, 2021	-	Initial issue



Table of Contents

1. Attestation of Test Results	4
2. Summary of Test Results	5
3. Test Methodology and Reference Procedures.....	6
4. Facilities and Accreditation.....	6
5. Measurement Uncertainty	7
6. Equipment under Test	8
6.1. Description of EUT.....	8
6.2. Channel List.....	11
6.3. Test Condition.....	13
6.4. Description of Available Antennas.....	13
6.5. Test Mode Applicability and Tested Channel Detail.....	14
6.6. Duty cycle	17
7. Test Equipment.....	23
8. Description of Test Setup.....	25
9. Test Results.....	26
9.1. 6dB Bandwidth	26
9.2. 26dB Bandwidth	40
9.3. Occupied Bandwidth.....	58
9.4. Conducted Output Power	80
9.5. Power Spectral Density.....	96
9.6. Frequency Stability	128
9.7. Radiated Spurious Emission	130
9.8. AC Power Line Conducted Emission	269
Appendix I Radiated Band Edge and OOB Measurement.....	279
Appendix II Radiated Spurious Emission Measurement	345

Underwriters Laboratories Taiwan Co., Ltd.

Building B and Building E, No. 372-7, Sec. 4, Zhongxing Rd., Zhudong Township, Hsinchu County, Taiwan

Telephone :+886-2-7737-3000

Facsimile (FAX) :+886-3-583-7948

Doc No: 17-EM-F0878 / 5.0



Test report No. : 4789558396-US-R1-V0
Page : 4 of 393
Issued date : Mar. 16, 2021
FCC ID : RYK-WNFB266AXIBT

1. Attestation of Test Results

APPLICANT: SparkLAN Communications, Inc.
8F., No.257, Sec. 2, Tiding Blvd., Neihu District, Taipei City 11493,
Taiwan (R.O.C.)

MANUFACTURER SparkLAN Communications, Inc.
8F., No.257, Sec. 2, Tiding Blvd., Neihu District, Taipei City 11493,
Taiwan (R.O.C.)

EUT DESCRIPTION: IEEE 802.11ax/ac/a/b/g/n 2x2 WiFi with Bluetooth5.0 Combo Module

MODEL: WNFB-266AXI(BT)

SERIES MODEL: AP12275_M2

SAMPLE STAGE: Identical Prototype

DATE of TESTED: Feb. 1, 2021 ~ Feb. 24, 2021

APPLICABLE STANDARDS	
STANDARD	Test Results
FCC 47 CFR PART 15 Subpart E (Section 15.407)	PASS

Underwriters Laboratories Taiwan Co., Ltd. tested the above equipment in accordance with the requirements set forth in the above standards. All indications of Pass/Fail in this report are opinions expressed by Underwriters Laboratories Taiwan Co., Ltd. based on interpretations and/or observations of test results. The test results show that the equipment tested is capable of demonstrating compliance with the requirements as documented in this report.

Note: The results documented in this report apply only to the tested sample, under the conditions and modes of operation as described herein. This document may not be altered or revised in any way unless done so by Underwriters Laboratories Taiwan Co., Ltd. and all revisions are duly noted in the revisions section. Any alteration of this document not carried out by Underwriters Laboratories Taiwan Co., Ltd. will constitute fraud and shall nullify the document. This report must not be used by the client to claim product certification, approval, or endorsement by NVLAP, NIST, any agency of the Federal Government, or any agency of any government.

Prepared By:

Sally Lu
Project Handler

Date : Mar. 16, 2021

Approved and Authorized By:

Water Nil Guan
Engineer

Date : Mar. 16, 2021

Underwriters Laboratories Taiwan Co., Ltd.

Building B and Building E, No. 372-7, Sec. 4, Zhongxing Rd., Zhudong Township, Hsinchu County, Taiwan
Telephone : +886-2-7737-3000
Facsimile (FAX) : +886-3-583-7948

Doc No: 17-EM-F0878 / 5.0



2. Summary of Test Results

Summary of Test Results		
FCC Clause	Test Items	Result
15.407(e)	6dB Bandwidth	PASS
15.403(i)	26dB Bandwidth	PASS
2.1049	Occupied Bandwidth	See Note2
15.407(a)(1/2/3)	Conducted Output Power	PASS
15.407(a)(1/2/3)	Power Spectral Density	PASS
15.407(g)	Frequency Stability	PASS
15.407(b) (1/2/3/4(i/ii)/6)	Radiated Emissions and Band Edge Measurement	PASS
15.407(b)(6)	AC Power Conducted Emission	PASS
15.203	Antenna Requirement	PASS
15.407(h)	Dynamic Frequency Selection	See Note3

Note:

1. For the Radiated Band Edge and OOB test plots were recorded in Appendix I, the Radiated Emissions test plots were recorded in Appendix II.
2. The Occupied Bandwidth was reference only.
3. The “Dynamic Frequency Selection measurement” was recorded in Report No.: 4789558396-US-R2-V0.

Underwriters Laboratories Taiwan Co., Ltd.

Building B and Building E, No. 372-7, Sec. 4, Zhongxing Rd., Zhudong Township, Hsinchu County, Taiwan

Telephone :+886-2-7737-3000

Facsimile (FAX) :+886-3-583-7948

Doc No: 17-EM-F0878 / 5.0



3. Test Methodology and Reference Procedures

The tests documented in this report were performed in accordance with 47 CFR FCC Part 2, KDB 789033 D02 General UNII Test Procedure New Rules v02r01, KDB414788 D01 Radiated Test Site v01r01, ANSI C63.10-2013 and KDB 662911 D01 Multiple Transmitter Output v02r01.

4. Facilities and Accreditation

Test Location	Underwriters Laboratories Taiwan Co., Ltd.
Address	Building B and Building E, No. 372-7, Sec. 4, Zhongxing Rd., Zhudong Township, Hsinchu County, Taiwan
Accreditation Certificate	Underwriters Laboratories Taiwan Co., Ltd. is accredited by TAF, Laboratory Code 3398. The full scope of accreditation can be viewed at http://accreditation.taftw.org.tw/taf/public/basic/viewApplyItems.action?unitNo=3398

Underwriters Laboratories Taiwan Co., Ltd.

Building B and Building E, No. 372-7, Sec. 4, Zhongxing Rd., Zhudong Township, Hsinchu County, Taiwan

Telephone :+886-2-7737-3000

Facsimile (FAX) :+886-3-583-7948



5. Measurement Uncertainty

For statement of conformity, accuracy method (Section 8.2.4 and 8.2.5 of ISO Guide 98-4) was applied as decision rule for measurement in this test report.

The following uncertainties have been calculated to provide a confidence level of 95 % using a coverage factor $k=2$.

Test Item	Measurement Frequency Range	K	U(dB)
Conducted disturbance at mains terminals ports	0.15MHz ~ 30MHz	2	1.5
RF Conducted	9 kHz - 40GHz	2	1.0
Radiated disturbance below 30MHz	9 kHz - 30 MHz	2	1.9
Radiated disturbance below 1 GHz	30MHz ~ 1GHz	2	5.4
Radiated disturbance above 1GHz	1GHz ~ 40GHz	2	4.7

Underwriters Laboratories Taiwan Co., Ltd.

Building B and Building E, No. 372-7, Sec. 4, Zhongxing Rd., Zhudong Township, Hsinchu County, Taiwan

Telephone :+886-2-7737-3000

Facsimile (FAX) :+886-3-583-7948

Doc No: 17-EM-F0878 / 5.0



6. Equipment under Test

6.1. Description of EUT

Product	IEEE 802.11ax/ac/a/b/g/n 2x2 WiFi with Bluetooth5.0 Combo Module	
Model Name	WNFB-266AXI(BT)	
Series Model	AP12275_M2	
Operating Frequency	5180 ~ 5240 MHz, 5260 ~ 5320 MHz, 5500 ~ 5720 MHz, 5745 ~ 5825 MHz	
Modulation	1024QAM, 256QAM, 64QAM, 16QAM, QPSK, BPSK	
Transfer Rate	802.11a: up to 54 Mbps 802.11n: up to MCS15 802.11ac: up to MCS9 802.11ax: up to HE11	
Number of Channel	5180 ~ 5240 MHz	4 for 802.11a, 802.11n (HT20), 802.11ac (VHT20), 802.11ax (HE20)
		2 for 802.11n (HT40), 802.11ac (VHT40), 802.11ax (HE40)
		1 for 802.11ac (VHT80), 802.11ax (HE80)
	5260 ~ 5320 MHz	4 for 802.11a, 802.11n (HT20), 802.11ac (VHT20), 802.11ax (HE20)
		2 for 802.11n (HT40), 802.11ac (VHT40), 802.11ax (HE40)
		1 for 802.11ac (VHT80), 802.11ax (HE80)
	5500 ~ 5720 MHz	12 for 802.11a, 802.11n (HT20), 802.11ac (VHT20), 802.11ax (HE20)
		6 for 802.11n (HT40), 802.11ac (VHT40), 802.11ax (HE40)
		3 for 802.11ac (VHT80), 802.11ax (HE80),
	5745 ~ 5825 MHz	5 for 802.11a, 802.11n (HT20), 802.11ac (VHT20), 802.11ax (HE20)
		2 for 802.11n (HT40), 802.11ac (VHT40), 802.11ax (HE40)
		1 for 802.11ac (VHT80), 802.11ax (HE80)

Underwriters Laboratories Taiwan Co., Ltd.

Building B and Building E, No. 372-7, Sec. 4, Zhongxing Rd., Zhudong Township, Hsinchu County, Taiwan
Telephone :+886-2-7737-3000
Facsimile (FAX) :+886-3-583-7948



Maximum Output Power	Non-Beamforming mode: 5180 ~ 5240 MHz: 18.49 dBm 5260 ~ 5320 MHz: 18.38 dBm 5500 ~ 5720 MHz: 18.40 dBm 5745 ~ 5825 MHz: 18.45 dBm Beamforming mode: 5180 ~ 5240 MHz: 17.85 dBm 5260 ~ 5320 MHz: 17.90 dBm 5500 ~ 5720 MHz: 17.91 dBm 5745 ~ 5825 MHz: 17.86 dBm
Normal Voltage	3.3 Vdc
S/N	3200753
Software Version	N/A

Underwriters Laboratories Taiwan Co., Ltd.

Building B and Building E, No. 372-7, Sec. 4, Zhongxing Rd., Zhudong Township, Hsinchu County, Taiwan

Telephone :+886-2-7737-3000

Facsimile (FAX) :+886-3-583-7948

Doc No: 17-EM-F0878 / 5.0



Note:

1. The models difference table as below:

Brand	Model	Difference
SparkLAN	WNFB-266AXI(BT)	-
Ampak	AP12275_M2	Same as WNFB-266AXI(BT), marketing purpose only.

*Except above change, there are no change to technical construction that is included circuit diagram, PCB Layout, components and component layout, all electrical construction and mechanical construction.

2. The EUT incorporates a MIMO function. Physically, the EUT provides two completed transmitters and two receivers.

Modulation Mode	Tx,Rx Function
802.11a	2TX,2RX
802.11n (HT20)	2TX,2RX
802.11n (HT40)	2TX,2RX
802.11ac (VHT20)	2TX,2RX
802.11ac (VHT40)	2TX,2RX
802.11ac (VHT80)	2TX,2RX
802.11ax (HE20)	2TX,2RX
802.11ax (HE40)	2TX,2RX
802.11ax (HE80)	2TX,2RX

* The modulation and bandwidth are similar for 802.11n mode for HT20 / HT40 and 802.11ac mode for VHT20 / VHT40 / VHT80 and 802.11ax mode for HE20 / HE40 / HE80, therefore investigated worst case to representative mode in test report.

3. Since the 802.11ax is the worst case, so the peak output power of 802.11n/ac will quote the value of 802.11ax.
4. The EUT contains following accessory devices.

Product	Brand	Model	Description
Dipole Antenna 1	SparkLAN	AD-103AG	2.4GHz: 2.02dBi 5GHz: 2.03dBi RP-SMA
Dipole Antenna 2	SparkLAN	AD-302N	2.4GHz: 3.14dBi 5GHz: 2.73dBi RP-SMA
Dipole Antenna 3	SparkLAN	AD-303N	2.4GHz: 3.14dBi 5GHz: 3.24dBi RP-SMA

5. The above EUT information is declared by manufacturer and for more detailed features description, please refer the manufacturer's or user's manual.

Underwriters Laboratories Taiwan Co., Ltd.

Building B and Building E, No. 372-7, Sec. 4, Zhongxing Rd., Zhudong Township, Hsinchu County, Taiwan
Telephone :+886-2-7737-3000
Facsimile (FAX) :+886-3-583-7948



6.2. Channel List

FOR 5180 ~ 5240MHz

4 channels are provided for 802.11a, 802.11n (HT20), 802.11ac (VHT20), 802.11ax (HE20):

Channel	Frequency	Channel	Frequency
36	5180 MHz	44	5220 MHz
40	5200 MHz	48	5240 MHz

2 channels are provided for 802.11n (HT40), 802.11ac (VHT40), 802.11ax (HE40):

Channel	Frequency	Channel	Frequency
38	5190 MHz	46	5230 MHz

1 channel is provided for 802.11ac (VHT80), 802.11ax (HE80):

Channel	Frequency
42	5210MHz

FOR 5260 ~ 5320MHz

4 channels are provided for 802.11a, 802.11n (HT20), 802.11ac (VHT20), 802.11ax (HE20):

Channel	Frequency	Channel	Frequency
52	5260 MHz	60	5300 MHz
56	5280 MHz	64	5320 MHz

2 channels are provided for 802.11n (HT40), 802.11ac (VHT40), 802.11ax (HE40):

Channel	Frequency	Channel	Frequency
54	5270 MHz	62	5310 MHz

1 channel is provided for 802.11ac (VHT80), 802.11ax (HE80):

Channel	Frequency
58	5290MHz

Underwriters Laboratories Taiwan Co., Ltd.

Building B and Building E, No. 372-7, Sec. 4, Zhongxing Rd., Zhudong Township, Hsinchu County, Taiwan

Telephone :+886-2-7737-3000

Facsimile (FAX) :+886-3-583-7948

Doc No: 17-EM-F0878 / 5.0



FOR 5500 ~ 5720MHz

12 channels are provided for 802.11a, 802.11n (HT20), 802.11ac (VHT20), 802.11ax (HE20):

Channel	Frequency	Channel	Frequency
100	5500 MHz	124	5620 MHz
104	5520 MHz	128	5640 MHz
108	5540 MHz	132	5660 MHz
112	5560 MHz	136	5680 MHz
116	5580 MHz	140	5700 MHz
120	5600 MHz	144	5720 MHz

6 channels are provided for 802.11n (HT40), 802.11ac (VHT40), 802.11ax (HE40):

Channel	Frequency	Channel	Frequency
102	5510 MHz	126	5630 MHz
110	5550 MHz	134	5670 MHz
118	5590 MHz	142	5710 MHz

3 channels are provided for 802.11ac (VHT80), 802.11ax (HE80):

Channel	Frequency	Channel	Frequency
106	5530MHz	138	5690MHz
122	5610MHz	-	-

FOR 5745 ~ 5825MHz:

5 channels are provided for 802.11a, 802.11n (HT20), 802.11ac (VHT20), 802.11ax (HE20):

Channel	Frequency	Channel	Frequency
149	5745MHz	161	5805MHz
153	5765MHz	165	5825MHz
157	5785MHz	-	-

2 channels are provided for 802.11n (HT40), 802.11ac (VHT40), 802.11ax (HE40):

Channel	Frequency	Channel	Frequency
151	5755MHz	159	5795MHz

1 channel is provided for 802.11ac (VHT80), 802.11ax (HE80):

Channel	Frequency
155	5775MHz

Underwriters Laboratories Taiwan Co., Ltd.

Building B and Building E, No. 372-7, Sec. 4, Zhongxing Rd., Zhudong Township, Hsinchu County, Taiwan

Telephone :+886-2-7737-3000

Facsimile (FAX) :+886-3-583-7948



6.3. Test Condition

Test Item	Test Site No.	Environmental Condition	Input Power	Test Date	Tested by
Antenna Port Conducted Measurement	SR4	23~26°C / 63~68%RH	120Vac / 60 Hz	Feb. 1, 2021 ~ Feb. 24, 2021	Mike Cai
Radiated Spurious Emission	966-2	22~26°C / 62~68%RH	120Vac / 60 Hz	Feb. 1, 2021 ~ Feb. 19, 2021	Mike Cai
AC power Line Conducted Emission	SR1	23~25°C / 63~68%RH	120Vac / 60 Hz	Feb. 1, 2021 ~ Feb. 24, 2021	Mike Cai

FCC Test Firm Registration Number: 498077

6.4. Description of Available Antennas

Ant. No.	Transmitter Circuit	Brand Name	Model Name	Ant. Type	Maximum Gain (dBi)	Remark
1	Chain (0)+(1)	SparkLAN	AD-103AG	Dipole	2.4GHz: 2.02 5GHz: 2.03	Length of Antenna cable:150mm Connector type of Antenna cable: I-PEX/MHF4 to RP-SMA(F)
2	Chain (0)+(1)	SparkLAN	AD-302N	Dipole	2.4GHz: 3.14 5GHz: 2.73	
3	Chain (0)+(1)	SparkLAN	AD-303N	Dipole	2.4GHz: 3.14 5GHz: 3.24	

Note: The above antenna information was provided from customer and for more detailed features description, please refer the manufacturer's specification or user's manual.

Underwriters Laboratories Taiwan Co., Ltd.

Building B and Building E, No. 372-7, Sec. 4, Zhongxing Rd., Zhudong Township, Hsinchu County, Taiwan

Telephone :+886-2-7737-3000

Facsimile (FAX) :+886-3-583-7948

Doc No: 17-EM-F0878 / 5.0



6.5. Test Mode Applicability and Tested Channel Detail

- Pre-Scan has been conducted to determine the worst-case mode from all possible combinations between available modulations, data rates and antenna ports (if EUT with antenna diversity architecture).
- For below 1 GHz radiated emission and AC power line conducted emission have performed all modes of operation were investigated and the worst-case emissions are reported.
- For Antenna Port Conducted Measurement, this item includes all test value of each mode, but only includes spectrum plot of worst value of each mode.
- For below 30MHz testing, investigation was done on three antenna orientations (parallel, perpendicular, and ground-parallel), parallel and perpendicular are the worst orientations, therefore testing was performed on these two orientations only.
- For AC power line conducted emissions, the pre-scan has been determined by AC power 120Vac/60Hz (worst case)
- The antennas No.3 has the highest gain, therefore, the Antenna No.3 was selected for the final test.

Non-Beamforming mode:

Test item	Mode	Frequency Band (MHz)	Modulation Technology	Available Channel	Test Channel	Data Rate
Radiated Emissions (Above 1GHz)	802.11a	5180-5240	OFDM	36 to 48	36, 44, 48	6Mbps
	802.11ax20		OFDM/ OFDMA	36 to 48	36, 44, 48	HE0
	802.11ax40			38 to 46	38, 46	HE0
	802.11ax80			42	42	HE0
	802.11a	5260-5320	OFDM	52 to 64	52, 60, 64	6Mbps
	802.11ax20		OFDM/ OFDMA	52 to 64	52, 60, 64	HE0
	802.11ax40			54 to 62	54, 62	HE0
	802.11ax80			58	58	HE0
	802.11a	5500-5720	OFDM	100 to 144	100,116,140,144	6Mbps
	802.11ax20		OFDM/ OFDMA	100 to 144	100,116,140,144	HE0
	802.11ax40			102 to 142	102, 110, 134,142	HE0
	802.11ax80			106, 122,138	106, 122,138	HE0
	802.11a	5745-5825	OFDM	149 to 165	149, 157, 165	6Mbps
	802.11ax20		OFDM/ OFDMA	149 to 165	149, 157, 165	HE0
	802.11ax40			151 to 159	151, 159	HE0
	802.11ax80			155	155	HE0
Radiated Emissions (Below 1GHz)	802.11a	5500-5720	OFDM	100 to 144	116	6Mbps
AC Power Line Conducted Emission	802.11a	5500-5720	OFDM	100 to 144	116	6Mbps

Underwriters Laboratories Taiwan Co., Ltd.

Building B and Building E, No. 372-7, Sec. 4, Zhongxing Rd., Zhudong Township, Hsinchu County, Taiwan

Telephone :+886-2-7737-3000

Facsimile (FAX) :+886-3-583-7948

Doc No: 17-EM-F0878 / 5.0



Test item	Mode	Frequency Band (MHz)	Modulation Technology	Available Channel	Test Channel	Data Rate
Antenna Port Conducted Measurement	802.11a	5180-5240	OFDM	36 to 48	36, 44, 48	6Mbps
	802.11ax20		OFDM/ OFDMA	36 to 48	36, 44, 48	HE0
	802.11ax40			38 to 46	38, 46	HE0
	802.11ax80			42	42	HE0
	802.11a	5260-5320	OFDM	52 to 64	52, 60, 64	6Mbps
	802.11ax20		OFDM/ OFDMA	52 to 64	52, 60, 64	HE0
	802.11ax40			54 to 62	54, 62	HE0
	802.11ax80			58	58	HE0
	802.11a	5500-5720	OFDM	100 to 144	100,116,140,144	6Mbps
	802.11ax20		OFDM/ OFDMA	100 to 144	100,116,140,144	HE0
	802.11ax40			102 to 142	102, 110, 134,142	HE0
	802.11ax80			106, 122,138	106, 122,138	HE0
	802.11a	5745-5825	OFDM	149 to 165	149, 157, 165	6Mbps
	802.11ax20		OFDM/ OFDMA	149 to 165	149, 157, 165	HE0
	802.11ax40			151 to 159	151, 159	HE0
	802.11ax80			155	155	HE0

Underwriters Laboratories Taiwan Co., Ltd.

Building B and Building E, No. 372-7, Sec. 4, Zhongxing Rd., Zhudong Township, Hsinchu County, Taiwan

Telephone :+886-2-7737-3000

Facsimile (FAX) :+886-3-583-7948

Doc No: 17-EM-F0878 / 5.0



Beamforming mode:

Test item	Mode	Frequency Band (MHz)	Modulation Technology	Available Channel	Test Channel	Data Rate
Radiated Emissions (Above 1GHz)	802.11ax20	5180-5240	OFDM/ OFDMA	36 to 48	36, 44, 48	HE0
	802.11ax40			38 to 46	38, 46	HE0
	802.11ax80			42	42	HE0
	802.11ax20	5260-5320	OFDM/ OFDMA	52 to 64	52, 60, 64	HE0
	802.11ax40			54 to 62	54, 62	HE0
	802.11ax80			58	58	HE0
	802.11ax20	5500-5720	OFDM/ OFDMA	100 to 144	100,116,140,144	HE0
	802.11ax40			102 to 142	102, 110, 134,142	HE0
	802.11ax80			106, 122,138	106, 122,138	HE0
	802.11ax20	5745-5825	OFDM/ OFDMA	149 to 165	149, 157, 165	HE0
	802.11ax40			151 to 159	151, 159	HE0
	802.11ax80			155	155	HE0
Radiated Emissions (Below 1GHz)	802.11ax20	5500-5720	OFDM	100 to 144	116	HE0
AC Power Line Conducted Emission	802.11ax20	5500-5720	OFDM	100 to 144	116	HE0
Antenna Port Conducted Measurement	802.11ax20	5180-5240	OFDM/ OFDMA	36 to 48	36, 44, 48	HE0
	802.11ax40			38 to 46	38, 46	HE0
	802.11ax80			42	42	HE0
	802.11ax20	5260-5320	OFDM/ OFDMA	52 to 64	52, 60, 64	HE0
	802.11ax40			54 to 62	54, 62	HE0
	802.11ax80			58	58	HE0
	802.11ax20	5500-5720	OFDM/ OFDMA	100 to 144	100,116,140,144	HE0
	802.11ax40			102 to 142	102, 110, 134,142	HE0
	802.11ax80			106, 122,138	106, 122,138	HE0
	802.11ax20	5745-5825	OFDM/ OFDMA	149 to 165	149, 157, 165	HE0
	802.11ax40			151 to 159	151, 159	HE0
	802.11ax80			155	155	HE0

Underwriters Laboratories Taiwan Co., Ltd.

Building B and Building E, No. 372-7, Sec. 4, Zhongxing Rd., Zhudong Township, Hsinchu County, Taiwan

Telephone :+886-2-7737-3000

Facsimile (FAX) :+886-3-583-7948

Doc No: 17-EM-F0878 / 5.0



6.6. Duty cycle

Non-Beamforming mode

802.11a:

Duty cycle = $1.12/1.23 = 0.911$, Duty factor(dB) = $10 * \log(1/0.911) = 0.41$ dB

OFDM:

802.11ax (HE20): Duty cycle = $0.8/0.93 = 0.86$, Duty factor(dB) = $10 * \log(1/0.86) = 0.66$ dB

802.11ax (HE40): Duty cycle = $0.41/0.55 = 0.745$, Duty factor(dB) = $10 * \log(1/0.745) = 1.28$ dB

802.11ax (HE80): Duty cycle = $0.2/0.34 = 0.588$, Duty factor(dB) = $10 * \log(1/0.588) = 2.31$ dB

OFDMA:

802.11ax (HE20): Duty cycle = $3.94/4.96 = 0.794$, Duty factor(dB) = $10 * \log(1/0.794) = 1$ dB

802.11ax (HE40): Duty cycle = $1.96/3 = 0.653$, Duty factor(dB) = $10 * \log(1/0.653) = 1.85$ dB

802.11ax (HE80): Duty cycle = $0.94/1.99 = 0.472$, Duty factor(dB) = $10 * \log(1/0.472) = 3.26$ dB



OFDM





OFDMA





Beamforming mode

OFDM:

802.11ax (HE20): Duty cycle = $0.82/0.94 = 0.872$, Duty factor(dB) = $10 * \log(1/0.872) = 0.6$ dB

802.11ax (HE40): Duty cycle = $0.41/0.55 = 0.745$, Duty factor(dB) = $10 * \log(1/0.745) = 1.28$ dB

802.11ax (HE80): Duty cycle = $0.2/0.35 = 0.571$, Duty factor(dB) = $10 * \log(1/0.571) = 2.44$ dB

OFDMA:

802.11ax (HE20): Duty cycle = $3.92/4.96 = 0.79$, Duty factor(dB) = $10 * \log(1/0.79) = 1.03$ dB

802.11ax (HE40):Duty cycle = $1.96/3.02 = 0.649$, Duty factor(dB) = $10 * \log(1/0.649) = 1.88$ dB

802.11ax (HE80): Duty cycle = $0.94/2 = 0.47$, Duty factor(dB) = $10 * \log(1/0.47) = 3.28$ dB

Underwriters Laboratories Taiwan Co., Ltd.

Building B and Building E, No. 372-7, Sec. 4, Zhongxing Rd., Zhudong Township, Hsinchu County, Taiwan

Telephone :+886-2-7737-3000

Facsimile (FAX) :+886-3-583-7948

Doc No: 17-EM-F0878 / 5.0



OFDM

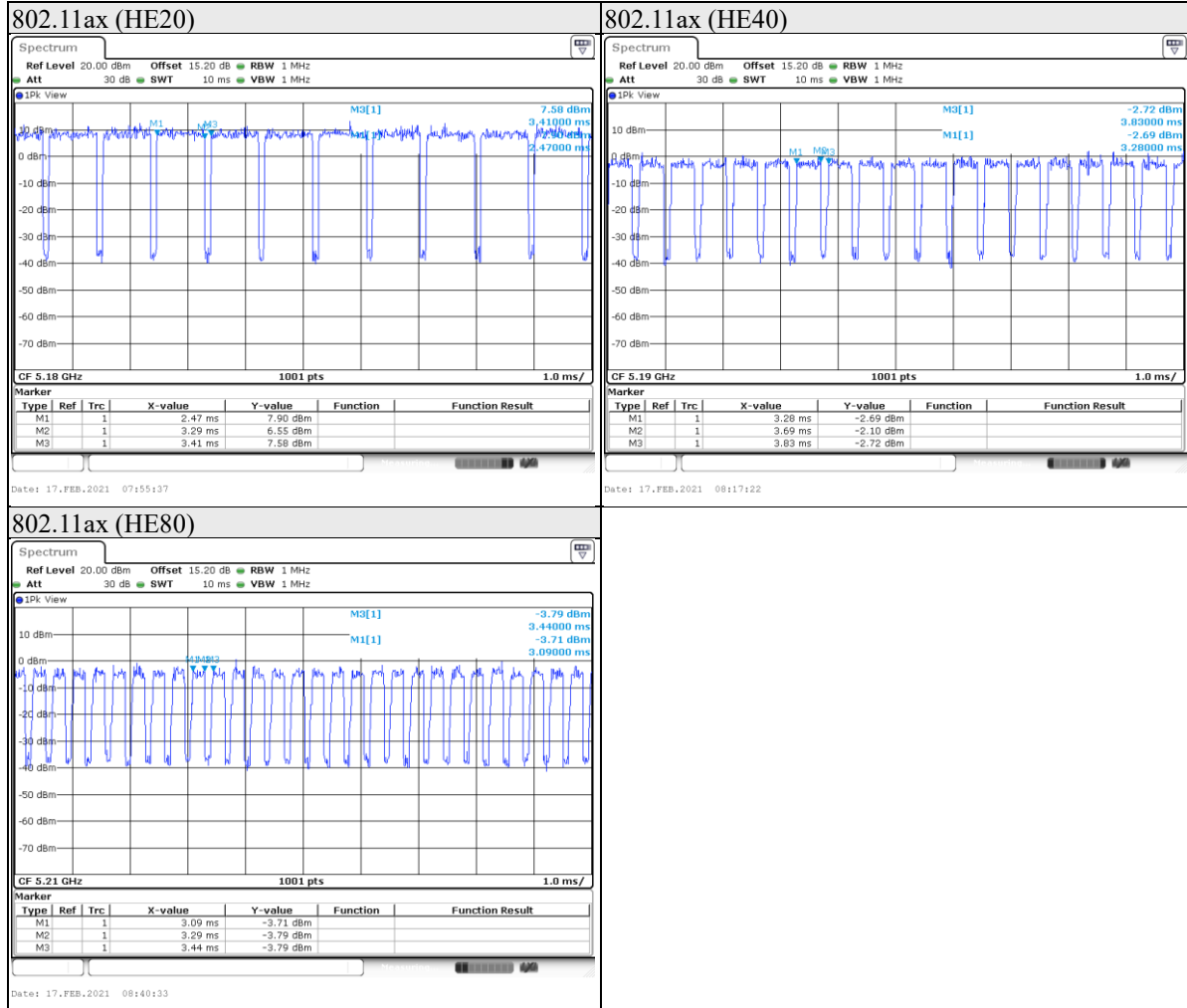



OFDMA





7. Test Equipment

Test Equipment List					
Equipment	Manufacturer	Model No.	Serial No.	Cal. Date	Expired date
Radiated Spurious Emission					
Spectrum Analyzer	Keysight	N9010A	MY56070827	2020/11/11	2021/11/10
EMI Test Receiver	Rohde & Schwarz	ESR7	101754	2020/12/11	2021/12/10
Loop Antenna	ETS lindgren	6502	00213440	2020/12/25	2021/12/24
Trilog-Broadband Antenna with 5dB Attenuator	Schwarzbeck & EMCI	VULB 9168 & N-6-05	774 & AT-N0538	2021/1/13	2022/1/12
Horn Antenna (1-18 GHz)	Schwarzbeck	BBHA 9120 D	01690	2020/12/30	2021/12/29
Horn Antenna (18-40 GHz)	Schwarzbeck	BBHA 9170	781	2020/12/30	2021/12/29
Preamplifier (30-1000 MHz)	EMCI	EMC330E	980405	2020/6/9	2021/6/8
Preamplifier (1-18 GHz)	EMCI	EMC051835BE	980406	2020/2/4	2021/2/2
				2021/2/3	2022/2/2
Preamplifier (18-40GHz)	EMCI	EMC184040SEE	980426	2020/5/19	2021/5/18
Cables	Hanyitek	K1K50-UP0264-K1K50-2500	170214-4 & 170425-2	2020/7/2	2021/7/1
Cables	Hanyitek	K1K50-UP0264-K1K50-2500	170214-1 & 170214-2	2021/1/7	2022/1/6

Underwriters Laboratories Taiwan Co., Ltd.

Building B and Building E, No. 372-7, Sec. 4, Zhongxing Rd., Zhudong Township, Hsinchu County, Taiwan

Telephone :+886-2-7737-3000

Facsimile (FAX) :+886-3-583-7948

Doc No: 17-EM-F0878 / 5.0



Test report No. : 4789558396-US-R1-V0
Page : 24 of 393
Issued date : Mar. 16, 2021
FCC ID : RYK-WNFB266AXIBT

Test Equipment List					
Equipment	Manufacturer	Model No.	Serial No.	Cal. Date	Expired date
Antenna Port Conducted Measurement					
Spectrum Analyzer	Keysight	N9010A	MY56070834	2020/11/6	2021/11/5
Pulse Power Sensor	Anritsu	MA2411B	1531202	2020/12/21	2021/12/20
Power Meter	Anritsu	ML2495A	1645002	2020/12/21	2021/12/20
Temperature & Humidity Test Chamber	GIANT FORCE	GTH-150-40-CP-AR	MAA1701-010	2020/3/23	2021/3/22
AC power Line Conducted Emission					
EMI Test Receiver	Rohde & Schwarz	ESR7	101753	2020/11/17	2021/11/16
Two-Line V-Network	Rohde & Schwarz	ENV216	102136	2020/8/19	2021/8/18
Impuls-Begrenzer Pulse Limiter	Rohde & Schwarz	ESH3-Z2	102219-Qt	2020/8/12	2021/8/11
Cables	TITAN	CFD200	T0732ACFD20 020A300-1	2020/9/1	2021/8/31

UL Software		
Description	Name	Version
Radiated measurement	EZ_EMG	1.1.4.2
Conducted measurement	Keysight.TestSystem	1.0.0.0
AC power Line Conducted Emission	EZ_EMG	1.1.4.2

Underwriters Laboratories Taiwan Co., Ltd.

Building B and Building E, No. 372-7, Sec. 4, Zhongxing Rd., Zhudong Township, Hsinchu County, Taiwan

Telephone :+886-2-7737-3000

Facsimile (FAX) :+886-3-583-7948

Doc No: 17-EM-F0878 / 5.0



8. Description of Test Setup

Support Equipment

Equipment	Brand Name	Model Name	S/N	Remark
Notebook	Lenovo	T430	PBE38AK	N/A
Mini Card adapter	N/A	N/A	N/A	N/A
Power adapter	AOEM	ADS012PM-W 050200	N/A	For Mini Card adapter use

Test Setup

The EUT was worked in engineering mode to transmit signal. The test special command was used to enable a continuous transmission mode and to select the test channels, data rates, modulation schemes and power setting as required. When the configuration is complete, the notebook can be removed.

Setup Diagram for Test

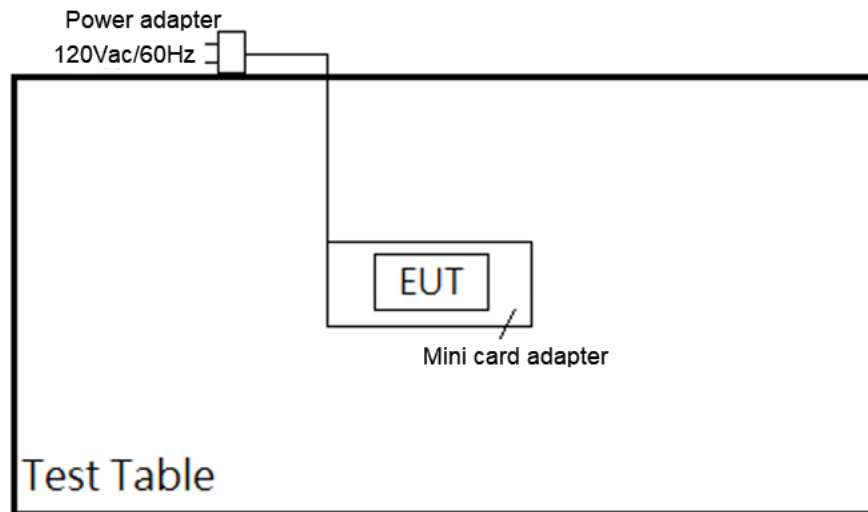

Underwriters Laboratories Taiwan Co., Ltd.

Building B and Building E, No. 372-7, Sec. 4, Zhongxing Rd., Zhudong Township, Hsinchu County, Taiwan

Telephone : +886-2-7737-3000

Facsimile (FAX) : +886-3-583-7948

Doc No: 17-EM-F0878 / 5.0



9. Test Results

9.1. 6dB Bandwidth

Requirements

The minimum 6 dB bandwidth shall be at least 500 kHz.

Test procedure

- Set resolution bandwidth (RBW) = 100kHz
- Set the video bandwidth (VBW) $\geq 3 \times$ RBW, Detector = Peak.
- Trace mode = max hold.
- Sweep = auto couple.
- Measure the maximum width of the emission that is constrained by the frequencies associated with the two amplitude points (upper and lower) that are attenuated by 6 dB relative to the maximum level measured in the fundamental emission

Test Setup

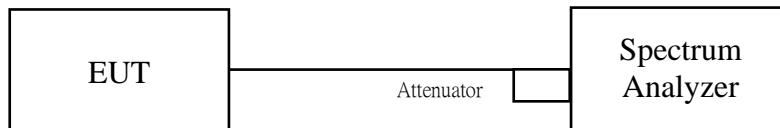

The loss between RF output port of the EUT and the input port of the Spectrum Analyzer has been taken into consideration.

Underwriters Laboratories Taiwan Co., Ltd.

Building B and Building E, No. 372-7, Sec. 4, Zhongxing Rd., Zhudong Township, Hsinchu County, Taiwan

Telephone :+886-2-7737-3000

Facsimile (FAX) :+886-3-583-7948

Doc No: 17-EM-F0878 / 5.0



Test Data

Non-Beamforming mode

802.11a

Channel	Frequency (MHz)	6 dB Bandwidth (MHz)		Minimum Limit (MHz)	Pass / Fail
		Chain 0	Chain 1		
144 (U-NII-3 Band)	5720	3.07	3.07	0.5	PASS
149	5745	16.30	16.30	0.5	PASS
157	5785	16.30	16.30	0.5	PASS
165	5825	16.30	16.30	0.5	PASS

Underwriters Laboratories Taiwan Co., Ltd.

Building B and Building E, No. 372-7, Sec. 4, Zhongxing Rd., Zhudong Township, Hsinchu County, Taiwan

Telephone :+886-2-7737-3000

Facsimile (FAX) :+886-3-583-7948

Doc No: 17-EM-F0878 / 5.0



OFDM

802.11ax (HE20)

Channel	Frequency (MHz)	6 dB Bandwidth (MHz)		Minimum Limit (MHz)	Pass / Fail
		Chain 0	Chain 1		
144 (U-NII-3 Band)	5720	4.15	3.79	0.5	PASS
149	5745	18.50	17.38	0.5	PASS
157	5785	18.58	16.78	0.5	PASS
165	5825	18.42	16.82	0.5	PASS

802.11ax (HE40)

Channel	Frequency (MHz)	6 dB Bandwidth (MHz)		Minimum Limit (MHz)	Pass / Fail
		Chain 0	Chain 1		
142 (U-NII-3 Band)	5710	3.78	3.70	0.5	PASS
151	5755	37.72	37.56	0.5	PASS
159	5795	37.48	37.16	0.5	PASS

802.11ax (HE80)

Channel	Frequency (MHz)	6 dB Bandwidth (MHz)		Minimum Limit (MHz)	Pass / Fail
		Chain 0	Chain 1		
138 (U-NII-3 Band)	5690	3.52	3.36	0.5	PASS
155	5775	76.56	77.36	0.5	PASS

Underwriters Laboratories Taiwan Co., Ltd.

Building B and Building E, No. 372-7, Sec. 4, Zhongxing Rd., Zhudong Township, Hsinchu County, Taiwan

Telephone :+886-2-7737-3000

Facsimile (FAX) :+886-3-583-7948

Doc No: 17-EM-F0878 / 5.0



OFDMA

802.11ax (HE20)

Channel	Frequency (MHz)	6 dB Bandwidth (MHz)		Minimum Limit (MHz)	Pass / Fail
		Chain 0	Chain 1		
144 (U-NII-3 Band)	5720	4.43	4.47	0.5	PASS
149	5745	19.14	18.94	0.5	PASS
157	5785	19.02	19.02	0.5	PASS
165	5825	19.14	18.94	0.5	PASS

802.11ax (HE40)

Channel	Frequency (MHz)	6 dB Bandwidth (MHz)		Minimum Limit (MHz)	Pass / Fail
		Chain 0	Chain 1		
142 (U-NII-3 Band)	5710	3.86	3.70	0.5	PASS
151	5755	37.72	37.72	0.5	PASS
159	5795	37.72	37.56	0.5	PASS

802.11ax (HE80)

Channel	Frequency (MHz)	6 dB Bandwidth (MHz)		Minimum Limit (MHz)	Pass / Fail
		Chain 0	Chain 1		
138 (U-NII-3 Band)	5690	3.68	3.52	0.5	PASS
155	5775	77.52	77.68	0.5	PASS

Underwriters Laboratories Taiwan Co., Ltd.

Building B and Building E, No. 372-7, Sec. 4, Zhongxing Rd., Zhudong Township, Hsinchu County, Taiwan

Telephone : +886-2-7737-3000

Facsimile (FAX) : +886-3-583-7948

Doc No: 17-EM-F0878 / 5.0



OFDM

Spectrum Plot of Worst Value

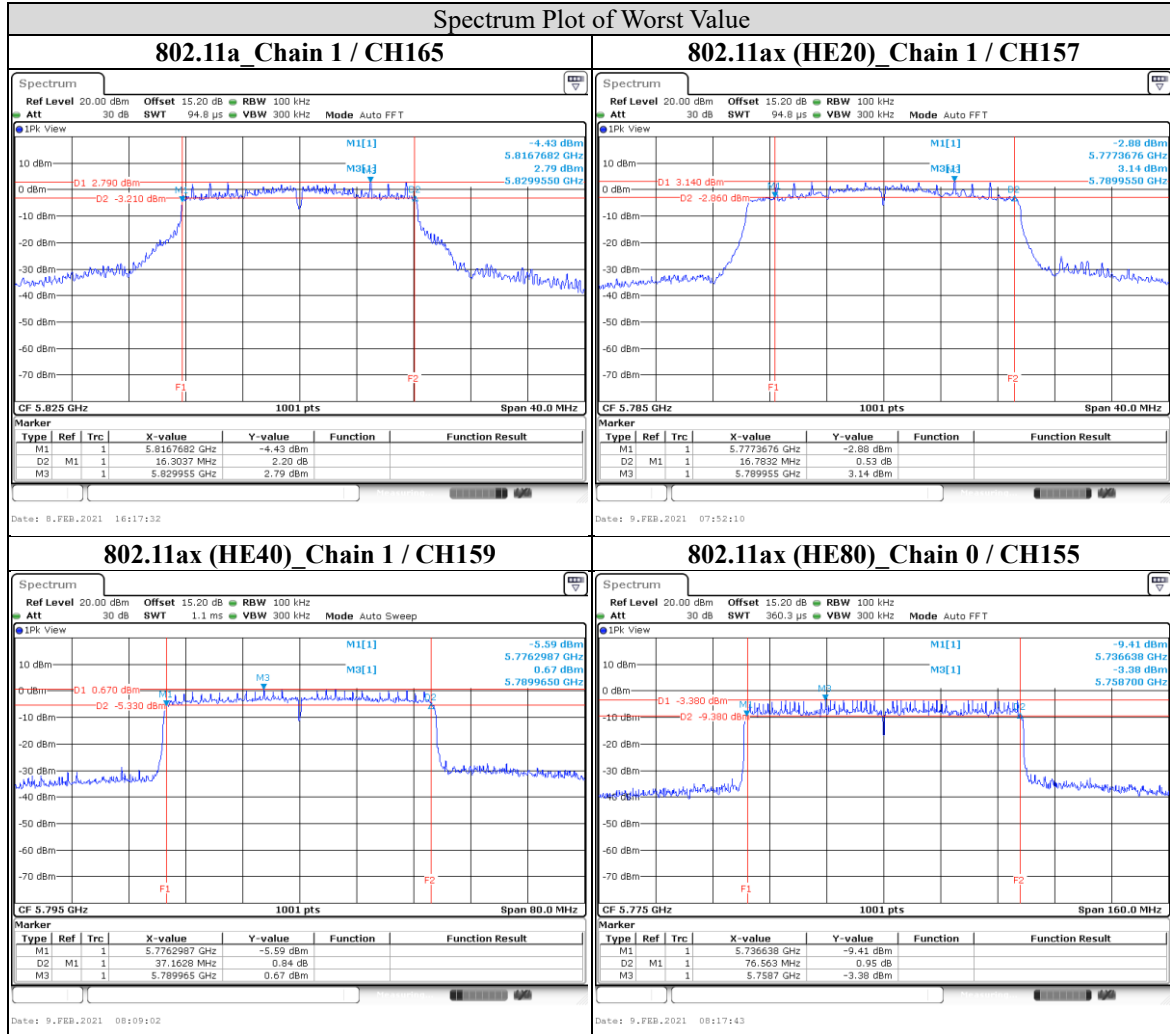

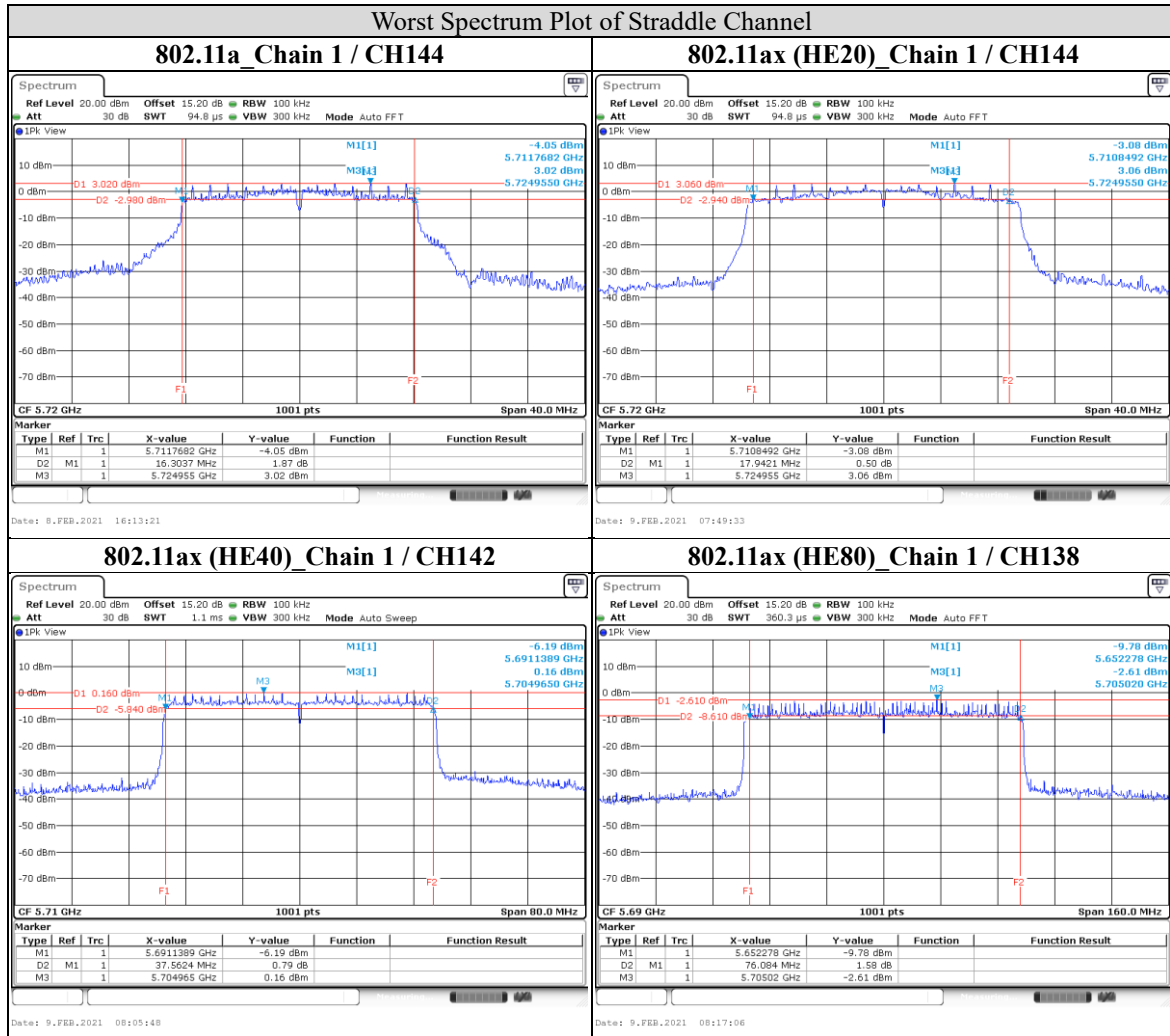

Note: The bandwidth above 5725MHz = Marker 1 + Delta 2 – 5725MHz



OFDMA

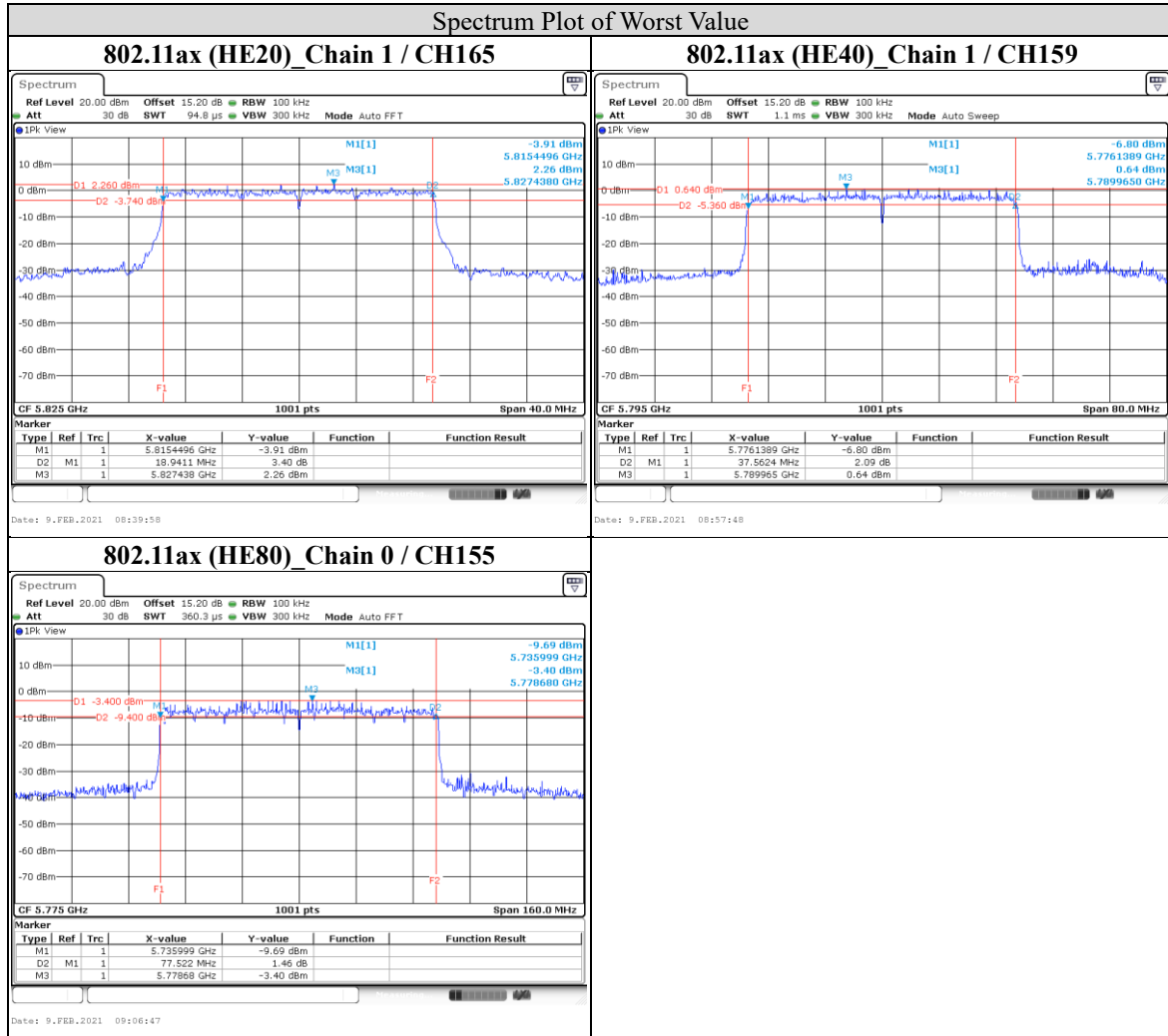

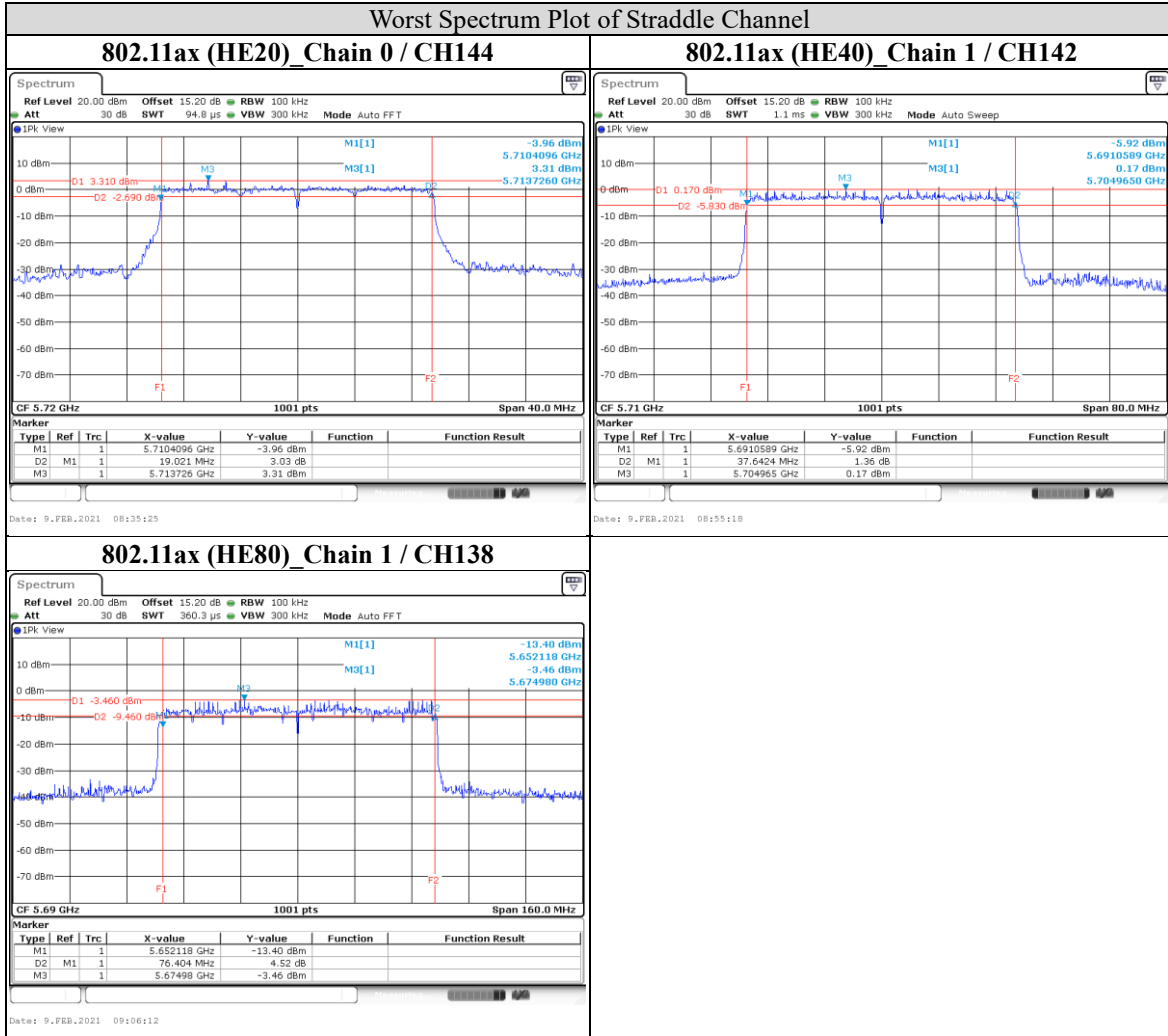

Note: The bandwidth above 5725MHz = Marker 1 + Delta 2 – 5725MHz



Beamforming mode

OFDM

802.11ax (HE20)

Channel	Frequency (MHz)	6 dB Bandwidth (MHz)		Minimum Limit (MHz)	Pass / Fail
		Chain 0	Chain 1		
144 (U-NII-3 Band)	5720	4.03	4.23	0.5	PASS
149	5745	18.54	17.90	0.5	PASS
157	5785	18.46	17.70	0.5	PASS
165	5825	18.34	16.50	0.5	PASS

802.11ax (HE40)

Channel	Frequency (MHz)	6 dB Bandwidth (MHz)		Minimum Limit (MHz)	Pass / Fail
		Chain 0	Chain 1		
142 (U-NII-3 Band)	5710	3.78	3.62	0.5	PASS
151	5755	37.64	37.48	0.5	PASS
159	5795	37.56	37.24	0.5	PASS

802.11ax (HE80)

Channel	Frequency (MHz)	6 dB Bandwidth (MHz)		Minimum Limit (MHz)	Pass / Fail
		Chain 0	Chain 1		
138 (U-NII-3 Band)	5690	3.36	2.40	0.5	PASS
155	5775	77.20	77.36	0.5	PASS

Underwriters Laboratories Taiwan Co., Ltd.

Building B and Building E, No. 372-7, Sec. 4, Zhongxing Rd., Zhudong Township, Hsinchu County, Taiwan

Telephone :+886-2-7737-3000

Facsimile (FAX) :+886-3-583-7948

Doc No: 17-EM-F0878 / 5.0



OFDMA

802.11ax (HE20)

Channel	Frequency (MHz)	6 dB Bandwidth (MHz)		Minimum Limit (MHz)	Pass / Fail
		Chain 0	Chain 1		
144 (U-NII-3 Band)	5720	4.51	4.51	0.5	PASS
149	5745	19.02	18.98	0.5	PASS
157	5785	19.02	19.02	0.5	PASS
165	5825	19.02	18.94	0.5	PASS

802.11ax (HE40)

Channel	Frequency (MHz)	6 dB Bandwidth (MHz)		Minimum Limit (MHz)	Pass / Fail
		Chain 0	Chain 1		
142 (U-NII-3 Band)	5710	3.86	3.78	0.5	PASS
151	5755	37.80	37.72	0.5	PASS
159	5795	37.64	37.56	0.5	PASS

802.11ax (HE80)

Channel	Frequency (MHz)	6 dB Bandwidth (MHz)		Minimum Limit (MHz)	Pass / Fail
		Chain 0	Chain 1		
138 (U-NII-3 Band)	5690	3.68	3.20	0.5	PASS
155	5775	77.68	77.52	0.5	PASS

Underwriters Laboratories Taiwan Co., Ltd.

Building B and Building E, No. 372-7, Sec. 4, Zhongxing Rd., Zhudong Township, Hsinchu County, Taiwan

Telephone : +886-2-7737-3000

Facsimile (FAX) : +886-3-583-7948

Doc No: 17-EM-F0878 / 5.0



OFDM

Spectrum Plot of Worst Value

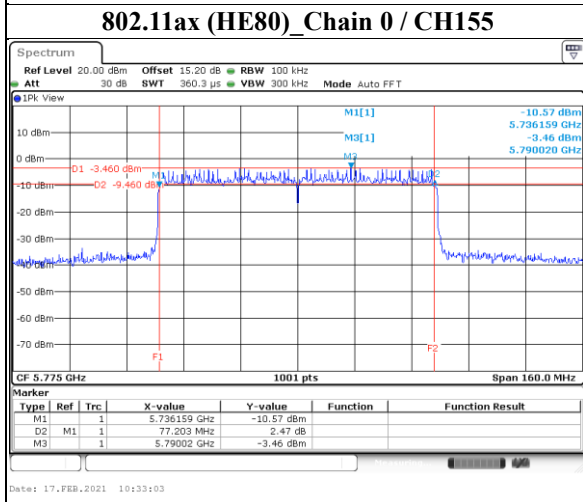
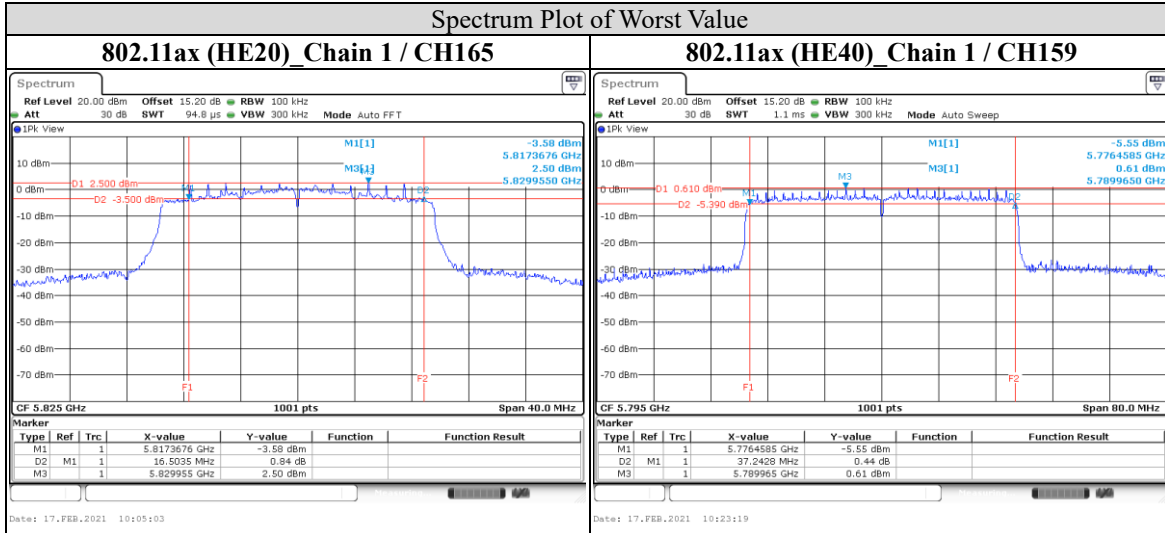

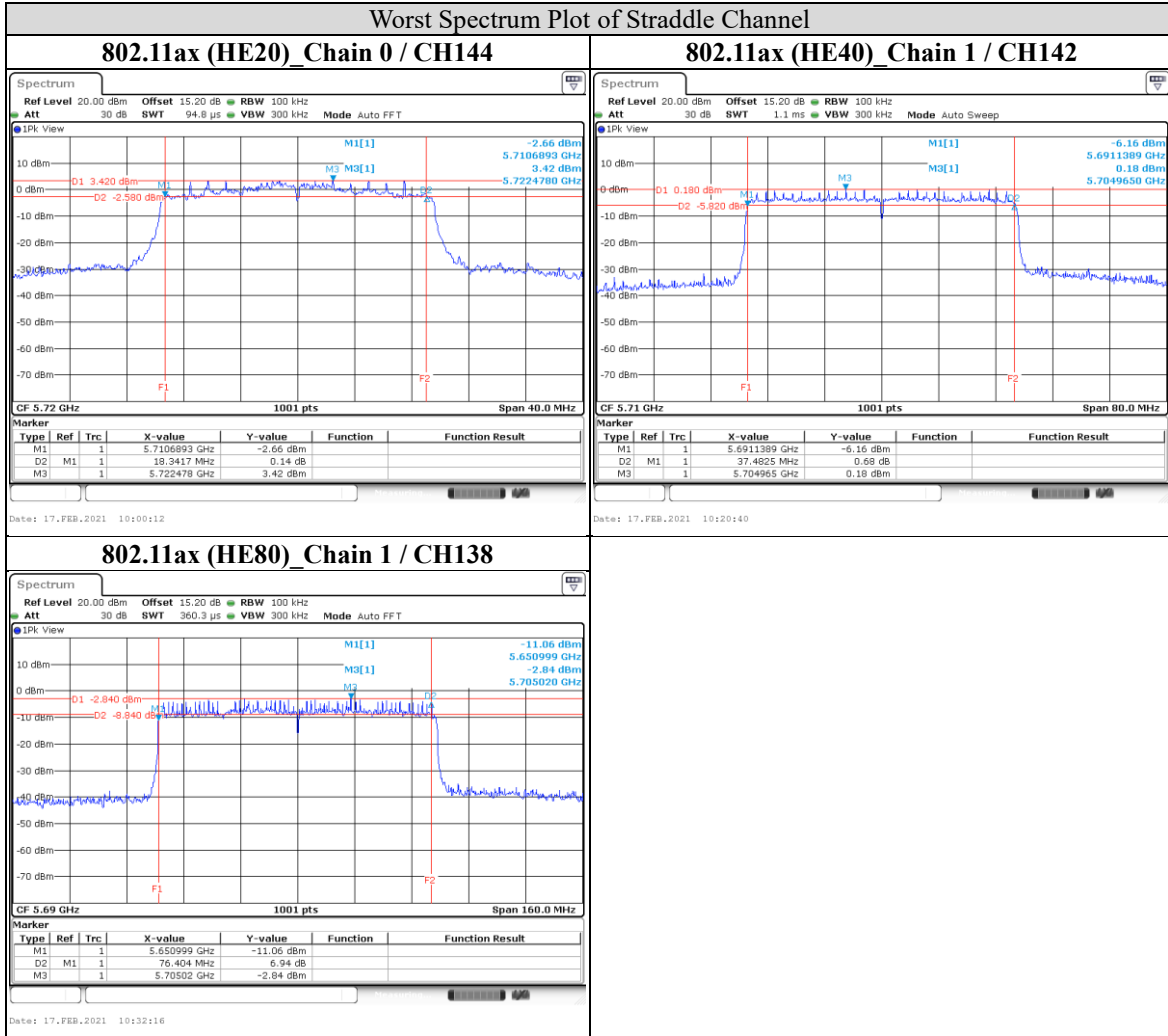

Note: The bandwidth above 5725MHz = Marker 1 + Delta 2 – 5725MHz



OFDMA

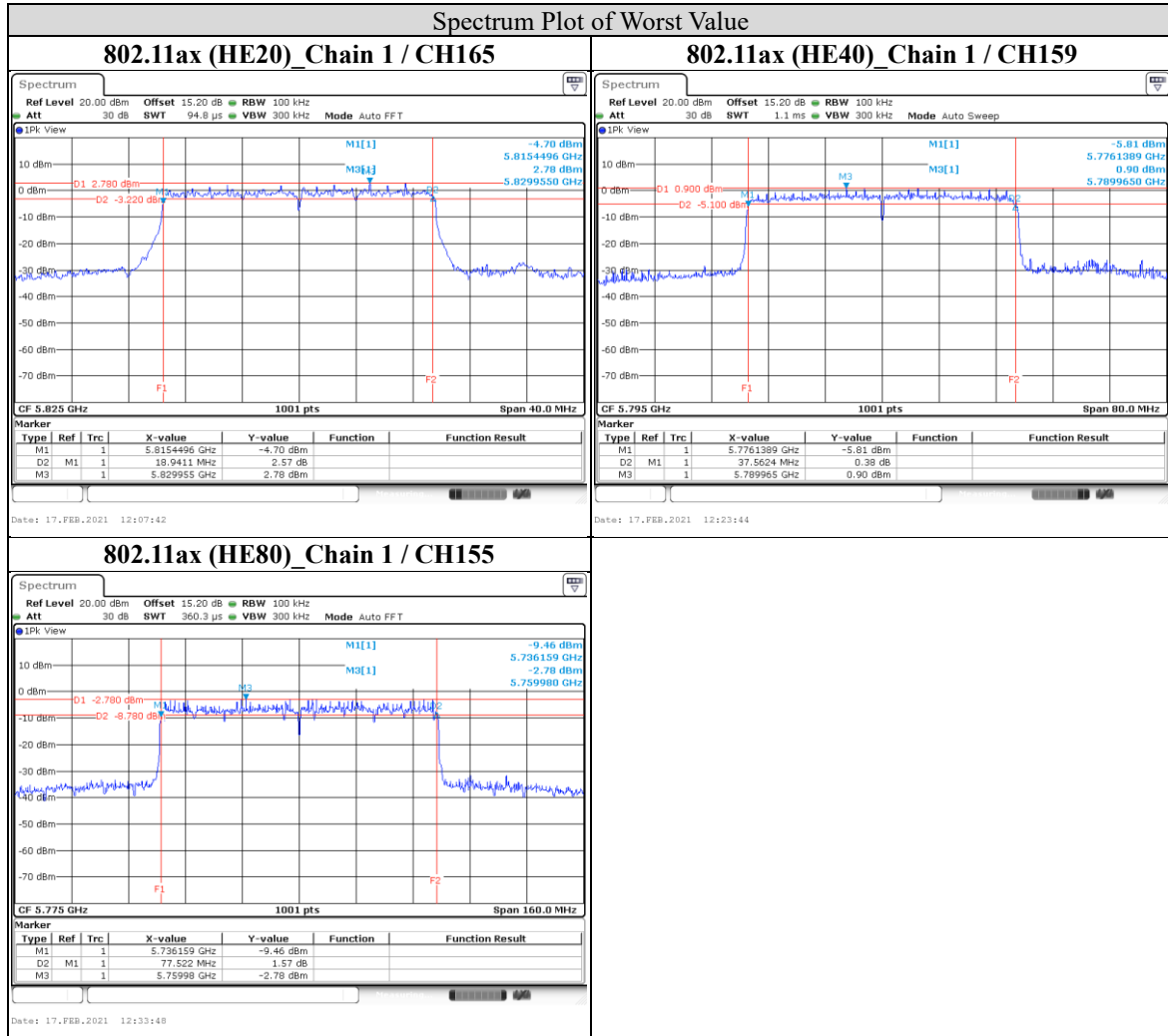

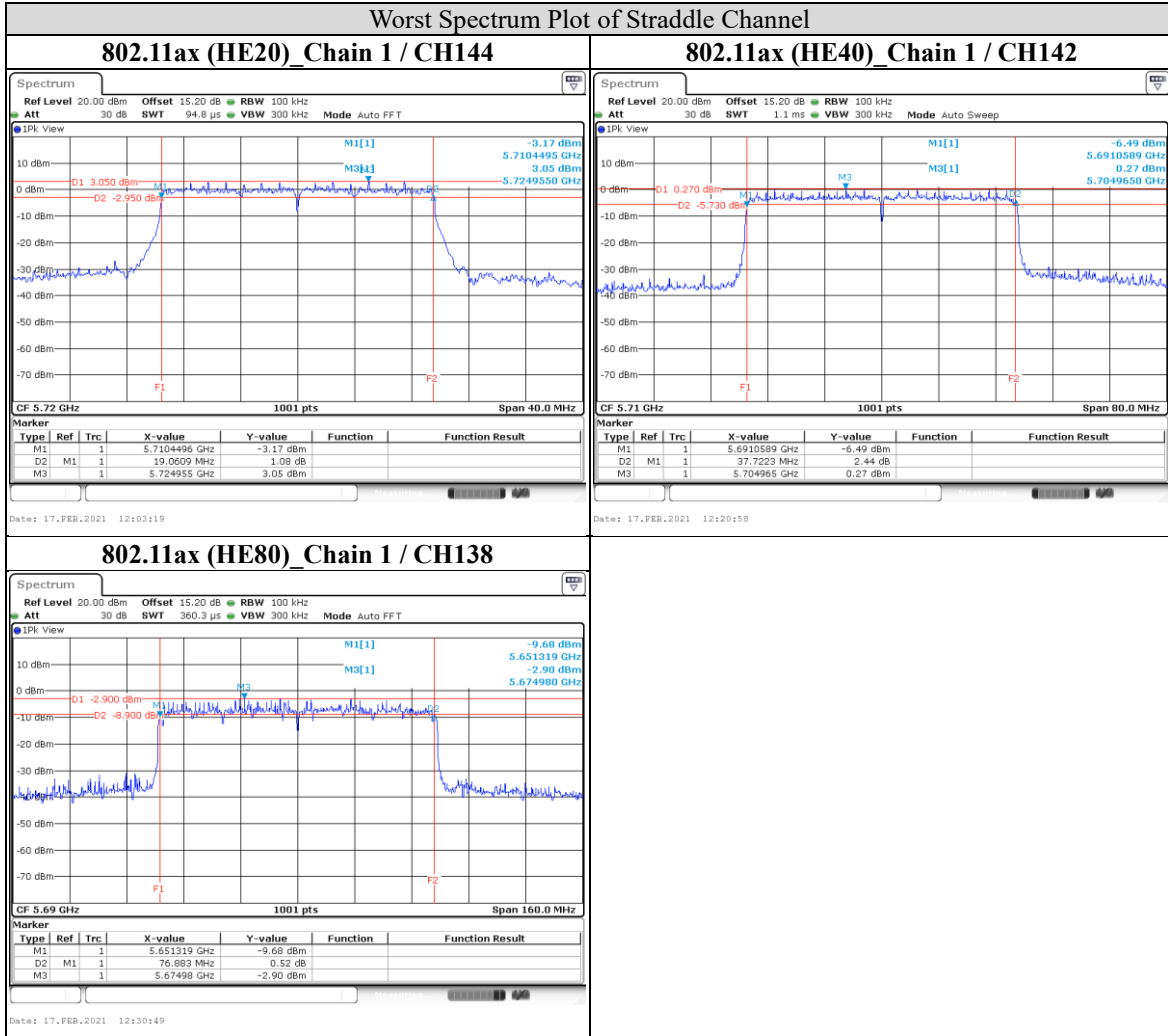

Note: The bandwidth above 5725MHz = Marker 1 + Delta 2 – 5725MHz



9.2. 26dB Bandwidth

Test procedure

- a. Set RBW = approximately 1% of the emission bandwidth.
- b. Set the VBW > RBW.
- c. Detector = Peak.
- d. Trace mode = max hold.
- e. Measure the maximum width of the emission that is 26 dB down from the peak of the emission. Compare this with the RBW setting of the analyzer. Readjust RBW and repeat measurement as needed until the RBW/EBW ratio is approximately 1%.

Test Setup

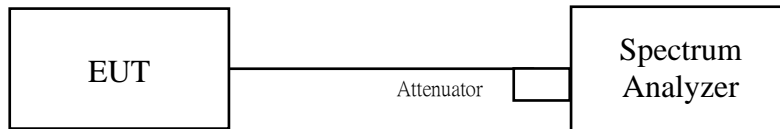

The loss between RF output port of the EUT and the input port of the Spectrum Analyzer has been taken into consideration.



Test Data

Non-Beamforming mode

802.11a

Channel	Frequency (MHz)	26 dB Bandwidth (MHz)	
		Chain 0	Chain 1
36	5180	21.62	21.30
44	5220	21.38	21.26
48	5240	21.26	22.18
52	5260	21.30	21.26
60	5300	21.30	22.18
64	5320	21.50	21.38
100	5500	21.70	21.34
116	5580	21.50	21.42
140	5700	21.54	21.42
144	5720	21.58	21.66
144 (U-NII-2c Band)	5720	15.87	15.95

Underwriters Laboratories Taiwan Co., Ltd.

Building B and Building E, No. 372-7, Sec. 4, Zhongxing Rd., Zhudong Township, Hsinchu County, Taiwan

Telephone :+886-2-7737-3000

Facsimile (FAX) :+886-3-583-7948

Doc No: 17-EM-F0878 / 5.0



OFDM

802.11ax (HE20)

Channel	Frequency (MHz)	26 dB Bandwidth (MHz)	
		Chain 0	Chain 1
36	5180	21.66	21.26
44	5220	21.30	21.02
48	5240	21.18	21.26
52	5260	21.26	21.42
60	5300	21.38	21.18
64	5320	21.10	20.98
100	5500	21.18	21.30
116	5580	23.26	21.26
140	5700	22.70	21.18
144	5720	21.38	21.74
144 (U-NII-2c Band)	5720	15.71	16.11

802.11ax (HE40)

Channel	Frequency (MHz)	26 dB Bandwidth (MHz)	
		Chain 0	Chain 1
38	5190	40.12	40.12
46	5230	40.44	40.12
54	5270	40.44	40.52
62	5310	40.52	40.04
102	5510	40.44	40.12
110	5550	40.44	40.04
134	5670	40.68	40.12
142	5710	40.52	40.20
142 (U-NII-2c Band)	5710	35.14	35.14

Underwriters Laboratories Taiwan Co., Ltd.

Building B and Building E, No. 372-7, Sec. 4, Zhongxing Rd., Zhudong Township, Hsinchu County, Taiwan

Telephone : +886-2-7737-3000

Facsimile (FAX) : +886-3-583-7948

Doc No: 17-EM-F0878 / 5.0



802.11ax (HE80)

Channel	Frequency (MHz)	26 dB Bandwidth (MHz)	
		Chain 0	Chain 1
42	5210	82.16	81.84
58	5290	81.68	81.36
106	5530	81.84	81.52
122	5610	82.00	81.52
138	5690	88.71	81.84
138 (U-NII-2c Band)	5690	82.95	75.76

Underwriters Laboratories Taiwan Co., Ltd.

Building B and Building E, No. 372-7, Sec. 4, Zhongxing Rd., Zhudong Township, Hsinchu County, Taiwan

Telephone :+886-2-7737-3000

Facsimile (FAX) :+886-3-583-7948

Doc No: 17-EM-F0878 / 5.0



OFDMA

802.11ax (HE20)

Channel	Frequency (MHz)	26 dB Bandwidth (MHz)	
		Chain 0	Chain 1
36	5180	22.34	21.62
44	5220	21.86	21.58
48	5240	22.14	21.58
52	5260	21.78	22.54
60	5300	21.82	21.62
64	5320	21.70	21.62
100	5500	21.66	21.58
116	5580	21.86	21.78
140	5700	21.62	21.66
144	5720	21.62	21.62
144 (U-NII-2c Band)	5720	15.83	15.87

802.11ax (HE40)

Channel	Frequency (MHz)	26 dB Bandwidth (MHz)	
		Chain 0	Chain 1
38	5190	40.68	40.20
46	5230	40.20	40.12
54	5270	40.28	40.12
62	5310	40.68	40.20
102	5510	40.12	40.04
110	5550	40.68	40.52
134	5670	40.68	40.28
142	5710	40.76	40.12
142 (U-NII-2c Band)	5710	35.54	35.14

Underwriters Laboratories Taiwan Co., Ltd.

Building B and Building E, No. 372-7, Sec. 4, Zhongxing Rd., Zhudong Township, Hsinchu County, Taiwan

Telephone : +886-2-7737-3000

Facsimile (FAX) : +886-3-583-7948

Doc No: 17-EM-F0878 / 5.0



802.11ax (HE80)

Channel	Frequency (MHz)	26 dB Bandwidth (MHz)	
		Chain 0	Chain 1
42	5210	82.48	81.52
58	5290	81.52	81.84
106	5530	81.84	81.36
122	5610	82.16	81.68
138	5690	81.20	81.68
138 (U-NII-2c Band)	5690	75.60	75.76

Underwriters Laboratories Taiwan Co., Ltd.

Building B and Building E, No. 372-7, Sec. 4, Zhongxing Rd., Zhudong Township, Hsinchu County, Taiwan

Telephone :+886-2-7737-3000

Facsimile (FAX) :+886-3-583-7948

Doc No: 17-EM-F0878 / 5.0



OFDM

Spectrum Plot of Worst Value

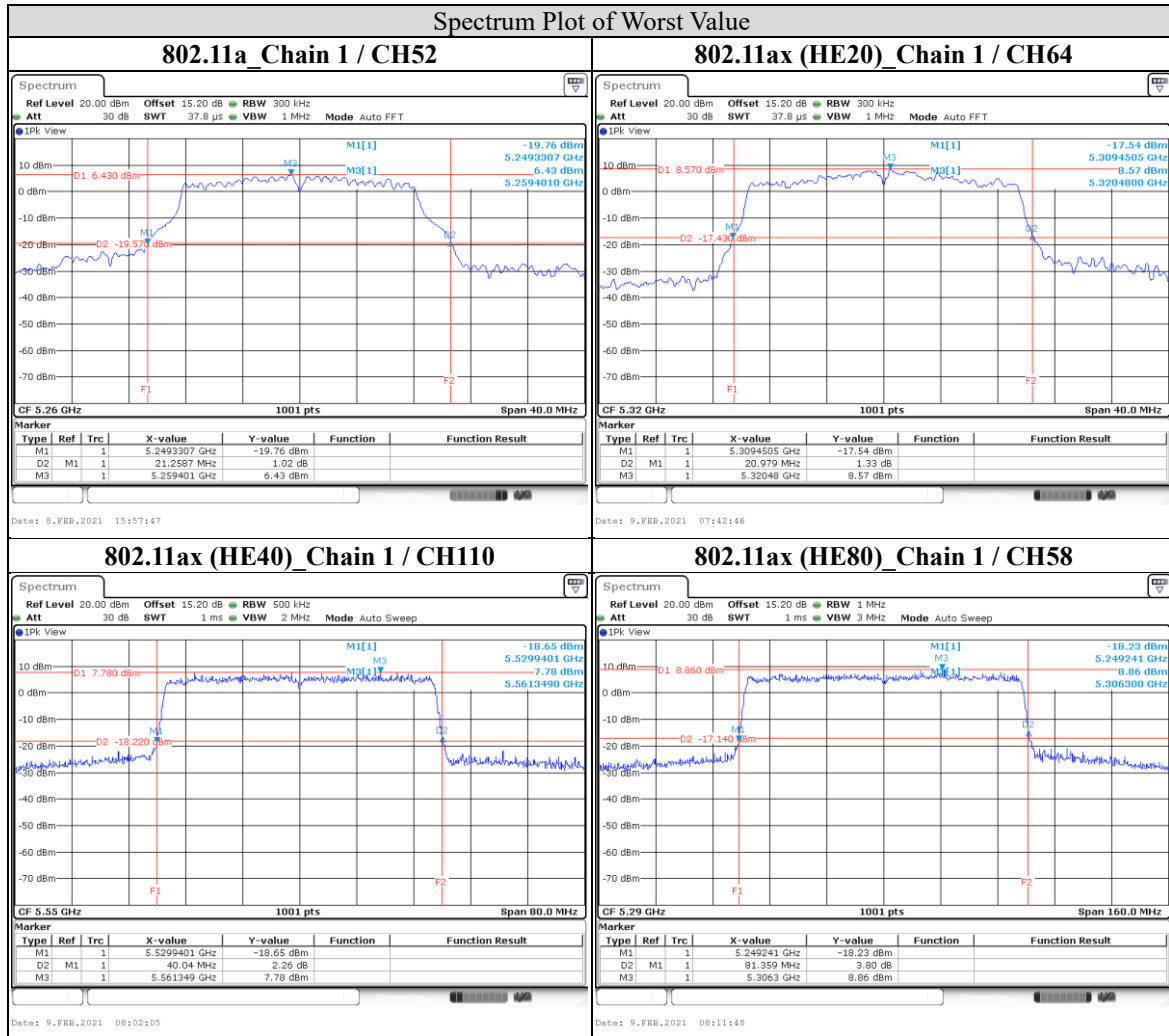

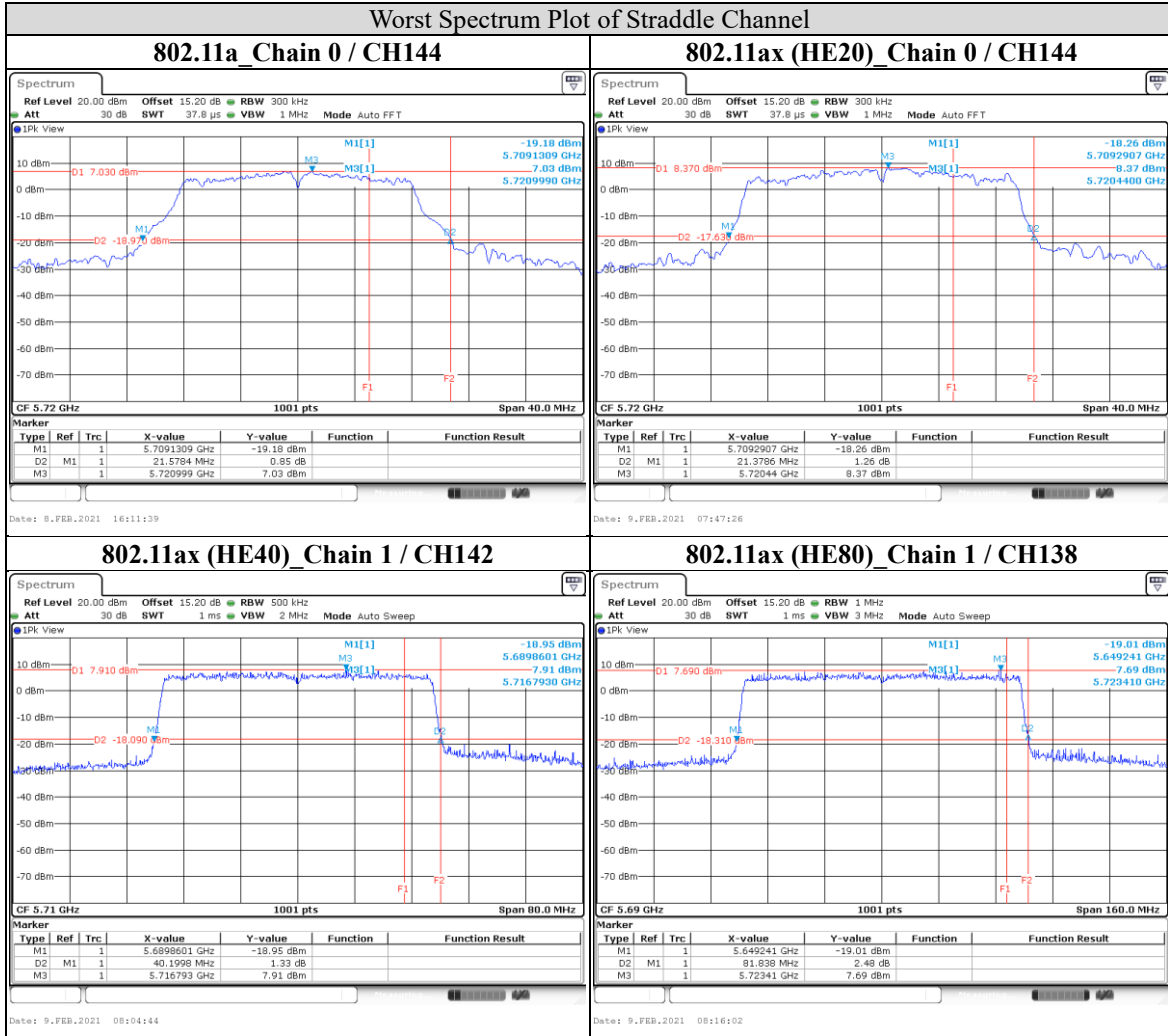

Note: The bandwidth below 5725MHz = Delta 2 – (Marker 1 + Delta 2 – 5725MHz)



OFDMA

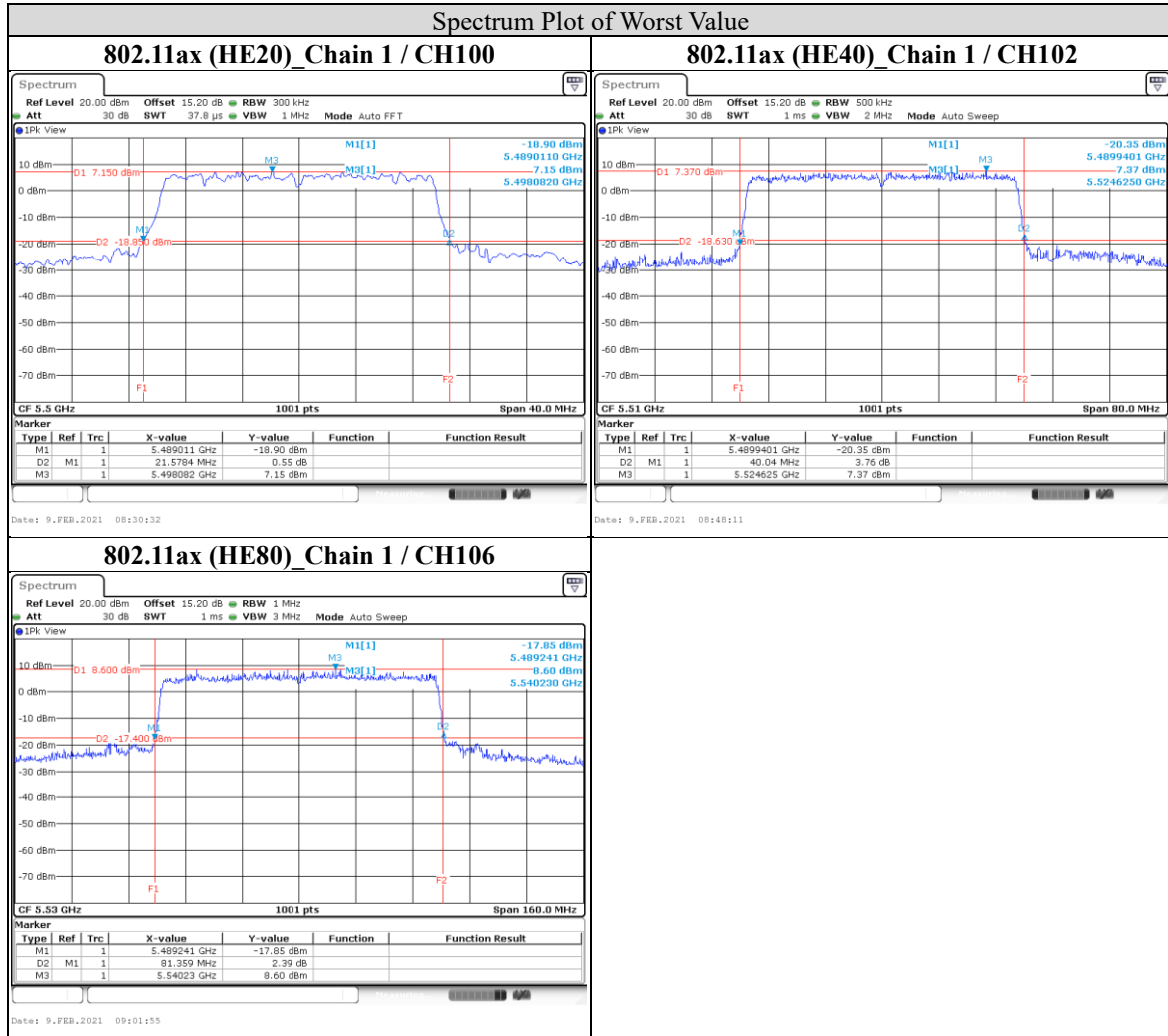

Underwriters Laboratories Taiwan Co., Ltd.

Building B and Building E, No. 372-7, Sec. 4, Zhongxing Rd., Zhudong Township, Hsinchu County, Taiwan

Telephone : +886-2-7737-3000

Facsimile (FAX) : +886-3-583-7948

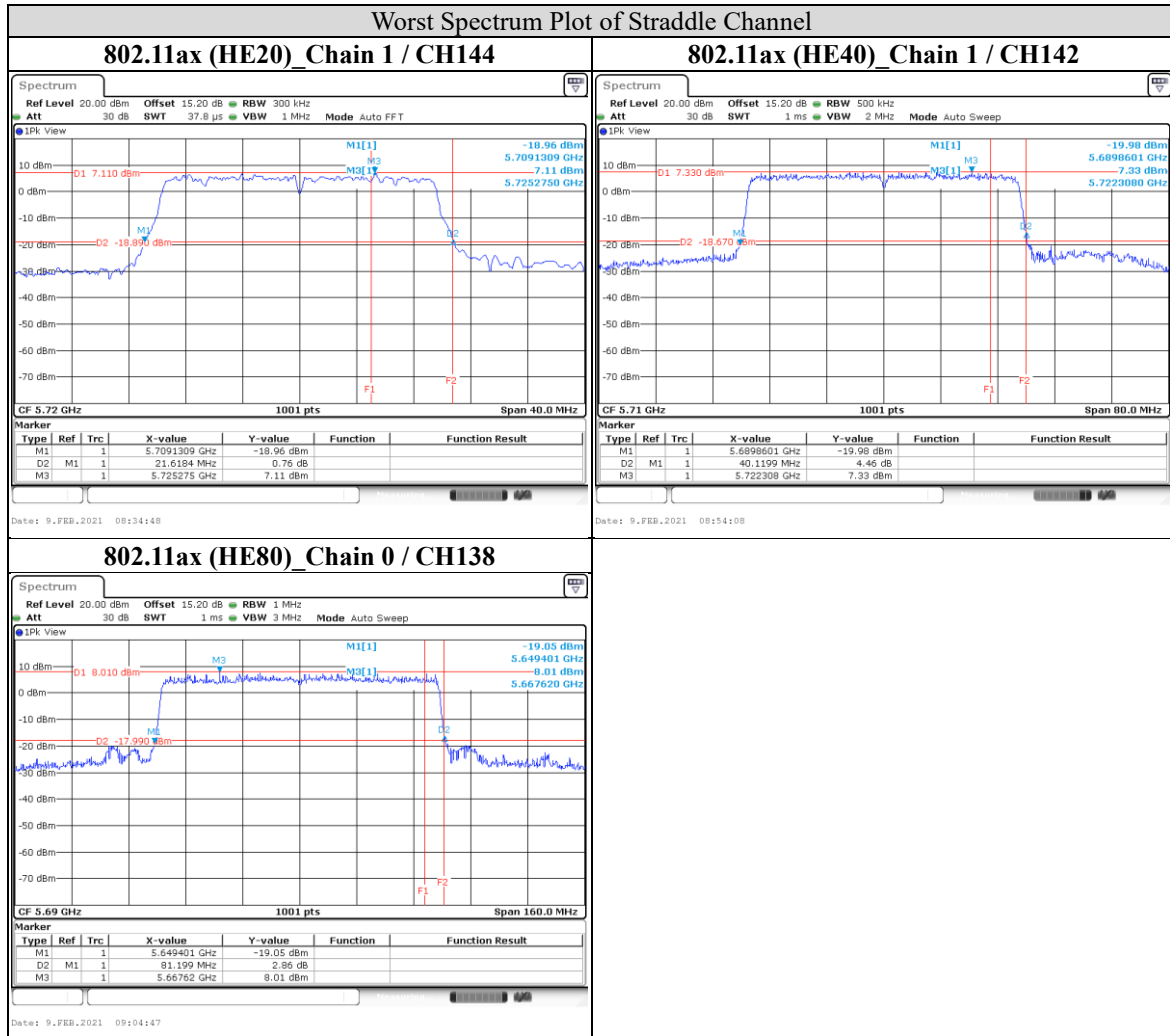

Note: The bandwidth below 5725MHz = Delta 2 – (Marker 1 + Delta 2 – 5725MHz)



Beamforming mode

OFDM

802.11ax (HE20)

Channel	Frequency (MHz)	26 dB Bandwidth (MHz)	
		Chain 0	Chain 1
36	5180	21.22	21.30
44	5220	21.26	21.14
48	5240	21.30	21.46
52	5260	21.38	21.94
60	5300	21.34	21.30
64	5320	21.26	21.14
100	5500	21.54	21.38
116	5580	24.34	21.34
140	5700	21.58	21.22
144	5720	21.10	21.46
144 (U-NII-2c Band)	5720	15.59	15.95

802.11ax (HE40)

Channel	Frequency (MHz)	26 dB Bandwidth (MHz)	
		Chain 0	Chain 1
38	5190	40.20	40.12
46	5230	40.52	40.12
54	5270	40.36	40.12
62	5310	40.36	40.12
102	5510	40.60	39.96
110	5550	40.36	40.04
134	5670	40.60	40.12
142	5710	42.12	40.12
142 (U-NII-2c Band)	5710	35.14	35.14

Underwriters Laboratories Taiwan Co., Ltd.

Building B and Building E, No. 372-7, Sec. 4, Zhongxing Rd., Zhudong Township, Hsinchu County, Taiwan

Telephone :+886-2-7737-3000

Facsimile (FAX) :+886-3-583-7948

Doc No: 17-EM-F0878 / 5.0



802.11ax (HE80)

Channel	Frequency (MHz)	26 dB Bandwidth (MHz)	
		Chain 0	Chain 1
42	5210	82.80	82.00
58	5290	82.00	81.52
106	5530	82.16	81.52
122	5610	81.68	81.52
138	5690	82.16	81.84
138 (U-NII-2c Band)	5690	76.40	75.92

Underwriters Laboratories Taiwan Co., Ltd.

Building B and Building E, No. 372-7, Sec. 4, Zhongxing Rd., Zhudong Township, Hsinchu County, Taiwan

Telephone : +886-2-7737-3000

Facsimile (FAX) : +886-3-583-7948

Doc No: 17-EM-F0878 / 5.0



OFDMA

802.11ax (HE20)

Channel	Frequency (MHz)	26 dB Bandwidth (MHz)	
		Chain 0	Chain 1
36	5180	21.90	21.62
44	5220	21.94	21.70
48	5240	22.10	24.70
52	5260	21.82	21.54
60	5300	22.06	21.62
64	5320	21.42	21.98
100	5500	22.06	21.78
116	5580	22.62	21.50
140	5700	21.74	21.70
144	5720	21.66	21.66
144 (U-NII-2c Band)	5720	15.87	15.91

802.11ax (HE40)

Channel	Frequency (MHz)	26 dB Bandwidth (MHz)	
		Chain 0	Chain 1
38	5190	40.36	40.28
46	5230	40.44	40.20
54	5270	40.44	40.12
62	5310	40.76	40.12
102	5510	40.36	40.04
110	5550	40.60	40.52
134	5670	42.20	40.20
142	5710	40.92	40.44
142 (U-NII-2c Band)	5710	35.22	35.06

Underwriters Laboratories Taiwan Co., Ltd.

Building B and Building E, No. 372-7, Sec. 4, Zhongxing Rd., Zhudong Township, Hsinchu County, Taiwan

Telephone :+886-2-7737-3000

Facsimile (FAX) :+886-3-583-7948

Doc No: 17-EM-F0878 / 5.0



802.11ax (HE80)

Channel	Frequency (MHz)	26 dB Bandwidth (MHz)	
		Chain 0	Chain 1
42	5210	82.00	82.00
58	5290	81.84	81.68
106	5530	81.36	82.80
122	5610	81.52	80.88
138	5690	81.20	81.36
138 (U-NII-2c Band)	5690	75.60	75.76

Underwriters Laboratories Taiwan Co., Ltd.

Building B and Building E, No. 372-7, Sec. 4, Zhongxing Rd., Zhudong Township, Hsinchu County, Taiwan

Telephone :+886-2-7737-3000

Facsimile (FAX) :+886-3-583-7948

Doc No: 17-EM-F0878 / 5.0



OFDM

Spectrum Plot of Worst Value

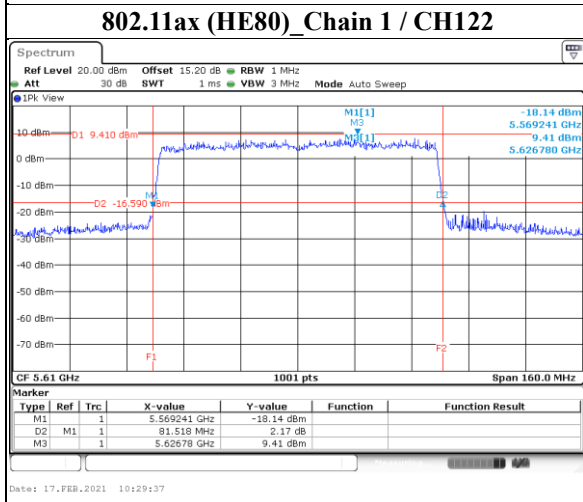
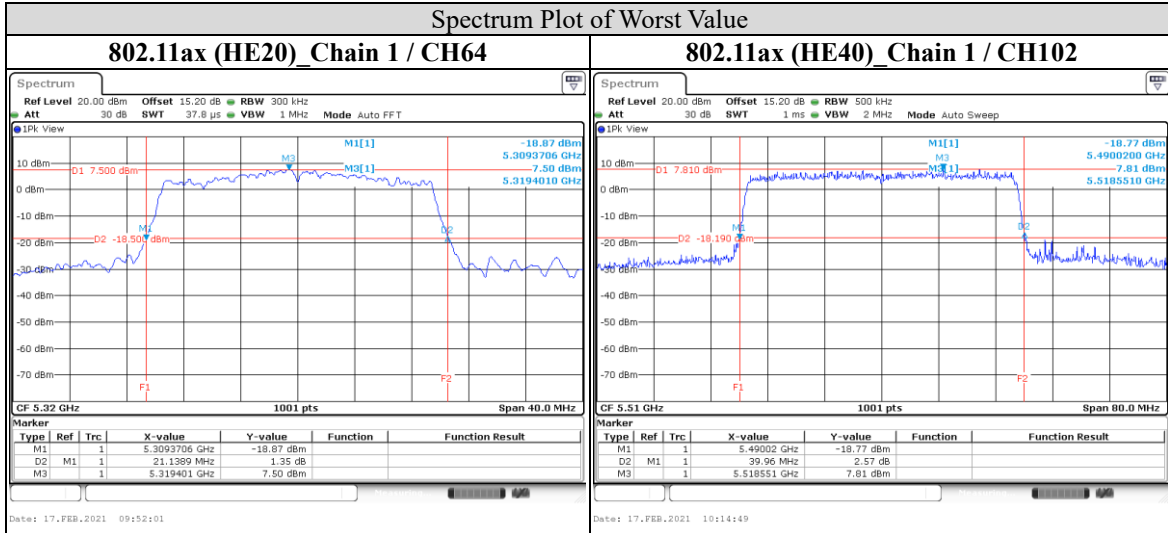

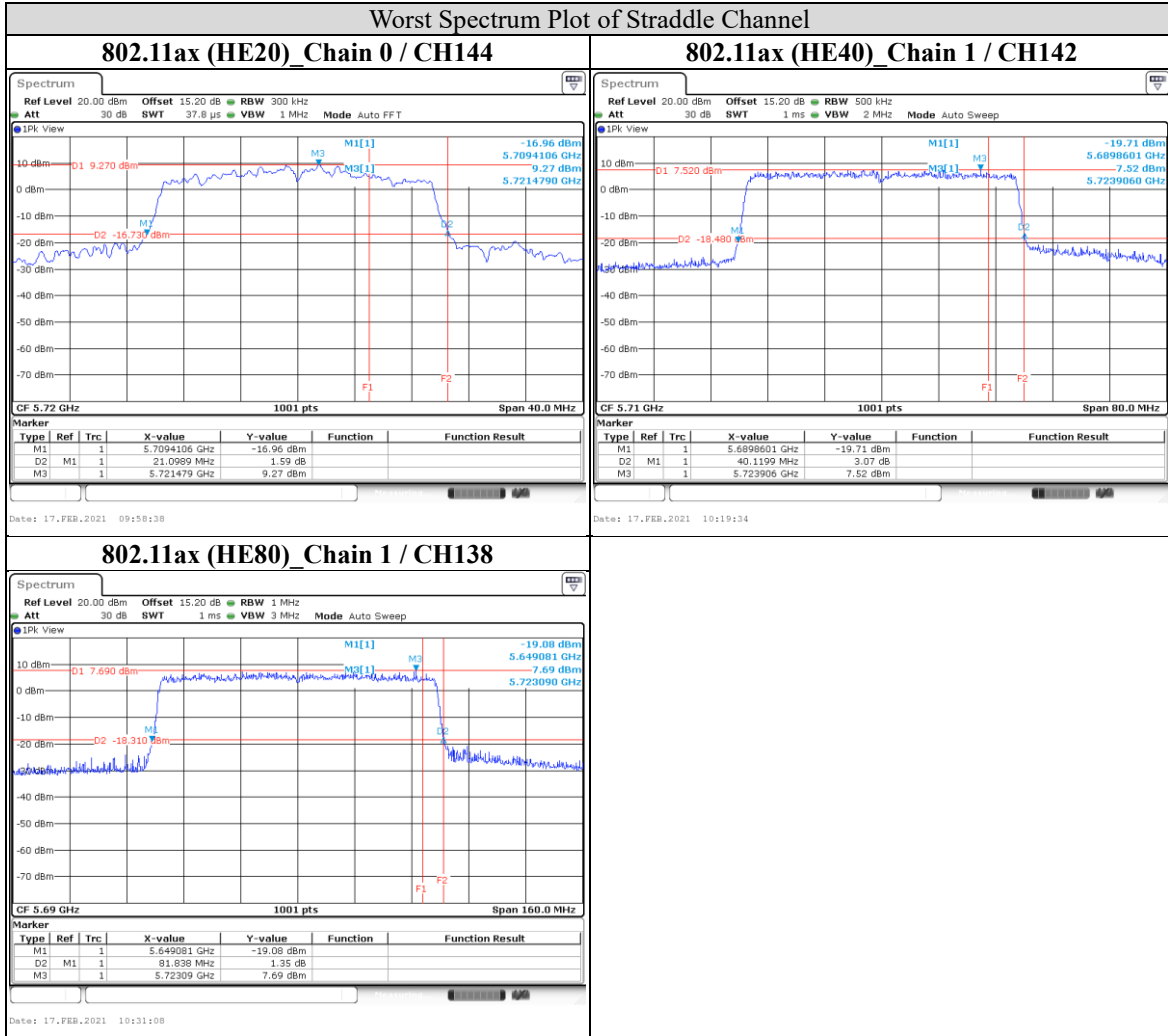

Note: The bandwidth below 5725MHz = Delta 2 – (Marker 1 + Delta 2 – 5725MHz)



OFDMA

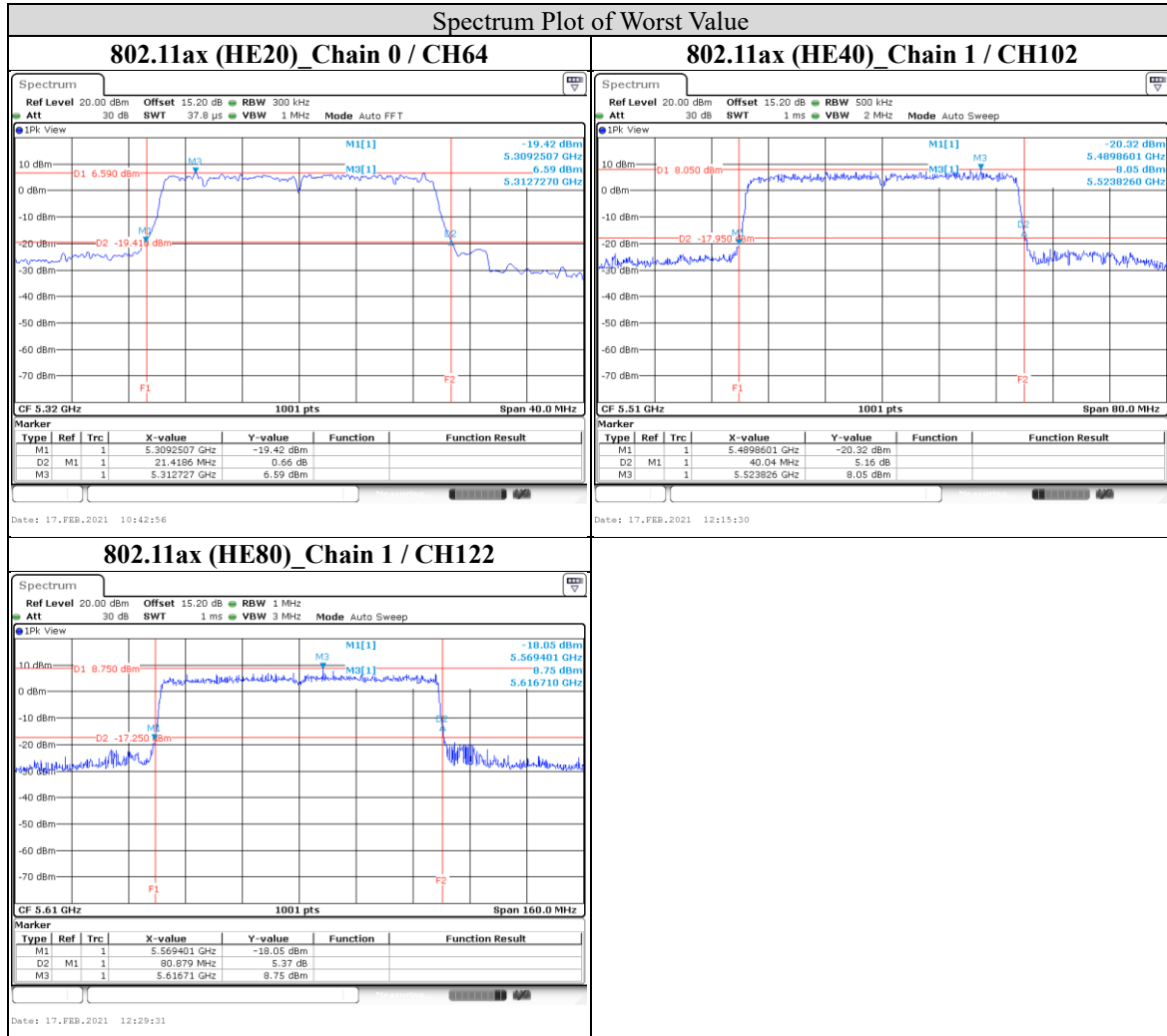

Underwriters Laboratories Taiwan Co., Ltd.

Building B and Building E, No. 372-7, Sec. 4, Zhongxing Rd., Zhudong Township, Hsinchu County, Taiwan

Telephone : +886-2-7737-3000

Facsimile (FAX) : +886-3-583-7948

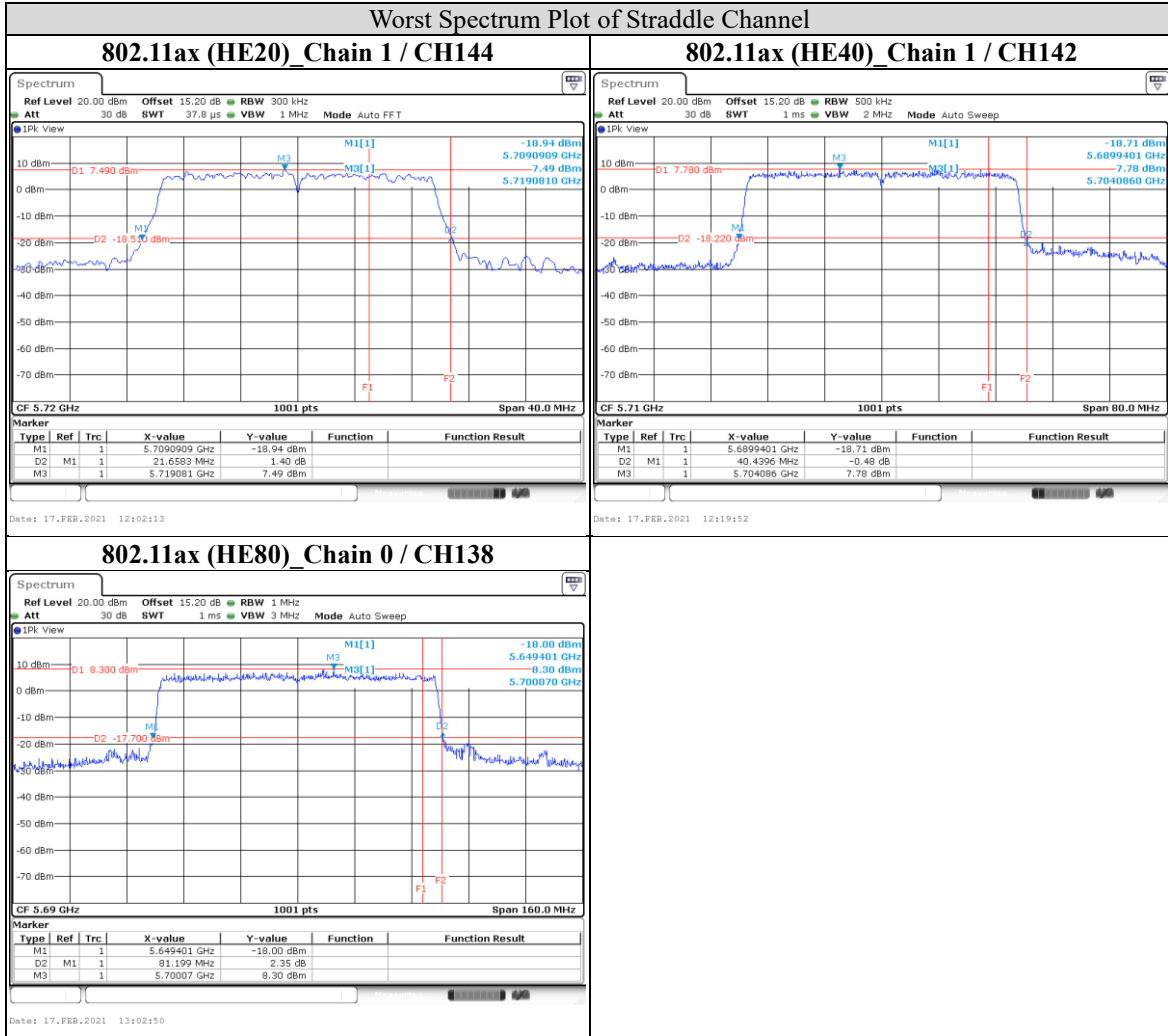

Note: The bandwidth below 5725MHz = Delta 2 – (Marker 1 + Delta 2 – 5725MHz)



9.3. Occupied Bandwidth

Test procedure

- a. Set center frequency to the nominal EUT channel center frequency.
- b. Set span = 1.5 times to 5.0 times the OBW.
- c. Set RBW = 1% to 5% of the OBW
- d. Set VBW $\geq 3 \times$ RBW
- e. Video averaging is not permitted. Where practical, a sample detection and single sweep mode shall be used. Otherwise, peak detection and max hold mode (until the trace stabilizes) shall be used.
- f. Use the 99% power bandwidth function of the instrument (if available).
- g. If the instrument does not have a 99% power bandwidth function, the trace data points are recovered and directly summed in power units. The recovered amplitude data points, beginning at the lowest frequency, are placed in a running sum until 0.5% of the total is reached; that frequency is recorded as the lower frequency. The process is repeated until 99.5% of the total is reached; that frequency is recorded as the upper frequency. The 99% occupied bandwidth is the difference between these two frequencies.

Test Setup

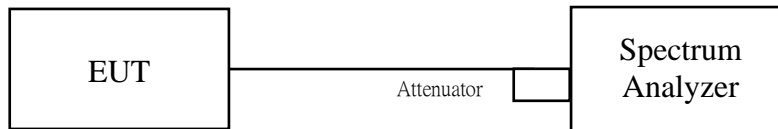

The loss between RF output port of the EUT and the input port of the Spectrum Analyzer has been taken into consideration.



Test Data

Non-Beamforming mode

802.11a

Channel	Frequency (MHz)	Occupied Bandwidth (MHz)	
		Chain 0	Chain 1
36	5180	16.86	16.70
44	5220	17.78	17.02
48	5240	16.90	16.78
52	5260	16.82	16.86
60	5300	16.98	16.78
64	5320	18.14	17.06
100	5500	16.86	16.74
116	5580	17.38	16.70
140	5700	17.42	16.74
144	5720	16.90	16.74
149	5745	17.22	16.74
157	5785	16.90	16.82
165	5825	17.38	17.06

Underwriters Laboratories Taiwan Co., Ltd.

Building B and Building E, No. 372-7, Sec. 4, Zhongxing Rd., Zhudong Township, Hsinchu County, Taiwan

Telephone :+886-2-7737-3000

Facsimile (FAX) :+886-3-583-7948

Doc No: 17-EM-F0878 / 5.0



OFDM

802.11ax (HE20)

Channel	Frequency (MHz)	Occupied Bandwidth (MHz)	
		Chain 0	Chain 1
36	5180	18.98	18.90
44	5220	18.90	19.10
48	5240	18.98	19.02
52	5260	18.94	18.98
60	5300	19.02	18.98
64	5320	18.98	18.98
100	5500	19.02	18.94
116	5580	19.10	18.98
140	5700	19.02	18.94
144	5720	18.98	19.06
149	5745	18.98	19.06
157	5785	18.94	18.98
165	5825	18.98	18.98

802.11ax (HE40)

Channel	Frequency (MHz)	Occupied Bandwidth (MHz)	
		Chain 0	Chain 1
38	5190	37.72	37.72
46	5230	37.64	37.64
54	5270	37.56	37.64
62	5310	37.72	37.64
102	5510	37.64	37.64
110	5550	37.64	37.64
134	5670	37.72	37.72
142	5710	37.72	37.64
151	5755	37.64	37.64
159	5795	37.56	37.56

Underwriters Laboratories Taiwan Co., Ltd.

Building B and Building E, No. 372-7, Sec. 4, Zhongxing Rd., Zhudong Township, Hsinchu County, Taiwan

Telephone :+886-2-7737-3000

Facsimile (FAX) :+886-3-583-7948

Doc No: 17-EM-F0878 / 5.0



802.11ax (HE80)

Channel	Frequency (MHz)	Occupied Bandwidth (MHz)	
		Chain 0	Chain 1
42	5210	77.36	77.36
58	5290	77.36	77.36
106	5530	77.36	77.20
122	5610	77.20	77.20
138	5690	77.68	77.20
155	5775	77.20	77.36

Underwriters Laboratories Taiwan Co., Ltd.

Building B and Building E, No. 372-7, Sec. 4, Zhongxing Rd., Zhudong Township, Hsinchu County, Taiwan

Telephone :+886-2-7737-3000

Facsimile (FAX) :+886-3-583-7948

Doc No: 17-EM-F0878 / 5.0



OFDMA

802.11ax (HE20)

Channel	Frequency (MHz)	Occupied Bandwidth (MHz)	
		Chain 0	Chain 1
36	5180	19.14	19.06
44	5220	19.06	19.14
48	5240	19.10	19.22
52	5260	19.14	19.22
60	5300	19.18	19.14
64	5320	19.34	19.14
100	5500	19.18	19.14
116	5580	19.14	19.14
140	5700	19.22	19.14
144	5720	19.14	19.14
149	5745	19.14	19.10
157	5785	19.10	19.26
165	5825	19.30	19.22

802.11ax (HE40)

Channel	Frequency (MHz)	Occupied Bandwidth (MHz)	
		Chain 0	Chain 1
38	5190	37.64	37.64
46	5230	37.64	37.64
54	5270	37.64	37.64
62	5310	37.72	37.64
102	5510	37.72	37.64
110	5550	37.72	37.64
134	5670	37.64	37.64
142	5710	37.64	37.64
151	5755	37.64	37.96
159	5795	37.64	37.56

Underwriters Laboratories Taiwan Co., Ltd.

Building B and Building E, No. 372-7, Sec. 4, Zhongxing Rd., Zhudong Township, Hsinchu County, Taiwan

Telephone :+886-2-7737-3000

Facsimile (FAX) :+886-3-583-7948

Doc No: 17-EM-F0878 / 5.0



802.11ax (HE80)

Channel	Frequency (MHz)	Occupied Bandwidth (MHz)	
		Chain 0	Chain 1
42	5210	77.52	77.20
58	5290	77.20	77.04
106	5530	77.36	77.20
122	5610	77.20	77.20
138	5690	77.68	77.20
155	5775	77.20	77.52

Underwriters Laboratories Taiwan Co., Ltd.

Building B and Building E, No. 372-7, Sec. 4, Zhongxing Rd., Zhudong Township, Hsinchu County, Taiwan

Telephone :+886-2-7737-3000

Facsimile (FAX) :+886-3-583-7948

Doc No: 17-EM-F0878 / 5.0



OFDM

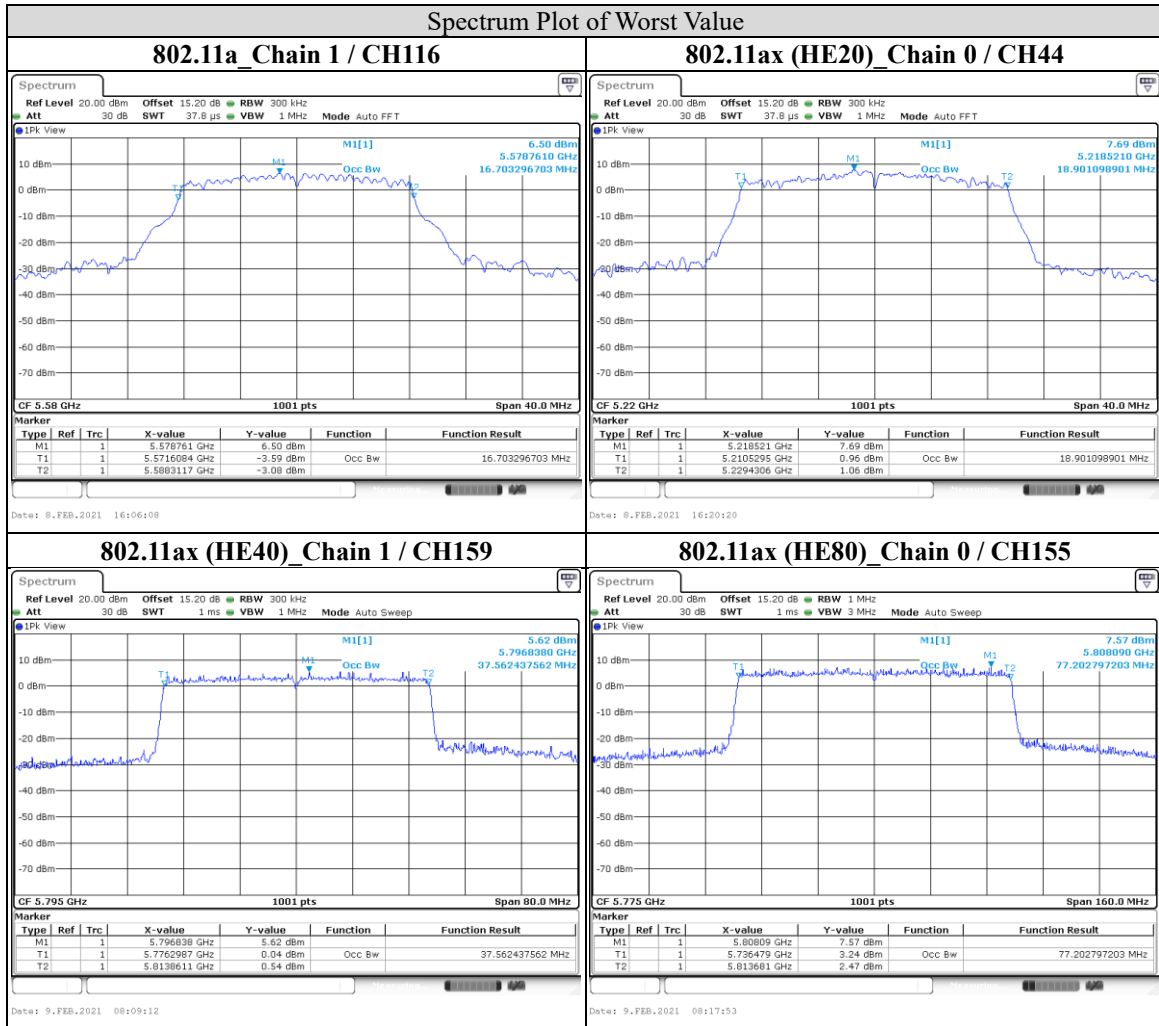

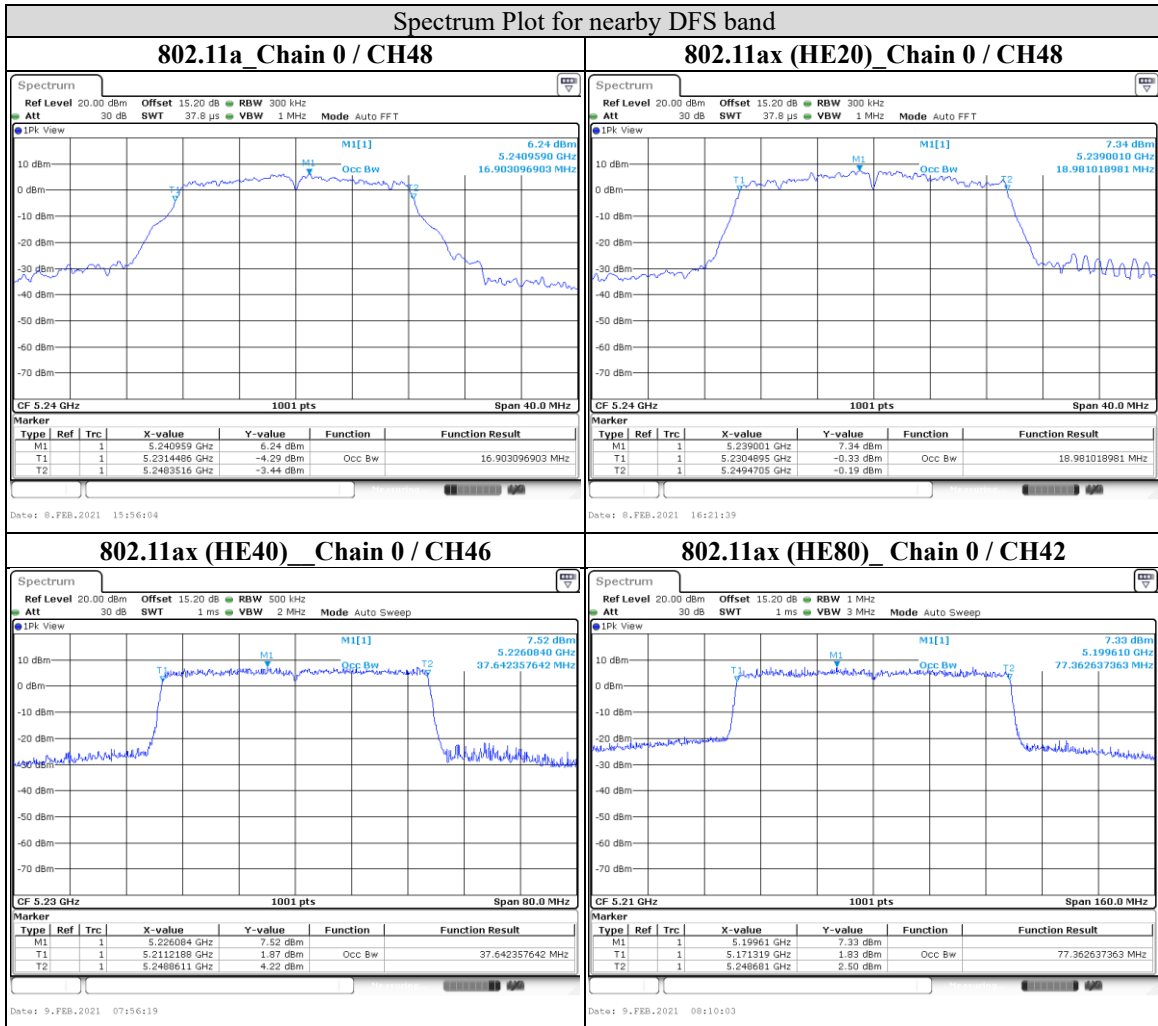

Note: The observed T2 is all <5250 MHz, so in nearby DFS band channels no need for DFS function

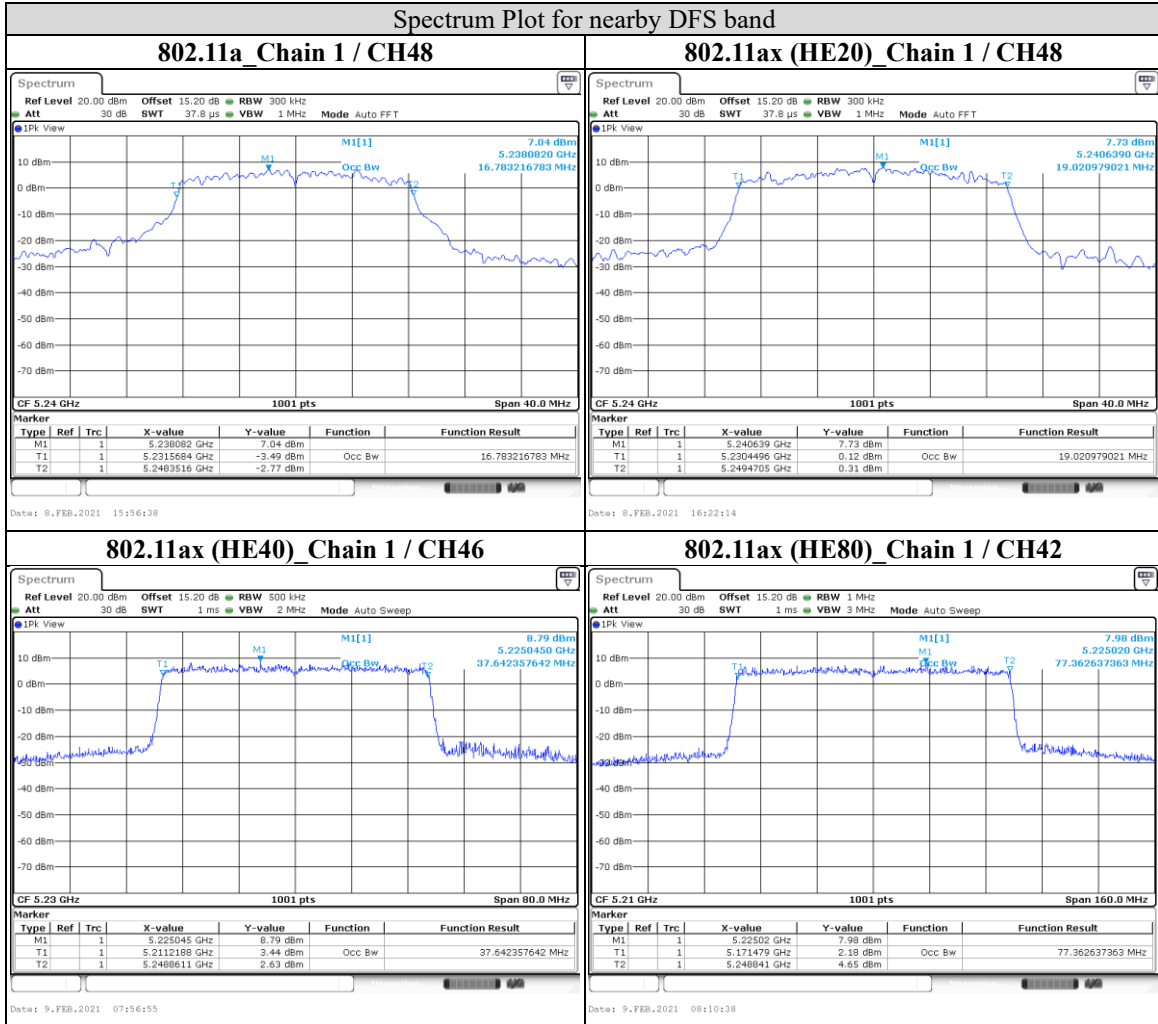

Note: The observed T2 is all <5250 MHz, so in nearby DFS band channels no need for DFS function



OFDMA

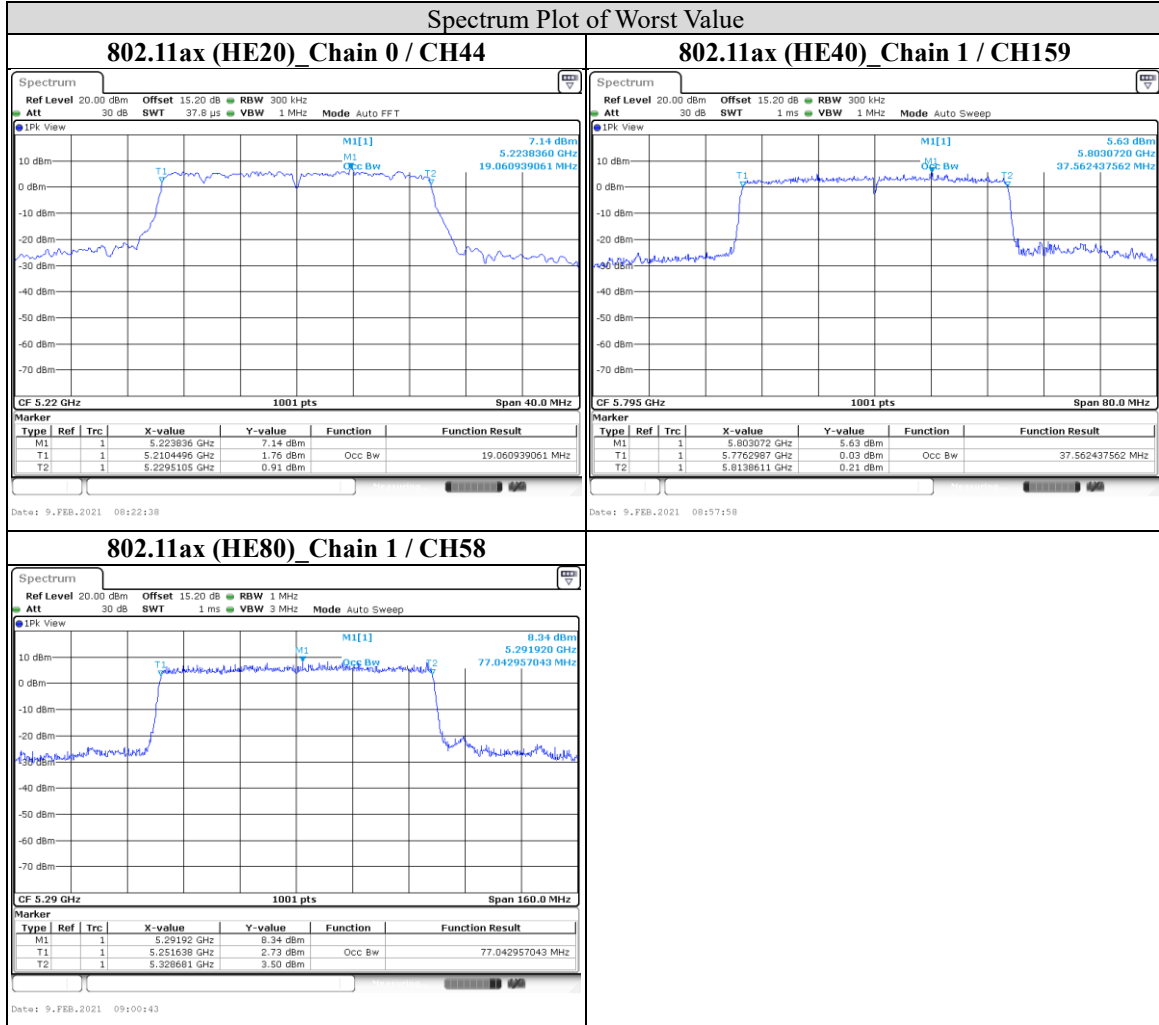

Underwriters Laboratories Taiwan Co., Ltd.

Building B and Building E, No. 372-7, Sec. 4, Zhongxing Rd., Zhudong Township, Hsinchu County, Taiwan

Telephone :+886-2-7737-3000

Facsimile (FAX) :+886-3-583-7948

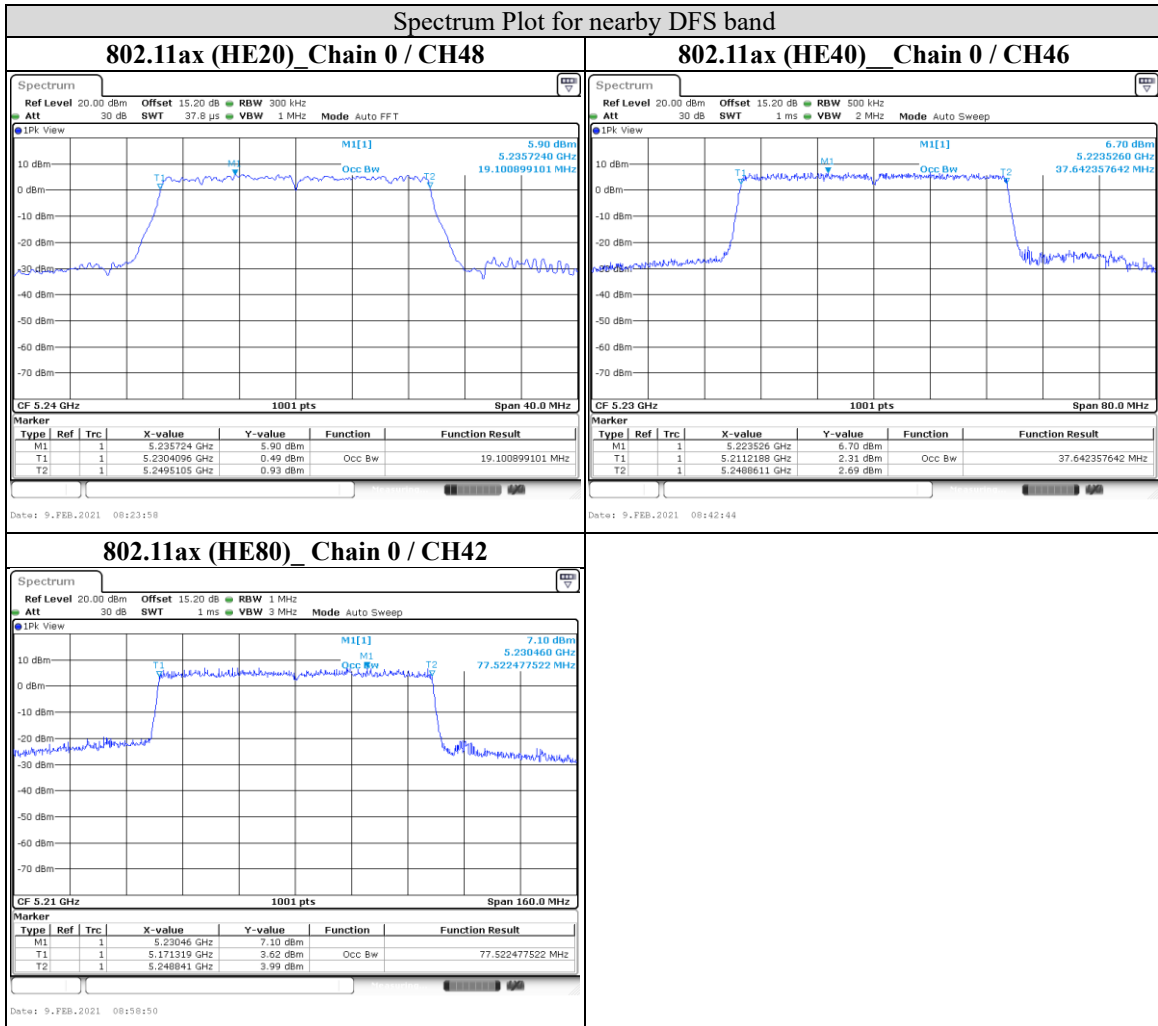

Note: The observed T2 is all <5250 MHz, so in nearby DFS band channels no need for DFS function

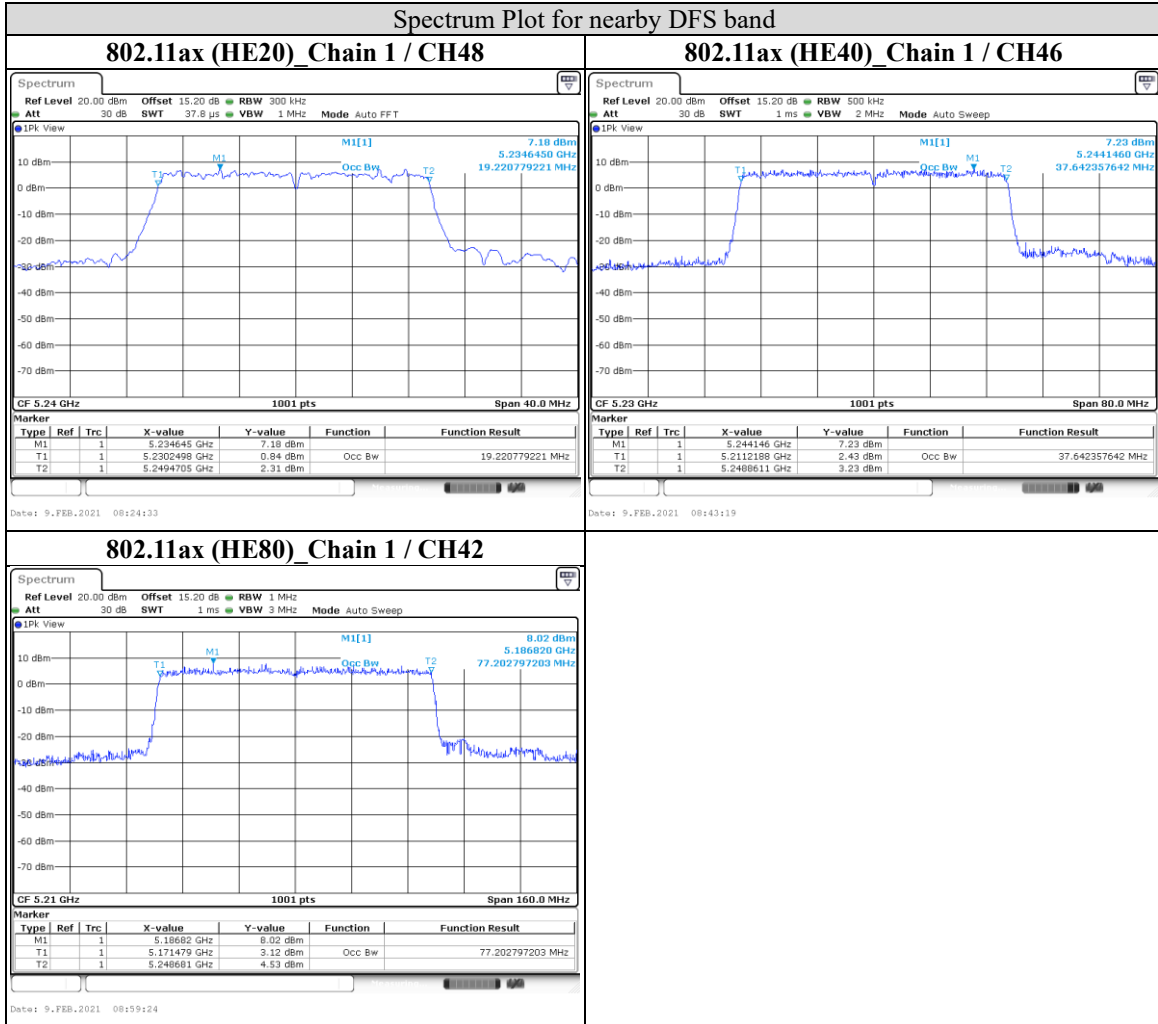

Note: The observed T2 is all <5250 MHz, so in nearby DFS band channels no need for DFS function