



A D T

# FCC TEST REPORT

**REPORT NO.:** RF990714C01

**MODEL NO.:** WMIR-269GN

**FCC ID:** RYK-WMIR269GN

**RECEIVED:** Jul. 14, 2010

**TESTED:** Jul. 28 ~ Aug. 02, 2010

**ISSUED:** Aug. 06, 2010

**APPLICANT:** SparkLAN Communications, Inc.

**ADDRESS:** 8F., No.257, Sec. 2, Tiding Blvd., Neihu District,  
Taipei City 11493, Taiwan (R.O.C.)

**ISSUED BY:** Bureau Veritas Consumer Products Services (H.K.)  
Ltd., Taoyuan Branch

**LAB ADDRESS:** No. 47, 14th Ling, Chia Pau Tsuen, Lin Kou Hsiang,  
Taipei Hsien 244, Taiwan, R.O.C.

**TEST LOCATION:** No. 19, Hwa Ya 2nd Rd, Wen Hwa Tsuen, Kwei  
Shan Hsiang, Taoyuan Hsien 333, Taiwan, R.O.C.

This test report consists of 68 pages in total. It may be duplicated completely for legal use with the approval of the applicant. It should not be reproduced except in full, without the written approval of our laboratory. The client should not use it to claim product, certification, approval or endorsement by TAF or any government agency. The test results in the report only apply to the tested sample. The test results in this report are traceable to the national or international standards.





A D T

## TABLE OF CONTENTS

1.	CERTIFICATION.....	4
2.	SUMMARY OF TEST RESULTS .....	5
2.1	MEASUREMENT UNCERTAINTY.....	5
3.	GENERAL INFORMATION.....	6
3.1	GENERAL DESCRIPTION OF EUT .....	6
3.2	DESCRIPTION OF TEST MODES .....	7
3.2.1	CONFIGURATION OF SYSTEM UNDER TEST .....	7
3.2.2	TEST MODE APPLICABILITY AND TESTED CHANNEL DETAIL .....	8
3.3	GENERAL DESCRIPTION OF APPLIED STANDARDS .....	10
3.4	DESCRIPTION OF SUPPORT UNITS .....	10
4.	TEST TYPES AND RESULTS .....	11
4.1	RADIATED EMISSION MEASUREMENT .....	11
4.1.1	LIMITS OF RADIATED EMISSION MEASUREMENT.....	11
4.1.2	TEST INSTRUMENTS.....	12
4.1.3	TEST PROCEDURES .....	13
4.1.4	DEVIATION FROM TEST STANDARD.....	13
4.1.5	TEST SETUP.....	14
4.1.6	EUT OPERATING CONDITIONS .....	14
4.1.7	TEST RESULTS .....	15
4.2	CONDUCTED EMISSION MEASUREMENT .....	28
4.2.1	LIMITS OF CONDUCTED EMISSION MEASUREMENT.....	28
4.2.2	TEST INSTRUMENTS.....	28
4.2.3	TEST PROCEDURES .....	29
4.2.4	DEVIATION FROM TEST STANDARD.....	29
4.2.5	TEST SETUP.....	30
4.2.6	EUT OPERATING CONDITIONS .....	30
4.2.7	TEST RESULTS .....	31
4.3	6dB BANDWIDTH MEASUREMENT.....	33
4.3.1	LIMITS OF 6DB BANDWIDTH MEASUREMENT .....	33
4.3.2	TEST INSTRUMENTS.....	33
4.3.3	TEST PROCEDURE.....	33
4.3.4	DEVIATION FROM TEST STANDARD.....	33
4.3.5	TEST SETUP.....	34
4.3.6	EUT OPERATING CONDITIONS .....	34



A D T

4.3.7	TEST RESULTS .....	35
4.4	MAXIMUM OUTPUT POWER .....	39
4.4.1	LIMITS OF MAXIMUM OUTPUT POWER MEASUREMENT .....	39
4.4.2	INSTRUMENTS .....	39
4.4.3	TEST PROCEDURES .....	39
4.4.4	DEVIATION FROM TEST STANDARD .....	40
4.4.5	TEST SETUP .....	40
4.4.6	EUT OPERATING CONDITIONS .....	40
4.4.7	TEST RESULTS .....	41
4.5	POWER SPECTRAL DENSITY MEASUREMENT .....	42
4.5.1	LIMITS OF POWER SPECTRAL DENSITY MEASUREMENT .....	42
4.5.2	TEST INSTRUMENTS .....	42
4.5.3	TEST PROCEDURE .....	42
4.5.4	DEVIATION FROM TEST STANDARD .....	43
4.5.5	TEST SETUP .....	43
4.5.6	EUT OPERATING CONDITION .....	43
4.5.7	TEST RESULTS .....	44
4.6	BAND EDGES MEASUREMENT .....	48
4.6.1	LIMITS OF BAND EDGES MEASUREMENT .....	48
4.6.2	TEST INSTRUMENTS .....	48
4.6.3	TEST PROCEDURE .....	49
4.6.4	DEVIATION FROM TEST STANDARD .....	49
4.6.5	EUT OPERATING CONDITION .....	49
4.6.6	TEST RESULTS .....	50
5.	PHOTOGRAPHS OF THE TEST CONFIGURATION .....	66
6.	INFORMATION ON THE TESTING LABORATORIES .....	67
7.	APPENDIX A - MODIFICATIONS RECORDERS FOR ENGINEERING CHANGES TO THE EUT BY THE LAB .....	68



A D T

## 1. CERTIFICATION

**PRODUCT:** 11gn mini-PCI card

**MODEL:** WMIR-269GN

**BRAND:** SparkLAN

**APPLICANT:** SparkLAN Communications, Inc.

**TEST SAMPLE:** ENGINEERING SAMPLE

**TESTED:** Jul. 28 ~ Aug. 02, 2010

**STANDARDS:** FCC Part 15, Subpart C (Section 15.247)

ANSI C63.4-2003

The above equipment (Model: WMIR-269GN) has been tested by **Bureau Veritas Consumer Products Services (H.K.) Ltd., Taoyuan Branch**, and found compliance with the requirement of the above standards. The test record, data evaluation & Equipment Under Test (EUT) configurations represented herein are true and accurate accounts of the measurements of the sample's EMC characteristics under the conditions specified in this report.

**PREPARED BY** : Ivy Lin , **DATE:** Aug. 06, 2010  
Ivy Lin / Specialist

**TECHNICAL ACCEPTANCE** : Long Chen , **DATE:** Aug. 06, 2010  
Responsible for RF Long Chen / Senior Engineer

**APPROVED BY** : Gary Chang , **DATE:** Aug. 06, 2010  
Gary Chang / Assistant Manager

## 2. SUMMARY OF TEST RESULTS

The EUT has been tested according to the following specifications:

APPLIED STANDARD: FCC PART 15, SUBPART C (SECTION 15.247)			
STANDARD SECTION	TEST TYPE AND LIMIT	RESULT	REMARK
15.207	AC Power Conducted Emission	PASS	Meet the requirement of limit. Minimum passing margin is -12.03dB at 0.310MHz.
15.247(a)(2)	Spectrum Bandwidth of a Direct Sequence Spread Spectrum System Limit: min. 500kHz	PASS	Meet the requirement of limit.
15.247(b)	Maximum Output Power Limit: max. 30dBm	PASS	Meet the requirement of limit.
15.247(d)	Radiated Emissions Limit: Table 15.209	PASS	Meet the requirement of limit. Minimum passing margin is -1.0dB at 166.20, 2386.00 & 7311.00MHz.
15.247(e)	Power Spectral Density Limit: max. 8dBm	PASS	Meet the requirement of limit.
15.247(d)	Band Edge Measurement Limit: 20dB less than the peak value of fundamental frequency	PASS	Meet the requirement of limit.
15.203	Antenna Requirement	PASS	Antenna connector is UFL not a standard connector.

### 2.1 MEASUREMENT UNCERTAINTY

Where relevant, the following measurement uncertainty levels have been estimated for tests performed on the EUT as specified in CISPR 16-4-2:

MEASUREMENT	FREQUENCY	UNCERTAINTY
Conducted emissions	150kHz~30MHz	2.44dB
Radiated emissions	30MHz ~ 200MHz	3.19 dB
	200MHz ~1000MHz	3.21 dB
	1GHz ~ 18GHz	2.26 dB
	18GHz ~ 40GHz	1.94 dB

This uncertainty represents an expanded uncertainty expressed at approximately the 95% confidence level using a coverage factor of  $k = 2$ .



A D T

### 3. GENERAL INFORMATION

#### 3.1 GENERAL DESCRIPTION OF EUT

<b>EUT</b>	11gn mini-PCI card
<b>MODEL NO.</b>	WMIR-269GN
<b>FCC ID</b>	RYK-WMIR269GN
<b>POWER SUPPLY</b>	3.3Vdc
<b>MODULATION TYPE</b>	CCK, DQPSK, DBPSK for DSSS 64QAM, 16QAM, QPSK, BPSK for OFDM
<b>MODULATION TECHNOLOGY</b>	DSSS, OFDM
<b>TRANSFER RATE</b>	802.11b: 11.0/ 5.5/ 2.0/ 1.0Mbps 802.11g: 54.0/ 48.0/ 36.0/ 24.0/ 18.0/ 12.0/ 9.0/ 6.0Mbps 802.11n: up to 300.0Mbps
<b>OPERATING FREQUENCY</b>	2412 ~ 2462MHz
<b>NUMBER OF CHANNEL</b>	11 for 802.11b, 802.11g, 802.11n (20MHz) 7 for 802.11n (40MHz)
<b>OUTPUT POWER</b>	376.8mW
<b>ANTENNA TYPE</b>	Dipole antenna with 2.0dBi gain
<b>ANTENNA CONNECTOR</b>	UFL
<b>DATA CABLE</b>	NA
<b>I/O PORTS</b>	NA
<b>ACCESSORY DEVICES</b>	NA

**NOTE:**

1. The EUT incorporates a MIMO function. Physically, the EUT provides two completed transmitters and two receivers.

<b>MODULATION MODE</b>	<b>TX FUNCTION</b>
<b>802.11b</b>	1TX
<b>802.11g</b>	1TX
<b>802.11n (20MHz)</b>	2TX
<b>802.11n (40MHz)</b>	2TX

2. The above EUT information was declared by manufacturer and for more detailed features description, please refer to the manufacturer's specifications or user's manual.

### 3.2 DESCRIPTION OF TEST MODES

11 channels are provided for 802.11b, 802.11g and 802.11n (20MHz):

CHANNEL	FREQUENCY	CHANNEL	FREQUENCY
1	2412MHz	7	2442MHz
2	2417MHz	8	2447MHz
3	2422MHz	9	2452MHz
4	2427MHz	10	2457MHz
5	2432MHz	11	2462MHz
6	2437MHz		

7 channels are provided for 802.11n (40MHz):

CHANNEL	FREQUENCY	CHANNEL	FREQUENCY
1	2422MHz	5	2442MHz
2	2427MHz	6	2447MHz
3	2432MHz	7	2452MHz
4	2437MHz		

#### 3.2.1 CONFIGURATION OF SYSTEM UNDER TEST

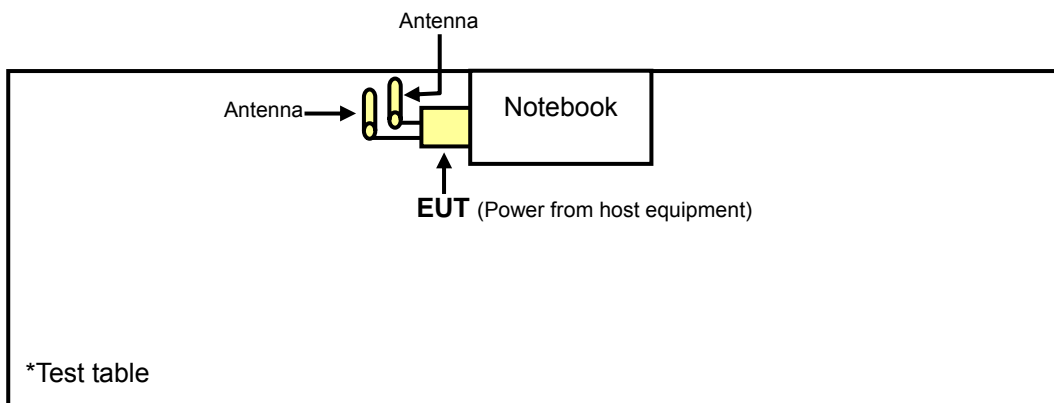



### 3.2.2 TEST MODE APPLICABILITY AND TESTED CHANNEL DETAIL

EUT CONFIGURE MODE	APPLICABLE TO				DESCRIPTION
	RE≥1G	RE<1G	PLC	APCM	Adapter Model
-	√	√	√	√	-

Where **RE≥1G**: Radiated Emission above 1GHz      **RE<1G**: Radiated Emission below 1GHz  
**PLC**: Power Line Conducted Emission      **APCM**: Antenna Port Conducted Measurement

#### **RADIATED EMISSION TEST (ABOVE 1GHz):**

- Pre-Scan has been conducted to determine the worst-case mode from all possible combinations between available modulations, data rates and antenna ports (if EUT with antenna diversity architecture).
- Following channel(s) was (were) selected for the final test as listed below.

EUT CONFIGURE MODE	MODE	AVAILABLE CHANNEL	TESTED CHANNEL	MODULATION TECHNOLOGY	MODULATION TYPE	DATA RATE (Mbps)
-	802.11b	1 to 11	1, 6, 11	DSSS	DBPSK	1.0
-	802.11g	1 to 11	1, 6, 11	OFDM	BPSK	6.0
-	802.11n (20MHz)	1 to 11	1, 6, 11	OFDM	BPSK	7.2
-	802.11n (40MHz)	1 to 7	1, 4, 7	OFDM	BPSK	15.0

#### **RADIATED EMISSION TEST (BELOW 1GHz):**

- Pre-Scan has been conducted to determine the worst-case mode from all possible combinations between available modulations, data rates antenna ports (if EUT with antenna diversity architecture).
- Following channel(s) was (were) selected for the final test as listed below.

EUT CONFIGURE MODE	MODE	AVAILABLE CHANNEL	TESTED CHANNEL	MODULATION TECHNOLOGY	MODULATION TYPE	DATA RATE (Mbps)
-	802.11n (20MHz)	1 to 11	11	OFDM	BPSK	7.2

#### **POWER LINE CONDUCTED EMISSION TEST:**

- Pre-Scan has been conducted to determine the worst-case mode from all possible combinations between available modulations, data rates and antenna ports (if EUT with antenna diversity architecture).
- Following channel(s) was (were) selected for the final test as listed below.

EUT CONFIGURE MODE	MODE	AVAILABLE CHANNEL	TESTED CHANNEL	MODULATION TECHNOLOGY	MODULATION TYPE	DATA RATE (Mbps)
-	802.11n (20MHz)	1 to 11	11	OFDM	BPSK	7.2





**BANDEDGE MEASUREMENT:**

- Pre-Scan has been conducted to determine the worst-case mode from all possible combinations between available modulations, data rates and antenna ports (if EUT with antenna diversity architecture).
- Following channel(s) was (were) selected for the final test as listed below.

EUT CONFIGURE MODE	MODE	AVAILABLE CHANNEL	TESTED CHANNEL	MODULATION TECHNOLOGY	MODULATION TYPE	DATA RATE (Mbps)
-	802.11b	1 to 11	1, 11	DSSS	DBPSK	1.0
-	802.11g	1 to 11	1, 11	OFDM	BPSK	6.0
-	802.11n (20MHz)	1 to 11	1, 11	OFDM	BPSK	7.2
-	802.11n (40MHz)	1 to 7	1, 7	OFDM	BPSK	15.0

**ANTENNA PORT CONDUCTED MEASUREMENT:**

- This item includes all test value of each mode, but only includes spectrum plot of worst value of each mode.
- Pre-Scan has been conducted to determine the worst-case mode from all possible combinations between available modulations, data rates and antenna ports (if EUT with antenna diversity architecture).
- Following channel(s) was (were) selected for the final test as listed below.

EUT CONFIGURE MODE	MODE	AVAILABLE CHANNEL	TESTED CHANNEL	MODULATION TECHNOLOGY	MODULATION TYPE	DATA RATE (Mbps)
-	802.11b	1 to 11	1, 6, 11	DSSS	DBPSK	1.0
-	802.11g	1 to 11	1, 6, 11	OFDM	BPSK	6.0
-	802.11n (20MHz)	1 to 11	1, 6, 11	OFDM	BPSK	7.2
-	802.11n (40MHz)	1 to 7	1, 4, 7	OFDM	BPSK	15.0

**TEST CONDITION:**

APPLICABLE TO	ENVIRONMENTAL CONDITIONS	INPUT POWER (SYSTEM)	TESTED BY
RE≥1G	28deg. C, 68%RH, 1005 hPa	120Vac, 60Hz	Sun Lin
RE<1G	23deg. C, 68%RH, 1003 hPa	120Vac, 60Hz	Sun Lin
PLC	24deg. C, 62%RH, 1004 hPa	120Vac, 60Hz	Antony Lee
APCM	23deg. C, 66%RH, 1007 hPa	120Vac, 60Hz	Brad Wu



A D T

### 3.3 GENERAL DESCRIPTION OF APPLIED STANDARDS

The EUT is a RF Product. According to the specifications of the manufacturer, it must comply with the requirements of the following standards:

**FCC Part 15, Subpart C (15.247)**

**ANSI C63.4-2003**

All test items have been performed and recorded as per the above standards.

**NOTE:** The EUT is also considered as a kind of computer peripheral, because the connection to computer is necessary for typical use. It has been verified to comply with the requirements of FCC Part 15, Subpart B, Class B (DoC). The test report has been issued separately.

### 3.4 DESCRIPTION OF SUPPORT UNITS

The EUT has been tested as an independent unit together with other necessary accessories or support units. The following support units or accessories were used to form a representative test configuration during the tests.

NO.	PRODUCT	BRAND	MODEL NO.	SERIAL NO.	FCC ID
1	NOTEBOOK	DELL	PP18L	33497605792	CXSMM01BRD02D3 30

NO.	SIGNAL CABLE DESCRIPTION OF THE ABOVE SUPPORT UNITS
1	NA

**NOTE:** All power cords of the above support units are non shielded (1.8m).



## 4. TEST TYPES AND RESULTS

### 4.1 RADIATED EMISSION MEASUREMENT

#### 4.1.1 LIMITS OF RADIATED EMISSION MEASUREMENT

Emissions radiated outside of the specified bands, shall be according to the general radiated limits in 15.209 as following:

FREQUENCIES (MHz)	FIELD STRENGTH (microvolts/meter)	MEASUREMENT DISTANCE (meters)
0.009 ~ 0.490	2400/F(kHz)	300
0.490 ~ 1.705	24000/F(kHz)	30
1.705 ~ 30.0	30	30
30 ~ 88	100	3
88 ~ 216	150	3
216 ~ 960	200	3
Above 960	500	3

**NOTE:**

1. The lower limit shall apply at the transition frequencies.
2. Emission level (dBuV/m) = 20 log Emission level (uV/m).
3. As shown in 15.35(b), for frequencies above 1000MHz, the field strength limits are based on average detector, however, the peak field strength of any emission shall not exceed the maximum permitted average limits, specified above by more than 20dB under any condition of modulation.



A D T

#### 4.1.2 TEST INSTRUMENTS

DESCRIPTION & MANUFACTURER	MODEL NO.	SERIAL NO.	DATE OF CALIBRATION	DUE DATE OF CALIBRATION
Test Receiver ROHDE & SCHWARZ	ESI7	838496/016	Dec. 29, 2009	Dec. 28, 2010
Spectrum Analyzer ROHDE & SCHWARZ	FSP40	100039	Jan. 11, 2010	Jan. 10, 2011
BILOG Antenna SCHWARZBECK	VULB9168	9168-155	Apr. 28, 2010	Apr. 27, 2011
HORN Antenna SCHWARZBECK	BBHA 9120D	9120D-408	Jan. 05, 2010	Jan. 04, 2011
HORN Antenna SCHWARZBECK	BBHA 9170	BBHA9170242	Dec. 25, 2009	Dec. 24, 2010
Preamplifier Agilent	8449B	3008A01961	Nov. 04, 2009	Nov. 03, 2010
Preamplifier Agilent	8447D	2944A10738	Nov. 04, 2009	Nov. 03, 2010
RF signal cable HUBER+SUHNNER	SUCOFLEX 104	274041/4	Aug. 28, 2009	Aug. 27, 2010
RF signal cable HUBER+SUHNNER	SUCOFLEX 104	283397/4	Aug. 28, 2009	Aug. 27, 2010
Software ADT.	ADT_Radiated_ V7.6.15.9.2	NA	NA	NA
Antenna Tower inn-co GmbH	MA 4000	010303	NA	NA
Antenna Tower Controller inn-co GmbH	CO2000	019303	NA	NA
Turn Table ADT.	TT100.	TT93021704	NA	NA
Turn Table Controller ADT.	SC100.	SC93021704	NA	NA

- NOTE:**
1. The calibration interval of the above test instruments is 12 months and the calibrations are traceable to NML/ROC and NIST/USA.
  2. The test was performed in HwaYa Chamber 4.
  3. The horn antenna and HP preamplifier (model: 8449B) are used only for the measurement of emission frequency above 1GHz if tested.
  4. The FCC Site Registration No. is 988962.
  5. The IC Site Registration No. is IC7450F-4.



#### 4.1.3 TEST PROCEDURES

- a. The EUT was placed on the top of a rotating table 0.8 meters above the ground at a 3 meters semi-anechoic chamber. The table was rotated 360 degrees to determine the position of the highest radiation.
- b. The EUT was set 3 meters away from the interference-receiving antenna, which was mounted on the top of a variable-height antenna tower.
- c. The antenna is a broadband antenna, and its height is varied from one meter to four meters above the ground to determine the maximum value of the field strength. Both horizontal and vertical polarizations of the antenna are set to make the measurement.
- d. For each suspected emission, the EUT was arranged to its worst case and then the antenna was tuned to heights from 1 meter to 4 meters and the rotatable table was turned from 0 degrees to 360 degrees to find the maximum reading.
- e. The test-receiver system was set to Peak Detect Function and Specified Bandwidth with Maximum Hold Mode.
- f. If the emission level of the EUT in peak mode was lower than the limit specified, then testing could be stopped and the peak values of the EUT would be reported. Otherwise the emissions would be re-tested one by one using peak, quasi-peak or average method as specified and then reported in a data sheet.

**NOTE:**

1. The resolution bandwidth and video bandwidth of test receiver/spectrum analyzer is 120kHz for Quasi-peak detection at frequency below 1GHz.
2. The resolution bandwidth of test receiver/spectrum analyzer is 1MHz and video bandwidth is 3MHz for Peak detection at frequency above 1GHz.
3. The resolution bandwidth of test receiver/spectrum analyzer is 1MHz and the video bandwidth is 10Hz for Average detection (AV) at frequency above 1GHz.
4. All modes of operation were investigated and the worst-case emissions are reported.

#### 4.1.4 DEVIATION FROM TEST STANDARD

No deviation.

#### 4.1.5 TEST SETUP

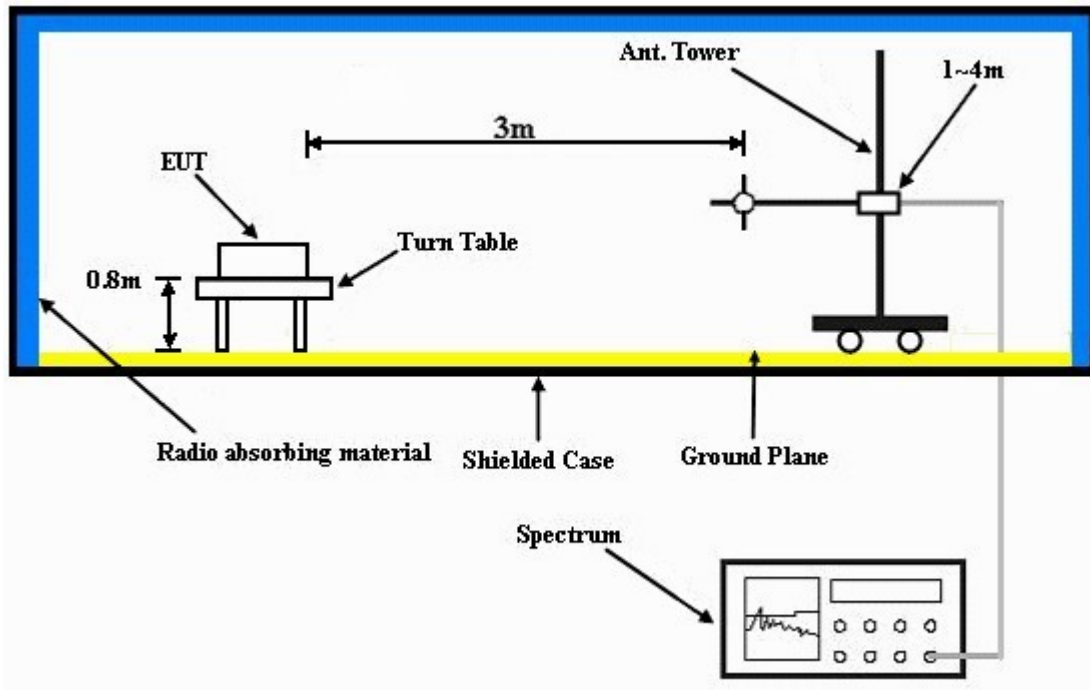

For the actual test configuration, please refer to the attached file (Test Setup Photo).

#### 4.1.6 EUT OPERATING CONDITIONS

- a. The notebook system ran a test program (provided by manufacturer) to enable EUT under transmission condition continuously at specific channel frequency.
- b. The necessary accessories enable the system in full functions.



### 4.1.7 TEST RESULTS

#### 802.11b

EUT TEST CONDITION		MEASUREMENT DETAIL	
CHANNEL	Channel 1	FREQUENCY RANGE	1 ~ 25GHz
INPUT POWER (SYSTEM)	120 Vac, 60 Hz	DETECTOR FUNCTION	Peak (PK) Average (AV)
ENVIRONMENTAL CONDITIONS	28deg. C, 68%RH 1005 hPa	TESTED BY	Sun Lin

ANTENNA POLARITY & TEST DISTANCE: HORIZONTAL AT 3 M								
NO.	FREQ. (MHz)	EMISSION LEVEL (dBuV/m)	LIMIT (dBuV/m)	MARGIN (dB)	ANTENNA HEIGHT (m)	TABLE ANGLE (Degree)	RAW VALUE (dBuV)	CORRECTION FACTOR (dB/m)
1	2390.00	59.4 PK	74.0	-14.6	2.00 H	75	25.90	33.50
2	2390.00	49.8 AV	54.0	-4.2	2.00 H	75	16.30	33.50
3	*2412.00	93.6 PK			2.00 H	75	60.00	33.60
4	*2412.00	89.8 AV			2.00 H	75	56.20	33.60
5	4824.00	49.9 PK	74.0	-24.1	1.08 H	18	9.90	40.00
6	4824.00	37.4 AV	54.0	-16.6	1.08 H	18	-2.60	40.00

ANTENNA POLARITY & TEST DISTANCE: VERTICAL AT 3 M								
NO.	FREQ. (MHz)	EMISSION LEVEL (dBuV/m)	LIMIT (dBuV/m)	MARGIN (dB)	ANTENNA HEIGHT (m)	TABLE ANGLE (Degree)	RAW VALUE (dBuV)	CORRECTION FACTOR (dB/m)
1	2386.00	62.2 PK	74.0	-11.8	1.35 V	312	28.70	33.50
2	2386.00	53.0 AV	54.0	-1.0	1.35 V	312	19.50	33.50
3	*2412.00	107.5 PK			1.35 V	312	73.90	33.60
4	*2412.00	103.4 AV			1.35 V	312	69.80	33.60
5	4824.00	49.3 PK	74.0	-24.7	1.30 V	253	9.30	40.00
6	4824.00	37.2 AV	54.0	-16.8	1.30 V	253	-2.80	40.00

- REMARKS:**
1. Emission level (dBuV/m) = Raw Value (dBuV) + Correction Factor (dB/m).
  2. Correction Factor (dB/m) = Antenna Factor (dB/m) + Cable Factor (dB).
  3. The other emission levels were very low against the limit.
  4. Margin value = Emission level – Limit value.
  5. “ \* “: Fundamental frequency.



A D T

EUT TEST CONDITION		MEASUREMENT DETAIL	
CHANNEL	Channel 6	FREQUENCY RANGE	1 ~ 25GHz
INPUT POWER (SYSTEM)	120 Vac, 60 Hz	DETECTOR FUNCTION	Peak (PK) Average (AV)
ENVIRONMENTAL CONDITIONS	28deg. C, 68%RH 1005 hPa	TESTED BY	Sun Lin

ANTENNA POLARITY & TEST DISTANCE: HORIZONTAL AT 3 M								
NO.	FREQ. (MHz)	EMISSION LEVEL (dBuV/m)	LIMIT (dBuV/m)	MARGIN (dB)	ANTENNA HEIGHT (m)	TABLE ANGLE (Degree)	RAW VALUE (dBuV)	CORRECTION FACTOR (dB/m)
1	*2437.00	95.6 PK			1.00 H	62	61.90	33.70
2	*2437.00	91.6 AV			1.00 H	62	57.90	33.70
3	4874.00	49.5 PK	74.0	-24.5	1.02 H	54	9.40	40.10
4	4874.00	37.3 AV	54.0	-16.7	1.02 H	54	-2.80	40.10
5	7311.00	56.4 PK	74.0	-17.6	1.02 H	36	10.00	46.40
6	7311.00	45.5 AV	54.0	-8.5	1.02 H	36	-0.90	46.40
ANTENNA POLARITY & TEST DISTANCE: VERTICAL AT 3 M								
NO.	FREQ. (MHz)	EMISSION LEVEL (dBuV/m)	LIMIT (dBuV/m)	MARGIN (dB)	ANTENNA HEIGHT (m)	TABLE ANGLE (Degree)	RAW VALUE (dBuV)	CORRECTION FACTOR (dB/m)
1	*2437.00	109.3 PK			1.06 V	294	75.60	33.70
2	*2437.00	105.2 AV			1.06 V	294	71.50	33.70
3	4874.00	52.5 PK	74.0	-21.5	1.02 V	56	12.40	40.10
4	4874.00	38.2 AV	54.0	-15.8	1.02 V	56	-1.90	40.10
5	7311.00	62.0 PK	74.0	-12.0	1.40 V	122	15.60	46.40
6	7311.00	53.0 AV	54.0	-1.0	1.40 V	122	6.60	46.40

- REMARKS:**
1. Emission level (dBuV/m) = Raw Value (dBuV) + Correction Factor (dB/m).
  2. Correction Factor (dB/m) = Antenna Factor (dB/m) + Cable Factor (dB).
  3. The other emission levels were very low against the limit.
  4. Margin value = Emission level – Limit value.
  5. “ \* “: Fundamental frequency.





A D T

EUT TEST CONDITION		MEASUREMENT DETAIL	
CHANNEL	Channel 11	FREQUENCY RANGE	1 ~ 25GHz
INPUT POWER (SYSTEM)	120 Vac, 60 Hz	DETECTOR FUNCTION	Peak (PK) Average (AV)
ENVIRONMENTAL CONDITIONS	28deg. C, 68%RH 1005 hPa	TESTED BY	Sun Lin

ANTENNA POLARITY & TEST DISTANCE: HORIZONTAL AT 3 M								
NO.	FREQ. (MHz)	EMISSION LEVEL (dBuV/m)	LIMIT (dBuV/m)	MARGIN (dB)	ANTENNA HEIGHT (m)	TABLE ANGLE (Degree)	RAW VALUE (dBuV)	CORRECTION FACTOR (dB/m)
1	*2462.00	93.6 PK			1.00 H	203	59.80	33.80
2	*2462.00	89.4 AV			1.00 H	203	55.60	33.80
3	2487.40	58.5 PK	74.0	-15.5	1.00 H	204	24.60	33.90
4	2487.40	48.6 AV	54.0	-5.4	1.00 H	204	14.70	33.90
5	4924.00	50.7 PK	74.0	-23.3	1.00 H	247	10.50	40.20
6	4924.00	37.8 AV	54.0	-16.2	1.00 H	247	-2.40	40.20
7	7386.00	56.5 PK	74.0	-17.5	1.20 H	36	9.90	46.60
8	7386.00	45.5 AV	54.0	-8.5	1.20 H	36	-1.10	46.60
ANTENNA POLARITY & TEST DISTANCE: VERTICAL AT 3 M								
NO.	FREQ. (MHz)	EMISSION LEVEL (dBuV/m)	LIMIT (dBuV/m)	MARGIN (dB)	ANTENNA HEIGHT (m)	TABLE ANGLE (Degree)	RAW VALUE (dBuV)	CORRECTION FACTOR (dB/m)
1	*2462.00	107.7 PK			1.08 V	355	73.90	33.80
2	*2462.00	103.1 AV			1.08 V	355	69.30	33.80
3	2487.40	62.4 PK	74.0	-11.6	1.03 V	306	28.50	33.90
4	2487.40	52.5 AV	54.0	-1.5	1.03 V	306	18.60	33.90
5	4924.00	51.2 PK	74.0	-22.8	1.02 V	263	11.00	40.20
6	4924.00	36.8 AV	54.0	-17.2	1.02 V	263	-3.40	40.20
7	7386.00	61.0 PK	74.0	-13.0	1.24 V	116	14.40	46.60
8	7386.00	52.8 AV	54.0	-1.2	1.24 V	116	6.20	46.60

- REMARKS:**
1. Emission level (dBuV/m) = Raw Value (dBuV) + Correction Factor (dB/m).
  2. Correction Factor (dB/m) = Antenna Factor (dB/m) + Cable Factor (dB).
  3. The other emission levels were very low against the limit.
  4. Margin value = Emission level – Limit value.
  5. “ \* “: Fundamental frequency.



A D T

802.11g

EUT TEST CONDITION		MEASUREMENT DETAIL	
CHANNEL	Channel 1	FREQUENCY RANGE	1 ~ 25GHz
INPUT POWER (SYSTEM)	120 Vac, 60 Hz	DETECTOR FUNCTION	Peak (PK) Average (AV)
ENVIRONMENTAL CONDITIONS	28deg. C, 68%RH 1005 hPa	TESTED BY	Sun Lin

ANTENNA POLARITY & TEST DISTANCE: HORIZONTAL AT 3 M								
NO.	FREQ. (MHz)	EMISSION LEVEL (dBuV/m)	LIMIT (dBuV/m)	MARGIN (dB)	ANTENNA HEIGHT (m)	TABLE ANGLE (Degree)	RAW VALUE (dBuV)	CORRECTION FACTOR (dB/m)
1	2390.00	58.9 PK	74.0	-15.1	1.00 H	72	25.40	33.50
2	2390.00	47.5 AV	54.0	-6.5	1.00 H	72	14.00	33.50
3	*2412.00	98.4 PK			1.02 H	72	64.80	33.60
4	*2412.00	88.8 AV			1.02 H	72	55.20	33.60
5	4824.00	51.0 PK	74.0	-23.0	1.00 H	266	11.00	40.00
6	4824.00	38.1 AV	54.0	-15.9	1.00 H	266	-1.90	40.00
ANTENNA POLARITY & TEST DISTANCE: VERTICAL AT 3 M								
NO.	FREQ. (MHz)	EMISSION LEVEL (dBuV/m)	LIMIT (dBuV/m)	MARGIN (dB)	ANTENNA HEIGHT (m)	TABLE ANGLE (Degree)	RAW VALUE (dBuV)	CORRECTION FACTOR (dB/m)
1	2390.00	66.4 PK	74.0	-7.6	1.18 V	161	32.90	33.50
2	2390.00	52.1 AV	54.0	-1.9	1.18 V	161	18.60	33.50
3	*2412.00	109.6 PK			1.15 V	17	76.00	33.60
4	*2412.00	100.1 AV			1.15 V	17	66.50	33.60
5	4824.00	51.8 PK	74.0	-22.2	1.02 V	360	11.80	40.00
6	4824.00	38.3 AV	54.0	-15.7	1.02 V	360	-1.70	40.00

- REMARKS:**
1. Emission level (dBuV/m) = Raw Value (dBuV) + Correction Factor (dB/m).
  2. Correction Factor (dB/m) = Antenna Factor (dB/m) + Cable Factor (dB).
  3. The other emission levels were very low against the limit.
  4. Margin value = Emission level – Limit value.
  5. “ \* “: Fundamental frequency.



A D T

EUT TEST CONDITION		MEASUREMENT DETAIL	
CHANNEL	Channel 6	FREQUENCY RANGE	1 ~ 25GHz
INPUT POWER (SYSTEM)	120 Vac, 60 Hz	DETECTOR FUNCTION	Peak (PK) Average (AV)
ENVIRONMENTAL CONDITIONS	28deg. C, 68%RH 1005 hPa	TESTED BY	Sun Lin

ANTENNA POLARITY & TEST DISTANCE: HORIZONTAL AT 3 M								
NO.	FREQ. (MHz)	EMISSION LEVEL (dBuV/m)	LIMIT (dBuV/m)	MARGIN (dB)	ANTENNA HEIGHT (m)	TABLE ANGLE (Degree)	RAW VALUE (dBuV)	CORRECTION FACTOR (dB/m)
1	*2437.00	98.6 PK			1.00 H	60	64.90	33.70
2	*2437.00	87.8 AV			1.00 H	60	54.10	33.70
3	4874.00	51.6 PK	74.0	-22.4	1.02 H	63	11.50	40.10
4	4874.00	38.6 AV	54.0	-15.4	1.02 H	63	-1.50	40.10
ANTENNA POLARITY & TEST DISTANCE: VERTICAL AT 3 M								
NO.	FREQ. (MHz)	EMISSION LEVEL (dBuV/m)	LIMIT (dBuV/m)	MARGIN (dB)	ANTENNA HEIGHT (m)	TABLE ANGLE (Degree)	RAW VALUE (dBuV)	CORRECTION FACTOR (dB/m)
1	*2437.00	109.3 PK			1.04 V	313	75.60	33.70
2	*2437.00	99.9 AV			1.04 V	313	66.20	33.70
3	4874.00	50.5 PK	74.0	-23.5	1.00 V	14	10.40	40.10
4	4874.00	38.4 AV	54.0	-15.6	1.00 V	14	-1.70	40.10

- REMARKS:**
1. Emission level (dBuV/m) = Raw Value (dBuV) + Correction Factor (dB/m).
  2. Correction Factor (dB/m) = Antenna Factor (dB/m) + Cable Factor (dB).
  3. The other emission levels were very low against the limit.
  4. Margin value = Emission level – Limit value.
  5. “ \* “: Fundamental frequency.



A D T

EUT TEST CONDITION		MEASUREMENT DETAIL	
CHANNEL	Channel 11	FREQUENCY RANGE	1 ~ 25GHz
INPUT POWER (SYSTEM)	120 Vac, 60 Hz	DETECTOR FUNCTION	Peak (PK) Average (AV)
ENVIRONMENTAL CONDITIONS	28deg. C, 68%RH 1005 hPa	TESTED BY	Sun Lin

ANTENNA POLARITY & TEST DISTANCE: HORIZONTAL AT 3 M								
NO.	FREQ. (MHz)	EMISSION LEVEL (dBuV/m)	LIMIT (dBuV/m)	MARGIN (dB)	ANTENNA HEIGHT (m)	TABLE ANGLE (Degree)	RAW VALUE (dBuV)	CORRECTION FACTOR (dB/m)
1	*2462.00	98.6 PK			1.29 H	71	64.80	33.80
2	*2462.00	88.4 AV			1.29 H	71	54.60	33.80
3	2483.50	60.6 PK	74.0	-13.4	1.25 H	63	26.80	33.80
4	2483.50	48.6 AV	54.0	-5.4	1.25 H	63	14.80	33.80
5	4924.00	51.0 PK	74.0	-23.0	1.00 H	270	10.80	40.20
6	4924.00	37.1 AV	54.0	-16.9	1.00 H	270	-3.10	40.20
ANTENNA POLARITY & TEST DISTANCE: VERTICAL AT 3 M								
NO.	FREQ. (MHz)	EMISSION LEVEL (dBuV/m)	LIMIT (dBuV/m)	MARGIN (dB)	ANTENNA HEIGHT (m)	TABLE ANGLE (Degree)	RAW VALUE (dBuV)	CORRECTION FACTOR (dB/m)
1	*2462.00	109.5 PK			1.05 V	263	75.70	33.80
2	*2462.00	99.2 AV			1.05 V	263	65.40	33.80
3	2483.50	65.4 PK	74.0	-8.6	1.05 V	319	31.60	33.80
4	2483.50	52.6 AV	54.0	-1.4	1.05 V	319	18.80	33.80
5	4924.00	51.1 PK	74.0	-22.9	1.02 V	355	10.90	40.20
6	4924.00	38.3 AV	54.0	-15.7	1.02 V	355	-1.90	40.20

- REMARKS:**
1. Emission level (dBuV/m) = Raw Value (dBuV) + Correction Factor (dB/m).
  2. Correction Factor (dB/m) = Antenna Factor (dB/m) + Cable Factor (dB).
  3. The other emission levels were very low against the limit.
  4. Margin value = Emission level – Limit value.
  5. “ \* “: Fundamental frequency.



A D T

802.11n (20MHz)

EUT TEST CONDITION		MEASUREMENT DETAIL	
CHANNEL	Channel 1	FREQUENCY RANGE	1 ~ 25GHz
INPUT POWER (SYSTEM)	120 Vac, 60 Hz	DETECTOR FUNCTION	Peak (PK) Average (AV)
ENVIRONMENTAL CONDITIONS	28deg. C, 68%RH 1005 hPa	TESTED BY	Sun Lin

ANTENNA POLARITY & TEST DISTANCE: HORIZONTAL AT 3 M								
NO.	FREQ. (MHz)	EMISSION LEVEL (dBuV/m)	LIMIT (dBuV/m)	MARGIN (dB)	ANTENNA HEIGHT (m)	TABLE ANGLE (Degree)	RAW VALUE (dBuV)	CORRECTION FACTOR (dB/m)
1	2390.00	58.4 PK	74.0	-15.6	1.00 H	105	24.90	33.50
2	2390.00	47.2 AV	54.0	-6.8	1.00 H	105	13.70	33.50
3	*2412.00	96.6 PK			1.00 H	105	63.00	33.60
4	*2412.00	85.6 AV			1.00 H	105	52.00	33.60
5	4824.00	51.3 PK	74.0	-22.7	1.00 H	271	11.30	40.00
6	4824.00	38.6 AV	54.0	-15.4	1.00 H	271	-1.40	40.00
ANTENNA POLARITY & TEST DISTANCE: VERTICAL AT 3 M								
NO.	FREQ. (MHz)	EMISSION LEVEL (dBuV/m)	LIMIT (dBuV/m)	MARGIN (dB)	ANTENNA HEIGHT (m)	TABLE ANGLE (Degree)	RAW VALUE (dBuV)	CORRECTION FACTOR (dB/m)
1	2390.00	66.3 PK	74.0	-7.7	1.32 V	310	32.80	33.50
2	2390.00	52.9 AV	54.0	-1.1	1.32 V	310	19.40	33.50
3	*2412.00	107.2 PK			1.07 V	260	73.60	33.60
4	*2412.00	97.2 AV			1.07 V	260	63.60	33.60
5	4824.00	51.6 PK	74.0	-22.4	1.01 V	352	11.60	40.00
6	4824.00	38.7 AV	54.0	-15.3	1.01 V	352	-1.30	40.00

- REMARKS:**
1. Emission level (dBuV/m) = Raw Value (dBuV) + Correction Factor (dB/m).
  2. Correction Factor (dB/m) = Antenna Factor (dB/m) + Cable Factor (dB).
  3. The other emission levels were very low against the limit.
  4. Margin value = Emission level – Limit value.
  5. “ \* “: Fundamental frequency.



A D T

EUT TEST CONDITION		MEASUREMENT DETAIL	
CHANNEL	Channel 6	FREQUENCY RANGE	1 ~ 25GHz
INPUT POWER (SYSTEM)	120 Vac, 60 Hz	DETECTOR FUNCTION	Peak (PK) Average (AV)
ENVIRONMENTAL CONDITIONS	28deg. C, 68%RH 1005 hPa	TESTED BY	Sun Lin

ANTENNA POLARITY & TEST DISTANCE: HORIZONTAL AT 3 M								
NO.	FREQ. (MHz)	EMISSION LEVEL (dBuV/m)	LIMIT (dBuV/m)	MARGIN (dB)	ANTENNA HEIGHT (m)	TABLE ANGLE (Degree)	RAW VALUE (dBuV)	CORRECTION FACTOR (dB/m)
1	*2437.00	96.1 PK			1.34 H	70	62.40	33.70
2	*2437.00	85.8 AV			1.34 H	70	52.10	33.70
3	4874.00	51.8 PK	74.0	-22.2	1.01 H	54	11.70	40.10
4	4874.00	38.7 AV	54.0	-15.3	1.01 H	54	-1.40	40.10
ANTENNA POLARITY & TEST DISTANCE: VERTICAL AT 3 M								
NO.	FREQ. (MHz)	EMISSION LEVEL (dBuV/m)	LIMIT (dBuV/m)	MARGIN (dB)	ANTENNA HEIGHT (m)	TABLE ANGLE (Degree)	RAW VALUE (dBuV)	CORRECTION FACTOR (dB/m)
1	*2437.00	107.0 PK			1.03 V	316	73.30	33.70
2	*2437.00	97.4 AV			1.03 V	316	63.70	33.70
3	4874.00	51.0 PK	74.0	-23.0	1.00 V	20	10.90	40.10
4	4874.00	38.7 AV	54.0	-15.3	1.00 V	20	-1.40	40.10

- REMARKS:**
1. Emission level (dBuV/m) = Raw Value (dBuV) + Correction Factor (dB/m).
  2. Correction Factor (dB/m) = Antenna Factor (dB/m) + Cable Factor (dB).
  3. The other emission levels were very low against the limit.
  4. Margin value = Emission level – Limit value.
  5. “ \* “: Fundamental frequency.



A D T

EUT TEST CONDITION		MEASUREMENT DETAIL	
CHANNEL	Channel 11	FREQUENCY RANGE	1 ~ 25GHz
INPUT POWER (SYSTEM)	120 Vac, 60 Hz	DETECTOR FUNCTION	Peak (PK) Average (AV)
ENVIRONMENTAL CONDITIONS	28deg. C, 68%RH 1005 hPa	TESTED BY	Sun Lin

ANTENNA POLARITY & TEST DISTANCE: HORIZONTAL AT 3 M								
NO.	FREQ. (MHz)	EMISSION LEVEL (dBuV/m)	LIMIT (dBuV/m)	MARGIN (dB)	ANTENNA HEIGHT (m)	TABLE ANGLE (Degree)	RAW VALUE (dBuV)	CORRECTION FACTOR (dB/m)
1	*2462.00	95.9 PK			1.00 H	62	62.10	33.80
2	*2462.00	86.3 AV			1.00 H	62	52.50	33.80
3	2483.50	58.5 PK	74.0	-15.5	1.00 H	63	24.70	33.80
4	2483.50	48.1 AV	54.0	-5.9	1.00 H	63	14.30	33.80
5	4924.00	51.6 PK	74.0	-22.4	1.00 H	266	11.40	40.20
6	4924.00	37.4 AV	54.0	-16.6	1.00 H	266	-2.80	40.20
ANTENNA POLARITY & TEST DISTANCE: VERTICAL AT 3 M								
NO.	FREQ. (MHz)	EMISSION LEVEL (dBuV/m)	LIMIT (dBuV/m)	MARGIN (dB)	ANTENNA HEIGHT (m)	TABLE ANGLE (Degree)	RAW VALUE (dBuV)	CORRECTION FACTOR (dB/m)
1	*2462.00	108.1 PK			1.06 V	263	74.30	33.80
2	*2462.00	97.5 AV			1.06 V	263	63.70	33.80
3	2483.50	65.2 PK	74.0	-8.8	1.05 V	264	31.40	33.80
4	2483.50	52.8 AV	54.0	-1.2	1.05 V	264	19.00	33.80
5	4924.00	51.5 PK	74.0	-22.5	1.00 V	269	11.30	40.20
6	4924.00	38.9 AV	54.0	-15.1	1.00 V	269	-1.30	40.20

- REMARKS:**
1. Emission level (dBuV/m) = Raw Value (dBuV) + Correction Factor (dB/m).
  2. Correction Factor (dB/m) = Antenna Factor (dB/m) + Cable Factor (dB).
  3. The other emission levels were very low against the limit.
  4. Margin value = Emission level – Limit value.
  5. “ \* “: Fundamental frequency.



A D T

802.11n (40MHz)

EUT TEST CONDITION		MEASUREMENT DETAIL	
CHANNEL	Channel 1	FREQUENCY RANGE	1 ~ 25GHz
INPUT POWER (SYSTEM)	120 Vac, 60 Hz	DETECTOR FUNCTION	Peak (PK) Average (AV)
ENVIRONMENTAL CONDITIONS	28deg. C, 68%RH 1005 hPa	TESTED BY	Sun Lin

ANTENNA POLARITY & TEST DISTANCE: HORIZONTAL AT 3 M								
NO.	FREQ. (MHz)	EMISSION LEVEL (dBuV/m)	LIMIT (dBuV/m)	MARGIN (dB)	ANTENNA HEIGHT (m)	TABLE ANGLE (Degree)	RAW VALUE (dBuV)	CORRECTION FACTOR (dB/m)
1	2390.00	59.2 PK	74.0	-14.8	1.98 H	71	25.70	33.50
2	2390.00	48.1 AV	54.0	-5.9	1.98 H	71	14.60	33.50
3	*2422.00	93.9 PK			1.99 H	70	60.30	33.60
4	*2422.00	83.6 AV			1.99 H	70	50.00	33.60
5	4844.00	50.8 PK	74.0	-23.2	1.02 H	56	10.80	40.00
6	4844.00	38.1 AV	54.0	-15.9	1.02 H	56	-1.90	40.00
ANTENNA POLARITY & TEST DISTANCE: VERTICAL AT 3 M								
NO.	FREQ. (MHz)	EMISSION LEVEL (dBuV/m)	LIMIT (dBuV/m)	MARGIN (dB)	ANTENNA HEIGHT (m)	TABLE ANGLE (Degree)	RAW VALUE (dBuV)	CORRECTION FACTOR (dB/m)
1	2390.00	63.1 PK	74.0	-10.9	1.13 V	0	29.60	33.50
2	2390.00	52.8 AV	54.0	-1.2	1.13 V	0	19.30	33.50
3	*2422.00	103.2 PK			1.11 V	67	69.60	33.60
4	*2422.00	93.1 AV			1.11 V	67	59.50	33.60
5	4844.00	51.5 PK	74.0	-22.5	1.00 V	265	11.50	40.00
6	4844.00	38.8 AV	54.0	-15.2	1.00 V	265	-1.20	40.00

- REMARKS:**
1. Emission level (dBuV/m) = Raw Value (dBuV) + Correction Factor (dB/m).
  2. Correction Factor (dB/m) = Antenna Factor (dB/m) + Cable Factor (dB).
  3. The other emission levels were very low against the limit.
  4. Margin value = Emission level – Limit value.
  5. “ \* “: Fundamental frequency.





A D T

EUT TEST CONDITION		MEASUREMENT DETAIL	
CHANNEL	Channel 4	FREQUENCY RANGE	1 ~ 25GHz
INPUT POWER (SYSTEM)	120 Vac, 60 Hz	DETECTOR FUNCTION	Peak (PK) Average (AV)
ENVIRONMENTAL CONDITIONS	28deg. C, 68%RH 1005 hPa	TESTED BY	Sun Lin

ANTENNA POLARITY & TEST DISTANCE: HORIZONTAL AT 3 M								
NO.	FREQ. (MHz)	EMISSION LEVEL (dBuV/m)	LIMIT (dBuV/m)	MARGIN (dB)	ANTENNA HEIGHT (m)	TABLE ANGLE (Degree)	RAW VALUE (dBuV)	CORRECTION FACTOR (dB/m)
1	*2437.00	92.4 PK			1.08 H	60	58.70	33.70
2	*2437.00	82.8 AV			1.08 H	60	49.10	33.70
3	4874.00	50.9 PK	74.0	-23.1	1.01 H	58	10.80	40.10
4	4874.00	38.6 AV	54.0	-15.4	1.01 H	58	-1.50	40.10
ANTENNA POLARITY & TEST DISTANCE: VERTICAL AT 3 M								
NO.	FREQ. (MHz)	EMISSION LEVEL (dBuV/m)	LIMIT (dBuV/m)	MARGIN (dB)	ANTENNA HEIGHT (m)	TABLE ANGLE (Degree)	RAW VALUE (dBuV)	CORRECTION FACTOR (dB/m)
1	*2437.00	103.0 PK			1.00 V	320	69.30	33.70
2	*2437.00	93.1 AV			1.00 V	320	59.40	33.70
3	4874.00	51.8 PK	74.0	-22.2	1.00 V	268	11.70	40.10
4	4874.00	38.4 AV	54.0	-15.6	1.00 V	268	-1.70	40.10

- REMARKS:**
1. Emission level (dBuV/m) = Raw Value (dBuV) + Correction Factor (dB/m).
  2. Correction Factor (dB/m) = Antenna Factor (dB/m) + Cable Factor (dB).
  3. The other emission levels were very low against the limit.
  4. Margin value = Emission level – Limit value.
  5. “ \* “: Fundamental frequency.



A D T

EUT TEST CONDITION		MEASUREMENT DETAIL	
CHANNEL	Channel 7	FREQUENCY RANGE	1 ~ 25GHz
INPUT POWER (SYSTEM)	120 Vac, 60 Hz	DETECTOR FUNCTION	Peak (PK) Average (AV)
ENVIRONMENTAL CONDITIONS	28deg. C, 68%RH 1005 hPa	TESTED BY	Sun Lin

ANTENNA POLARITY & TEST DISTANCE: HORIZONTAL AT 3 M								
NO.	FREQ. (MHz)	EMISSION LEVEL (dBuV/m)	LIMIT (dBuV/m)	MARGIN (dB)	ANTENNA HEIGHT (m)	TABLE ANGLE (Degree)	RAW VALUE (dBuV)	CORRECTION FACTOR (dB/m)
1	*2452.00	92.5 PK			1.99 H	68	58.80	33.70
2	*2452.00	82.6 AV			1.99 H	68	48.90	33.70
3	2483.50	58.6 PK	74.0	-15.4	1.96 H	69	24.80	33.80
4	2483.50	48.3 AV	54.0	-5.7	1.96 H	69	14.50	33.80
5	4904.00	51.9 PK	74.0	-22.1	1.02 H	147	11.70	40.20
6	4904.00	38.6 AV	54.0	-15.4	1.02 H	147	-1.60	40.20
ANTENNA POLARITY & TEST DISTANCE: VERTICAL AT 3 M								
NO.	FREQ. (MHz)	EMISSION LEVEL (dBuV/m)	LIMIT (dBuV/m)	MARGIN (dB)	ANTENNA HEIGHT (m)	TABLE ANGLE (Degree)	RAW VALUE (dBuV)	CORRECTION FACTOR (dB/m)
1	*2452.00	103.0 PK			1.05 V	265	69.30	33.70
2	*2452.00	92.4 AV			1.05 V	265	58.70	33.70
3	2483.50	63.3 PK	74.0	-10.7	1.00 V	317	29.50	33.80
4	2483.50	52.4 AV	54.0	-1.6	1.00 V	317	18.60	33.80
5	4904.00	52.3 PK	74.0	-21.7	1.00 V	263	12.10	40.20
6	4904.00	39.0 AV	54.0	-15.0	1.00 V	263	-1.20	40.20

- REMARKS:**
1. Emission level (dBuV/m) = Raw Value (dBuV) + Correction Factor (dB/m).
  2. Correction Factor (dB/m) = Antenna Factor (dB/m) + Cable Factor (dB).
  3. The other emission levels were very low against the limit.
  4. Margin value = Emission level – Limit value.
  5. “ \* “: Fundamental frequency.



A D T

**BELOW 1GHz WORST-CASE DATA : 802.11n (20MHz)**

EUT TEST CONDITION		MEASUREMENT DETAIL	
CHANNEL	Channel 11	FREQUENCY RANGE	Below 1000MHz
INPUT POWER (SYSTEM)	120 Vac, 60 Hz	DETECTOR FUNCTION	Quasi-Peak
ENVIRONMENTAL CONDITIONS	23deg. C, 68%RH 1003 hPa	TESTED BY	Sun Lin

ANTENNA POLARITY & TEST DISTANCE: HORIZONTAL AT 3 M								
NO.	FREQ. (MHz)	EMISSION LEVEL (dBuV/m)	LIMIT (dBuV/m)	MARGIN (dB)	ANTENNA HEIGHT (m)	TABLE ANGLE (Degree)	RAW VALUE (dBuV)	CORRECTION FACTOR (dB/m)
1	99.89	36.3 QP	43.5	-7.2	1.50 H	199	26.80	9.50
2	119.34	37.2 QP	43.5	-6.3	1.50 H	79	25.80	11.40
3	<b>166.20</b>	<b>42.5 QP</b>	<b>43.5</b>	<b>-1.0</b>	<b>1.53 H</b>	<b>47</b>	<b>28.60</b>	<b>13.90</b>
4	199.05	38.1 QP	43.5	-5.4	1.50 H	13	26.50	11.60
5	364.32	33.7 QP	46.0	-12.3	1.00 H	7	16.60	17.10
6	430.42	31.3 QP	46.0	-14.7	1.50 H	358	12.40	18.90
ANTENNA POLARITY & TEST DISTANCE: VERTICAL AT 3 M								
NO.	FREQ. (MHz)	EMISSION LEVEL (dBuV/m)	LIMIT (dBuV/m)	MARGIN (dB)	ANTENNA HEIGHT (m)	TABLE ANGLE (Degree)	RAW VALUE (dBuV)	CORRECTION FACTOR (dB/m)
1	31.84	36.0 QP	40.0	-4.0	1.25 V	259	23.20	12.80
2	99.89	33.4 QP	43.5	-10.1	1.25 V	298	23.90	9.50
3	166.00	37.4 QP	43.5	-6.1	2.00 V	295	23.50	13.90
4	346.82	35.7 QP	46.0	-10.3	1.25 V	88	19.00	16.70
5	399.31	38.3 QP	46.0	-7.7	1.00 V	10	20.30	18.00
6	533.47	31.4 QP	46.0	-14.6	1.00 V	10	9.80	21.60

- REMARKS:**
1. Emission level (dBuV/m) = Raw Value (dBuV) + Correction Factor (dB/m).
  2. Correction Factor (dB/m) = Antenna Factor (dB/m) + Cable Factor (dB).
  3. The other emission levels were very low against the limit.
  4. Margin value = Emission level – Limit value.



## 4.2 CONDUCTED EMISSION MEASUREMENT

### 4.2.1 LIMITS OF CONDUCTED EMISSION MEASUREMENT

FREQUENCY OF EMISSION (MHz)	CONDUCTED LIMIT (dBµV)	
	Quasi-peak	Average
0.15 ~ 0.5	66 to 56	56 to 46
0.5 ~ 5	56	46
5 ~ 30	60	50

- NOTE:** 1. The lower limit shall apply at the transition frequencies.  
 2. The limit decreases in line with the logarithm of the frequency in the range of 0.15 to 0.50MHz.  
 3. All emanations from a class A/B digital device or system, including any network of conductors and apparatus connected thereto, shall not exceed the level of field strengths specified above.

### 4.2.2 TEST INSTRUMENTS

DESCRIPTION & MANUFACTURER	MODEL NO.	SERIAL NO.	DATE OF CALIBRATION	DUE DATE OF CALIBRATION
Test Receiver ROHDE & SCHWARZ	ESCS30	100288	Sep. 24, 2009	Sep. 23, 2010
RF signal cable Woken	5D-FB	Cable-HYCO2-01	Dec. 31, 2009	Dec. 30, 2010
LISN ROHDE & SCHWARZ	ESH2-Z5	100100	Aug. 24, 2009	Aug. 23, 2010
LISN ROHDE & SCHWARZ	ESH3-Z5	100311	Jul. 08, 2010	Jul. 07, 2011
Software ADT	ADT_Cond_ V7.3.7	NA	NA	NA

- NOTE:** 1. The calibration interval of the above test instruments is 12 months and the calibrations are traceable to NML/ROC and NIST/USA.  
 2. The test was performed in HwaYa Shielded Room 2.  
 3. The VCCI Site Registration No. is C-2047.



A D T

#### 4.2.3 TEST PROCEDURES

- a. The EUT was placed 0.4 meters from the conducting wall of the shielded room with EUT being connected to the power mains through a line impedance stabilization network (LISN). Other support units were connected to the power mains through another LISN. The two LISNs provide 50 ohm/ 50uH of coupling impedance for the measuring instrument.
- b. Both lines of the power mains connected to the EUT were checked for maximum conducted interference.
- c. The frequency range from 150kHz to 30MHz was searched. Emission levels under (Limit - 20dB) was not recorded.

**NOTE:** All modes of operation were investigated and the worst-case emissions are reported.

#### 4.2.4 DEVIATION FROM TEST STANDARD

No deviation.

#### 4.2.5 TEST SETUP

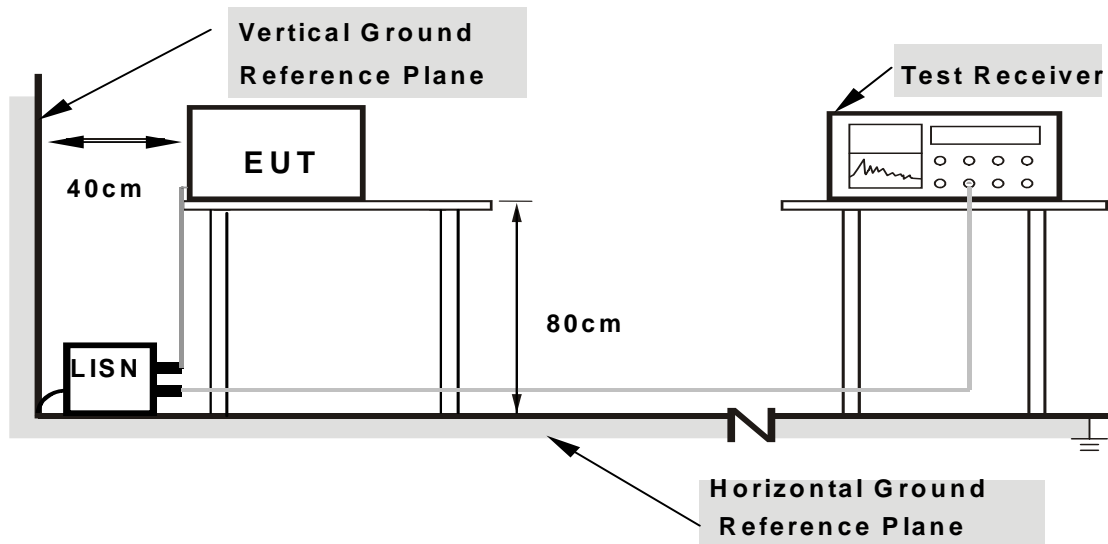

- Note:**
1. Support units were connected to second LISN.
  2. Both of LISNs (AMN) are 80 cm from EUT and at least 80 from other units and other metal planes

For the actual test configuration, please refer to the attached file (Test Setup Photo).

#### 4.2.6 EUT OPERATING CONDITIONS

Same as 4.1.6.

### 4.2.7 TEST RESULTS

**CONDUCTED WORST-CASE DATA : 802.11n (20MHz)**

<b>PHASE</b>	Line 1	<b>6dB BANDWIDTH</b>	9kHz
--------------	--------	----------------------	------

No	Freq. [MHz]	Corr.	Reading Value		Emission Level		Limit		Margin	
		Factor (dB)	[dB (uV)]		[dB (uV)]		[dB (uV)]		(dB)	
			Q.P.	AV.	Q.P.	AV.	Q.P.	AV.	Q.P.	AV.
1	0.228	0.16	46.23	-	46.39	-	62.52	52.52	-16.13	-
2	0.420	0.18	37.82	-	38.00	-	57.46	47.46	-19.46	-
3	0.505	0.19	39.64	-	39.83	-	56.00	46.00	-16.17	-
4	0.556	0.19	40.54	-	40.73	-	56.00	46.00	-15.27	-
5	0.627	0.20	40.76	-	40.96	-	56.00	46.00	-15.04	-
6	16.758	0.57	35.38	-	35.95	-	60.00	50.00	-24.05	-

- REMARKS:**
1. Q.P. and AV. are abbreviations of quasi-peak and average individually.
  2. "-": The Quasi-peak reading value also meets average limit and measurement with the average detector is unnecessary.
  3. The emission levels of other frequencies were very low against the limit.
  4. Margin value = Emission level - Limit value
  5. Correction factor = Insertion loss + Cable loss
  6. Emission Level = Correction Factor + Reading Value.

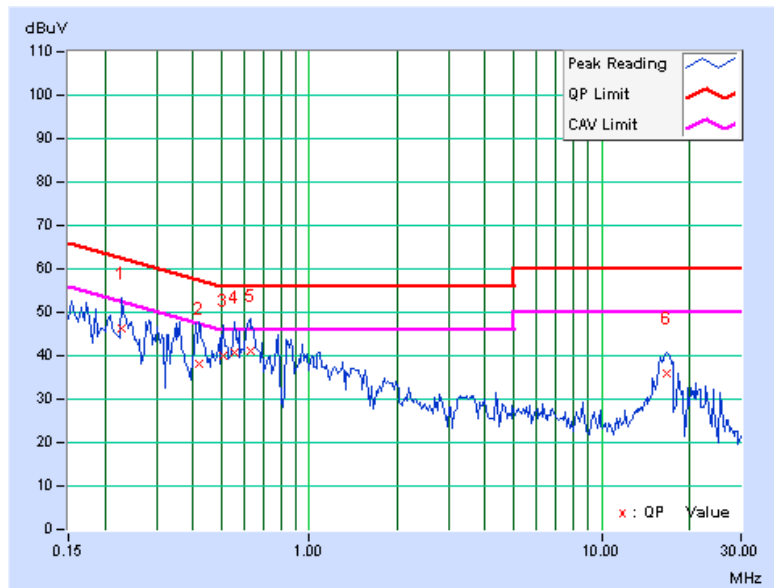

PHASE	Line 2	6dB BANDWIDTH	9kHz
-------	--------	---------------	------

No	Freq. [MHz]	Corr.	Reading Value		Emission Level		Limit		Margin	
		Factor (dB)	Q.P. [dB (uV)]	AV. [dB (uV)]	Q.P. [dB (uV)]	AV. [dB (uV)]	Q.P. [dB (uV)]	AV. [dB (uV)]	Q.P. (dB)	AV. (dB)
1	0.177	0.13	49.29	-	49.42	-	64.61	54.61	-15.19	-
2	<b>0.310</b>	<b>0.15</b>	<b>47.79</b>	-	<b>47.94</b>	-	<b>59.97</b>	<b>49.97</b>	<b>-12.03</b>	-
3	0.509	0.17	41.39	-	41.56	-	56.00	46.00	-14.44	-
4	0.552	0.18	43.13	-	43.31	-	56.00	46.00	-12.69	-
5	0.693	0.19	41.68	-	41.87	-	56.00	46.00	-14.13	-
6	16.809	0.75	34.80	-	35.55	-	60.00	50.00	-24.45	-

- REMARKS:**
1. Q.P. and AV. are abbreviations of quasi-peak and average individually.
  2. "-": The Quasi-peak reading value also meets average limit and measurement with the average detector is unnecessary.
  3. The emission levels of other frequencies were very low against the limit.
  4. Margin value = Emission level - Limit value
  5. Correction factor = Insertion loss + Cable loss
  6. Emission Level = Correction Factor + Reading Value.

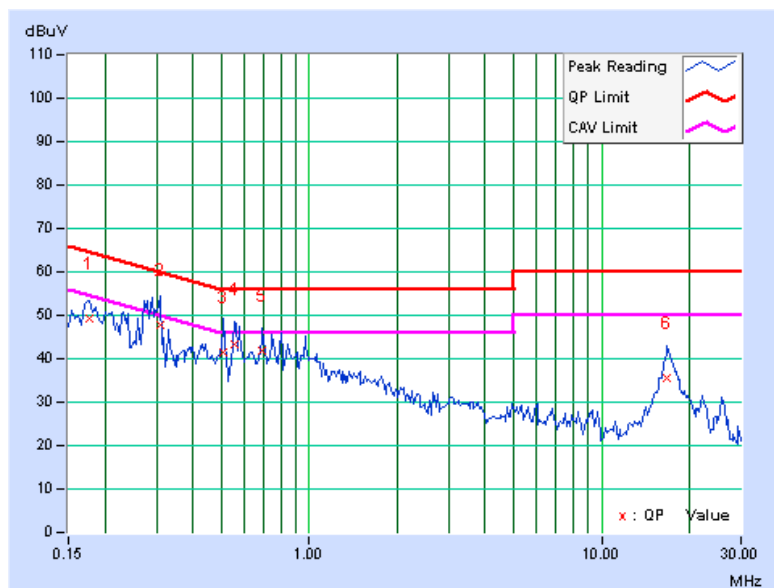



### 4.3 6dB BANDWIDTH MEASUREMENT

#### 4.3.1 LIMITS OF 6dB BANDWIDTH MEASUREMENT

The minimum of 6dB Bandwidth Measurement is 0.5 MHz.

#### 4.3.2 TEST INSTRUMENTS

DESCRIPTION & MANUFACTURER	MODEL NO.	SERIAL NO.	DATE OF CALIBRATION	DUE DATE OF CALIBRATION
SPECTRUM ANALYZER R&S	FSP40	100039	Jan. 11, 2010	Jan. 10, 2011

**NOTE:** The calibration interval of the above test instruments is 12 months and the calibrations are traceable to NML/ROC and NIST/USA.

#### 4.3.3 TEST PROCEDURE

The transmitter output was connected to the spectrum analyzer through an attenuator. The bandwidth of the fundamental frequency was measured by spectrum analyzer with 100kHz RBW and 300kHz VBW. The 6dB bandwidth is defined as the total spectrum the power of which is higher than peak power minus 6dB.

#### 4.3.4 DEVIATION FROM TEST STANDARD

No deviation.

#### 4.3.5 TEST SETUP

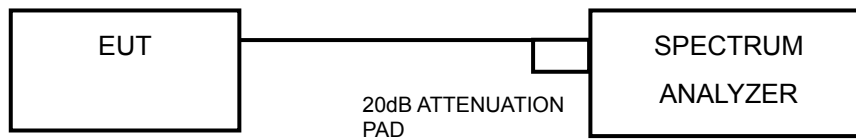

#### 4.3.6 EUT OPERATING CONDITIONS

The software provided by client to enable the EUT under transmission condition continuously at lowest, middle and highest channel frequencies individually.



A D T

### 4.3.7 TEST RESULTS

#### 802.11b

CHANNEL	CHANNEL FREQUENCY (MHz)	6dB BANDWIDTH (MHz)	MINIMUM LIMIT (MHz)	PASS / FAIL
1	2412	12.20	0.5	PASS
6	2437	12.23	0.5	PASS
11	2462	12.26	0.5	PASS

#### CH 11

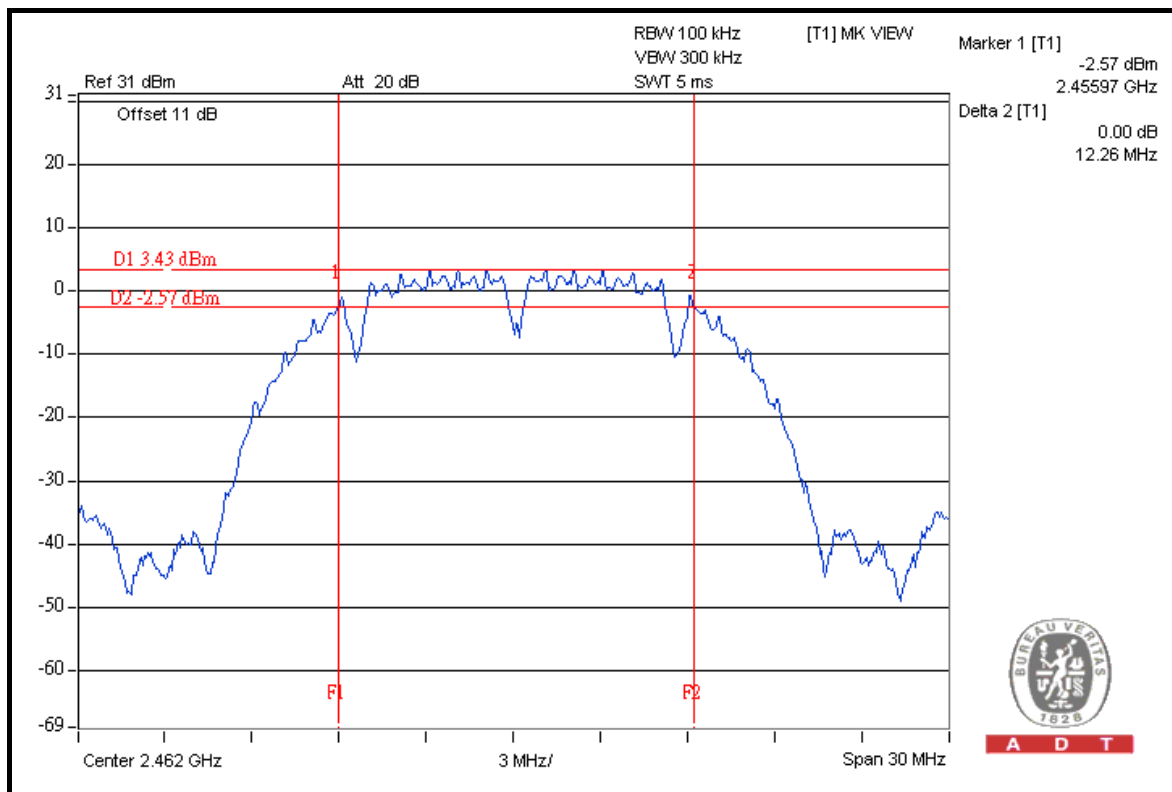

A D T



A D T

### 802.11g

CHANNEL	CHANNEL FREQUENCY (MHz)	6dB BANDWIDTH (MHz)	MINIMUM LIMIT (MHz)	PASS / FAIL
1	2412	16.65	0.5	PASS
6	2437	16.63	0.5	PASS
11	2462	16.60	0.5	PASS

### CH 1

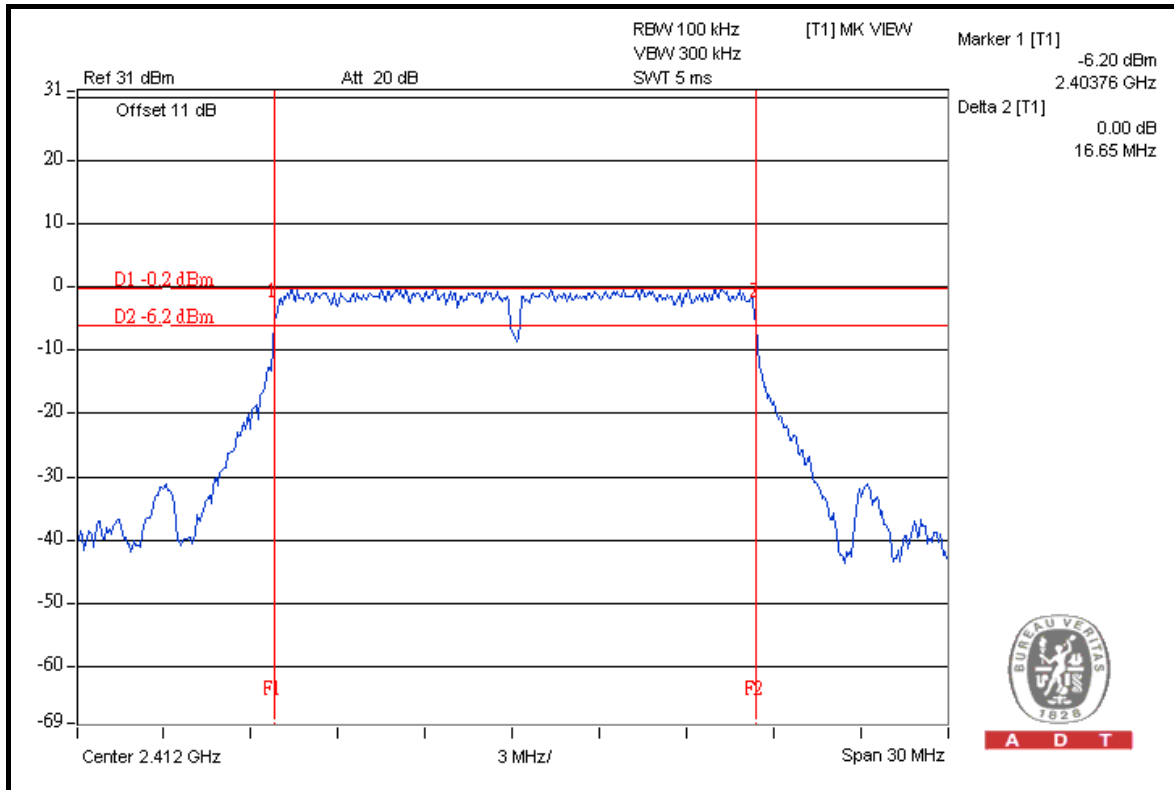



A D T

### 802.11n (20MHz)

CHANNEL	CHANNEL FREQUENCY (MHz)	6dB BANDWIDTH (MHz)		MINIMUM LIMIT (MHz)	PASS / FAIL
		CHAIN 0	CHAIN 1		
1	2412	17.79	17.72	0.5	PASS
6	2437	17.77	17.78	0.5	PASS
11	2462	17.76	17.74	0.5	PASS

### FOR CHAIN 0: CH 1

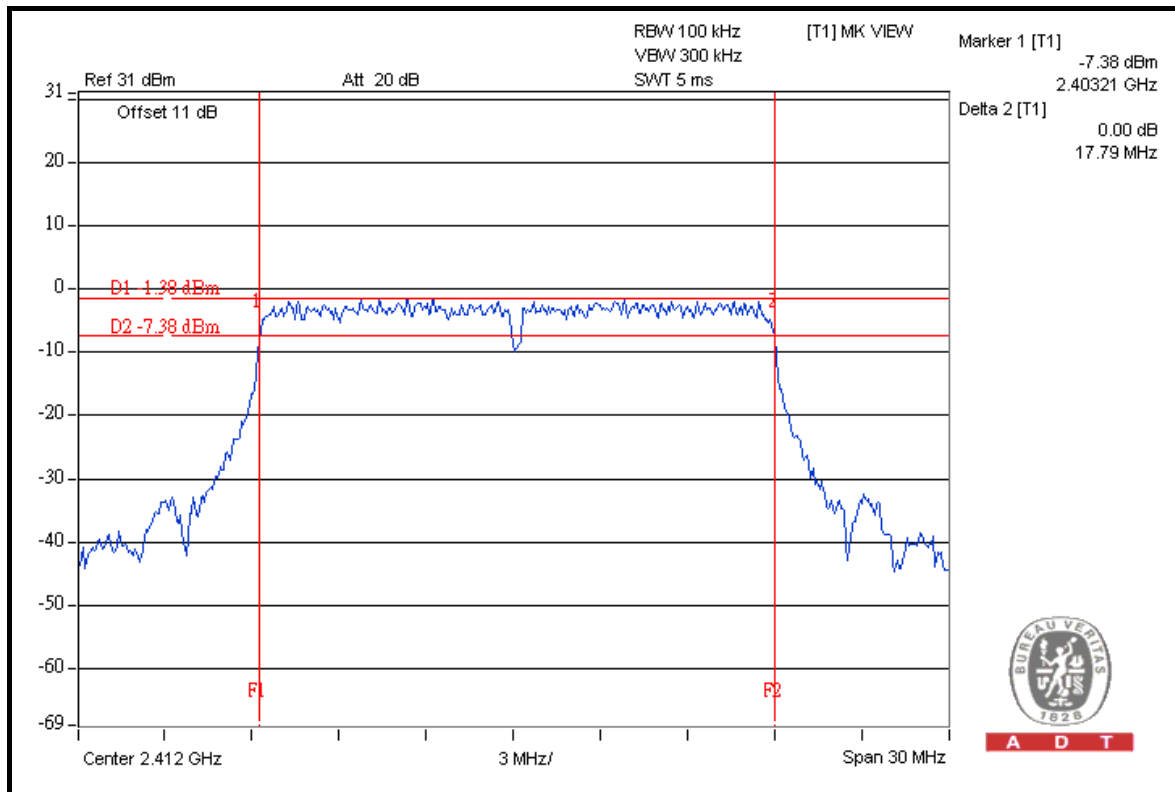



A D T

### 802.11n (40MHz)

CHANNEL	CHANNEL FREQUENCY (MHz)	6dB BANDWIDTH (MHz)		MINIMUM LIMIT (MHz)	PASS / FAIL
		CHAIN 0	CHAIN 1		
1	2422	36.53	36.52	0.5	PASS
4	2437	36.53	36.53	0.5	PASS
7	2452	36.54	36.50	0.5	PASS

### FOR CHAIN 0: CH 7

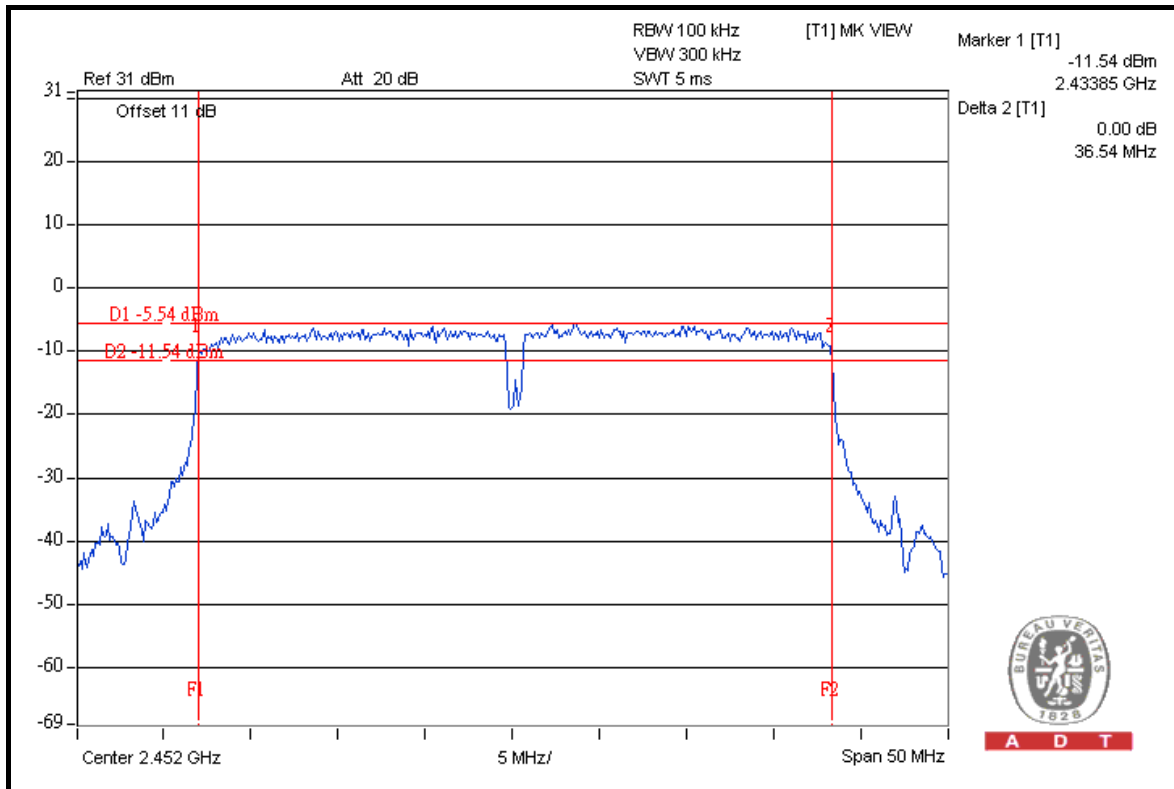



A D T

## 4.4 MAXIMUM OUTPUT POWER

### 4.4.1 LIMITS OF MAXIMUM OUTPUT POWER MEASUREMENT

The Maximum Output Power Measurement is 30dBm.

### 4.4.2 INSTRUMENTS

DESCRIPTION & MANUFACTURER	MODEL NO.	SERIAL NO.	DATE OF CALIBRATION	DUE DATE OF CALIBRATION
High Speed Peak Power Meter	ML2495A	0824012	Aug. 10, 2009	Aug. 09, 2010
Power Sensor	MA2411B	0738138	Aug. 10, 2009	Aug. 09, 2010

**NOTE:**

1. The calibration interval of the above test instruments is 12 months and the calibrations are traceable to NML/ROC and NIST/USA.
2. Measurement Bandwidth of ML2495A is 65MHz greater than 6dB bandwidth of emission.

### 4.4.3 TEST PROCEDURES

A power sensor was used on the output port of the EUT. A power meter was used to read the response of the power sensor. Record the power level.

#### 4.4.4 DEVIATION FROM TEST STANDARD

No deviation.

#### 4.4.5 TEST SETUP

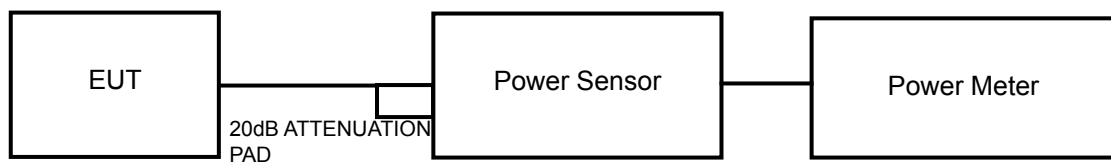

#### 4.4.6 EUT OPERATING CONDITIONS

Same as Item 4.3.6.





#### 4.4.7 TEST RESULTS

##### 802.11b

CHANNEL	CHANNEL FREQUENCY (MHz)	PEAK POWER OUTPUT (mW)	PEAK POWER OUTPUT (dBm)	PEAK POWER LIMIT (dBm)	PASS/FAIL
1	2412	81.3	19.1	30	PASS
6	2437	134.9	21.3	30	PASS
11	2462	79.4	19.0	30	PASS

##### 802.11g

CHANNEL	CHANNEL FREQUENCY (MHz)	PEAK POWER OUTPUT (mW)	PEAK POWER OUTPUT (dBm)	PEAK POWER LIMIT (dBm)	PASS/FAIL
1	2412	295.1	24.7	30	PASS
6	2437	288.4	24.6	30	PASS
11	2462	269.2	24.3	30	PASS

##### 802.11n (20MHz)

CHAN.	CHAN. FREQ. (MHz)	POWER OUTPUT (dBm)		TOTAL POWER (mW)	TOTAL POWER (dBm)	POWER LIMIT (dBm)	PASS / FAIL
		CHAIN 0	CHAIN 1				
1	2412	22.3	22.4	343.6	25.4	30	PASS
6	2437	22.5	22.7	364.0	25.6	30	PASS
11	2462	22.7	22.8	376.8	25.8	30	PASS

##### 802.11n (40MHz)

CHAN.	CHAN. FREQ. (MHz)	POWER OUTPUT (dBm)		TOTAL POWER (mW)	TOTAL POWER (dBm)	POWER LIMIT (dBm)	PASS / FAIL
		CHAIN 0	CHAIN 1				
1	2422	21.3	21.4	272.9	24.4	30	PASS
4	2437	21.4	21.3	272.9	24.4	30	PASS
7	2452	21.5	21.5	282.5	24.5	30	PASS

## 4.5 POWER SPECTRAL DENSITY MEASUREMENT

### 4.5.1 LIMITS OF POWER SPECTRAL DENSITY MEASUREMENT

The Maximum of Power Spectral Density Measurement is 8dBm.

### 4.5.2 TEST INSTRUMENTS

DESCRIPTION & MANUFACTURER	MODEL NO.	SERIAL NO.	DATE OF CALIBRATION	DUE DATE OF CALIBRATION
SPECTRUM ANALYZER R&S	FSP40	100039	Jan. 11, 2010	Jan. 10, 2011

**NOTE:** The calibration interval of the above test instruments is 12 months and the calibrations are traceable to NML/ROC and NIST/USA.

### 4.5.3 TEST PROCEDURE

The transmitter output was connected to the spectrum analyzer through an attenuator, the bandwidth of the fundamental frequency was measured with the spectrum analyzer using 3kHz RBW and 30kHz VBW, set sweep time = span/3kHz. The power spectral density was measured and recorded.

The sweep time is allowed to be longer than span/3kHz for a full response of the mixer in the spectrum analyzer.

#### 4.5.4 DEVIATION FROM TEST STANDARD

No deviation.

#### 4.5.5 TEST SETUP

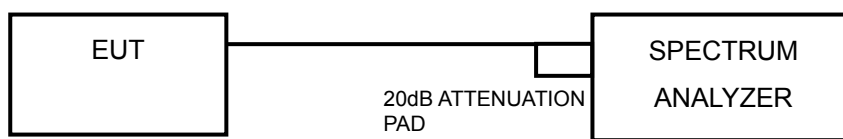

#### 4.5.6 EUT OPERATING CONDITION

Same as Item 4.3.6



A D T

### 4.5.7 TEST RESULTS

#### 802.11b

CHANNEL	CHANNEL FREQUENCY (MHz)	RF POWER LEVEL IN 3 kHz BW (dBm)	MAXIMUM LIMIT (dBm)	PASS/FAIL
1	2412	-14.6	8	PASS
6	2437	-12.5	8	PASS
11	2462	-14.8	8	PASS

#### CH 6

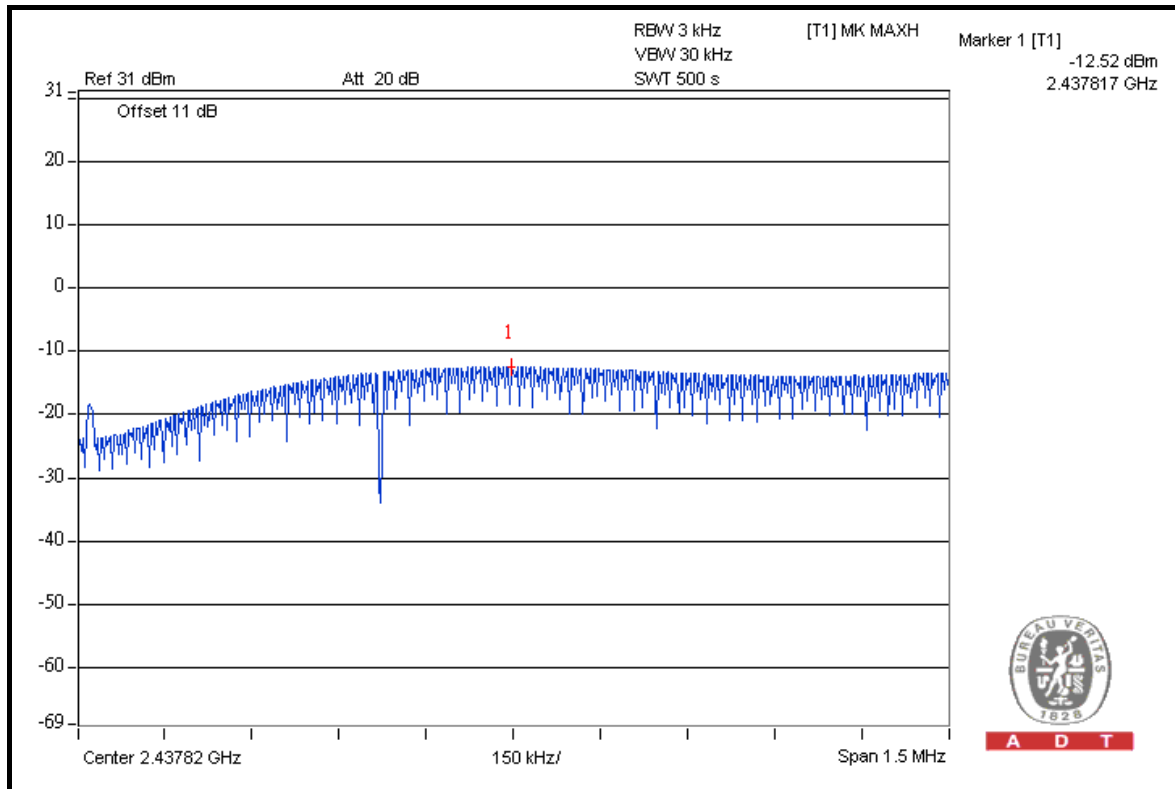



A D T

### 802.11g

CHANNEL	CHANNEL FREQUENCY (MHz)	RF POWER LEVEL IN 3 kHz BW (dBm)	MAXIMUM LIMIT (dBm)	PASS/FAIL
1	2412	-14.1	8	PASS
6	2437	-14.4	8	PASS
11	2462	-14.5	8	PASS

### CH 1

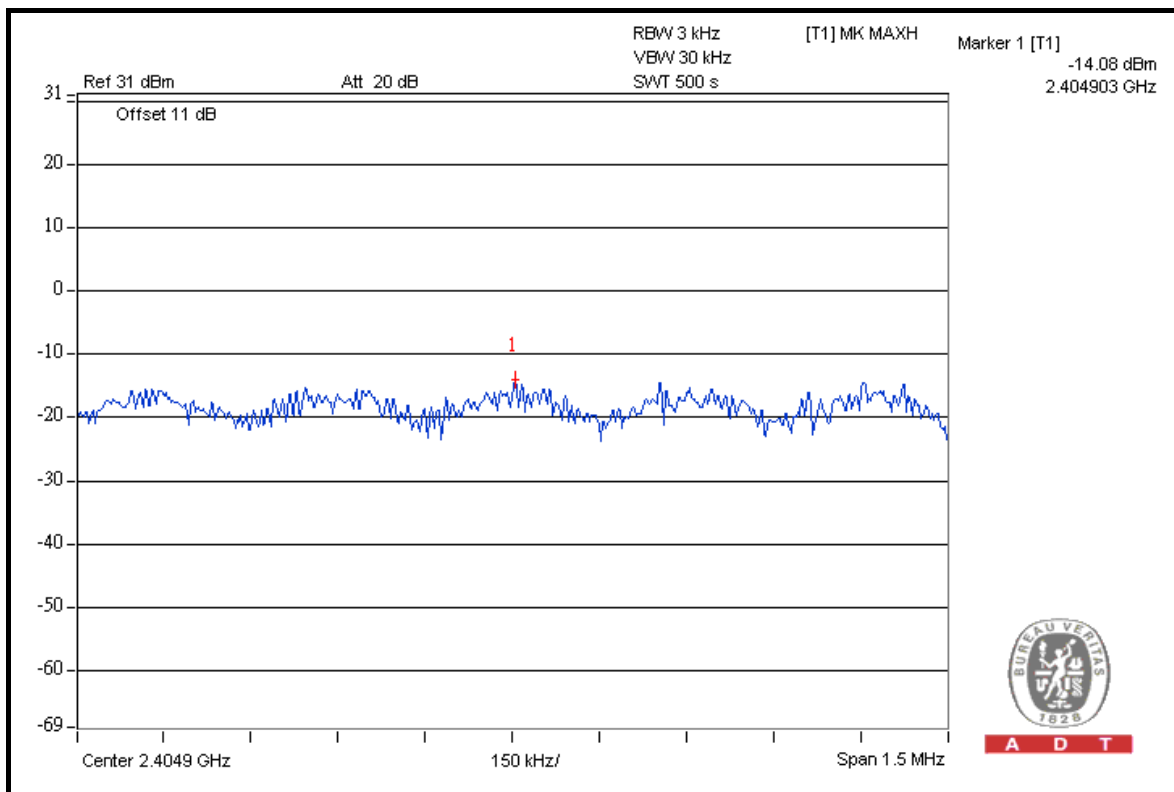

A D T



A D T

### 802.11n (20MHz)

CHAN.	CHAN. FREQ. (MHz)	RF POWER LEVEL IN 3kHz BW (dBm)		TOTAL POWER DENSITY (dBm)	MAX. LIMIT (dBm)	PASS / FAIL
		CHAIN 0	CHAIN 1			
1	2412	-14.8	-15.0	-11.9	8	PASS
6	2437	-14.4	-14.8	-11.6	8	PASS
11	2462	-14.4	-14.5	-11.4	8	PASS

### FOR CHAIN 0: CH 11

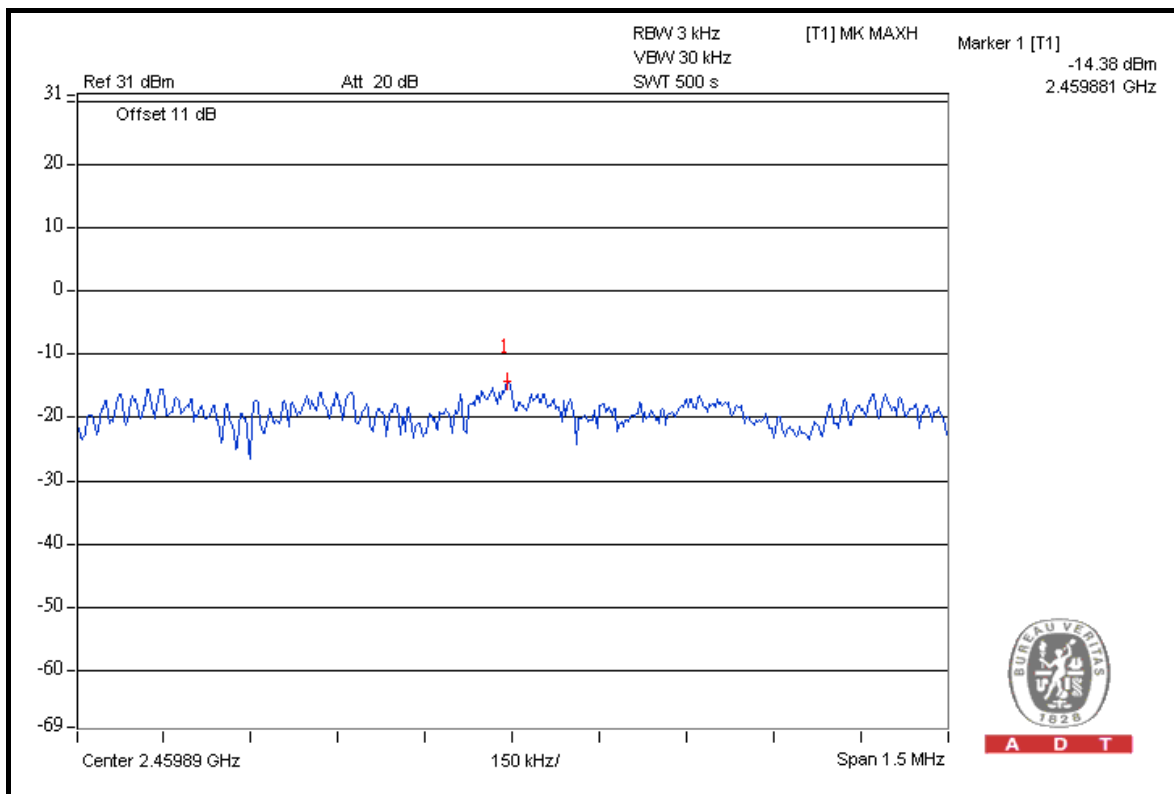



A D T

### 802.11n (40MHz)

CHAN.	CHAN. FREQ. (MHz)	RF POWER LEVEL IN 3kHz BW (dBm)		TOTAL POWER DENSITY (dBm)	MAX. LIMIT (dBm)	PASS / FAIL
		CHAIN 0	CHAIN 1			
1	2422	-18.9	-18.0	-15.4	8	PASS
4	2437	-18.8	-18.0	-15.3	8	PASS
7	2452	-18.6	-17.8	-15.2	8	PASS

### FOR CHAIN 1: CH 7

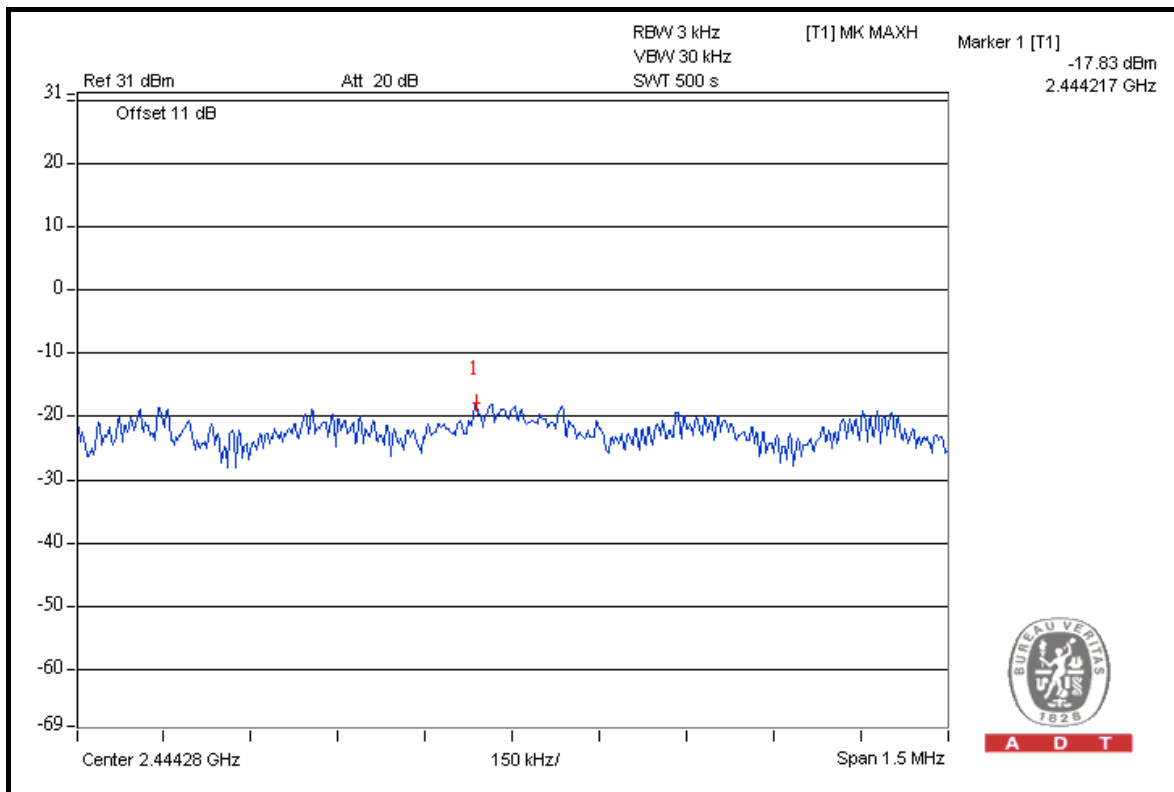



**A D T**

## 4.6 BAND EDGES MEASUREMENT

### 4.6.1 LIMITS OF BAND EDGES MEASUREMENT

Below -20dB of the highest emission level of operating band (in 100kHz Resolution Bandwidth).

### 4.6.2 TEST INSTRUMENTS

DESCRIPTION & MANUFACTURER	MODEL NO.	SERIAL NO.	DATE OF CALIBRATION	DUE DATE OF CALIBRATION
<b>FOR CONDUCTED MEASUREMENT</b>				
R&S SPECTRUM ANALYZER	FSP40	100039	Jan. 11, 2010	Jan. 10, 2011
<b>FOR RADIATED MEASUREMENT</b>				
Test Receiver ROHDE & SCHWARZ	ESI7	838496/016	Dec. 29, 2009	Dec. 28, 2010
Spectrum Analyzer ROHDE & SCHWARZ	FSP40	100039	Jan. 11, 2010	Jan. 10, 2011
BILOG Antenna SCHWARZBECK	VULB9168	9168-155	Apr. 28, 2010	Apr. 27, 2011
HORN Antenna SCHWARZBECK	BBHA 9120D	9120D-408	Jan. 05, 2010	Jan. 04, 2011
HORN Antenna SCHWARZBECK	BBHA 9170	BBHA9170242	Dec. 25, 2009	Dec. 24, 2010
Preamplifier Agilent	8449B	3008A01961	Nov. 04, 2009	Nov. 03, 2010
Preamplifier Agilent	8447D	2944A10738	Nov. 04, 2009	Nov. 03, 2010
RF signal cable HUBER+SUHNNER	SUCOFLEX 104	274041/4	Aug. 28, 2009	Aug. 27, 2010
RF signal cable HUBER+SUHNNER	SUCOFLEX 104	283397/4	Aug. 28, 2009	Aug. 27, 2010
Software ADT.	ADT_Radiated_V7.6.15.9.2	NA	NA	NA
Antenna Tower inn-co GmbH	MA 4000	010303	NA	NA
Antenna Tower Controller inn-co GmbH	CO2000	019303	NA	NA
Turn Table ADT.	TT100.	TT93021704	NA	NA
Turn Table Controller ADT.	SC100.	SC93021704	NA	NA

**NOTE:** The calibration interval of the above test instruments is 12 months and the calibrations are traceable to NML/ROC and NIST/USA.





A D T

#### 4.6.3 TEST PROCEDURE

- a. The EUT was placed on the top of a rotating table 0.8 meters above the ground at a 3 meter semi-anechoic chamber. The table was rotated 360 degrees to determine the position of the highest radiation.
- b. The EUT was set 3 meters away from the interference-receiving antenna, which was mounted on the top of a variable-height antenna tower.
- c. The antenna is a broadband antenna, and its height is varied from one meter to four meters above the ground to determine the maximum value of the field strength. Both horizontal and vertical polarizations of the antenna are set to make the measurement.
- d. For each suspected emission, the EUT was arranged to its worst case and then the antenna was tuned to heights from 1 meter to 4 meters and the rotatable table was turned from 0 degrees to 360 degrees to find the maximum reading.
- e. Set both RBW and VBW of spectrum analyzer to 100kHz and 300kHz with suitable frequency span including 100MHz bandwidth from band edge. The band edges was measured and recorded.

The spectrum plots (Peak RBW = 100kHz, VBW = 300kHz) are attached on the following pages.

**NOTE:** The resolution bandwidth of test receiver/spectrum analyzer is 1MHz and the video bandwidth is 10Hz for Average detection (AV) at frequency above 1GHz.

#### 4.6.4 DEVIATION FROM TEST STANDARD

No deviation.

#### 4.6.5 EUT OPERATING CONDITION

Same as Item 4.3.6.



#### 4.6.6 TEST RESULTS

The spectrum plots are attached on the following pages. D1 line indicates the highest level, and D2 line indicates the 20dB offset below D1. It shows compliance with the requirement in part 15.247(d).

#### 802.11b

##### RESTRICT BAND (2310 ~ 2390 MHz)

FREQUENCY (MHz)	FUNDAMENTAL EMISSION (dBuV/m)	DELTA (dB)	MAXIMUM FIELD STRENGTH IN RESTRICT BAND (dBuV/m)	LIMIT (dBuV/m)
2412.00 (PK)	107.5	49.01	58.49	74.00
2412.00 (AV)	103.4	52.0	51.40	54.00

##### RESTRICT BAND (2483.5 ~ 2500 MHz)

FREQUENCY (MHz)	FUNDAMENTAL EMISSION (dBuV/m)	DELTA (dB)	MAXIMUM FIELD STRENGTH IN RESTRICT BAND (dBuV/m)	LIMIT (dBuV/m)
2462.00 (PK)	107.7	48.96	58.74	74.00
2462.00 (AV)	103.1	51.78	51.32	54.00

**NOTE:**

1. Delta = Amplitude between the peak of the fundamental and the peak of the band edge emission. Please check following 3 pages.
2. Maximum field strength in restrict band = Fundamental emission – Delta.



A D T

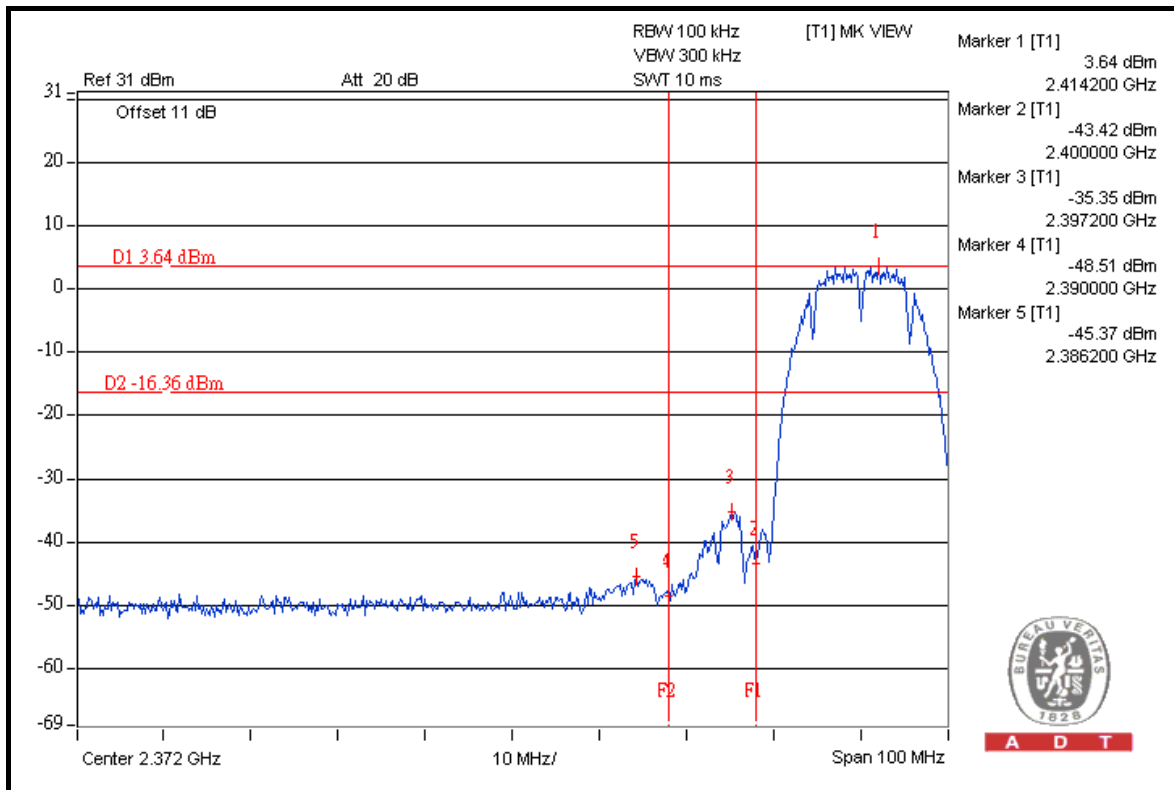

A D T

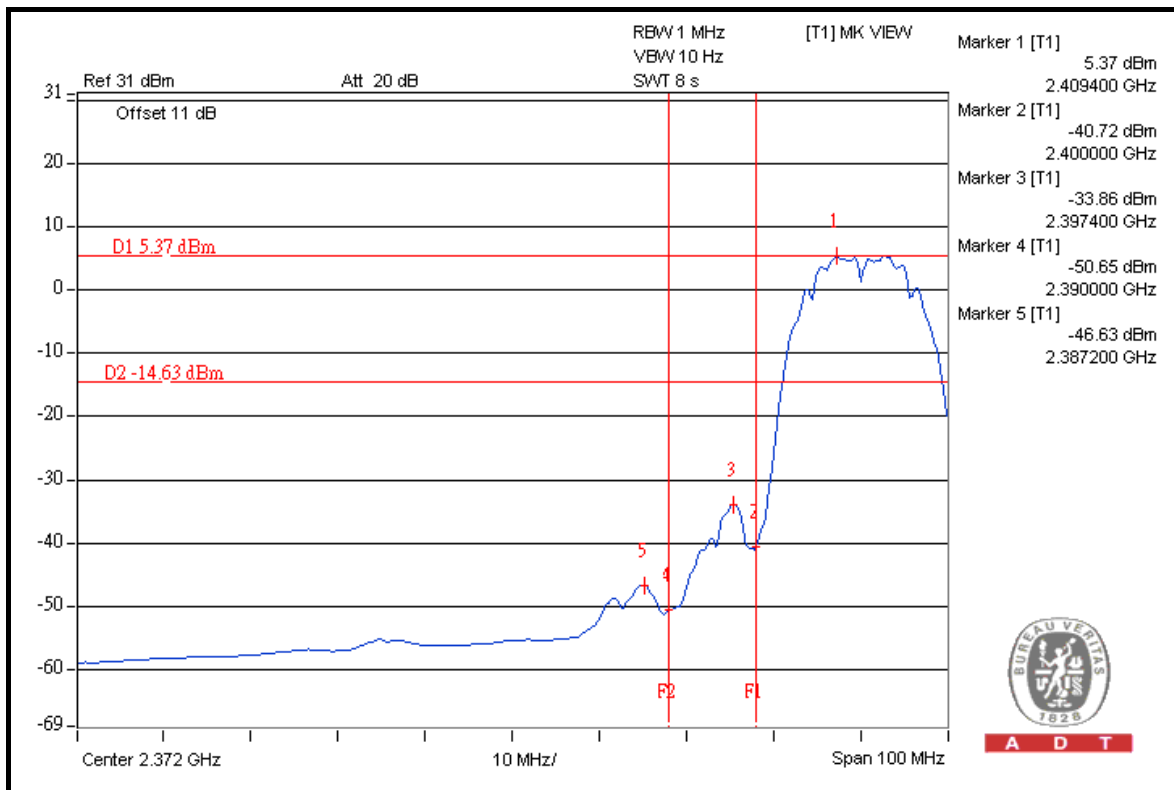

A D T



A D T

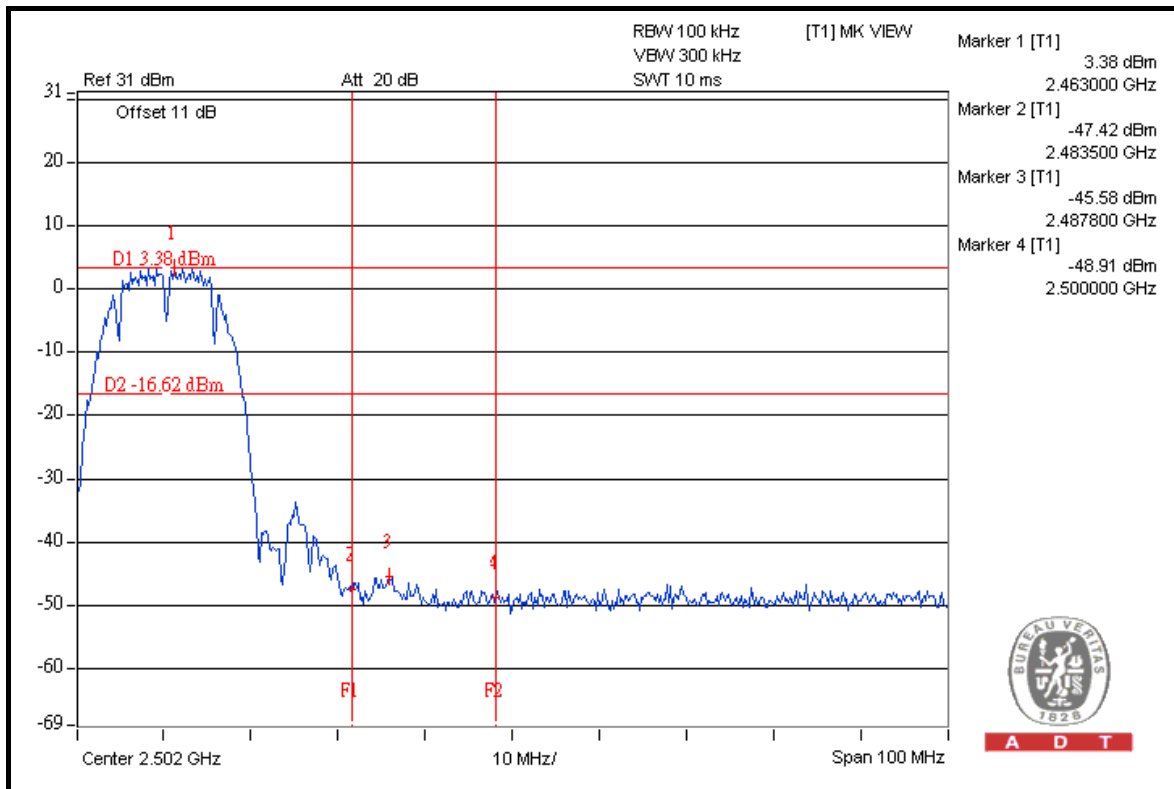
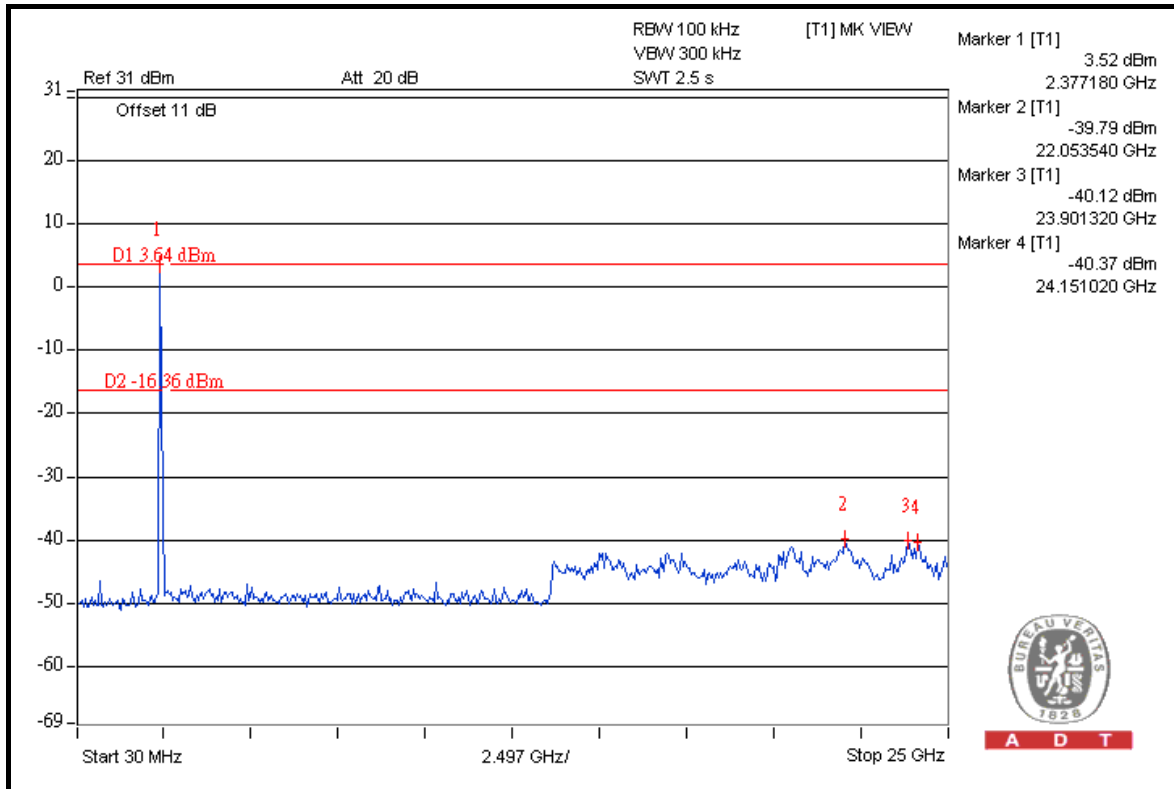



A D T

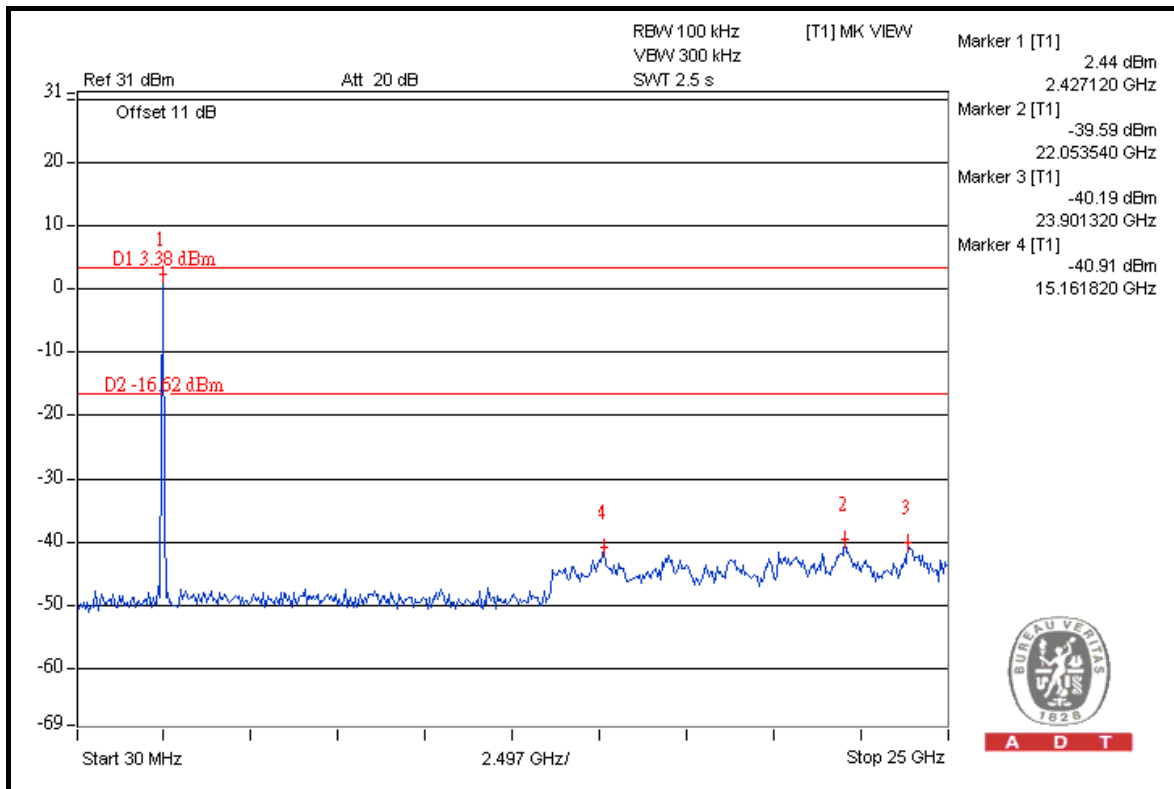
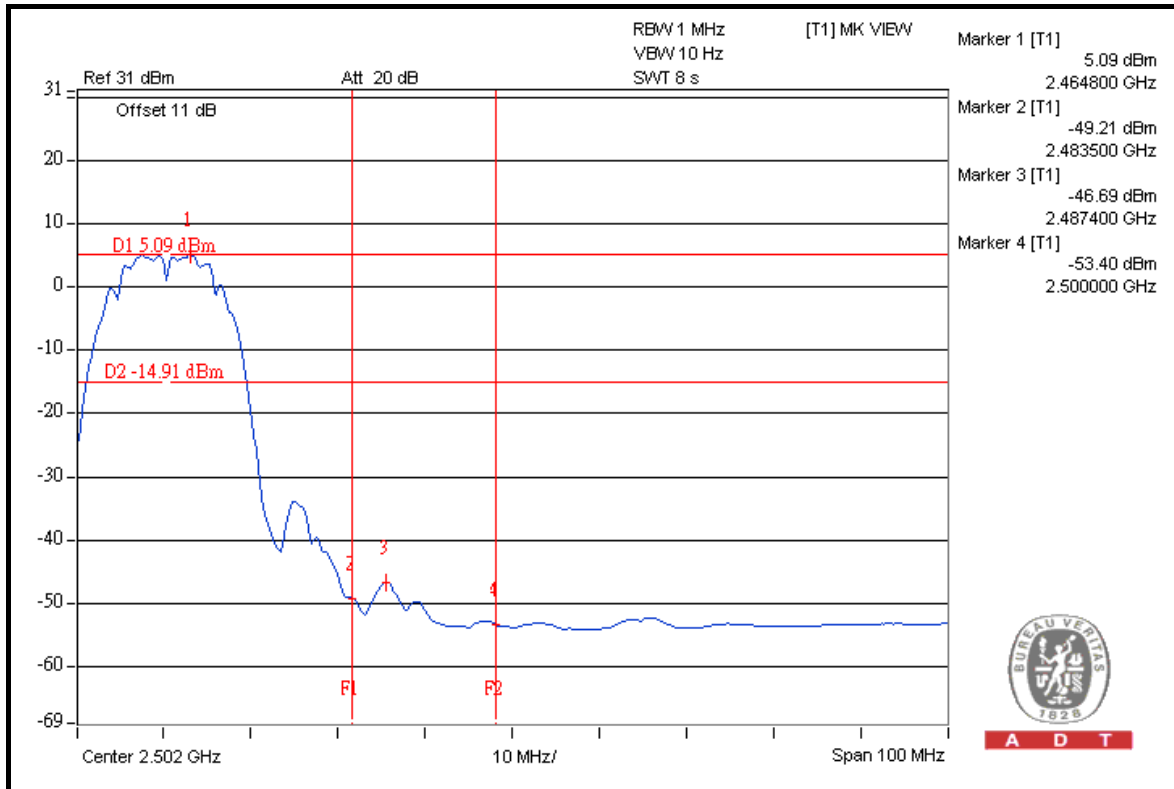



A D T

## 802.11g

### RESTRICT BAND (2310 ~ 2390 MHz)

FREQUENCY (MHz)	FUNDAMENTAL EMISSION (dBuV/m)	DELTA (dB)	MAXIMUM FIELD STRENGTH IN RESTRICT BAND (dBuV/m)	LIMIT (dBuV/m)
2412.00 (PK)	109.6	43.16	66.44	74.00
2412.00 (AV)	100.1	49.03	51.07	54.00

### RESTRICT BAND (2483.5 ~ 2500 MHz)

FREQUENCY (MHz)	FUNDAMENTAL EMISSION (dBuV/m)	DELTA (dB)	MAXIMUM FIELD STRENGTH IN RESTRICT BAND (dBuV/m)	LIMIT (dBuV/m)
2462.00 (PK)	109.5	43.51	65.99	74.00
2462.00 (AV)	99.2	48.09	51.11	54.00

#### NOTE:

1. Delta = Amplitude between the peak of the fundamental and the peak of the band edge emission. Please check following 3 pages.
2. Maximum field strength in restrict band = Fundamental emission – Delta.



A D T

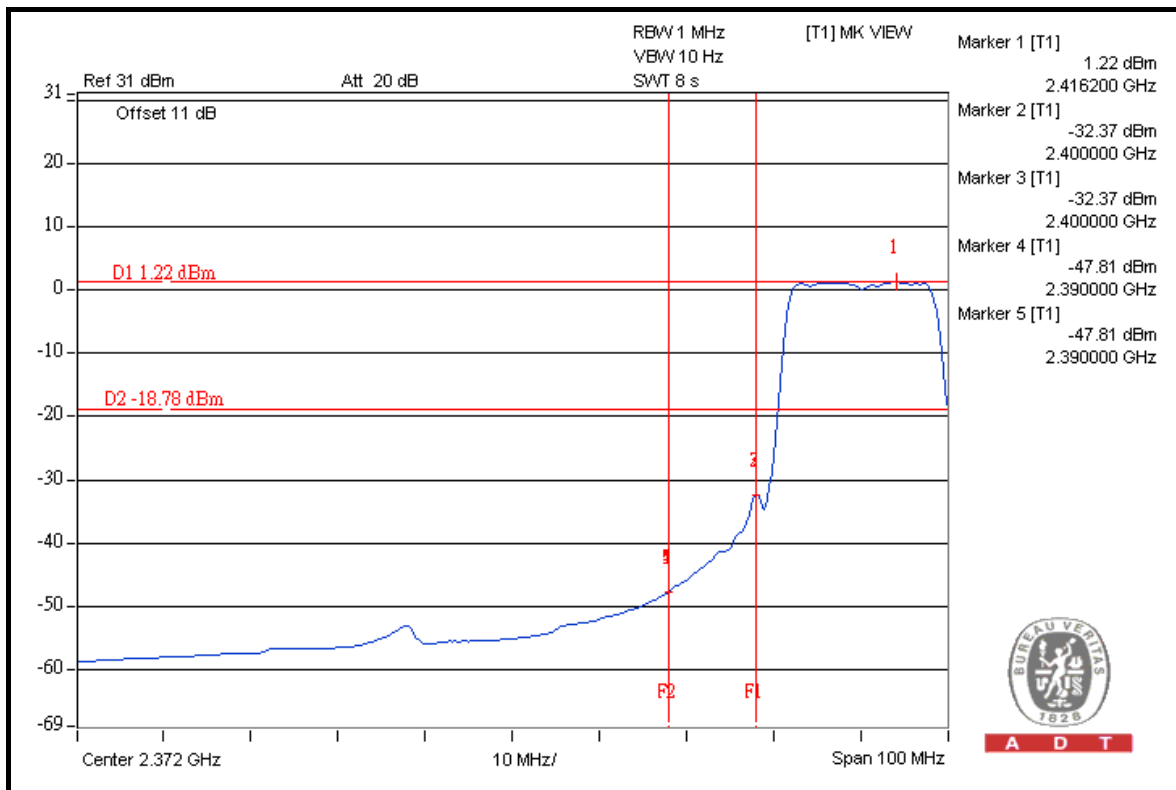
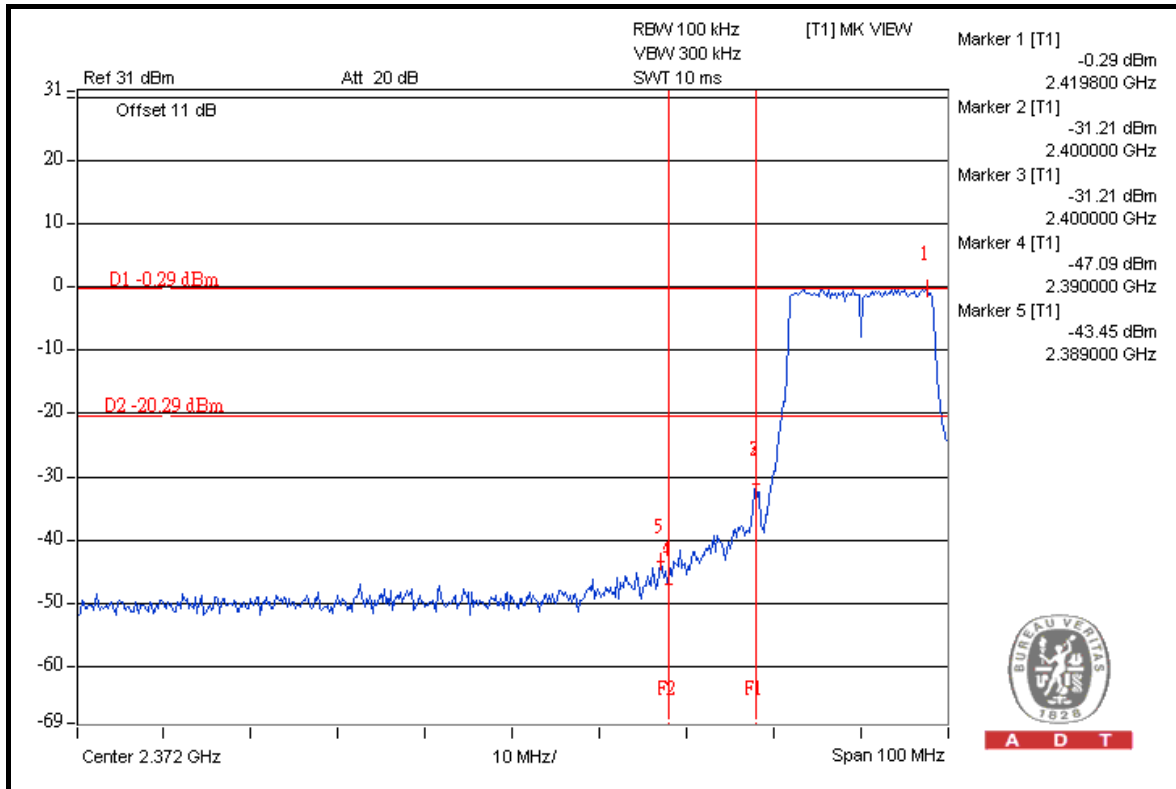



A D T

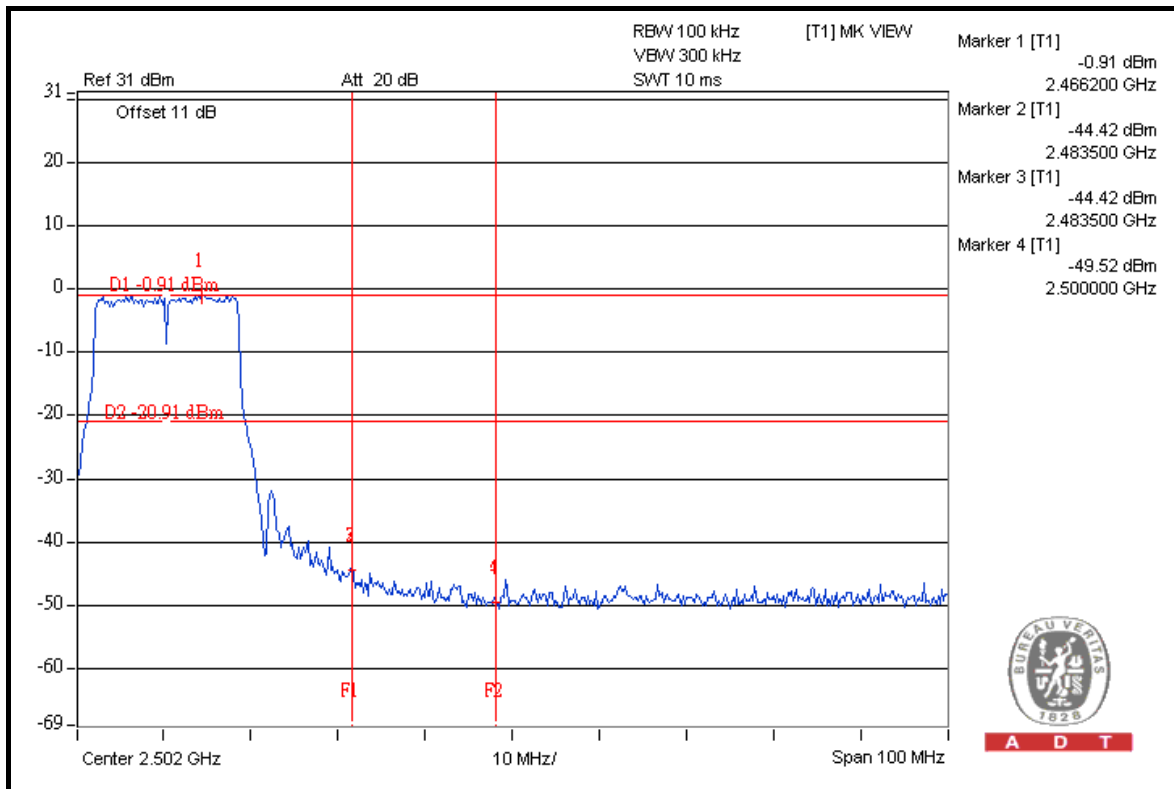
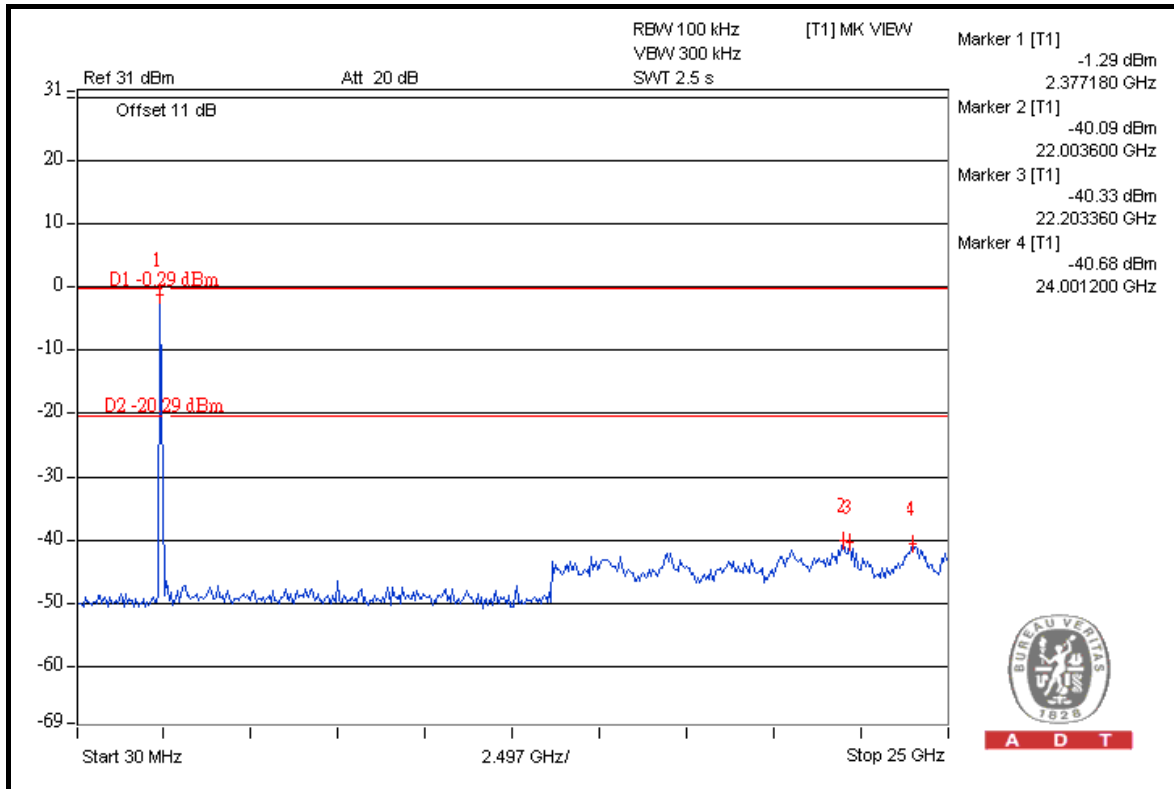





A D T

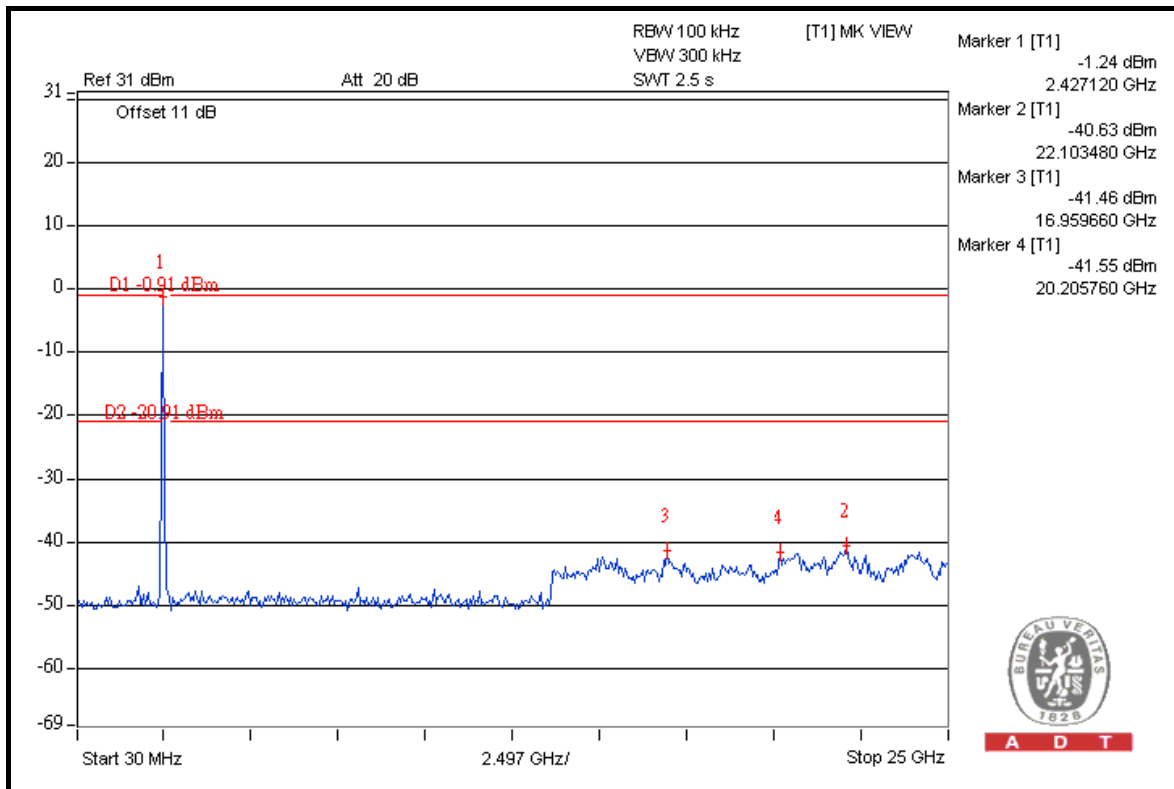
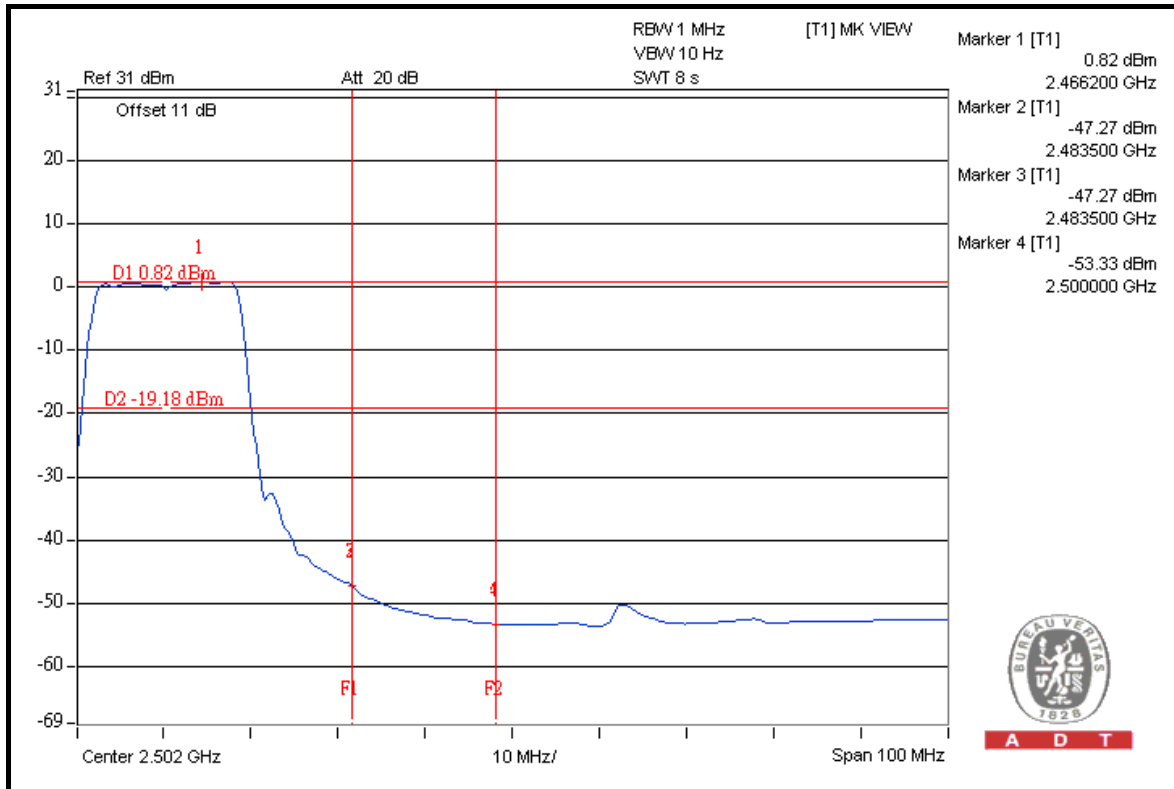



A D T

## 802.11n (20MHz)

### RESTRICT BAND (2310 ~ 2390 MHz)

FREQUENCY (MHz)	FUNDAMENTAL EMISSION (dBuV/m)	DELTA (dB)	MAXIMUM FIELD STRENGTH IN RESTRICT BAND (dBuV/m)	LIMIT (dBuV/m)
2412.00 (PK)	107.2	42.69	64.51	74.00
2412.00 (AV)	97.2	48.29	48.91	54.00

### RESTRICT BAND (2483.5 ~ 2500 MHz)

FREQUENCY (MHz)	FUNDAMENTAL EMISSION (dBuV/m)	DELTA (dB)	MAXIMUM FIELD STRENGTH IN RESTRICT BAND (dBuV/m)	LIMIT (dBuV/m)
2462.00 (PK)	108.1	42.17	65.93	74.00
2462.00 (AV)	97.5	49.07	48.43	54.00

#### NOTE:

1. Delta = Amplitude between the peak of the fundamental and the peak of the band edge emission. Please check following 3 pages.
2. Maximum field strength in restrict band = Fundamental emission – Delta.



A D T

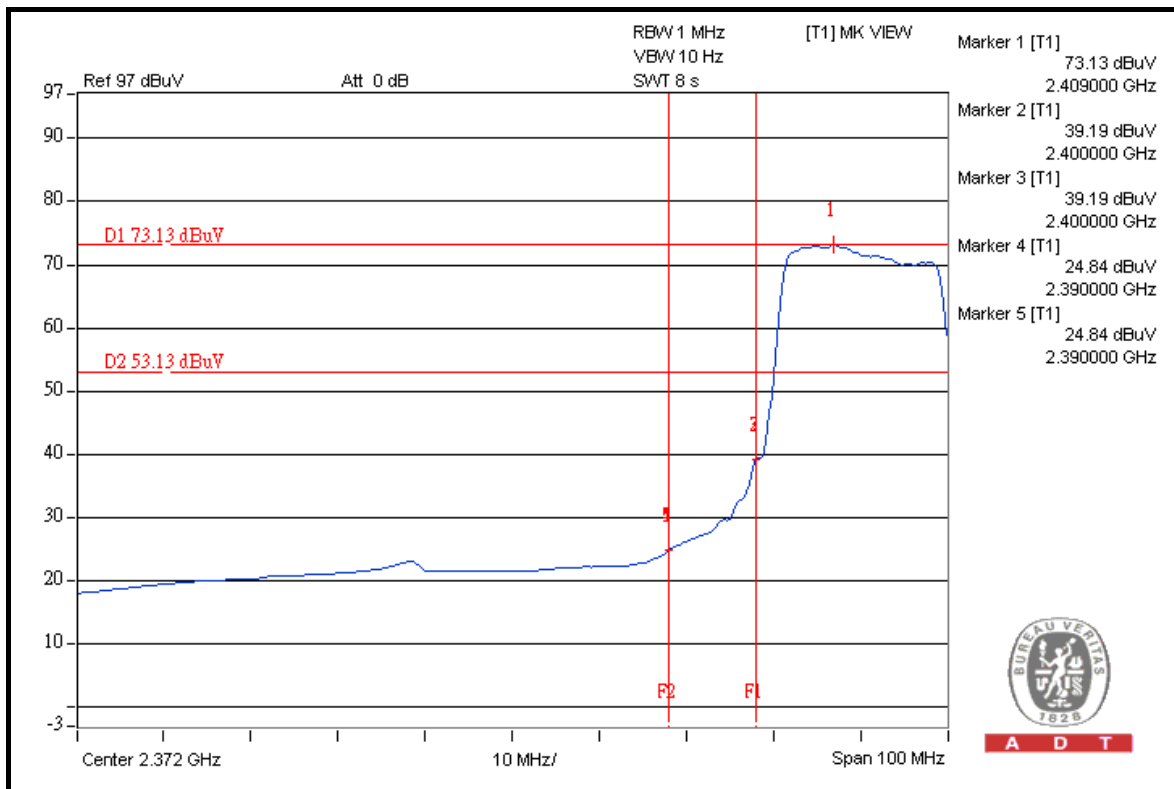
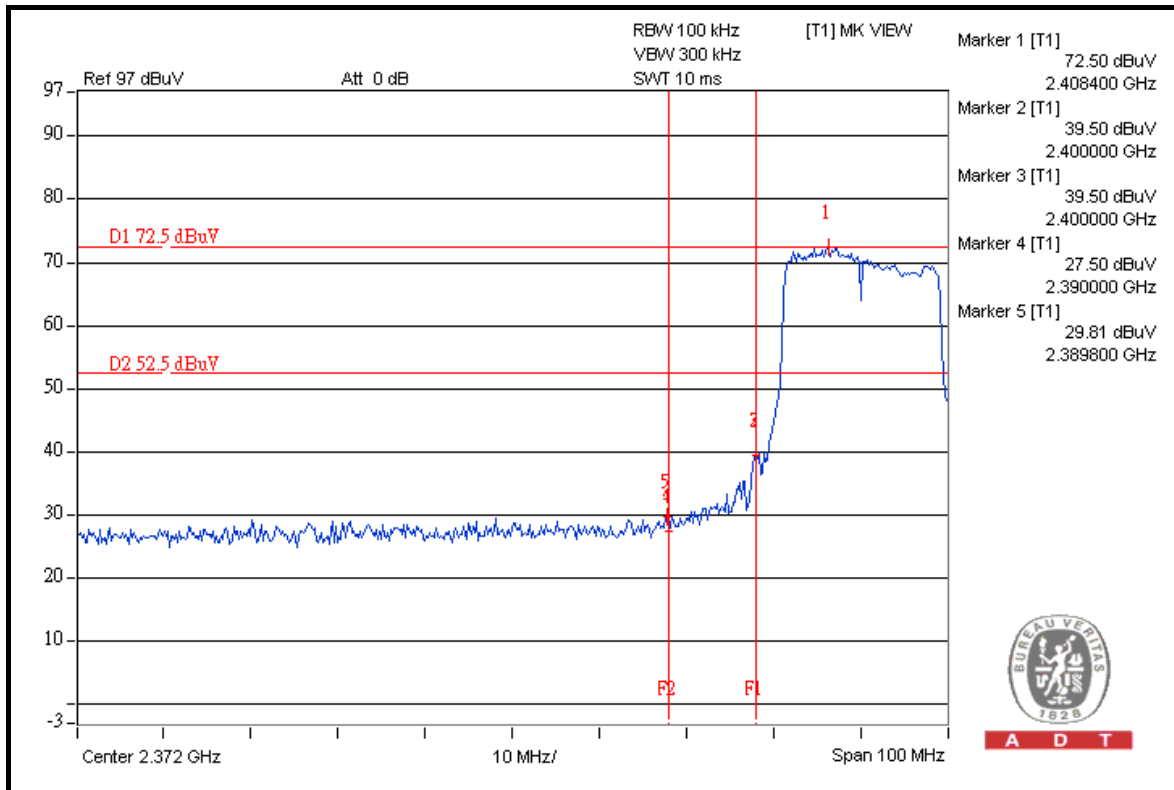



A D T

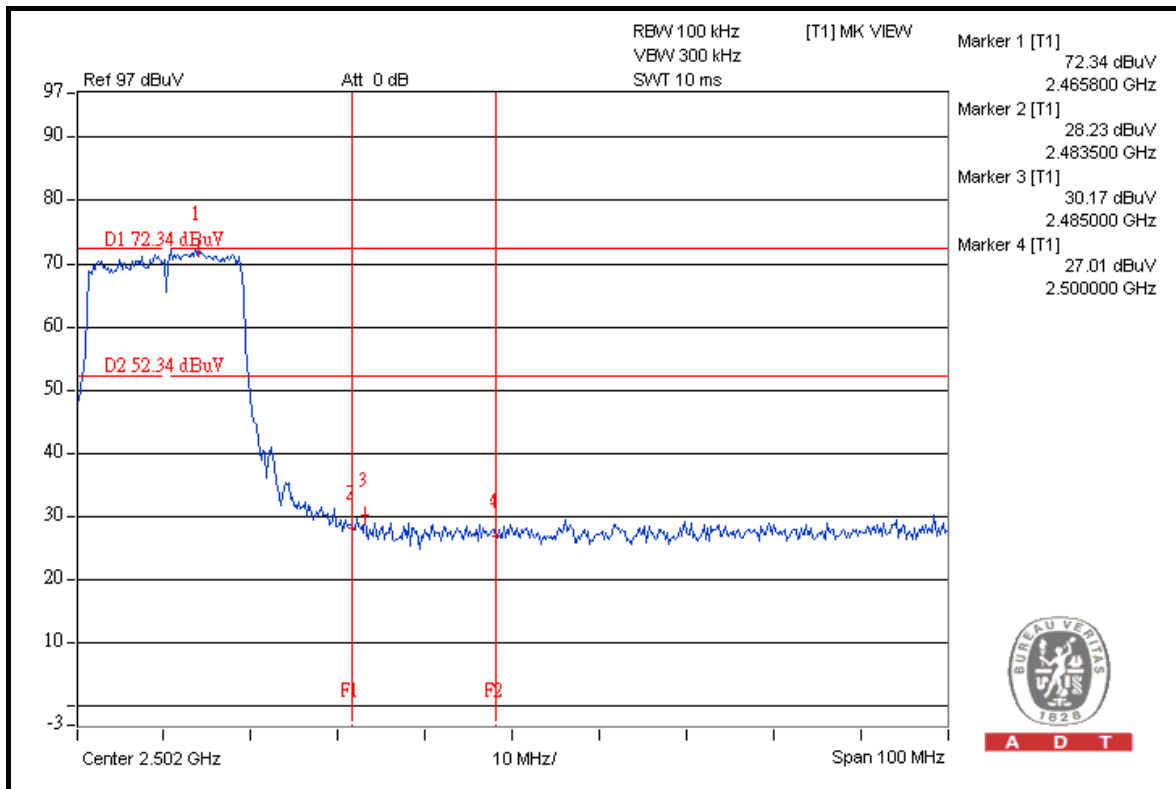
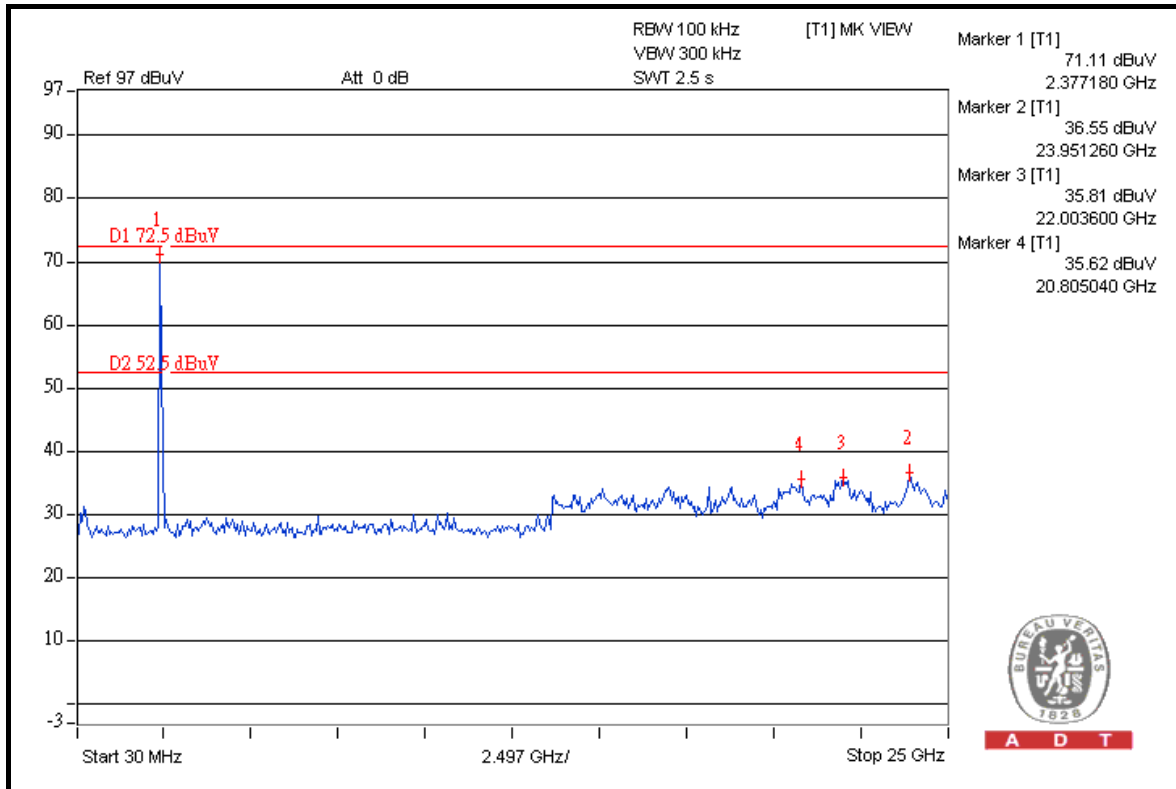



A D T

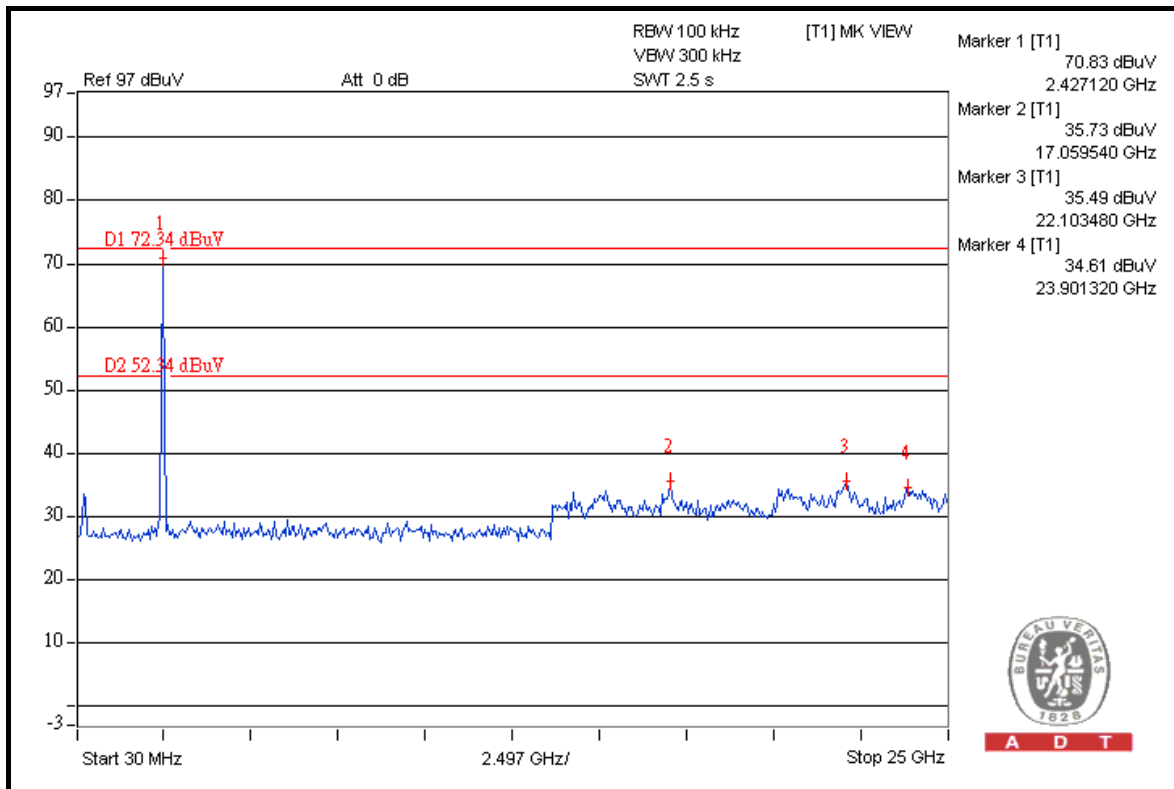
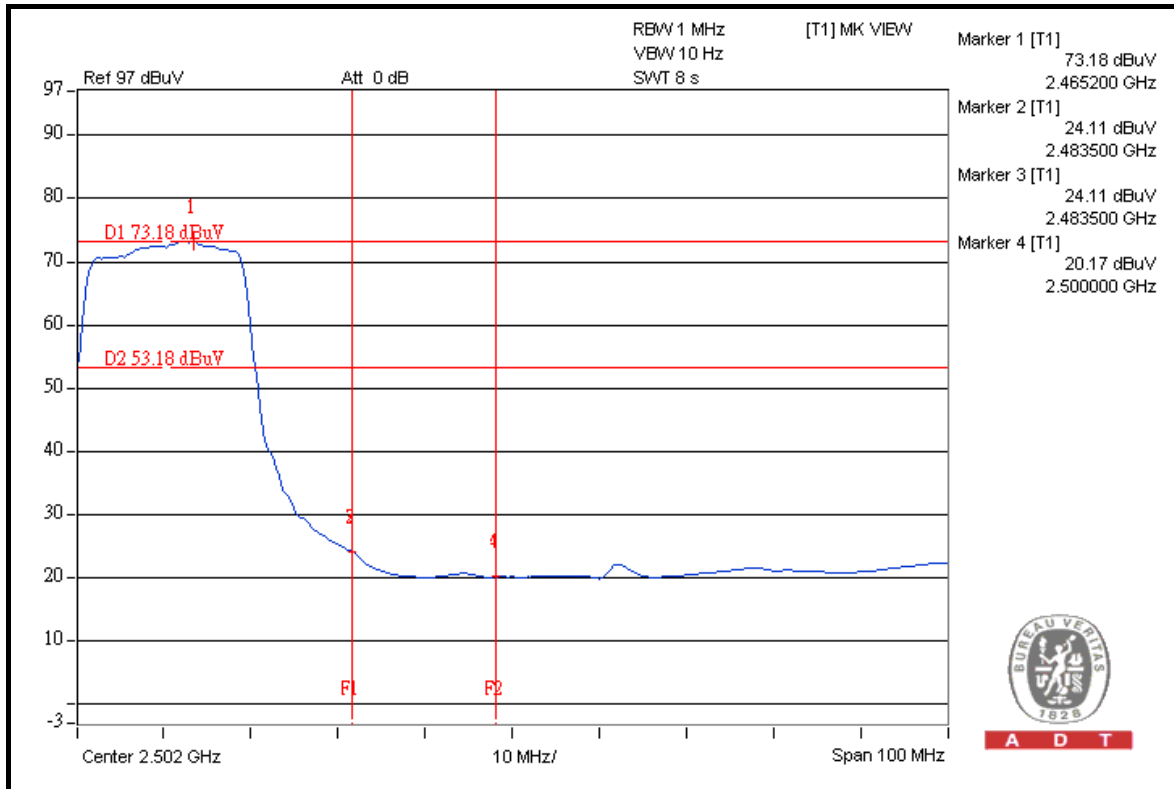



A D T

### 802.11n (40MHz)

#### RESTRICT BAND (2310 ~ 2390 MHz)

FREQUENCY (MHz)	FUNDAMENTAL EMISSION (dBuV/m)	DELTA (dB)	MAXIMUM FIELD STRENGTH IN RESTRICT BAND (dBuV/m)	LIMIT (dBuV/m)
2422.00 (PK)	103.2	39.28	65.88	74.00
2422.00 (AV)	93.1	44.51	52.41	54.00

#### RESTRICT BAND (2483.5 ~ 2500 MHz)

FREQUENCY (MHz)	FUNDAMENTAL EMISSION (dBuV/m)	DELTA (dB)	MAXIMUM FIELD STRENGTH IN RESTRICT BAND (dBuV/m)	LIMIT (dBuV/m)
2452.00 (PK)	103.0	39.29	63.71	74.00
2452.00 (AV)	92.4	46.94	45.46	54.00

#### NOTE:

1. Delta = Amplitude between the peak of the fundamental and the peak of the band edge emission. Please check following 3 pages.
2. Maximum field strength in restrict band = Fundamental emission – Delta.



A D T

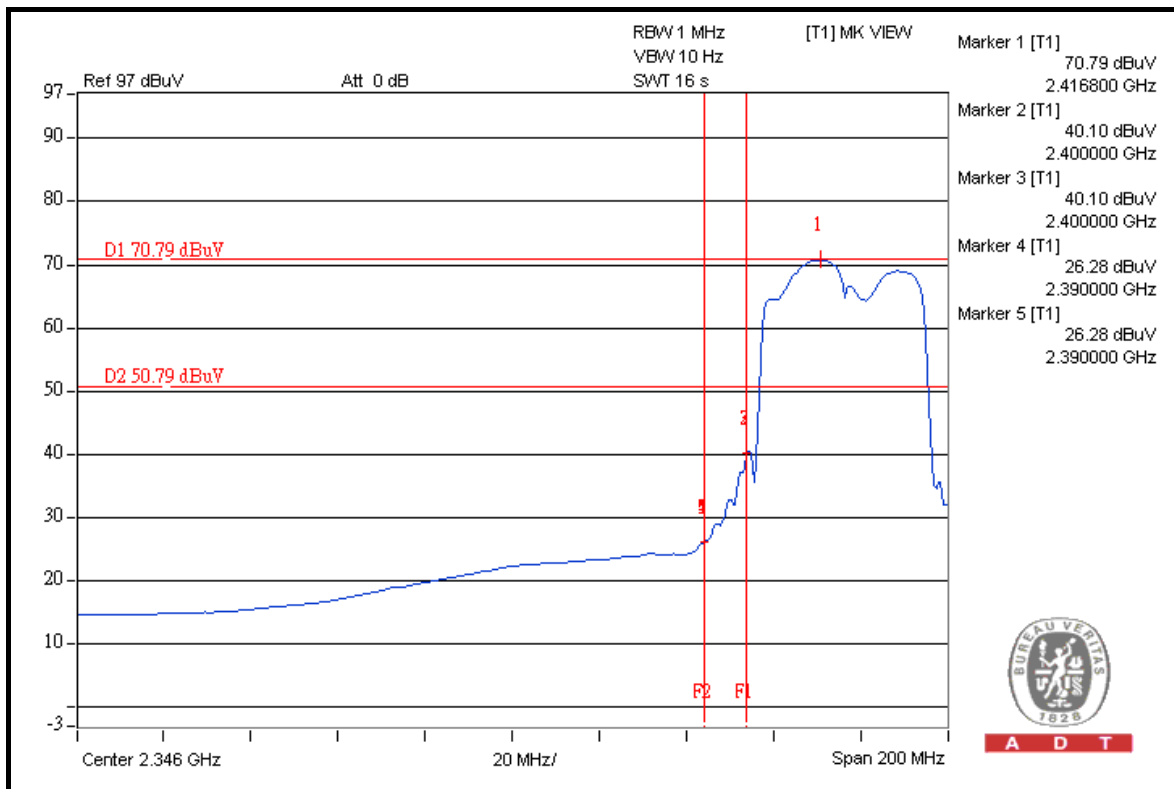
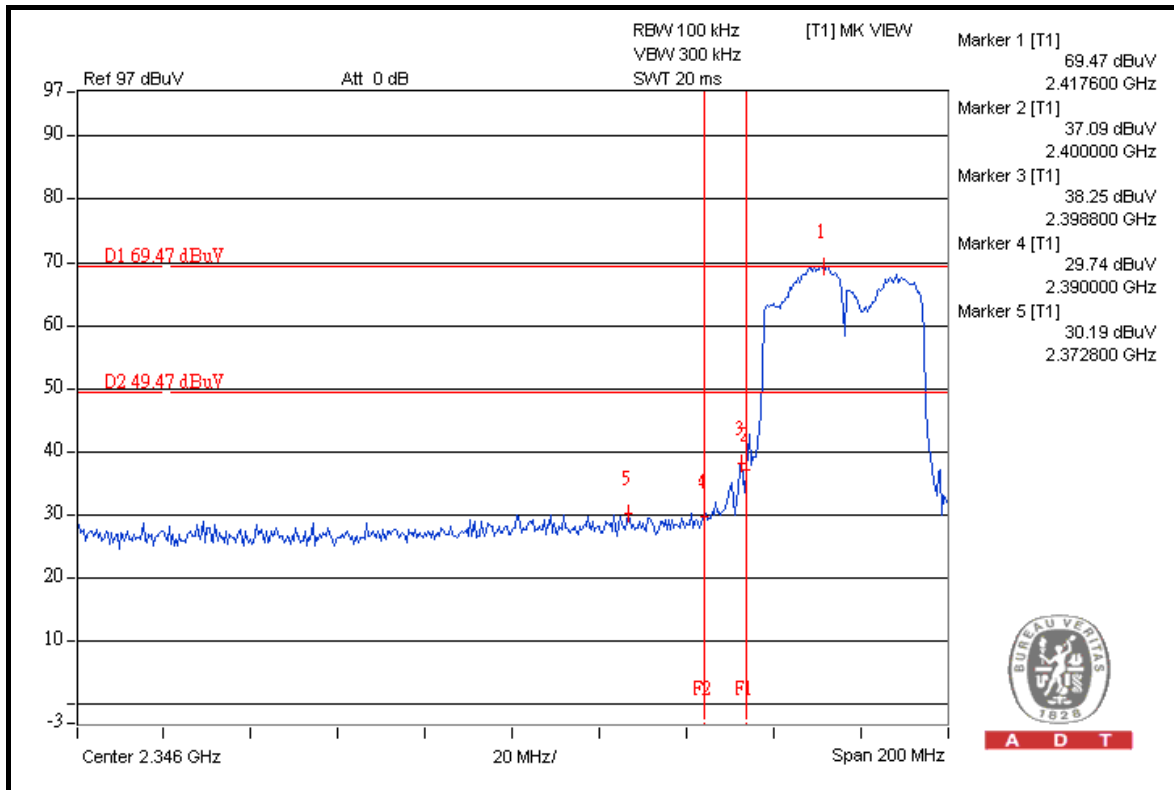



A D T

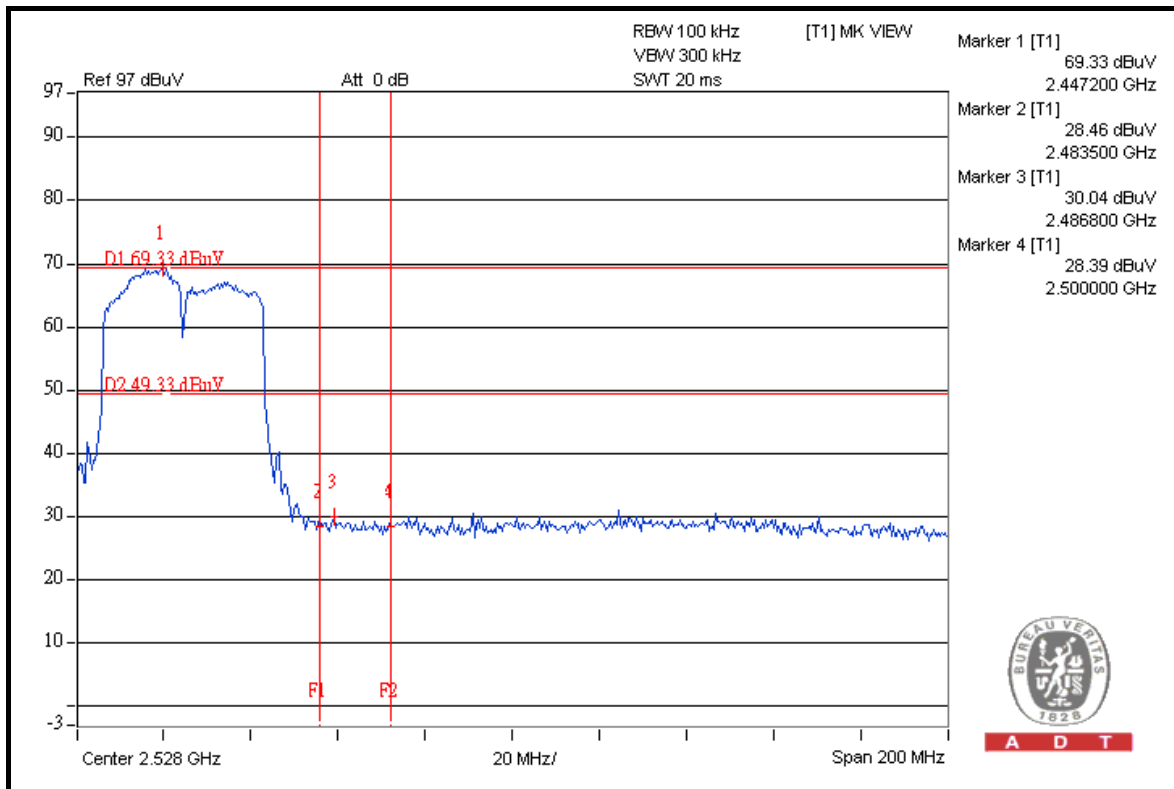
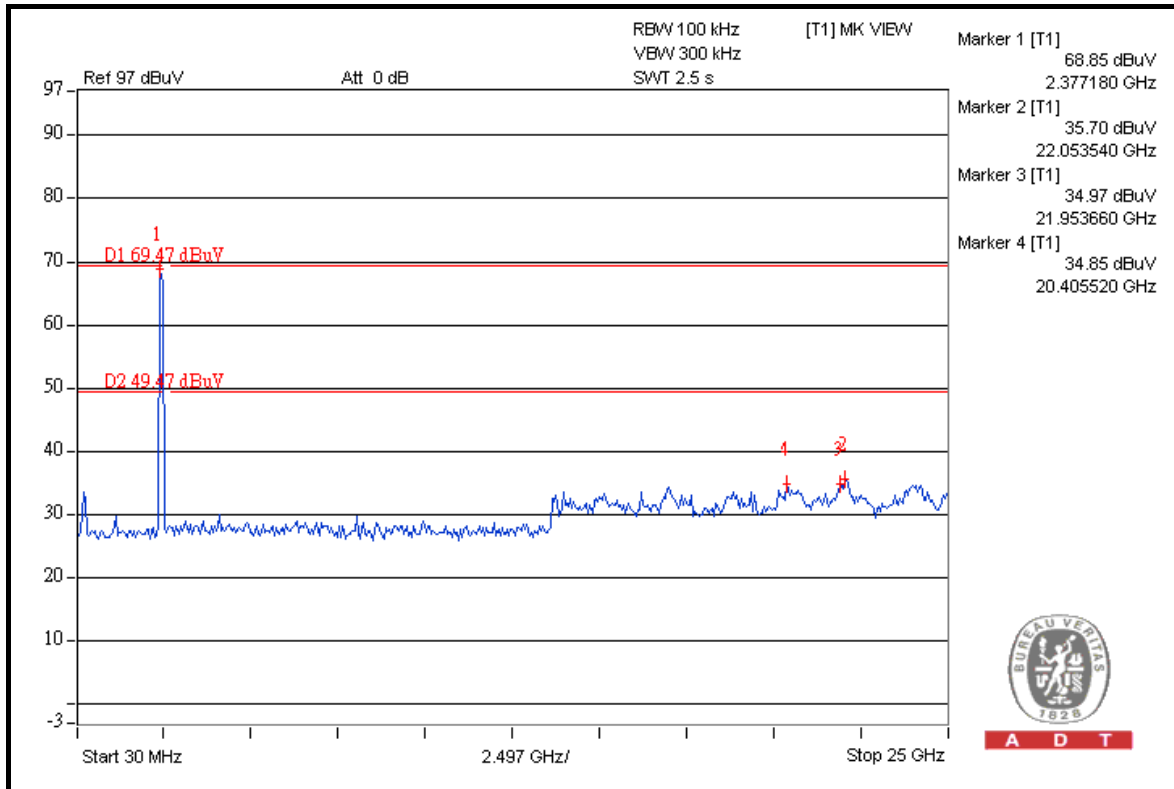





A D T

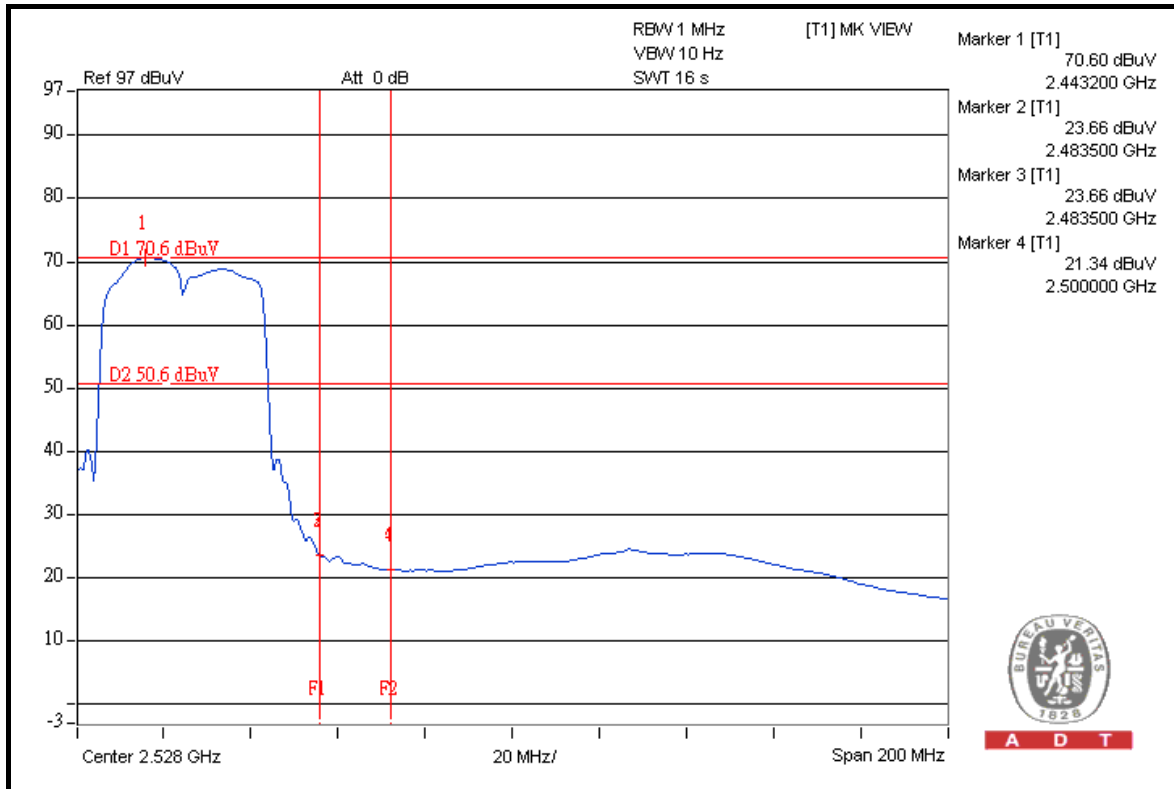

A D T

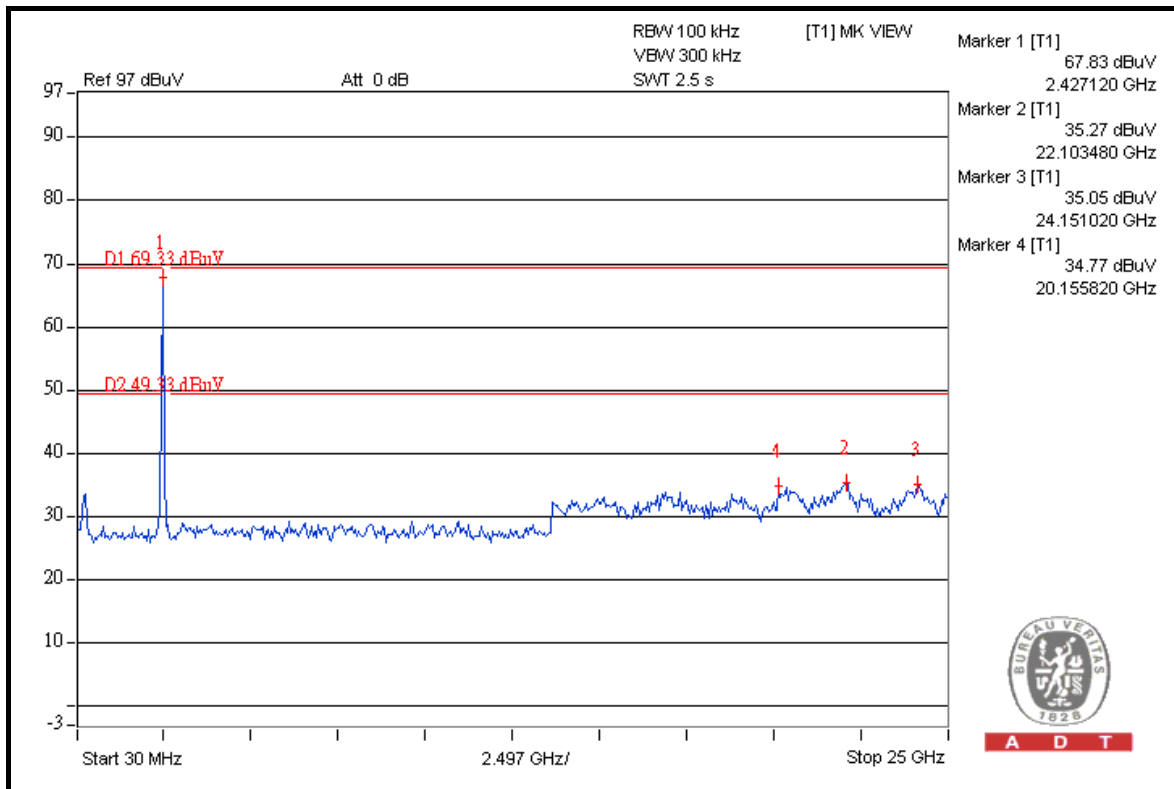

A D T



A D T

## 5. PHOTOGRAPHS OF THE TEST CONFIGURATION

Please refer to the attached file (Test Setup Photo).



A D T

## 6. INFORMATION ON THE TESTING LABORATORIES

We, Bureau Veritas Consumer Products Services (H.K.) Ltd., Taoyuan Branch, were founded in 1988 to provide our best service in EMC, Radio, Telecom and Safety consultation. Our laboratories are accredited and approved according to ISO/IEC 17025.

Copies of accreditation certificates of our laboratories obtained from approval agencies can be downloaded from our web site:

[www.adt.com.tw/index.5/phtml](http://www.adt.com.tw/index.5/phtml). If you have any comments, please feel free to contact us at the following:

**Linko EMC/RF Lab:**

Tel: 886-2-26052180

Fax: 886-2-26051924

**Hsin Chu EMC/RF Lab:**

Tel: 886-3-5935343

Fax: 886-3-5935342

**Hwa Ya EMC/RF/Safety Telecom Lab:**

Tel: 886-3-3183232

Fax: 886-3-3185050

**Web Site:** [www.adt.com.tw](http://www.adt.com.tw)

The address and road map of all our labs can be found in our web site also.



A D T

## **7. APPENDIX A - MODIFICATIONS RECORDERS FOR ENGINEERING CHANGES TO THE EUT BY THE LAB**

No any modifications are made to the EUT by the lab during the test.

**---END---**