



FCC TEST REPORT (15.247)

REPORT NO.: RF940321L05A
MODEL NO.: WL-760A
OEM MODEL NO.: TEW-503PI
TESTED: Mar. 10 ~ Mar. 23, 2005
ISSUED: May 28, 2005

APPLICANT: SparkLAN Communications, Inc.

ADDRESS: 3Fl., No. 246, Sec. 1, Neihu Road., Neihu
Chiu, Taipei Taiwan 114, R.O.C.

ISSUED BY: Advance Data Technology Corporation

LAB ADDRESS: No. 47, 14th Ling, Chia Pau Tsuen, Lin Kou
Hsiang 244, Taipei Hsien, Taiwan, R.O.C.

TEST LOCATION: No. 19, Hwa Ya 2nd Rd., Wen Hwa Tsuen,
Kwei Shan Hsiang, Taoyuan Hsien 333,
Taiwan, R.O.C.

This test report consists of 116 pages in total. It may be duplicated completely for legal use with the approval of the applicant. It should not be reproduced except in full, without the written approval of our laboratory. The client should not use it to claim product endorsement by CNLA, A2LA or any government agencies. The test results in the report only apply to the tested sample.



0528
ILAC MRA



No. 2177-01



Table of Contents

1.	CERTIFICATION	5
2.	SUMMARY OF TEST RESULTS	6
2.1	MEASUREMENT UNCERTAINTY	6
3.	GENERAL INFORMATION.....	7
3.1	GENERAL DESCRIPTION OF EUT	7
3.2	DESCRIPTION OF TEST MODES.....	8
3.2.1	CONFIGURATION OF SYSTEM UNDER TEST	9
3.2.2	TEST MODE APPLICABILITY AND TESTED CHANNEL DETAIL:.....	10
3.3	GENERAL DESCRIPTION OF APPLIED STANDARDS	12
3.4	DESCRIPTION OF SUPPORT UNITS	12
4.	TEST TYPES AND RESULTS (802.11b & g 2412~2462MHz BAND)	13
4.1	CONDUCTED EMISSION MEASUREMENT	13
4.1.1	LIMITS OF CONDUCTED EMISSION MEASUREMENT.....	13
4.1.2	TEST INSTRUMENTS.....	13
4.1.3	TEST PROCEDURES	14
4.1.4	DEVIATION FROM TEST STANDARD	14
4.1.5	TEST SETUP	15
4.1.6	EUT OPERATING CONDITIONS	15
4.1.7	TEST RESULTS	16
4.2	RADIATED EMISSION MEASUREMENT	22
4.2.1	LIMITS OF RADIATED EMISSION MEASUREMENT.....	22
4.2.2	TEST INSTRUMENTS.....	23
4.2.3	TEST PROCEDURES	24
4.2.4	DEVIATION FROM TEST STANDARD	24
4.2.5	TEST SETUP	25
4.2.6	EUT OPERATING CONDITIONS	25
4.2.7	TEST RESULTS	26
4.3	6dB BANDWIDTH MEASUREMENT	34
4.3.1	LIMITS OF 6dB BANDWIDTH MEASUREMENT	34
4.3.2	TEST INSTRUMENTS.....	34
4.3.3	TEST PROCEDURE.....	35
4.3.4	DEVIATION FROM TEST STANDARD	35
4.3.5	TEST SETUP	35
4.3.6	EUT OPERATING CONDITIONS	35
4.3.7	TEST RESULTS	36
4.4	MAXIMUM PEAK OUTPUT POWER	44
4.4.1	LIMITS OF MAXIMUM PEAK OUTPUT POWER MEASUREMENT	44
4.4.2	INSTRUMENTS.....	44



4.4.3	TEST PROCEDURES	45
4.4.4	DEVIATION FROM TEST STANDARD	45
4.4.5	TEST SETUP	45
4.4.6	EUT OPERATING CONDITIONS	45
4.4.7	TEST RESULTS	46
4.5	POWER SPECTRAL DENSITY MEASUREMENT	48
4.5.1	LIMITS OF POWER SPECTRAL DENSITY MEASUREMENT	48
4.5.2	TEST INSTRUMENTS.....	48
4.5.3	TEST PROCEDURE.....	49
4.5.4	DEVIATION FROM TEST STANDARD	49
4.5.5	TEST SETUP	49
4.5.6	EUT OPERATING CONDITION	49
4.5.7	TEST RESULTS	50
4.6	BAND EDGES MEASUREMENT	58
4.6.1	LIMITS OF BAND EDGES MEASUREMENT	58
4.6.2	TEST INSTRUMENTS.....	58
4.6.3	TEST PROCEDURE.....	58
4.6.4	DEVIATION FROM TEST STANDARD	58
4.6.5	EUT OPERATING CONDITION	58
4.6.6	TEST RESULTS	59
4.7	ANTENNA REQUIREMENT	71
4.7.1	STANDARD APPLICABLE	71
4.7.2	ANTENNA CONNECTED CONSTRUCTION.....	71
5.	TEST TYPES AND RESULTS (802.11a 5725~5850MHz BAND)	72
5.1	CONDUCTED EMISSION MEASUREMENT	72
5.1.1	LIMITS OF CONDUCTED EMISSION MEASUREMENT.....	72
5.1.2	TEST INSTRUMENTS.....	72
5.1.3	TEST PROCEDURES	73
5.1.4	DEVIATION FROM TEST STANDARD	73
5.1.5	TEST SETUP	74
5.1.6	EUT OPERATING CONDITIONS	74
5.1.7	TEST RESULTS	75
5.2	RADIATED EMISSION MEASUREMENT	77
5.2.1	LIMITS OF RADIATED EMISSION MEASUREMENT.....	77
5.2.2	TEST INSTRUMENTS.....	78
5.2.3	TEST PROCEDURES	79
5.2.4	DEVIATION FROM TEST STANDARD	79
5.2.5	TEST SETUP	80
5.2.6	EUT OPERATING CONDITIONS	80
5.2.7	TEST RESULTS	81
5.3	6dB BANDWIDTH MEASUREMENT	87



5.3.1	LIMITS OF 6dB BANDWIDTH MEASUREMENT	87
5.3.2	TEST INSTRUMENTS.....	87
5.3.3	TEST PROCEDURE.....	88
5.3.4	DEVIATION FROM TEST STANDARD	88
5.3.5	TEST SETUP	88
5.3.6	EUT OPERATING CONDITIONS	88
5.3.7	TEST RESULTS	89
5.4	MAXIMUM PEAK OUTPUT POWER	94
5.4.1	LIMITS OF MAXIMUM PEAK OUTPUT POWER MEASUREMENT	94
5.4.2	INSTRUMENTS.....	94
5.4.3	TEST PROCEDURES	95
5.4.4	DEVIATION FROM TEST STANDARD	95
5.4.5	TEST SETUP	95
5.4.6	EUT OPERATING CONDITIONS	95
5.4.7	TEST RESULTS	96
5.5	POWER SPECTRAL DENSITY MEASUREMENT.....	98
5.5.1	LIMITS OF POWER SPECTRAL DENSITY MEASUREMENT	98
5.5.2	TEST INSTRUMENTS.....	98
5.5.3	TEST PROCEDURE.....	99
5.5.4	DEVIATION FROM TEST STANDARD	99
5.5.5	TEST SETUP	99
5.5.6	EUT OPERATING CONDITION	99
5.5.7	TEST RESULTS	100
5.6	BAND EDGES MEASUREMENT	105
5.6.1	LIMITS OF BAND EDGES MEASUREMENT	105
5.6.2	TEST INSTRUMENTS.....	105
5.6.3	TEST PROCEDURE.....	105
5.6.4	DEVIATION FROM TEST STANDARD	105
5.6.5	EUT OPERATING CONDITION	106
5.6.6	TEST RESULTS	106
5.7	ANTENNA REQUIREMENT	113
5.7.1	STANDARD APPLICABLE	113
5.7.2	ANTENNA CONNECTED CONSTRUCTION.....	113
6.	PHOTOGRAPHS OF THE TEST CONFIGURATION.....	114
7.	INFORMATION ON THE TESTING LABORATORIES	116



1. CERTIFICATION

PRODUCT: WLAN 802.11a/b/g PCI Adapter
OEM PRODUCT NAME: 108Mbps Wireless PCI Adapter
BRAND NAME: SparkLAN
OEM BRAND NAME: TRENDnet
MODEL NO: WL-760A
OEM MODEL NO.: TEW-503PI
APPLICANT: SPARKLAN COMMUNICATIONS, INC.
STANDARDS: FCC Part 15, Subpart C (Section 15.247),
ANSI C63.4-2003

The above equipment (model no.: WL-760A) is identical to model no. WMP55AG ver. 1.3, which has been tested by **Advance Data Technology Corporation** from Mar. 10 ~ Mar. 23, 2005, and found compliance with the requirement of the above standards. The test record, data evaluation & Equipment Under Test (EUT) configurations represented herein are true and accurate accounts of the measurements of the sample's EMC characteristics under the conditions specified in this report.

PREPARED BY : Andrea Hsia , **DATE:** May 28, 2005
(Andrea Hsia)

TECHNICAL
ACCEPTANCE : Gary Chang , **DATE:** May 28, 2005
Responsible for RF (Gary Chang)

APPROVED BY : Cody Chang , **DATE:** May 28, 2005
(Cody Chang, Deputy Manager)

2. SUMMARY OF TEST RESULTS

The EUT has been tested according to the following specifications:

APPLIED STANDARD: FCC Part 15, Subpart C (Section 15.247)			
Standard Section	Test Type and Limit	Result	Remark
15.207	AC Power Conducted Emission	PASS	Meet the requirement of limit. Minimum passing margin is -15.89dB at 0.636MHz
15.247(a)(2)	Spectrum Bandwidth of a Direct Sequence Spread Spectrum System Limit: min. 500kHz	PASS	Meet the requirement of limit.
15.247(b)	Maximum Peak Output Power Limit: max. 30dBm	PASS	Meet the requirement of limit.
15.247(d)	Radiated Emissions Limit: Table 15.209	PASS	Meet the requirement of limit. Minimum passing margin is -0.43dB at 2390.00MHz
15.247(e)	Power Spectral Density Limit: max. 8dBm	PASS	Meet the requirement of limit.
15.247(d)	Band Edge Measurement Limit: 20dB less than the peak value of fundamental frequency	PASS	Meet the requirement of limit.

2.1 MEASUREMENT UNCERTAINTY

Where relevant, the following measurement uncertainty levels have been estimated for tests performed on the EUT as specified in CISPR 16-4:

Measurement	Frequency	Uncertainty
Conducted emissions	9kHz~30MHz	2.44 dB
	30MHz ~ 200MHz	3.73 dB
Radiated emissions	200MHz ~ 1000MHz	3.74 dB
	1GHz ~ 18GHz	2.20 dB
	18GHz ~ 40GHz	1.88 dB



3. GENERAL INFORMATION

3.1 GENERAL DESCRIPTION OF EUT

PRODUCT	WLAN 802.11a/b/g PCI Adapter
OEM PRODUCT	108Mbps Wireless PCI Adapter
MODEL NO.	WL-760A
OEM MODEL NO.	TEW-503PI
POWER SUPPLY	3.3Vdc from host equipment
MODULATION TYPE	CCK, DQPSK, DBPSK for DSSS 64QAM, 16QAM, QPSK, BPSK for OFDM
MODULATION TECHNOLOGY	DSSS, OFDM
TRANSFER RATE	802.11b: 11/5.5/2/1Mbps 802.11g: 54/48/36/24/18/12/9/6Mbps (Turbo mode: up to 108Mbps *see Note 2) 802.11a: 54/48/36/24/18/12/9/6Mbps (Turbo mode: up to 108Mbps *see Note 2)
FREQUENCY RANGE	802.11b & 802.11g: 2412 ~ 2462MHz 802.11a: 5.15 ~ 5.35GHz and 5.725 ~ 5.850GHz
NUMBER OF CHANNEL	802.11b & 802.11g: 11 for Normal mode / 1 for Turbo mode 802.11a: 13 for Normal mode / 5 for Turbo mode
CHANNEL SPACING	802.11b & 802.11g: 5MHz 802.11a: 20MHz for Normal mode / 40MHz for Turbo mode
OUTPUT POWER	802.11b: 63.826mW 802.11g: 51.050mW 802.11a: 50.933mW
DATA CABLE	NA
ANTENNA TYPE	Dipole antenna with 2.0dBi gain (for 2.4GHz) Dipole antenna with 2.0dBi gain (for 5.0GHz)
I/O PORTS	NA
ASSOCIATED DEVICES	NA

NOTE:

1. This is a duplicate report of RF940321L05, the difference is changing the Model name, Brand name, Product Name and Applicant.
2. The EUT operates in both the 5GHz and 2.4GHz Bands and compatibility with 802.11a and 802.11b, 802.11g technology.
3. This EUT is capable of providing data rates of up to 108Mbps in Turbo Mode depending upon reception quality.
4. The above EUT information was declared by the manufacturer and for more detailed features description, please refer to the manufacturer's specifications or User's Manual.

3.2 DESCRIPTION OF TEST MODES

Operated in 2400 ~ 2483.5MHz band:

For 802.11b/g: Eleven channels are provided to this EUT for normal mode.

Channel	Frequency	Channel	Frequency
1	2412 MHz	7	2442 MHz
2	2417 MHz	8	2447 MHz
3	2422 MHz	9	2452 MHz
4	2427 MHz	10	2457 MHz
5	2432 MHz	11	2462 MHz
6	2437 MHz		

For 802.11g: One channel is provided to this EUT for turbo mode.

Channel	Frequency
6	2437 MHz

Operated in 5725 ~ 5850MHz band:

For 802.11a: Five channels are provided to this EUT for normal mode.

Channel	Frequency
1	5745 MHz
2	5765 MHz
3	5785 MHz
4	5805 MHz
5	5825 MHz

For 802.11a: Two channels are provided to this EUT for turbo mode.

Channel	Frequency
1	5760 MHz
2	5800 MHz

3.2.1 CONFIGURATION OF SYSTEM UNDER TEST

(Power from host equipment)

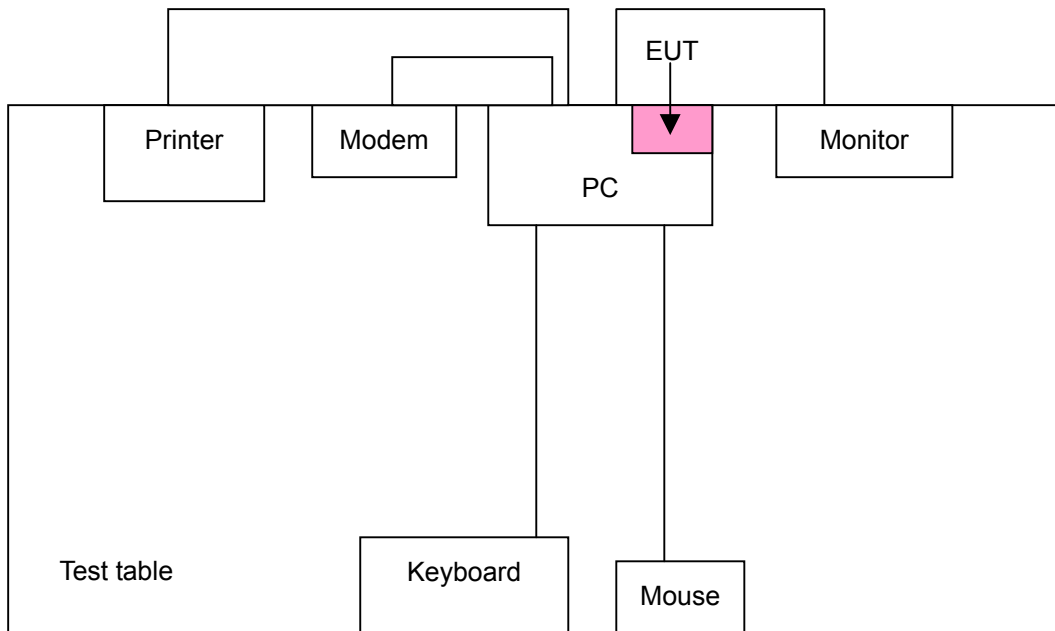



3.2.2 TEST MODE APPLICABILITY AND TESTED CHANNEL DETAIL:

EUT configure mode	Applicable to				Description
	PLC	RE<1G	RE≥1G	APCM	
-	X	X	X	X	NA

Where PLC: Power Line Conducted Emission RE<1G RE: Radiated Emission below 1GHz
 RE≥1G: Radiated Emission above 1GHz APCM: Antenna Port Conducted Measurement

Power Line Conducted Emission Test:

- Pre-Scan has been conducted to determine the worst-case mode from all possible combinations between available modulations, data rates and antenna ports (if EUT with antenna diversity architecture).
- Following channel(s) was (were) selected for the final test as listed below.

Mode	Available Channel	Tested Channel	Modulation Technology	Modulation Type	Data Rate (Mbps)
802.11g	1 to 11	1, 6, 11	OFDM	BPSK	6
802.11a	1 to 5	3	OFDM	BPSK	6

Radiated Emission Test (Below 1 GHz):

- Pre-Scan has been conducted to determine the worst-case mode from all possible combinations between available modulations, data rates and antenna ports (if EUT with antenna diversity architecture).
- Following channel(s) was (were) selected for the final test as listed below.

Mode	Available Channel	Tested Channel	Modulation Technology	Modulation Type	Data Rate (Mbps)
802.11g	1 to 11	11	OFDM	BPSK	6
802.11a	1 to 5	3	OFDM	BPSK	6

Radiated Emission Test (Above 1 GHz):

- Pre-Scan has been conducted to determine the worst-case mode from all possible combinations between available modulations, data rates and antenna ports (if EUT with antenna diversity architecture).
- Following channel(s) was (were) selected for the final test as listed below.

Mode	Available Channel	Tested Channel	Modulation Technology	Modulation Type	Data Rate (Mbps)
802.11b	1 to 11	1, 6, 11	DSSS	CCK	11
802.11g	1 to 11	1, 6, 11	OFDM	BPSK	6
802.11g Turbo	6	6	OFDM	BPSK	12
802.11a	1 to 5	1, 3, 5	OFDM	BPSK	6
802.11a Turbo	1 to 2	1, 2	OFDM	BPSK	12



Bandedge Measurement:

- Pre-Scan has been conducted to determine the worst-case mode from all possible combinations between available modulations, data rates and antenna ports (if EUT with antenna diversity architecture).
- Following channel(s) was (were) selected for the final test as listed below.

Mode	Available Channel	Tested Channel	Modulation Technology	Modulation Type	Data Rate (Mbps)
802.11b	1 to 11	1, 11	DSSS	CCK	11
802.11g	1 to 11	1, 11	OFDM	BPSK	6
802.11g Turbo	6	6	OFDM	BPSK	12
802.11a	1 to 5	1, 5	OFDM	BPSK	6
802.11a Turbo	1 to 2	1, 2	OFDM	BPSK	12

Antenna Port Conducted Measurement:

- Pre-Scan has been conducted to determine the worst-case mode from all possible combinations between available modulations, data rates and antenna ports (if EUT with antenna diversity architecture).
- Following channel(s) was (were) selected for the final test as listed below.

Mode	Available Channel	Tested Channel	Modulation Technology	Modulation Type	Data Rate (Mbps)
802.11b	1 to 11	1, 6, 11	DSSS	CCK	11
802.11g	1 to 11	1, 6, 11	OFDM	BPSK	6
802.11g Turbo	6	6	OFDM	BPSK	12
802.11a	1 to 5	1, 3, 5	OFDM	BPSK	6
802.11a Turbo	1 to 2	1, 2	OFDM	BPSK	12



3.3 GENERAL DESCRIPTION OF APPLIED STANDARDS

The EUT is a WLAN 802.11a/b/g PCI Adapter. According to the specifications of the manufacturer, it must comply with the requirements of the following standards:

FCC Part 15, Subpart C. (15.247) ANSI C63.4-2003

All test items have been performed and recorded as per the above standards.

NOTE: The EUT is also considered as a kind of computer peripheral, because the connection to computer is necessary for typical use. It has been verified to comply with the requirements of FCC Part 15, Subpart B, Class B (DoC). The test report has been issued separately.

3.4 DESCRIPTION OF SUPPORT UNITS

The EUT has been tested as an independent unit together with other necessary accessories or support units. The following support units or accessories were used to form a representative test configuration during the tests.

NO.	PRODUCT	BRAND	MODEL NO.	SERIAL NO.	FCC ID
1	PC	MSI	Hetis 865G Giga	3AS0119581	FCC DoC Approved
2	LCD MONITOR	ACER	AL1721	ET.L0408.01040 4001E6PK00	FCC DoC Approved
3	PRINTER	EPSON	LQ-300+	DCGY047265	FCC DoC Approved
4	MOUSE	HP	M-S69	M4-010565	INZ211443
5	KEYBOARD	HP	SK-1688	C0306114659	GYUR84SK
6	MODEM	ACEEX	1414V/3	0401008248	IFAXDM1414

NO.	SIGNAL CABLE DESCRIPTION OF THE ABOVE SUPPORT UNITS
1	NA
2	1.8 m shielded cable with one core
3	1.8 m shielded cable without core
4	1.2 m shielded cable without core
5	1.3 m shielded cable without core
6	1.2 m shielded cable without core

NOTE: All power cords of the above support units are non shielded (1.8m).



4. TEST TYPES AND RESULTS (802.11b & g 2412~2462MHz Band)

4.1 CONDUCTED EMISSION MEASUREMENT

4.1.1 LIMITS OF CONDUCTED EMISSION MEASUREMENT

FREQUENCY OF EMISSION (MHz)	CONDUCTED LIMIT (dB μ V)	
	Quasi-peak	Average
0.15-0.5	66 to 56	56 to 46
0.5-5	56	46
5-30	60	50

- NOTE:**
1. The lower limit shall apply at the transition frequencies.
 2. The limit decreases in line with the logarithm of the frequency in the range of 0.15 to 0.50 MHz.
 3. All emanations from a class A/B digital device or system, including any network of conductors and apparatus connected thereto, shall not exceed the level of field strengths specified above.

4.1.2 TEST INSTRUMENTS

DESCRIPTION & MANUFACTURER	MODEL NO.	SERIAL NO.	CALIBRATED UNTIL
Test Receiver ROHDE & SCHWARZ	ESCS30	100291	Nov. 16, 2005
RF signal cable Woken	5D-FB	Cable-HYC01-01	Jan. 09, 2006
LISN ROHDE & SCHWARZ	ESH3-Z5	100312	Feb. 15, 2006
LISN ROHDE & SCHWARZ	ESH2-Z5	100104	Feb. 15, 2006
Software ADT	ADT_Cond_V3	NA	NA

- NOTE:**
1. The calibration interval of the above test instruments is 12 months and the calibrations are traceable to NML/ROC and NIST/USA.
 2. The test was performed in HwaYa Shielded Room 1.
 3. The VCCI Site Registration No. is C-2040.



4.1.3 TEST PROCEDURES

- a. The EUT was placed 0.4 meters from the conducting wall of the shielded room with EUT being connected to the power mains through a line impedance stabilization network (LISN). Other support units were connected to the power mains through another LISN. The two LISNs provide 50 ohm/ 50uH of coupling impedance for the measuring instrument.
- b. Both lines of the power mains connected to the EUT were checked for maximum conducted interference.
- c. The frequency range from 150kHz to 30MHz was searched. Emission levels under (Limit - 20dB) was not recorded.

4.1.4 DEVIATION FROM TEST STANDARD

No deviation

4.1.5 TEST SETUP

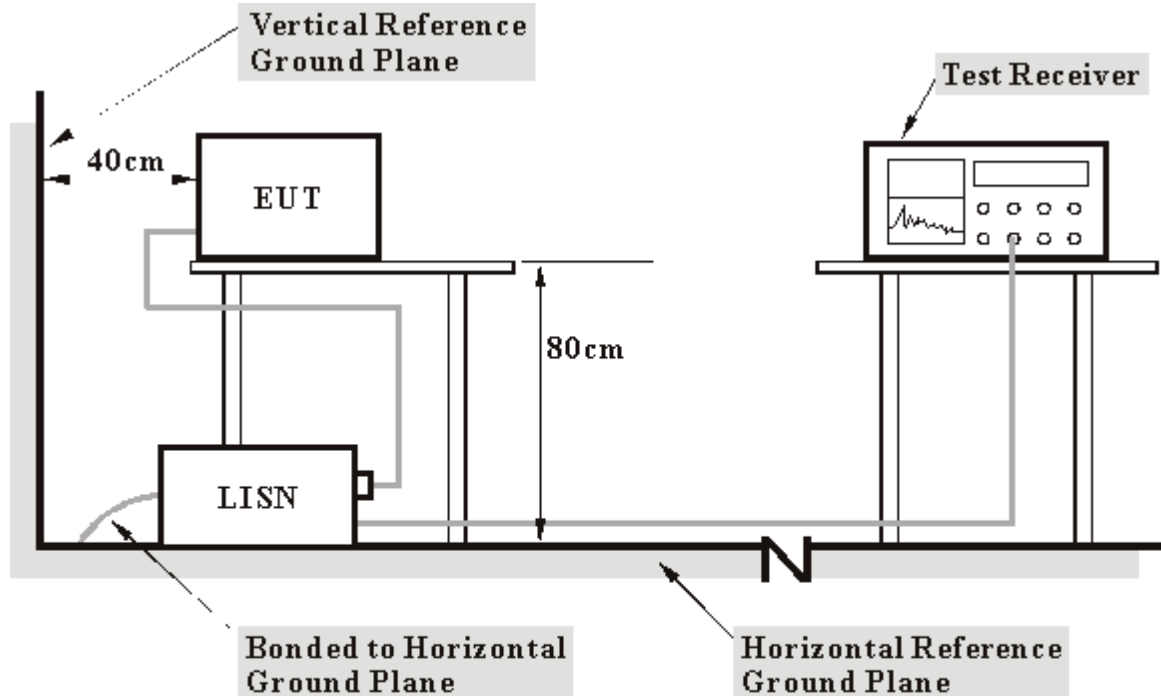

- Note:**
1. Support units were connected to second LISN.
 2. Both of LISNs (AMN) 80 cm from EUT and at the least 80 cm from other units and other metal planes support units.

For the actual test configuration, please refer to the related item – Photographs of the Test Configuration.

4.1.6 EUT OPERATING CONDITIONS

- a. Connected the EUT into Desktop PC placed on a testing table.
- b. The notebook system ran a test program (provided by manufacturer) to enable EUT under transmission/receiving condition continuously at specific channel frequency.
- c. The notebook system sent "H" messages to its screen.
- d. The notebook system sent "H" messages to modem.
- e. The notebook system sent "H" messages to printer, and the printer printed them on paper.
- f. Steps c ~ e were repeated.



4.1.7 TEST RESULTS

Conducted Worst-Case Data

EUT	WLAN 802.11a/b/g PCI Adapter	MODEL	WL-760A
CHANNEL	Channel 1	6dB BANDWIDTH	9 kHz
MODULATION TYPE	BPSK	TRANSFER RATE	6Mbps
INPUT POWER (SYSTEM)	120Vac, 60 Hz	PHASE	Line (L)
ENVIRONMENTAL CONDITIONS	20deg. C, 70%RH, 991hPa	TESTED BY	Scott Yang

No	Freq. [MHz]	Corr. Factor (dB)	Reading Value		Emission Level		Limit		Margin	
			[dB (uV)]		[dB (uV)]		[dB (uV)]		(dB)	
			Q.P.	AV.	Q.P.	AV.	Q.P.	AV.	Q.P.	AV.
1	0.190	0.11	46.24	-	46.35	-	64.02	54.02	-17.67	-
2	0.444	0.12	37.32	-	37.44	-	56.98	46.98	-19.54	-
3	0.951	0.17	35.76	-	35.93	-	56.00	46.00	-20.07	-
4	1.775	0.20	37.00	-	37.20	-	56.00	46.00	-18.80	-
5	3.169	0.25	35.05	-	35.30	-	56.00	46.00	-20.70	-
6	21.928	1.00	32.98	-	33.98	-	60.00	50.00	-26.02	-

*(The test data is in accordance with ADT Report No.: RF940321L05.)

- REMARKS:**
1. Q.P. and AV. are abbreviations of quasi-peak and average individually.
 2. "-": The Quasi-peak reading value also meets average limit and measurement with the average detector is unnecessary.
 3. The emission levels of other frequencies were very low against the limit.
 4. Margin value = Emission level - Limit value
 5. Correction factor = Insertion loss + Cable loss
 6. Emission Level = Correction Factor + Reading Value.

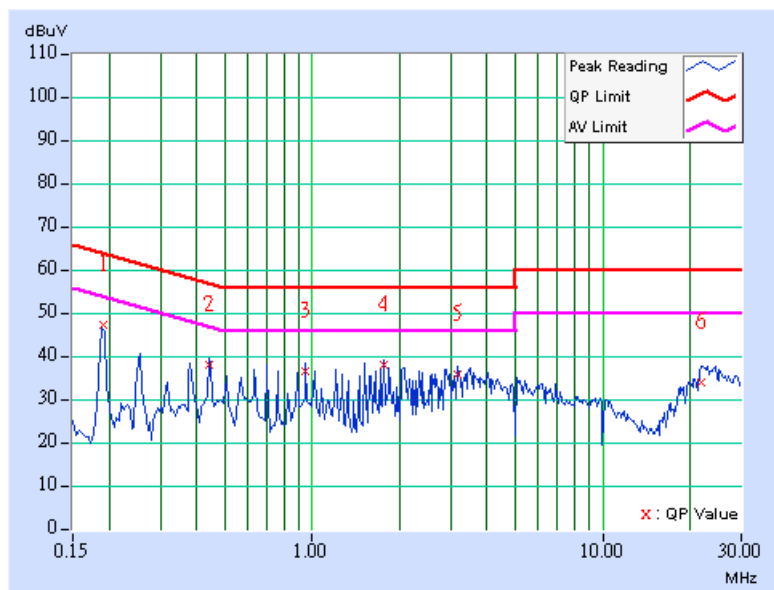



EUT	WLAN 802.11a/b/g PCI Adapter	MODEL	WL-760A
CHANNEL	Channel 1	6dB BANDWIDTH	9 kHz
MODULATION TYPE	BPSK	TRANSFER RATE	6Mbps
INPUT POWER (SYSTEM)	120Vac, 60 Hz	PHASE	Neutral (N)
ENVIRONMENTAL CONDITIONS	20deg. C, 70%RH, 991hPa	TESTED BY	Scott Yang

No	Freq. [MHz]	Corr. Factor (dB)	Reading Value [dB (uV)]		Emission Level [dB (uV)]		Limit [dB (uV)]		Margin (dB)	
			Q.P.	AV.	Q.P.	AV.	Q.P.	AV.	Q.P.	AV.
			1	0.190	0.10	44.96	-	45.06	-	64.02
2	0.381	0.11	40.77	-	40.88	-	58.25	48.25	-17.37	-
3	0.635	0.13	39.88	-	40.01	-	56.00	46.00	-15.99	-
4	0.890	0.16	39.32	-	39.48	-	56.00	46.00	-16.52	-
5	1.206	0.19	39.26	-	39.45	-	56.00	46.00	-16.55	-
6	3.427	0.26	35.69	-	35.95	-	56.00	46.00	-20.05	-

*(The test data is in accordance with ADT Report No.: RF940321L05.)

- REMARKS:**
1. Q.P. and AV. are abbreviations of quasi-peak and average individually.
 2. "-": The Quasi-peak reading value also meets average limit and measurement with the average detector is unnecessary.
 3. The emission levels of other frequencies were very low against the limit.
 4. Margin value = Emission level - Limit value
 5. Correction factor = Insertion loss + Cable loss
 6. Emission Level = Correction Factor + Reading Value.

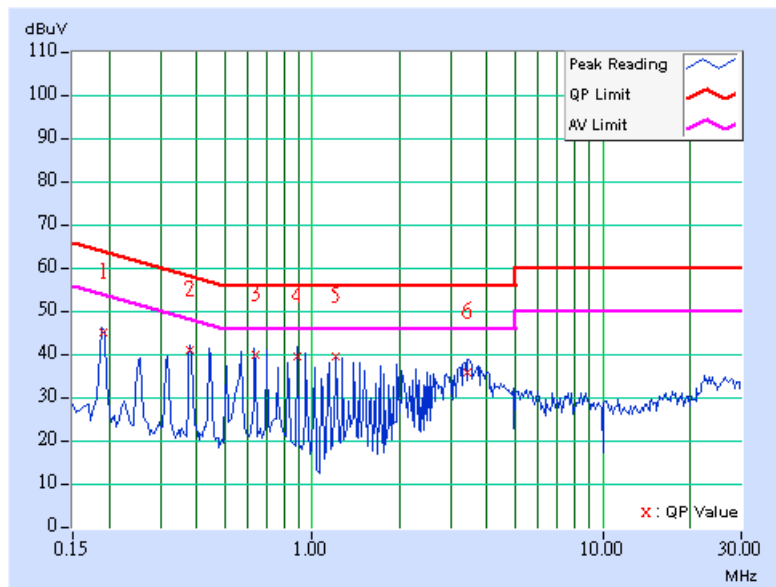



EUT	WLAN 802.11a/b/g PCI Adapter	MODEL	WL-760A
CHANNEL	Channel 6	6dB BANDWIDTH	9 kHz
MODULATION TYPE	BPSK	TRANSFER RATE	6Mbps
INPUT POWER (SYSTEM)	120Vac, 60 Hz	PHASE	Line (L)
ENVIRONMENTAL CONDITIONS	20deg. C, 70%RH, 991hPa	TESTED BY	Scott Yang

No	Freq. [MHz]	Corr. Factor (dB)	Reading Value [dB (uV)]		Emission Level [dB (uV)]		Limit [dB (uV)]		Margin (dB)	
			Q.P.	AV.	Q.P.	AV.	Q.P.	AV.	Q.P.	AV.
			1	0.191	0.11	46.18	-	46.29	-	63.99
2	0.446	0.12	37.36	-	37.48	-	56.96	46.96	-19.48	-
3	0.955	0.17	35.64	-	35.81	-	56.00	46.00	-20.19	-
4	1.780	0.20	36.92	-	37.12	-	56.00	46.00	-18.88	-
5	3.431	0.26	34.27	-	34.53	-	56.00	46.00	-21.47	-
6	21.980	1.00	33.01	-	34.01	-	60.00	50.00	-25.99	-

*(The test data is in accordance with ADT Report No.: RF940321L05.)

- REMARKS:**
1. Q.P. and AV. are abbreviations of quasi-peak and average individually.
 2. "-": The Quasi-peak reading value also meets average limit and measurement with the average detector is unnecessary.
 3. The emission levels of other frequencies were very low against the limit.
 4. Margin value = Emission level - Limit value
 5. Correction factor = Insertion loss + Cable loss
 6. Emission Level = Correction Factor + Reading Value.

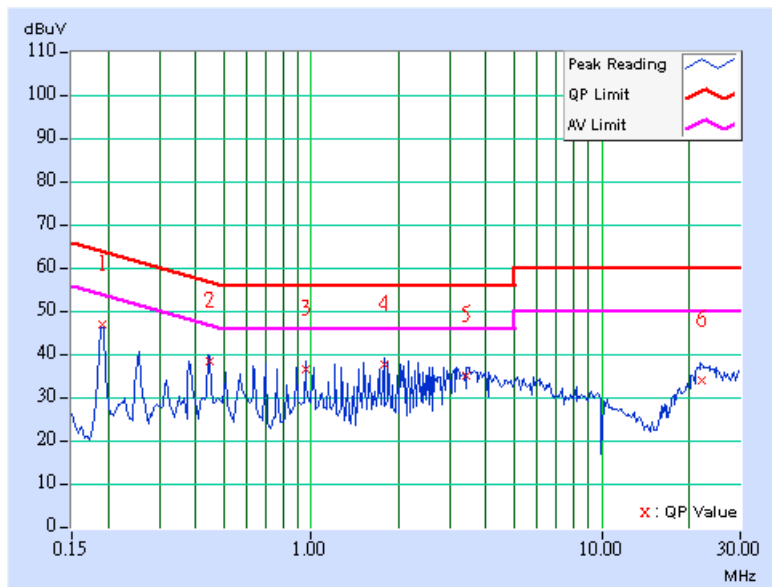



EUT	WLAN 802.11a/b/g PCI Adapter	MODEL	WL-760A
CHANNEL	Channel 6	6dB BANDWIDTH	9 kHz
MODULATION TYPE	BPSK	TRANSFER RATE	6Mbps
INPUT POWER (SYSTEM)	120Vac, 60 Hz	PHASE	Neutral (N)
ENVIRONMENTAL CONDITIONS	20deg. C, 70%RH, 991hPa	TESTED BY	Scott Yang

No	Freq. [MHz]	Corr. Factor (dB)	Reading Value [dB (uV)]		Emission Level [dB (uV)]		Limit [dB (uV)]		Margin (dB)	
			Q.P.	AV.	Q.P.	AV.	Q.P.	AV.	Q.P.	AV.
			1	0.192	0.10	44.81	-	44.91	-	63.97
2	0.380	0.11	40.85	-	40.96	-	58.27	48.27	-17.31	-
3	0.636	0.13	39.98	-	40.11	-	56.00	46.00	-15.89	-
4	0.890	0.16	38.99	-	39.15	-	56.00	46.00	-16.85	-
5	1.207	0.19	38.70	-	38.89	-	56.00	46.00	-17.11	-
6	3.491	0.26	36.38	-	36.64	-	56.00	46.00	-19.36	-

*(The test data is in accordance with ADT Report No.: RF940321L05.)

- REMARKS:**
1. Q.P. and AV. are abbreviations of quasi-peak and average individually.
 2. "-": The Quasi-peak reading value also meets average limit and measurement with the average detector is unnecessary.
 3. The emission levels of other frequencies were very low against the limit.
 4. Margin value = Emission level - Limit value
 5. Correction factor = Insertion loss + Cable loss
 6. Emission Level = Correction Factor + Reading Value.

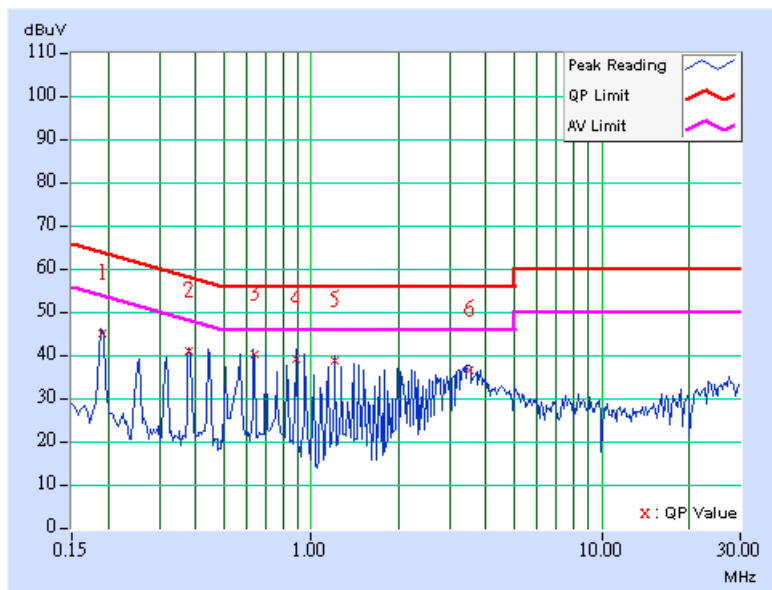



EUT	WLAN 802.11a/b/g PCI Adapter	MODEL	WL-760A
CHANNEL	Channel 11	6dB BANDWIDTH	9 kHz
MODULATION TYPE	BPSK	TRANSFER RATE	6Mbps
INPUT POWER (SYSTEM)	120Vac, 60 Hz	PHASE	Line (L)
ENVIRONMENTAL CONDITIONS	20deg. C, 70%RH, 991hPa	TESTED BY	Scott Yang

No	Freq. [MHz]	Corr. Factor (dB)	Reading Value [dB (uV)]		Emission Level [dB (uV)]		Limit [dB (uV)]		Margin (dB)	
			Q.P.	AV.	Q.P.	AV.	Q.P.	AV.	Q.P.	AV.
			1	0.192	0.11	45.96	-	46.07	-	63.97
2	0.446	0.12	37.47	-	37.59	-	56.96	46.96	-19.37	-
3	0.955	0.17	35.88	-	36.05	-	56.00	46.00	-19.95	-
4	1.526	0.20	36.55	-	36.75	-	56.00	46.00	-19.25	-
5	2.861	0.24	35.31	-	35.55	-	56.00	46.00	-20.45	-
6	23.071	1.04	32.57	-	33.61	-	60.00	50.00	-26.39	-

*(The test data is in accordance with ADT Report No.: RF940321L05.)

- REMARKS:**
1. Q.P. and AV. are abbreviations of quasi-peak and average individually.
 2. "-": The Quasi-peak reading value also meets average limit and measurement with the average detector is unnecessary.
 3. The emission levels of other frequencies were very low against the limit.
 4. Margin value = Emission level - Limit value
 5. Correction factor = Insertion loss + Cable loss
 6. Emission Level = Correction Factor + Reading Value.

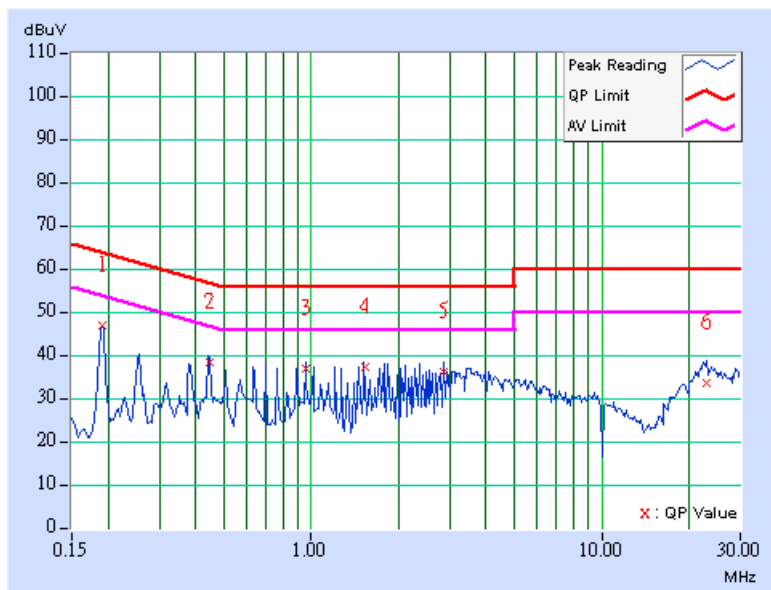



EUT	WLAN 802.11a/b/g PCI Adapter	MODEL	WL-760A
CHANNEL	Channel 11	6dB BANDWIDTH	9 kHz
MODULATION TYPE	BPSK	TRANSFER RATE	6Mbps
INPUT POWER (SYSTEM)	120Vac, 60 Hz	PHASE	Neutral (N)
ENVIRONMENTAL CONDITIONS	20deg. C, 70%RH, 991hPa	TESTED BY	Scott Yang

No	Freq. [MHz]	Corr. Factor (dB)	Reading Value [dB (uV)]		Emission Level [dB (uV)]		Limit [dB (uV)]		Margin (dB)	
			Q.P.	AV.	Q.P.	AV.	Q.P.	AV.	Q.P.	AV.
			1	0.190	0.10	44.90	-	45.00	-	64.02
2	0.382	0.11	40.81	-	40.92	-	58.24	48.24	-17.32	-
3	0.637	0.13	39.86	-	39.99	-	56.00	46.00	-16.01	-
4	0.891	0.16	38.88	-	39.04	-	56.00	46.00	-16.96	-
5	1.463	0.19	37.05	-	37.24	-	56.00	46.00	-18.76	-
6	3.435	0.26	35.79	-	36.05	-	56.00	46.00	-19.95	-

*(The test data is in accordance with ADT Report No.: RF940321L05.)

- REMARKS:**
1. Q.P. and AV. are abbreviations of quasi-peak and average individually.
 2. "-": The Quasi-peak reading value also meets average limit and measurement with the average detector is unnecessary.
 3. The emission levels of other frequencies were very low against the limit.
 4. Margin value = Emission level - Limit value
 5. Correction factor = Insertion loss + Cable loss
 6. Emission Level = Correction Factor + Reading Value.

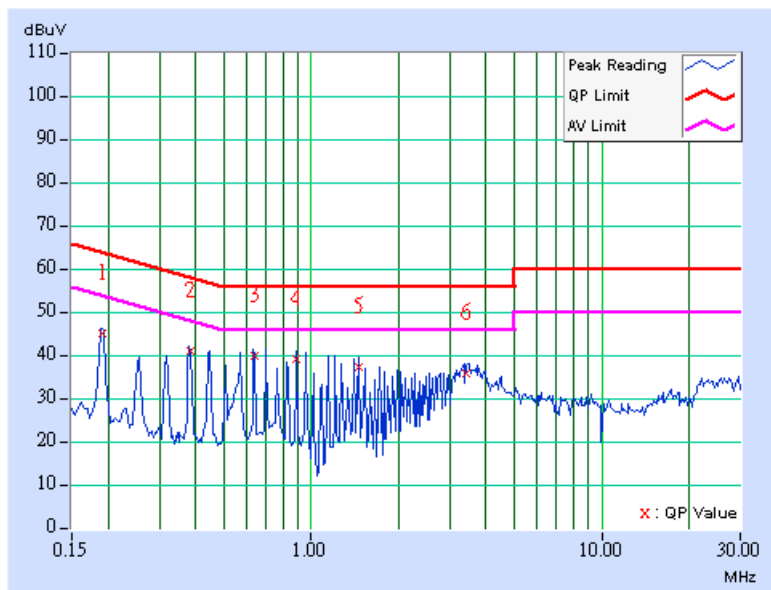



4.2 RADIATED EMISSION MEASUREMENT

4.2.1 LIMITS OF RADIATED EMISSION MEASUREMENT

Emissions radiated outside of the specified bands, shall be according to the general radiated limits in 15.209 as following:

Frequencies (MHz)	Field strength (microvolts/meter)	Measurement distance (meters)
0.009-0.490	2400/F(kHz)	300
0.490-1.705	24000/F(kHz)	30
1.705-30.0	30	30
30-88	100	3
88-216	150	3
216-960	200	3
Above 960	500	3

NOTE:

1. The lower limit shall apply at the transition frequencies.
2. Emission level (dBuV/m) = 20 log Emission level (uV/m).
3. As shown in 15.35(b), for frequencies above 1000MHz, the field strength limits are based on average detector, however, the peak field strength of any emission shall not exceed the maximum permitted average limits, specified above by more than 20dB under any condition of modulation.



4.2.2 TEST INSTRUMENTS

DESCRIPTION & MANUFACTURER	MODEL NO.	SERIAL NO.	CALIBRATED UNTIL
Test Receiver ROHDE & SCHWARZ	ESIB7	100188	Dec. 19, 2005
Spectrum Analyzer ROHDE & SCHWARZ	FSP40	100039	Nov. 21, 2005
BILOG Antenna SCHWARZBECK	VULB9168	9168-157	Jan. 22, 2006
HORN Antenna SCHWARZBECK	BBHA 9120 D	9120D-407	Jan. 16, 2006
HORN Antenna SCHWARZBECK	BBHA 9170	BBHA 9170241	Feb. 23, 2006
Preamplifier Agilent	8449B	3008A01961	Nov. 09, 2005
Preamplifier Agilent	8447D	2944A10629	Nov. 09, 2005
RF signal cable HUBER+SUHNER	SUCOFLEX 104	218182/4	Feb. 17, 2006
RF signal cable HUBER+SUHNER	SUCOFLEX 104	218194/4	Feb. 17, 2006
Software ADT.	ADT_Radiated_V5.14	NA	NA
Antenna Tower ADT.	AT100	AT93021702	NA
Turn Table ADT.	TT100.	TT93021702	NA
Controller ADT.	SC100.	SC93021702	NA

- NOTE:**
1. The calibration interval of the above test instruments is 12 months and the calibrations are traceable to NML/ROC and NIST/USA.
 2. The test was performed in HwaYa Chamber 1.
 3. The horn antenna and HP preamplifier (model: 8449B) are used only for the measurement of emission frequency above 1GHz if tested.
 4. The IC Site Registration No. is IC4924-2.



4.2.3 TEST PROCEDURES

- a. The EUT was placed on the top of a rotating table 0.8 meters above the ground at a 3 meter semi- anechoic. The table was rotated 360 degrees to determine the position of the highest radiation.
- b. The EUT was set 3 meters away from the interference-receiving antenna, which was mounted on the top of a variable-height antenna tower.
- c. The antenna is a broadband antenna, and its height is varied from one meter to four meters above the ground to determine the maximum value of the field strength. Both horizontal and vertical polarizations of the antenna are set to make the measurement.
- d. For each suspected emission, the EUT was arranged to its worst case and then the antenna was tuned to heights from 1 meter to 4 meters and the rotatable table was turned from 0 degrees to 360 degrees to find the maximum reading.
- e. The test-receiver system was set to Peak Detect Function and Specified Bandwidth with Maximum Hold Mode.
- f. If the emission level of the EUT in peak mode was lower than the limit specified, then testing could be stopped and the peak values of the EUT would be reported. Otherwise the emissions would be re-tested one by one using peak, quasi-peak or average method as specified and then reported in a data sheet.

NOTE:

1. The resolution bandwidth and video bandwidth of test receiver/spectrum analyzer is 120kHz for Quasi-peak detection at frequency below 1GHz.
2. The resolution bandwidth and video bandwidth of test receiver/spectrum analyzer is 1 MHz for Peak detection (PK) at frequency above 1GHz.
3. The resolution bandwidth of test receiver/spectrum analyzer is 1 MHz and the video bandwidth is 10 Hz for Average detection (AV) at frequency above 1GHz.

4.2.4 DEVIATION FROM TEST STANDARD

No deviation

4.2.5 TEST SETUP

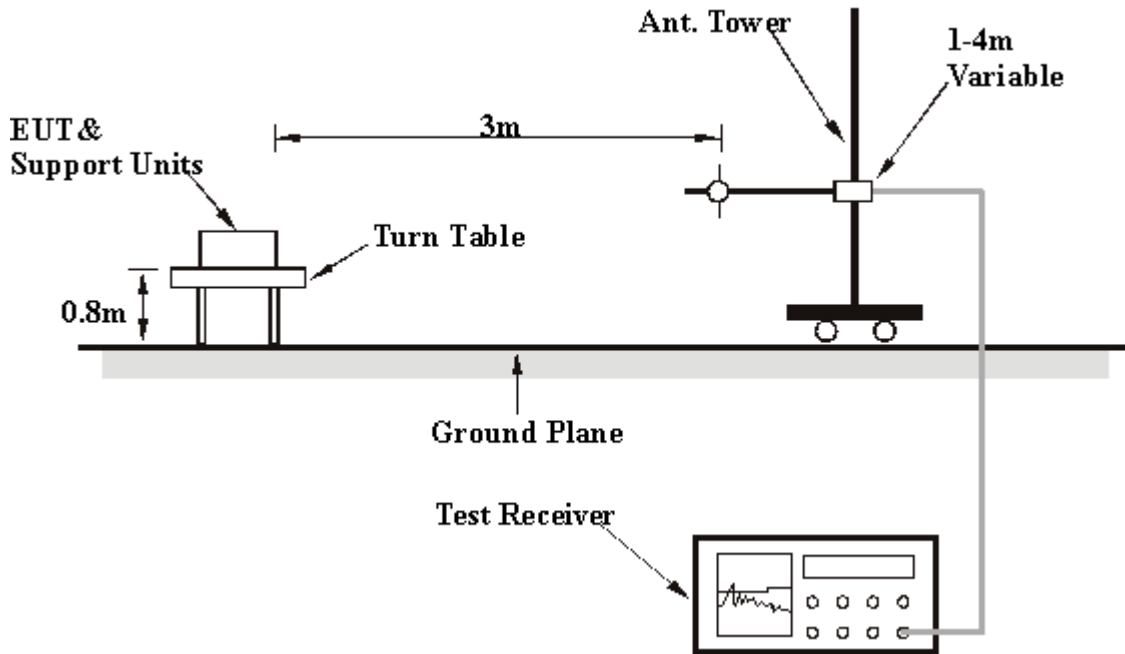

For the actual test configuration, please refer to the related item – Photographs of the Test Configuration.

4.2.6 EUT OPERATING CONDITIONS

Same as 4.1.6

4.2.7 TEST RESULTS

Below 1GHz Worst-Case Data

EUT	WLAN 802.11a/b/g PCI Adapter	MODEL	WL-760A
CHANNEL	Channel 11	FREQUENCY RANGE	Below 1000MHz
MODULATION TYPE	BPSK	TRANSFER RATE	6Mbps
INPUT POWER (SYSTEM)	120Vac, 60 Hz	DETECTOR FUNCTION	Quasi-Peak
ENVIRONMENTAL CONDITIONS	25deg. C, 61%RH, 991hPa	TESTED BY	Brad Wu

ANTENNA POLARITY & TEST DISTANCE: HORIZONTAL AT 3 M

No.	Freq. (MHz)	Emission Level (dBuV/m)	Limit (dBuV/m)	Margin (dB)	Antenna Height (m)	Table Angle (Degree)	Raw Value (dBuV)	Correction Factor (dB/m)
1	236.05	35.95 QP	46.00	-10.05	1.25 H	49	23.23	12.72
2	401.28	36.53 QP	46.00	-9.47	1.00 H	319	19.76	16.76
3	480.98	44.81 QP	46.00	-1.19	1.00 H	16	26.45	18.35
4	537.35	37.30 QP	46.00	-8.70	1.25 H	166	18.07	19.23
5	671.11	30.30 QP	46.00	-15.70	1.24 H	144	8.60	21.70
6	743.41	39.54 QP	46.00	-6.46	1.00 H	130	16.46	23.08

ANTENNA POLARITY & TEST DISTANCE: VERTICAL AT 3 M

No.	Freq. (MHz)	Emission Level (dBuV/m)	Limit (dBuV/m)	Margin (dB)	Antenna Height (m)	Table Angle (Degree)	Raw Value (dBuV)	Correction Factor (dB/m)
1	31.94	30.28 QP	40.00	-9.72	1.00 V	271	16.27	14.01
2	239.94	37.37 QP	46.00	-8.63	1.75 V	28	24.40	12.96
3	488.76	42.04 QP	46.00	-3.96	1.00 V	13	23.60	18.44
4	670.74	40.79 QP	46.00	-5.21	1.25 V	3	19.10	21.69
5	743.41	39.71 QP	46.00	-6.29	1.25 V	172	16.63	23.08
6	939.74	36.01 QP	46.00	-9.99	1.00 V	157	10.79	25.22

*(The test data is in accordance with ADT Report No.: RF940321L05.)

- REMARKS:**
1. Emission level(dBuV/m)=Raw Value(dBuV) + Correction Factor(dB/m)
 2. Correction Factor(dB/m) = Antenna Factor (dB/m) + Cable Factor (dB)
 3. The other emission levels were very low against the limit.
 4. Margin value = Emission level – Limit value

802.11b DSSS modulation

EUT	WLAN 802.11a/b/g PCI Adapter	MODEL	WL-760A
CHANNEL	Channel 1	FREQUENCY RANGE	1 ~ 25GHz
MODULATION TYPE	CCK	TRANSFER RATE	11Mbps
INPUT POWER (SYSTEM)	120Vac, 60 Hz	DETECTOR FUNCTION	Peak(PK) Average (AV)
ENVIRONMENTAL CONDITIONS	22deg. C, 62%RH, 991hPa	TESTED BY	Match Tsui

ANTENNA POLARITY & TEST DISTANCE: HORIZONTAL AT 3 M

No.	Freq. (MHz)	Emission Level (dBuV/m)	Limit (dBuV/m)	Margin (dB)	Antenna Height (m)	Table Angle (Degree)	Raw Value (dBuV)	Correction Factor (dB/m)
1	2372.00	53.59 PK	74.00	-20.41	1.40 H	212	22.69	30.90
1	2372.00	45.54 AV	54.00	-8.46	1.40 H	212	14.64	30.90
2	*2412.00	105.31 PK			1.40 H	212	74.25	31.06
2	*2412.00	98.07 AV			1.40 H	212	67.01	31.06
3	4824.00	46.83 PK	74.00	-27.17	1.26 H	25	10.40	36.43
3	4824.00	37.32 AV	54.00	-16.68	1.26 H	25	0.89	36.43

ANTENNA POLARITY & TEST DISTANCE: VERTICAL AT 3 M

No.	Freq. (MHz)	Emission Level (dBuV/m)	Limit (dBuV/m)	Margin (dB)	Antenna Height (m)	Table Angle (Degree)	Raw Value (dBuV)	Correction Factor (dB/m)
1	2372.00	57.79 PK	74.00	-16.21	1.26 V	182	26.89	30.90
1	2372.00	50.44 AV	54.00	-3.56	1.26 V	182	19.54	30.90
2	*2412.00	112.78 PK			1.26 V	182	81.72	31.06
2	*2412.00	105.43 AV			1.26 V	182	74.37	31.06
3	3216.00	45.35 PK	74.00	-28.65	1.09 V	191	12.76	32.59
3	3216.00	38.57 AV	54.00	-15.43	1.09 V	191	5.98	32.59
4	4824.00	50.66 PK	74.00	-23.34	1.14 V	199	14.23	36.43
4	4824.00	44.30 AV	54.00	-9.70	1.14 V	199	7.87	36.43

*(The test data is in accordance with ADT Report No.: RF940321L05.)

- REMARKS:**
1. Emission level(dBuV/m)=Raw Value(dBuV) + Correction Factor(dB/m)
 2. Correction Factor(dB/m) = Antenna Factor (dB/m) + Cable Factor (dB)
 3. The other emission levels were very low against the limit.
 4. Margin value = Emission level – Limit value.
 5. The limit value is defined as per 15.247
 6. " * " : Fundamental frequency



EUT	WLAN 802.11a/b/g PCI Adapter	MODEL	WL-760A
CHANNEL	Channel 6	FREQUENCY RANGE	1 ~ 25GHz
MODULATION TYPE	CCK	TRANSFER RATE	11Mbps
INPUT POWER (SYSTEM)	120Vac, 60 Hz	DETECTOR FUNCTION	Peak(PK) Average (AV)
ENVIRONMENTAL CONDITIONS	22deg. C, 62%RH, 991hPa	TESTED BY	Match Tsui

ANTENNA POLARITY & TEST DISTANCE: HORIZONTAL AT 3 M

No.	Freq. (MHz)	Emission Level (dBuV/m)	Limit (dBuV/m)	Margin (dB)	Antenna Height (m)	Table Angle (Degree)	Raw Value (dBuV)	Correction Factor (dB/m)
1	*2437.00	105.41 PK			1.41 H	200	74.24	31.17
1	*2437.00	98.59 AV			1.41 H	200	67.42	31.17
2	4874.00	47.21 PK	74.00	-26.79	1.24 H	100	10.67	36.54
2	4874.00	38.39 AV	54.00	-15.61	1.24 H	100	1.85	36.54

ANTENNA POLARITY & TEST DISTANCE: VERTICAL AT 3 M

No.	Freq. (MHz)	Emission Level (dBuV/m)	Limit (dBuV/m)	Margin (dB)	Antenna Height (m)	Table Angle (Degree)	Raw Value (dBuV)	Correction Factor (dB/m)
1	*2437.00	113.04 PK			1.47 V	186	81.87	31.17
1	*2437.00	105.67 AV			1.47 V	186	74.50	31.17
2	3249.00	45.20 PK	74.00	-28.80	1.11 V	121	12.57	32.63
2	3249.00	38.47 AV	54.00	-15.53	1.11 V	121	5.84	32.63
3	4874.00	48.13 PK	74.00	-25.87	1.25 V	95	11.59	36.54
3	4874.00	42.32 AV	54.00	-11.68	1.25 V	95	5.78	36.54

*(The test data is in accordance with ADT Report No.: RF940321L05.)

- REMARKS:**
1. Emission level(dBuV/m)=Raw Value(dBuV) + Correction Factor(dB/m)
 2. Correction Factor(dB/m) = Antenna Factor (dB/m) + Cable Factor (dB)
 3. The other emission levels were very low against the limit.
 4. Margin value = Emission level – Limit value.
 5. The limit value is defined as per 15.247
 6. “ * “ : Fundamental frequency



EUT	WLAN 802.11a/b/g PCI Adapter	MODEL	WL-760A
CHANNEL	Channel 11	FREQUENCY RANGE	1 ~ 25GHz
MODULATION TYPE	CCK	TRANSFER RATE	11Mbps
INPUT POWER (SYSTEM)	120Vac, 60 Hz	DETECTOR FUNCTION	Peak(PK) Average (AV)
ENVIRONMENTAL CONDITIONS	22deg. C, 62%RH, 991hPa	TESTED BY	Match Tsui

ANTENNA POLARITY & TEST DISTANCE: HORIZONTAL AT 3 M

No.	Freq. (MHz)	Emission Level (dBuV/m)	Limit (dBuV/m)	Margin (dB)	Antenna Height (m)	Table Angle (Degree)	Raw Value (dBuV)	Correction Factor (dB/m)
1	*2462.00	102.87 PK			1.19 H	241	71.59	31.28
1	*2462.00	95.58 AV			1.19 H	241	64.30	31.28
2	2500.00	54.84 PK	74.00	-19.16	1.19 H	241	23.40	31.44
2	2500.00	45.50 AV	54.00	-8.50	1.19 H	241	14.06	31.44
3	4924.00	48.69 PK	74.00	-25.31	1.10 H	355	12.03	36.66
3	4924.00	36.99 AV	54.00	-17.01	1.10 H	355	0.33	36.66

ANTENNA POLARITY & TEST DISTANCE: VERTICAL AT 3 M

No.	Freq. (MHz)	Emission Level (dBuV/m)	Limit (dBuV/m)	Margin (dB)	Antenna Height (m)	Table Angle (Degree)	Raw Value (dBuV)	Correction Factor (dB/m)
1	*2462.00	112.46 PK			1.54 V	184	81.18	31.28
1	*2462.00	105.83 AV			1.54 V	184	74.55	31.28
2	2500.00	60.98 PK	74.00	-13.02	1.54 V	184	29.54	31.44
2	2500.00	52.30 AV	54.00	-1.70	1.54 V	184	20.86	31.44
3	3282.00	44.06 PK	74.00	-29.94	1.13 V	342	11.39	32.67
3	3282.00	35.45 AV	54.00	-18.55	1.13 V	342	2.78	32.67
4	4924.00	49.30 PK	74.00	-24.70	1.27 V	19	12.64	36.66
4	4924.00	41.20 AV	54.00	-12.80	1.27 V	19	4.54	36.66

*(The test data is in accordance with ADT Report No.: RF940321L05.)

- REMARKS:**
1. Emission level(dBuV/m)=Raw Value(dBuV) + Correction Factor(dB/m)
 2. Correction Factor(dB/m) = Antenna Factor (dB/m) + Cable Factor (dB)
 3. The other emission levels were very low against the limit.
 4. Margin value = Emission level – Limit value.
 5. The limit value is defined as per 15.247
 6. “ * “ : Fundamental frequency

802.11g OFDM modulation

EUT	WLAN 802.11a/b/g PCI Adapter	MODEL	WL-760A
CHANNEL	Channel 1	FREQUENCY RANGE	1 ~ 25GHz
MODULATION TYPE	BPSK	TRANSFER RATE	6Mbps
INPUT POWER (SYSTEM)	120Vac, 60 Hz	DETECTOR FUNCTION	Peak(PK) Average (AV)
ENVIRONMENTAL CONDITIONS	22deg. C, 62%RH, 991hPa	TESTED BY	Match Tsui

ANTENNA POLARITY & TEST DISTANCE: HORIZONTAL AT 3 M

No.	Freq. (MHz)	Emission Level (dBuV/m)	Limit (dBuV/m)	Margin (dB)	Antenna Height (m)	Table Angle (Degree)	Raw Value (dBuV)	Correction Factor (dB/m)
1	2390.00	61.34 PK	74.00	-12.66	1.40 H	214	30.37	30.97
1	2390.00	46.14 AV	54.00	-7.86	1.40 H	214	15.17	30.97
2	*2412.00	102.66 PK			1.40 H	214	71.60	31.06
2	*2412.00	92.56 AV			1.40 H	214	61.50	31.06
3	3216.00	42.53 PK	74.00	-31.47	1.15 H	320	9.94	32.59
3	3216.00	31.87 AV	54.00	-22.13	1.15 H	320	-0.72	32.59

ANTENNA POLARITY & TEST DISTANCE: VERTICAL AT 3 M

No.	Freq. (MHz)	Emission Level (dBuV/m)	Limit (dBuV/m)	Margin (dB)	Antenna Height (m)	Table Angle (Degree)	Raw Value (dBuV)	Correction Factor (dB/m)
1	2390.00	65.99 PK	74.00	-8.01	1.31 V	288	35.02	30.97
1	2390.00	49.46 AV	54.00	-4.54	1.31 V	288	18.49	30.97
2	*2412.00	109.19 PK			1.31 V	288	78.13	31.06
2	*2412.00	97.98 AV			1.31 V	288	66.92	31.06
3	3216.00	48.42 PK	74.00	-25.58	1.15 V	11	15.83	32.59
3	3216.00	44.87 AV	54.00	-9.13	1.15 V	11	12.28	32.59

*(The test data is in accordance with ADT Report No.: RF940321L05.)

- REMARKS:**
1. Emission level(dBuV/m)=Raw Value(dBuV) + Correction Factor(dB/m)
 2. Correction Factor(dB/m) = Antenna Factor (dB/m) + Cable Factor (dB)
 3. The other emission levels were very low against the limit.
 4. Margin value = Emission level – Limit value.
 5. The limit value is defined as per 15.247
 6. “ * “ : Fundamental frequency



EUT	WLAN 802.11a/b/g PCI Adapter	MODEL	WL-760A
CHANNEL	Channel 6	FREQUENCY RANGE	1 ~ 25GHz
MODULATION TYPE	BPSK	TRANSFER RATE	6Mbps
INPUT POWER (SYSTEM)	120Vac, 60 Hz	DETECTOR FUNCTION	Peak(PK) Average (AV)
ENVIRONMENTAL CONDITIONS	22deg. C, 62%RH, 991hPa	TESTED BY	Match Tsui

ANTENNA POLARITY & TEST DISTANCE: HORIZONTAL AT 3 M

No.	Freq. (MHz)	Emission Level (dBuV/m)	Limit (dBuV/m)	Margin (dB)	Antenna Height (m)	Table Angle (Degree)	Raw Value (dBuV)	Correction Factor (dB/m)
1	*2437.00	103.93 PK			1.45 H	135	72.76	31.17
1	*2437.00	94.39 AV			1.45 H	135	63.22	31.17
2	3249.00	42.68 PK	74.00	-31.32	1.10 H	330	10.05	32.63
2	3249.00	32.18 AV	54.00	-21.82	1.10 H	330	-0.45	32.63

ANTENNA POLARITY & TEST DISTANCE: VERTICAL AT 3 M

No.	Freq. (MHz)	Emission Level (dBuV/m)	Limit (dBuV/m)	Margin (dB)	Antenna Height (m)	Table Angle (Degree)	Raw Value (dBuV)	Correction Factor (dB/m)
1	*2437.00	109.59 PK			1.47 V	187	78.42	31.17
1	*2437.00	100.51 AV			1.47 V	187	69.34	31.17
2	3249.00	47.01 PK	74.00	-26.99	1.37 V	360	14.38	32.63
2	3249.00	44.03 AV	54.00	-9.97	1.37 V	360	11.40	32.63

*(The test data is in accordance with ADT Report No.: RF940321L05.)

- REMARKS:**
1. Emission level(dBuV/m)=Raw Value(dBuV) + Correction Factor(dB/m)
 2. Correction Factor(dB/m) = Antenna Factor (dB/m) + Cable Factor (dB)
 3. The other emission levels were very low against the limit.
 4. Margin value = Emission level – Limit value.
 5. The limit value is defined as per 15.247
 6. “ * “ : Fundamental frequency



EUT	WLAN 802.11a/b/g PCI Adapter	MODEL	WL-760A
CHANNEL	Channel 11	FREQUENCY RANGE	1 ~ 25GHz
MODULATION TYPE	BPSK	TRANSFER RATE	6Mbps
INPUT POWER (SYSTEM)	120Vac, 60 Hz	DETECTOR FUNCTION	Peak(PK) Average (AV)
ENVIRONMENTAL CONDITIONS	22deg. C, 62%RH, 991hPa	TESTED BY	Match Tsui

ANTENNA POLARITY & TEST DISTANCE: HORIZONTAL AT 3 M

No.	Freq. (MHz)	Emission Level (dBuV/m)	Limit (dBuV/m)	Margin (dB)	Antenna Height (m)	Table Angle (Degree)	Raw Value (dBuV)	Correction Factor (dB/m)
1	*2462.00	101.20 PK			1.07 H	101	69.92	31.28
1	*2462.00	90.96 AV			1.07 H	101	59.68	31.28
2	2483.50	57.77 PK	74.00	-16.23	1.07 H	101	26.40	31.37
2	2483.50	45.49 AV	54.00	-8.51	1.07 H	101	14.12	31.37
3	3282.00	42.62 PK	74.00	-31.38	1.10 H	333	9.95	32.67
3	3282.00	32.15 AV	54.00	-21.85	1.10 H	333	-0.52	32.67

ANTENNA POLARITY & TEST DISTANCE: VERTICAL AT 3 M

No.	Freq. (MHz)	Emission Level (dBuV/m)	Limit (dBuV/m)	Margin (dB)	Antenna Height (m)	Table Angle (Degree)	Raw Value (dBuV)	Correction Factor (dB/m)
1	*2462.00	109.70 PK			1.40 V	264	78.42	31.28
1	*2462.00	100.40 AV			1.40 V	264	69.12	31.28
2	2483.50	67.75 PK	74.00	-6.25	1.40 V	264	36.38	31.37
2	2483.50	51.56 AV	54.00	-2.44	1.40 V	264	20.19	31.37
3	3282.00	48.38 PK	74.00	-25.62	1.14 V	300	15.71	32.67
3	3282.00	44.69 AV	54.00	-9.31	1.14 V	300	12.02	32.67

*(The test data is in accordance with ADT Report No.: RF940321L05.)

- REMARKS:**
1. Emission level(dBuV/m)=Raw Value(dBuV) + Correction Factor(dB/m)
 2. Correction Factor(dB/m) = Antenna Factor (dB/m) + Cable Factor (dB)
 3. The other emission levels were very low against the limit.
 4. Margin value = Emission level – Limit value.
 5. The limit value is defined as per 15.247
 6. “ * “ : Fundamental frequency

802.11g Turbo OFDM modulation

EUT	WLAN 802.11a/b/g PCI Adapter	MODEL	WL-760A
CHANNEL	Channel 6	FREQUENCY RANGE	1 ~ 25GHz
MODULATION TYPE	BPSK	TRANSFER RATE	12Mbps
INPUT POWER (SYSTEM)	120Vac, 60 Hz	DETECTOR FUNCTION	Peak(PK) Average (AV)
ENVIRONMENTAL CONDITIONS	22deg. C, 62%RH, 991hPa	TESTED BY	Match Tsui

ANTENNA POLARITY & TEST DISTANCE: HORIZONTAL AT 3 M

No.	Freq. (MHz)	Emission Level (dBuV/m)	Limit (dBuV/m)	Margin (dB)	Antenna Height (m)	Table Angle (Degree)	Raw Value (dBuV)	Correction Factor (dB/m)
1	2390.00	71.63 PK	74.00	-2.37	1.35 H	330	40.66	30.97
1	2390.00	45.52 AV	54.00	-8.48	1.35 H	330	14.55	30.97
2	*2437.00	101.55 PK			1.35 H	150	70.38	31.17
2	*2437.00	92.46 AV			1.35 H	150	61.29	31.17
3	2483.50	71.62 PK	74.00	-2.38	1.35 H	330	40.25	31.37
3	2483.50	47.87 AV	54.00	-6.13	1.35 H	330	16.50	31.37

ANTENNA POLARITY & TEST DISTANCE: VERTICAL AT 3 M

No.	Freq. (MHz)	Emission Level (dBuV/m)	Limit (dBuV/m)	Margin (dB)	Antenna Height (m)	Table Angle (Degree)	Raw Value (dBuV)	Correction Factor (dB/m)
1	2390.00	73.57 PK	74.00	-0.43	1.35 V	330	42.60	30.97
1	2390.00	49.65 AV	54.00	-4.35	1.35 V	330	18.68	30.97
2	*2437.00	107.50 PK			1.37 V	200	76.33	31.17
2	*2437.00	99.12 AV			1.37 V	200	67.95	31.17
3	2483.50	72.63 PK	74.00	-1.37	1.35 V	330	41.26	31.37
3	2483.50	48.60 AV	54.00	-5.40	1.35 V	330	17.23	31.37
4	3249.00	46.20 PK	74.00	-27.80	1.30 V	12	13.57	32.63
4	3249.00	43.19 AV	54.00	-10.81	1.30 V	12	10.56	32.63

*(The test data is in accordance with ADT Report No.: RF940321L05.)

- REMARKS:**
1. Emission level(dBuV/m)=Raw Value(dBuV) + Correction Factor(dB/m)
 2. Correction Factor(dB/m) = Antenna Factor (dB/m) + Cable Factor (dB)
 3. The other emission levels were very low against the limit.
 4. Margin value = Emission level – Limit value.
 5. The limit value is defined as per 15.247
 6. " * " : Fundamental frequency



4.3 6dB BANDWIDTH MEASUREMENT

4.3.1 LIMITS OF 6dB BANDWIDTH MEASUREMENT

The minimum of 6dB Bandwidth Measurement is 0.5 MHz.

4.3.2 TEST INSTRUMENTS

Description & Manufacturer	Model No.	Serial No.	Calibrated Until
SPECTRUM ANALYZER	FSEK 30	100049	Aug. 12, 2005

NOTE: The calibration interval of the above test instruments is 12 months and the calibrations are traceable to NML/ROC and NIST/USA.

4.3.3 TEST PROCEDURE

The transmitter output was connected to the spectrum analyzer through an attenuator. The bandwidth of the fundamental frequency was measured by spectrum analyzer with 100kHz RBW and 100kHz VBW. The 6dB bandwidth is defined as the total spectrum the power of which is higher than peak power minus 6dB.

4.3.4 DEVIATION FROM TEST STANDARD

No deviation

4.3.5 TEST SETUP



4.3.6 EUT OPERATING CONDITIONS

The software provided by client to enable the EUT under transmission condition continuously at lowest, middle and highest channel frequencies individually.

4.3.7 TEST RESULTS

802.11b DSSS modulation

EUT	WLAN 802.11a/b/g PCI Adapter	MODEL	WL-760A
MODULATION TYPE	CCK	TRANSFER RATE	11Mbps
INPUT POWER (SYSTEM)	120Vac, 60 Hz	ENVIRONMENTAL CONDITIONS	22deg. C, 55%RH, 991hPa
TESTED BY	Gary Chang		

CHANNEL	CHANNEL FREQUENCY (MHz)	6dB BANDWIDTH (MHz)	MINIMUM LIMIT (MHz)	PASS/FAIL
1	2412	12.08	0.5	PASS
6	2437	11.92	0.5	PASS
11	2462	11.84	0.5	PASS

*(The test data is in accordance with ADT Report No.: RF940321L05.)



CH1

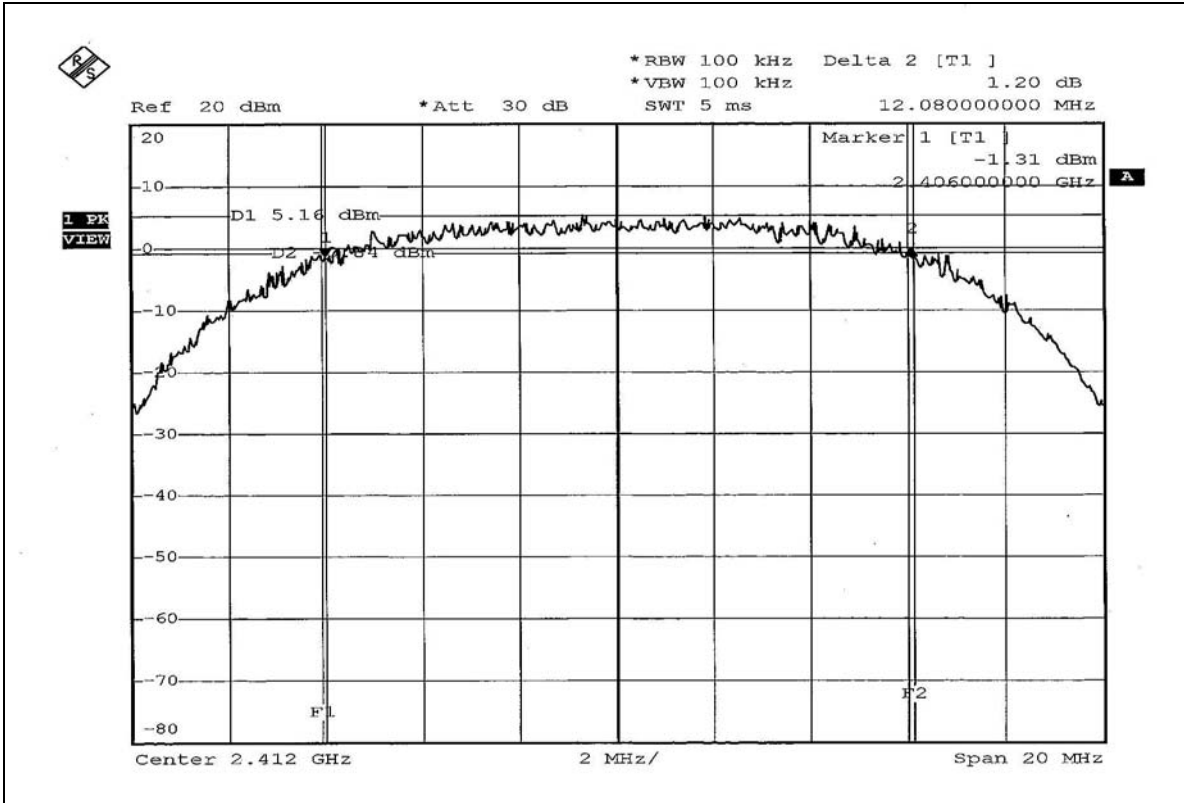

CH6

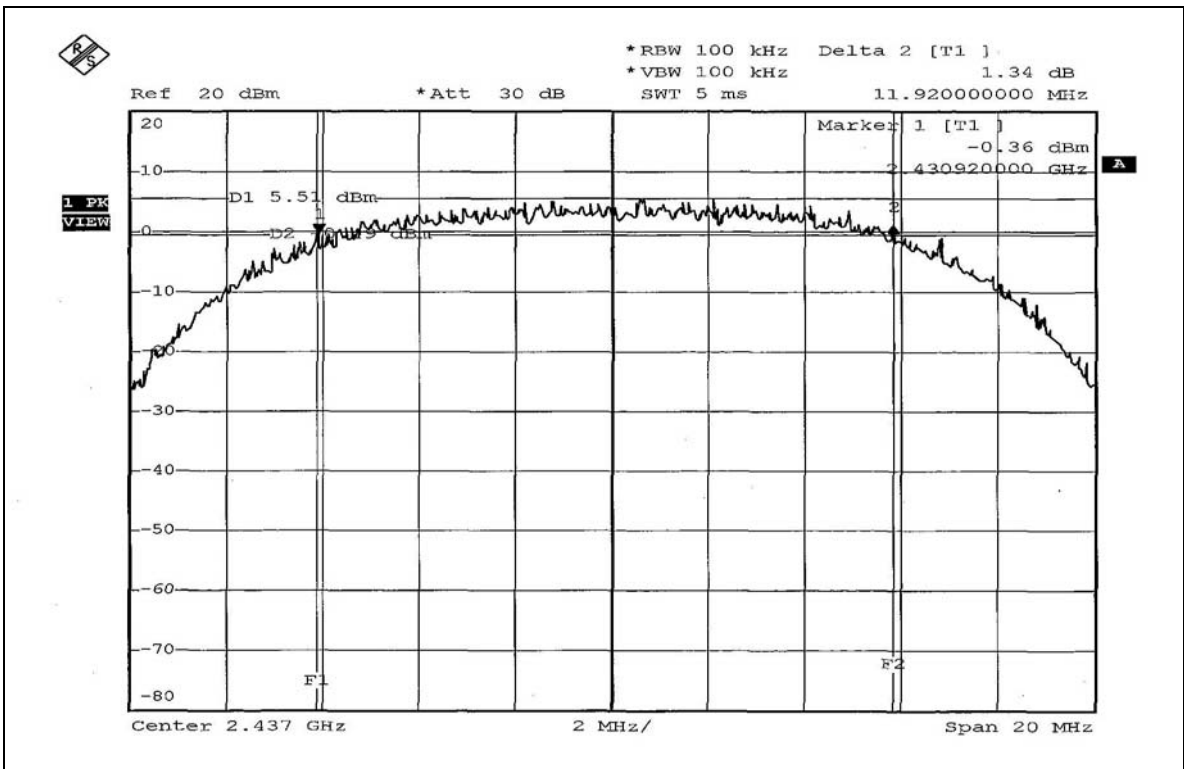



CH11

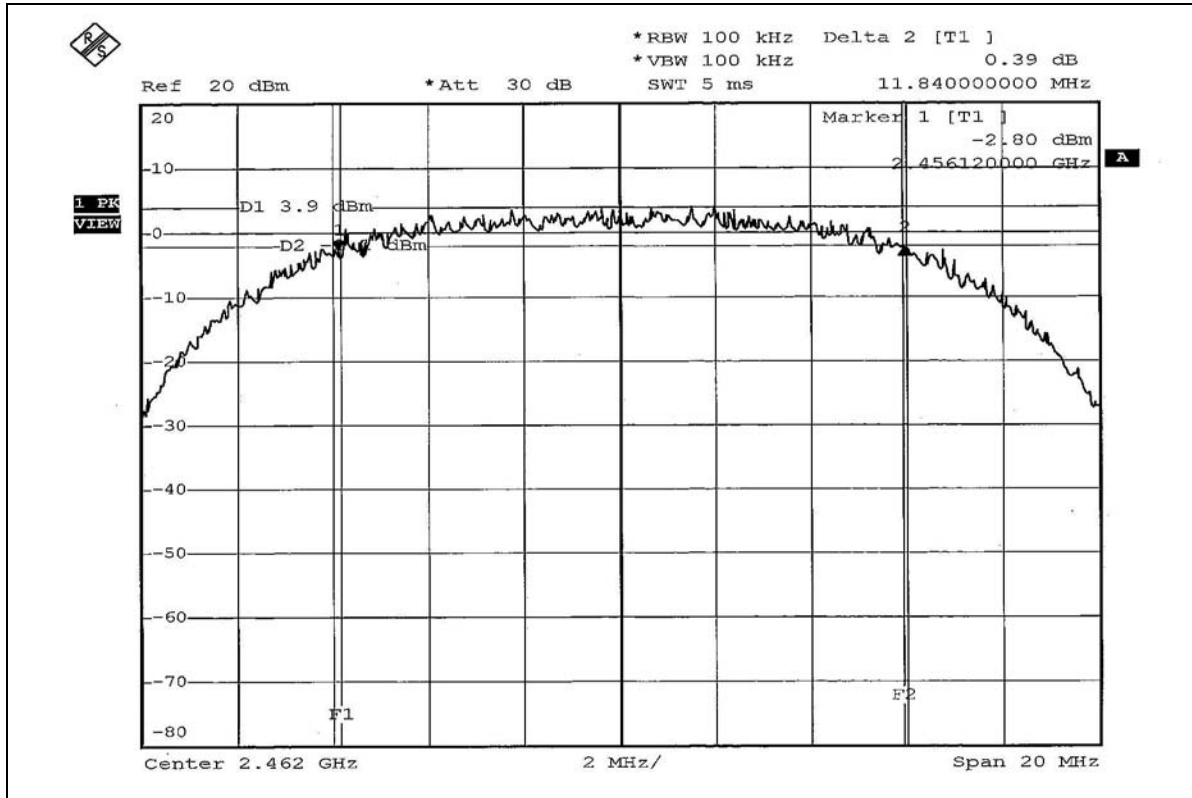

**802.11g OFDM modulation**

EUT	WLAN 802.11a/b/g PCI Adapter	MODEL	WL-760A
MODULATION TYPE	BPSK	TRANSFER RATE	6Mbps
INPUT POWER (SYSTEM)	120Vac, 60 Hz	ENVIRONMENTAL CONDITIONS	22deg. C, 55%RH, 991hPa
TESTED BY	Gary Chang		

CHANNEL	CHANNEL FREQUENCY (MHz)	6dB BANDWIDTH (MHz)	MINIMUM LIMIT (MHz)	PASS/FAIL
1	2412	16.36	0.5	PASS
6	2437	16.36	0.5	PASS
11	2462	16.48	0.5	PASS

*(The test data is in accordance with ADT Report No.: RF940321L05.)



CH1

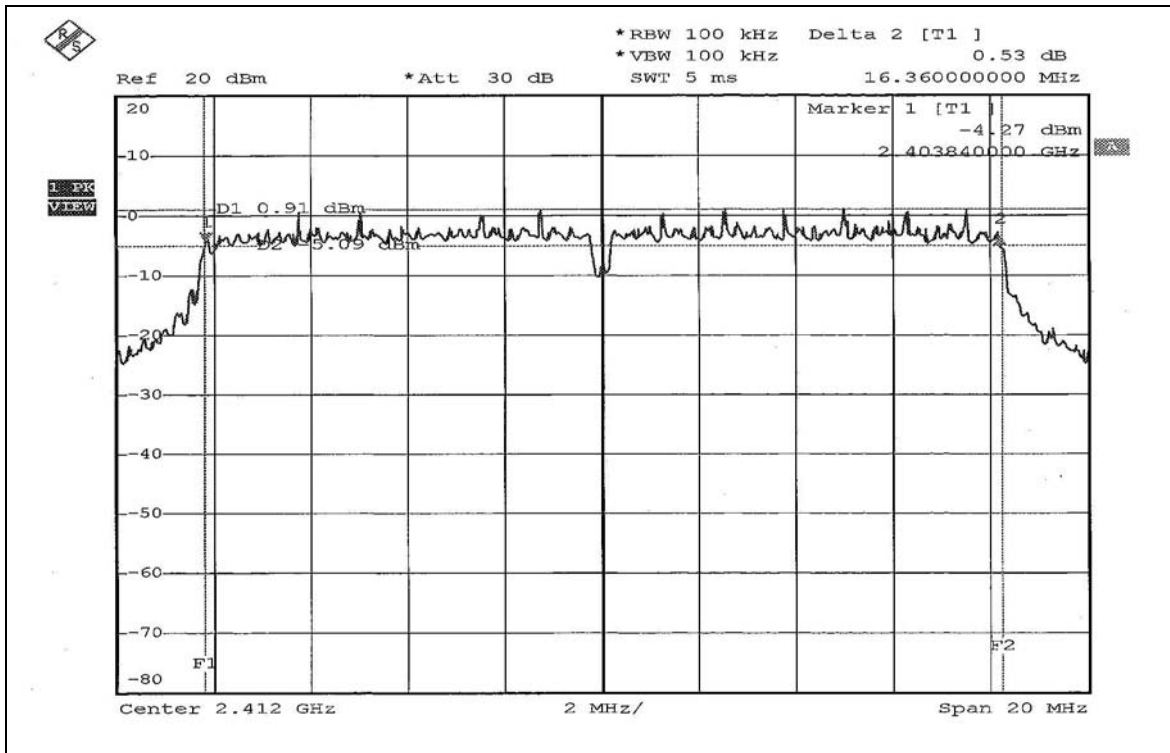

CH6

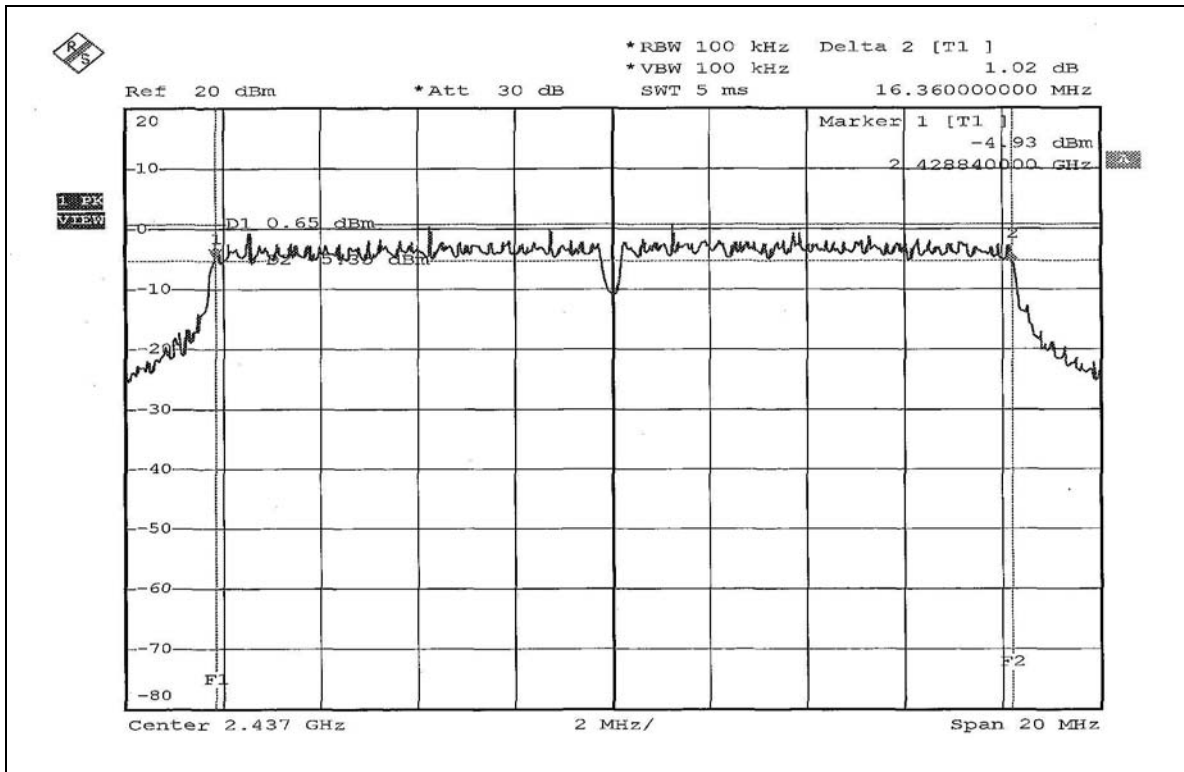



CH11

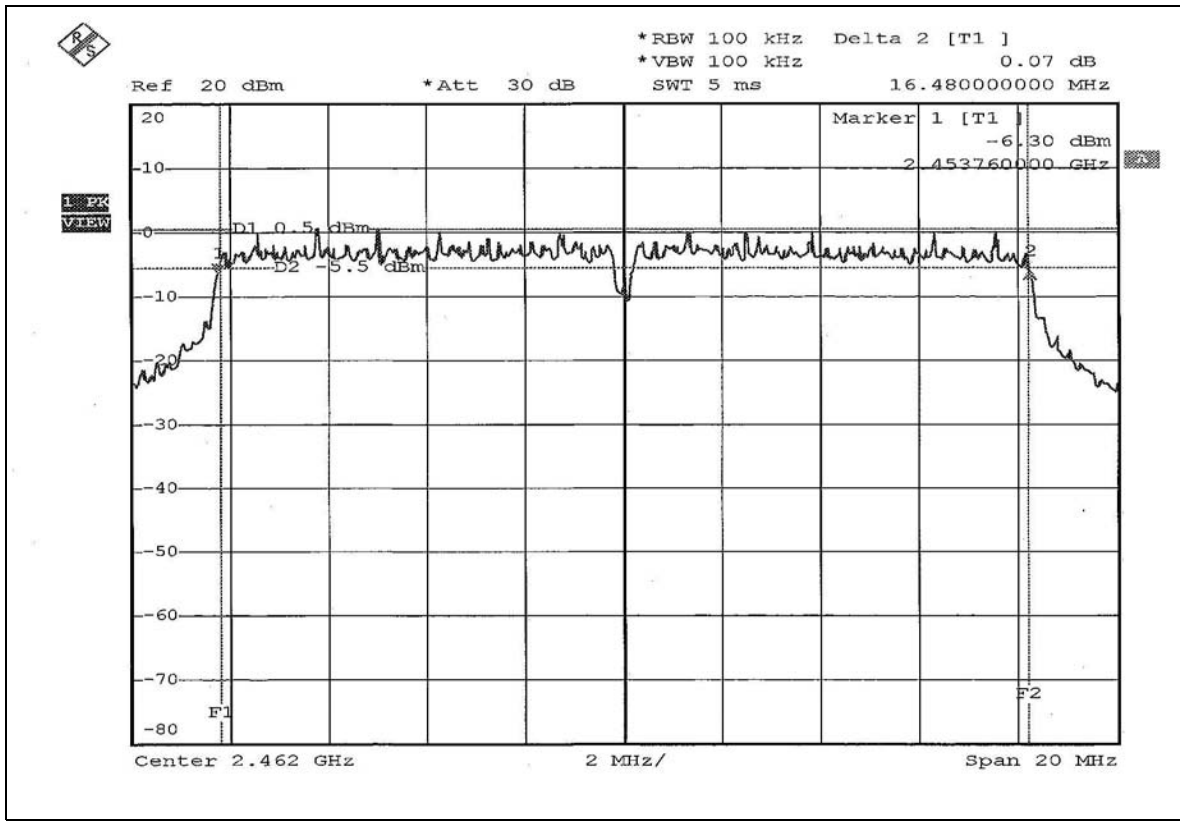

**802.11g Turbo OFDM modulation**

EUT	WLAN 802.11a/b/g PCI Adapter	MODEL	WL-760A
MODULATION TYPE	BPSK	TRANSFER RATE	12Mbps
INPUT POWER (SYSTEM)	120Vac, 60 Hz	ENVIRONMENTAL CONDITIONS	22deg. C, 55%RH, 991hPa
TESTED BY	Gary Chang		

CHANNEL	CHANNEL FREQUENCY (MHz)	6dB BANDWIDTH (MHz)	MINIMUM LIMIT (MHz)	PASS/FAIL
6	2437	32.48	0.5	PASS

*(The test data is in accordance with ADT Report No.: RF940321L05.)



CH6

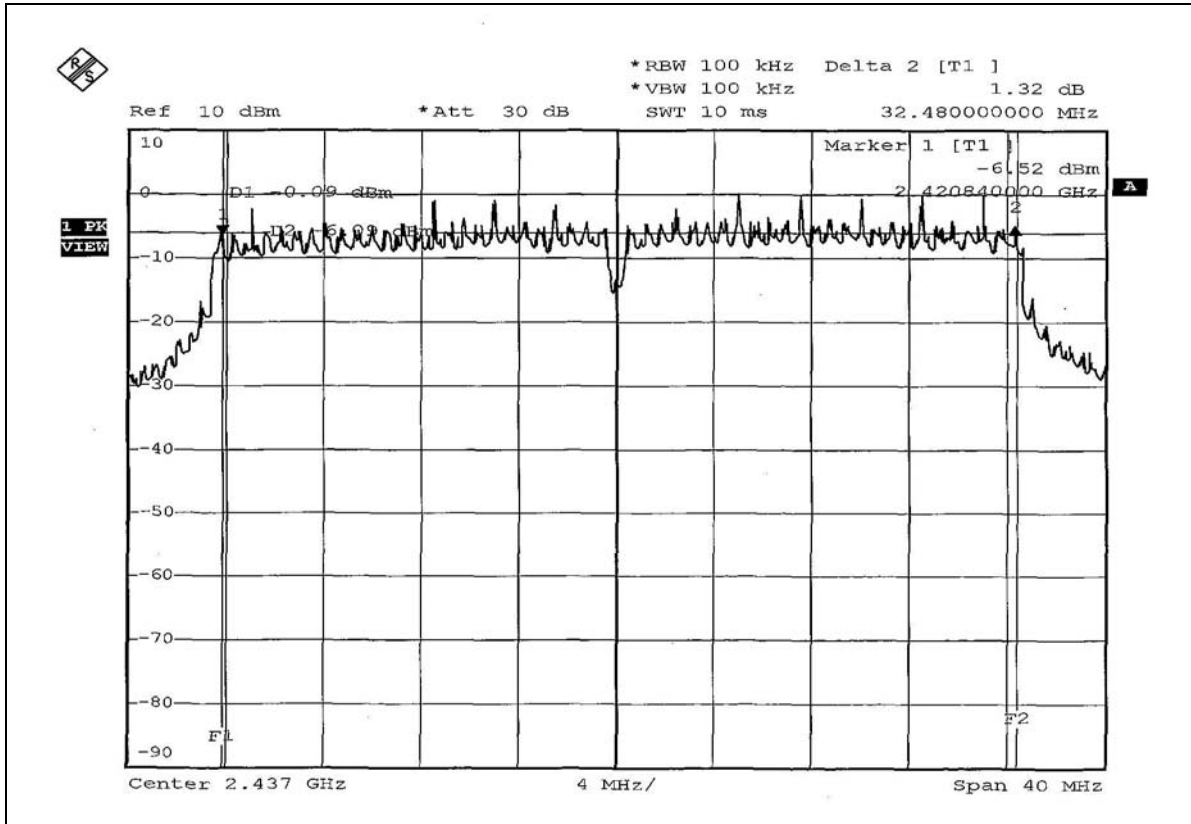



4.4 MAXIMUM PEAK OUTPUT POWER

4.4.1 LIMITS OF MAXIMUM PEAK OUTPUT POWER MEASUREMENT

The Maximum Peak Output Power Measurement is 30dBm.

4.4.2 INSTRUMENTS

Description & Manufacturer	Model No.	Serial No.	Calibrated Until
R&S SPECTRUM ANALYZER	FSEK30	100049	Aug. 12, 2005
AGILENT SIGNAL GENERATOR	E8257C	MY43320668	Dec. 06, 2005
TEKTRONIX OSCILLOSCOPE	TDS 1012	C019167	Feb. 01, 2006
NARDA DETECTOR	4503A	FSCM99899	NA

NOTE:

The calibration interval of the above test instruments is 12 months and the calibrations are traceable to NML/ROC and NIST/USA.

4.4.3 TEST PROCEDURES

1. A detector was used on the output port of the EUT. An oscilloscope was used to read the response of the detector.
2. Replaced the EUT by the signal generator. The center frequency of the S.G was adjusted to the center frequency of the measured channel.
3. Adjusted the power to have the same reading on oscilloscope. Record the power level.

4.4.4 DEVIATION FROM TEST STANDARD

No deviation

4.4.5 TEST SETUP



4.4.6 EUT OPERATING CONDITIONS

Same as Item 4.3.6

4.4.7 TEST RESULTS

802.11b DSSS modulation

EUT	WLAN 802.11a/b/g PCI Adapter	MODEL	WL-760A
MODULATION TYPE	CCK	TRANSFER RATE	11Mbps
INPUT POWER (SYSTEM)	120Vac, 60Hz	ENVIRONMENTAL CONDITIONS	22deg. C, 55%RH, 991hPa
TESTED BY	Gary Chang		

CHANNEL	CHANNEL FREQUENCY (MHz)	PEAK POWER OUTPUT (mW)	PEAK POWER OUTPUT (dBm)	PEAK POWER LIMIT (dBm)	PASS/FAIL
1	2412	63.387	18.02	30	PASS
6	2437	63.826	18.05	30	PASS
11	2462	50.582	17.04	30	PASS

*(The test data is in accordance with ADT Report No.: RF940321L05.)

**802.11g OFDM modulation**

EUT	WLAN 802.11a/b/g PCI Adapter	MODEL	WL-760A
MODULATION TYPE	BPSK	TRANSFER RATE	6Mbps
INPUT POWER (SYSTEM)	120Vac, 60Hz	ENVIRONMENTAL CONDITIONS	22deg. C, 55%RH, 991hPa
TESTED BY	Gary Chang		

CHANNEL	CHANNEL FREQUENCY (MHz)	PEAK POWER OUTPUT (mW)	PEAK POWER OUTPUT (dBm)	PEAK POWER LIMIT (dBm)	PASS/FAIL
1	2412	50.582	17.04	30	PASS
6	2437	51.050	17.08	30	PASS
11	2462	50.699	17.05	30	PASS

802.11g Turbo OFDM modulation

EUT	WLAN 802.11a/b/g PCI Adapter	MODEL	WL-760A
MODULATION TYPE	BPSK	TRANSFER RATE	12Mbps
INPUT POWER (SYSTEM)	120Vac, 60Hz	ENVIRONMENTAL CONDITIONS	22deg. C, 55%RH, 991hPa
TESTED BY	Gary Chang		

CHANNEL	CHANNEL FREQUENCY (MHz)	PEAK POWER OUTPUT (mW)	PEAK POWER OUTPUT (dBm)	PEAK POWER LIMIT (dBm)	PASS/FAIL
6	2437	50.350	17.02	30	PASS

*(The test data is in accordance with ADT Report No.: RF940321L05.)



4.5 POWER SPECTRAL DENSITY MEASUREMENT

4.5.1 LIMITS OF POWER SPECTRAL DENSITY MEASUREMENT

The Maximum of Power Spectral Density Measurement is 8dBm.

4.5.2 TEST INSTRUMENTS

Description & Manufacturer	Model No.	Serial No.	Calibrated Until
R&S SPECTRUM ANALYZER	FSEK30	100049	Aug. 12, 2005

NOTE:

The calibration interval of the above test instruments is 12 months and the calibrations are traceable to NML/ROC and NIST/USA.

4.5.3 TEST PROCEDURE

The transmitter output was connected to the spectrum analyzer through an attenuator, the bandwidth of the fundamental frequency was measured with the spectrum analyzer using 3kHz RBW and 30kHz VBW, set sweep time = span/3kHz. The power spectral density was measured and recorded. The sweep time is allowed to be longer than span/3kHz for a full response of the mixer in the spectrum analyzer.

4.5.4 DEVIATION FROM TEST STANDARD

No deviation

4.5.5 TEST SETUP

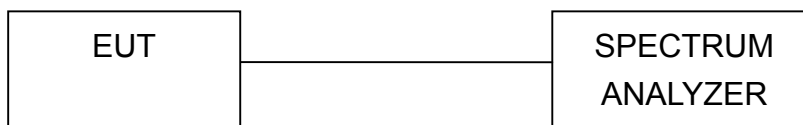

4.5.6 EUT OPERATING CONDITION

Same as Item 4.3.6



4.5.7 TEST RESULTS

802.11b DSSS modulation

EUT	WLAN 802.11a/b/g PCI Adapter	MODEL	WL-760A
MODULATION TYPE	CCK	TRANSFER RATE	11Mbps
INPUT POWER (SYSTEM)	120Vac, 60Hz	ENVIRONMENTAL CONDITIONS	22deg.C, 55%RH, 991hPa
TESTED BY	Gary Chang		

CHANNEL	CHANNEL FREQUENCY (MHz)	RF POWER LEVEL IN 3kHz BW (dBm)	MAXIMUM LIMIT (dBm)	PASS/FAIL
1	2412	-8.70	8	PASS
6	2437	-8.93	8	PASS
11	2462	-9.79	8	PASS

*(The test data is in accordance with ADT Report No.: RF940321L05.)



CH1

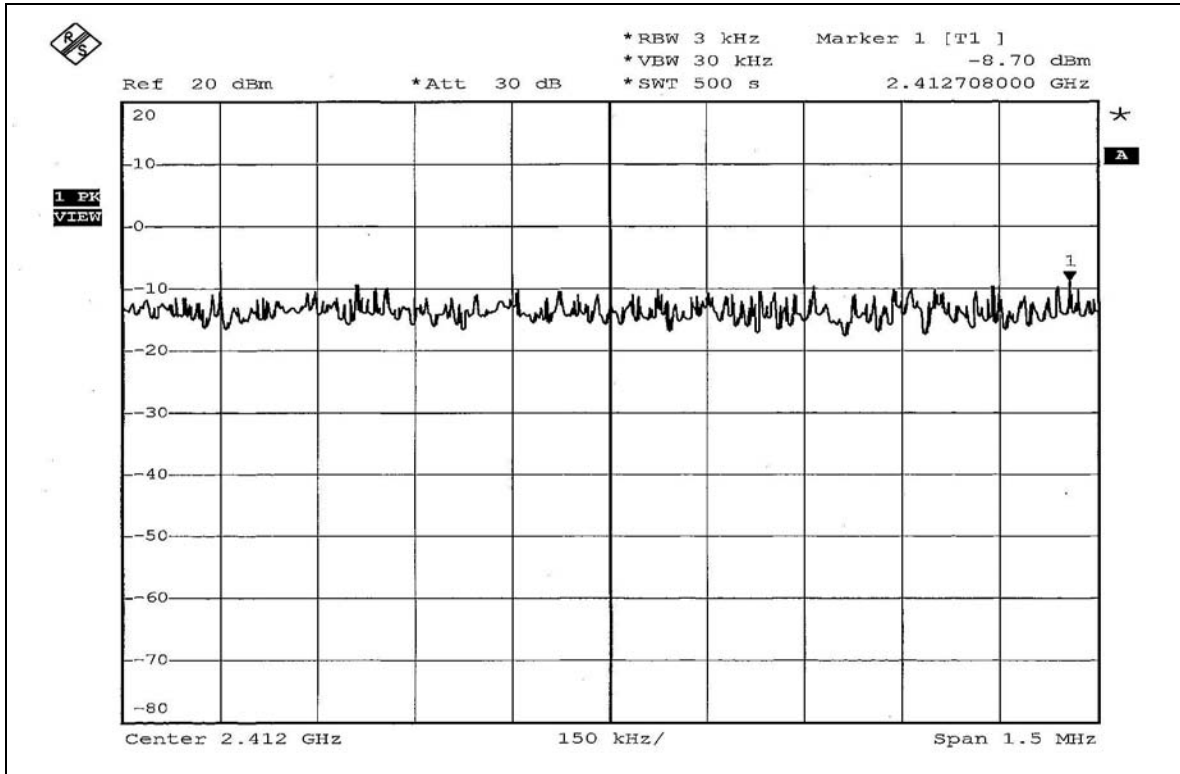

CH6

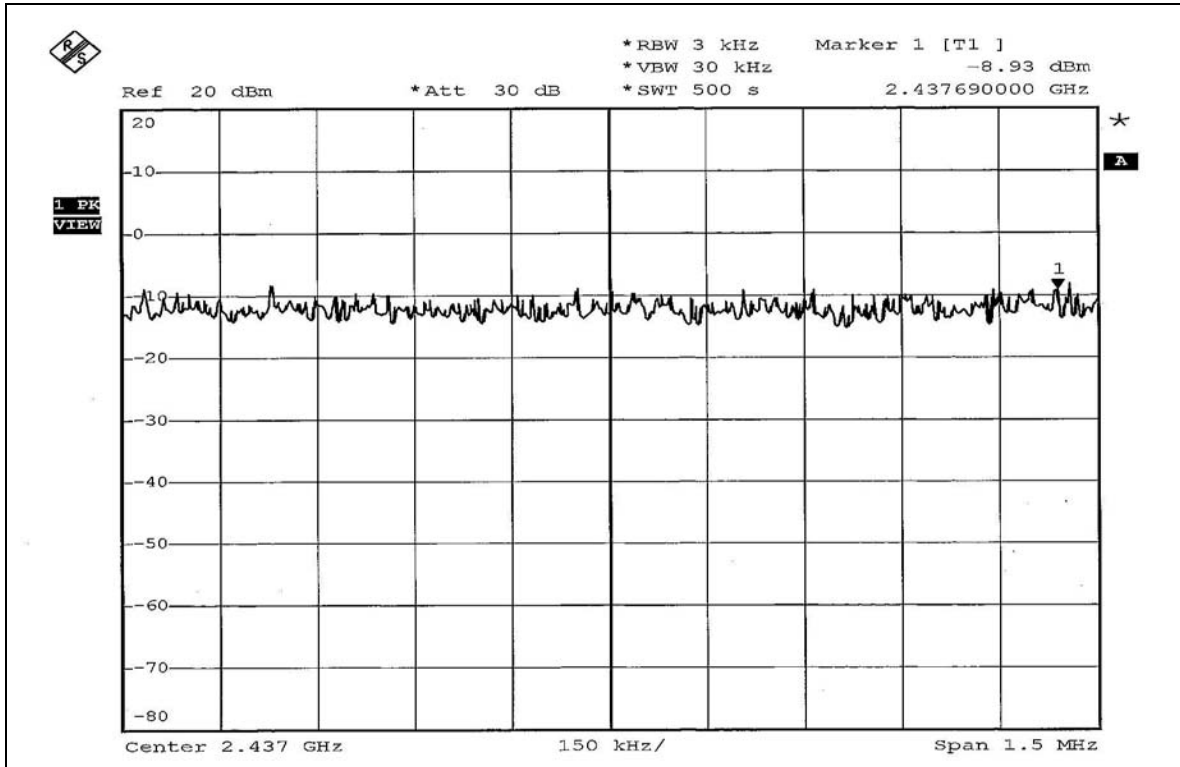



CH11

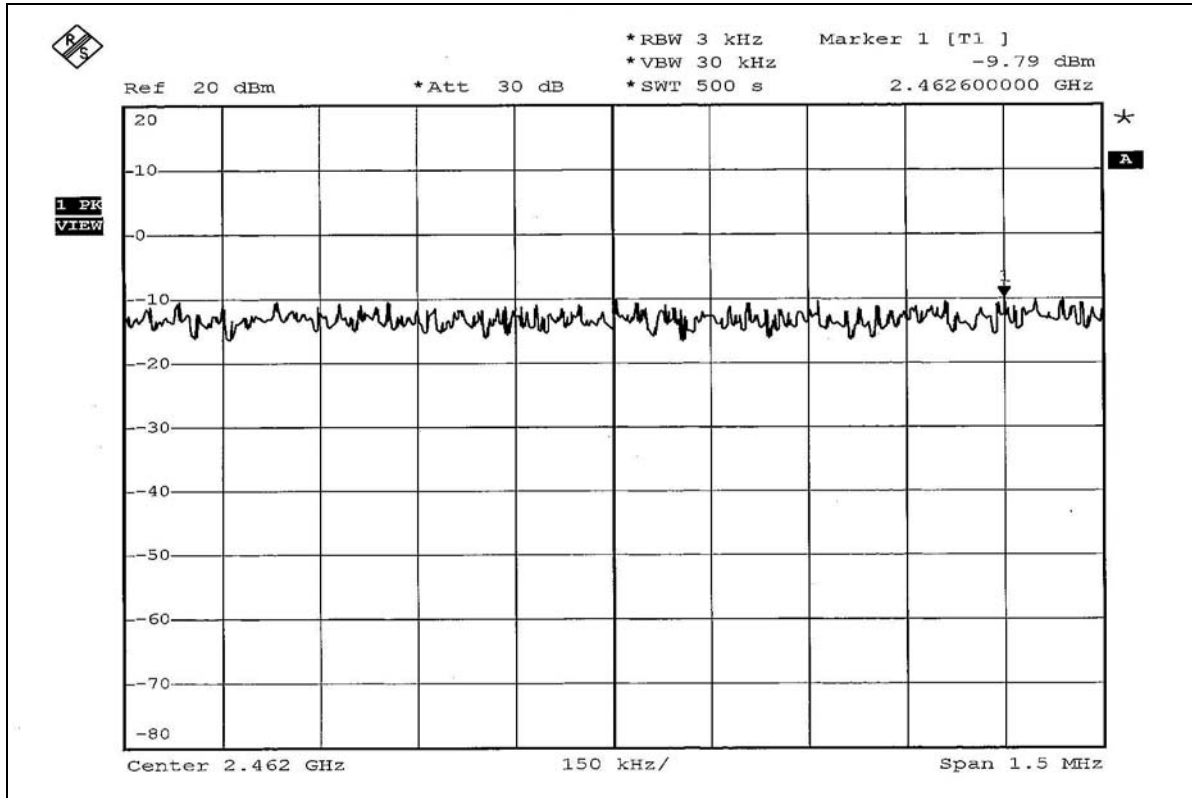

**802.11g OFDM modulation**

EUT	WLAN 802.11a/b/g PCI Adapter	MODEL	WL-760A
MODULATION TYPE	BPSK	TRANSFER RATE	6Mbps
INPUT POWER (SYSTEM)	120Vac, 60Hz	ENVIRONMENTAL CONDITIONS	22deg.C, 55%RH, 991hPa
TESTED BY	Gary Chang		

CHANNEL	CHANNEL FREQUENCY (MHz)	RF POWER LEVEL IN 3kHz BW (dBm)	MAXIMUM LIMIT (dBm)	PASS/FAIL
1	2412	-12.30	8	PASS
6	2437	-12.72	8	PASS
11	2462	-12.49	8	PASS

*(The test data is in accordance with ADT Report No.: RF940321L05.)

**802.11g Turbo OFDM modulation**

EUT	WLAN 802.11a/b/g PCI Adapter	MODEL	WL-760A
MODULATION TYPE	BPSK	TRANSFER RATE	12Mbps
INPUT POWER (SYSTEM)	120Vac, 60Hz	ENVIRONMENTAL CONDITIONS	22deg.C, 55%RH, 991hPa
TESTED BY	Gary Chang		

CHANNEL	CHANNEL FREQUENCY (MHz)	RF POWER LEVEL IN 3kHz BW (dBm)	MAXIMUM LIMIT (dBm)	PASS/FAIL
6	2437	-16.34	8	PASS

*(The test data is in accordance with ADT Report No.: RF940321L05.)



CH6

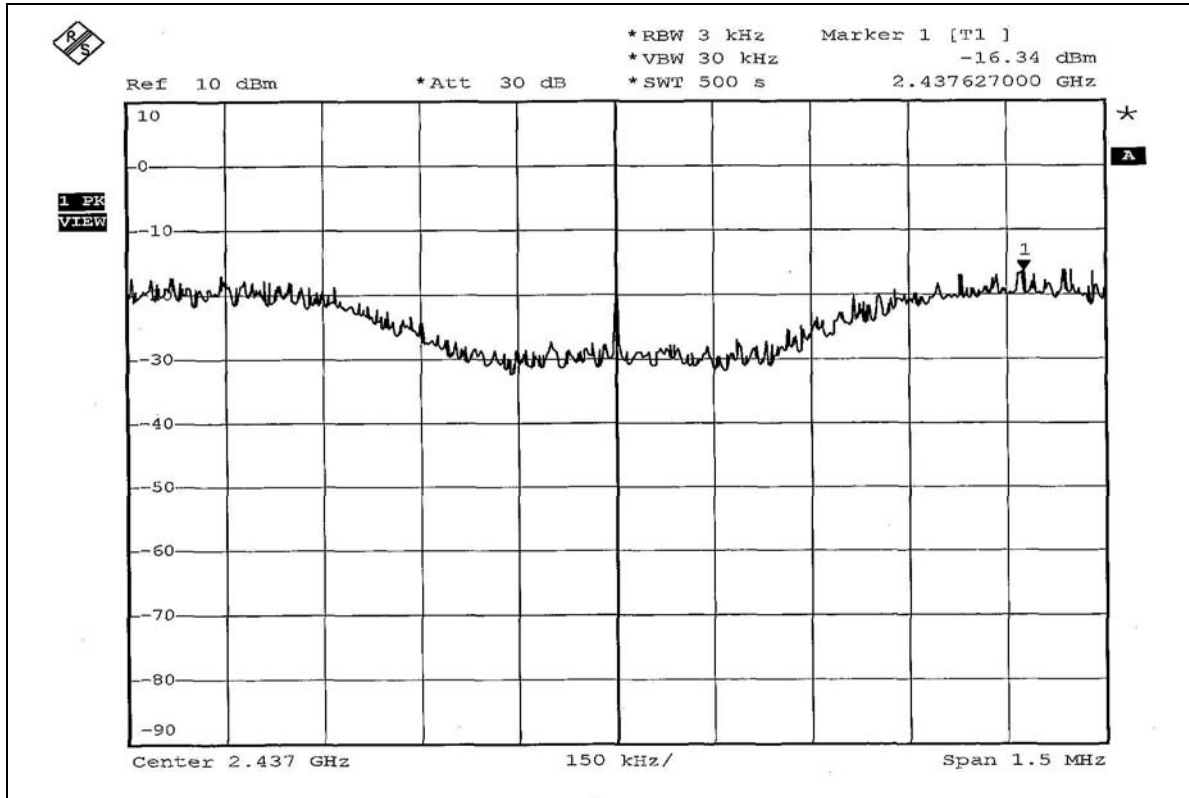



4.6 BAND EDGES MEASUREMENT

4.6.1 LIMITS OF BAND EDGES MEASUREMENT

Below -20dB of the highest emission level of operating band (in 100kHz Resolution Bandwidth).

4.6.2 TEST INSTRUMENTS

Description & Manufacturer	Model No.	Serial No.	Calibrated Until
R&S SPECTRUM ANALYZER	FSEK30	100049	Aug. 12, 2005

NOTE: The calibration interval of the above test instruments is 12 months and the calibrations are traceable to NML/ROC and NIST/USA.

4.6.3 TEST PROCEDURE

The transmitter output was connected to the spectrum analyzer via a low lose cable. Set both RBW and VBW of spectrum analyzer to 100kHz with suitable frequency span including 100 MHz bandwidth from band edge. The band edges was measured and recorded.

The spectrum plots (Peak RBW=VBW=100kHz ; Average RBW=1MHz, VBW=10Hz) are attached on the following pages.

4.6.4 DEVIATION FROM TEST STANDARD

No deviation

4.6.5 EUT OPERATING CONDITION

Same as Item 4.3.6



4.6.6 TEST RESULTS

The spectrum plots are attached on the following 18 images. D2 line indicates the highest level, and D1 line indicates the 20dB offset below D2. It shows compliance with the requirement in part 15.247(d).

802.11b DSSS modulation

NOTE 1: The band edge emission plot on page 63 shows 52.93dBc between carrier maximum power and local maximum emission in restrict band (2.3842GHz). The emission of carrier strength list in the test result of channel 1 at the item 4.2.7 is 112.78dBuV/m (Peak), so the maximum field strength in restrict band is $112.78 - 52.93 = 59.85$ dBuV/m which is under 74dBuV/m limit..

The band edge emission plot of on page 63 shows 56.49dBc between carrier maximum power and local maximum emission in restrict band (2.3719GHz). The emission of carrier strength list in the test result of channel 1 at the item 4.2.7 is 105.43dBuV/m (Average), so the maximum field strength in restrict band is $105.43 - 56.49 = 48.94$ dBuV/m which is under 54dBuV/m limit.

NOTE 2: The band edge emission plot on page 64 shows 50.91dBc between carrier maximum power and local maximum emission in restrict band (2.5000GHz). The emission of carrier strength list in the test result of channel 11 at the item 4.2.7 is 112.46dBuV/m (Peak), so the maximum field strength in restrict band is $112.46 - 50.91 = 61.55$ dBuV/m which is under 74dBuV/m limit.

The band edge emission plot on page 65 shows 53.33dBc between carrier maximum power and local maximum emission in restrict band (2.5000GHz). The emission of carrier strength list in the test result of channel 11 at the item 4.2.7 is 105.83dBuV/m (Average), so the maximum field strength in restrict band is $105.83 - 53.33 = 52.50$ dBuV/m which is under 54dBuV/m limit.

*(The test data is in accordance with ADT Report No.: RF940321L05.)



802.11g OFDM modulation

NOTE 1: The band edge emission plot on page 66 shows 48.30dBc between carrier maximum power and local maximum emission in restrict band (2.3890GHz). The emission of carrier strength list in the test result of channel 1 at the item 4.2.7 is 109.19dBuV/m (Peak), so the maximum field strength in restrict band is $109.19 - 48.30 = 60.89$ dBuV/m which is under 74dBuV/m limit.

The band edge emission plot of on page 66 shows 50.91dBc between carrier maximum power and local maximum emission in restrict band (2.3898GHz). The emission of carrier strength list in the test result of channel 1 at the item 4.2.7 is 97.98dBuV/m (Average), so the maximum field strength in restrict band is $97.98 - 50.91 = 47.07$ dBuV/m which is under 54dBuV/m limit.

NOTE 2: The band edge emission plot on page 67 shows 45.86dBc between carrier maximum power and local maximum emission in restrict band (2.4842GHz). The emission of carrier strength list in the test result of channel 11 at the item 4.2.7 is 109.70dBuV/m (Peak), so the maximum field strength in restrict band is $109.70 - 45.86 = 63.84$ dBuV/m which is under 74dBuV/m limit.

The band edge emission plot on page 68 shows 48.73dBc between carrier maximum power and local maximum emission in restrict band (2.4835GHz). The emission of carrier strength list in the test result of channel 11 at the item 4.2.7 is 100.40dBuV/m (Average), so the maximum field strength in restrict band is $100.40 - 48.73 = 51.67$ dBuV/m which is under 54dBuV/m limit.

*(The test data is in accordance with ADT Report No.: RF940321L05.)



802.11g Turbo OFDM modulation

NOTE 1: The band edge emission plot on page 69 shows 51.29dBc between carrier maximum power and local maximum emission in restrict band (2.3900GHz). The emission of carrier strength list in the test result of channel 6 at the item 4.2.7 is 107.50dBuV/m (Peak), so the maximum field strength in restrict band is $107.50 - 51.29 = 56.21$ dBuV/m which is under 74dBuV/m limit.

The band edge emission plot of on page 69 shows 51.39dBc between carrier maximum power and local maximum emission in restrict band (2.3900GHz). The emission of carrier strength list in the test result of channel 6 at the item 4.2.7 is 99.12dBuV/m (Average), so the maximum field strength in restrict band is $99.12 - 51.39 = 47.73$ dBuV/m which is under 54dBuV/m limit.

NOTE 2: The band edge emission plot on page 70 shows 50.60dBc between carrier maximum power and local maximum emission in restrict band (2.4852GHz). The emission of carrier strength list in the test result of channel 6 at the item 4.2.7 is 107.50dBuV/m (Peak), so the maximum field strength in restrict band is $107.50 - 50.60 = 56.90$ dBuV/m which is under 74dBuV/m limit.

The band edge emission plot on page 71 shows 48.97dBc between carrier maximum power and local maximum emission in restrict band (2.4835GHz). The emission of carrier strength list in the test result of channel 6 at the item 4.2.7 is 99.12dBuV/m (Average), so the maximum field strength in restrict band is $99.12 - 48.97 = 50.15$ dBuV/m which is under 54dBuV/m limit.

*(The test data is in accordance with ADT Report No.: RF940321L05.)



802.11b DSSS modulation

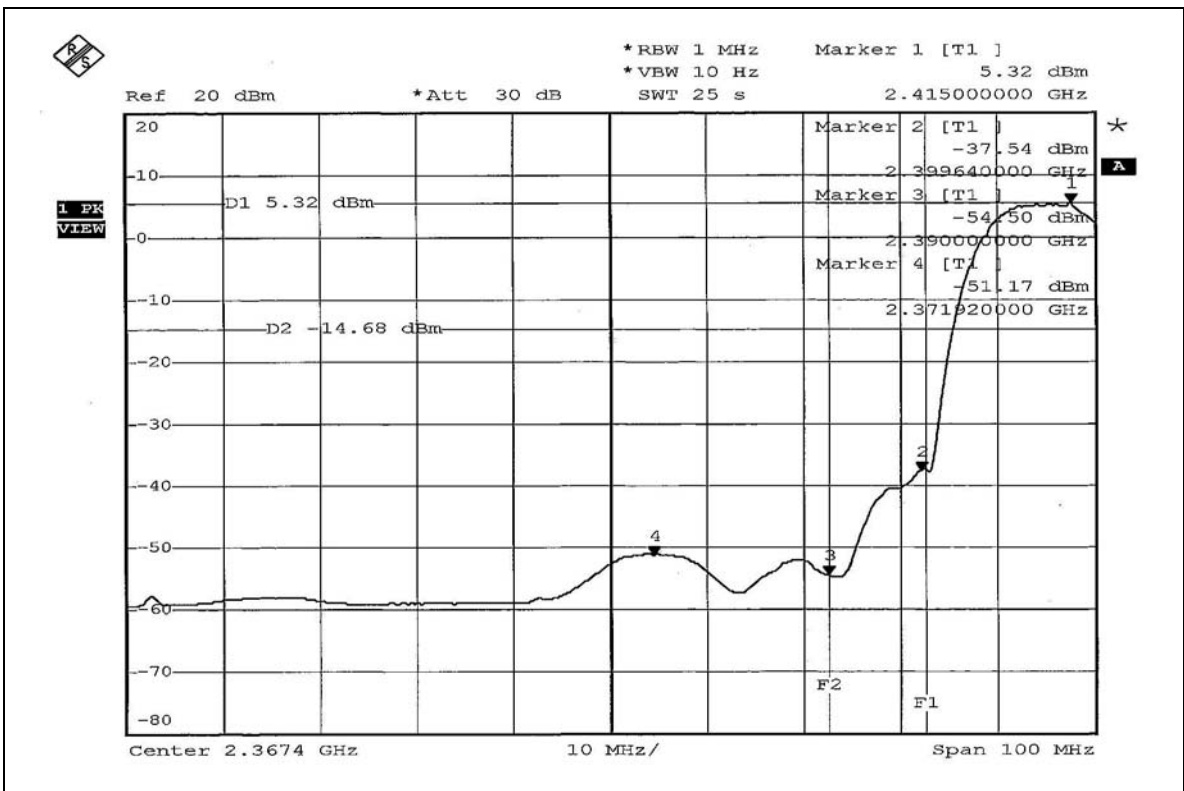
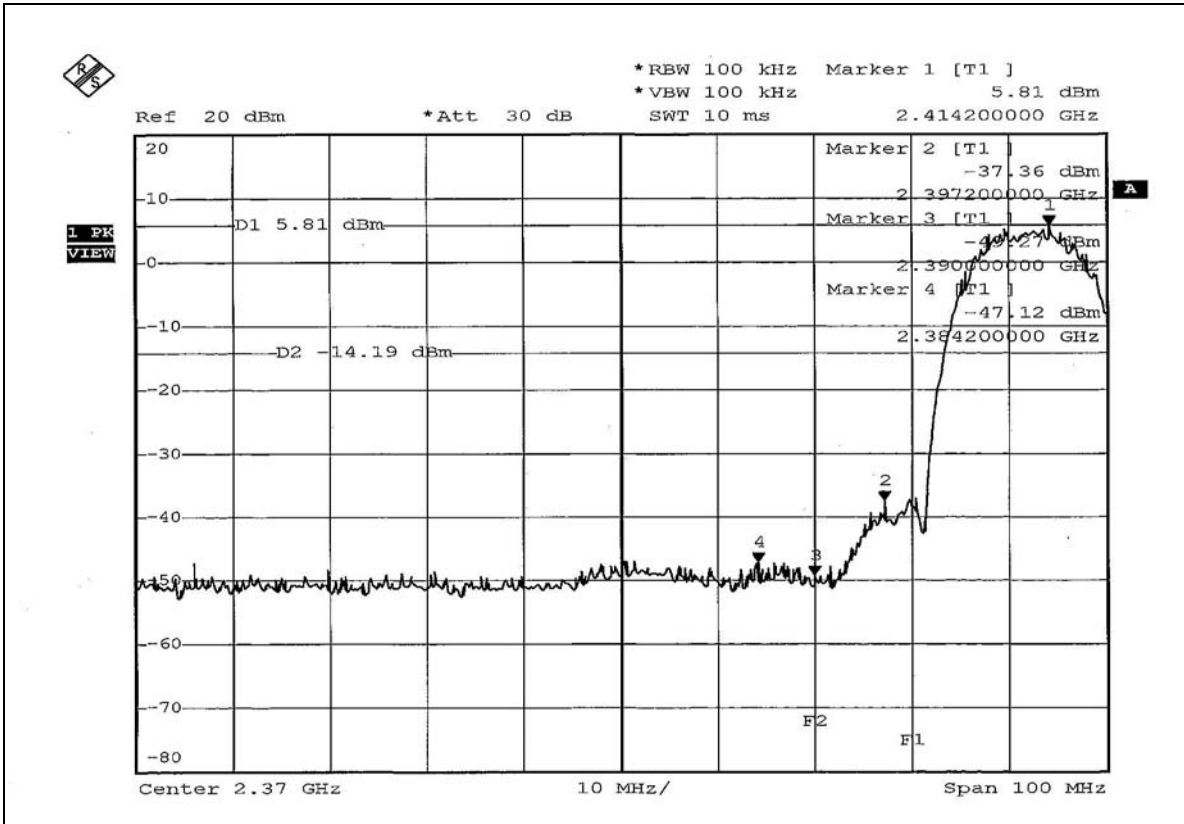

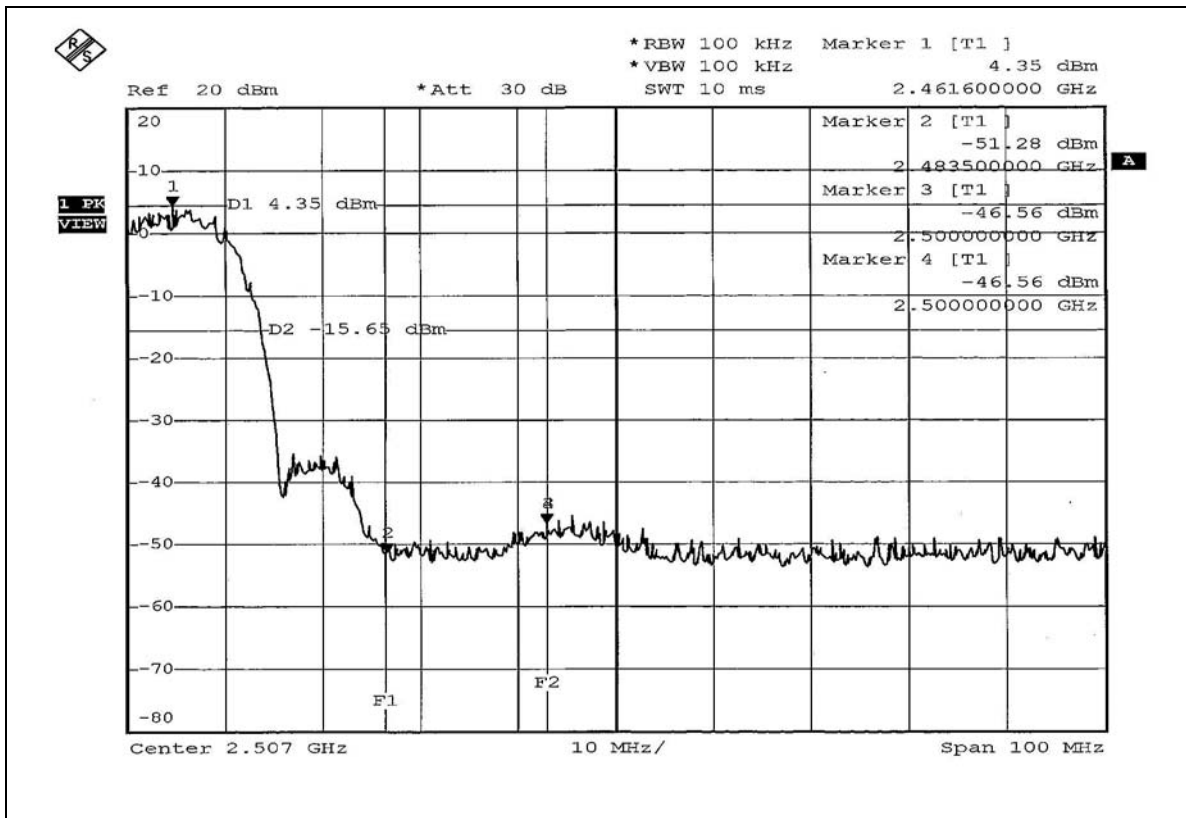
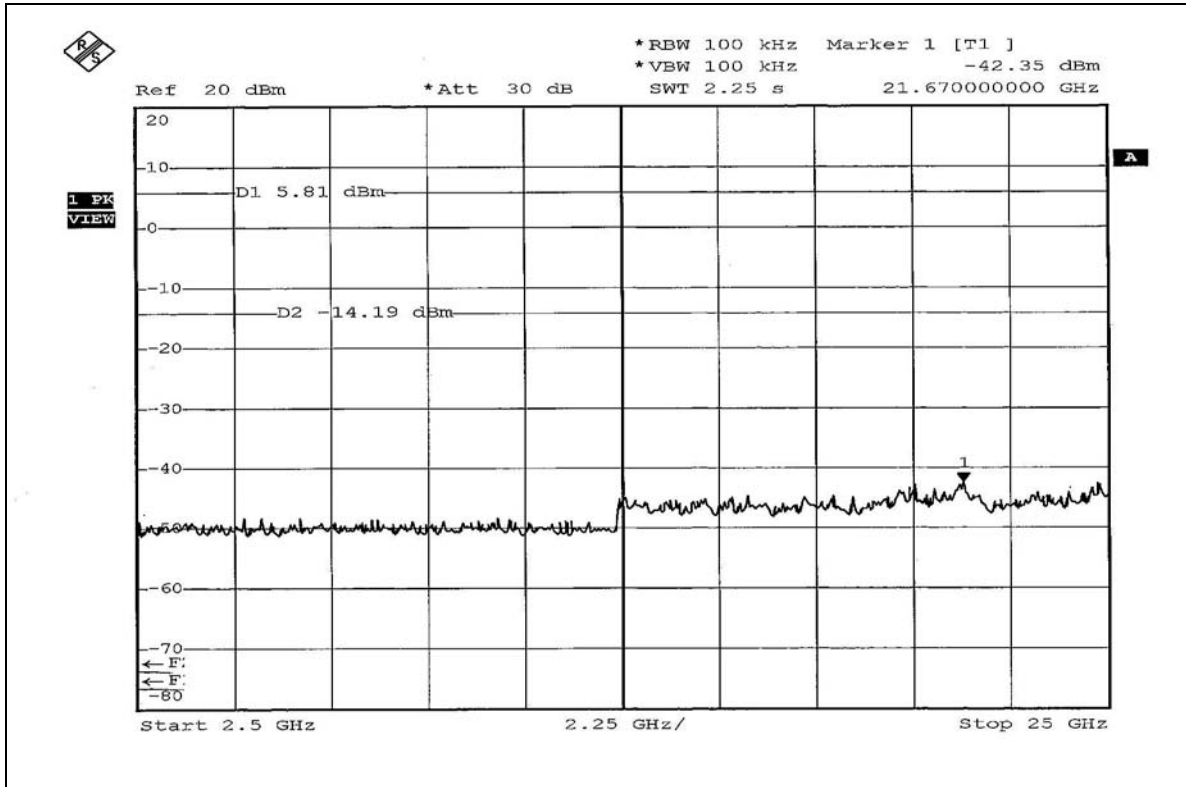

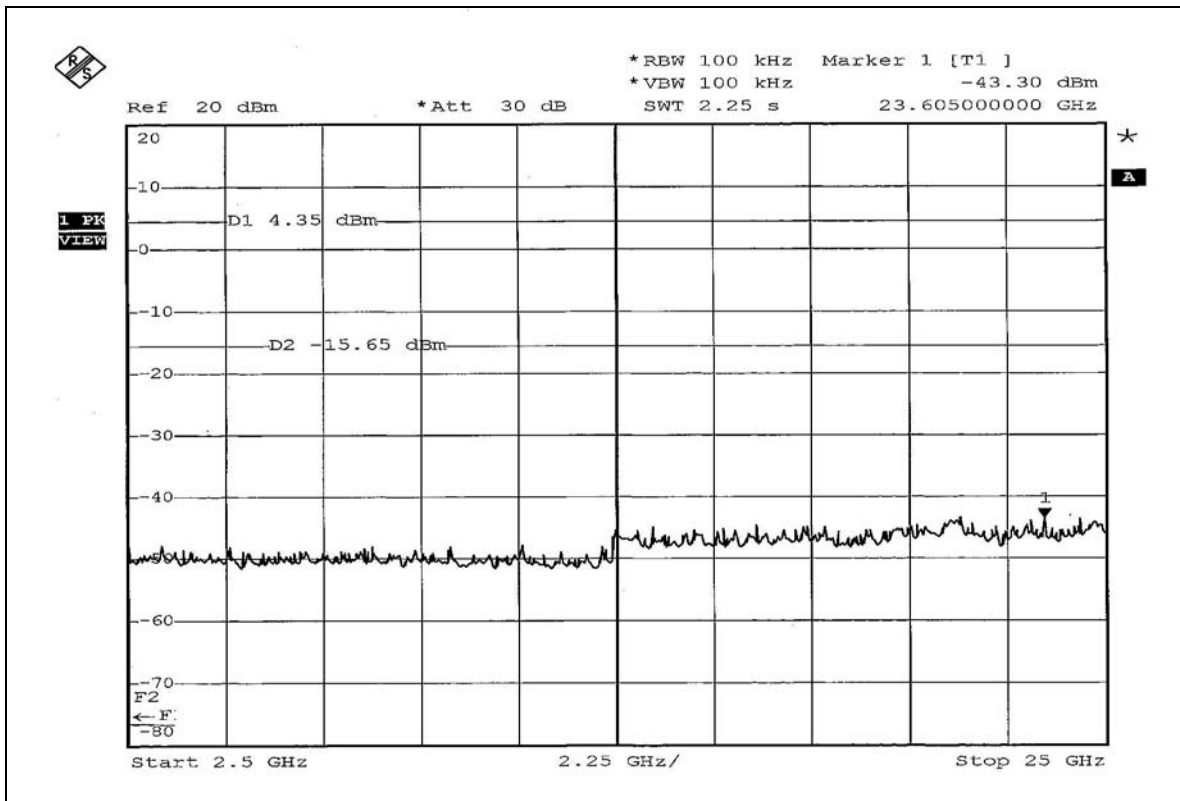
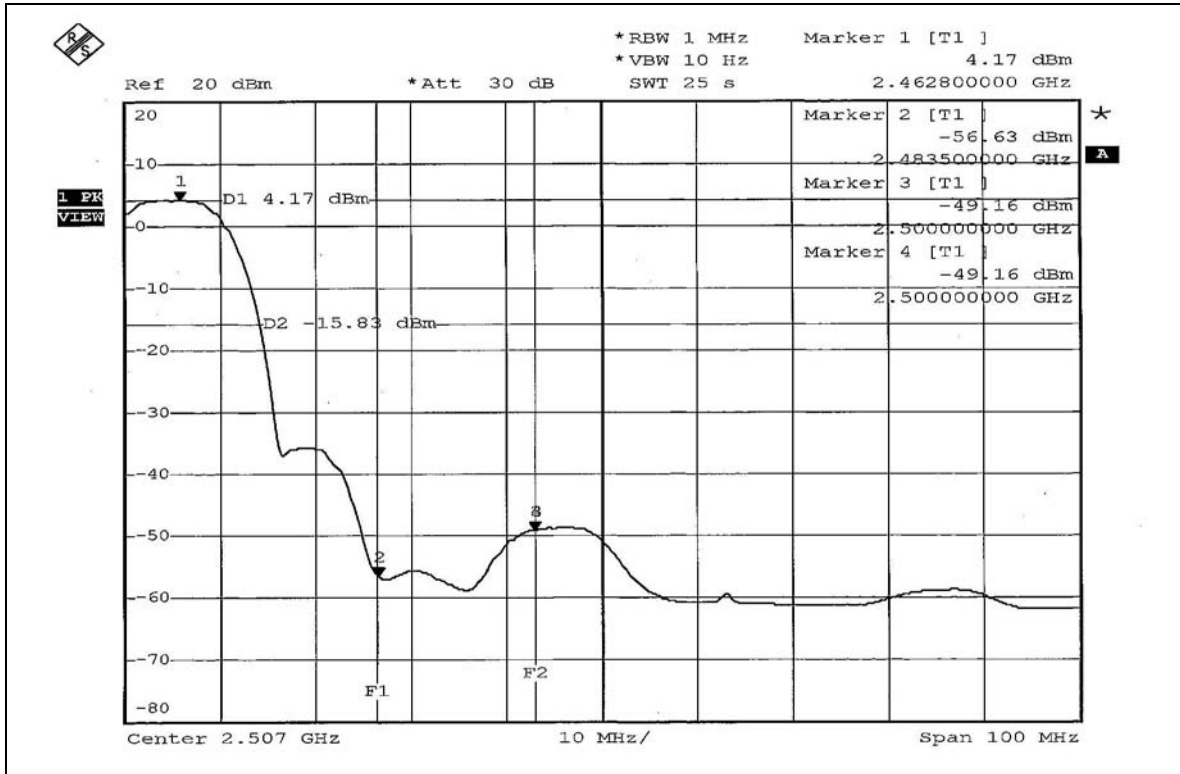



802.11g OFDM modulation

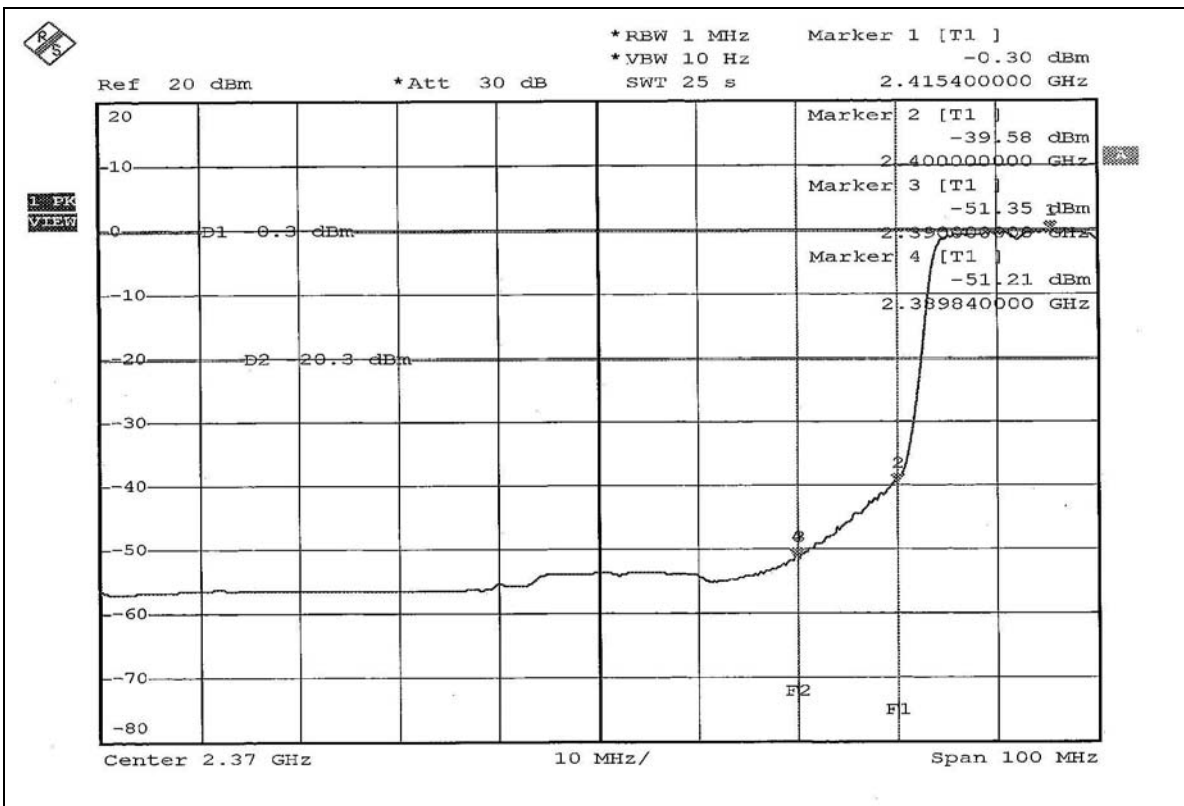
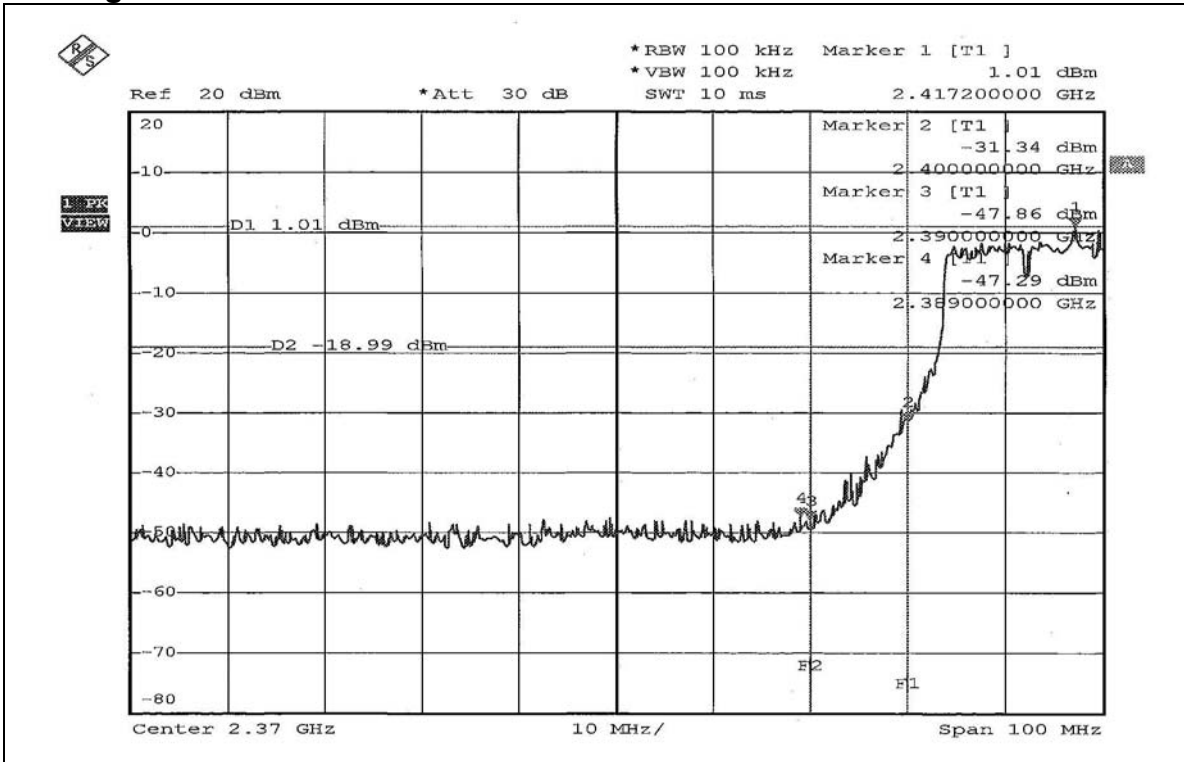

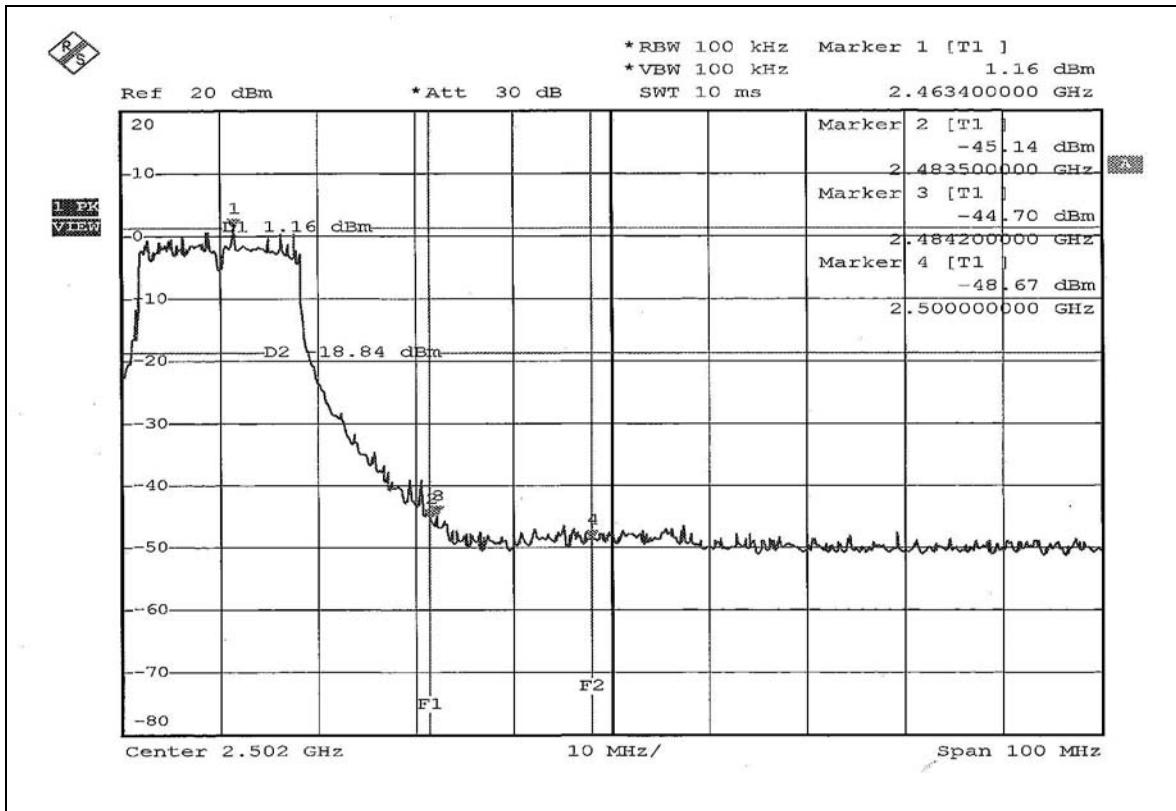
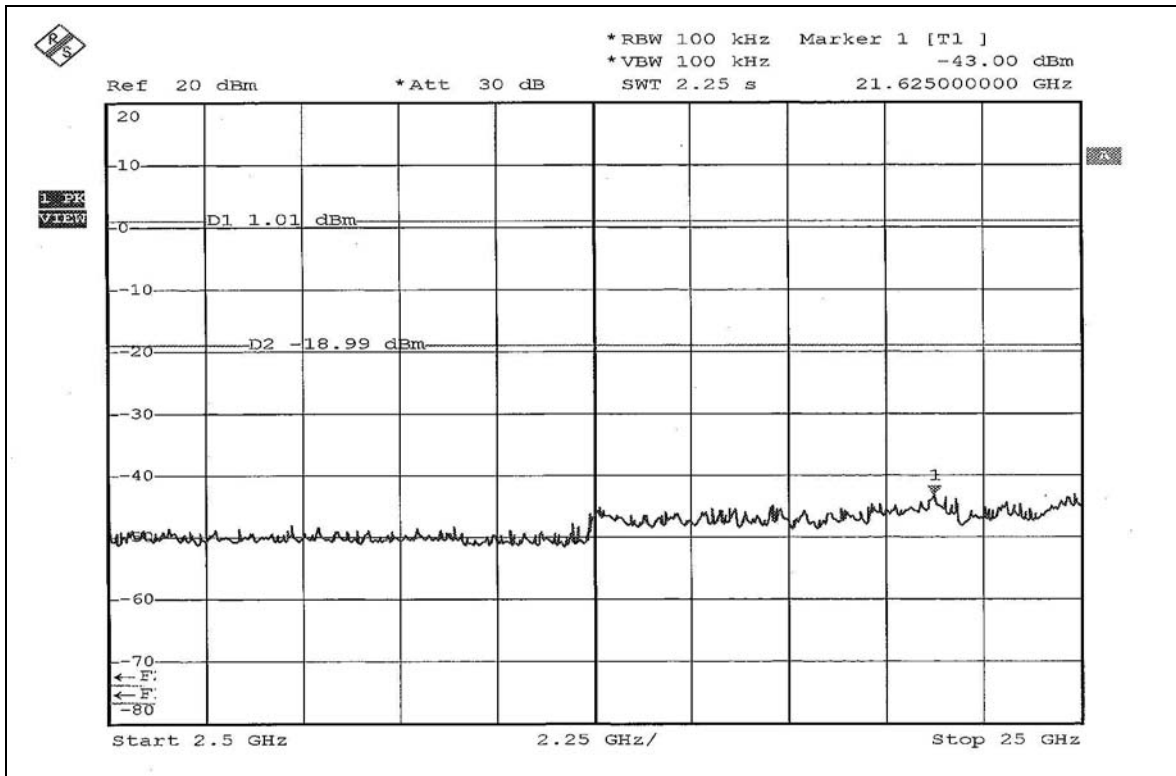

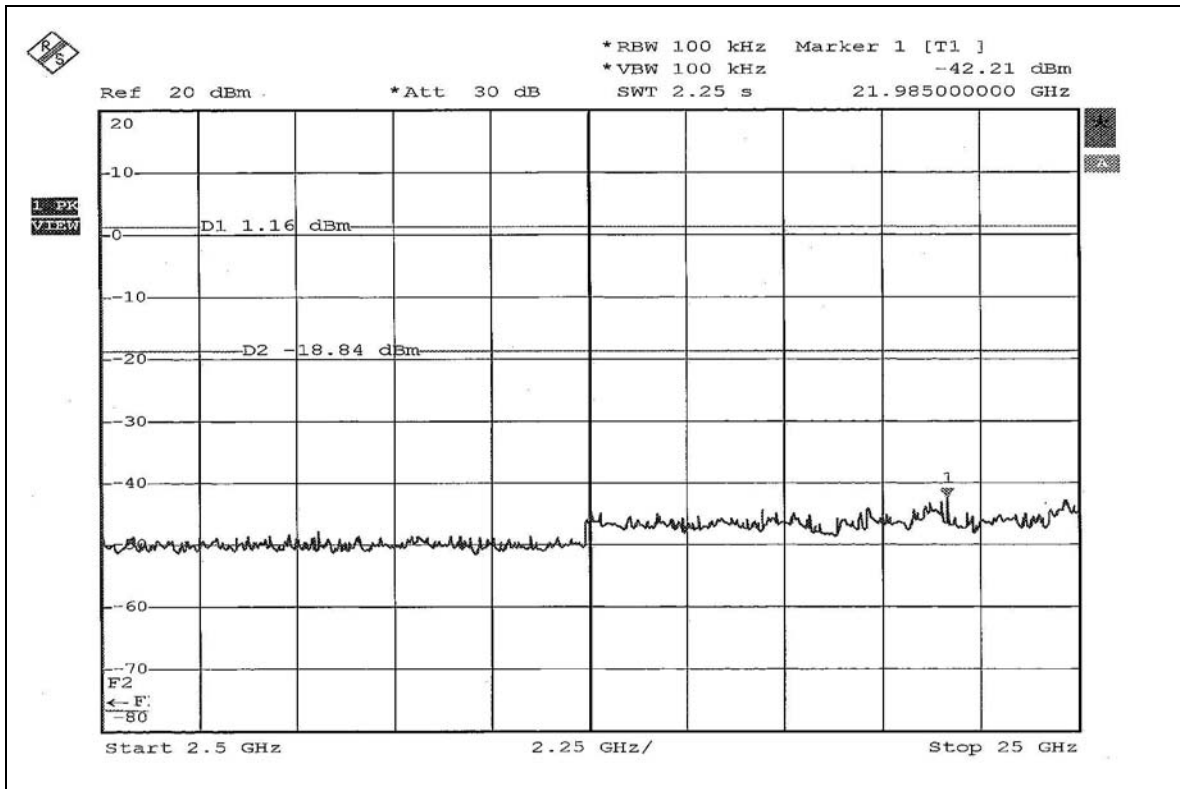
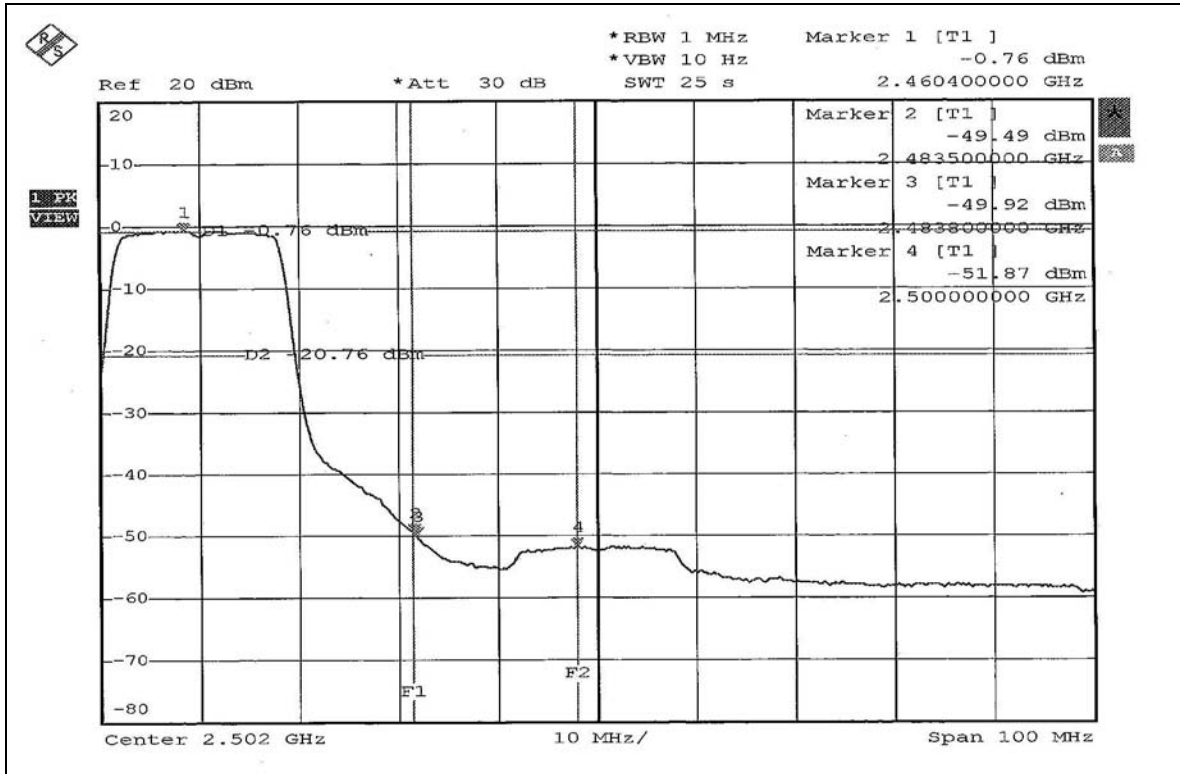



802.11g Turbo OFDM modulation

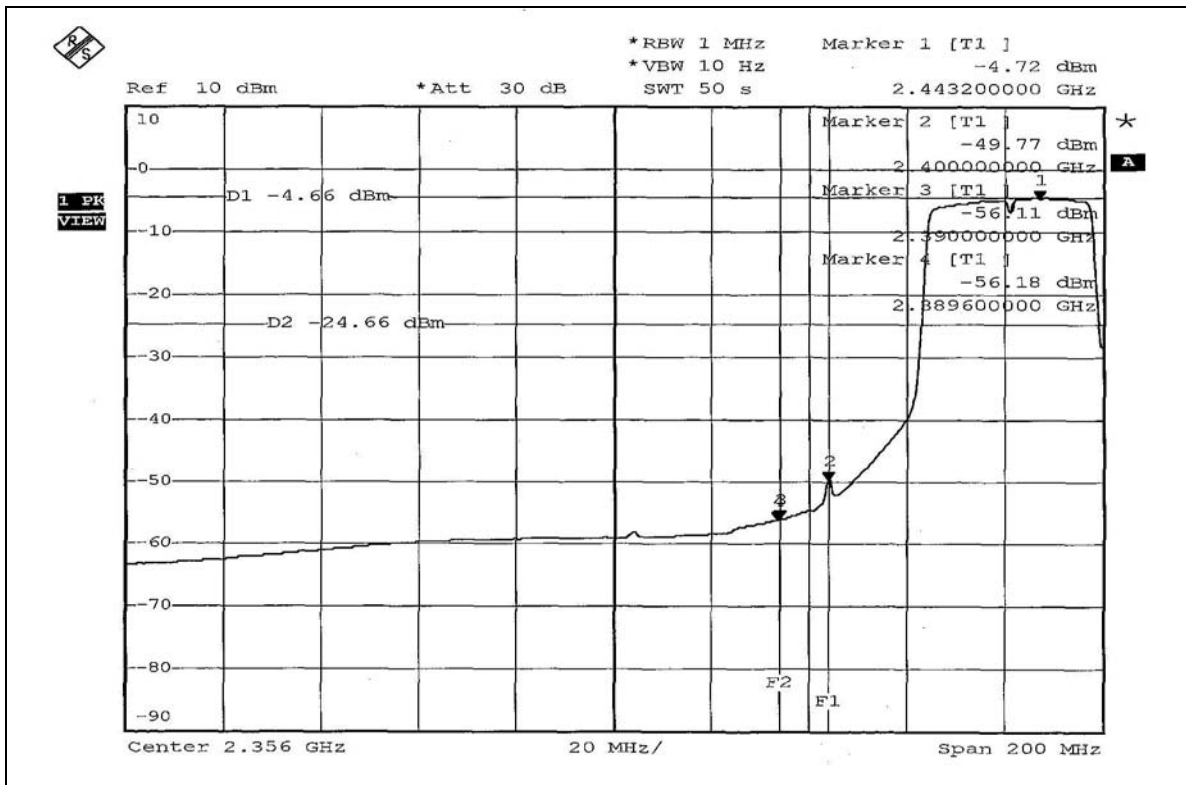
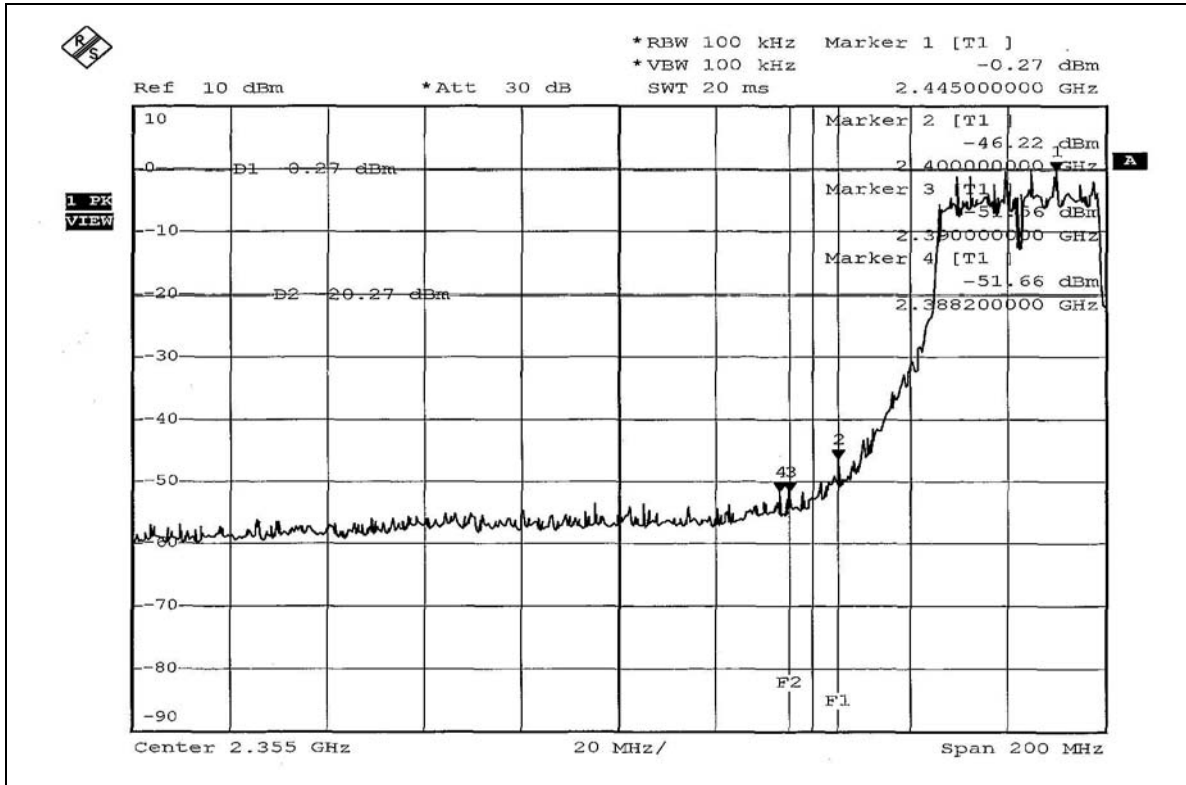

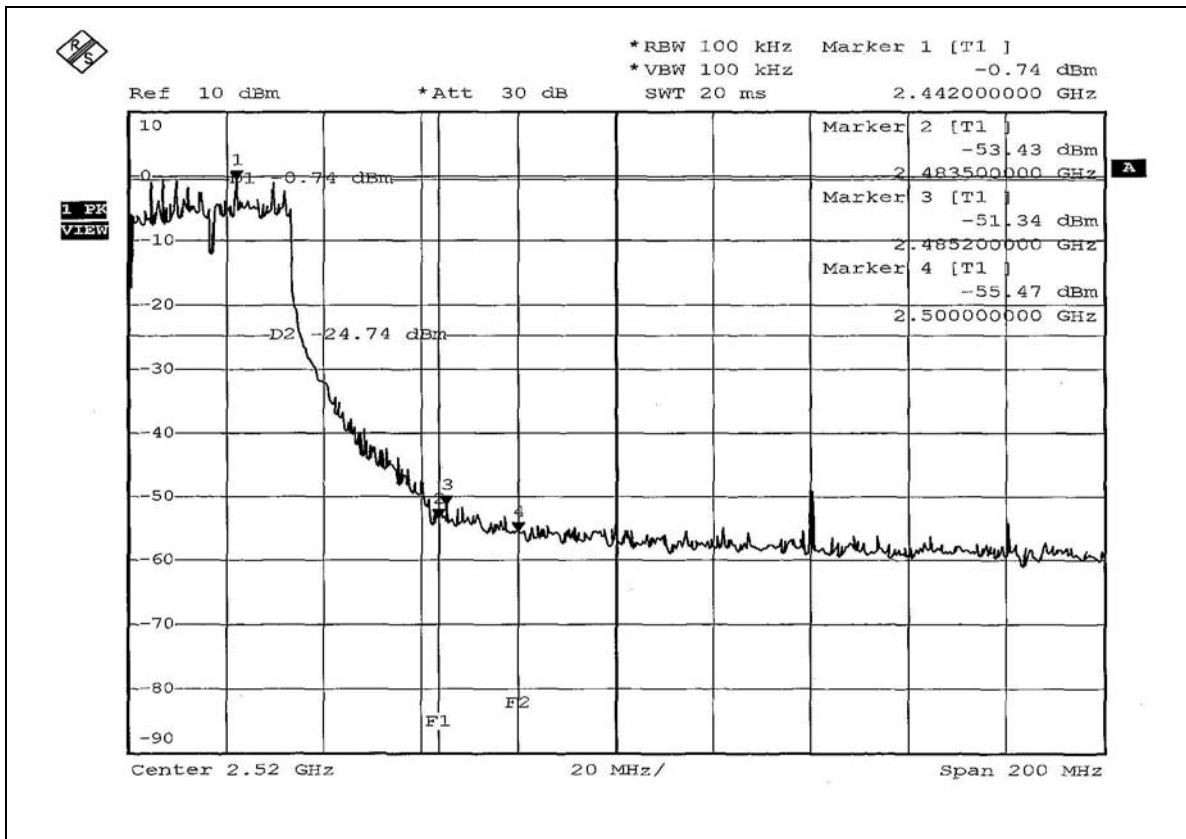
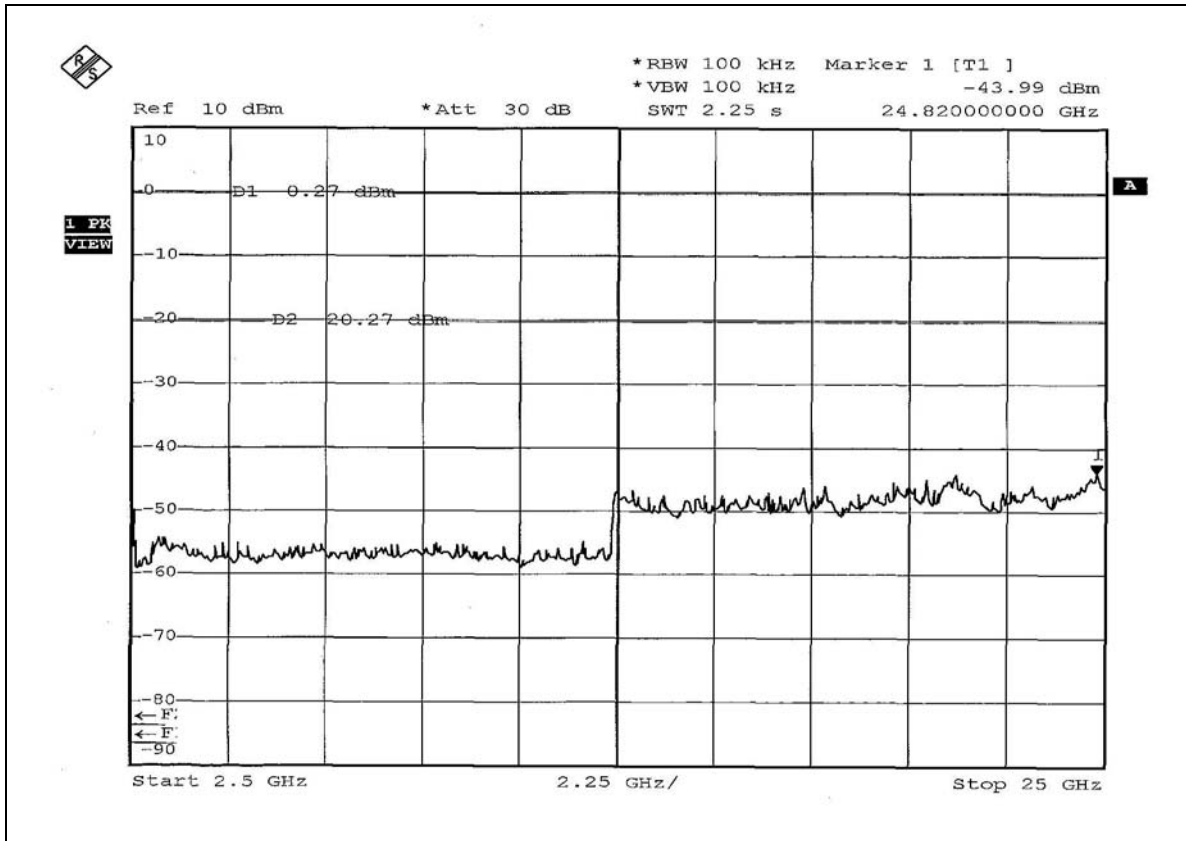

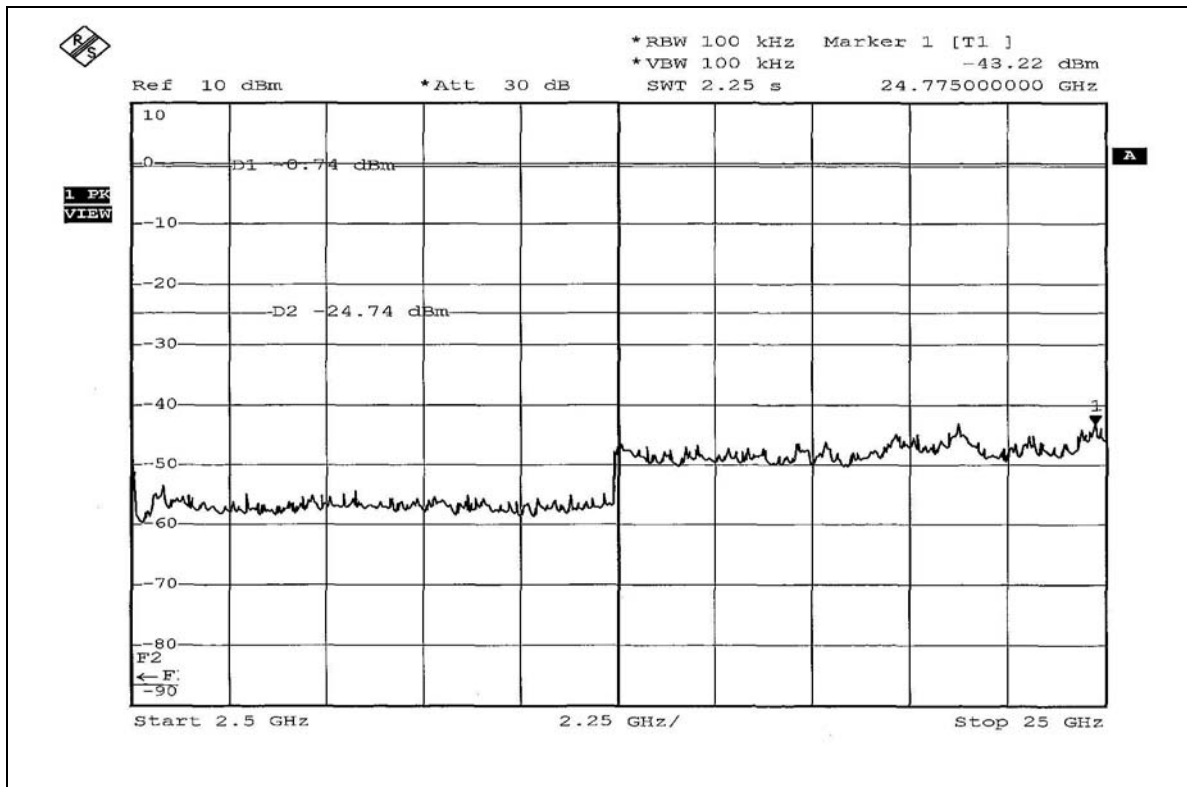
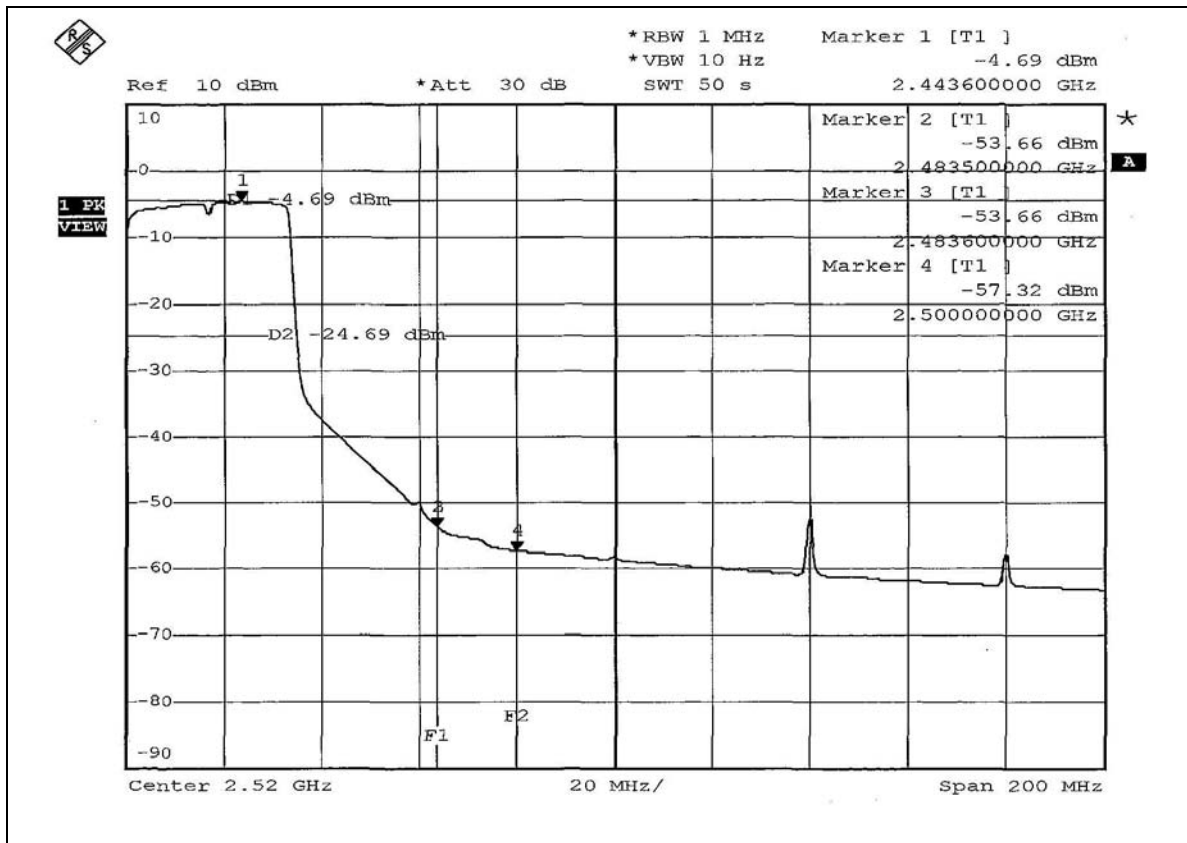



4.7 ANTENNA REQUIREMENT

4.7.1 STANDARD APPLICABLE

For intentional device, according to FCC 47 CFR Section 15.203, an intentional radiator shall be designed to ensure that no antenna other than that furnished by the responsible party shall be used with the device. And according to FCC 47 CFR Section 15.247 (b), if transmitting antennas of directional gain greater than 6dBi are used, the power shall be reduced by the amount in dB that the directional gain of the antenna exceeds 6dBi.

4.7.2 ANTENNA CONNECTED CONSTRUCTION

The antenna used in this product is Dipole antenna with Reverse SMA connector. The maximum Gain of the antenna is 2dBi.