

REV.	DESCRIPTION	DRAWN	ECN	DATE
A	NEW RELEASE		04-108	2004/03/23
B	SEE ECN		04-129	2004/04/23
C	SEE ECN		04-284	2004/08/06
D	SEE ECN	Jimmy	05-044	2005/02/15

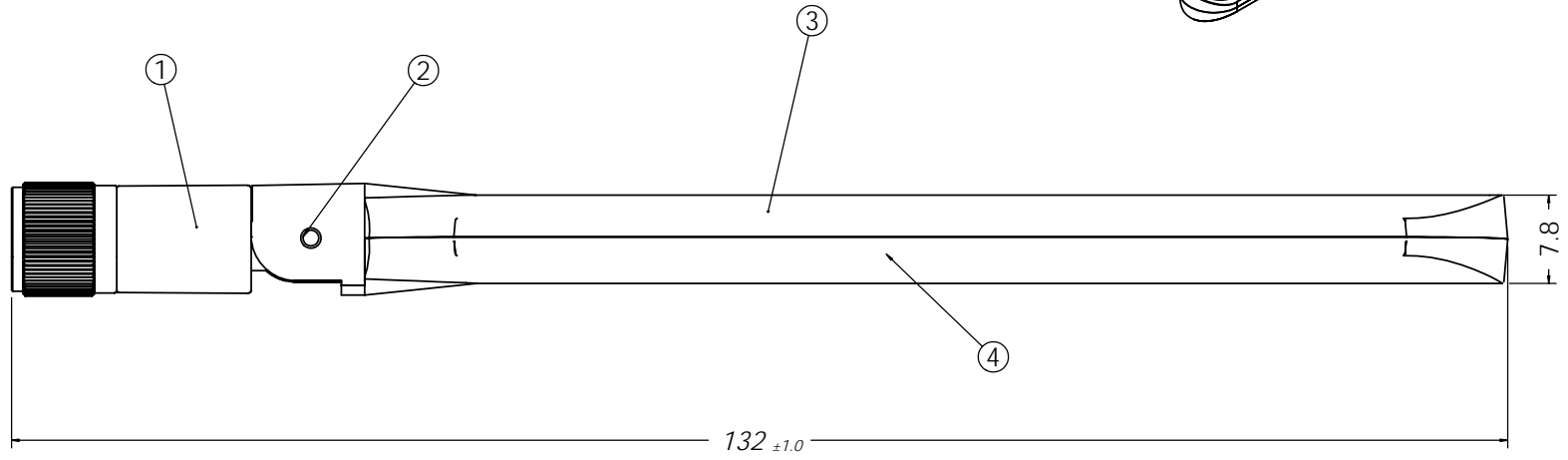
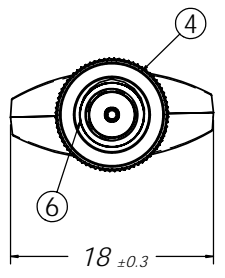
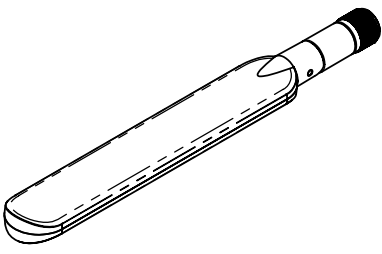

ITEM	DESCRIPTION	MATERIALS	FINISHED
6	RP-SMA Plug	Brass	Gold 4u"
5	SHELL	BRASS	Black Cr.
4	上蓋	PC/ABS	Black
3	下蓋	PC/ABS	Black
2	PIN x 2	BRASS	Black Cr.
1	PEDESTAL	ABS	Black

附註:
 超音波熔接
 美工線間距0-0.3mm

ELECTRICAL PERFORMANCE :
 1.Impedance : 50 ohms
 2.Frequency Range :2.4--5.825GHz
 3.V.S.W.R : 2.0 max
 4.Gain:5dBi

UNLESS OTHERWISE SPECIFIED ALL TOLERANCES ARE:			
DIMENSION		ANGLE	
INTEGRAL DIMENSIONS	±1	ANGULAR DIMENSIONS	±5°
1 PLACE DECIMAL	±0.5	HOLES UNDER Ø0.5	±0.1
2 PLACE DECIMALS	±0.25	ROUGHNESS	
	FINISH:		METERIAL:



DRAWN BY:	Jimmy	DATE:	2005/02/15	UNIT:	MM	SIZE:	A4	REV.	D
ENGR BY:	ZEKE	DATE:	2004/02/28	SCALE:	1.5:1	SHEET	1 OF 1		
APVD BY:		DATE:							

DWG TITLE: 2.4-5.825GHz Tri-Band RP-SMA Plug Antenna

DWG NO: W620-132-D200



CCS WUGU Antenna Pattern

Job No.: 雙頻-B-2400-E

Date: 2006/5/11

Time: 下午 03:53

Temp.()/Hum.(%): 25 /80%

Tested by:

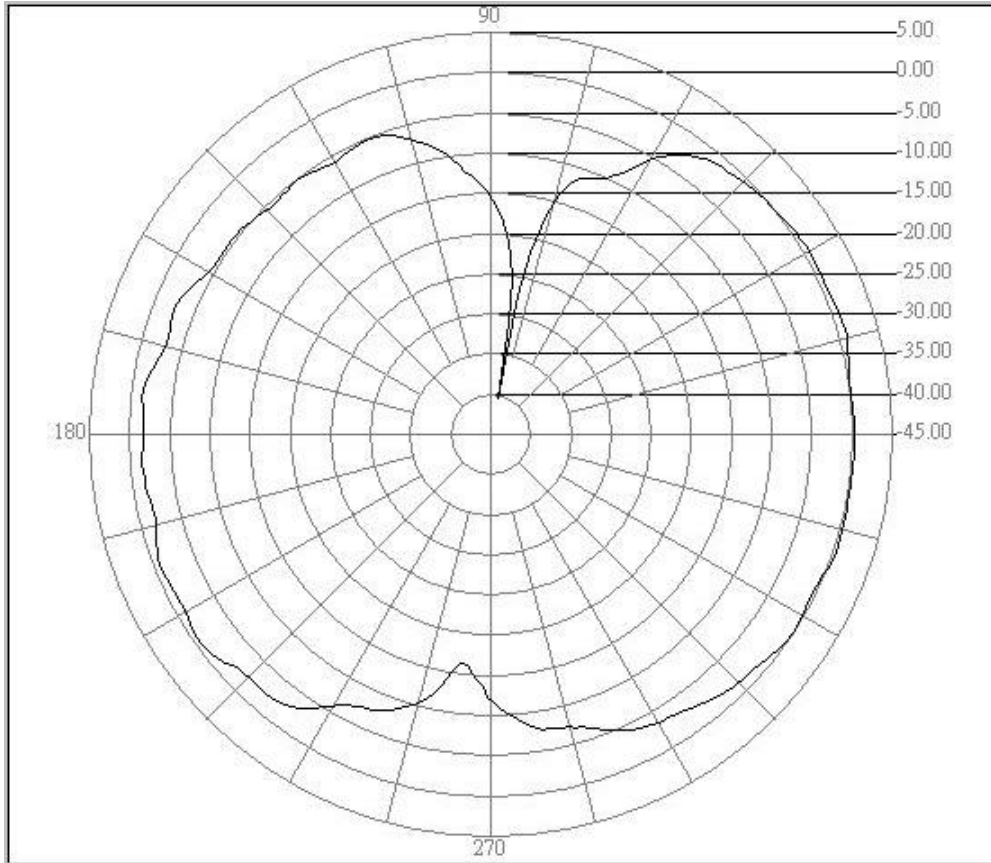

Center freq.(MHz): 2400

Polarization : E Plane

Max gain(dBi): 1.05

Min gain(dBi): -40.41

Avg gain(dBi): -2.60



CCS WUGU Antenna Pattern

Job No.: 雙頻-B-2400-H

Date: 2006/5/11

Time: 下午 04:09

Temp.()/Hum.(%): 25 /80%

Tested by:

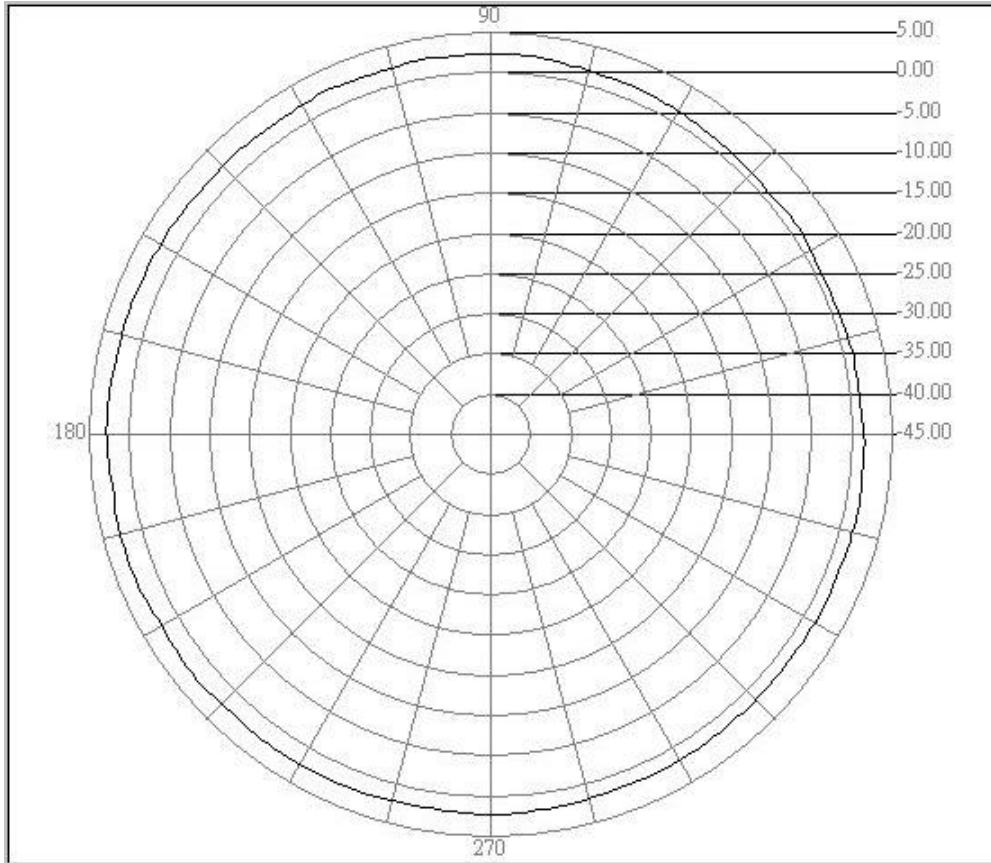

Center freq.(MHz): 2400

Polarization : H Plane

Max gain(dBi): 2.89

Min gain(dBi): 0.76

Avg gain(dBi): 2.03



CCS WUGU Antenna Pattern

Job No.: 雙頻-B-2450-H

Date: 2006/5/11

Time: 下午 04:08

Temp.()/Hum.(%): 25 /80%

Tested by:

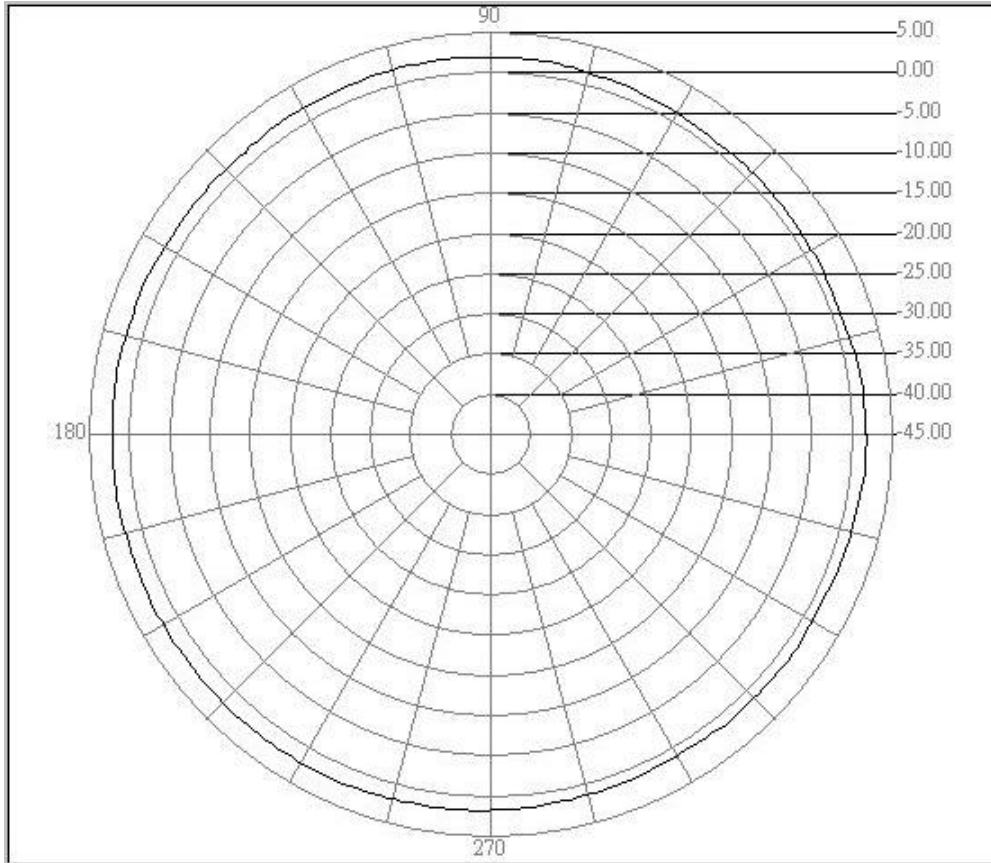

Center freq.(MHz): 2450

Polarization : H Plane

Max gain(dBi): 2.27

Min gain(dBi): 0.94

Avg gain(dBi): 1.72



CCS WUGU Antenna Pattern

Job No.: 雙頻-B-2450-E

Date: 2006/5/11

Time: 下午 03:51

Temp.()/Hum.(%): 25 /80%

Tested by:

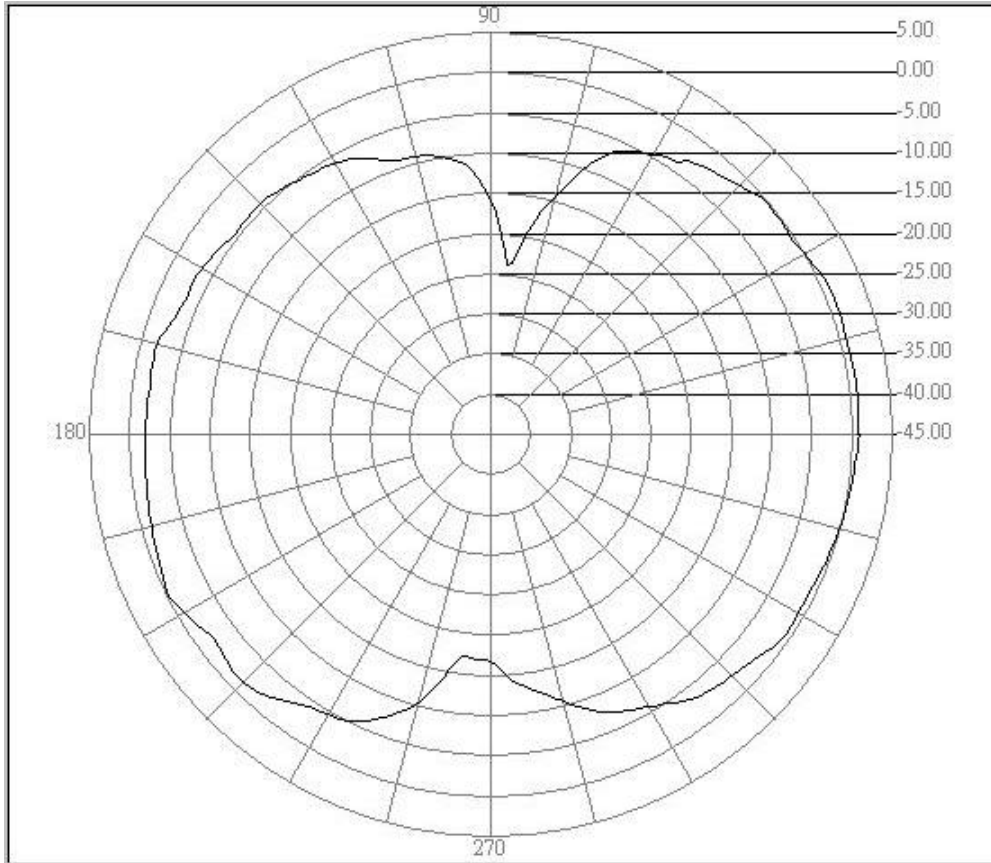

Center freq.(MHz): 2450

Polarization : E Plane

Max gain(dBi): 1.05

Min gain(dBi): -23.80

Avg gain(dBi): -2.80



CCS WUGU Antenna Pattern

Job No.: 雙頻-B-2500-H

Date: 2006/5/11

Time: 下午 04:11

Temp.()/Hum.(%): 25 /80%

Tested by:

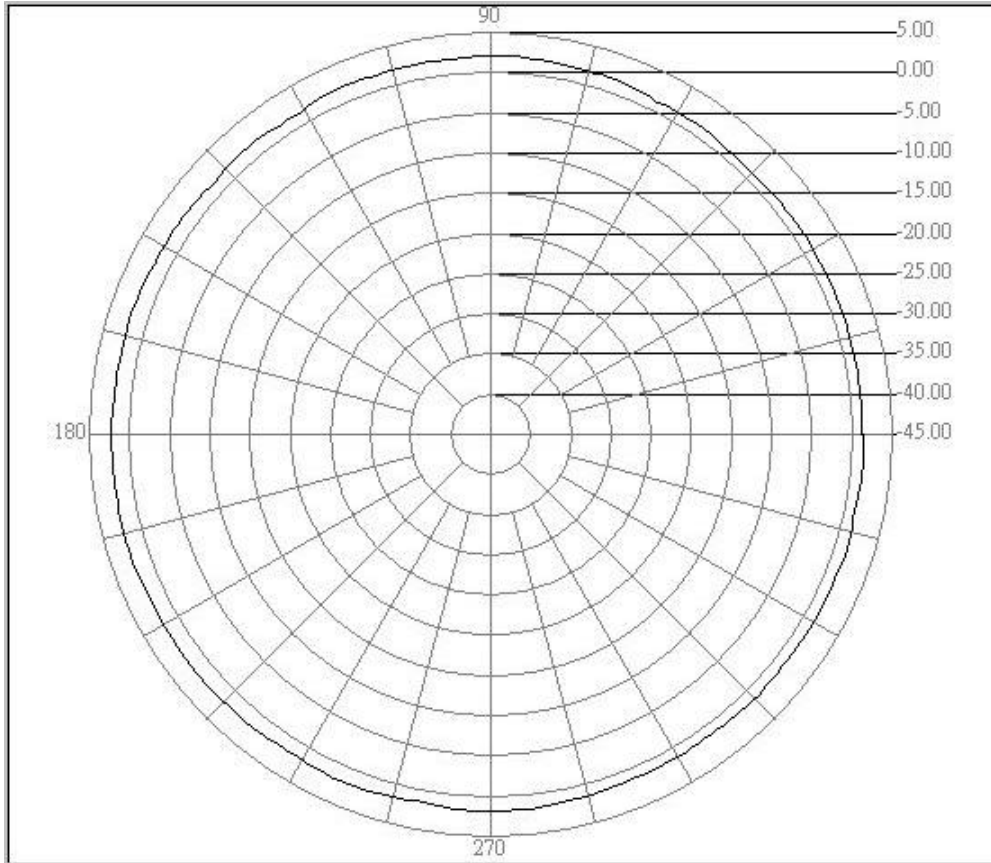

Center freq.(MHz): 2500

Polarization : H Plane

Max gain(dBi): 2.32

Min gain(dBi): 0.91

Avg gain(dBi): 1.73



CCS WUGU Antenna Pattern

Job No.: 雙頻-B-2500-E

Date: 2006/5/11

Time: 下午 03:54

Temp.()/Hum.(%): 25 /80%

Tested by:

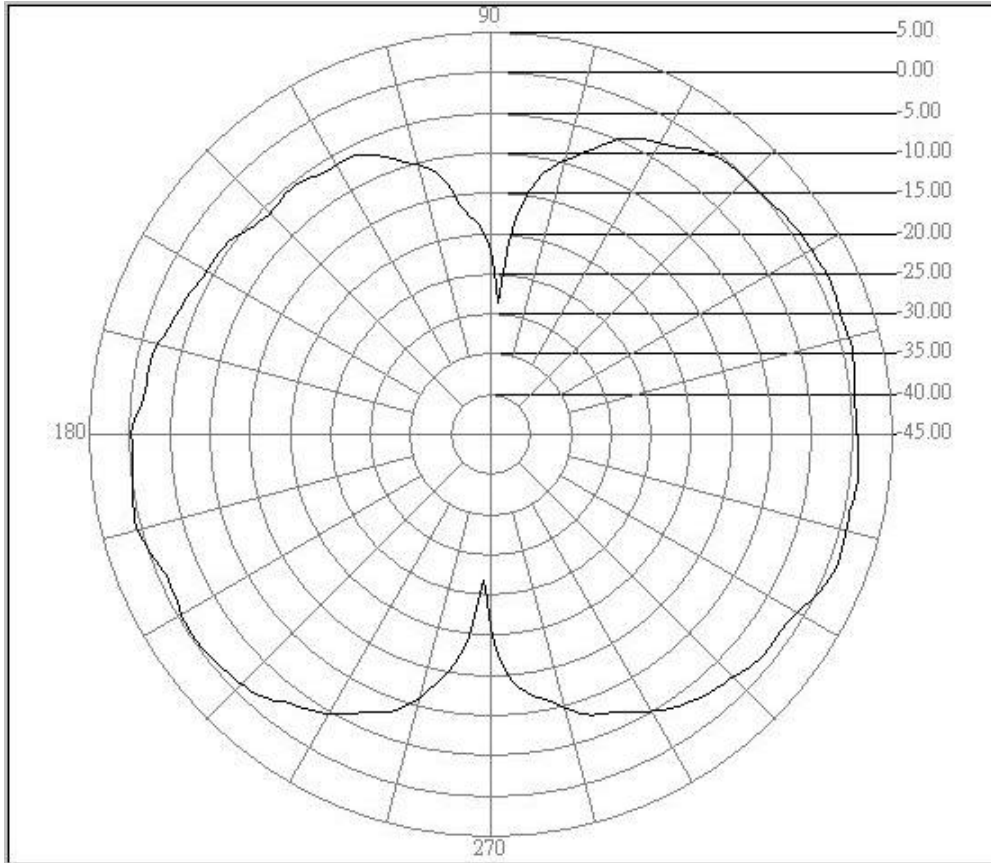

Center freq.(MHz): 2500

Polarization : E Plane

Max gain(dBi): 1.35

Min gain(dBi): -28.67

Avg gain(dBi): -2.29



CCS WUGU Antenna Pattern

Job No.: 雙頻-B-5150-H

Date: 2006/5/11

Time: 下午 04:13

Temp.()/Hum.(%): 25 /80%

Tested by:

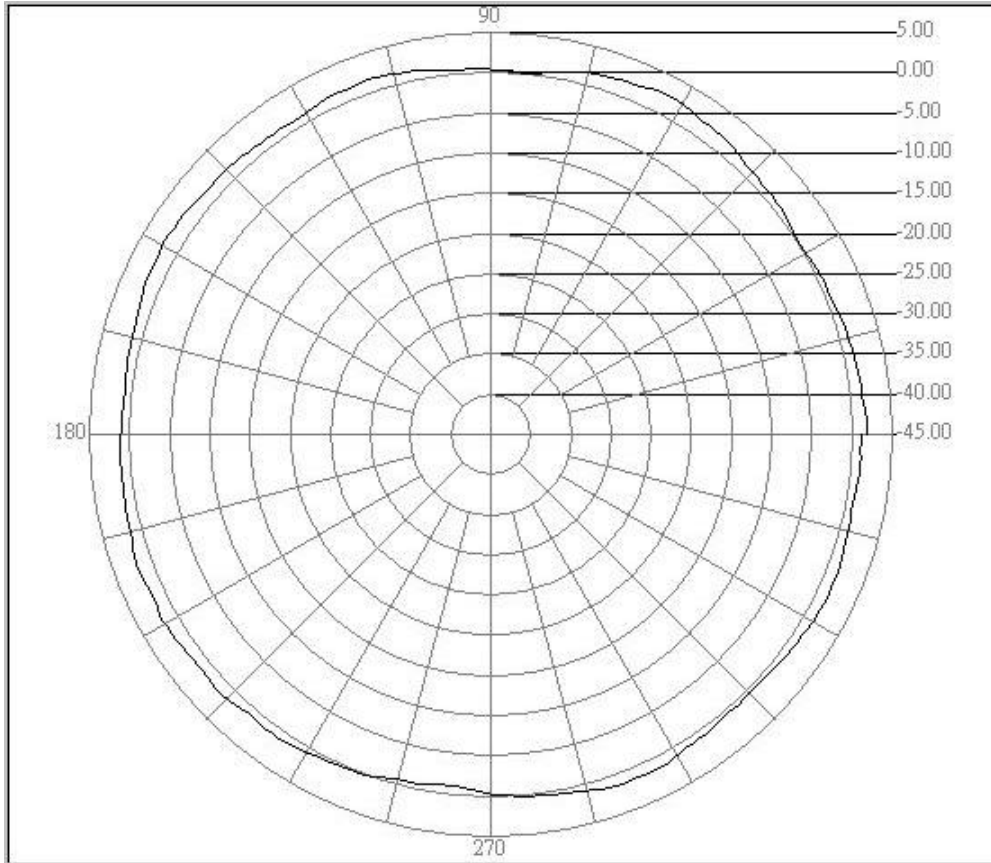

Center freq.(MHz): 5150

Polarization : H Plane

Max gain(dBi): 2.64

Min gain(dBi): -1.04

Avg gain(dBi): 1.17



CCS WUGU Antenna Pattern

Job No.: 雙頻-B-5150-E

Date: 2006/5/11

Time: 下午 03:56

Temp.()/Hum.(%): 25 /80%

Tested by:

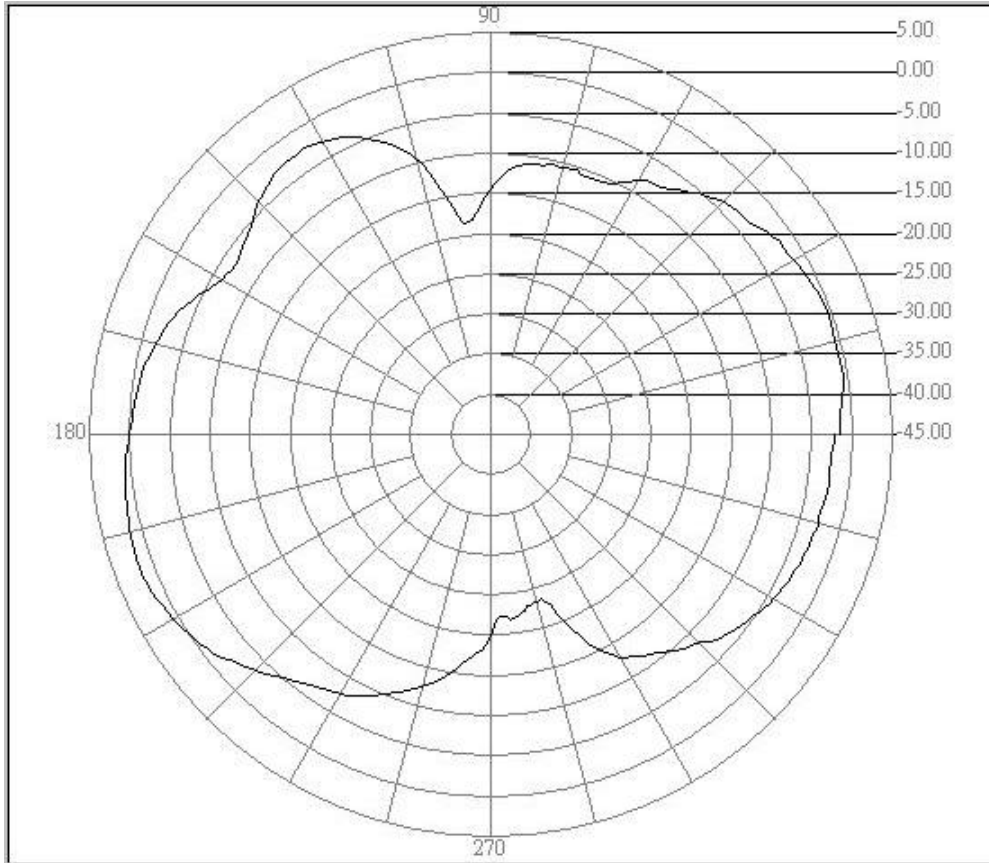

Center freq.(MHz): 5150

Polarization : E Plane

Max gain(dBi): 1.76

Min gain(dBi): -23.62

Avg gain(dBi): -3.68



CCS WUGU Antenna Pattern

Job No.: 雙頻-B-5250-H

Date: 2006/5/11

Time: 下午 04:15

Temp.()/Hum.(%): 25 /80%

Tested by:

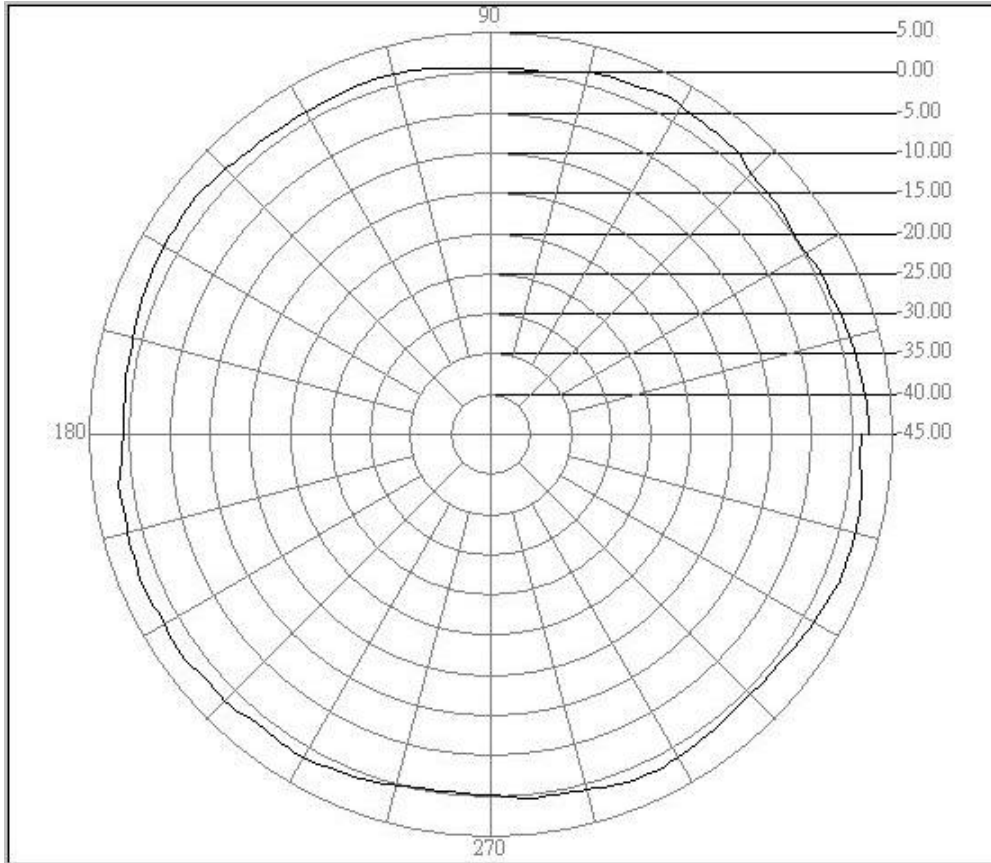

Center freq.(MHz): 5250

Polarization : H Plane

Max gain(dBi): 2.39

Min gain(dBi): -0.24

Avg gain(dBi): 1.34



CCS WUGU Antenna Pattern

Job No.: 雙頻-B-5250-E

Date: 2006/5/11

Time: 下午 03:59

Temp.()/Hum.(%): 25 /80%

Tested by:

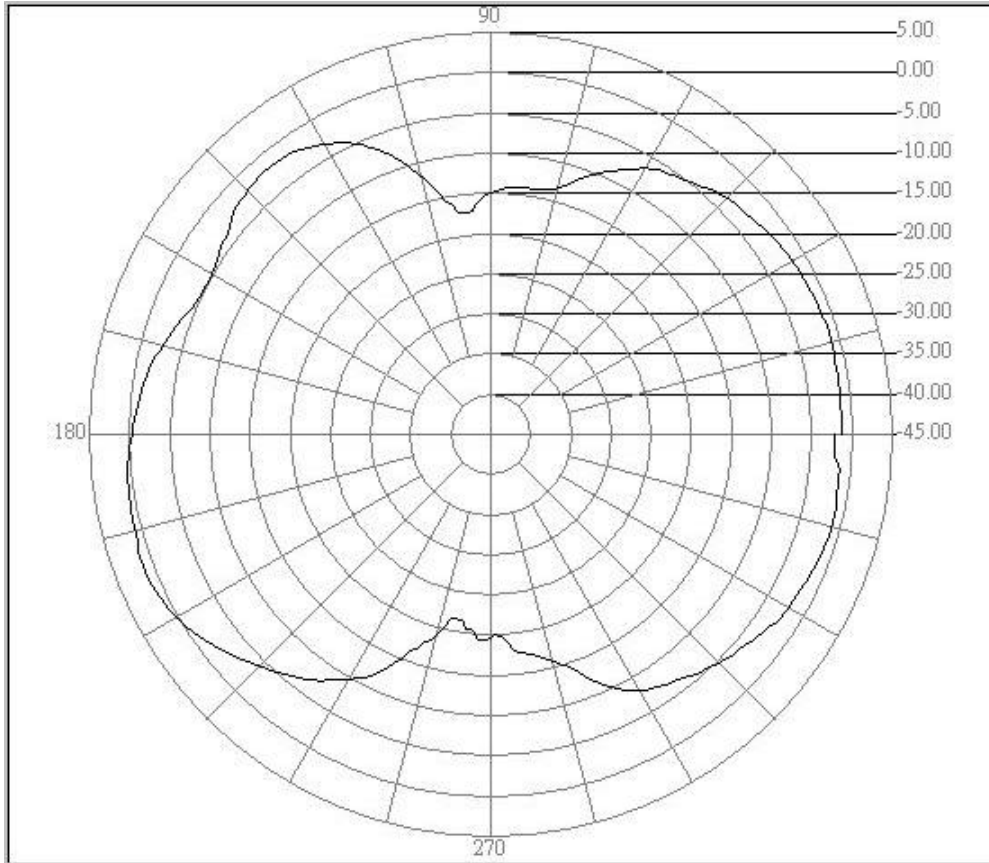

Center freq.(MHz): 5250

Polarization : E Plane

Max gain(dBi): 1.26

Min gain(dBi): -21.63

Avg gain(dBi): -3.55



CCS WUGU Antenna Pattern

Job No.: 雙頻-B-5350-H

Date: 2006/5/11

Time: 下午 04:18

Temp.()/Hum.(%): 25 /80%

Tested by:

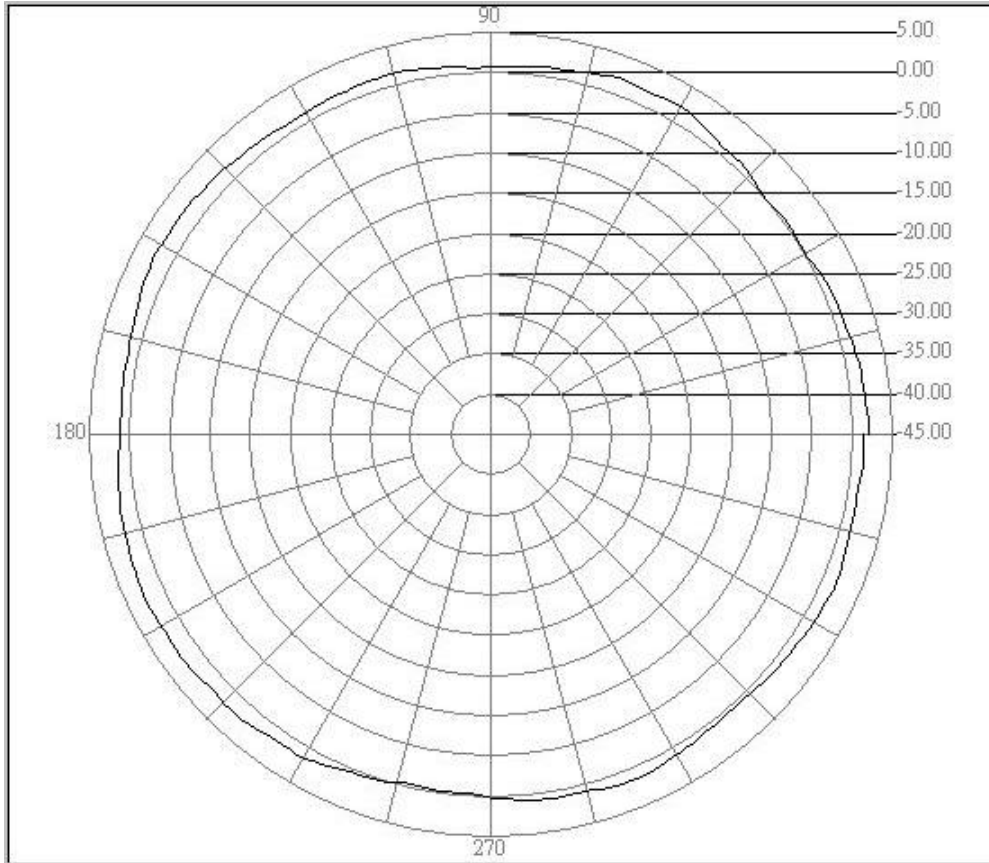

Center freq.(MHz): 5350

Polarization : H Plane

Max gain(dBi): 2.63

Min gain(dBi): -0.35

Avg gain(dBi): 1.39



CCS WUGU Antenna Pattern

Job No.: 雙頻-B-5350-E

Date: 2006/5/11

Time: 下午 04:01

Temp.()/Hum.(%): 25 /80%

Tested by:

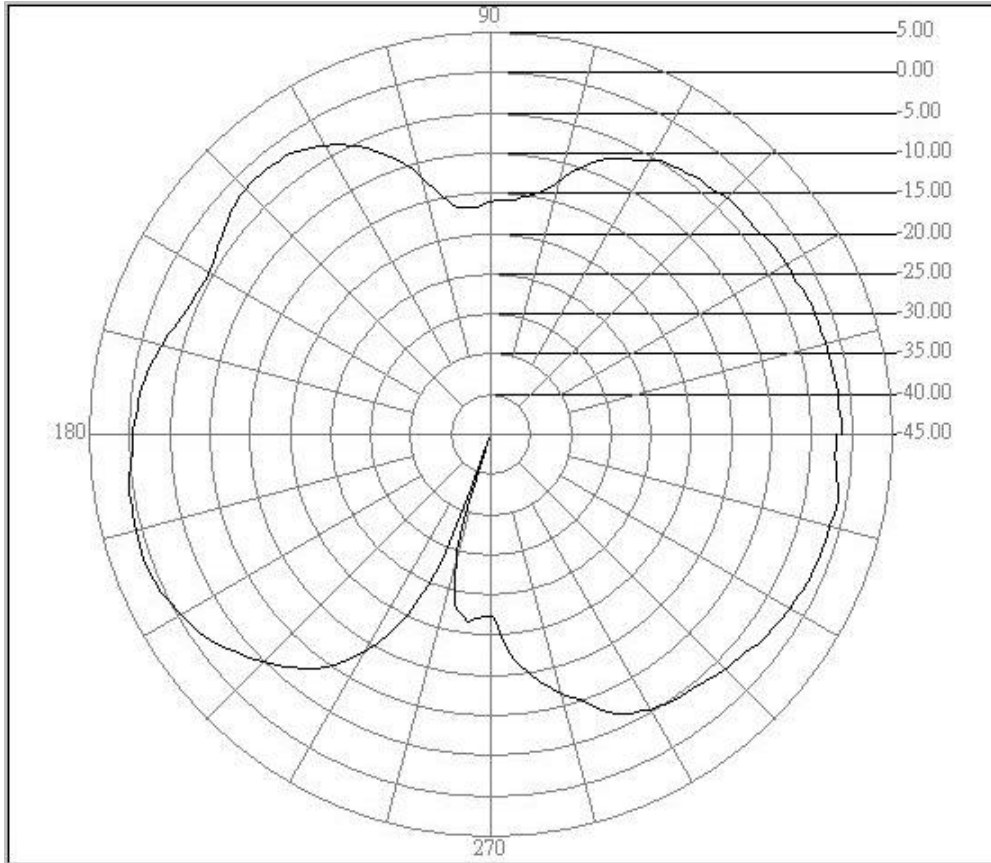

Center freq.(MHz): 5350

Polarization : E Plane

Max gain(dBi): 0.90

Min gain(dBi): -44.46

Avg gain(dBi): -3.61



CCS WUGU Antenna Pattern

Job No.: 雙頻-B-5725-H

Date: 2006/5/11

Time: 下午 04:20

Temp.()/Hum.(%): 25 /80%

Tested by:

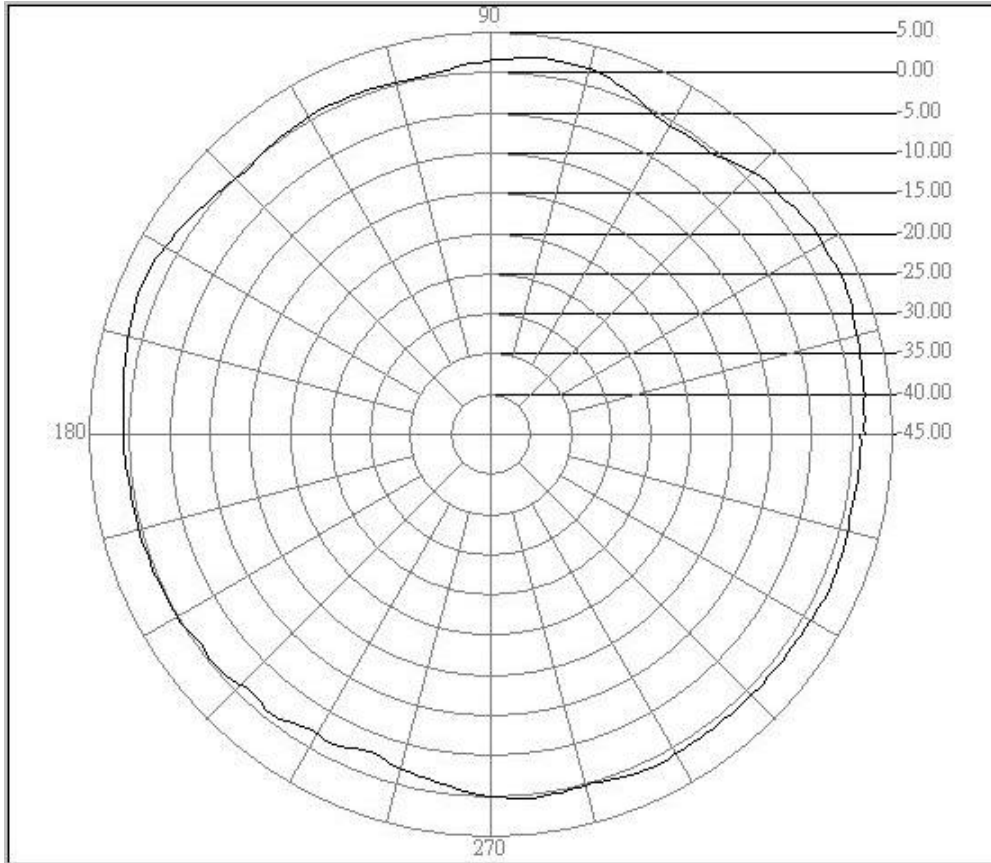

Center freq.(MHz): 5725

Polarization : H Plane

Max gain(dBi): 2.96

Min gain(dBi): -2.73

Avg gain(dBi): 0.81



CCS WUGU Antenna Pattern

Job No.: 雙頻-B-5725-E

Date: 2006/5/11

Time: 下午 04:03

Temp.()/Hum.(%): 25 /80%

Tested by:

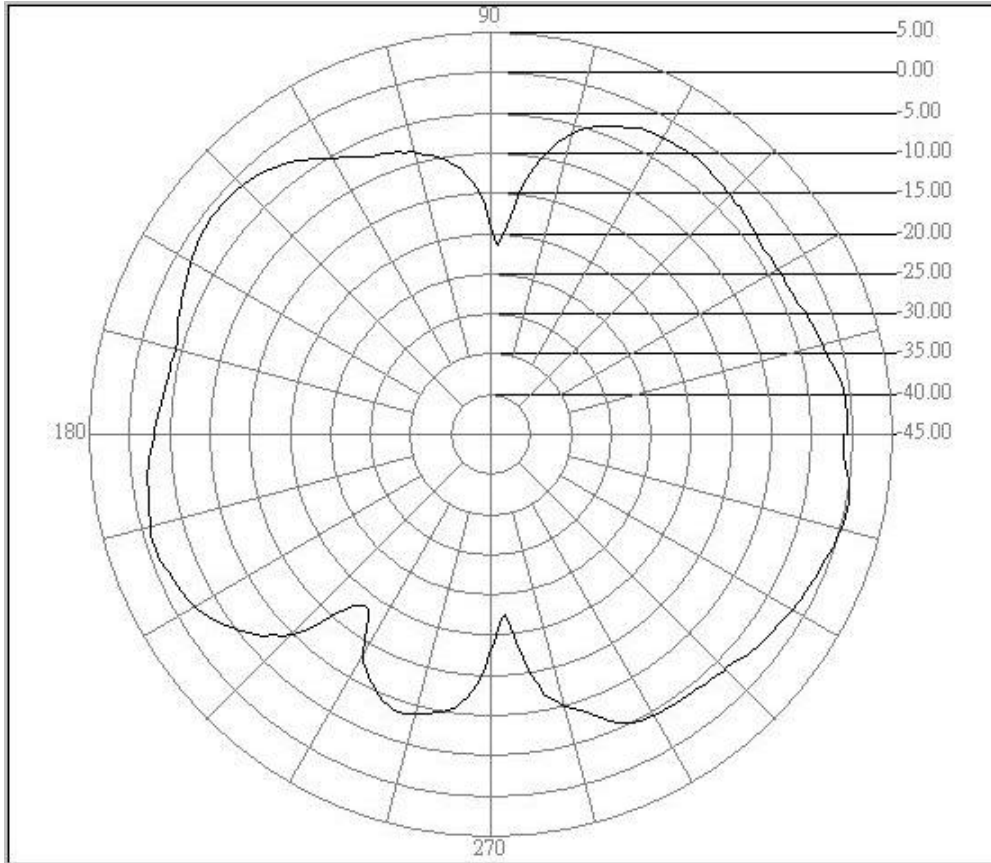

Center freq.(MHz): 5725

Polarization : E Plane

Max gain(dBi): 0.43

Min gain(dBi): -22.59

Avg gain(dBi): -3.69



CCS WUGU Antenna Pattern

Job No.: 雙頻-B-5850-H

Date: 2006/5/11

Time: 下午 04:22

Temp.()/Hum.(%): 25 /80%

Tested by:

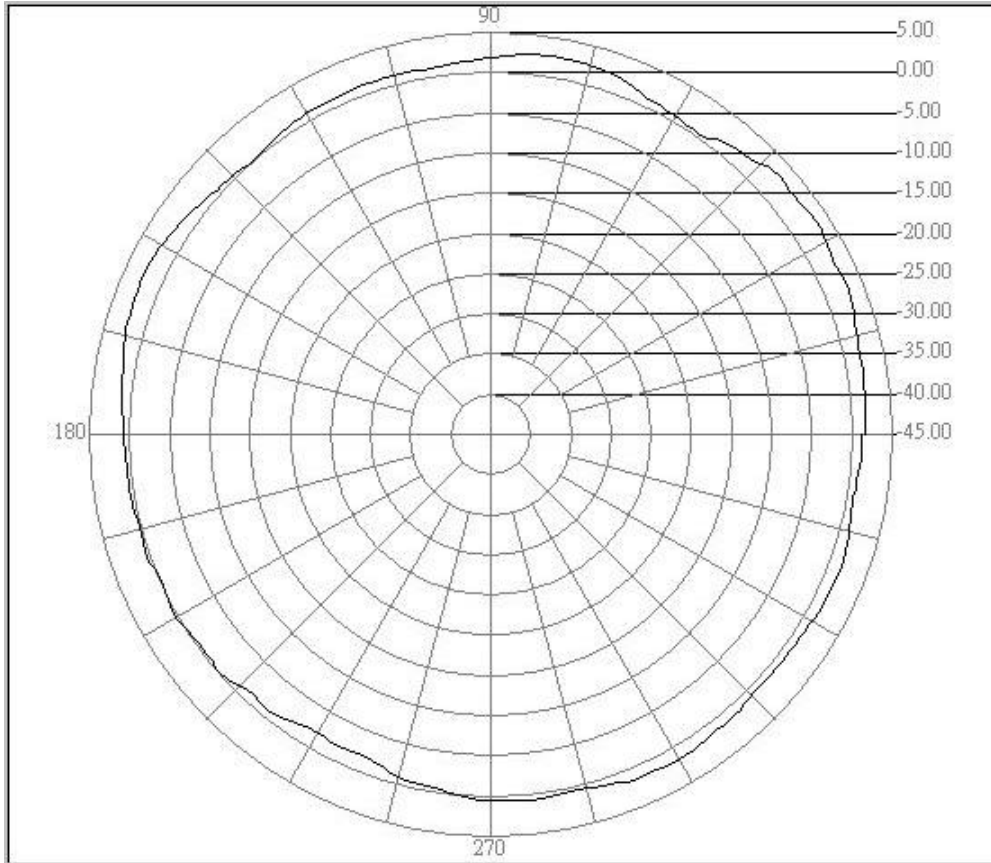

Center freq.(MHz): 5850

Polarization : H Plane

Max gain(dBi): 3.47

Min gain(dBi): -2.08

Avg gain(dBi): 1.23



CCS WUGU Antenna Pattern

Job No.: 雙頻-B-5850-E

Date: 2006/5/11

Time: 下午 04:05

Temp.()/Hum.(%): 25 /80%

Tested by:

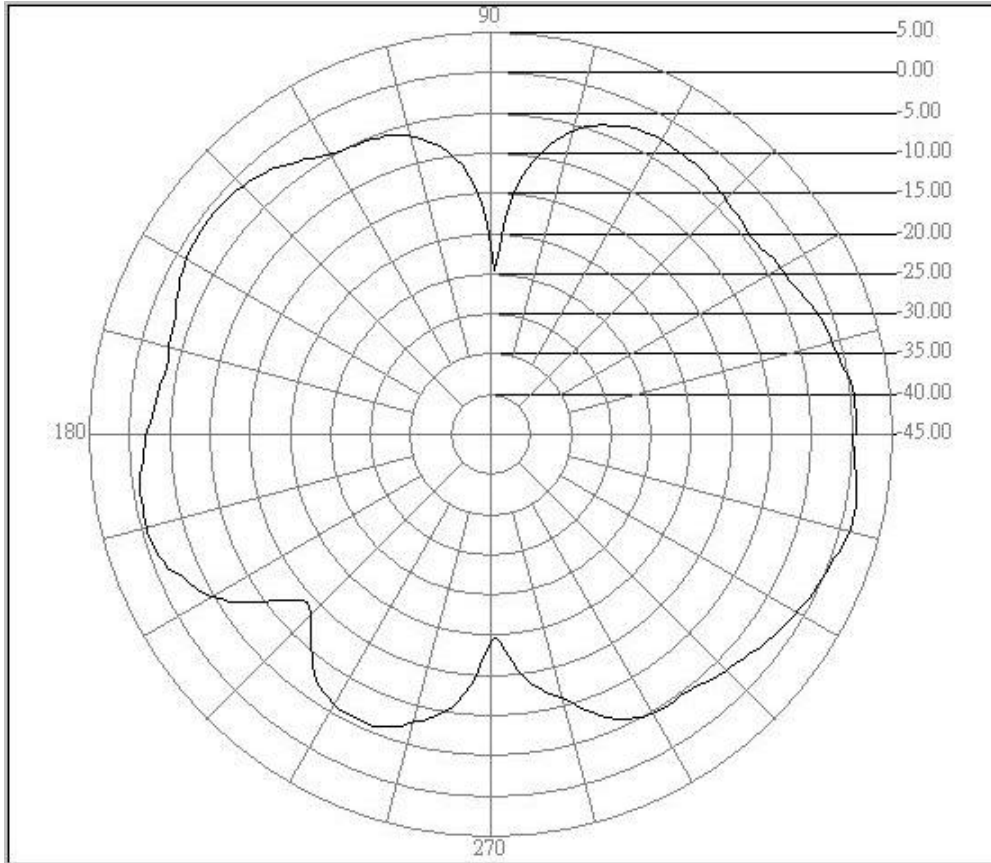

Center freq.(MHz): 5850

Polarization : E Plane

Max gain(dBi): 1.38

Min gain(dBi): -24.50

Avg gain(dBi): -3.24