

# AD-309N

## Antenna Approval Sheet

<b>Part Number</b>	R3410110227
<b>Product Number</b>	AD-309N
<b>Description</b>	Dipole Antenna, 1.68dBi/4.72dBi 2.4G/5GHz, I-PEX / MHF4 connector
<b>DOC NO</b>	AS-2104002

Ver. 1.0

### Revised History

Version	Purpose	Date	Responsible
1.0	Initial Doc	2022/04/21	Aaron

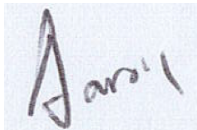
<b>SparkLAN</b>		<b>Customer</b>
<b>Sales</b>	<b>PM</b>	<b>Approval by</b>
-		-

# Contents

1. Electrical Specifications .....	3
2. V.S.W.R .....	3
3. Antenna Drawing .....	4
4. Antenna Pattern.....	5

# Dual Band Dipole Antenna

## AD-309N

### Electrical Specifications

Frequency range	2400 - 2500 MHz	5150 - 5875 MHz
Peak Gain	1.68 dBi	4.72 dBi
Efficiency	56.47 %	55.22 %
VSWR	2.0 : 1 Max.	2.0 : 1 Max.
Power handling	1W (cw)	
Impedance	50 Ω	
Dimensions	36.1x8.1mm	
Antenna Material	FR4	
Connector	I-PEX MHF4	
Cable	Ø1.13 L:400mm	

\*Antenna measured on a 2mm thick ABS plastic base

### Environmental & Mechanical Characteristics

Temperature	- 10°C to +55°C
Humidity	95% @ 25°C



### VSWR

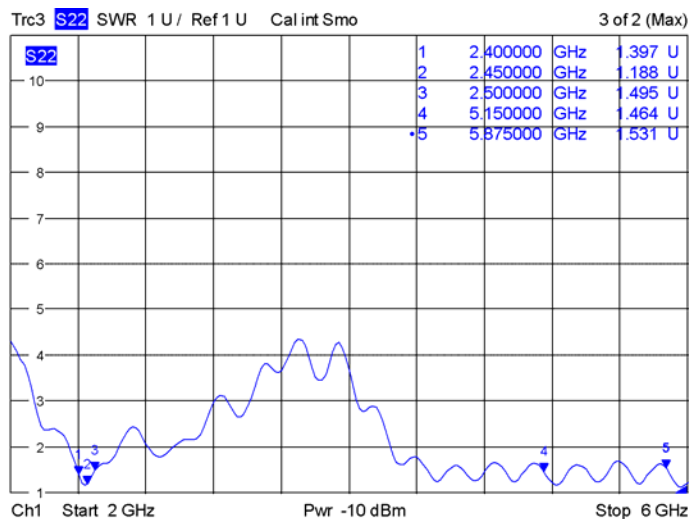

Date: 2.FEB.2021 07:58:08

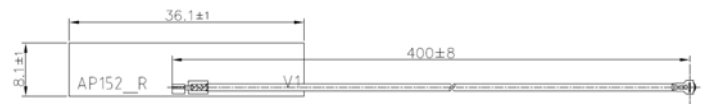

Manufacture: ARISTOTLE ENTERPRISES INC.

Manufacturer address: 8F, No.63, Juguang Rd, Zhonghe Dist, New Taipei City 235, Taiwan, R.O.C.

NO.	NAME	FINSH	MAT'L	Q'TY	MEMO
1.	PCB	BLACK	FR4	1	
2.	CABLE	BLACK	--	1	∅1.13
3.	IPEX	PLATED GOLD	BRASS	1	MHF4
4.	TAPE	--	--	1	

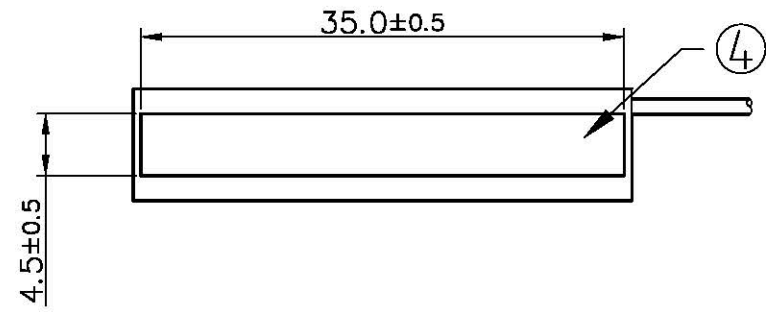
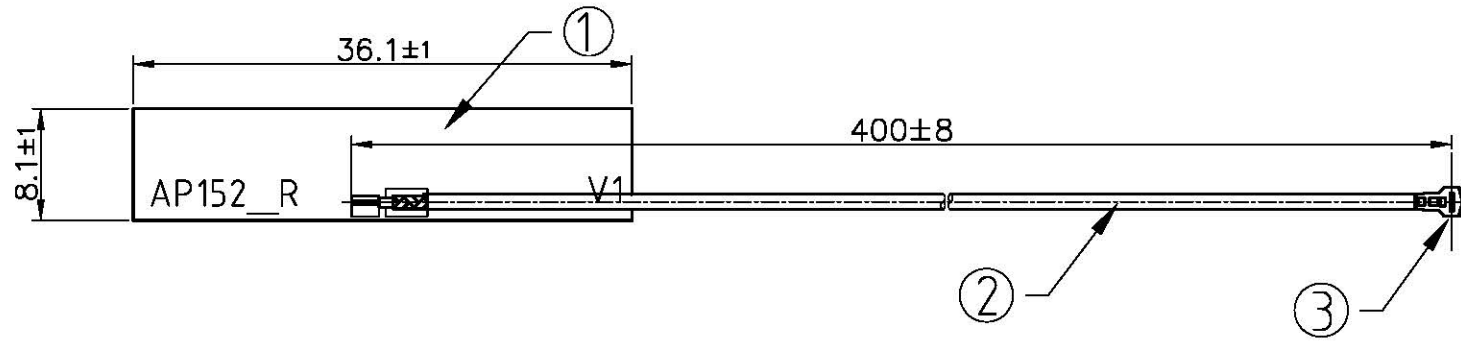

	TOLERANCE UNLESS OTHERWISE SPECIFIED	
	LINER	ANGLE
UNITS	.X ±0.10	X' ±0.5°
MM	.XX ±0.05	
	.XXX ±0.01	

TITLE  
AD-309N

DWG NO.  
R3410110227

3.				REV.	A	APPD.		
2.				SHEET	1/1	CHKD.		
1.				SIZE	SCALE	DESIGN		
REV.	ECN.	NAME	DATE	A4	1:1	DRAW	Gino	2021/02/02

# Antenna Pattern

2GHz Band = 2400 - 2500 MHz

XY Plane (+X = 0°, +Y = +90°) / Elevation = 90 °

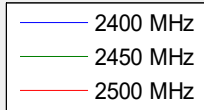
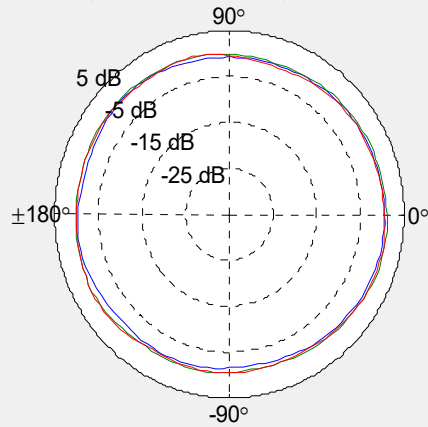

ZX Plane (+Z = 0°, +X = +90°) / Azimuth = 0 °

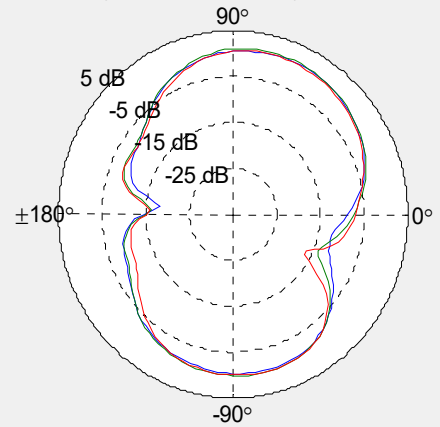

YZ Plane (+Z = 0°, +Y = +90°) / Azimuth = 90 °

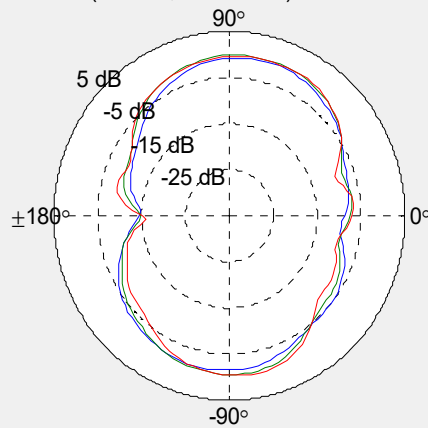

## Antenna Pattern

5GHz Band = 5150 - 6000 MHz

- 5150 MHz
- 5250 MHz
- 5350 MHz
- 5475 MHz
- 5600 MHz
- 5725 MHz
- 5750 MHz
- 5825 MHz
- 5875 MHz

XY Plane (+X = 0°, +Y = +90°) / Elevation = 90 °

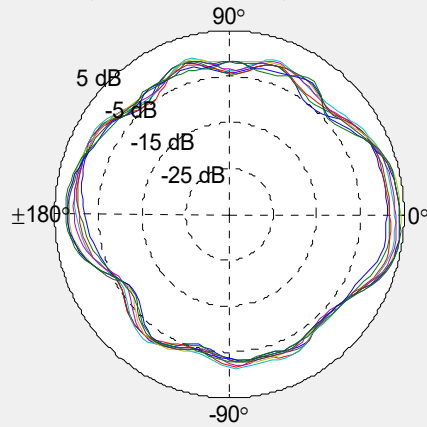

ZX Plane (+Z = 0°, +X = +90°) / Azimuth = 0 °

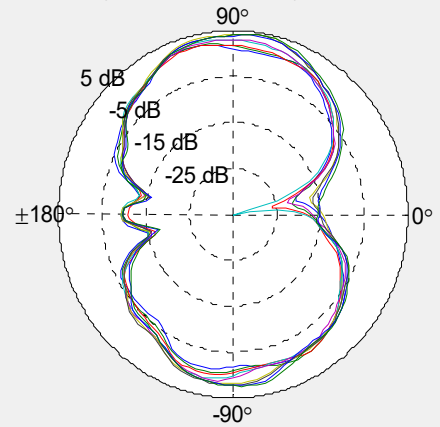

YZ Plane (+Z = 0°, +Y = +90°) / Azimuth = 90 °

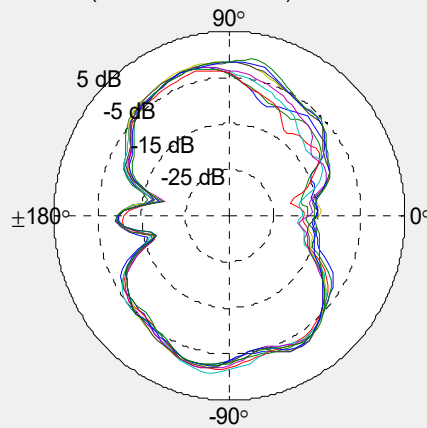

# Product Photo



# 速連通訊股份有限公司

文件編號		文件名稱		發行版本	B	頁次	1/1
公司名稱：	SparkLAN		最小包裝	PCS	50		
料號/品名：	R3410110227 / AD-309N		中包裝	PCS	200		
供應商料號/品名			大包裝	PCS	5000		
相關配件			備註				

## 1. 最小包裝(50PCS-夾鏈袋)



示意圖

## 2. 中包裝(200PCS-PE 袋)



示意圖

P/N : R3410110227

Name: AD-309N

P/O :

Q' TY: 200 PCS

Date: 2021/04/01

標籤尺寸：7X3CM

## 3. 大包裝(5000PCS-1 箱)



示意圖

## 4.





**NAN YA PLASTICS CORPORATION**  
 ELECTRONIC MATERIALS DIVISION.  
**COPPER CLAD LAMINATE DEPARTMENT**

**Glass cloth base epoxy resin  
 flame retardant copper clad laminate**

NO. 201. TUNG HWA N. ROAD,  
 TAIPEI, TAIWAN.

**NP-140TL**

**■ FEATURES**

- Multi-functional epoxy renders the material outstanding heat resistance, better dimensional stability, and through-hole reliability that benefit the performance of high layer count multilayer boards.
- HTE copper foil applied to prevent corner cracking.
- High luminance of epoxy contrast with copper for laser type A.O.I.
- UV solder mask may be applied simultaneously in order to increase yields.
- IPC-4101B specification is applicable.

**■ PERFORMANCE LIST**

Characteristics	Unit	Conditioning	Typical Values	SPEC	Test Method
Volume resistivity	MΩ-cm	C-96/35/90	5.0 x10 <sup>9</sup>	10 <sup>6</sup> ↑	2.5.17
Surface resistivity	MΩ	C-96/35/90	5.0 x10 <sup>7</sup>	10 <sup>4</sup> ↑	2.5.17
Permittivity 1 MHZ	-	C-24/23/50	4.2-4.4	5.4 ↓	2.5.5.9
Permittivity 1 GHZ	-	C-24/23/50	3.8-4.0	-	2.5.5.9
Loss Tangent 1 MHZ	-	C-24/23/50	0.015-0.020	0.035 ↓	2.5.5.9
Loss Tangent 1 GHZ	-	C-24/23/50	0.012-0.014	-	2.5.5.9
Arc resistance	SEC	D-48/50+D-0.5/23	120 ↑	60 ↑	2.5.1
Dielectric breakdown	KV	D-48/50	60 ↑	40 ↑	2.5.6
Moisture absorption	%	D-24/23	0.20-0.30	0.35 ↓	2.6.2.1
Flammability	-	C-24/23/50+E-24/125	94V0	94V0	UL94
Peel strength 1 oz	lb/in	288 x10" solder floating	10-14	6 ↑	2.4.8
Thermal stress	SEC	288 solder dipping	90 ↑	10 ↑	2.4.13.1
Glass transition temp		DSC	140 ± 5	N/A	2.4.25
Dimensional stability X-Y axis	%	E 4/105	0.01-0.03	0.05 ↓	2.4.39
Coefficient of thermal expansion					
	ppm/	TMA	50-70	N/A	2.4.24
	ppm/	TMA	250-350		

Data shown are nominal values for reference only.

**NOTE:**

The average value in the table refers to samples of .020" 1/1.

Test method per IPC-TM-650

■ UV TRANSMISSION CURVE OF 0.2mm CCL

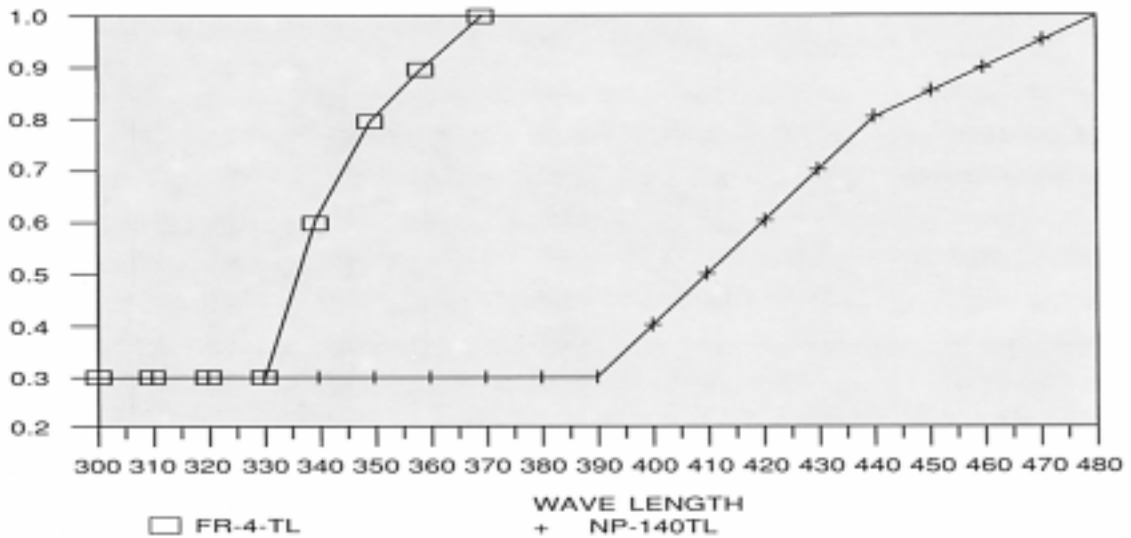

■ PRODUCT SIZE & THICKNESS

THICKNESS INCH(mm)	COPPER CLADDING OZ (µm)	SIZE		THICKNESS TOLERANCE
		INCH	mm	
0.004 (0.1)	0.5 (17)	48.8 x 36.6	1240 x 0930	CLASS C/M
to	1.0 (35)	48.8 x 40.5	1240 x 1030	
0.047(1.2)	2.0 (70)	48.8 x 42.5	1240 x 1080	

■ Keeping the core and prepreg in the same grain direction is crucial to ensure the flatness of multilayer boards.

Grain direction is shown on the Certificate of Conformance

■ CERTIFICATION UL

• UL File No. : E98983

**■ CONSTRUCTION:**

THICKNESS		CONSTRUCTION	THICKNESS		CONSTRUCTION
mm	mil		mm	mil	
0.08	3	2112 1 ply	0.45	18	7628 x 2 + 1080 x 1
0.10	4	1080 2 plies	0.46	18	7667 2 plies
0.11	4	2116 1 ply	0.50	20	7628 3 plies
0.13	5	1080 2 plies	0.53	21	7628 3 plies
0.13sp	5	2116 1 ply	0.60	24	7628 3 plies
0.15	6	1506 1 ply	0.77	31	7628 4 plies
0.16	6	2112 2 plies	0.8	32	7628 4 plies
0.21	8	7628 1 ply	0.9	36	7628 5 plies
0.26	10	2116 2 plies	1.0	39	7628 5 plies
0.30	12	2116 3 plies	1.1	43	7628 6 plies
0.30sp	12	1506 2 plies	1.2	47	7628 6 plies
0.35	14	7628 2 plies			
0.38	15	7628 2 plies			

\*1.2,1.1,1.0,0.9,0.77 mm, THICKNESS INCLUDES CLADDING. ALL OTHERS EXCLUDE CLADDING.



## Double Coated Tissue Tapes

### 9888T

*Temporary Technical Data*

*May, 2002*

#### **Product Description:**

Product 9888T double coated tissue tape features a tissue carrier for dimensional stability and improved handling with ease of die cutting and laminating.

#### **Construction:**

<b>Product Number</b>	<b>Adhesive<sup>1</sup>/ Color/ Tape Thickness</b>	<b>Carrier</b>	<b>Liner Color, Type, Print</b>	<b>Liner Caliper</b>
9888T	Translucent, 0.0059" (0.150mm)	Tissue translucent in color	White, PE <sup>2</sup> polycoated paper, 3M logo print in red color	0.0059" (0.150mm)

Note 1: Pressure Sensitive Acrylic Adhesive provides excellent initial tack and adhesion to a wide variety surface including many low surface energy plastics.

Note 2: PE (Polyethylene)

#### **Feature**

1. 9888T feature a medium-soft acrylic pressure sensitive adhesive system. The key characteristics of this adhesive include a combination of high initial adhesion and good shear and holding power to a wide variety of materials, including many plastics.
2. 9888T feature controlled adhesive flow into open cell foam and controlled caliper for bond to application surface.
3. For foam laminating, it provides excellent foam stability to reduce stretching and allows to more precise alignment during application.

## Typical Physical Properties and Performance Characteristics

Note: The following technical information and data should be considered representative or typical only and should not be used for specification purposes.

Product Number	9888T
<b>Adhesion to stainless steel</b> ASTM D3330 –180 degree, 2 mil Al foil at 22°C, 50%RH 15 minute RT 72 Hour RT	g/25.4m  2940 3180
<b>Adhesion to ABS</b> ASTM D3330 –180 degree, 2 mil Al foil at 22°C, 50%RH 15 minute RT 72 Hour RT	2210 2440
<b>Adhesion to PC</b> ASTM D3330 –180 degree, 2 mil Al foil at 22°C, 50%RH 15 minute RT 72 Hour RT	2560 2670
<b>Adhesion to PP</b> ASTM D3330 –180 degree, 2 mil Al foil at 22°C, 50%RH 20 minute RT 72 Hour RT	1900 2190

<b>Shear strength</b> ASTM D3654 modified 0.5 inch <sup>2</sup> sample size at 22°C 1000 grams	10000 mins
<b>Relative High temperature Operating Ranges</b>	
Long Term (days, weeks)	80°C
Short Term (minutes, hours)	120°C
<b>Shelf Life</b> 12 months from date of receipt by customer when stored in original carton at 22 °C and 50% relative humidity	

### **Application Techniques:**

Bond strength is dependent upon the amount of adhesive-to-surface contact developed. Firm application pressure helps develop better adhesive contact and improves bond strength.

To obtain optimum adhesion, the bonding surfaces must be clean, dry and well unified. Some typical surface cleaning solvents are isopropyl alcohol or heptane. Note: Carefully read and follow the manufacturer's precautions and directions for use when working with solvents.

Ideal tape application temperature range is 70° F to 100° F (21° C to 38° C). Initial tape application to surfaces at temperatures below 50° F (10° C) is not recommended because the adhesive becomes too firm to adhere readily. However, once properly applied, low temperature holding is generally satisfactory.

### **General Information**

Tape 9888T has a tissue carrier, which can add dimensional stability to foams and other substrates. The carrier also provides easier handling during slitting and die-cutting.

### **Application Ideas**

- 9888T tapes are specially formulated for many indoor high performance purpose mounting and joining applications, including bonding to Polyethylene, Polypropylene and many other Plastics, where moderate temperature and shear performance are required.
- 9888T tapes are formulated for more demanding indoor and moderate outdoor high performance mounting and joining application.
- Application ideas for these tapes include
  - Lens attachment for mobile phone
  - Wire and Cable Clips
  - Appliance, Case for display and Electronics Equipment Trim
  - Interior under sheet for car
  - Paper splicing
  - Foam, Gasket attachment in mobile phones and pagers.
  - Plastics Hooks, Racks and Dispensers
  - Sign, Nameplates and Plaques
  - Appliques

**Important Notice**

3M MAKES NO WARRANTIES, EXPRESS OR IMPLIED, INCLUDING, BUT NOT LIMITED TO, ANY IMPLIED WARRANTY OF MERCHANTABILITY OR FITNESS FOR A PARTICULAR PURPOSE. User is responsible for determining whether the 3M product is fit for a particular purpose and suitable for user's method of application. Please remember that many factors can affect the use and performance of a 3M product in a particular application. The materials to be bonded with the product, the surface preparation of those materials, the product selected for use, the conditions in which the product is used, and the time and environmental conditions in which the product is expected to perform are among the many factors that can affect the use and performance of a 3M product. Given the variety of factors that can affect the use and performance of a 3M product, some of which are uniquely within the user's knowledge and control, it is essential that the user evaluate the 3M product to determine whether it is fit for a particular purpose and suitable for the user's method of application.

**Limitation of Remedies and Liability**

If the 3M product is proved to be defective, THE EXCLUSIVE REMEDY, AT 3M'S OPTION, SHALL BE TO REFUND THE PURCHASE PRICE OF OR TO REPAIR OR REPLACE THE DEFECTIVE 3M PRODUCT. 3M shall not otherwise be liable for loss or damages, whether direct, indirect, special, incidental, or consequential, regardless of the legal theory asserted, including negligence, warranty, or strict liability.

Part No.	Development status
20565-001R-13	Under development

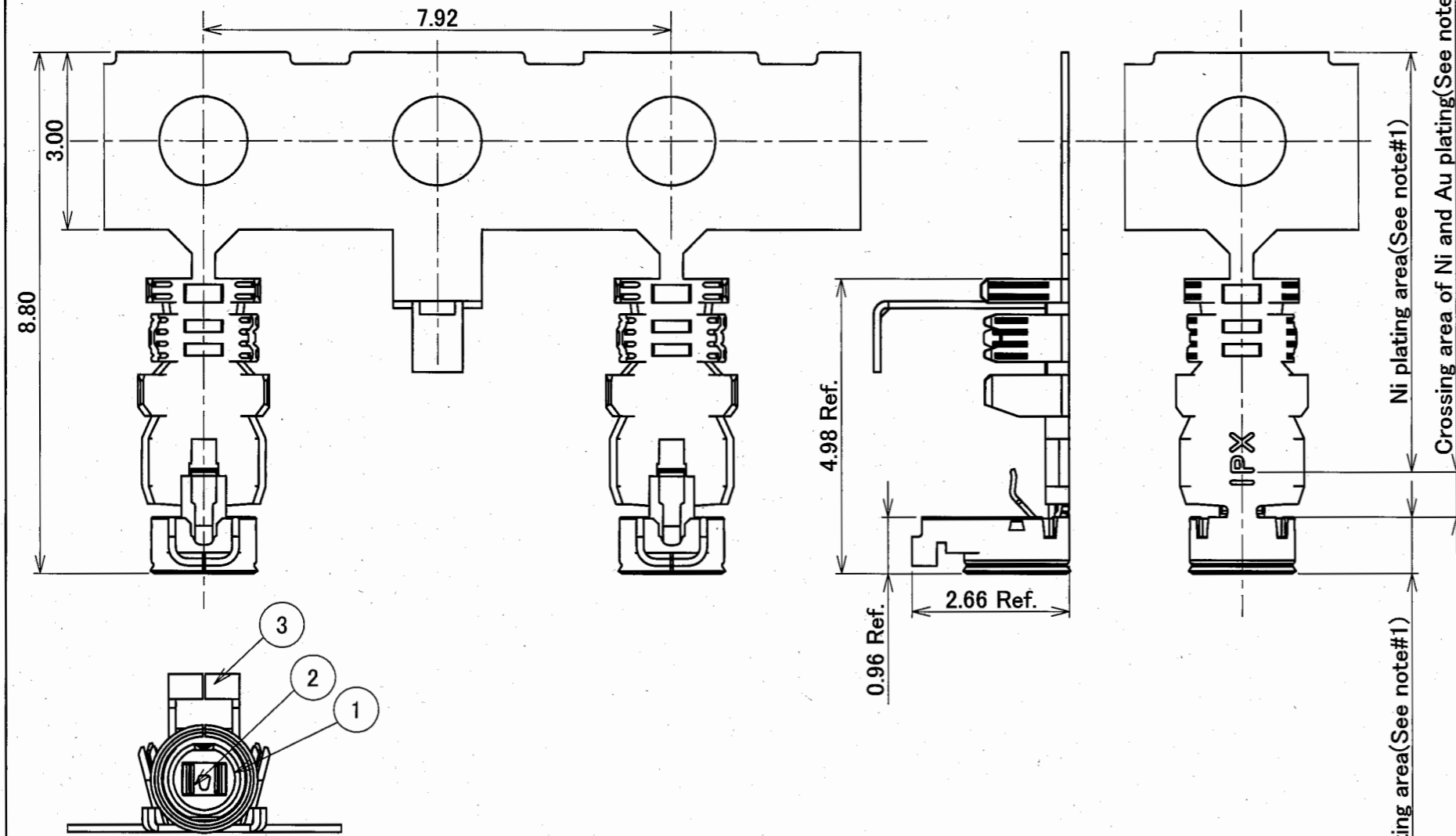

Notes

1. Material and finish(Plating)

- ① Housing  
PBT(Black) UL94V-0
- ② Contact  
Phosphor bronze : Au over Ni
- ③ Ground Contact  
Phosphor bronze  
Au plating area : Au over Ni  
Ni plating area : Ni only

2. Packing

Reel

3. Applicable cable

3-1. Description

Inner conductor

AWG#32(7/0.08)

Silver plating annealed copper wire or silver plating tin-copper alloy.

\*Must not use solder coated inner conductor.

Dielectric core

Fluoro-plastics, diameter 0.68(+0.04/-0.02)mm  
nominal thickness 0.22mm

Outer conductor

16/4/0.05, nominal diameter 0.93mm silver plating  
annealed copper wire.

\*Must not use solder coated outer conductor

Jacket

Fluoro-plastics, diameter 1.13(+0.08/-0.05)mm  
nominal thickness 0.10mm

3-2. Requirements

Characteristic impedance : 50(±2)ohm by TDR method

Nominal capacitance(Reference value) : 97pF/m

Conductor resistance of inner conductor(Reference value):520 ohm/km

Insulation resistance : 1500Mega-ohm. km MIN.

Dielectric with stance voltage : on breakdown at AC1000V for 1 minutes.

4. Applicable connector

P/N:20449-001E-\*\*-\*\* MHF4 Receptacle

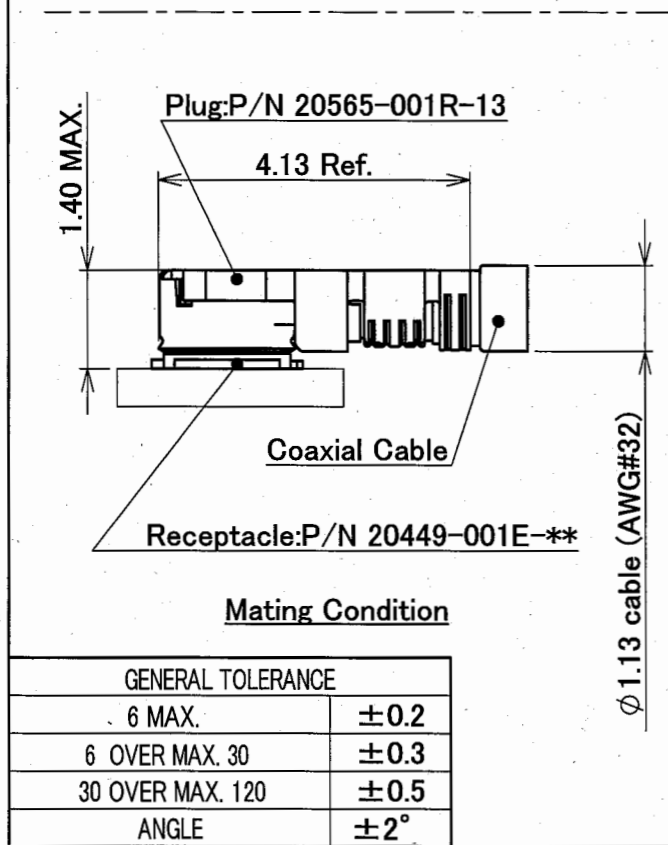

Mating Condition

GENERAL TOLERANCE	
6 MAX.	±0.2
6 OVER MAX. 30	±0.3
30 OVER MAX. 120	±0.5
ANGLE	±2°

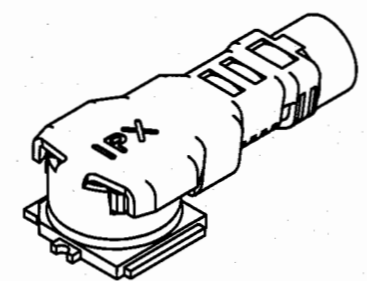
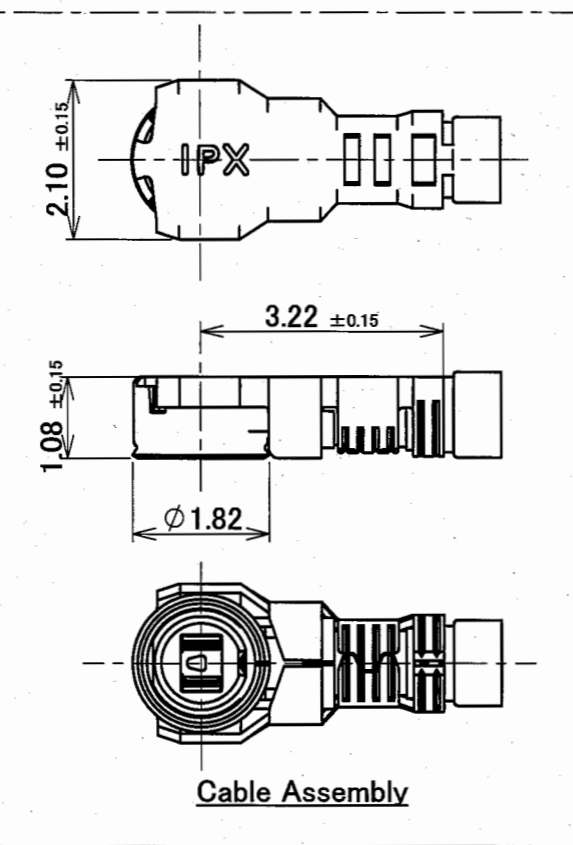

For CINGXING						DAI-CHI SEIKO CO.,LTD.		I-PEX Business Company		
DESIGN'D BY	S.Suzuki		DATE	Jul.10/1/13		TITLE	MHF4L PLUG CONNECTOR			
CHK'D BY	<i>[Signature]</i>		DATE	Jul.10/1/13						
APP'D BY	T.Takano		DATE	July/01/13						
REV	ECN	BY	DATE	APP		SCALE	UNIT	DWG. No.	SHEET	REV.
0	Z13609	S.S	Jul.10/1/13			10:1	mm	20565	1/2	0
REV.RECORD				SERIES No.		CUSTOMER COPY		PROJECTION		
				R5		①				



Part No.	20565-001R-13		
Applicable cable strip dimension			
Braided shield of Outer conductor	Single braided shield		
P/N of semi auto termination machine	90600-013		
Crimp Height	 Note 2 CH-1(i-Fit Part) : 1.07~1.11	 Note 2 CH-2(Shield Part) : 0.90~0.94	 Note 2 CH-3(Jacket Part) : 1.16~1.20

- Notes.
1. Must not use solder coated inner conductor and outer conductor
  2. Use for point micrometer.
  3. Mating and unmating instruction
    - 3-1. Mating  
Mate the connector vertically as much as possible, adjusting the mating axis of plug and receptacle. Do not slant mate.
    - 3-2. Unmating
      - 3-2-1. In case of unmating by pulling tool(P/N90609-0001)  
Use the pulling tool as the following drawing, and pull plug to vertical direction as directly as possible.
      - 3-2-2. In case of unmating directly by hand.  
Catch the catching area of plug, and pull plug to vertical direction as directly as possible.

Note 3-1

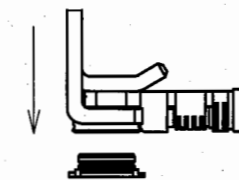

Note 3-2-1

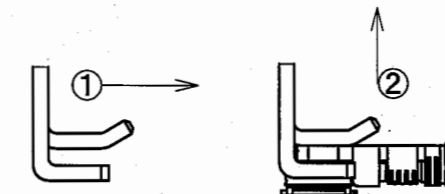

Note 3-2-2

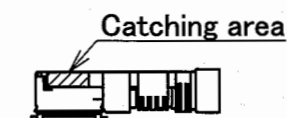

GENERAL TOLERANCE	
6 MAX.	±0.2
6 OVER MAX. 30	±0.3
30 OVER MAX. 120	±0.5
ANGLE	±2°

For CINGXING																																										
<table border="1"> <tr> <td>DESIGN'D BY</td> <td>DATE</td> </tr> <tr> <td>CHK'D BY</td> <td>DATE</td> </tr> <tr> <td>APP'D BY</td> <td>DATE</td> </tr> <tr> <td>REV</td> <td>ECN</td> <td>BY</td> <td>DATE</td> <td>APP</td> </tr> <tr> <td colspan="5">REV.RECORD</td> </tr> <tr> <td colspan="5">SERIES No.</td> </tr> </table>					DESIGN'D BY	DATE	CHK'D BY	DATE	APP'D BY	DATE	REV	ECN	BY	DATE	APP	REV.RECORD					SERIES No.					<table border="1"> <tr> <td colspan="2">I-PEX DAI-ICHI SEIKO CO.,LTD. I-PEX Business Company</td> </tr> <tr> <td colspan="2">TITLE MHF4L PLUG CONNECTOR</td> </tr> </table>		I-PEX DAI-ICHI SEIKO CO.,LTD. I-PEX Business Company		TITLE MHF4L PLUG CONNECTOR		<table border="1"> <tr> <td>CUSTOMER COPY</td> <td>PROJECTION</td> </tr> <tr> <td></td> <td></td> </tr> </table>		CUSTOMER COPY	PROJECTION			SCALE	UNIT	DWG. No.	SHEET	REV.
					DESIGN'D BY	DATE																																				
					CHK'D BY	DATE																																				
APP'D BY	DATE																																									
REV	ECN	BY	DATE	APP																																						
REV.RECORD																																										
SERIES No.																																										
I-PEX DAI-ICHI SEIKO CO.,LTD. I-PEX Business Company																																										
TITLE MHF4L PLUG CONNECTOR																																										
CUSTOMER COPY	PROJECTION																																									
	10:1	mm	20565	2/2	0																																					

# SPECIFICATION FOR APPROVAL

DOCUMENT: A3132TS001

---

STYLE : COAXIAL CABLE  
105°C 30V

---

SIZE: 32AWG×1C  
BRAID : TD

---

RECOGNIZED: UL 1979  
MEET VW-1

---



**WONDERFUL HI-TECH CO.,LTD.**

OFFICE : 72WU KONG 6TH ROAD,  
WU KU IND. DISTRICT  
TAIPEI HSIEN,TAIWAN

FACTORY : 17 PEI YUAN ROAD,  
CHUNG-LI IND. PARK  
TAIWAN, R.O.C.

TEL : (02)22988033  
FAX : (02)22988031-2

TEL : (03)4527777  
FAX : (03)4517214

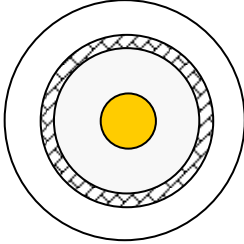

# WONDERFUL HI-TECH CO., LTD. SPECIFICATION

STYLE	105°C 30V UL 1979	DOCUMENT NO : A3132TS001	
SIZE	32AWG	ESTABLISHED DATE: Mar/16/2005	
STANDARD :			
Conductor	Size	AWG	32
	Material	----	Silver Cover Copper
	Conductors No.	----	7
	Conductors Size	mm	0.085
	O.D.	mm	0.26
Insulation	Average Thickness	mm	0.22
	Diameter	mm	0.70 ± 0.03
	Material	----	FEP
	Color	----	Clear
Braid	Material	----	Tinned Copper
	Construction	mm	16 / 4 / 0.050
	Coverage	%	89.4
Jacket	Average Thickness	mm	0.12
	Diameter	mm	1.13 ± 0.05
	Material	----	FEP
	Color	----	According to customer
Marking	Non		
Drawing			

AK001/210X297/1.0

PAGE : 1

EDITION : 1.4

MAKER : *H. C. KUO* CONFIRM : *C. Y. Chen*

APPROVAL : *W. J. Wang*



# WONDERFUL HI-TECH CO., LTD.

## SPECIFICATION

Electrical & Physical Properties					
Item		32AWG			
Rating Temp Voltage		105°C 30V			
Conductor Resistance		497 OHM/KM/20°C MAX.			
Insulation Resistance		3000 MEGA OHM-KM MIN.			
Dielectric Strength		AC 1000 V/Minute			
Spark Test		2 KV			
Insulation	Unaged	Tensile Strength	2500 PSI MIN.( 1.76 Kg / m m <sup>2</sup> )		
		Elongation	200% MIN.		
	Aged	Tensile Strength	UNAGED MIN. 75%(168HRS×232°C)		
		Elongation	UNAGED MIN. 75%(168HRS×232°C)		
Jacket	Unaged	Tensile Strength	2500 PSI MIN.( 1.76 Kg / m m <sup>2</sup> )		
		Elongation	200% MIN.		
	Aged	Tensile Strength	UNAGED MIN.75%(168HRS×232°C)		
		Elongation	UNAGED MIN.75%(168HRS×232°C)		
Nom. Impedance		50 ± 3 Ohms			
Nom. Capacitance		96 ± 3 pF/m			
Nom. Vel. of Prop.		69%			
Storage Temperature		-40°C ~+80°C			
VSWR Test (0 – 6 GHZ)		Max 1.3			
Flame Test		VW-1 OK			
Attenuation (dB/1m)	2.0GHZ	2.4GHZ	2.5GHZ	5.0GHZ	6.0 GHZ
	2.90	3.20	3.28	5.05	5.40

AK001/210X297/1.0

PAGE : 2

EDITION : 1.4

MAKER : *H. C. KUO*CONFIRM : *C. Y. Chen*APPROVAL : *W. J. Wang*