



FCC TEST REPORT (15.407)

REPORT NO.: RF940714L20

MODEL NO.: WX-7800A

Refer to page 6 for other models

RECEIVED: Jul. 19, 2005

TESTED: Oct. 15, 2004 ~ Aug. 01, 2005

ISSUED: Aug. 04, 2005

APPLICANT: SparkLAN Communications, Inc.

ADDRESS: 3Fl., No. 246, Sec. 1, Neihu Road., Neihu
Chiu, Taipei Taiwan 114, R.O.C

ISSUED BY: Advance Data Technology Corporation

LAB ADDRESS: No. 47, 14th Ling, Chia Pau Tsuen, Lin Kou
Hsiang 244, Taipei Hsien, Taiwan, R.O.C.

TEST LOCATION: No. 19, Hwa Ya 2nd Rd., Wen Hwa Tsuen, Kwei
Shan Hsiang, Taoyuan Hsien 333, Taiwan,
R.O.C.

This test report consists of 74 pages in total. It may be duplicated completely for legal use with the approval of the applicant. It should not be reproduced except in full, without the written approval of our laboratory. The client should not use it to claim product endorsement by CNLA, A2LA or any government agencies. The test results in the report only apply to the tested sample.



0528
ILAC MRA



No. 2177-01



Table of Contents

1.	CERTIFICATION	4
2.	SUMMARY OF TEST RESULTS	5
2.1	MEASUREMENT UNCERTAINTY	5
3.	GENERAL INFORMATION	6
3.1	GENERAL DESCRIPTION OF EUT	6
3.2	DESCRIPTION OF TEST MODES	8
3.2.1	CONFIGURATION OF SYSTEM UNDER TEST	9
3.2.2	TEST MODE APPLICABILITY AND TESTED CHANNEL DETAIL:	10
3.3	GENERAL DESCRIPTION OF APPLIED STANDARDS	12
3.4	DESCRIPTION OF SUPPORT UNITS.....	12
4.	TEST TYPES AND RESULTS (5150 ~ 5350MHz BAND)	13
4.1	CONDUCTED EMISSION MEASUREMENT	13
4.1.1	LIMITS OF CONDUCTED EMISSION MEASUREMENT	13
4.1.2	TEST INSTRUMENTS.....	13
4.1.3	TEST PROCEDURES	14
4.1.4	DEVIATION FROM TEST STANDARD	14
4.1.5	TEST SETUP	15
4.1.6	EUT OPERATING CONDITIONS	15
4.1.7	TEST RESULTS	16
4.2	RADIATED EMISSION MEASUREMENT	18
4.2.1	LIMITS OF RADIATED EMISSION MEASUREMENT.....	18
4.2.2	LIMITS OF UNWANTED EMISSION OUT OF THE RESTRICTED BANDS	19
4.2.3	TEST INSTRUMENTS.....	20
4.2.4	TEST PROCEDURES	21
4.2.5	DEVIATION FROM TEST STANDARD	21
4.2.6	TEST SETUP	22
4.2.7	EUT OPERATING CONDITION	22
4.2.8	TEST RESULTS	23
4.3	PEAK TRANSMIT POWER MEASUREMENT	31
4.3.1	LIMITS OF PEAK TRANSMIT POWER MEASUREMENT	31
4.3.2	TEST INSTRUMENTS.....	31
4.3.3	TEST PROCEDURE.....	32
4.3.4	DEVIATION FROM TEST STANDARD	32
4.3.5	TEST SETUP	32
4.3.6	EUT OPERATING CONDITIONS	32
4.3.7	TEST RESULTS	33
4.4	PEAK POWER EXCURSION MEASUREMENT	43
4.4.1	LIMITS OF PEAK POWER EXCURSION MEASUREMENT	43
4.4.2	TEST INSTRUMENTS.....	43
4.4.3	TEST PROCEDURE.....	44
4.4.4	DEVIATION FROM TEST STANDARD	44
4.4.5	TEST SETUP	44
4.4.6	EUT OPERATING CONDITIONS	44
4.4.7	TEST RESULTS	45
4.5	PEAK POWER SPECTRAL DENSITY MEASUREMENT	51
4.5.1	LIMITS OF PEAK POWER SPECTRAL DENSITY MEASUREMENT	51
4.5.2	TEST INSTRUMENTS.....	51



- 4.5.3 TEST PROCEDURES 52
- 4.5.4 DEVIATION FROM TEST STANDARD 52
- 4.5.5 TEST SETUP 52
- 4.5.6 EUT OPERATING CONDITIONS 52
- 4.5.7 TEST RESULTS 53
- 4.6 FREQUENCY STABILITY 59
- 4.6.1 LIMITS OF FREQUENCY STABILITY MEASUREMENT 59
- 4.6.2 TEST INSTRUMENTS 59
- 4.6.3 TEST PROCEDURE 59
- 4.6.4 DEVIATION FROM TEST STANDARD 59
- 4.6.5 TEST SETUP 60
- 4.6.6 EUT OPERATING CONDITION 60
- 4.6.7 TEST RESULTS 61
- 4.7 BAND EDGES MEASUREMENT 62
- 4.7.1 TEST INSTRUMENTS 62
- 4.7.2 TEST PROCEDURE 62
- 4.7.3 EUT OPERATING CONDITION 62
- 4.7.4 TEST RESULTS 62
- 4.8 ANTENNA REQUIREMENT 71
- 4.8.1 STANDARD APPLICABLE 71
- 4.8.2 ANTENNA CONNECTED CONSTRUCTION 71
- 5. PHOTOGRAPHS OF THE TEST CONFIGURATION 72
- 6. INFORMATION ON THE TESTING LABORATORIES 74



1. CERTIFICATION

PRODUCT: Wireless 11a+g Dual-Band Access Point
BRAND NAME: SparkLAN
Refer to page 6 for other brand names
MODEL NO.: WX-7800A
Refer to page 6 for other models
APPLICANT: SparkLAN Communications, Inc.
TEST SAMPLE: Engineering Sample
TESTED: Oct. 15, 2004 ~ Aug. 01, 2005
STANDARDS: FCC Part 15, Subpart E (Section 15.407)
ANSI C63.4-2003

The above equipment has been tested by **Advance Data Technology Corporation**, and found compliance with the requirement of the above standards. The test record, data evaluation & Equipment Under Test (EUT) configurations represented herein are true and accurate accounts of the measurements of the sample's EMC characteristics under the conditions specified in this report.

PREPARED BY : Wendy Liao , **DATE:** Aug. 04, 2005
(Wendy Liao)

TECHNICAL
ACCEPTANCE : Gary Chang , **DATE:** Aug. 04, 2005
Responsible for RF (Gary Chang)

APPROVED BY : Cody Chang , **DATE:** Aug. 04, 2005
(Cody Chang, Deputy Manager)

2. SUMMARY OF TEST RESULTS

The EUT has been tested according to the following specifications:

APPLIED STANDARD: FCC Part 15, Subpart E (Section 15.407)			
Standard Section	Test Type	Result	Remark
15.407(b)(5)	AC Power Conducted Emission	PASS	Meet the requirement of limit. Minimum passing margin is -14.73dB at 3.555MHz
15.407(b/1/2/3) (b)(5)	Electric Field Strength Spurious Emissions, 30MHz ~ 40000MHz	PASS	Meet the requirement of limit. Minimum passing margin is -1.00dB at 5150.00MHz
15.407(a/1/2/3)	Peak Transmit Power	PASS	Meet the requirement of limit.
15.407(a)(6)	Peak Power Excursion	PASS	Meet the requirement of limit.
15.407(a/1/2/3)	Peak Power Spectral Density	PASS	Meet the requirement of limit.
15.407(g)	Frequency Stability	PASS	Meet the requirement of limit.

2.1 MEASUREMENT UNCERTAINTY

Where relevant, the following measurement uncertainty levels have been estimated for tests performed on the EUT as specified in CISPR 16-4:

Measurement	Frequency	Uncertainty
Conducted emissions	9kHz ~ 30MHz	2.44 dB
	30MHz ~ 200MHz	3.55 dB
Radiated emissions	200MHz ~1000MHz	3.58 dB
	1GHz ~ 18GHz	1.10 dB
	18GHz ~ 40GHz	0.91 dB

This uncertainty represents an expanded uncertainty expressed at approximately the 95% confidence level using a coverage factor of k=2.



3. GENERAL INFORMATION

3.1 GENERAL DESCRIPTION OF EUT

EUT	Wireless 11a+g Dual-Band Access Point
MODEL NO.	WX-7800A Refer to Note 1 for other models
POWER SUPPLY	5Vdc from AC Adapter
MODULATION TYPE	CCK, DQPSK, DBPSK for DSSS 64QAM, 16QAM, QPSK, BPSK for OFDM
MODULATION TECHNOLOGY	DSSS, OFDM
TRANSFER RATE	802.11b: 11/5.5/2/1Mbps 802.11g: 54/48/36/24/18/12/9/6Mbps (Turbo mode: up to 108Mbps *see Note 3) 802.11a: 54/48/36/24/18/12/9/6Mbps (Turbo mode: up to 108Mbps *see Note 3)
FREQUENCY RANGE	802.11b & 802.11g: 2.412 ~ 2.462GHz 802.11a: 5.150 ~ 5.350GHz and 5.725 ~ 5.850GHz
NUMBER OF CHANNEL	802.11b & 802.11g: 11 for Normal mode / 1 for Turbo mode 802.11a: 13 for Normal mode / 5 for Turbo mode
CHANNEL SPACING	802.11b & 802.11g: 5MHz 802.11a: 20MHz for Normal mode / 40MHz for Turbo mode
OUTPUT POWER	64.57mW for 802.11b 41.69mW for 802.11g 22.03mW for 5.15 ~ 5.35GHz 40.18mW for 5.75 ~ 5.850GHz
ANTENNA TYPE	Dipole antenna with 2.0dBi gain for 2.4GHz Dipole antenna with 4.0dBi gain for 5GHz
DATA CABLE	NA
I/O PORTS	RJ45
ASSOCIATED DEVICES	NA

NOTE:

1. The models as below are identical to each other except for their model designation and brand name, due to marketing requirement.

Model Name	Brand	Description
WX-7800A	SparkLAN	For marketing different.
TEW-510APB	TRENDnet	For marketing different.

2. The EUT operates in both the 5GHz and 2.4GHz Bands and compatibility with 802.11a and 802.11b, 802.11g technology.
3. This EUT is capable of providing data rates of up to 108Mbps in Turbo Mode depending upon reception quality.



4. The EUT were powered by the following adapters:

BRAND:	LEI (LEADER ELECTRONICS INC.)
MODEL :	MT15-5050250-A1
INPUT :	100-120Vac, 0.5A, 60Hz
OUTPUT :	5.0Vdc, 2.5A
POWER LINE :	1.8m non-shielded cable without core

5. The above EUT information was declared by the manufacturer and for more detailed features description, please refer to the manufacturer's specifications or User's Manual.

3.2 DESCRIPTION OF TEST MODES

Operated in 5150 ~ 5250MHz, 5250MHz ~ 5350MHz bands:

Eight channels are provided to this EUT for normal mode.

Channel	Frequency
1	5180 MHz
2	5200 MHz
3	5220 MHz
4	5240 MHz
5	5260 MHz
6	5280 MHz
7	5300 MHz
8	5320 MHz

Three channels are provided to this EUT for turbo mode.

Channel	Frequency
1	5210 MHz
2	5250 MHz
3	5290 MHz

3.2.1 CONFIGURATION OF SYSTEM UNDER TEST

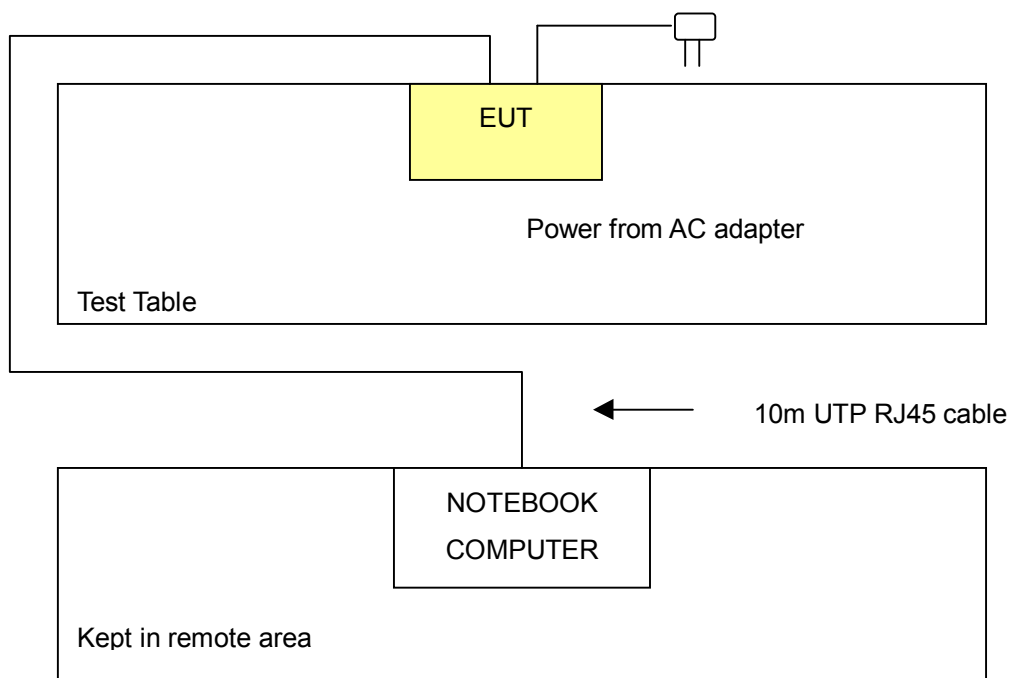



3.2.2 TEST MODE APPLICABILITY AND TESTED CHANNEL DETAIL:

EUT configure mode	Applicable to				Description
	PLC	RE<1G	RE≥1G	APCM	
-	V	V	V	V	-

Where PLC: Power Line Conducted Emission RE<1G RE: Radiated Emission below 1GHz
 RE≥1G: Radiated Emission above 1GHz APCM: Antenna Port Conducted Measurement

Power Line Conducted Emission Test:

- Pre-Scan has been conducted to determine the worst-case mode from all possible combinations between available modulations, data rates and antenna ports (if EUT with antenna diversity architecture).
- Following channel(s) was (were) selected for the final test as listed below.

Mode	Available Channel	Tested Channel	Modulation Technology	Modulation Type	Data Rate (Mbps)
802.11a	1 to 8	8	OFDM	BPSK	6

Radiated Emission Test (Below 1 GHz):

- Pre-Scan has been conducted to determine the worst-case mode from all possible combinations between available modulations, data rates, rotatable angle of EUT and antenna ports (if EUT with antenna diversity architecture).
- Following channel(s) was (were) selected for the final test as listed below.

Mode	Available Channel	Tested Channel	Modulation Technology	Modulation Type	Data Rate (Mbps)
802.11a	1 to 8	8	OFDM	BPSK	6

Radiated Emission Test (Above 1 GHz):

- Pre-Scan has been conducted to determine the worst-case mode from all possible combinations between available modulations, data rates, rotatable angle of EUT and antenna ports (if EUT with antenna diversity architecture).
- Following channel(s) was (were) selected for the final test as listed below.

Mode	Available Channel	Tested Channel	Modulation Technology	Modulation Type	Data Rate (Mbps)
802.11a	1 to 8	1, 4, 5, 8	OFDM	BPSK	6
802.11a Turbo	1 to 3	1, 2, 3	OFDM	BPSK	12



Bandedge Measurement:

- Pre-Scan has been conducted to determine the worst-case mode from all possible combinations between available modulations, data rates and antenna ports (if EUT with antenna diversity architecture).
- Following channel(s) was (were) selected for the final test as listed below.

Mode	Available Channel	Tested Channel	Modulation Technology	Modulation Type	Data Rate (Mbps)
802.11a	1 to 8	1, 8	OFDM	BPSK	6
802.11a Turbo	1 to 3	1, 3	OFDM	BPSK	12

Antenna Port Conducted Measurement:

- Pre-Scan has been conducted to determine the worst-case mode from all possible combinations between available modulations, data rates and antenna ports (if EUT with antenna diversity architecture).
- Following channel(s) was (were) selected for the final test as listed below.

Mode	Available Channel	Tested Channel	Modulation Technology	Modulation Type	Data Rate (Mbps)
802.11a	1 to 8	1, 4, 5, 8	OFDM	BPSK	6
802.11a Turbo	1 to 3	1, 2, 3	OFDM	BPSK	12



3.3 GENERAL DESCRIPTION OF APPLIED STANDARDS

The EUT is an Wireless 11a+g Dual-Band Access Point. According to the specifications of the manufacturer, it must comply with the requirements of the following standards:

FCC Part 15, Subpart E (15.407)

ANSI C63.4-2003

All test items have been performed and recorded as per the above standards.

NOTE: The EUT is also considered as a kind of computer peripheral, because the connection to computer is necessary for typical use. It has been verified to comply with the requirements of FCC Part 15, Subpart B, Class B (DoC). The test report has been issued separately.

3.4 DESCRIPTION OF SUPPORT UNITS

The EUT has been tested as an independent unit together with other necessary accessories or support units. The following support units or accessories were used to form a representative test configuration during the tests.

NO.	PRODUCT	BRAND	MODEL NO.	SERIAL NO.	FCC ID
1	NOTEBOOK COMPUTER	DELL	PP05L	12130898320	E2K24CLNS

NO.	SIGNAL CABLE DESCRIPTION OF THE ABOVE SUPPORT UNITS
1	NA

NOTE: 1. All power cords of the above support units are non shielded (1.8m).
 2. Item 1 act as a communication partner to transfer data.



4. TEST TYPES AND RESULTS (5150 ~ 5350MHz Band)

4.1 CONDUCTED EMISSION MEASUREMENT

4.1.1 LIMITS OF CONDUCTED EMISSION MEASUREMENT

FREQUENCY OF EMISSION (MHz)	CONDUCTED LIMIT (dB μ V)	
	Quasi-peak	Average
0.15-0.5	66 to 56	56 to 46
0.5-5	56	46
5-30	60	50

- NOTE:**
1. The lower limit shall apply at the transition frequencies.
 2. The limit decreases in line with the logarithm of the frequency in the range of 0.15 to 0.50 MHz.
 3. All emanations from a class A/B digital device or system, including any network of conductors and apparatus connected thereto, shall not exceed the level of field strengths specified above.

4.1.2 TEST INSTRUMENTS

DESCRIPTION & MANUFACTURER	MODEL NO.	SERIAL NO.	CALIBRATED UNTIL
Test Receiver ROHDE & SCHWARZ	ESCS30	100288	Nov. 06, 2005
RF signal cable Woken	5D-FB	Cable-HyC02-01	Jan. 09, 2006
LISN ROHDE & SCHWARZ	ESH2-Z5	100100	Jan. 20, 2006
LISN ROHDE & SCHWARZ	ESH3-Z5	100311	Jan. 20, 2006
Software ADT	ADT_Cond_V3	NA	NA

- NOTE:**
1. The calibration interval of the above test instruments is 12 months and the calibrations are traceable to NML/ROC and NIST/USA.
 2. The test was performed in HwaYa Shielded Room 3.
 3. The VCCI Site Registration No. is C-2047.



4.1.3 TEST PROCEDURES

- a. The EUT was placed 0.4 meters from the conducting wall of the shielded room with EUT being connected to the power mains through a line impedance stabilization network (LISN). Other support units were connected to the power mains through another LISN. The two LISNs provide 50 ohm/ 50uH of coupling impedance for the measuring instrument.
- b. Both lines of the power mains connected to the EUT were checked for maximum conducted interference.
- c. The frequency range from 150kHz to 30MHz was searched. Emission levels under (Limit - 20dB) was not recorded.

4.1.4 DEVIATION FROM TEST STANDARD

No deviation

4.1.5 TEST SETUP

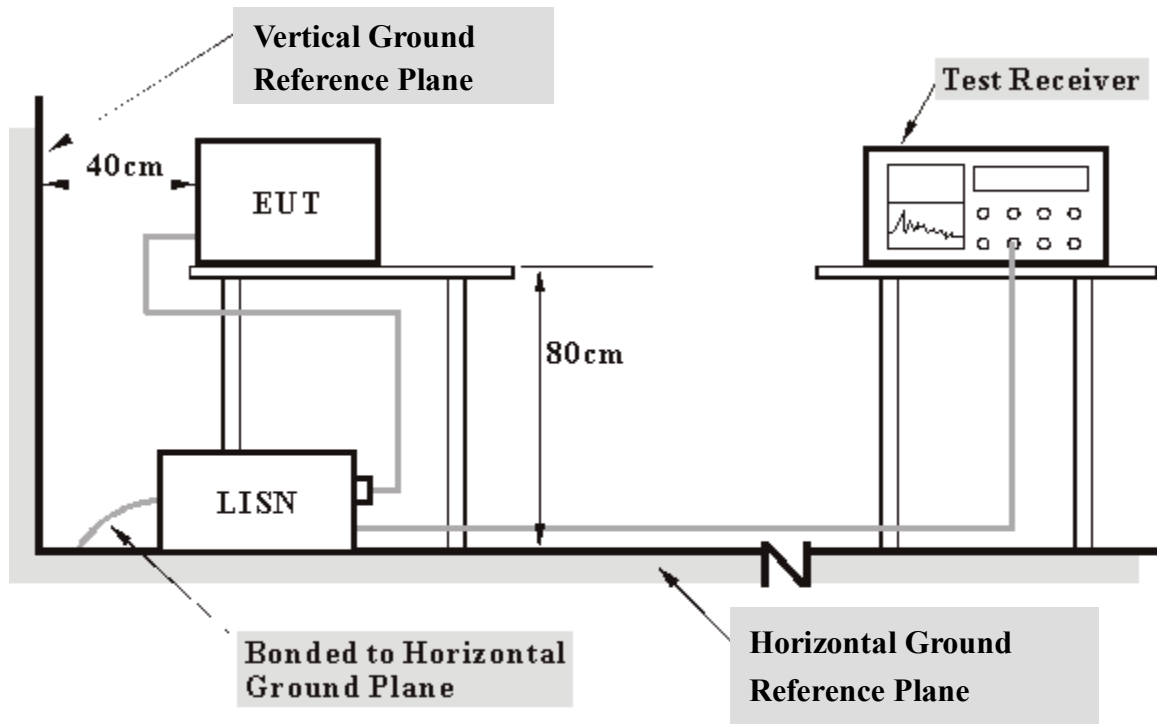

- Note:**
1. Support units were connected to second LISN.
 2. Both of LISNs (AMN) 80 cm from EUT and at the least 80 cm from other units and other metal planes support units.

For the actual test configuration, please refer to the related item – Photographs of the Test Configuration.

4.1.6 EUT OPERATING CONDITIONS

- a. Placed the EUT on the testing table.
- b. Prepared another notebook system to act as a communication partner and placed it outside of testing area.
- c. The communication partner run a test program (provided by manufacturer) to enable EUT under transmission/receiving condition continuously at specific channel frequency via an RJ45 cable.
- d. The communication partner sent data to EUT by command "PING".



4.1.7 TEST RESULTS

Conducted Worst-Case Data

EUT	Wireless 11a+g Dual-Band Access Point	MEASUREMENT DETAIL	
MODEL	WX-7800A	PHASE	Line 1
CHANNEL	Channel 8	6dB BANDWIDTH	9 kHz
MODULATION TYPE	BPSK	ENVIRONMENTAL CONDITIONS	23deg. C, 65%RH, 991hPa
TRANSFER RATE	6Mbps	INPUT POWER (SYSTEM)	120Vac, 60 Hz
TESTED BY	Gary Chang		

No	Freq. [MHz]	Corr. Factor (dB)	Reading Value [dB (uV)]		Emission Level [dB (uV)]		Limit [dB (uV)]		Margin (dB)	
			Q.P.	AV.	Q.P.	AV.	Q.P.	AV.	Q.P.	AV.
			1	0.150	0.10	42.13	-	42.23	-	66.00
2	0.357	0.10	35.69	-	35.79	-	58.80	48.80	-23.01	-
3	1.254	0.20	40.01	-	40.21	-	56.00	46.00	-15.79	-
4	1.410	0.20	38.86	-	39.06	-	56.00	46.00	-16.94	-
5	2.129	0.20	38.11	-	38.31	-	56.00	46.00	-17.69	-
6	3.555	0.20	41.07	-	41.27	-	56.00	46.00	-14.73	-

- REMARKS:**
1. Q.P. and AV. are abbreviations of quasi-peak and average individually.
 2. "-": The Quasi-peak reading value also meets average limit and measurement with the average detector is unnecessary.
 3. The emission levels of other frequencies were very low against the limit.
 4. Margin value = Emission level - Limit value
 5. Correction factor = Insertion loss + Cable loss
 6. Emission Level = Correction Factor + Reading Value.

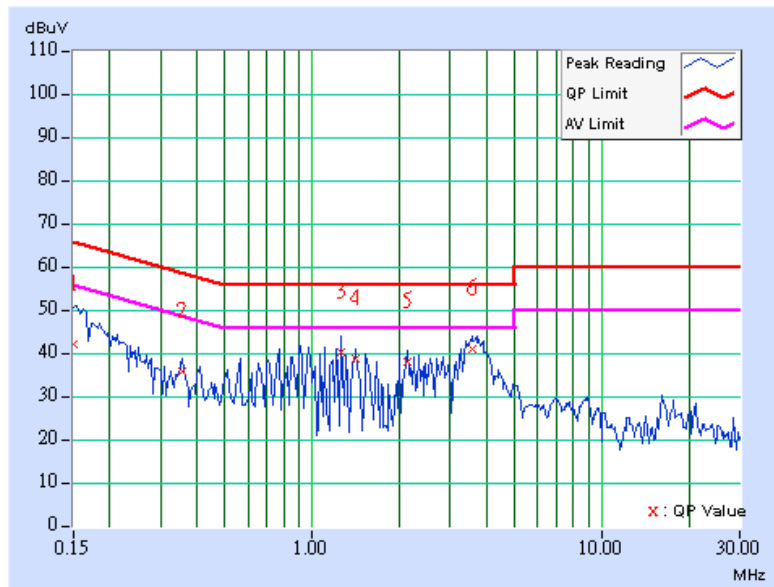



EUT	Wireless 11a+g Dual-Band Access Point	MEASUREMENT DETAIL	
MODEL	WX-7800A	PHASE	Line 2
CHANNEL	Channel 8	6dB BANDWIDTH	9 kHz
MODULATION TYPE	BPSK	ENVIRONMENTAL CONDITIONS	23deg. C, 65%RH, 991hPa
TRANSFER RATE	6Mbps	INPUT POWER (SYSTEM)	120Vac, 60 Hz
TESTED BY	Gary Chang		

No	Freq. [MHz]	Corr. Factor (dB)	Reading Value [dB (uV)]		Emission Level [dB (uV)]		Limit [dB (uV)]		Margin (dB)	
			Q.P.	AV.	Q.P.	AV.	Q.P.	AV.	Q.P.	AV.
			1	0.150	0.10	42.45	-	42.55	-	66.00
2	0.259	0.10	33.57	-	33.67	-	61.45	51.45	-27.78	-
3	0.920	0.19	40.06	-	40.25	-	56.00	46.00	-15.75	-
4	1.402	0.20	36.22	-	36.42	-	56.00	46.00	-19.58	-
5	3.559	0.20	40.72	-	40.92	-	56.00	46.00	-15.08	-
6	18.242	0.69	26.71	-	27.40	-	60.00	50.00	-32.60	-

- REMARKS:**
1. Q.P. and AV. are abbreviations of quasi-peak and average individually.
 2. "-": The Quasi-peak reading value also meets average limit and measurement with the average detector is unnecessary.
 3. The emission levels of other frequencies were very low against the limit.
 4. Margin value = Emission level - Limit value
 5. Correction factor = Insertion loss + Cable loss
 6. Emission Level = Correction Factor + Reading Value.

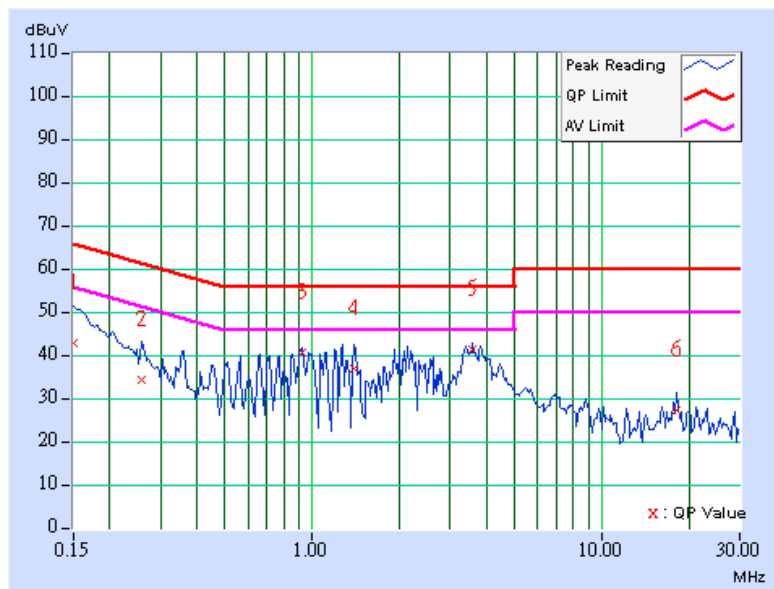



4.2 RADIATED EMISSION MEASUREMENT

4.2.1 LIMITS OF RADIATED EMISSION MEASUREMENT

Emissions radiated outside of the specified bands, shall be according to the general radiated limits in 15.209 as following:

Frequencies (MHz)	Field strength (microvolts/meter)	Measurement distance (meters)
0.009-0.490	2400/F(kHz)	300
0.490-1.705	24000/F(kHz)	30
1.705-30.0	30	30
30-88	100	3
88-216	150	3
216-960	200	3
Above 960	500	3

NOTE:

1. The lower limit shall apply at the transition frequencies.
2. Emission level (dBuV/m) = 20 log Emission level (uV/m).
3. As shown in 15.35(b), for frequencies above 1000MHz, the field strength limits are based on average detector, however, the peak field strength of any emission shall not exceed the maximum permitted average limits, specified above by more than 20dB under any condition of modulation.



4.2.2 LIMITS OF UNWANTED EMISSION OUT OF THE RESTRICTED BANDS

Frequencies (MHz)	EIRP Limit (dBm)	Equivalent Field Strength at 3m (dB μ V/m) *note 3
5150~5250	-27	68.3
5250~5350	-27	68.3
5725~5825	-27 *note 1	68.3
	-17 *note 2	78.3

NOTE:

1. For frequencies 10MHz or greater above or below the band edge.
2. All emissions within the frequency range from the band edge to 10MHz above or below the band edge.
3. The following formula is used to convert the equipment isotropic radiated power (eirp) to field strength

$$E = \frac{1000000\sqrt{30P}}{3} \mu\text{V/m, where P is the eirp (Watts)}$$



4.2.3 TEST INSTRUMENTS

DESCRIPTION & MANUFACTURER	MODEL NO.	SERIAL NO.	CALIBRATED UNTIL
Test Receiver ROHDE & SCHWARZ	ESIB7	100188	Dec. 19, 2005
Spectrum Analyzer ROHDE & SCHWARZ	FSP40	100039	Nov. 21, 2005
BILOG Antenna SCHWARZBECK	VULB9168	9168-157	Jan. 22, 2006
HORN Antenna SCHWARZBECK	BBHA 9120 D	9120D-407	Jan. 16, 2006
HORN Antenna SCHWARZBECK	BBHA 9170	BBHA 9170241	Feb. 23, 2006
Preamplifier Agilent	8449B	3008A01961	Nov. 09, 2005
Preamplifier Agilent	8447D	2944A10629	Nov. 09, 2005
RF signal cable HUBER+SUHNER	SUCOFLEX 104	218182/4	Feb. 17, 2006
RF signal cable HUBER+SUHNER	SUCOFLEX 104	218194/4	Feb. 17, 2006
Software ADT.	ADT_Radiated_V5.14	NA	NA
Antenna Tower ADT.	AT100	AT93021702	NA
Turn Table ADT.	TT100.	TT93021702	NA
Controller ADT.	SC100.	SC93021702	NA

- NOTE:** 1. The calibration interval of the above test instruments is 12 months and the calibrations are traceable to NML/ROC and NIST/USA.
2. The test was performed in HwaYa Chamber 1.
3. The horn antenna and HP preamplifier (model: 8449B) are used only for the measurement of emission frequency above 1GHz if tested.
4. The IC Site Registration No. is IC4924-2.



4.2.4 TEST PROCEDURES

- a. The EUT was placed on the top of a rotating table 0.8 meters above the ground at a 3 meter semi-anechoic chamber. The table was rotated 360 degrees to determine the position of the highest radiation.
- b. The EUT was set 3 meters away from the interference-receiving antenna, which was mounted on the top of a variable-height antenna tower.
- c. The antenna is a broadband antenna, and its height is varied from one meter to four meters above the ground to determine the maximum value of the field strength. Both horizontal and vertical polarizations of the antenna are set to make the measurement.
- d. For each suspected emission, the EUT was arranged to its worst case and then the antenna was tuned to heights from 1 meter to 4 meters and the rotatable table was turned from 0 degrees to 360 degrees to find the maximum reading.
- e. The test-receiver system was set to Peak Detect Function and Specified Bandwidth with Maximum Hold Mode.
- f. If the emission level of the EUT in peak mode was lower than the limit specified, then testing could be stopped and the peak values of the EUT would be reported. Otherwise the emissions would be re-tested one by one using peak, quasi-peak or average method as specified and then reported in a data sheet.

NOTE:

1. The resolution bandwidth and video bandwidth of test receiver/spectrum analyzer is 120kHz for Peak detection (PK) and Quasi-peak detection (QP) at frequency below 1GHz.
2. The resolution bandwidth and video bandwidth of test receiver/spectrum analyzer is 1 MHz for Peak detection at frequency above 1GHz.
3. The resolution bandwidth of test receiver/spectrum analyzer is 1 MHz and the video bandwidth is 10 Hz for Average detection (AV) at frequency above 1GHz.

4.2.5 DEVIATION FROM TEST STANDARD

No deviation

4.2.6 TEST SETUP

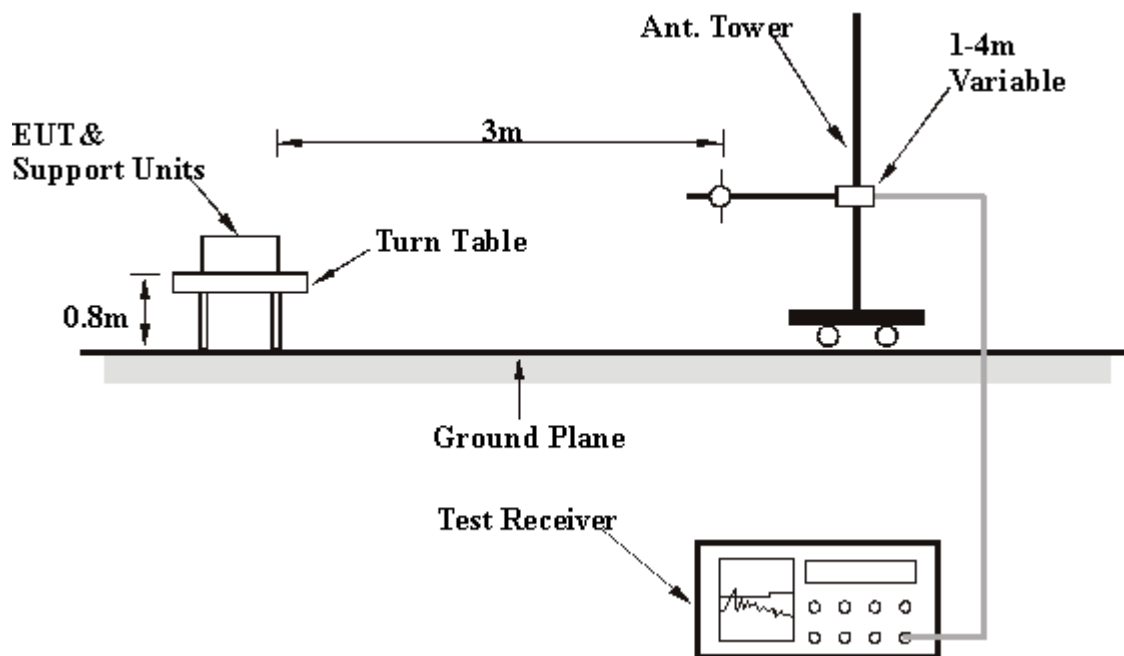

For the actual test configuration, please refer to the related item – Photographs of the Test Configuration.

4.2.7 EUT OPERATING CONDITION

Same as 4.1.6

4.2.8 TEST RESULTS

Below 1GHz Worst-Case Data

EUT	Wireless 11a+g Dual-Band Access Point	MEASUREMENT DETAIL	
MODEL	WX-7800A	FREQUENCY RANGE	Below 1000MHz
CHANNEL	Channel 8	DETECTOR FUNCTION	Quasi-Peak
MODULATION TYPE	BPSK	ENVIRONMENTAL CONDITIONS	26deg. C, 69%RH, 991hPa
TRANSFER RATE	6Mbps	INPUT POWER (SYSTEM)	120Vac, 60 Hz
TESTED BY	William Chien		

ANTENNA POLARITY & TEST DISTANCE: HORIZONTAL AT 3 M

No.	Freq. (MHz)	Emission Level (dBuV/m)	Limit (dBuV/m)	Margin (dB)	Antenna Height (m)	Table Angle (Degree)	Raw Value (dBuV)	Correction Factor (dB/m)
1	53.33	26.63 QP	40.00	-13.37	2.00 H	229	12.50	14.13
2	84.43	27.71 QP	40.00	-12.29	2.00 H	31	17.88	9.84
3	218.56	34.95 QP	46.00	-11.05	2.00 H	43	23.36	11.59
4	249.66	32.56 QP	46.00	-13.44	1.00 H	7	19.48	13.08
5	329.36	35.91 QP	46.00	-10.09	1.00 H	331	20.91	14.99
6	440.16	33.88 QP	46.00	-12.12	2.00 H	238	16.22	17.66
7	500.42	33.87 QP	46.00	-12.13	1.50 H	37	15.28	18.59
8	550.96	35.68 QP	46.00	-10.32	1.50 H	298	16.05	19.63
9	770.62	33.25 QP	46.00	-12.75	1.00 H	247	9.72	23.53

ANTENNA POLARITY & TEST DISTANCE: VERTICAL AT 3 M

No.	Freq. (MHz)	Emission Level (dBuV/m)	Limit (dBuV/m)	Margin (dB)	Antenna Height (m)	Table Angle (Degree)	Raw Value (dBuV)	Correction Factor (dB/m)
1	53.33	37.16 QP	40.00	-2.84	1.50 V	154	23.03	14.13
2	109.70	41.47 QP	43.50	-2.03	1.00 V	241	29.73	11.74
3	158.30	32.15 QP	43.50	-11.35	1.00 V	313	17.53	14.62
4	218.56	36.25 QP	46.00	-9.75	1.00 V	292	24.66	11.59
5	249.66	33.99 QP	46.00	-12.01	1.50 V	43	20.91	13.08
6	329.36	34.19 QP	46.00	-11.81	1.50 V	61	19.19	14.99
7	440.16	32.17 QP	46.00	-13.83	1.00 V	34	14.51	17.66
8	550.96	37.83 QP	46.00	-8.17	1.00 V	256	18.20	19.63
9	599.56	31.62 QP	46.00	-14.38	1.00 V	355	10.74	20.88
10	770.62	34.81 QP	46.00	-11.19	1.50 V	262	11.28	23.53
11	881.42	32.57 QP	46.00	-13.43	1.00 V	55	7.83	24.74

- REMARKS:**
1. Emission level(dBuV/m)=Raw Value(dBuV) + Correction Factor(dB/m)
 2. Correction Factor(dB/m) = Antenna Factor (dB/m) + Cable Factor (dB)
 3. The other emission levels were very low against the limit.
 4. Margin value = Emission level – Limit value

**802.11a OFDM modulation**

EUT	Wireless 11a+g Dual-Band Access Point	MEASUREMENT DETAIL	
MODEL	WX-7800A	FREQUENCY RANGE	1 ~ 40 GHz
CHANNEL	Channel 1	DETECTOR FUNCTION	Peak(PK) Average (AV)
MODULATION TYPE	BPSK	ENVIRONMENTAL CONDITIONS	25deg. C, 60%RH, 991hPa
TRANSFER RATE	6Mbps	INPUT POWER (SYSTEM)	120Vac, 60 Hz
TESTED BY	Match Tsui		

ANTENNA POLARITY & TEST DISTANCE: HORIZONTAL AT 3 M

No.	Freq. (MHz)	Emission Level (dBuV/m)	Limit (dBuV/m)	Margin (dB)	Antenna Height (m)	Table Angle (Degree)	Raw Value (dBuV)	Correction Factor (dB/m)
1	#1120.00	48.08 PK	74.00	-25.92	1.31 H	103	21.32	26.76
1	#1120.00	44.97 AV	54.00	-9.03	1.31 H	103	18.21	26.76
2	3453.00	42.03 PK	68.30	-26.27	1.12 H	90	6.45	35.58
3	#5150.00	44.17 PK	74.00	-29.83	1.05 H	124	5.07	39.10
3	#5150.00	34.08 AV	54.00	-19.92	1.05 H	124	-5.02	39.10
4	*5180.00	103.06 PK			1.05 H	124	63.89	39.17
4	*5180.00	92.67 AV			1.05 H	124	53.50	39.17
5	10360.00	61.21 PK	68.30	-7.09	1.21 H	82	15.92	45.29

ANTENNA POLARITY & TEST DISTANCE: VERTICAL AT 3 M

No.	Freq. (MHz)	Emission Level (dBuV/m)	Limit (dBuV/m)	Margin (dB)	Antenna Height (m)	Table Angle (Degree)	Raw Value (dBuV)	Correction Factor (dB/m)
1	#1120.00	47.33 PK	74.00	-26.67	1.00 V	330	20.57	26.76
1	#1120.00	44.14 AV	54.00	-9.86	1.00 V	330	17.38	26.76
2	3453.00	45.56 PK	68.30	-22.74	1.02 V	218	9.98	35.58
3	#5150.00	52.09 PK	74.00	-21.91	1.04 V	21	12.99	39.10
3	#5150.00	42.18 AV	54.00	-11.82	1.04 V	21	3.08	39.10
4	*5180.00	110.98 PK			1.04 V	21	71.81	39.17
4	*5180.00	101.07 AV			1.04 V	21	61.90	39.17
5	10360.00	65.23 PK	68.30	-3.07	1.00 V	190	19.94	45.29

- NOTE:**
1. Emission level(dBuV/m)=Raw Value(dBuV) + Correction Factor(dB/m)
 2. Correction Factor(dB/m) = Antenna Factor (dB/m) + Cable Factor (dB)
 3. The other emission levels were very low against the limit.
 4. Margin value = Emission level – Limit value
 5. "*" : Fundamental frequency
 6. "#" The radiated frequency falling in the restricted band.



EUT	Wireless 11a+g Dual-Band Access Point	MEASUREMENT DETAIL	
MODEL	WX-7800A	FREQUENCY RANGE	1 ~ 40 GHz
CHANNEL	Channel 4	DETECTOR FUNCTION	Peak(PK) Average (AV)
MODULATION TYPE	BPSK	ENVIRONMENTAL CONDITIONS	25deg. C, 60%RH, 991hPa
TRANSFER RATE	6Mbps	INPUT POWER (SYSTEM)	120Vac, 60 Hz
TESTED BY	Match Tsui		

ANTENNA POLARITY & TEST DISTANCE: HORIZONTAL AT 3 M

No.	Freq. (MHz)	Emission Level (dBuV/m)	Limit (dBuV/m)	Margin (dB)	Antenna Height (m)	Table Angle (Degree)	Raw Value (dBuV)	Correction Factor (dB/m)
1	#1120.00	47.15 PK	74.00	-26.85	1.33 H	103	20.39	26.76
1	#1120.00	44.62 AV	54.00	-9.38	1.33 H	103	17.86	26.76
2	3493.00	49.26 PK	68.30	-19.04	1.11 H	280	13.57	35.70
3	*5240.00	102.14 PK			1.04 H	127	62.96	39.18
3	*5240.00	92.50 AV			1.04 H	127	53.32	39.18
4	10480.00	60.34 PK	68.30	-7.96	1.16 H	207	14.25	46.08

ANTENNA POLARITY & TEST DISTANCE: VERTICAL AT 3 M

No.	Freq. (MHz)	Emission Level (dBuV/m)	Limit (dBuV/m)	Margin (dB)	Antenna Height (m)	Table Angle (Degree)	Raw Value (dBuV)	Correction Factor (dB/m)
1	#1120.00	46.22 PK	74.00	-27.78	1.00 V	326	19.46	26.76
1	#1120.00	43.32 AV	54.00	-10.68	1.00 V	326	16.56	26.76
2	3493.00	49.77 PK	68.30	-18.53	1.00 V	121	14.08	35.70
3	*5240.00	111.79 PK			1.05 V	18	72.61	39.18
3	*5240.00	101.86 AV			1.05 V	18	62.68	39.18
4	10480.00	63.64 PK	68.30	-4.66	1.19 V	299	17.55	46.08

- NOTE:**
1. Emission level(dBuV/m)=Raw Value(dBuV) + Correction Factor(dB/m)
 2. Correction Factor(dB/m) = Antenna Factor (dB/m) + Cable Factor (dB)
 3. The other emission levels were very low against the limit.
 4. Margin value = Emission level – Limit value
 5. "*" : Fundamental frequency
 6. "#" The radiated frequency falling in the restricted band.



EUT	Wireless 11a+g Dual-Band Access Point	MEASUREMENT DETAIL	
MODEL	WX-7800A	FREQUENCY RANGE	1 ~ 40 GHz
CHANNEL	Channel 5	DETECTOR FUNCTION	Peak(PK) Average (AV)
MODULATION TYPE	BPSK	ENVIRONMENTAL CONDITIONS	25deg. C, 60%RH, 991hPa
TRANSFER RATE	6Mbps	INPUT POWER (SYSTEM)	120Vac, 60 Hz
TESTED BY	Match Tsui		

ANTENNA POLARITY & TEST DISTANCE: HORIZONTAL AT 3 M

No.	Freq. (MHz)	Emission Level (dBuV/m)	Limit (dBuV/m)	Margin (dB)	Antenna Height (m)	Table Angle (Degree)	Raw Value (dBuV)	Correction Factor (dB/m)
1	#1120.00	46.21 PK	74.00	-27.79	1.09 H	16	19.45	26.76
1	#1120.00	43.48 AV	54.00	-10.69	1.09 H	16	16.55	26.76
2	3506.00	48.79 PK	68.30	-19.51	1.12 H	217	13.05	35.73
3	*5260.00	102.69 PK			1.14 H	126	63.53	39.16
3	*5260.00	92.62 AV			1.14 H	126	53.46	39.16
4	10520.00	58.02 PK	68.30	-10.28	1.07 H	256	11.87	46.16

ANTENNA POLARITY & TEST DISTANCE: VERTICAL AT 3 M

No.	Freq. (MHz)	Emission Level (dBuV/m)	Limit (dBuV/m)	Margin (dB)	Antenna Height (m)	Table Angle (Degree)	Raw Value (dBuV)	Correction Factor (dB/m)
1	#1120.00	46.98 PK	74.00	-27.02	1.00 V	330	20.22	26.76
1	#1120.00	43.48 AV	54.00	-10.52	1.00 V	330	16.72	26.76
2	3506.00	50.63 PK	68.30	-17.67	1.00 V	304	14.89	35.73
3	*5260.00	110.46 PK			1.03 V	1	71.30	39.16
3	*5260.00	100.81 AV			1.03 V	1	61.65	39.16
4	10520.00	64.59 PK	68.30	-3.71	1.02 V	186	18.44	46.16

- NOTE:**
1. Emission level(dBuV/m)=Raw Value(dBuV) + Correction Factor(dB/m)
 2. Correction Factor(dB/m) = Antenna Factor (dB/m) + Cable Factor (dB)
 3. The other emission levels were very low against the limit.
 4. Margin value = Emission level – Limit value
 5. "*" : Fundamental frequency
 6. "#"The radiated frequency falling in the restricted band.



EUT	Wireless 11a+g Dual-Band Access Point	MEASUREMENT DETAIL	
MODEL	WX-7800A	FREQUENCY RANGE	1 ~ 40 GHz
CHANNEL	Channel 8	DETECTOR FUNCTION	Peak(PK) Average (AV)
MODULATION TYPE	BPSK	ENVIRONMENTAL CONDITIONS	25deg. C, 60%RH, 991hPa
TRANSFER RATE	6Mbps	INPUT POWER (SYSTEM)	120Vac, 60 Hz
TESTED BY	Match Tsui		

ANTENNA POLARITY & TEST DISTANCE: HORIZONTAL AT 3 M

No.	Freq. (MHz)	Emission Level (dBuV/m)	Limit (dBuV/m)	Margin (dB)	Antenna Height (m)	Table Angle (Degree)	Raw Value (dBuV)	Correction Factor (dB/m)
1	#1120.00	45.45 PK	74.00	-28.55	1.26 H	103	18.69	26.76
1	#1120.00	44.69 AV	54.00	-9.31	1.26 H	103	17.93	26.76
2	3546.00	40.50 PK	68.30	-27.80	1.24 H	191	4.65	35.85
3	*5320.00	102.73 PK			1.00 H	128	63.58	39.15
3	*5320.00	92.70 AV			1.00 H	128	53.55	39.15
4	#5350.00	43.25 PK	74.00	-30.75	1.00 H	128	4.05	39.20
4	#5350.00	33.22 AV	54.00	-20.78	1.00 H	128	-5.98	39.20
5	#10640.00	60.78 PK	74.00	-13.22	1.12 H	131	14.55	46.23
5	#10640.00	48.13 AV	54.00	-5.87	1.12 H	131	1.90	46.23

ANTENNA POLARITY & TEST DISTANCE: VERTICAL AT 3 M

No.	Freq. (MHz)	Emission Level (dBuV/m)	Limit (dBuV/m)	Margin (dB)	Antenna Height (m)	Table Angle (Degree)	Raw Value (dBuV)	Correction Factor (dB/m)
1	#1120.00	46.53 PK	74.00	-27.47	1.00 V	329	19.77	26.76
1	#1120.00	43.48 AV	54.00	-10.52	1.00 V	329	16.72	26.76
2	3546.00	49.92 PK	68.30	-18.38	1.18 V	323	14.07	35.85
3	*5320.00	112.29 PK			1.15 V	20	73.14	39.15
3	*5320.00	102.68 AV			1.15 V	20	63.53	39.15
4	#5350.00	52.81 PK	74.00	-21.19	1.15 V	20	13.61	39.20
4	#5350.00	43.20 AV	54.00	-10.80	1.15 V	20	4.00	39.20
5	#10640.00	61.88 PK	74.00	-12.12	1.17 V	297	15.65	46.23
5	#10640.00	49.18 AV	54.00	-4.82	1.17 V	297	2.95	46.23
6	#15960.00	60.67 PK	74.00	-13.33	1.15 V	231	15.71	44.96
6	#15960.00	47.80 AV	54.00	-6.20	1.15 V	231	2.84	44.96

- NOTE:**
1. Emission level(dBuV/m)=Raw Value(dBuV) + Correction Factor(dB/m)
 2. Correction Factor(dB/m) = Antenna Factor (dB/m) + Cable Factor (dB)
 3. The other emission levels were very low against the limit.
 4. Margin value = Emission level – Limit value
 5. "*" : Fundamental frequency
 6. "#" The radiated frequency falling in the restricted band.

**802.11a Turbo OFDM modulation**

EUT	Wireless 11a+g Dual-Band Access Point	MEASUREMENT DETAIL	
MODEL	WX-7800A	FREQUENCY RANGE	1 ~ 40 GHz
CHANNEL	Channel 1	DETECTOR FUNCTION	Peak(PK) Average (AV)
MODULATION TYPE	BPSK	ENVIRONMENTAL CONDITIONS	25deg. C, 60%RH, 991hPa
TRANSFER RATE	12Mbps	INPUT POWER (SYSTEM)	120Vac, 60 Hz
TESTED BY	Match Tsui		

ANTENNA POLARITY & TEST DISTANCE: HORIZONTAL AT 3 M

No.	Freq. (MHz)	Emission Level (dBuV/m)	Limit (dBuV/m)	Margin (dB)	Antenna Height (m)	Table Angle (Degree)	Raw Value (dBuV)	Correction Factor (dB/m)
1	#1120.00	50.27 PK	74.00	-23.73	1.31 H	96	23.51	26.76
1	#1120.00	48.42 AV	54.00	-5.58	1.31 H	96	21.66	26.76
2	#5150.00	53.19 PK	74.00	-20.81	1.04 H	127	14.09	39.10
2	#5150.00	42.92 AV	54.00	-11.08	1.04 H	127	3.82	39.10
3	*5210.00	100.32 PK			1.04 H	127	61.11	39.21
3	*5210.00	90.05 AV			1.04 H	127	50.84	39.21
4	10420.00	59.47 PK	68.30	-8.83	1.18 H	204	13.70	45.77

ANTENNA POLARITY & TEST DISTANCE: VERTICAL AT 3 M

No.	Freq. (MHz)	Emission Level (dBuV/m)	Limit (dBuV/m)	Margin (dB)	Antenna Height (m)	Table Angle (Degree)	Raw Value (dBuV)	Correction Factor (dB/m)
1	#1120.00	46.64 PK	74.00	-27.36	1.00 V	331	19.88	26.76
1	#1120.00	43.14 AV	54.00	-10.86	1.00 V	331	16.38	26.76
2	3474.00	49.89 PK	74.00	-24.11	1.00 V	304	14.25	35.64
2	3474.00	42.29 AV	54.00	-11.71	1.00 V	304	6.65	35.64
3	#5150.00	63.30 PK	74.00	-10.70	1.06 V	131	24.20	39.10
3	#5150.00	53.00 AV	54.00	-1.00	1.06 V	131	13.90	39.10
4	*5210.00	110.34 PK			1.06 V	131	71.13	39.21
4	*5210.00	100.13 AV			1.06 V	131	60.92	39.21
5	10420.00	64.28 PK	68.30	-4.02	1.10 V	191	18.51	45.77

- NOTE:**
1. Emission level(dBuV/m)=Raw Value(dBuV) + Correction Factor(dB/m)
 2. Correction Factor(dB/m) = Antenna Factor (dB/m) + Cable Factor (dB)
 3. The other emission levels were very low against the limit.
 4. Margin value = Emission level – Limit value
 5. "*" : Fundamental frequency
 6. "#" The radiated frequency falling in the restricted band.



EUT	Wireless 11a+g Dual-Band Access Point	MEASUREMENT DETAIL	
MODEL	WX-7800A	FREQUENCY RANGE	1 ~ 40 GHz
CHANNEL	Channel 2	DETECTOR FUNCTION	Peak(PK) Average (AV)
MODULATION TYPE	BPSK	ENVIRONMENTAL CONDITIONS	25deg. C, 60%RH, 991hPa
TRANSFER RATE	12Mbps	INPUT POWER (SYSTEM)	120Vac, 60 Hz
TESTED BY	Match Tsui		

ANTENNA POLARITY & TEST DISTANCE: HORIZONTAL AT 3 M

No.	Freq. (MHz)	Emission Level (dBuV/m)	Limit (dBuV/m)	Margin (dB)	Antenna Height (m)	Table Angle (Degree)	Raw Value (dBuV)	Correction Factor (dB/m)
1	#1120.00	50.18 PK	74.00	-23.82	1.25 H	97	23.42	26.76
1	#1120.00	48.28 AV	54.00	-5.72	1.25 H	97	21.52	26.76
2	*5250.00	99.03 PK			1.15 H	124	59.86	39.17
2	*5250.00	89.62 AV			1.15 H	124	50.45	39.17
3	10500.00	56.97 PK	68.30	-11.33	1.01 H	254	10.78	46.19

ANTENNA POLARITY & TEST DISTANCE: VERTICAL AT 3 M

No.	Freq. (MHz)	Emission Level (dBuV/m)	Limit (dBuV/m)	Margin (dB)	Antenna Height (m)	Table Angle (Degree)	Raw Value (dBuV)	Correction Factor (dB/m)
1	#1120.00	47.50 PK	74.00	-26.50	1.48 V	360	20.74	26.76
1	#1120.00	44.49 AV	54.00	-9.51	1.48 V	360	17.73	26.76
2	3500.00	43.81 PK	68.30	-24.49	1.37 V	6	8.09	35.72
3	*5250.00	110.01 PK			1.05 V	360	70.84	39.17
3	*5250.00	99.32 AV			1.05 V	360	60.15	39.17
4	10500.00	60.29 PK	68.30	-8.01	1.02 V	6	14.10	46.19

- NOTE:**
1. Emission level(dBuV/m)=Raw Value(dBuV) + Correction Factor(dB/m)
 2. Correction Factor(dB/m) = Antenna Factor (dB/m) + Cable Factor (dB)
 3. The other emission levels were very low against the limit.
 4. Margin value = Emission level – Limit value
 5. "*" : Fundamental frequency
 6. "#"The radiated frequency falling in the restricted band.



EUT	Wireless 11a+g Dual-Band Access Point	MEASUREMENT DETAIL	
MODEL	WX-7800A	FREQUENCY RANGE	1 ~ 40 GHz
CHANNEL	Channel 3	DETECTOR FUNCTION	Peak(PK) Average (AV)
MODULATION TYPE	BPSK	ENVIRONMENTAL CONDITIONS	25deg. C, 60%RH, 991hPa
TRANSFER RATE	12Mbps	INPUT POWER (SYSTEM)	120Vac, 60 Hz
TESTED BY	Match Tsui		

ANTENNA POLARITY & TEST DISTANCE: HORIZONTAL AT 3 M

No.	Freq. (MHz)	Emission Level (dBuV/m)	Limit (dBuV/m)	Margin (dB)	Antenna Height (m)	Table Angle (Degree)	Raw Value (dBuV)	Correction Factor (dB/m)
1	#1120.00	49.92 PK	74.00	-24.08	1.32 H	96	23.16	26.76
1	#1120.00	48.23 AV	54.00	-5.77	1.32 H	96	21.47	26.76
2	*5290.00	101.49 PK			1.03 H	127	62.36	39.13
2	*5290.00	92.31 AV			1.03 H	127	53.18	39.13
3	10580.00	56.64 PK	68.30	-11.66	1.11 H	329	10.57	46.07

ANTENNA POLARITY & TEST DISTANCE: VERTICAL AT 3 M

No.	Freq. (MHz)	Emission Level (dBuV/m)	Limit (dBuV/m)	Margin (dB)	Antenna Height (m)	Table Angle (Degree)	Raw Value (dBuV)	Correction Factor (dB/m)
1	#1120.00	47.32 PK	74.00	-26.68	1.00 V	2	20.56	26.76
1	#1120.00	44.59 AV	54.00	-9.41	1.00 V	2	17.83	26.76
2	3526.00	50.04 PK	68.30	-18.26	1.23 V	340	14.25	35.79
3	*5290.00	110.13 PK			1.15 V	357	70.96	39.17
3	*5290.00	101.04 AV			1.15 V	357	61.87	39.17
4	10580.00	56.38 PK	68.30	-11.92	1.09 V	123	10.25	46.13

- NOTE:**
1. Emission level(dBuV/m)=Raw Value(dBuV) + Correction Factor(dB/m)
 2. Correction Factor(dB/m) = Antenna Factor (dB/m) + Cable Factor (dB)
 3. The other emission levels were very low against the limit.
 4. Margin value = Emission level – Limit value
 5. "*" : Fundamental frequency
 6. "#":The radiated frequency falling in the restricted band.



4.3 PEAK TRANSMIT POWER MEASUREMENT

4.3.1 LIMITS OF PEAK TRANSMIT POWER MEASUREMENT

Frequency Band	Limit
5.15 – 5.25GHz	The lesser of 50mW (17dBm) or 4dBm + 10logB
5.25 – 5.35GHz	The lesser of 250mW (24dBm) or 11dBm + 10logB
5.725 – 5.825GHz	The lesser of 1W (30dBm) or 17dBm + 10logB

NOTE: Where B is the 26dB emission bandwidth in MHz.

4.3.2 TEST INSTRUMENTS

Description & Manufacturer	Model No.	Serial No.	Calibrated Until
R&S SPECTRUM ANALYZER	FSEK30	100049	Aug. 12, 2005

NOTE: The calibration interval of the above test instruments is 12 months and the calibrations are traceable to NML/ROC and NIST/USA.

4.3.3 TEST PROCEDURE

1. The transmitter output was connected to the spectrum analyzer.
2. Set span to encompass the entire emission bandwidth of the signal.
3. Set RBW to 1MHz, VBW to 3MHz.
4. Using the spectrum analyzer's channel power measurement function to measure the output power.

NOTE:

The test is performed in accordance with FCC Public Notice: APPENDIX A Guidelines for Assessing Unlicensed National Information Infrastructure (U-NII) Devices – Part 15, Subpart E, August 2002.

The transmitter output operates continuously therefore Method # 1 is used.

4.3.4 DEVIATION FROM TEST STANDARD

No deviation

4.3.5 TEST SETUP

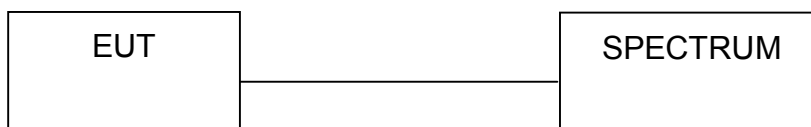

4.3.6 EUT OPERATING CONDITIONS

The software provided by client to enable the EUT under transmission condition continuously at specific channel frequencies individually.



4.3.7 TEST RESULTS

802.11a OFDM modulation

EUT	Wireless 11a+g Dual-Band Access Point	MODEL	WX-7800A
MODULATION TYPE	BPSK	TRANSFER RATE	6Mbps
INPUT POWER (SYSTEM)	120Vac, 60 Hz	ENVIRONMENTAL CONDITIONS	24deg. C, 67%RH, 991hPa
TESTED BY	Leo Hung		

CHANNEL	CHANNEL FREQUENCY (MHz)	PEAK POWER OUTPUT (mW)	PEAK POWER OUTPUT (dBm)	PEAK POWER LIMIT (dBm)	26dBc Occupied Bandwidth (MHz)	PASS/FAIL
1	5180	20.42	13.10	17.00	25.67	PASS
4	5240	20.09	13.03	17.00	25.95	PASS
5	5260	20.00	13.01	24.00	25.74	PASS
8	5320	20.32	13.08	24.00	25.04	PASS

NOTE: The 26dBc Occupied Bandwidth plot, please refer to the following pages.



Peak Power Output:
CH 1

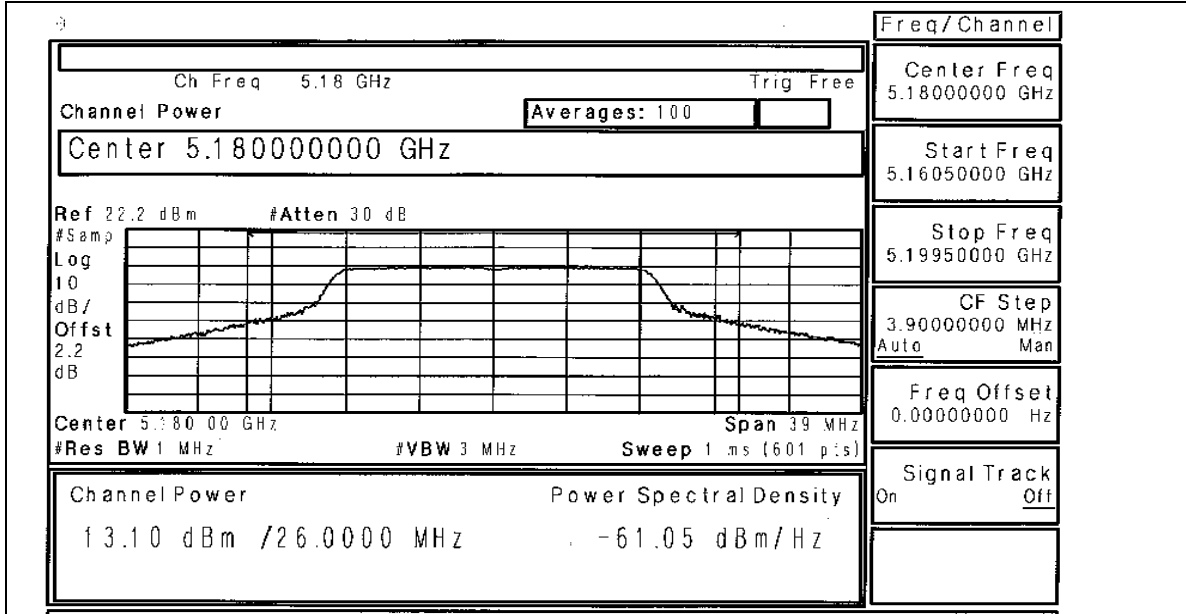

CH 4

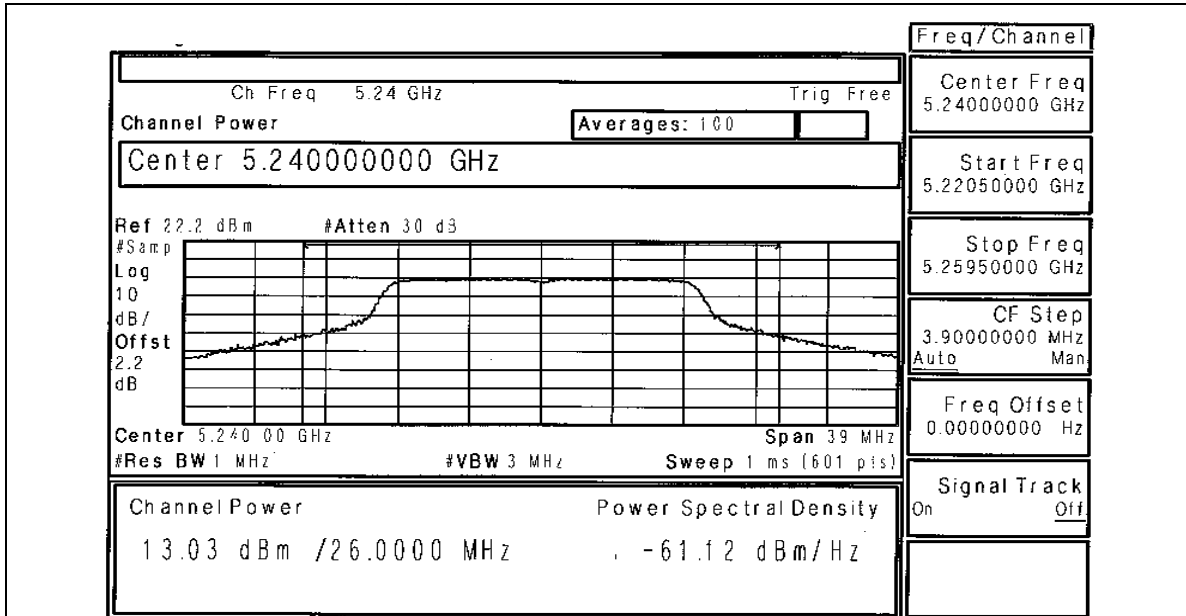



CH 5

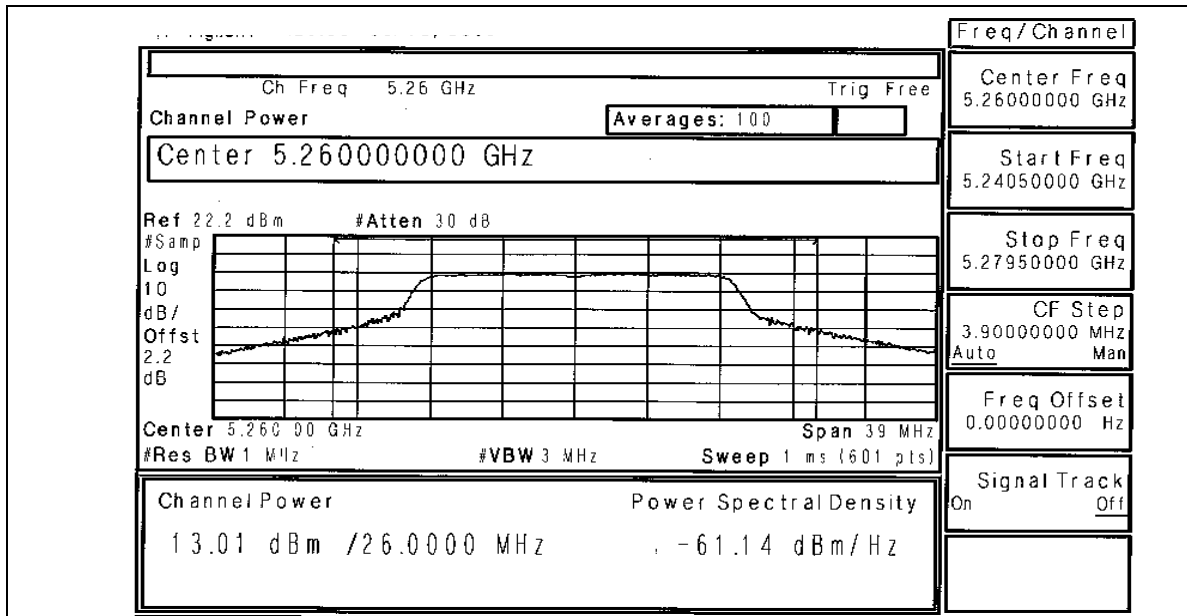

CH 8

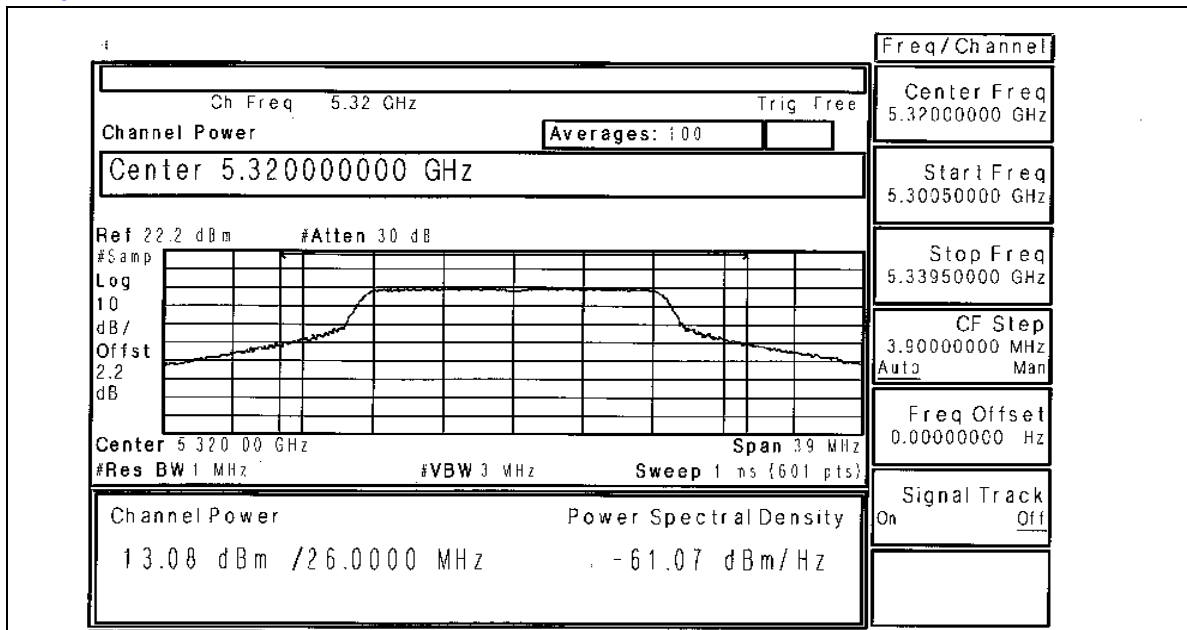



26dB Occupied Bandwidth:
CH 1

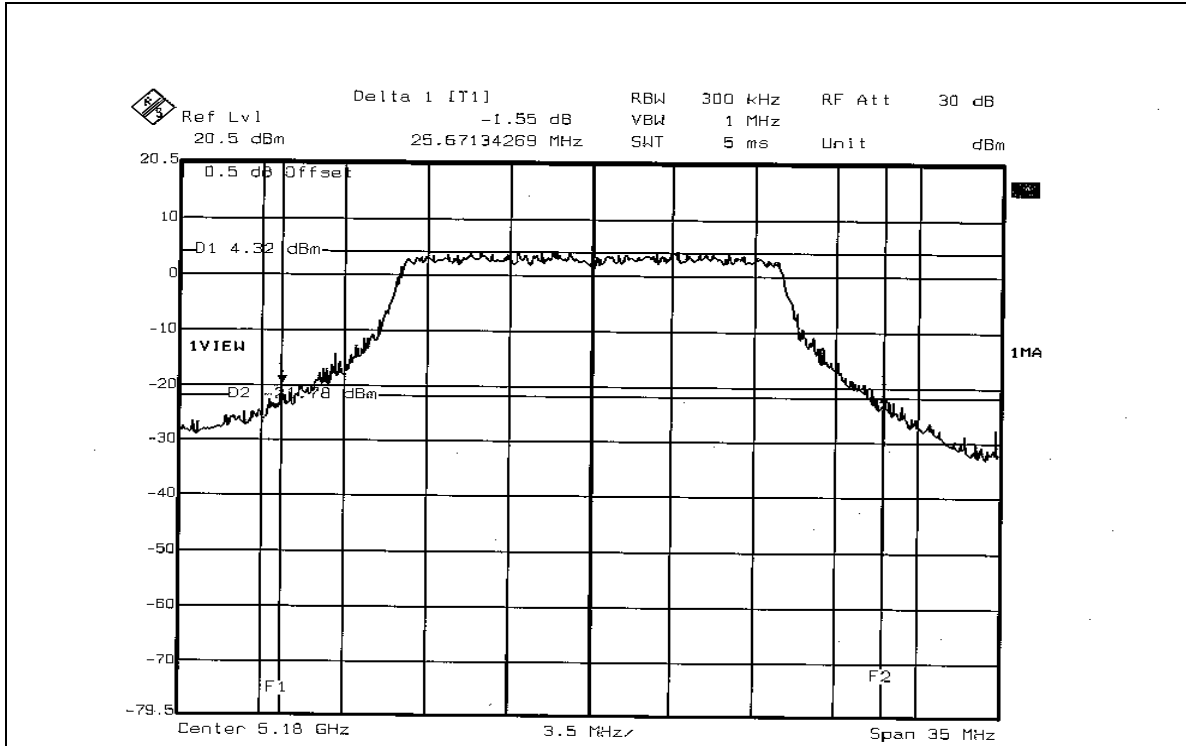

CH 4

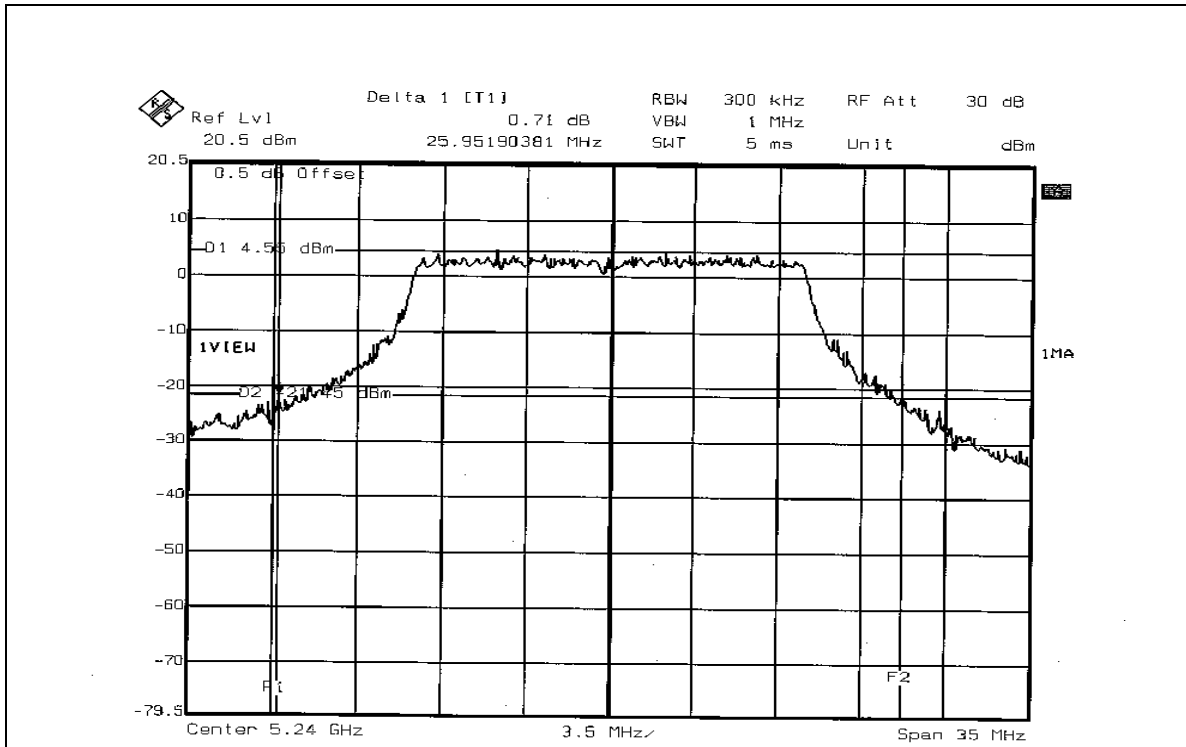



CH 5

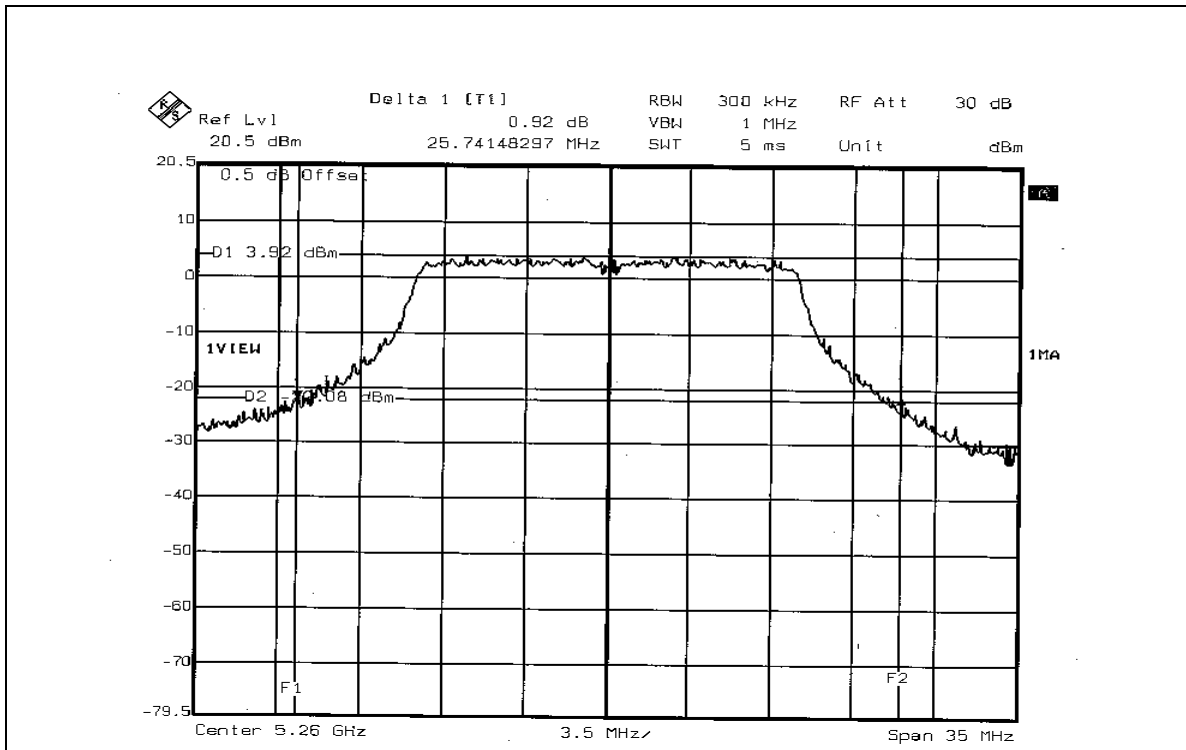

CH 8

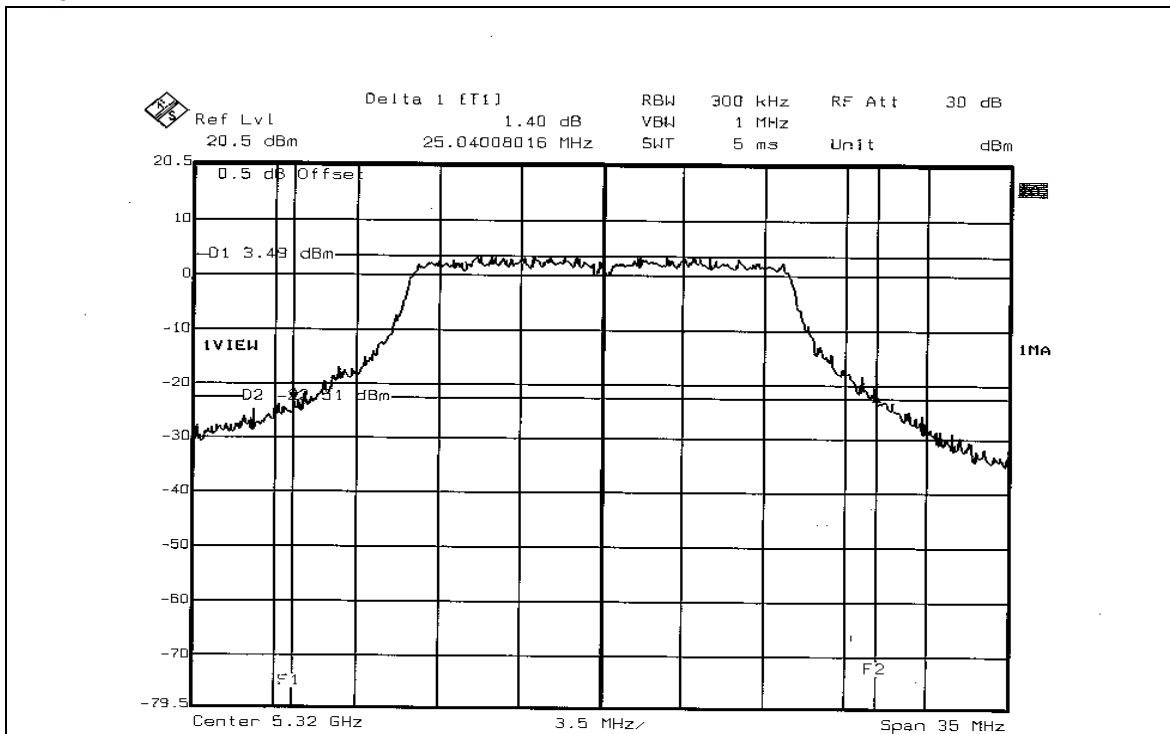

**802.11a Turbo OFDM modulation**

EUT	Wireless 11a+g Dual-Band Access Point	MODEL	WX-7800A
MODULATION TYPE	BPSK	TRANSFER RATE	12Mbps
INPUT POWER (SYSTEM)	120Vac, 60 Hz	ENVIRONMENTAL CONDITIONS	24deg. C, 67%RH, 991hPa
TESTED BY	Leo Hung		

CHANNEL	CHANNEL FREQUENCY (MHz)	PEAK POWER OUTPUT (mW)	PEAK POWER OUTPUT (dBm)	PEAK POWER LIMIT (dBm)	26dBc Occupied Bandwidth (MHz)	PASS/FAIL
1	5210	21.68	13.36	17.00	45.69	PASS
2	5250	22.03	13.43	17.00	48.09	PASS
3	5290	21.88	13.40	24.00	45.81	PASS

NOTE: The 26dBc Occupied Bandwidth plot, please refer to the following pages.



Peak Power Output:
CH 1

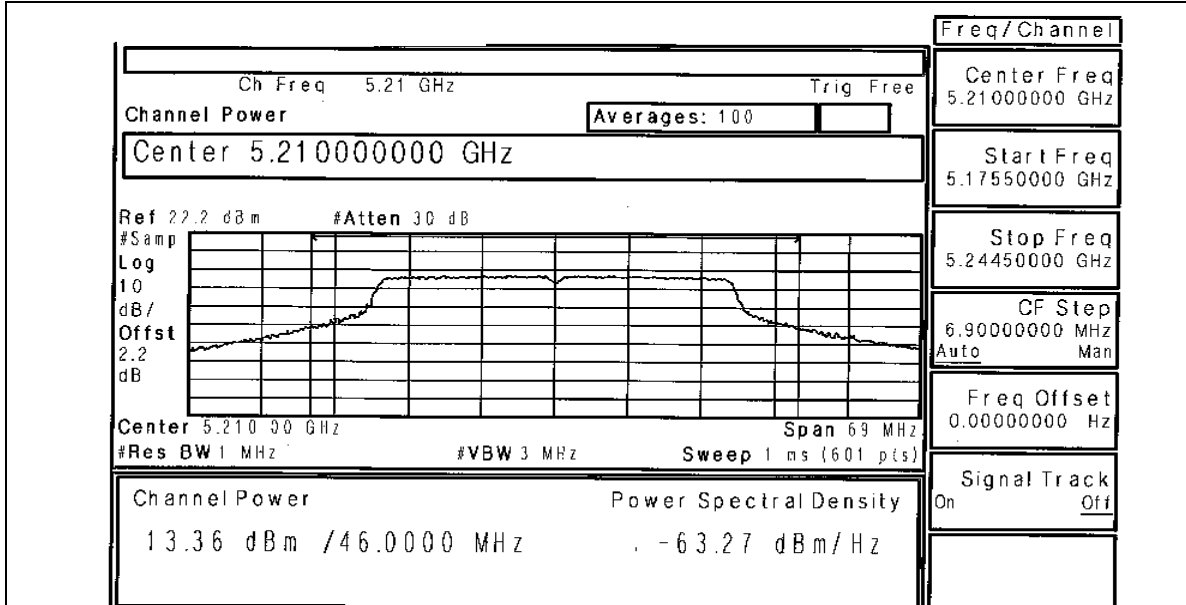

CH 2

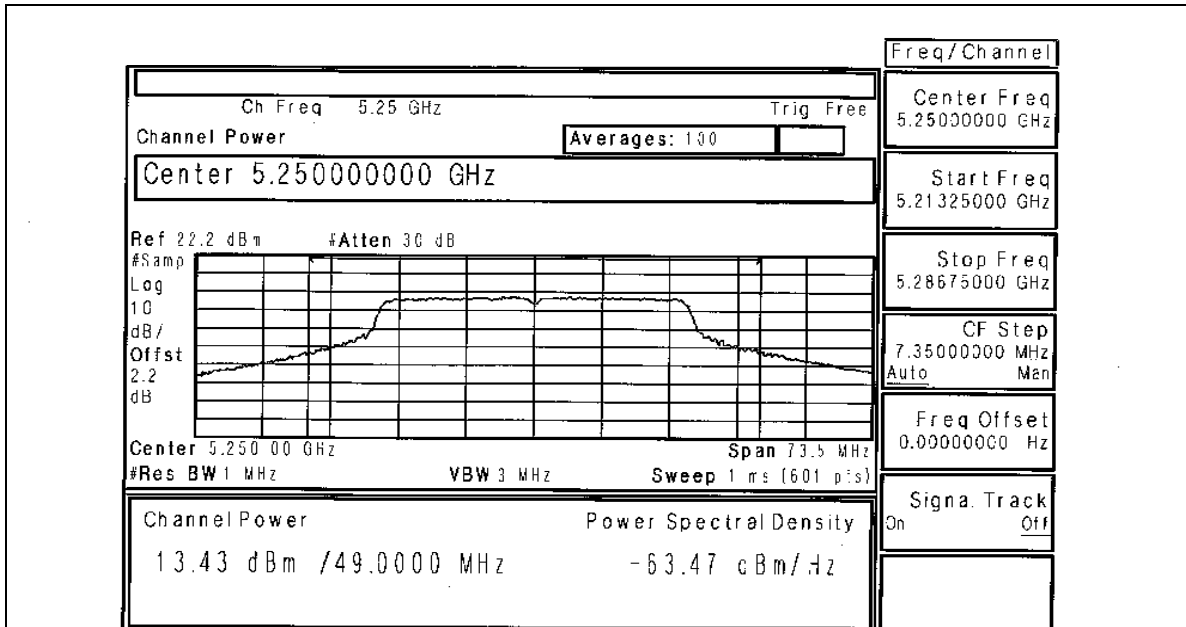



CH 3

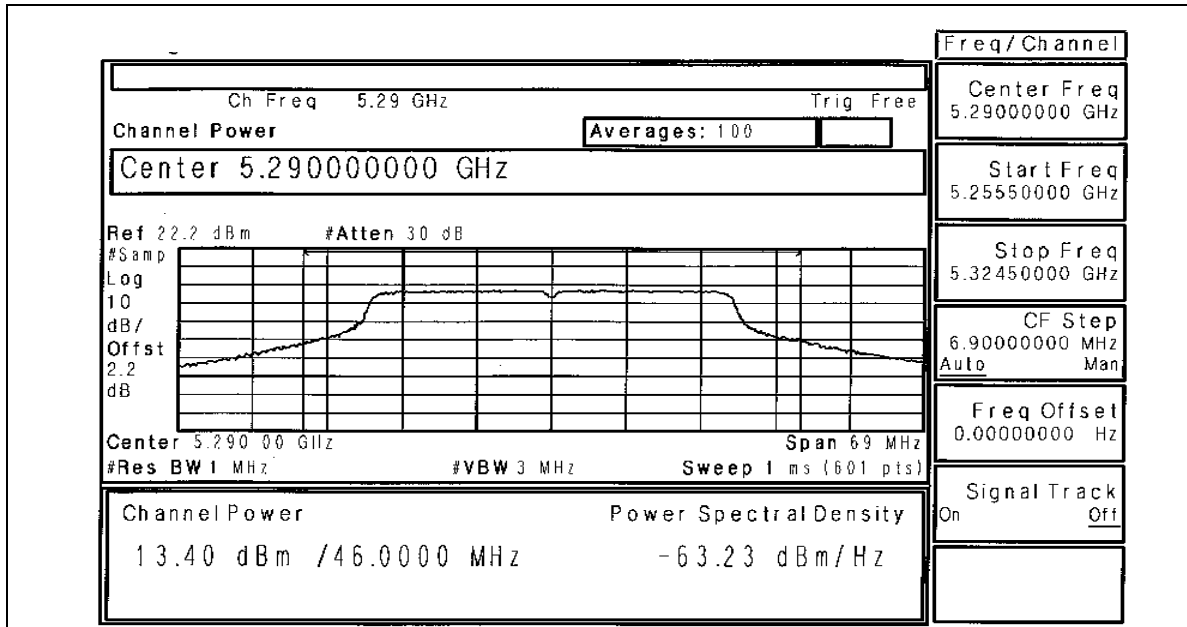



26dB Occupied Bandwidth:
CH 1

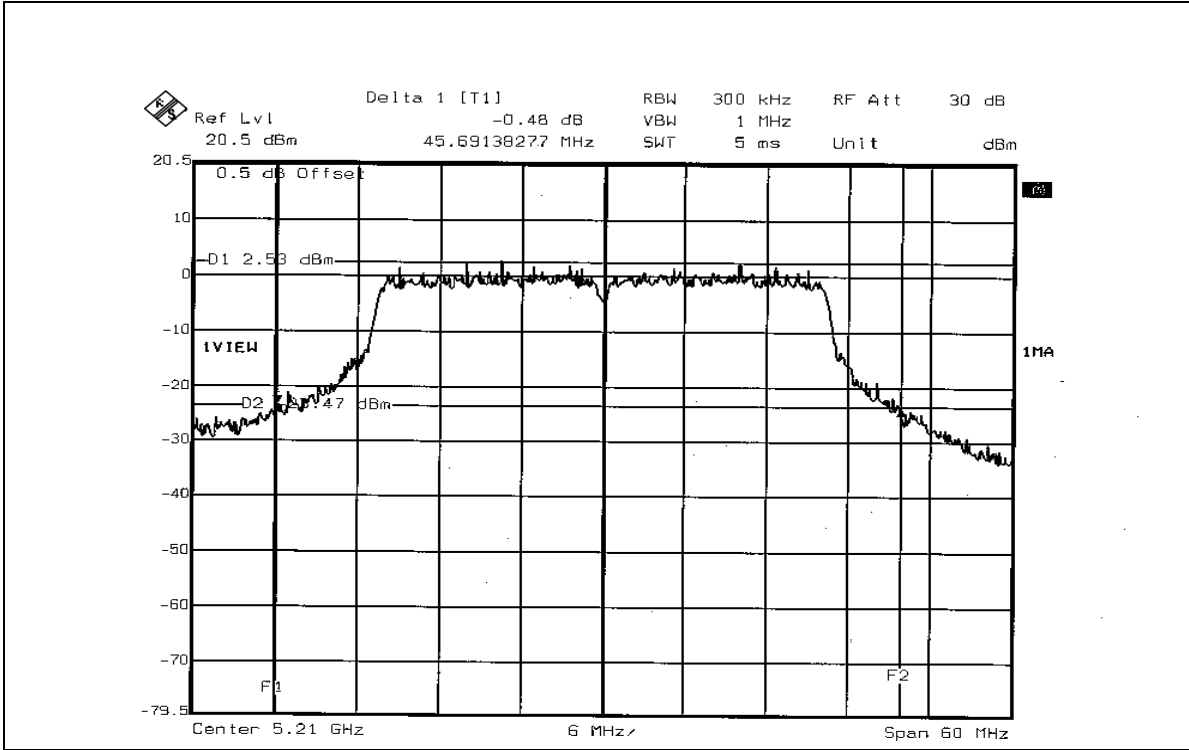

CH 2

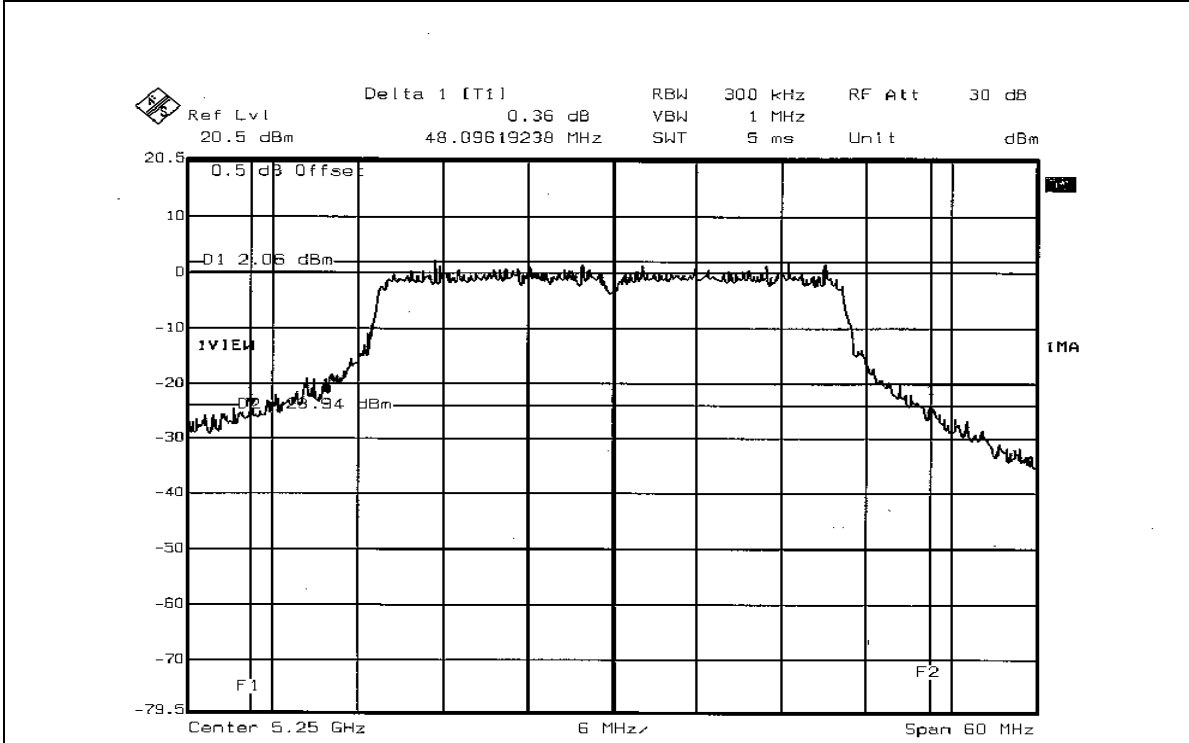



CH 3

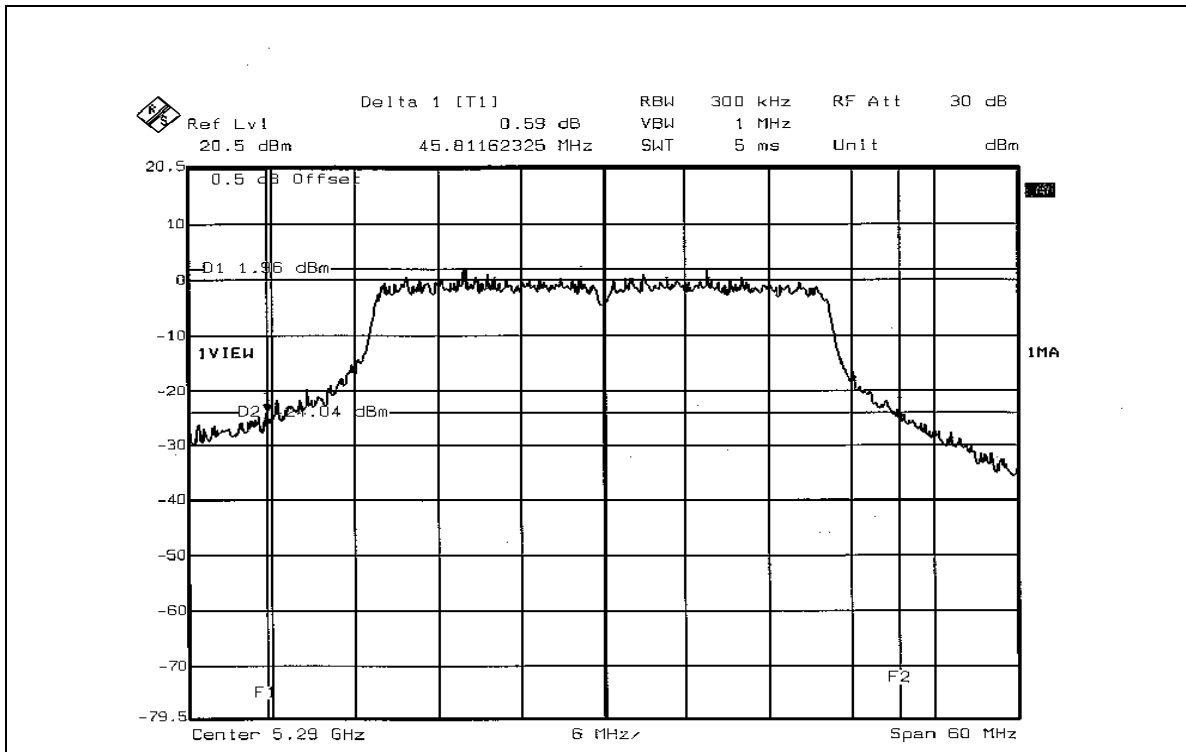



4.4 PEAK POWER EXCURSION MEASUREMENT

4.4.1 LIMITS OF PEAK POWER EXCURSION MEASUREMENT

Frequency Band	Limit
5.15 – 5.25 GHz	13dB
5.25 – 5.35 GHz	13dB
5.725 – 5.825 GHz	13dB

4.4.2 TEST INSTRUMENTS

Description & Manufacturer	Model No.	Serial No.	Calibrated Until
SPECTRUM ANALYZER	FSEK30	100049	Aug. 12, 2005

NOTE: The calibration interval of the above test instruments is 12 months and the calibrations are traceable to NML/ROC and NIST/USA.

4.4.3 TEST PROCEDURE

1. The transmitter output was connected to the spectrum analyzer.
2. Set the spectrum bandwidth span to view the entire spectrum.
3. Using peak detector and Max-hold function for Trace 1 (RB=1MHz, VB=3MHz) and 2 (RB=1MHz, VB=300KHz).
4. The largest difference between Trace 1 and Trace 2 in any 1MHz band on any frequency was recorded.

4.4.4 DEVIATION FROM TEST STANDARD

No deviation

4.4.5 TEST SETUP

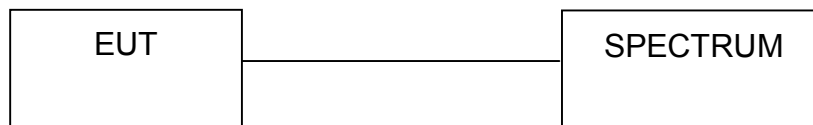

4.4.6 EUT OPERATING CONDITIONS

The software provided by client to enable the EUT under transmission condition continuously at specific channel frequencies individually.

4.4.7 TEST RESULTS

802.11a OFDM modulation

EUT	Wireless 11a+g Dual-Band Access Point	MODEL	WX-7800A
MODULATION TYPE	BPSK	TRANSFER RATE	6Mbps
INPUT POWER (SYSTEM)	120Vac, 60 Hz	ENVIRONMENTAL CONDITIONS	24deg. C, 67%RH, 991hPa
TESTED BY	Leo Hung		

CHANNEL	CHANNEL FREQUENCY (MHz)	PEAK POWER EXCURSION (dB)	PEAK to AVERAGE EXCURSION LIMIT (dB)	PASS/FAIL
1	5180	7.02	13	PASS
4	5240	7.29	13	PASS
5	5260	6.47	13	PASS
8	5320	7.32	13	PASS



CH 1

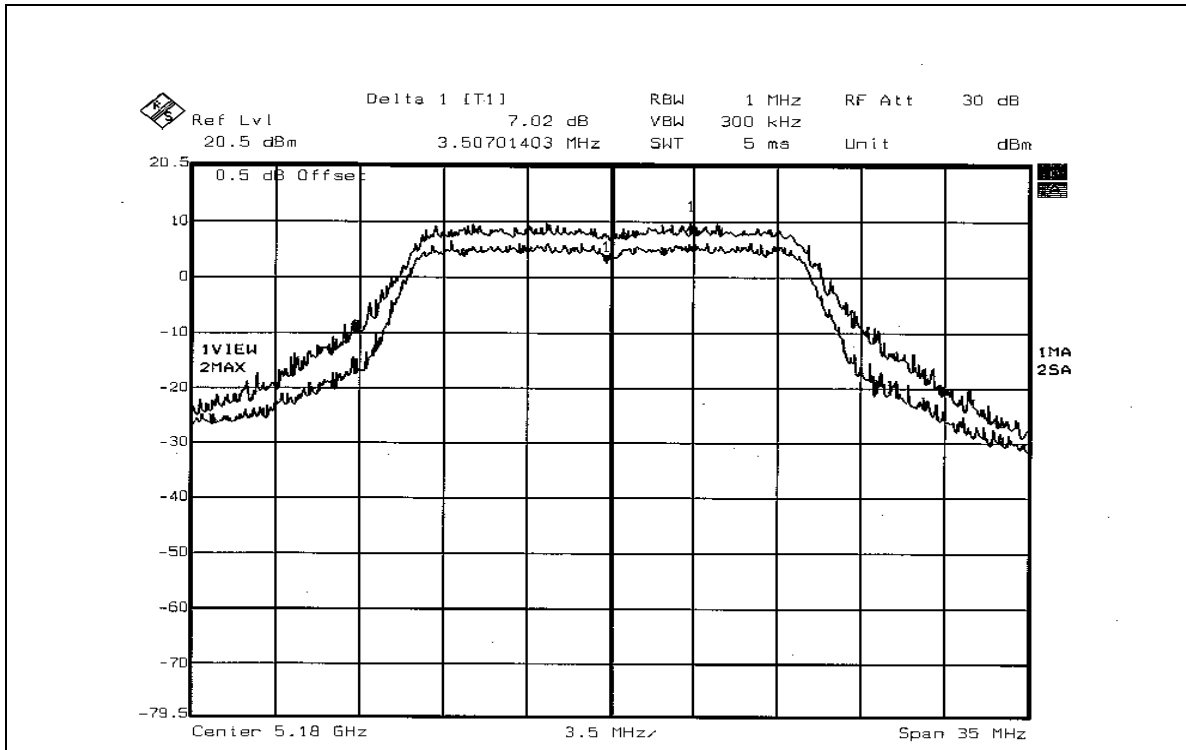

CH 4

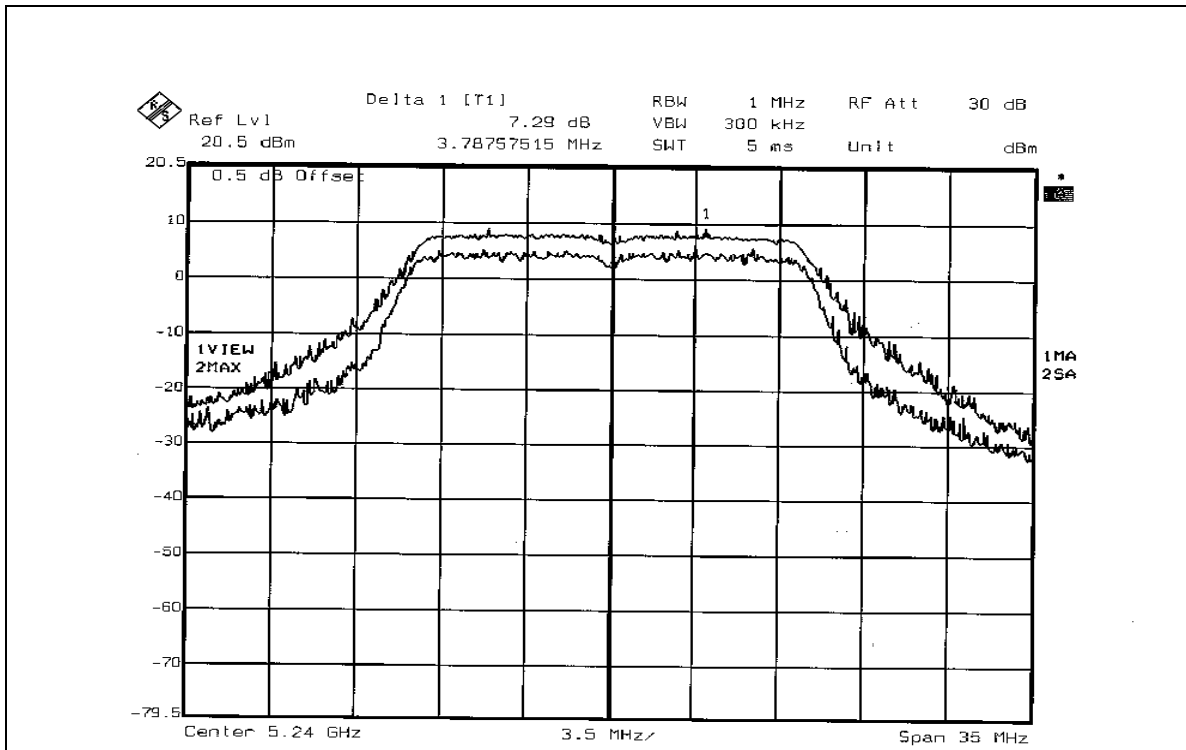



CH 5

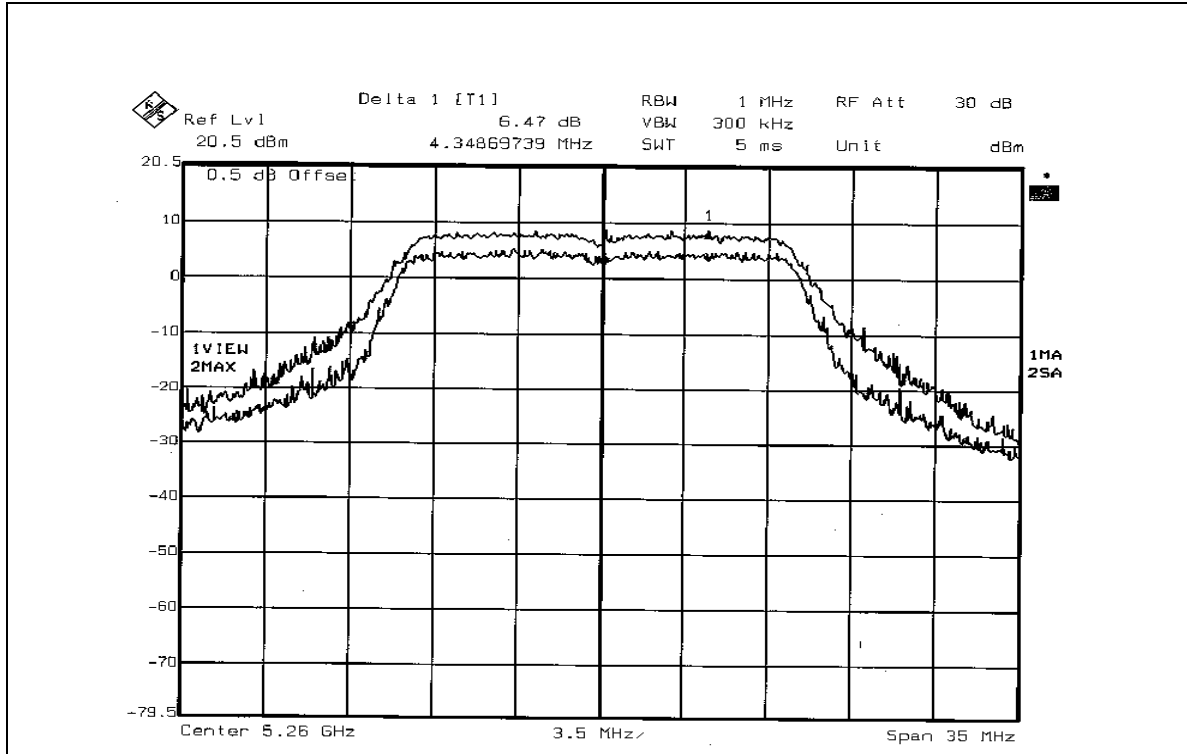

CH 8

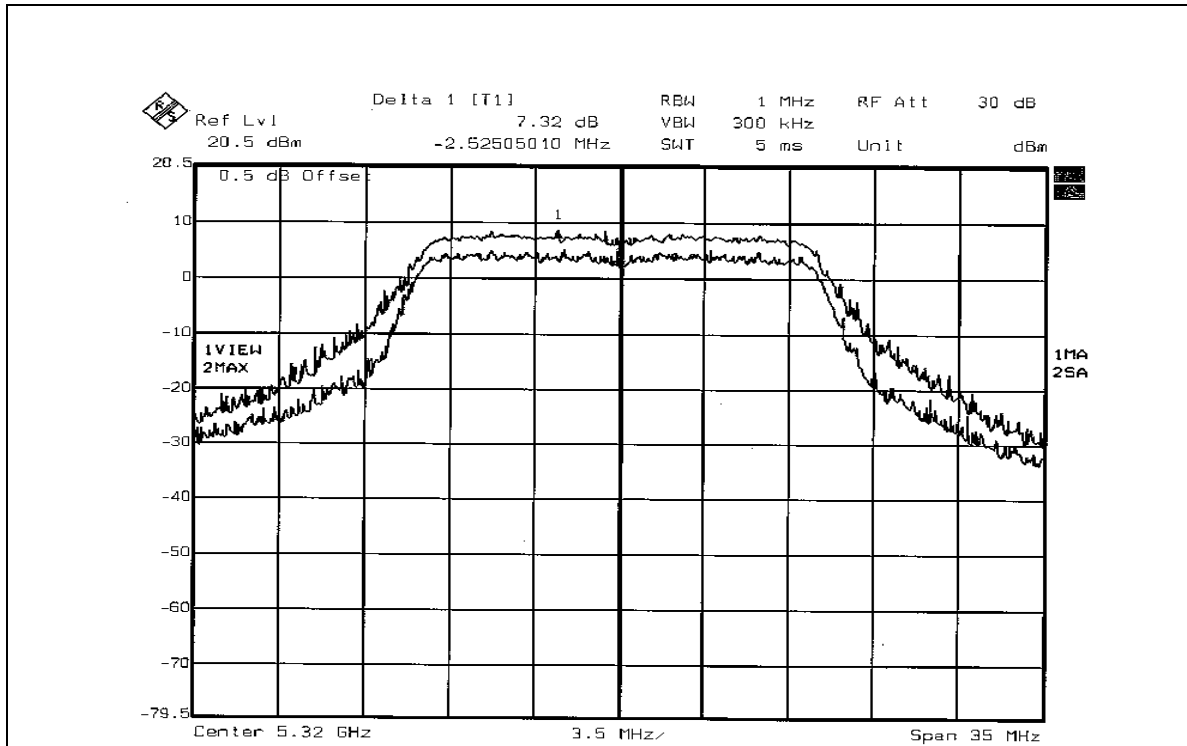

**802.11a Turbo OFDM modulation**

EUT	Wireless 11a+g Dual-Band Access Point	MODEL	WX-7800A
MODULATION TYPE	BPSK	TRANSFER RATE	12Mbps
INPUT POWER (SYSTEM)	120Vac, 60 Hz	ENVIRONMENTAL CONDITIONS	24deg. C, 67%RH, 991hPa
TESTED BY	Leo Hung		

CHANNEL	CHANNEL FREQUENCY (MHz)	PEAK POWER EXCURSION (dB)	PEAK to AVERAGE EXCURSION LIMIT (dB)	PASS/FAIL
1	5210	6.16	13	PASS
2	5250	6.79	13	PASS
3	5290	6.03	13	PASS



CH 1

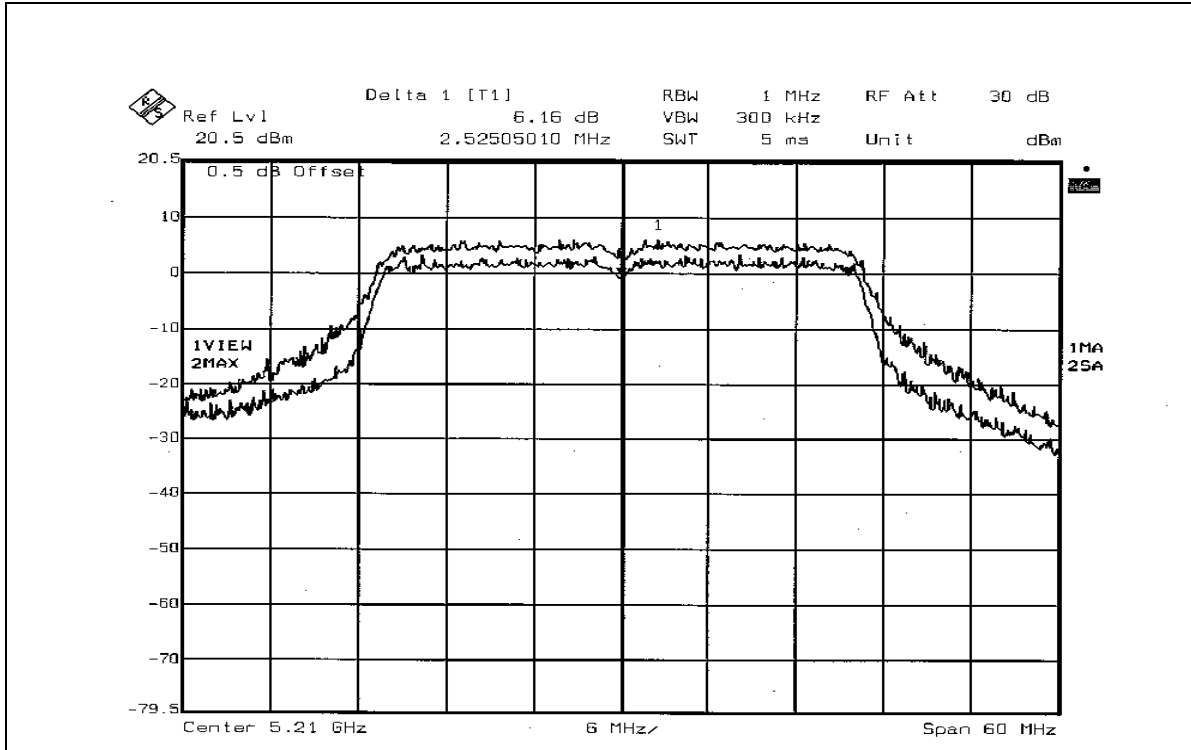

CH 2

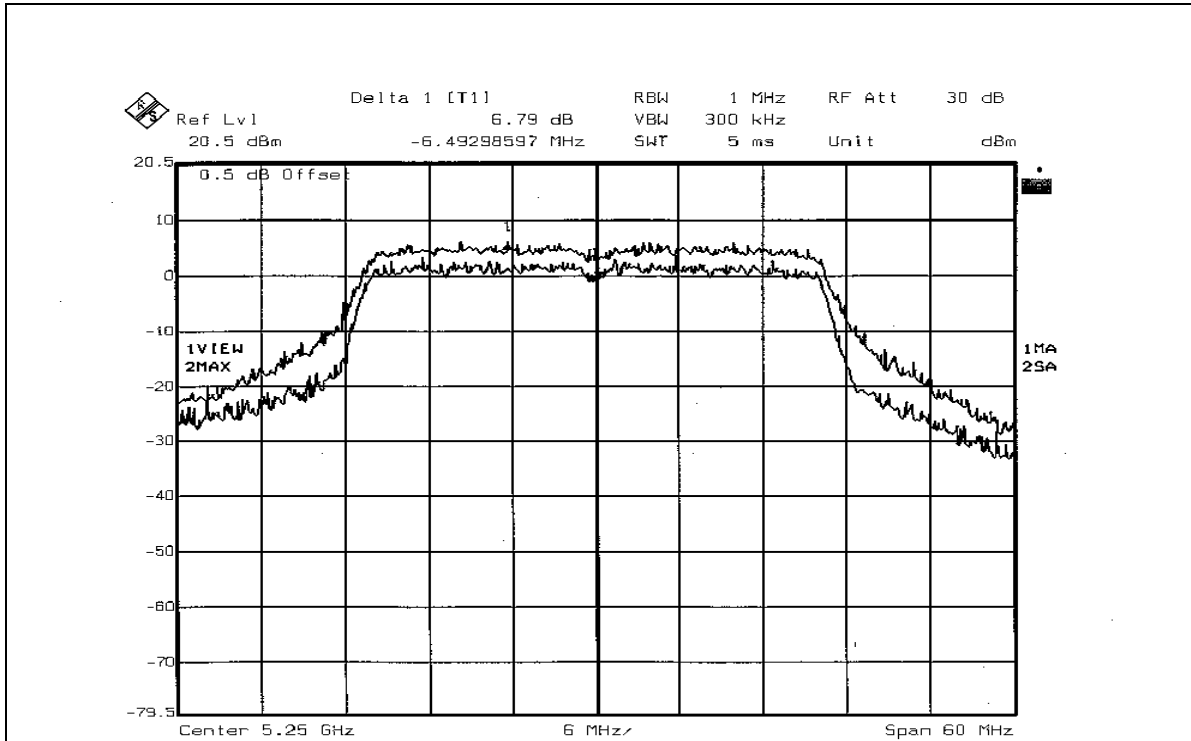



CH 3

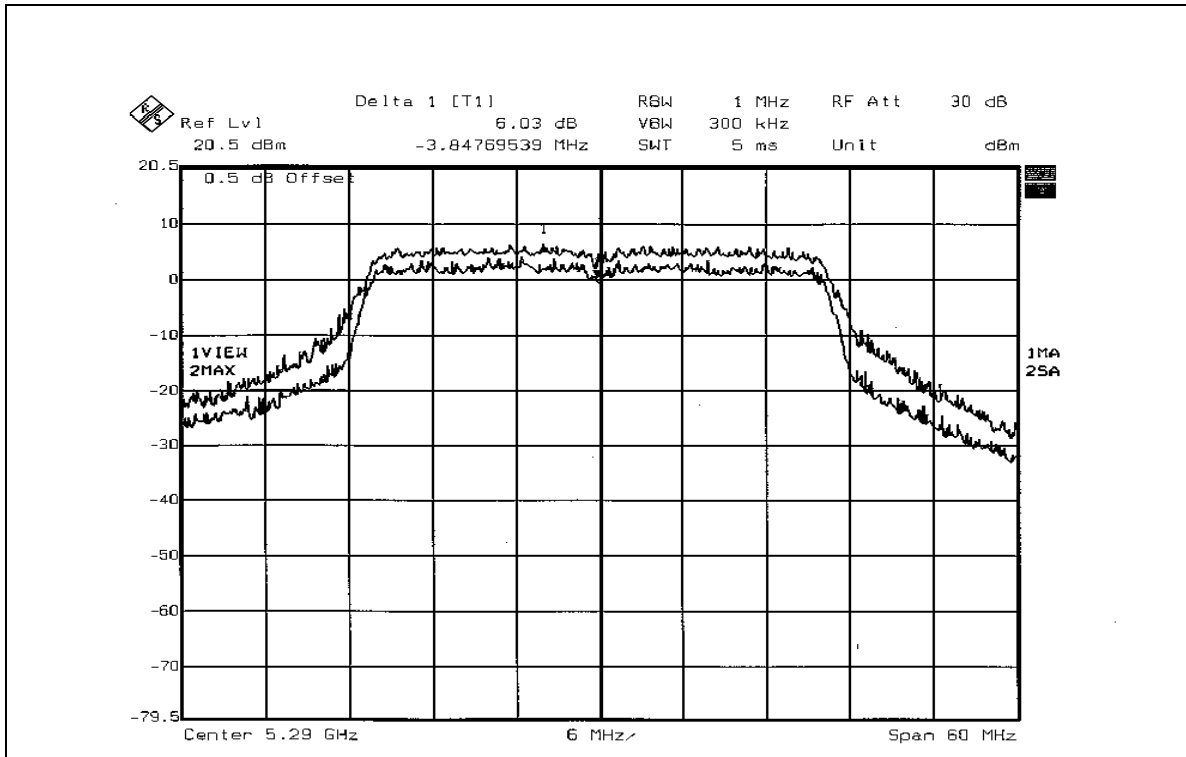

4.5 PEAK POWER SPECTRAL DENSITY MEASUREMENT

4.5.1 LIMITS OF PEAK POWER SPECTRAL DENSITY MEASUREMENT

Frequency Band	Limit
5.15 ~ 5.25GHz	4dBm
5.25 ~ 5.35GHz	11dBm
5.725 ~ 5.825GHz	17dBm

4.5.2 TEST INSTRUMENTS

Description & Manufacturer	Model No.	Serial No.	Calibrated Until
SPECTRUM ANALYZER	FSEK30	100049	Aug. 12, 2005

NOTE: The calibration interval of the above test instruments is 12 months and the calibrations are traceable to NML/ROC and NIST/USA.

4.5.3 TEST PROCEDURES

1. The transmitter output was connected to the spectrum analyzer.
2. Set RBW=1MHz, VBW=3MHz. The PPSD is the highest level found across the emission in any 1MHz band.

4.5.4 DEVIATION FROM TEST STANDARD

No deviation

4.5.5 TEST SETUP



4.5.6 EUT OPERATING CONDITIONS

Same as 5.3.6



4.5.7 TEST RESULTS

802.11a OFDM modulation

EUT	Wireless 11a+g Dual-Band Access Point	MODEL	WX-7800A
MODULATION TYPE	BPSK	TRANSFER RATE	6Mbps
INPUT POWER (SYSTEM)	120Vac, 60 Hz	ENVIRONMENTAL CONDITIONS	24deg. C, 67%RH, 991hPa
TESTED BY	Leo Hung		

CHANNEL	CHANNEL FREQUENCY (MHz)	RF POWER LEVEL IN 1MHz BW (dBm)	MAXIMUM LIMIT (dBm)	PASS/FAIL
1	5180	-0.55	4	PASS
4	5240	-0.61	4	PASS
5	5260	-0.70	11	PASS
8	5320	-0.93	11	PASS



CH 1

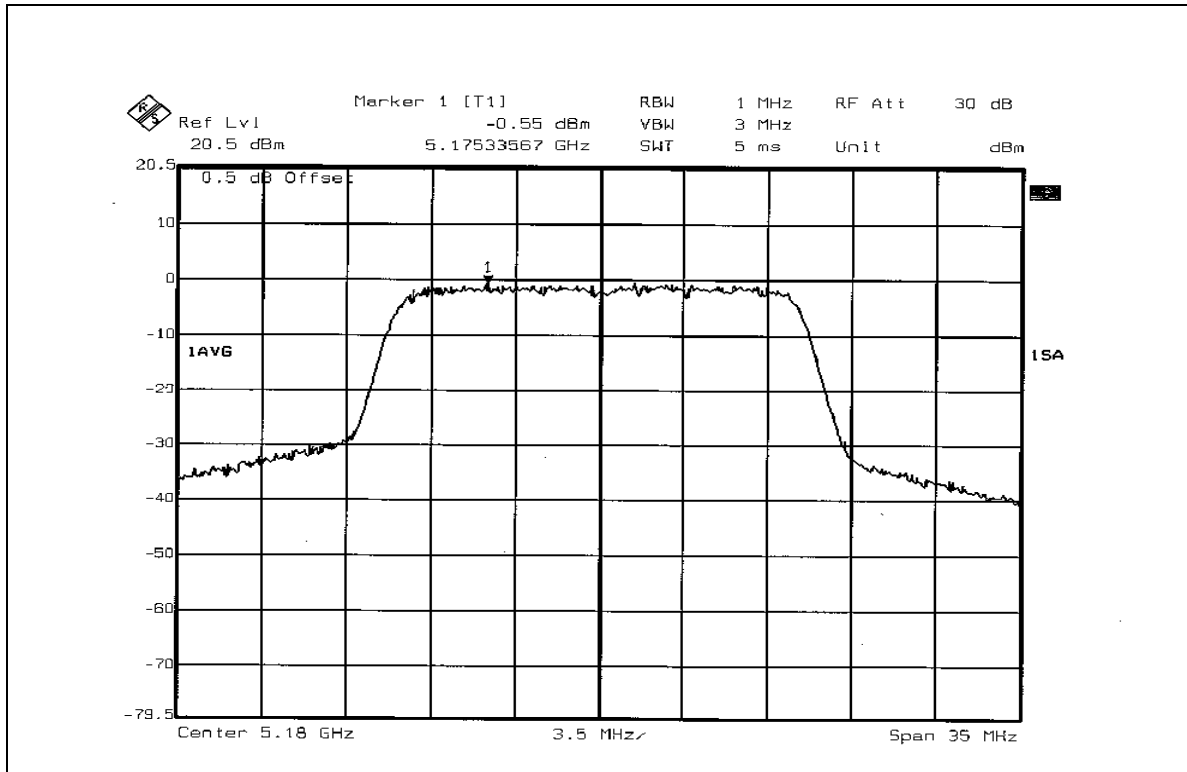

CH 4

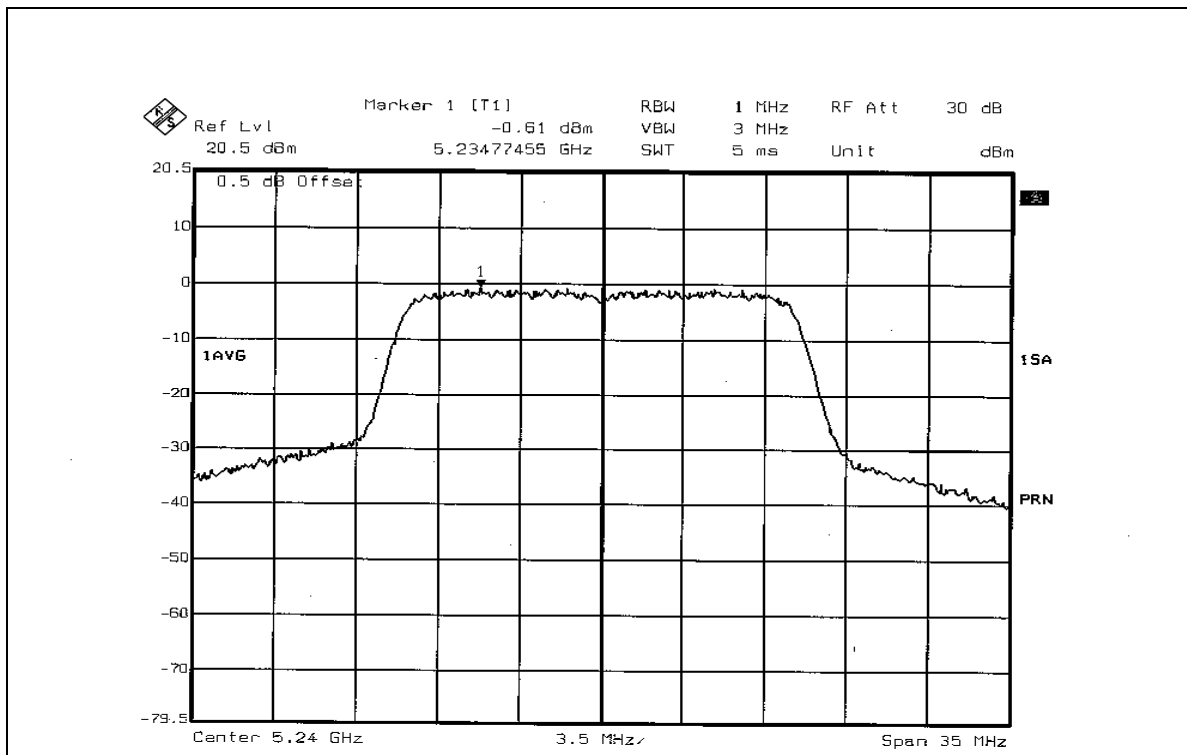



CH 5

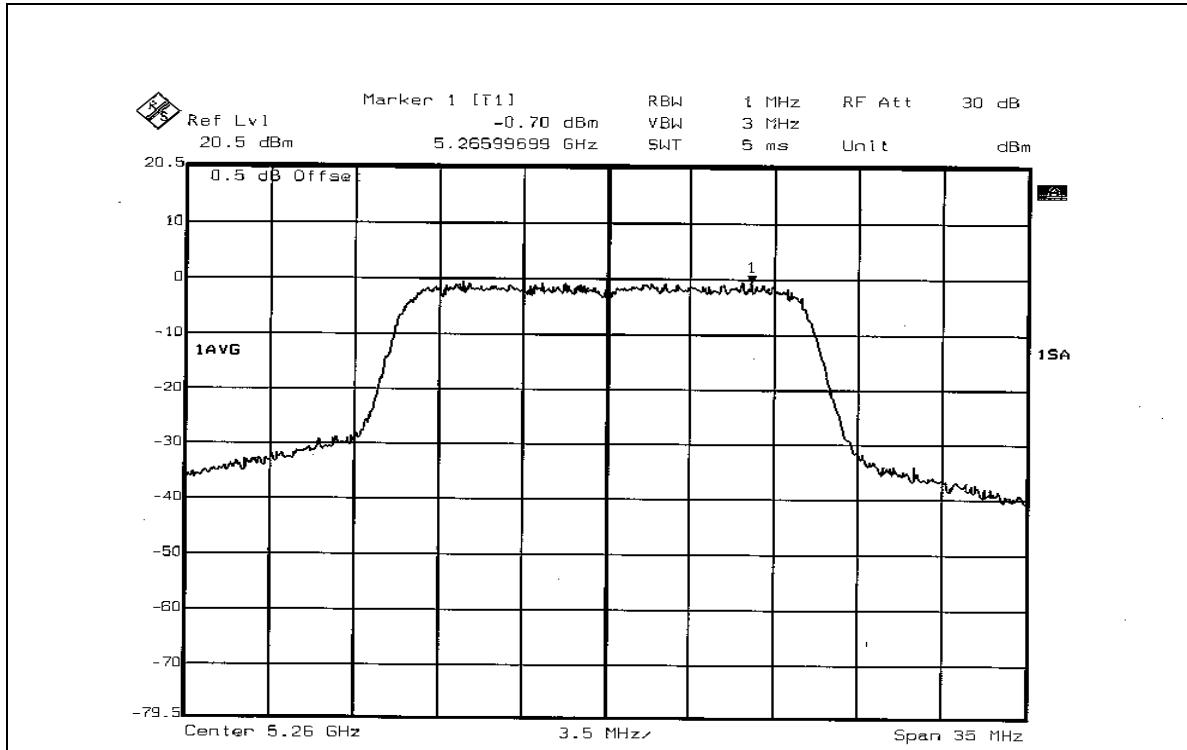

CH 8

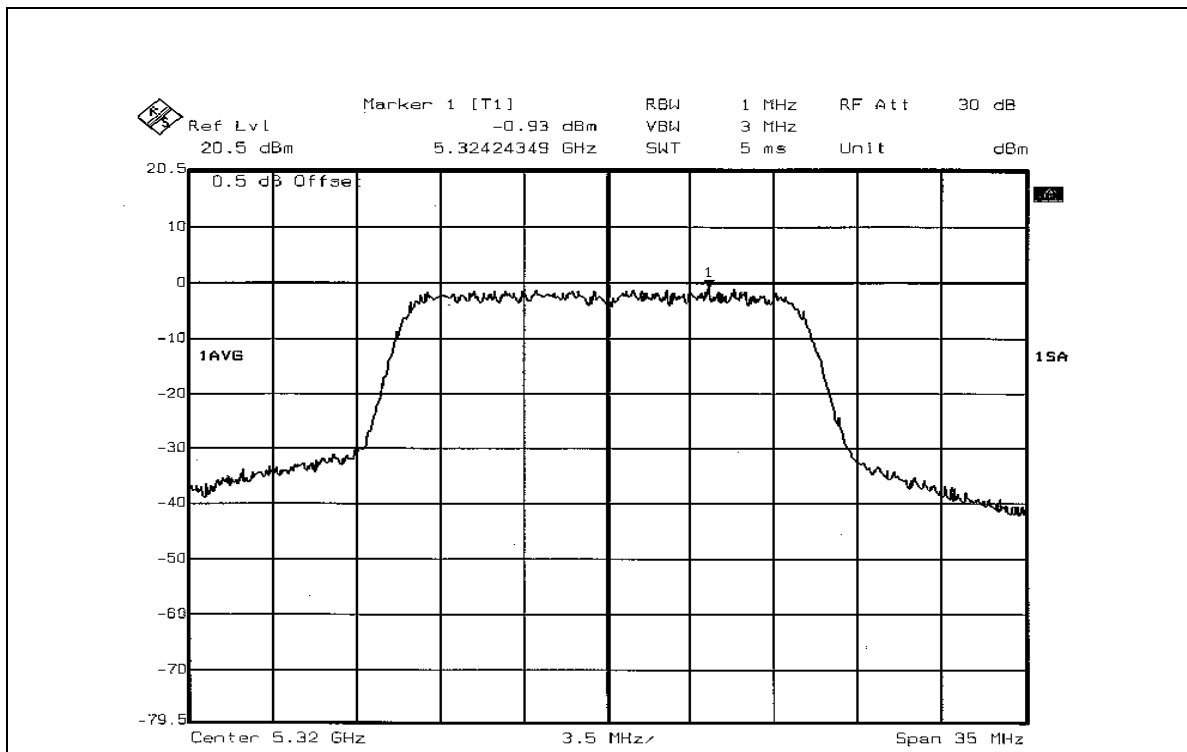

**802.11a Turbo OFDM modulation**

EUT	Wireless 11a+g Dual-Band Access Point	MODEL	WX-7800A
MODULATION TYPE	BPSK	TRANSFER RATE	12Mbps
INPUT POWER (SYSTEM)	120Vac, 60 Hz	ENVIRONMENTAL CONDITIONS	24deg. C, 67%RH, 991hPa
TESTED BY	Leo Hung		

CHANNEL	CHANNEL FREQUENCY (MHz)	RF POWER LEVEL IN 1 MHz BW (dBm)	MAXIMUM LIMIT (dBm)	PASS/FAIL
1	5210	-3.47	4	PASS
2	5250	-3.71	11	PASS
3	5290	-3.40	11	PASS



CH 1

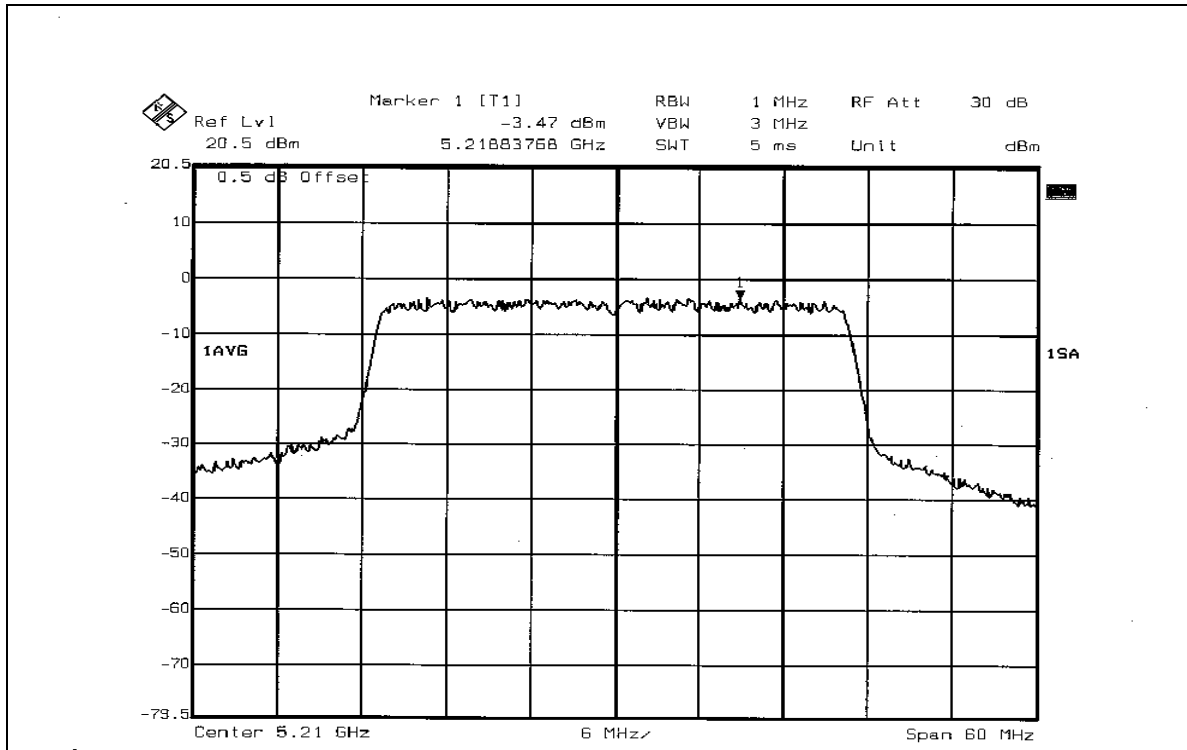

CH 2

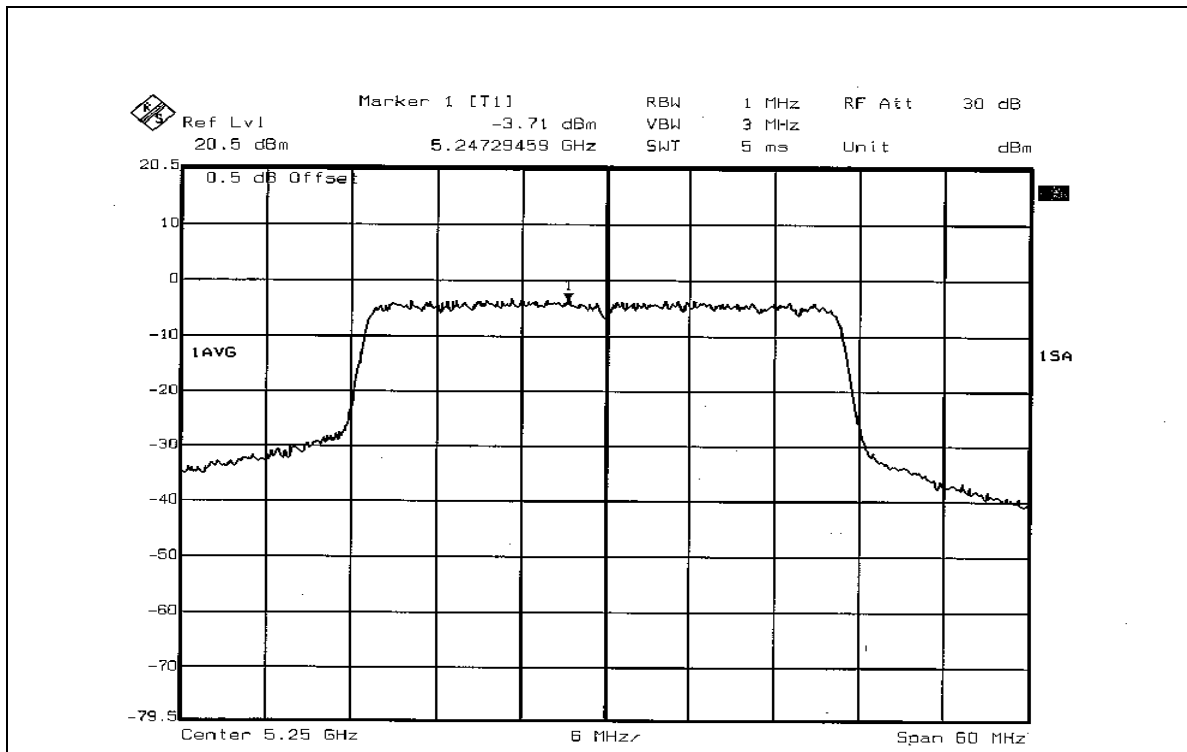



CH 3

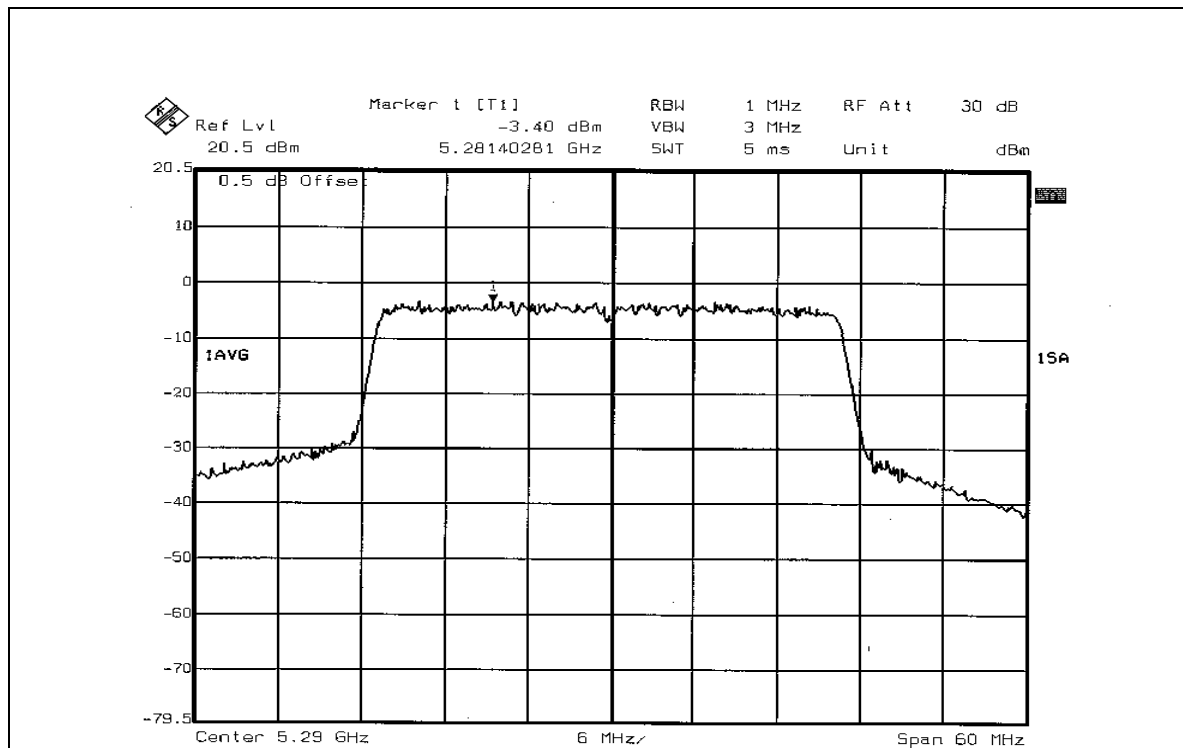



4.6 FREQUENCY STABILITY

4.6.1 LIMITS OF FREQUENCY STABILITY MEASUREMENT

The frequency tolerance of the carrier signal shall be maintained within +/- 0.02% of the operating frequency over a temperature variation of -30 degrees to 50 degrees C at normal supply voltage, and for a variation in the primary supply voltage from 85% to 115% of the rated supply voltage at a temperature of 20 degrees C.

4.6.2 TEST INSTRUMENTS

Description & Manufacturer	Model No.	Serial No.	Calibrated Until
ANRITSU SPECTRUM ANALYZER	MS2667C	M10281	Aug. 12, 2005
WIT STANDARD TEMPERATURE AND HUMIDITY CHAMBER	TH-4S-C	W901030	Aug. 12, 2005

NOTE: The calibration interval of the above test instruments is 12 months and the calibrations are traceable to NML/ROC and NIST/USA.

4.6.3 TEST PROCEDURE

1. The EUT was placed inside the environmental test chamber and powered by nominal DC voltage.
2. Turn the EUT on and couple its output to a spectrum analyzer.
3. Turn the EUT off and set the chamber to the highest temperature specified.
4. Allow sufficient time (approximately 30 min) for the temperature of the chamber to stabilize, turn the EUT on and measure the operating frequency after 2, 5, and 10 minutes.
5. Repeat step 2 and 3 with the temperature chamber set to the lowest temperature.
6. The test chamber was allowed to stabilize at +20 degree C for a minimum of 30 minutes. The supply voltage was then adjusted on the EUT from 85% to 115% and the frequency record.

4.6.4 DEVIATION FROM TEST STANDARD

No deviation

4.6.5 TEST SETUP

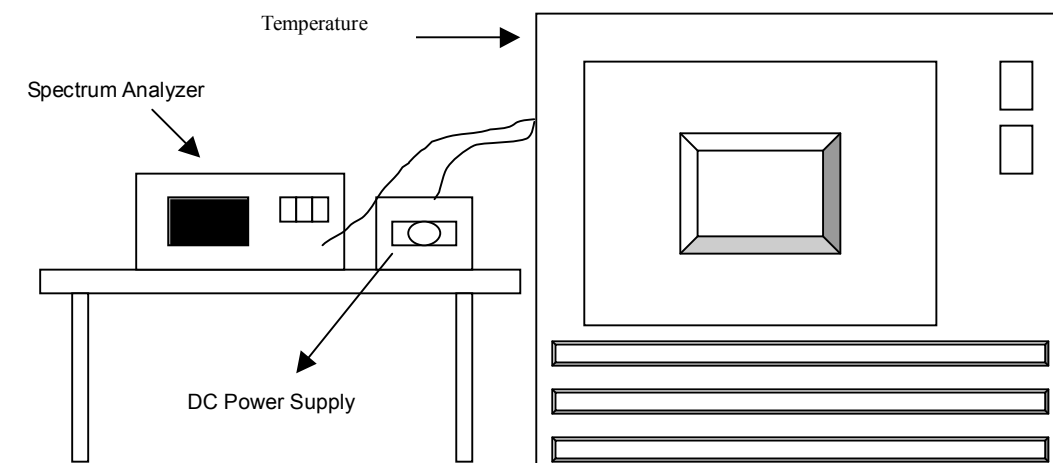

4.6.6 EUT OPERATING CONDITION

Same as Item 4.3.6



4.6.7 TEST RESULTS

		Operating frequency: 5320MHz				Limit : ± 0.015%			
Temp. (°C)	Power supply (Vac)	0 minute		2 minute		5 minute		10 minute	
		(MHz)	(%)	(MHz)	(%)	(MHz)	(%)	(MHz)	(%)
50	138	5319.9706	-0.0005526	5319.9708	-0.0005489	5319.9705	-0.0005545	5319.9712	-0.0005414
	120	5319.9701	-0.0005620	5319.9702	-0.0005602	5319.9707	-0.0005508	5319.9715	-0.0005357
	102	5319.9710	-0.0005451	5319.9712	-0.0005414	5319.9708	-0.0005489	5319.9717	-0.0005320
40	138	5319.9665	-0.0006297	5319.9667	-0.0006259	5319.9673	-0.0006147	5319.9675	-0.0006109
	120	5319.9670	-0.0006203	5319.9672	-0.0006165	5319.9673	-0.0006147	5319.9675	-0.0006109
	102	5319.9671	-0.0006184	5319.9673	-0.0006147	5319.9673	-0.0006147	5319.9677	-0.0006071
30	138	5319.9870	-0.0002444	5319.9872	-0.0002406	5319.9827	-0.0003252	5319.9802	-0.0003722
	120	5319.9850	-0.0002820	5319.9853	-0.0002763	5319.9822	-0.0003346	5319.9795	-0.0003853
	102	5319.9836	-0.0003083	5319.9838	-0.0003045	5319.9810	-0.0003571	5319.9785	-0.0004041
20	138	5319.9744	-0.0004812	5319.9747	-0.0004756	5319.9750	-0.0004662	5319.9747	-0.0004756
	120	5319.9745	-0.0004793	5319.9747	-0.0004756	5319.9752	-0.0004793	5319.9753	-0.0004643
	102	5319.9746	-0.0004774	5319.9748	-0.0004737	5319.9745	-0.0004850	5319.9748	-0.0004737
10	138	5319.9748	-0.0004737	5319.9750	-0.0004699	5319.9742	-0.0004850	5319.9742	-0.0004850
	120	5319.9735	-0.0004981	5319.9740	-0.0004887	5319.9742	-0.0004850	5319.9743	-0.0004831
	102	5319.9732	-0.0005038	5319.9740	-0.0004887	5319.9742	-0.0003421	5319.9742	-0.0004850
0	138	5319.9815	-0.0003477	5319.9817	-0.0003440	5319.9818	-0.0003421	5319.9822	-0.0003346
	120	5319.9824	-0.0003308	5319.9827	-0.0003252	5319.9818	-0.0003346	5319.9823	-0.0003327
	102	5319.9815	-0.0003477	5319.9818	-0.0003421	5319.9822	-0.0002105	5319.9817	-0.0003440
-10	138	5319.9880	-0.0002256	5319.9882	-0.0002218	5319.9888	-0.0002105	5319.9888	-0.0002105
	120	5319.9882	-0.0002218	5319.9885	-0.0002162	5319.9888	-0.0002105	5319.9893	-0.0002011
	102	5319.9883	-0.0002199	5319.9885	-0.0002162	5319.9888	-0.0002105	5319.9895	-0.0001974
-20	138	5319.9925	-0.0001410	5319.9828	-0.0003233	5319.9925	-0.0001372	5319.9925	-0.0001410
	120	5319.9923	-0.0001447	5319.9828	-0.0003233	5319.9927	-0.0001372	5319.9927	-0.0001372
	102	5319.9924	-0.0001429	5319.9927	-0.0001372	5319.9927	-0.0001447	5319.9925	-0.0001410
-30	138	5319.9915	-0.0001598	5319.9918	-0.0001541	5319.9923	-0.0001598	5319.9912	-0.0001654
	120	5319.9910	-0.0001692	5319.9915	-0.0001598	5319.9915	-0.0001635	5319.9910	-0.0001692
	102	5319.9914	-0.0001617	5319.9917	-0.0001560	5319.9913	-0.0001635	5319.9907	-0.0001748

4.7 BAND EDGES MEASUREMENT

4.7.1 TEST INSTRUMENTS

Description & Manufacturer	Model No.	Serial No.	Calibrated Until
SPECTRUM ANALYZER	FSEK30	100049	Aug. 12, 2005

NOTE: The calibration interval of the above test instruments is 12 months and the calibrations are traceable to NML/ROC and NIST/USA.

4.7.2 TEST PROCEDURE

The transmitter output was connected to the spectrum analyzer via a low lose cable. Set both RBW and VBW of spectrum analyzer to 1MHz with suitable frequency span including 100 MHz bandwidth from band edge. The band edges was measured and recorded.

4.7.3 EUT OPERATING CONDITION

The software provided by client to enable the EUT under transmission condition continuously at specific channel frequencies individually.

4.7.4 TEST RESULTS

For signals in the restricted bands above and below the 5.15 to 5.35GHz allocated band a measurement was made of the amplitude of the spurious emissions with respect to the intentional signals. The relative amplitude, in dBc, was applied to the average and peak filed strength of the intentional signal made on the OATS to calculate the field strength of the unintentional signals.

The spectrum plots (Peak RBW=VBW=1MHz; Average RBW=1MHz, VBW=10Hz) are attached on the following pages.

**802.11a OFDM modulation**

Channel 1 (5180MHz)

The band edge emission plot on page 64 shows 40.62dBc between carrier maximum power and local maximum emission in restrict band. The emission of carrier strength list in the test result of channel 1 is 110.98dBuV/m (Peak), so the maximum field strength in restrict band is $110.98-40.62=70.36$ dBuV/m which is under 74dBuV/m limit.

The band edge emission plot on page 64 shows 50.05dBc between carrier maximum power and local maximum emission in restrict band. The emission of carrier strength list in the test result of channel 1 is 101.07dBuV/m (Average), so the maximum field strength in restrict band is $101.07-50.05=51.02$ dBuV/m which is under 54dBuV/m limit.

Channel 8 (5320MHz)

The band edge emission plot on page 65 shows 46.21dBc between carrier maximum power and local maximum emission in restrict band. The emission of carrier strength list in the test result of channel 8 is 112.29dBuV/m (Peak), so the maximum field strength in restrict band is $112.29-46.21=66.08$ dBuV/m which is under 74dBuV/m limit.

The band edge emission plot on page 66 shows 51.51dBc between carrier maximum power and local maximum emission in restrict band. The emission of carrier strength list in the test result of channel 8 is 102.68dBuV/m (Average), so the maximum field strength in restrict band is $102.68-51.51=51.17$ dBuV/m which is under 54dBuV/m limit.



802.11a OFDM modulation

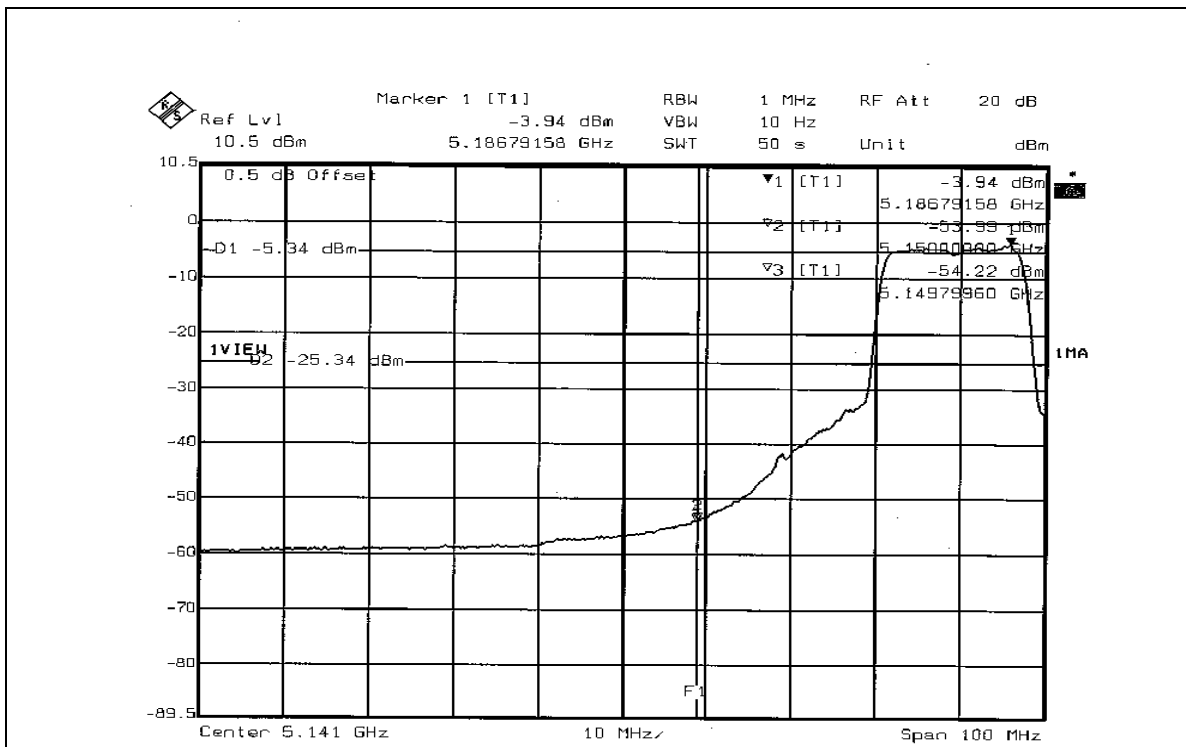
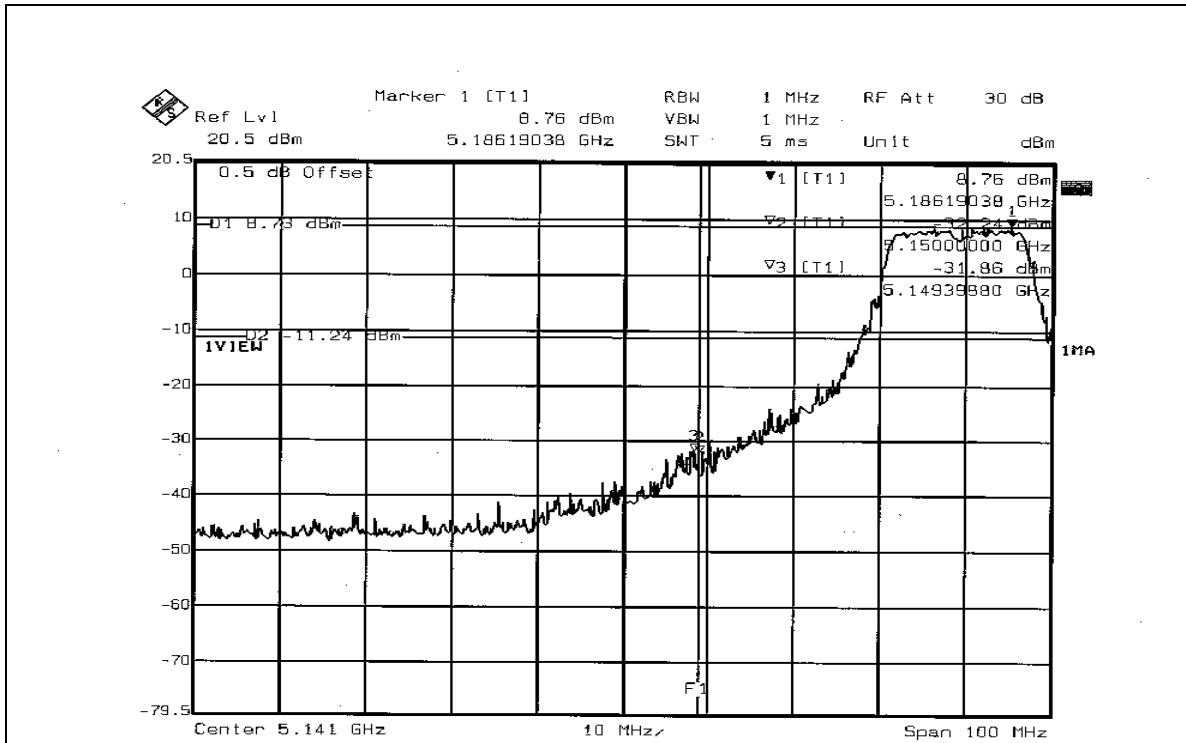

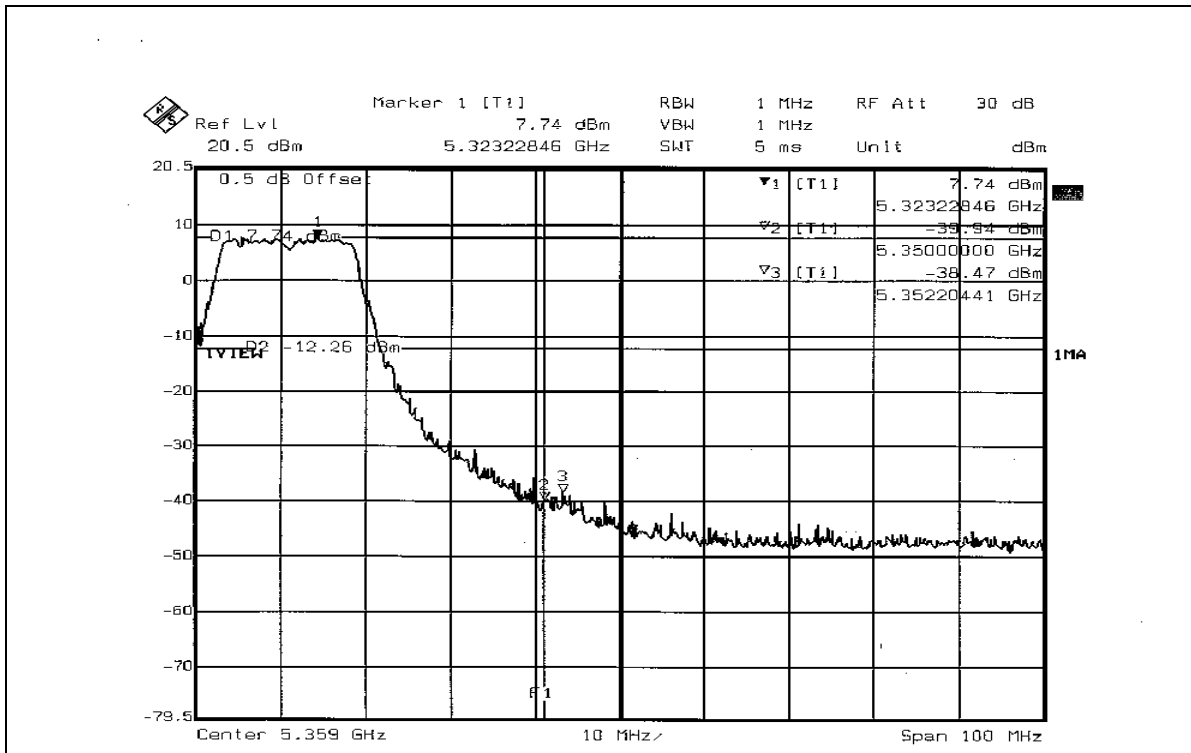
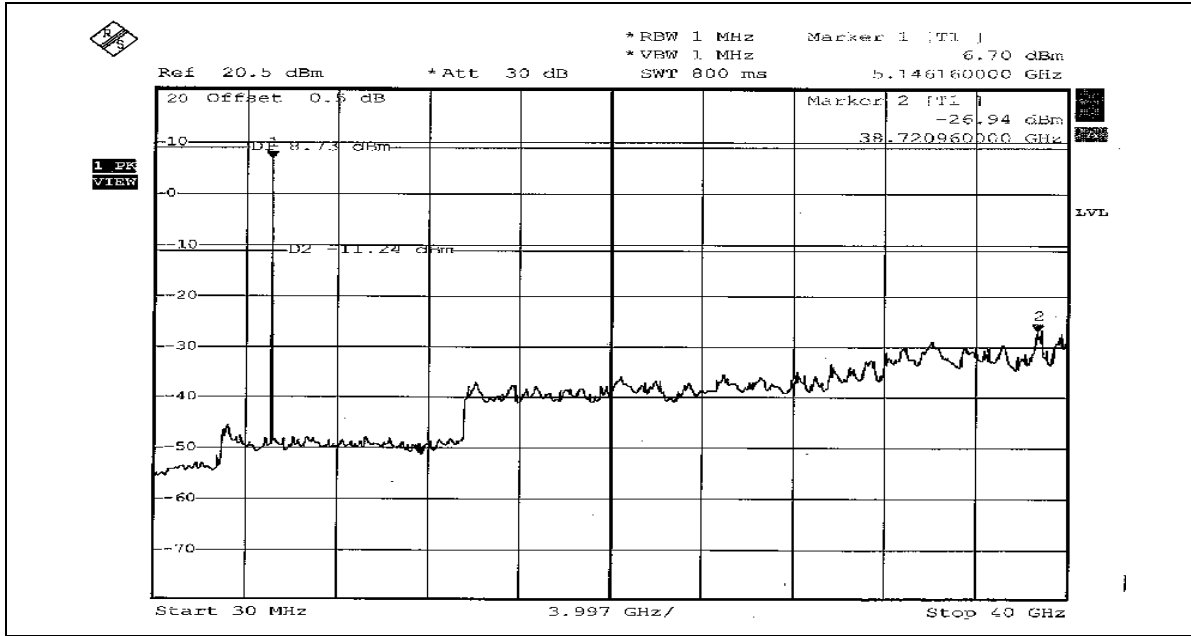

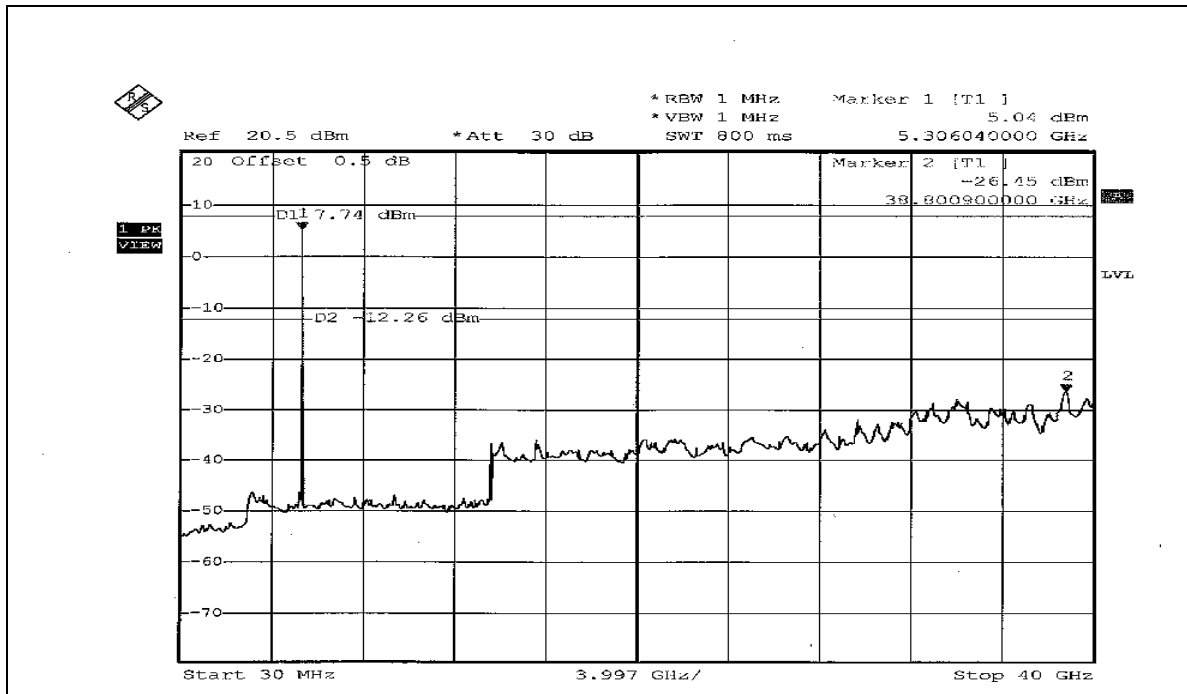
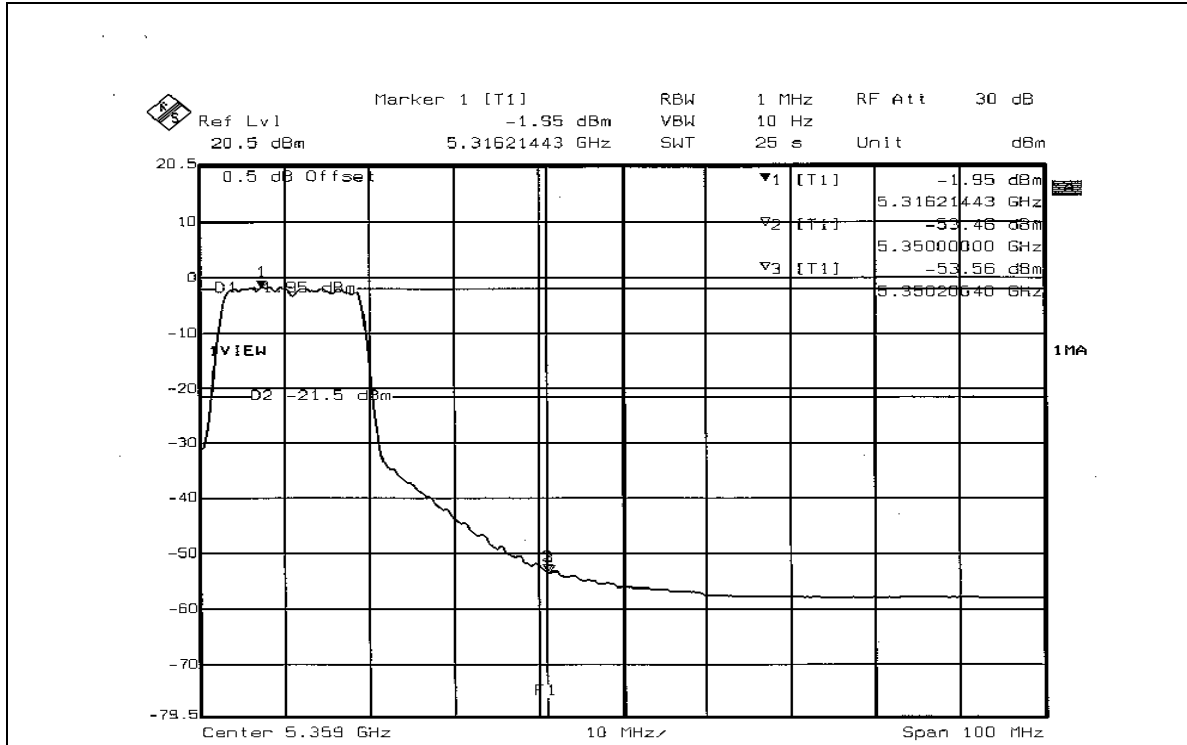

**802.11a Turbo OFDM modulation**

Channel 1 (5210MHz)

The band edge emission plot on page 68 shows 40.00dBc between carrier maximum power and local maximum emission in restrict band. The emission of carrier strength list in the test result of channel 1 is 110.34dBuV/m (Peak), so the maximum field strength in restrict band is $110.34 - 40.00 = 70.34$ dBuV/m which is under 74dBuV/m limit.

The band edge emission plot on page 68 shows 47.08dBc between carrier maximum power and local maximum emission in restrict band. The emission of carrier strength list in the test result of channel 1 is 100.13dBuV/m (Average), so the maximum field strength in restrict band is $100.13 - 47.08 = 53.05$ dBuV/m which is under 54dBuV/m limit.

Channel 3 (5290MHz)

The band edge emission plot on the pages 69 shows 47.40dBc between carrier maximum power and local maximum emission in restrict band. The emission of carrier strength list in the test result of channel 3 is 110.13dBuV/m (Peak), so the maximum field strength in restrict band is $110.13 - 47.40 = 62.70$ dBuV/m which is under 74dBuV/m limit.

The band edge emission plot on the pages 70 shows 50.12dBc between carrier maximum power and local maximum emission in restrict band. The emission of carrier strength list in the test result of channel 3 is 101.04dBuV/m (Average), so the maximum field strength in restrict band is $101.04 - 50.12 = 50.92$ dBuV/m which is under 54dBuV/m limit.



802.11a Turbo OFDM modulation

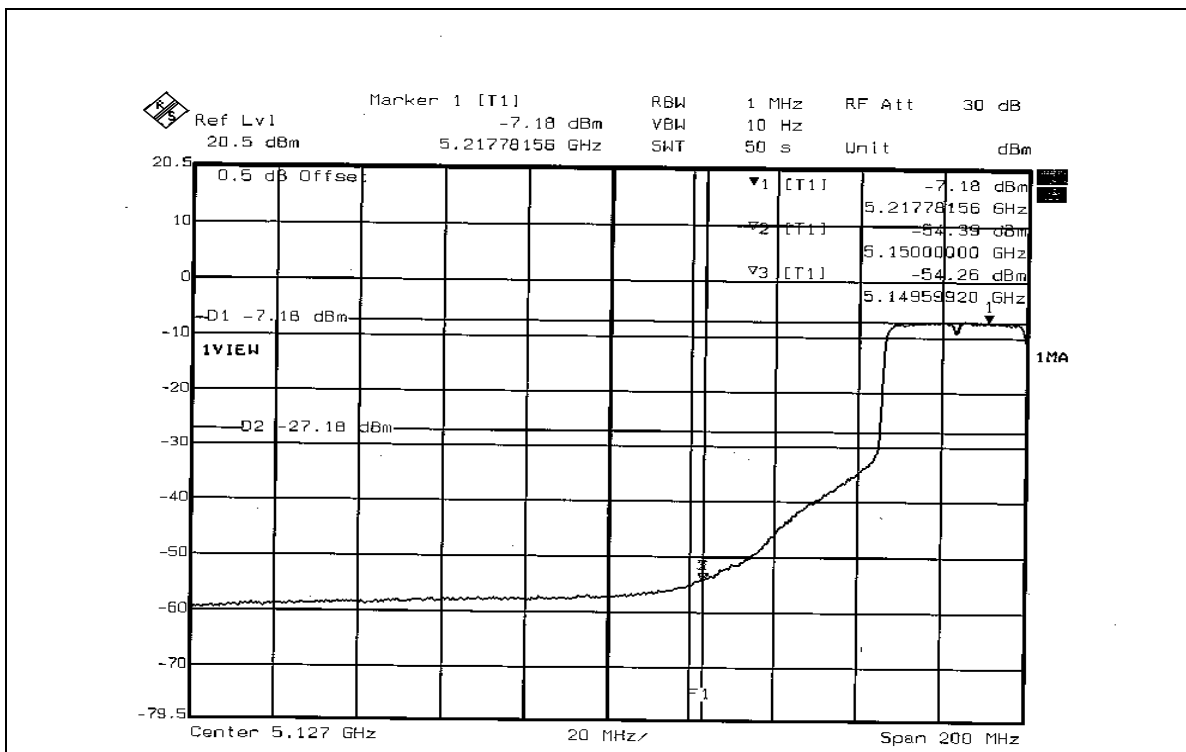
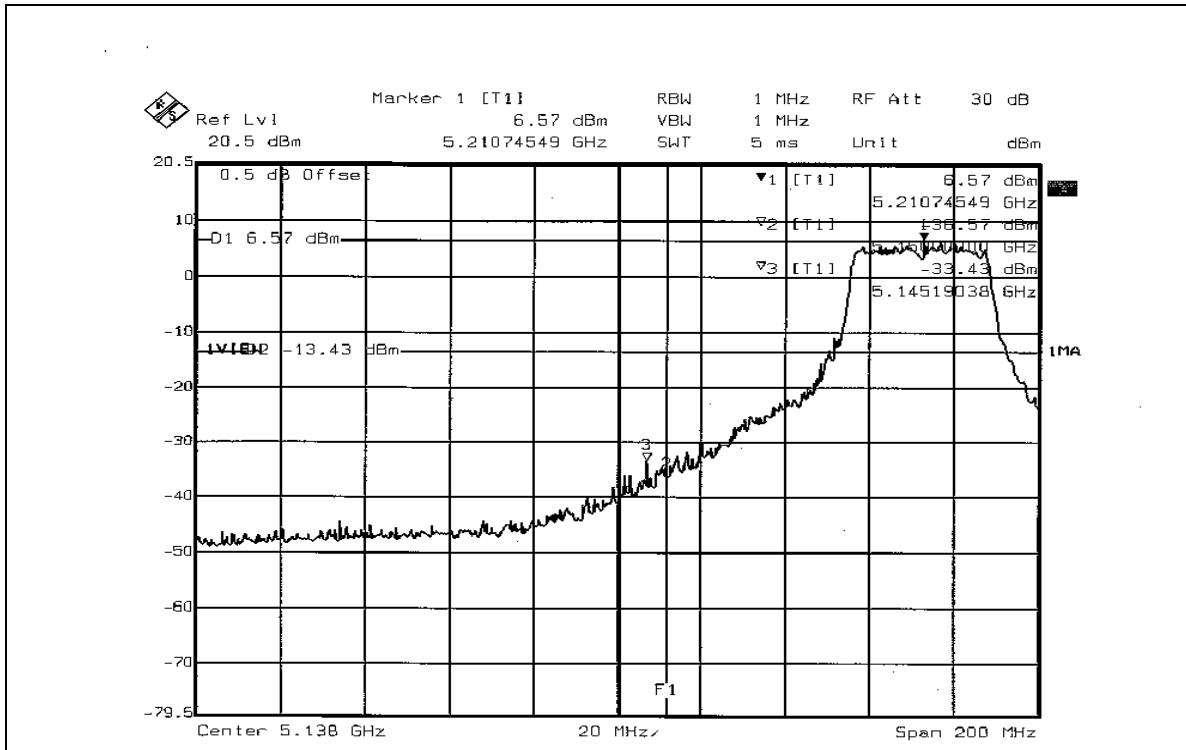

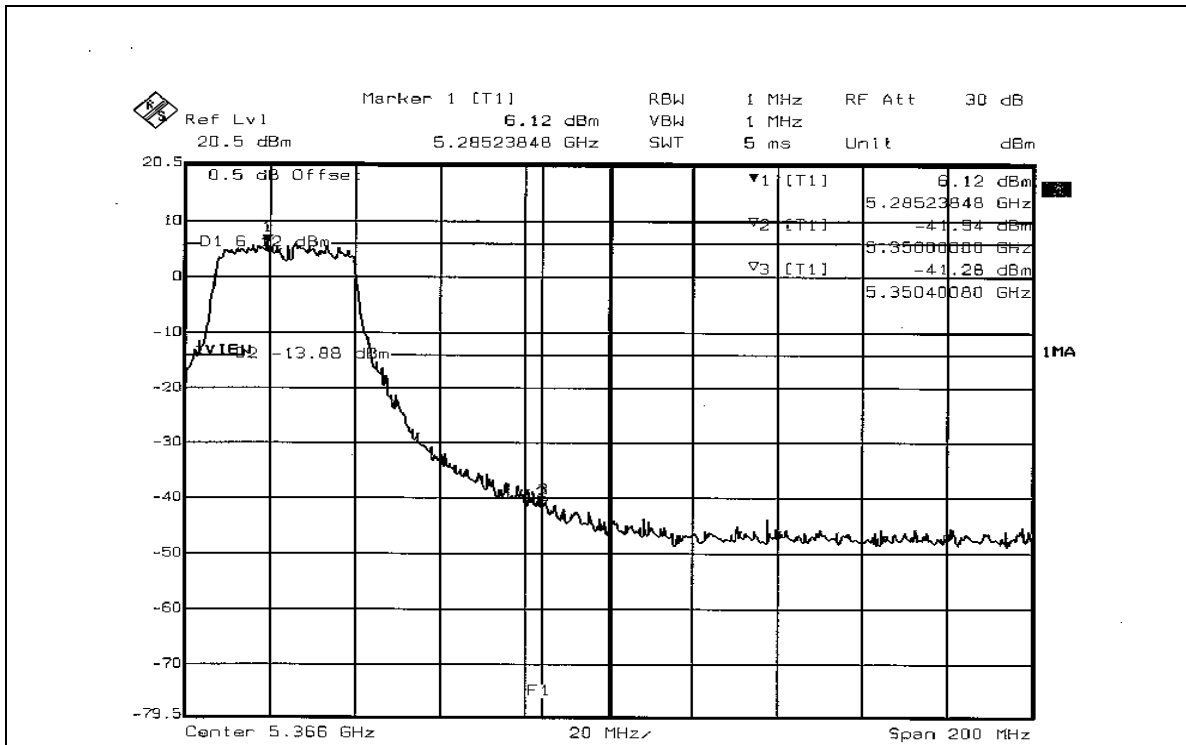
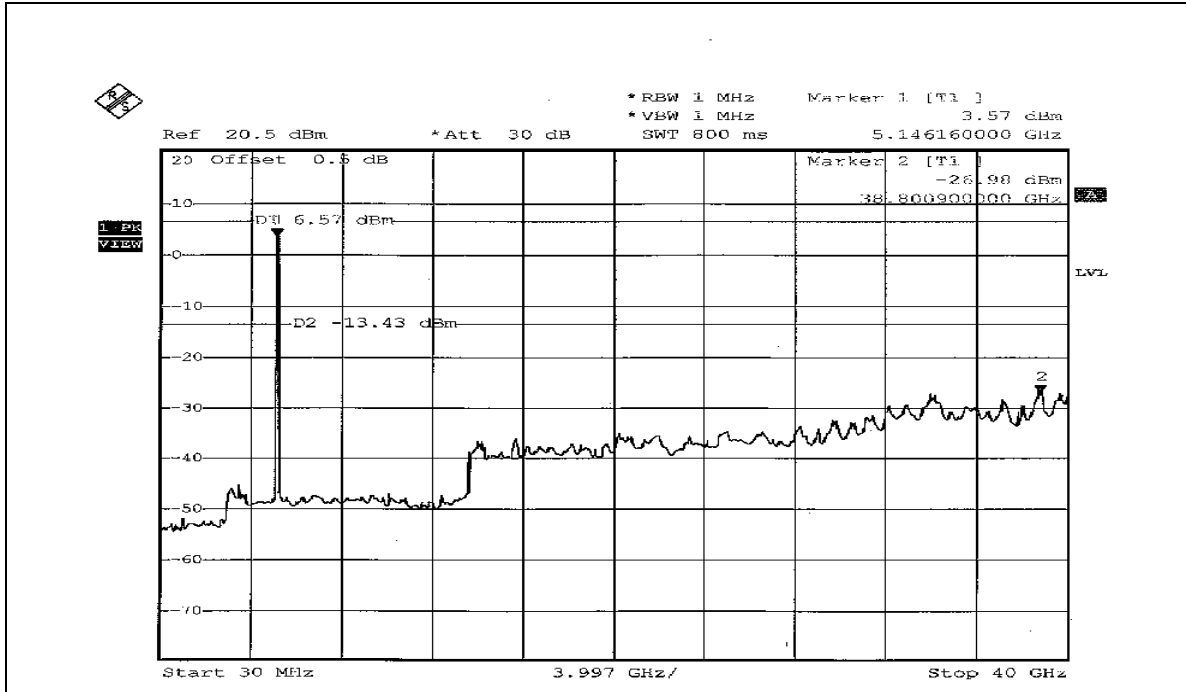

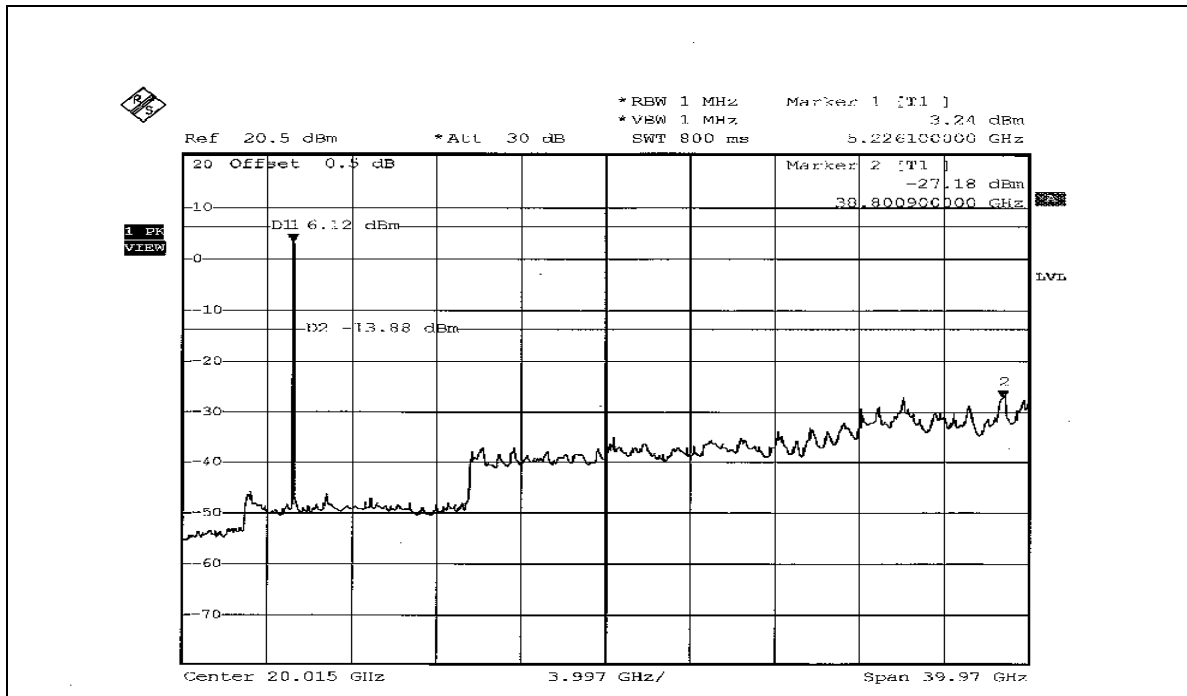
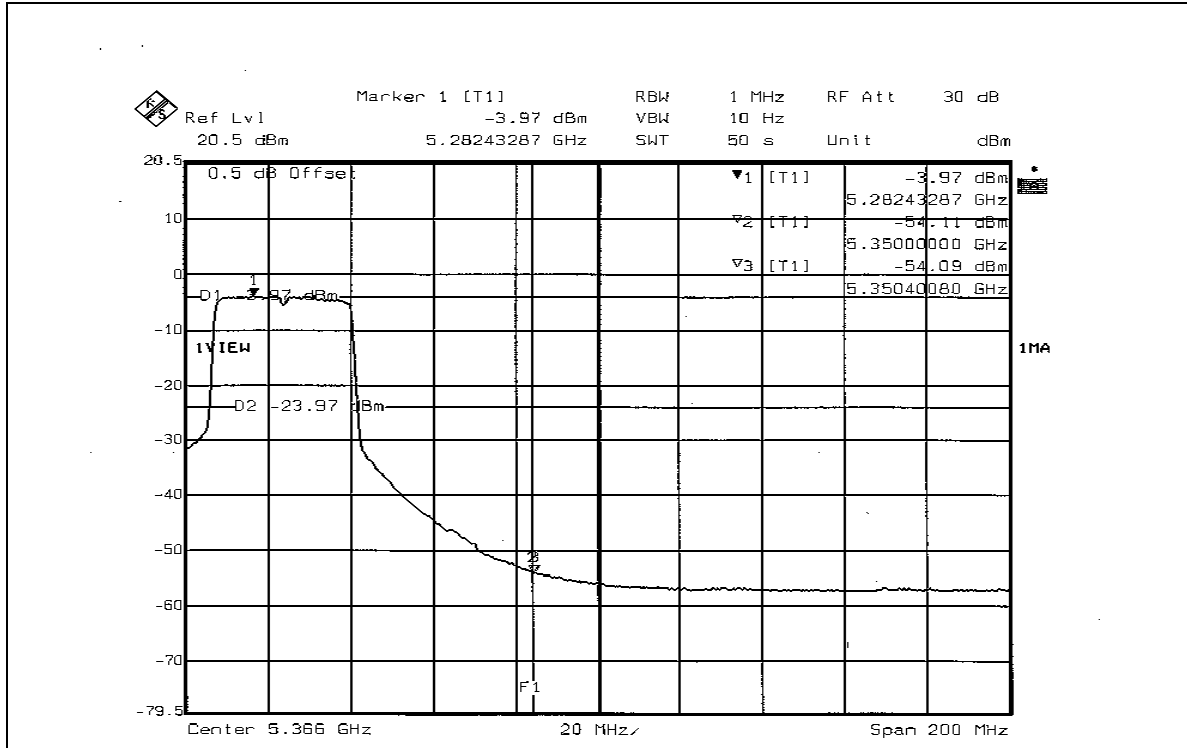



4.8 ANTENNA REQUIREMENT

4.8.1 STANDARD APPLICABLE

For intentional device, according to FCC 47 CFR Section 15.203, an intentional radiator shall be designed to ensure that no antenna other than that furnished by the responsible party shall be used with the device.

And according to FCC 47 CFR Section 15.407(a), if transmitting antennas of directional gain greater than 6dBi are used, the power shall be reduced by the amount in dB that the directional gain of the antenna exceeds 6dBi.

4.8.2 ANTENNA CONNECTED CONSTRUCTION

The antenna used in this product is Dipole antenna with Reverse SMA antenna connector. The maximum Gain of the antenna is 4.0dBi.

5. PHOTOGRAPHS OF THE TEST CONFIGURATION

CONDUCTED EMISSION TEST



RADIATED EMISSION TEST

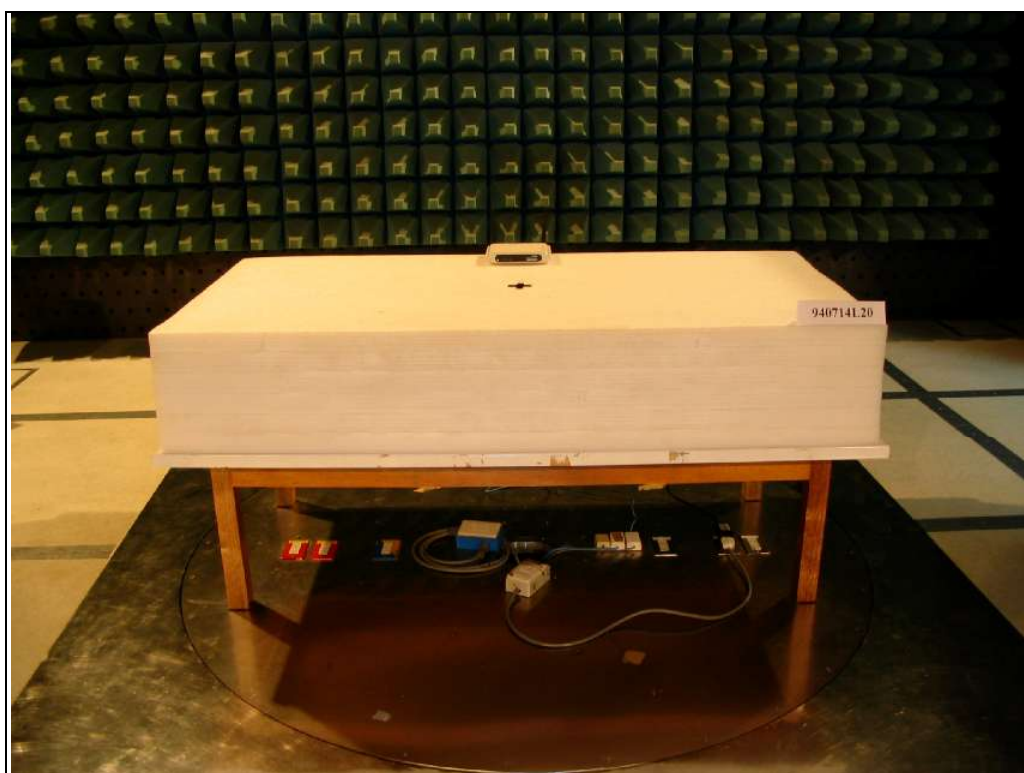
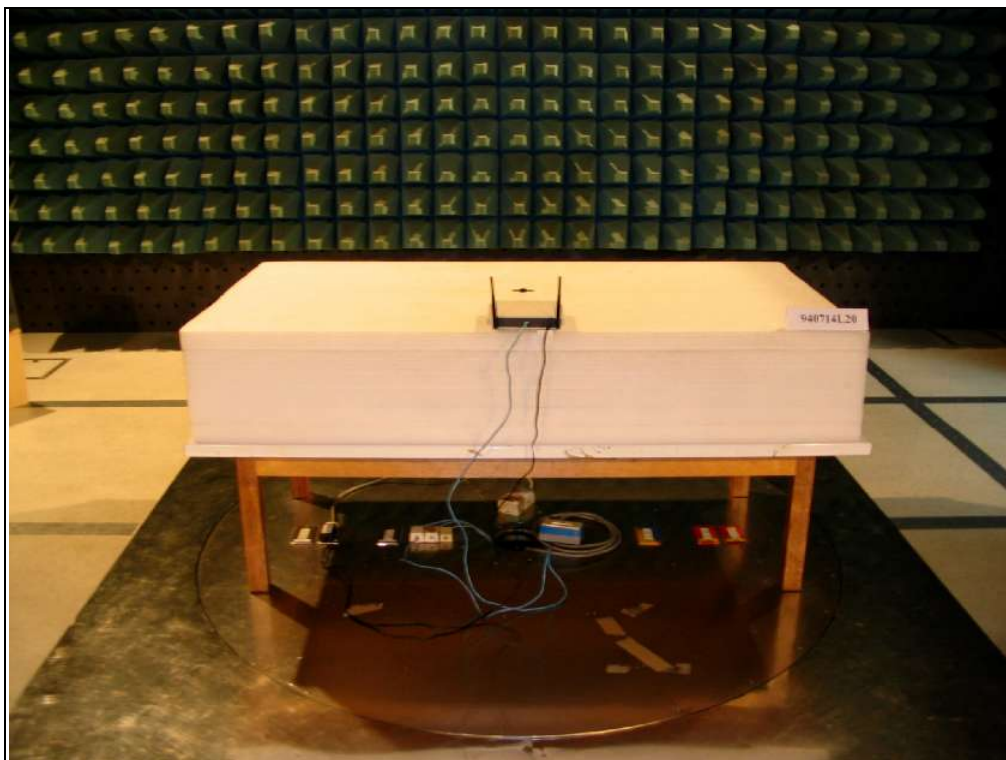



6. INFORMATION ON THE TESTING LABORATORIES

We, ADT Corp., were founded in 1988 to provide our best service in EMC, Radio, Telecom and Safety consultation. Our laboratories are accredited and approved by the following approval agencies according to ISO/IEC 17025:

USA	FCC, NVLAP, UL, A2LA
Germany	TUV Rheinland
Japan	VCCI
Norway	NEMKO
Canada	INDUSTRY CANADA , CSA
R.O.C.	CNLA, BSMI, DGT
Netherlands	Telefication
Singapore	PSB , GOST-ASIA(MOU)
Russia	CERTIS(MOU)

Copies of accreditation certificates of our laboratories obtained from approval agencies can be downloaded from our web site:

www.adt.com.tw/index.5/phtml. If you have any comments, please feel free to contact us at the following:

Linko EMC/RF Lab:

Tel: 886-2-26052180

Fax: 886-2-26052943

Hsin Chu EMC/RF Lab:

Tel: 886-3-5935343

Fax: 886-3-5935342

Hwa Ya EMC/RF/Safety Telecom Lab:

Tel: 886-3-3183232

Fax: 886-3-3185050

Linko RF Lab.

Tel: 886-3-3270910

Fax: 886-3-3270892

Web Site: www.adt.com.tw

The address and road map of all our labs can be found in our web site also