

## ANNEX B: INTERNAL CONSTRUCTION PHOTOS OF EUT

### 1. Inside View 1 of EUT

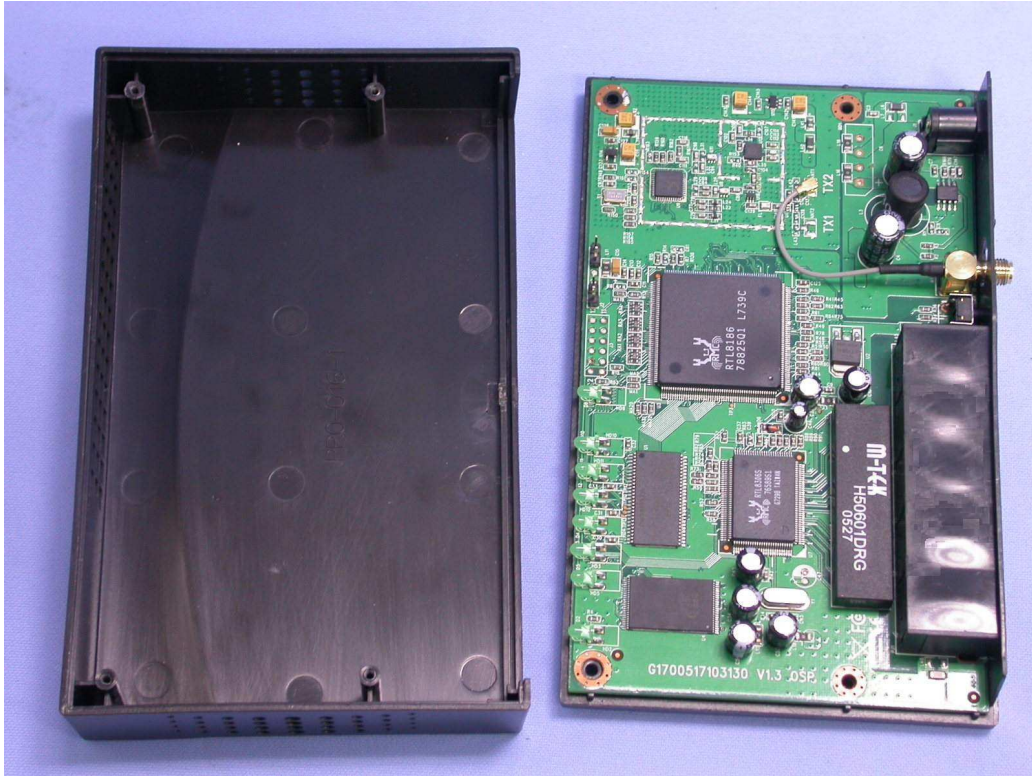

### 2. Inside View 2 of EUT

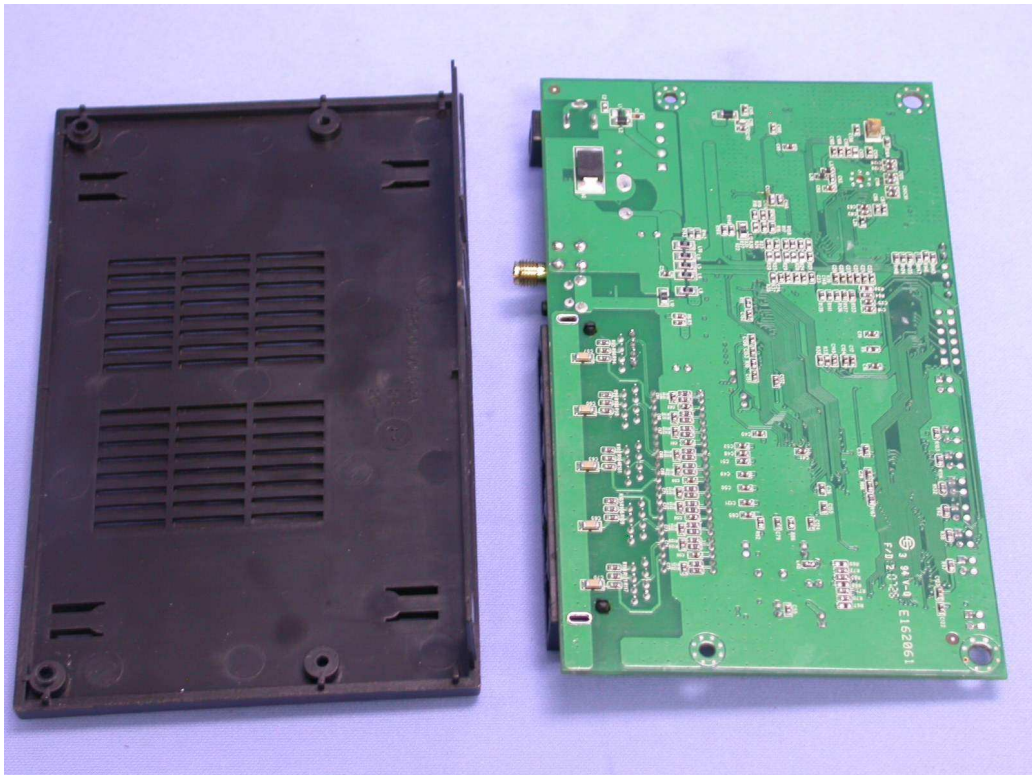

3. Inside View 3 of EUT

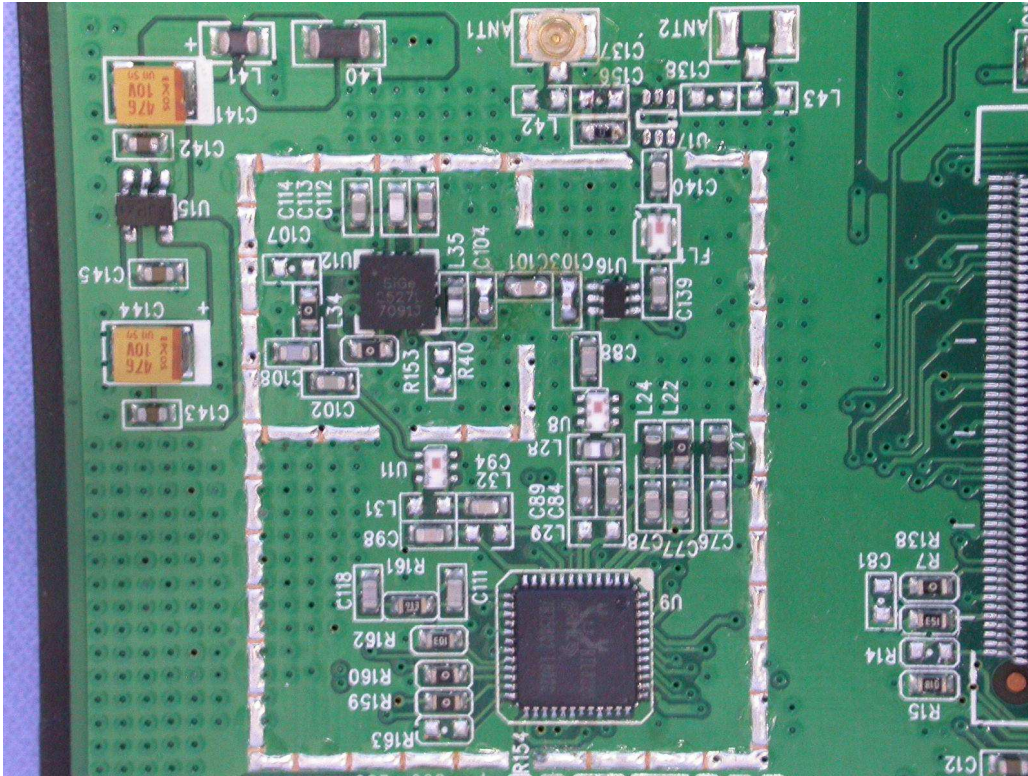

4. antenna

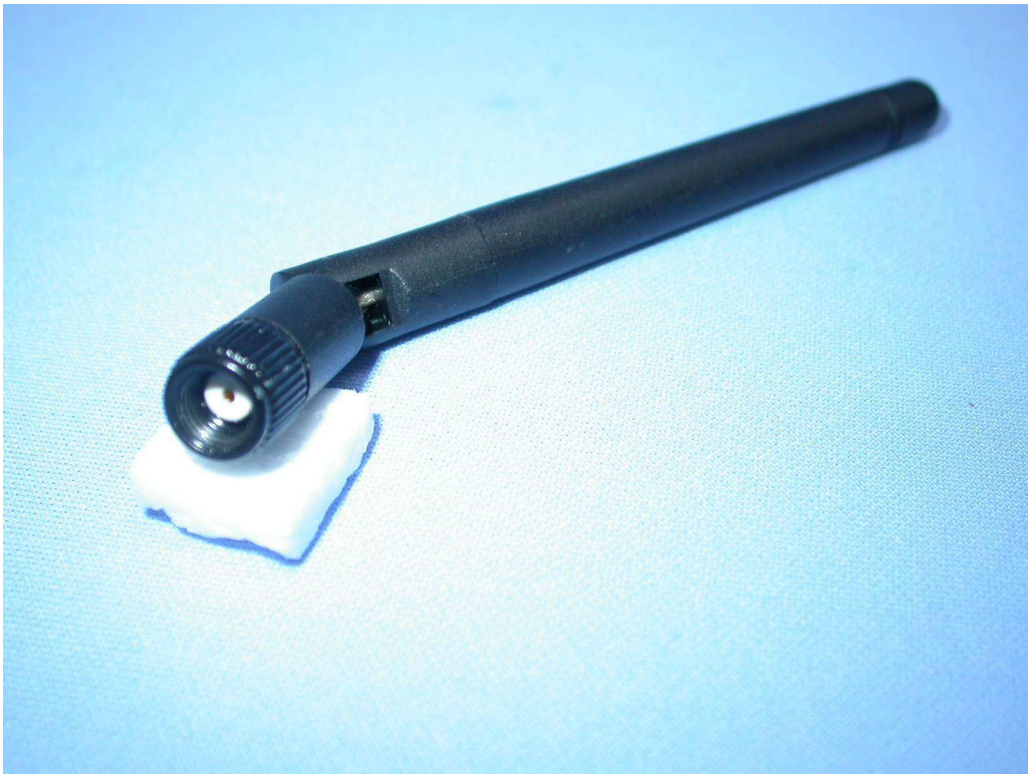

5. antenna



6. antenna



7. antenna



8. Front view of PCB

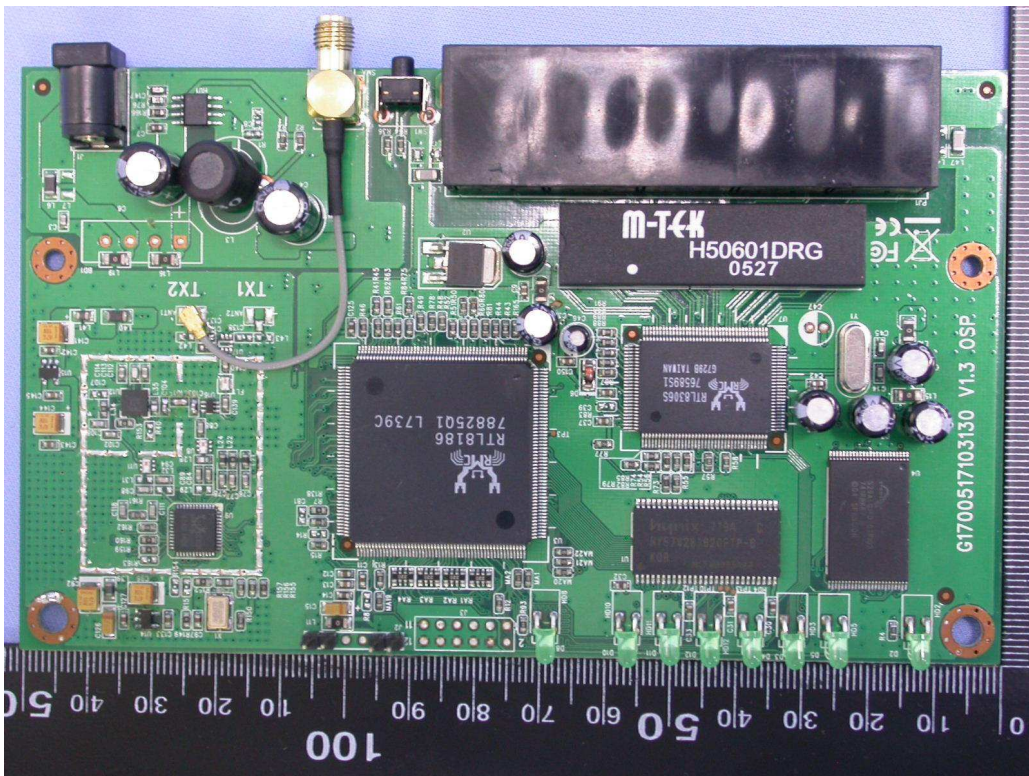

9. Rear view of PCB

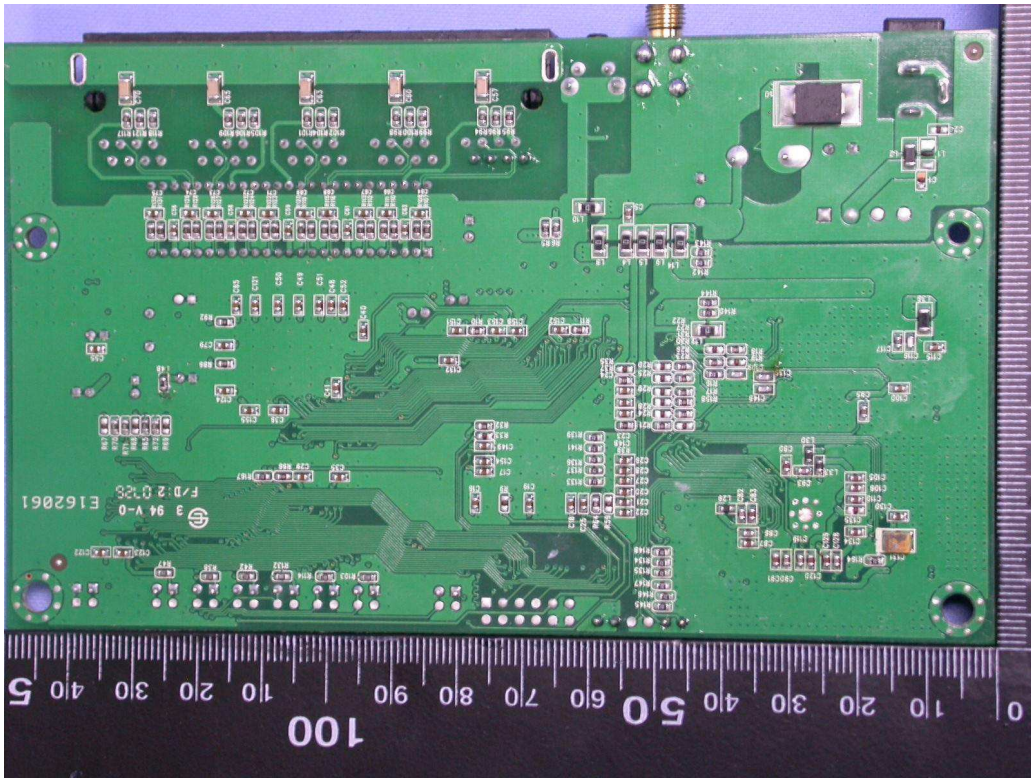

10. antenna

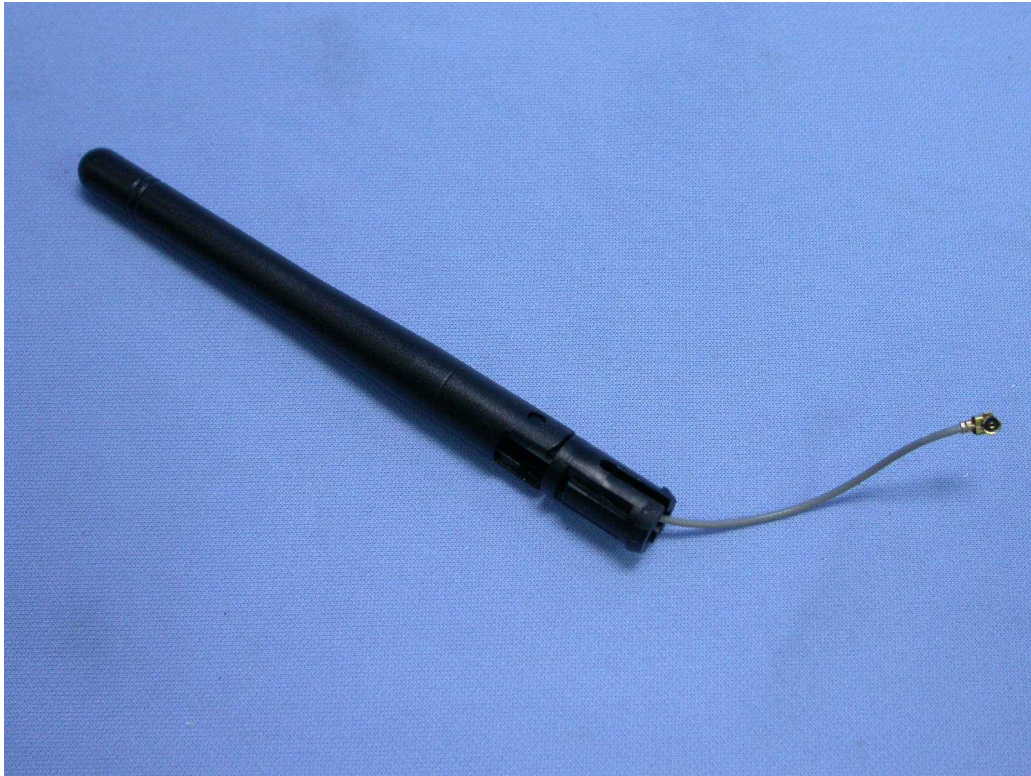

11. antenna



12. antenna

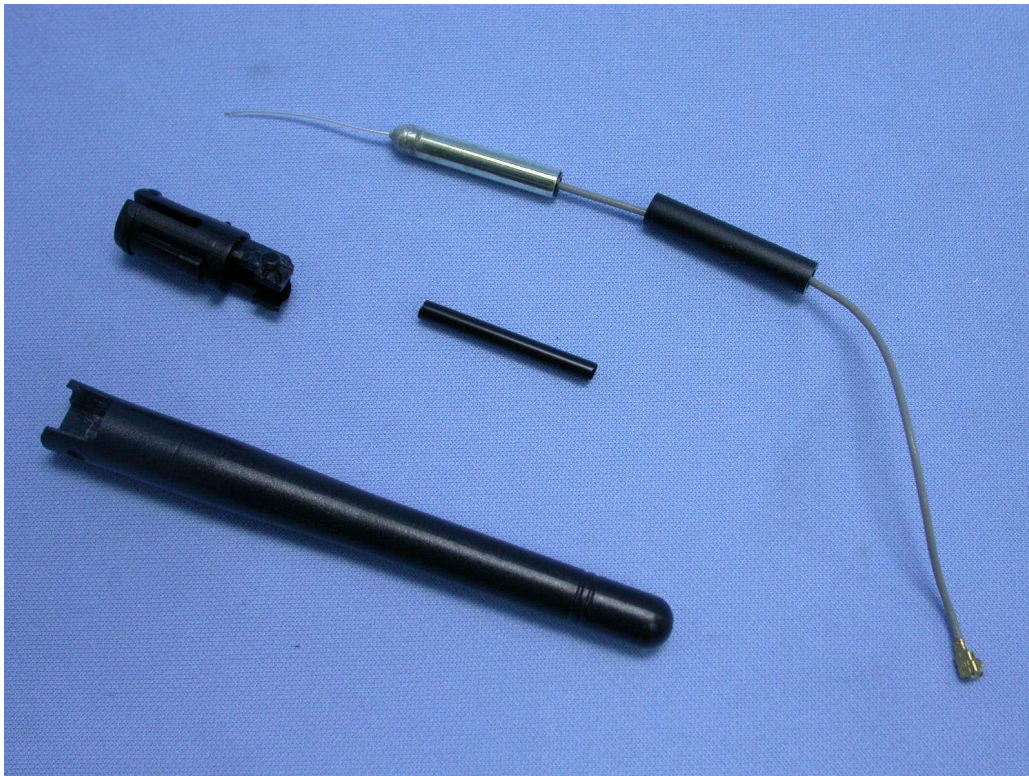

13. antenna

