

亞 驪 企 業 股 份 有 限 公 司  
ARISTOTLE ENTERPRISES

承 認 申 請 書

客戶名稱: 捷超通訊科技股份有限公司  
Customer  
廠商料號: RFA-02-C2M2-Ni  
Part No.  
品名: 2.4GHz, 鍍鎳 CON, 無鉛製程  
Description  
圖號: RFA-02-C2M2-Ni.DWG  
Drawing No.  
客戶料號:  
Drawing No.

出廠簽章:

檢 查 TEST BY	核 對 CHECK BY	承 認 APPROVE BY
周沂珮	黃秋芳	廖煥文

承認簽章:

檢 查 TEST BY	核 對 CHECK BY	承 認 APPROVE BY

地址:台北縣中和市莒光路 63 號 8 樓

電話:02-2225-8209

傳真:02-2225-7523

最小包裝：每 10 PCS裝入一夾鏈袋  
 單支重量：10.19 g

1	2	3	4	5
NO.	NAME	FINISH	MAT'L	Q'TY
1.	Hinge	BLACK	ABS	1
2.	Tube	BLACK	ABS	1
3.	Connector	-	Ni	1
			MEMO	RP SMA PLUG

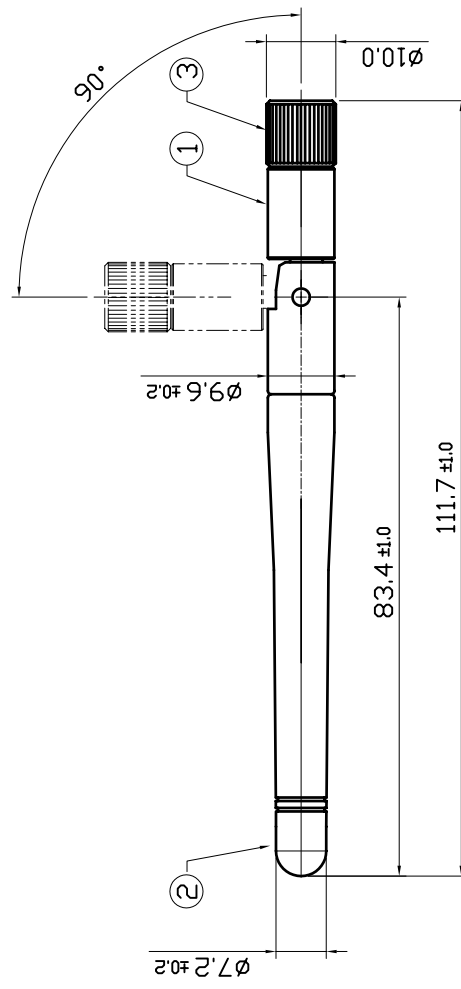

**ARISTOTILE ENTERPRISES INC.** 亞 驪 企 業 股 份 有 限 公 司

PROJECTION	UNITS	mm	TITLE
SCALE	1/1		RFA-02-C2M2-Ni
PAPER	A4		DWG NO.
APPD.			
CHKD			
DESIGN			
DRAW	J.W.Lee	04/07/29	RFA-02-C2M2-Ni.DWG

REV	ECN	NAME	DATE
4.			
3.			
2.			
1.			

SHEET 1/1  
REV. A

1	2	3	4	5
1	2	3	4	5
1	2	3	4	5
1	2	3	4	5

# 5. Antenna radiation patterns

## 5-1. 11b dipole Antenna Radiation pattern : E-Plane

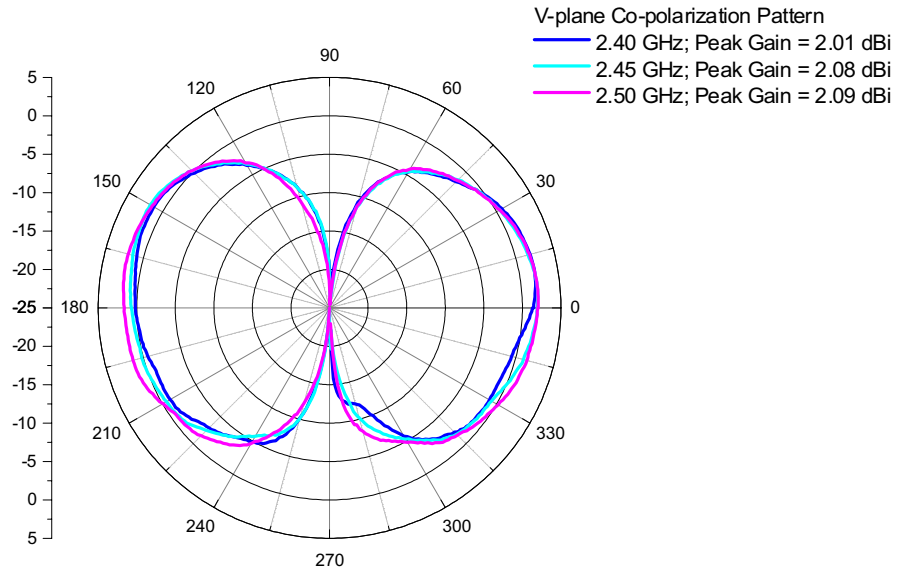

## 5-2. 11b dipole Antenna Radiation pattern : H-Plane

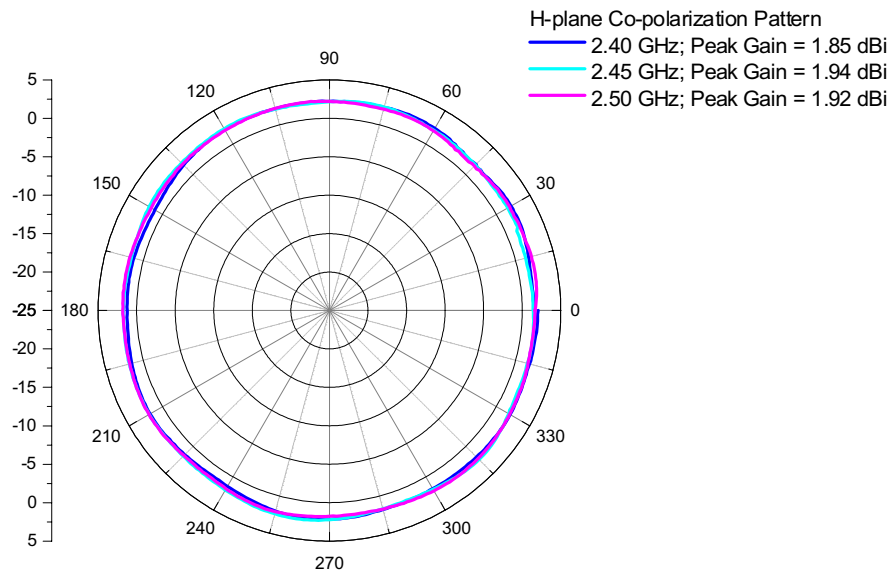

## 6. Antenna VSWR/Return Loss

### 6-1. 11b dipole Antenna VSWR

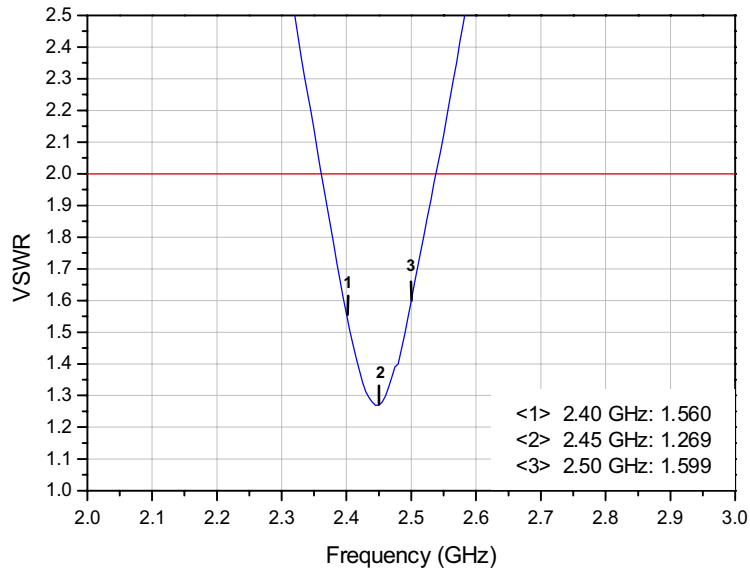

### 6-2. 11b dipole Return Loss

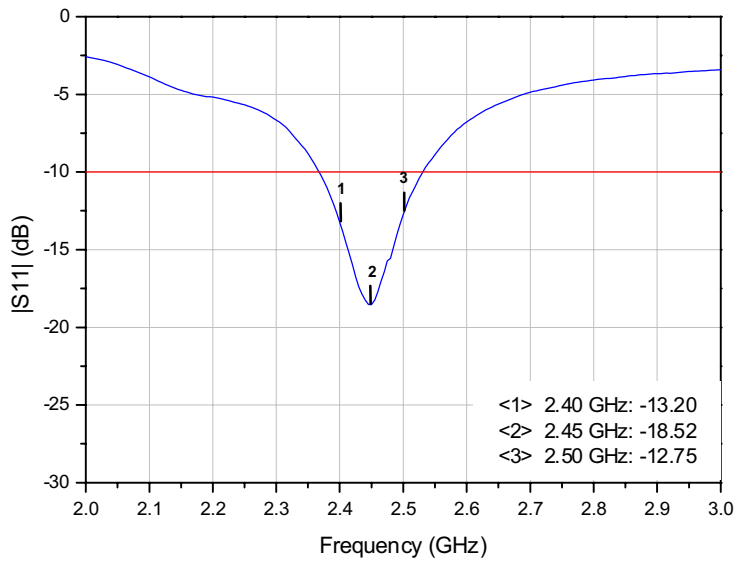



# CHI MEI CORPORATION

59-1 SAN CHIA, JEN TE, TAINAN COUNTY, TAIWAN R.O.C. TEL: 886-6-266-5000, FAX: 886-6-266-5555-7

## 泛用級 ABS, POLYLAC<sup>®</sup> PA-757

VIW

### 材料特性

特性(Properties)	測試方法(Test Method)	測試條件(Test Condition)	單位(Unit)	PA-757
引張強度 Tensile Strength	ASTM D638	1/8", 6 mm/min	Kg/cm <sup>2</sup> (lb/in <sup>2</sup> )	480(6800)
延伸率 Tensile Elongation	ASTM D638	1/8", 6 mm/min	%	20
彎曲強度 Flexural Strength	ASTM D790	1/4", 2.8 mm/min	Kg/cm <sup>2</sup> (lb/in <sup>2</sup> )	820(11660)
彎曲彈性率 Flexural Modulus	ASTM D790	1/4", 2.8 mm/min	Kg/cm <sup>2</sup> (lb/in <sup>2</sup> )	27000(380000)
IZOD 衝擊強度 Izod Impact Strength	ASTM D256(Notched)	1/4", 23°C 1/8", 23°C	Kg-cm/cm(ft-lb/in) Kg-cm/cm(ft-lb/in)	18(3.3) 20(3.7)
流動係數 Melt Flow Index	ASTM D1238	200°C, 5Kg	g/10min	1.8
硬度 Hardness	ASTM D785	1/2"	R Scale	116
比重 Specific Gravity	ASTM D792	23°C	-	1.05
軟化點 Vicat Softening Temp	ASTM D1525	1/8", 50°C/hr	°C(°F)	105(221)
熱變形溫度 H.D.T Annealed(85°C, 8hr) Unannealed	ASTM D648	1/4", 120°C/hr	°C(°F)	99(210) 88(190)
燃燒率 Flammability	UL 94	-	-	1/16"HB

以上數據僅代表一般通用數據，不代表每一產品的規格值

若有任何疑問請洽產品推廣課 06-2665000, 06-2663000



# 奇美實業股份有限公司

台灣省台南縣仁德鄉三甲村59-1號 電話：886-6-266-5000, 傳真：886-6-266-5555~7

1/2(A-GHE)

## 物質安全資料表

VIW

### 1. 物品及廠商資料

產品名稱	Polylac <sup>®</sup>	PA-707	PA-757	PA-757N	PA-717C	PA-727	PA-747	PA-709
製造商	奇美實業股份有限公司							
地址	台灣省台南縣仁德鄉三甲村59-1號							
電話	886-6-2663000 Ext.1361 (產品推廣課)							
緊急電話	886-6-2663000 Ext.1361 (產品推廣課)							
傳真電話	886-6-2667981							

### 2. 成品辨識資料

單一產品或混合物	單一產品
化學名稱	Acrylonitrile-Butadiene-Styrene Copolymer
含量	>98% (添加劑≤2%)
化學式	(C <sub>3</sub> H <sub>3</sub> N, C <sub>4</sub> H <sub>6</sub> , C <sub>8</sub> H <sub>8</sub> ) <sub>x</sub>
CAS No.	9003-56-9
危害性不純物	無

### 3. 危害性分類

健康危害效應	無
環境影響	無
物理性及化學性危害	無
特殊危害	無

### 4. 急救措施

吸入	若吸入熔融樹脂逸出之氣體，將患者移至通風處，立即送醫。
皮膚接觸	若接觸到塑膠粒或塑膠粉末，以清水沖洗。
	若接觸到熔膠，以大量(肥皂)水沖洗患部及衣物，立即送醫。
眼睛接觸	若接觸到塑膠粒或塑膠粉末，以大量清水至少沖洗15分鐘。
	若有不適，立即送醫。
	若接觸到高溫熔融樹脂逸出之氣體，以大量清水至少沖洗15分鐘。
	若有不適，立即送醫。
吞食	催吐，以清水漱口，若有不適，立即送醫。

### 5. 消防措施

適用滅火劑	水、泡沫、乾粉
滅火時可能遭遇之特殊危害	無
特殊滅火程序	移除可燃物
消防人員之特殊防護設備	使用供氧式呼吸防護具

### 6. 洩漏處理方法

個人應注意事項	若塑膠粒或塑膠粉末殘留於地面上，可能會導致人員滑倒。
環境注意事項	為防止鳥類或魚類由排水系統中攝食，須徹底回收
清理方法	回收或廢棄

### 7. 安全處置與儲存方法

處置	操作處所須嚴禁煙火，做好整理整頓以避免粉塵累積。為防止塵爆，空氣輸送管路、袋濾器及儲槽須加裝靜電消除裝置，並確實接地。袋濾器之濾材採導電性材質。
儲存	存放於陰涼處所，避免直射陽光、雨淋及急遽之溫差。儲存處嚴禁煙火



# 奇美實業股份有限公司

台灣省台南縣仁德鄉三甲村59-1號 電話：886-6-266-5000, 傳真：886-6-266-5555-7

2/2(A-GHE)

## 8. 暴露預防措施

容許濃度(TLV)  
通風設備  
個人防護設備

未定  
排除粉塵、煙及氣體時使用  
呼吸防護 清洗成型機時使用防毒面具。  
手部防護 接觸熔膠時使用皮手套。  
眼睛防護 平時使用安全眼鏡，清洗成型機時使用護目鏡

## 9. 物理及化學性質

物質狀態  
形狀  
顏色  
氣味  
閃火點  
自燃溫度  
爆炸界限  
最小著火能量  
最大爆炸壓力  
最大壓力上升速度  
比重  
溶解度

米白色膠粒  
粒狀  
米白色  
無  
404 °C  
466 °C  
45 g/m<sup>3</sup>  
3.6 mJ  
7 × 10<sup>5</sup> Pa  
3.2 × 10<sup>7</sup> Pa/S  
1.03-1.10  
無

## 10. 安定性及反應性

安定性  
危害性分解物  
燃燒能量

依一般操作及儲存程序時，安定性佳。  
CO, HCN, AN, SM and NO.  
3.53 × 10<sup>7</sup> J/kg (8424 Kcal/kg)

## 11. 毒性資料

刺激性

分解後之塑膠所產生的煙及蒸氣會刺激眼睛。

## 12. 生態資料

為防止被海洋生物或鳥類攝食，嚴禁丟棄至海洋或水域。

## 13. 廢棄物處理

適當之焚化爐燃燒或掩埋法。不適當之焚化爐可能會產生有毒氣體如 CO, HCN, AN and SM.

## 14. 運送資料

未分類

## 15. 法規資料

無

## 16. 其他資料

無

**CHI MEI CORPORATION**

59-1 SAN CHIA JEN TE TAINAN HSIEN TAIWAN

Material Designation: PA-757 (+)

Product Description: Acrylonitrile Butadiene Styrene (ABS), designated "Polylac" furnished as pellets.

Color	Min. Thick. (mm)	Flame Class	HWI	HAI	RTI Elec	RTI Imp	RTI Str	IEC GWIT	IEC GWF1
ALL	1.5	HB	4	0	85	80	85	-	-
	3.0	HB	3	0	85	80	85	-	-
<b>CTI: 0</b>	<b>IEC CTI: -</b>	<b>HVTR: 1</b>			<b>D495: 1</b>			<b>IEC Ball Pressure (°C): -</b>	
<b>Dielectric Strength (kV/mm): -</b>					<b>Volume Resistivity (10<sup>9</sup>ohm-cm): -</b>			<b>Dimensional Stability(%): -</b>	
<b>ISO Tensile Strength (MPa): -</b>					<b>ISO Flexural Strength (MPa): -</b>			<b>ISO Heat Deflection (°C): -</b>	
<b>ISO Tensile Impact (kJ/m<sup>2</sup>): -</b>					<b>ISO Izod Impact (kJ/m<sup>2</sup>): -</b>			<b>ISO Charpy Impact (kJ/m<sup>2</sup>): -</b>	

(+) Optional prefix or suffix may be used to denote 0-0.5% acid scavengers.

Report Date: 6/23/1983

Underwriters Laboratories Inc®

UL94 small-scale test data does not pertain to building materials, furnishings and related contents. UL 94 small-scale test data is intended solely for determining the flammability of plastic materials used in components and parts of end-product devices and appliances, where the acceptability of the combination is determined by

ULI.





# CHI MEI CORPORATION

59-1 SAN CHIA, JEN TE, TAINAN COUNTY, TAIWAN R.O.C. TEL: 886-6-266-5000, FAX: 886-6-266-5617

Data issued: May 25, 2005

We hereby certify that the follow Polylac ABS resin (list as follow) produced by Chi Mei Corporation

GP-Grade	PA-707, PA-757, PA-717C, PA-727, PA-747, PA-709,
HF-Grade	PA-756, PA-756S, PA-756H, PA-756B, PA-716, PA-746, PA-746H, PA-737
Extrusion Grade	PA-747F, PA-747R, PA-747S, PA-709S
HH-Grade	PA-777B, PA-777D, PA-777E
Transparent Grade	PA-758

conforms to the requirement that no chemicals as following are added.

1. PBBEs (Poly Bromo Bisphenyl Ethers)
2. PBBs (Poly Bromo Bisphenyls)
3. Ozone Depleting Chemicals(CFC's&HCFC'S)
4. Chlorinated Paraffin (C10-C13)
5. Polyvinyl Chloride (PVC)
6. Mercury(Hg) and its compounds,
7. Lead(Pb) and its compounds,
8. Cadmium(Cd) and its compounds,
9. Chromium(Cr) and its compounds,
10. Arsenic(As) and its compounds,
11. Antimony(Sb) and its compounds,
12. Selenium(Se) and its compounds,
13. Barium(Ba) and its compounds,
14. Chromium(Cr) VI and its compounds
15. Organic tin compounds
16. Polychlorinated Biphenyls(PCB's) and Terphenyls(PCT's)
17. Poly naphthalenes
18. Azo compounds
19. Polychlorinated biphenyl
20. Polychlorinated naphthalene
21. Asbestos
22. Phthalates

With regard to composition of above grade, they can comply with the Directives of RoHS (2002/95/EC), 2003/11/EC, TCO'99, Blue Angel and SONY (SS-00259)

Sincerely Yours,

Eric Chou

Manager

Department of Product Strategy & Service

This statement is based on our current level of knowledge and covers the above resins as supplied by CHI MEI CORPORATION at the date of issue. Since conditions of use are outside CHI MEI CORPORATION's control, CHI MEI CORPORATION makes no warranties, express or implied, and assumes no liability in connection with any use of this information.



# Aliner Industries, Inc.

## Material Certificate KUON CHEN HARDWARE CO., LTD

Material	FREE CUTTING BRASS ROD.	Alloy no.	C 3604 BD
Chemical Testing			
Testing method	X Ray Spectrogram Analysis		
Testing Equipment	Vacuum X Ray Spectrograph		
Compounds	Standard content(%)	Sample content (%)	
Cu	57.0~61.0	57.88	
Zn	REMAINDER	REMAINDER	
Fe	<0.5	-----	
Pb	1.8~3.7	3.18	
Other	<1.2	0.7	
Mechanical Testing			
Testing method	Hydraulic pulling test		
Equipment used	Computer universal testing machine	Electronic hardness testing machine	
Physical characteristic	Tensile-strength	Yield strength	Elongation
Required reading	Kg/mm <sup>2</sup>	Kg/mm <sup>2</sup>	%
Actual reading	Kg/mm <sup>2</sup>	Kg/mm <sup>2</sup>	%
Description			

# BRUSHWELLMAN

ENGINEERED MATERIALS

Shoemakersville Road, Shoemakersville, PA 19555  
Phone: 610-562-2211 ; Fax: 610-562-6610

Advance Technical Products Limited  
1003 Pacific Trade Centre  
2 Kai Hing Road, Kowloon Bay  
KOWLOON  
HONG KONG

Material Certificate				
Date	05/02/2003			
Purchase order item/date	S81249 / 04/02/2003			
Delivery item/date	80196127 900001 / 05/09/2003			
Order item/date	117399 000010 / 04/03/2003			
Customer nbr	Customer part nbr			
ZQ000				
Customer spec	BWJ-RW5.00-2			
Rev	Type	Comp	Class	Grade

4.0

Our Material: K549121100 ROD CD M25 H .15748 X *TM0310-R*

Brush Wellman testing for chemical composition (by Optical Emission Spectrometry), is conducted at our Elmore, OH Laboratories. Testing of mechanical, or physical properties is conducted at Laboratories which are accredited by American Association for Laboratory Accreditation.

This material was inspected and tested for conformity as required in accordance with the noted part, specification, and revision number. The quantitative test data obtained from these tests are available for review by the buyer.

Batch 0000319331 / Quantity 408 LBS

Characteristic	Unit	Value	Specification Limits	
			Lower	Upper

CDA (UNS) Alloy	-	C17300		
ASTM Temper	-	TD04		
Brush Spec Nbr.	-	BWJ-RW5.00-2		

Dimensional Attributes

Diameter	-	0.15748		
Diameter Plus	-	0.00059		
Diameter Minus	-	0.00059		
Length	-	98.42525		
Length Plus	-	0.25000		
Length Minus	-	0.00000		



Mechanical/Physical Properties

Grain Size	mm	0.015 0.024		0.050
Tensile	kgf	71.0 72.0	67.0	77.0
Yield	kgf	58.0 61.0	52.0	74.0
Elongation	%	15.0	10.0	
Hardness Scale	-	HR30T		
Hardness Value	-	79.0 80.0	77.0	83.0

The material supplied with this certification has not been heat treated. The following properties were achieved in Brush Wellman's laboratory. They represent what you may expect after heat treating the material, using the time and temperatures shown.

R1 Temper	-	HT		
R1 Heat Treat Time	hrs	2.00	2.00	2.00
R1 Heat Treat Temp	°C	316	316	316

# BRUSHWELLMAN

ENGINEERED MATERIALS

Advance Technical Products Limited  
 1003 Pacific Trade Centre  
 2 Kai Hing Road, Kowloon Bay  
 KOWLOON

Delivery item/date  
 80196127 900001 /  
 05/09/2003

Page  
 2 of 2

R1 Tensile	kgf	137.0 138.0	130.0	158.0
R1 Yield	kgf	129.0 130.0	116.0	
R1 Elongation	%	2.0 3.0	2.0	
R1 Hardness Scale	-	HR30N		
R1 Hardness Value		62.0	53.5	63.0

Chemistry Composition

Beryllium	%	1.83	1.80	2.00
Ni+Co	%	0.25		0.35
Ni+Co+Fe	%	0.28		0.60
Silicon	%	0.04		0.15
Aluminum	%	0.02		0.10
Lead	%	0.34	0.20	0.40
Alloy Balance	-	COPPER		

Lot Identification

Heat Number	-	28176
Piece Lot Number	-	11739911

*Jack Gatehouse*

Quality Representative

TM0310-R



# Properties of various fluoropolymers

	Properties	Unit	ASTM test method	PTFE		
PHYSICAL	Melting point	°C	-	327		
	Specific gravity	-	D792	2.14-2.20		
	Tensile strength	MPa (kgf/cm <sup>2</sup> )	D638	13.7-34.3 (140-350)		
	Elongation	%	D638	200-400		
	Compressive strength	MPa (kgf/cm <sup>2</sup> )	D695	11.8 (120)		
MECHANICAL	Impact strength (Aizot)	J/m (kgf·cm/cm)	D526A	160 (16.3)		
	Hardness (Rockwell)	-	D785	-		
	Hardness (Shore)	-	D2240	D50-55		
	Bending elasticity	GPa (10 <sup>3</sup> kgf/cm <sup>2</sup> )	D790	0.55 (5.6)		
	Tensile Strength	GPa (10 <sup>3</sup> kgf/cm <sup>2</sup> )	D638	0.40-0.55 (4.1-5.6)		
	Coefficient of dynamic friction	-	0.69MPa (7kgf/cm <sup>2</sup> ) 3m/min	0.10		
	Thermal conductivity	W/(m·K) (kcal/(m·hr·°C))	C177	0.25 (0.22)		
	Specific heat	J/(°C·g) (cal/(°C·g))	-	1.05 (0.25)		
	Coefficient of linear expansion	10 <sup>-5</sup> /°C	D696	10		
	Ball pressure	°C	-	180		
THERMAL	1.81MPa (18.5kgf/cm <sup>2</sup> )	°C	D648	55		
	0.45MPa (4.6kgf/cm <sup>2</sup> )	°C	-	121		
	Max. Service Temperature	°C	Unloaded	260		
	Volumetric resistance ratio	Ω·cm	D257 (50% RH/235)	>10 <sup>10</sup>		
	Dielectric breakdown strength (Short term)	MV/m kV/mm (3.2mm thickness)	D149	19		
	ELECTRICAL	Dielectric constant	60Hz	pF/m	D150	<18.6 (<2.1)
			10 <sup>3</sup> Hz	pF/m	D150	<18.6 (<2.1)
			10 <sup>6</sup> Hz	pF/m	D150	<18.6 (<2.1)
		Dielectric dissipation factor	60Hz	-	D150	<0.0002
			10 <sup>3</sup> Hz	-	D150	<0.0002
10 <sup>6</sup> Hz			-	D150	<0.0002	
Anti arcing property	sec	D495	>300			
Water absorption (24h)	%	D570	0.00			
DURABILITY	3.2mm thickness combustibility	-	(UL-94)	V-0		
	Oxygen index	-	D2863	>95		
	Effect of direct sunlight	-	-	No		
	Effect of weak acid	-	D543	No		
	Effect of strong acid	-	D543	No		
	Effect of weak alkali	-	D543	No		
	Effect of strong alkali	-	D543	No		
	Effect of solvent alkali	-	D543	No		



# SPECIFICATION FOR APPROVAL

DOCUMENT: A30178B001

---

STYLE : 200°C 30V  
RG-178B/U

---

SIZE: 7/0.102 SCCS

---

RECOGNIZED:

---

## WONDERFUL WIRE CABLE CO.,LTD

OFFICE : 72WU KONG 6TH ROAD,  
WU KU IND. DISTRICT  
TAIPEI HSIEN,TAIWAN

FACTORY : 17 PEI YUAN ROAD,  
CHUNG-LI IND. PARK  
TAIWAN, R.O.C.

TEL : (02)22988033  
FAX : (02)22988031-2

TEL : (03)4527777  
FAX : (03)4517214

WONDERFUL WIRE CABLE CO., LTD



# SPECIFICATION

STYLE	200°C 30V COAXIAL	DOCUMENT NO : A30178B001	
SIZE	RG-178B/U	ESTABLISHED DATE: 2000/06/29	
STANDARD : MIL-C-17			
Conductor	Size	AWG	30
	Material	----	Silver-Coated Copper Clad Steel
	Conductors No.	----	7
	Conductors Size	mm	0.102
	O.D.	mm	0.30
Insulation	Average Thickness	mm	0.28
	Diameter	mm	0.86
	Material	----	FEP
	Color	----	Clear
Braid	Material	----	Silver-Coated Copper
	Construction	mm	16 / 3 / 0.10
	Coverage	%	95
Jacket	Average Thickness	mm	0.25
	Diameter	mm	1.80 ±0.05
	Material	----	FEP
	Color	----	Brown
Marking	M17/93-RG178B/U WONDERFUL		
Drawing			

AK001/210X297/1.0

PAGE : 1

EDITION : 1.0

REVISED DATE :

MAKER :

CONFIRM :

APPROVAL :

## WONDERFUL WIRE CABLE CO., LTD

# SPECIFICATION

Electrical & Physical Properties						
Item		RG-178B/U				
Rating Temp Voltage		200°C 30V				
Conductor Resistance		838.0 OHM/KM/20°C MAX.				
Insulation Resistance		100 MEGA OHM/KM MIN.				
Dielectric Strength		AC 1.0 KV/Minute				
Spark Test		0.5 KV				
Insulation	Unaged	Tensile Strength	2500 PSI MIN.( 1.76 Kg / m m <sup>2</sup> )			
		Elongation	200% MIN.			
	Aged	Tensile Strength	<b>UNAGED MIN.75%(168HRS×232°C)</b>			
		Elongation	<b>UNAGED MIN.75%(168HRS×232°C)</b>			
Jacket	Unaged	Tensile Strength	2500 PSI MIN.( 1.76 Kg / m m <sup>2</sup> )			
		Elongation	200% MIN.			
	Aged	Tensile Strength	<b>UNAGED MIN.75%(168HRS×232°C)</b>			
		Elongation	<b>UNAGED MIN.75%(168HRS×232°C)</b>			
Nom. Impedance		50 Ohms				
VSWR		MAX. 1.3 at 0.4G~3GHz				
Nom. Vel. of Prop.		69.5%				
Flame Test		VW-1 OK				
Attenuation (dB/100m)	50MHz	100MHz	400MHz	900MHz	1.8GHz	3GHz
	34.4	45.9	91.8	139.4	207.5	308.2

AK001/210X297/1.0

PAGE : 2

EDITION : 1.0

REVISED DATE :

MAKER :

CONFIRM :

APPROVAL :



RoHS REPORT INDEX-RFA-02-C2M2-Ni

	NAME	供應商	RoHS report
1	ANTENNA HOUSING/HINGE-PA757	CHI MEI CORPORATION	KE/2006/10283
2	CONNECTOR		
2-1	銅合金 C3604	元祥金屬工業股份有限公司	CE/2005/53261A
2-2	BERYLLIUM COPPER C17300 M25	TAI MAO TECHNOLOGY CO., LTD.	CE/2005/84740
2-3	PTFE-鐵弗龍	宏庫貿易有限公司	ET940-09-035
2-4	鍍鎳-硫酸鎳	祐電精密有限公司	CE/2006/80517
3	CABLE-RG178	WONDERFUL HI-TECH CO., LTD.	CE/2006/10628



Chemical Laboratory - Kao.,SGS Taiwan Ltd.

**TEST REPORT**

REPORT NO.KE/2006/10283  
DATE: 2006/1/11  
PAGE: 1 OF 2

THE FOLLOWING MERCHANDISE WAS(WERE) SUBMITTED ON BEHALF OF THE CLIENT AND IDENTIFIED AS :

**CLIENT** : CHI MEI CORPORATION.  
**ADDRESS** : 59-1,SAN CHIA,JEN TE HSIANG,TAINAN COUNTY,TAIWAN,R.O.C.  
**PRODUCT DESCRIPTION** : ACRYLONITRILE-BUTADIENE-STYRENE COPOLYMER.  
: (AS ATTACHED SAMPLE PHOTO).  
**COLOR** : NATURAL.  
**STYLE/ITEM NO.** : POLYLAC@ PA-757.  
**TESTING DATE** : 2006/01/05 TO 2006/1/11 .  
**SAMPLE RECEIVED** : 2006/01/05.

WE HAVE TESTED THE SAMPLE(S) SUBMITTED AS REQUESTED AND THE FOLLOWING RESULTS WERE OBTAINED.

TEST ITEM(S)	UNIT	METHOD	DET. LMT	RESULT
Cadmium (Cd)	ppm	ICP-AES after reference to EN 1122, method B:2001 or other acid digestion.	2	n.d.
Lead (Pb)	ppm	ICP-AES after reference to US EPA 3050B or other acid digestion.	2	n.d.
Mercury (Hg)	ppm	ICP-AES after reference to US EPA 3052 or other acid digestion.	2	n.d.
Chromium VI (Cr+6)	ppm	As per US EPA 7196A and US EPA 3060A.	2	n.d.



*[Signature]*  
**Kueilan Chen / Asst. Supervisor**  
Signed for and on behalf of  
SGS Taiwan Limited



Chemical Laboratory - Kao.,SGS Taiwan Ltd.

## TEST REPORT

REPORT NO.KE/2006/10283

DATE: 2006/1/11

PAGE: 2 OF 2

TEST ITEM(S)	UNIT	METHOD	DET. LMT	RESULT
<b>PBBs (Polybrominated biphenyls)</b>	---	---	---	---
Monobromobiphenyl	%	With reference to USEPA3540C or USEPA3550C. Analysis was performed by HPLC/DAD, LC/MS or GC/MS. (prohibited by 2002/95/EC (RoHS), 83/264/EEC, and 76/769/EEC)	0.0005	n.d.
Dibromobiphenyl	%		0.0005	n.d.
Tribromobiphenyl	%		0.0005	n.d.
Tetrabromobiphenyl	%		0.0005	n.d.
Pentabromobiphenyl	%		0.0005	n.d.
Hexabromobiphenyl	%		0.0005	n.d.
Heptabromobiphenyl	%		0.0005	n.d.
Octabromobiphenyl	%		0.0005	n.d.
Nonabromobiphenyl	%		0.0005	n.d.
Decabromobiphenyl	%		0.0005	n.d.
<b>PBDEs (Polybrominated biphenyl ethers)</b>	---	---	---	---
Monobromobiphenyl ether	%	With reference to USEPA3540C or USEPA3550C. Analysis was performed by HPLC/DAD, LC/MS or GC/MS. (prohibited by 2002/95/EC (RoHS), 83/264/EEC, and 76/769/EEC)	0.0005	n.d.
Dibromobiphenyl ether	%		0.0005	n.d.
Tribromobiphenyl ether	%		0.0005	n.d.
Tetrabromobiphenyl ether	%		0.0005	n.d.
Pentabromobiphenyl ether	%		0.0005	n.d.
Hexabromobiphenyl ether	%		0.0005	n.d.
Heptabromobiphenyl ether	%		0.0005	n.d.
Octabromobiphenyl ether	%		0.0005	n.d.
Nonabromobiphenyl ether	%		0.0005	n.d.
Decabromobiphenyl ether	%		0.0005	n.d.

NOTE : n.d. = not detected.

<END>





## Test Report

元祥金屬工業股份有限公司  
1500彰化縣彰化市彰水路175號

報告號碼 : CE/2005/53261A  
日期 : 2005/05/24

以下測試樣品乃供應廠商所提供及確認：

樣品名稱 : 銅合金 C3604  
收件日期 : 2005/05/17  
測試日期 : 2005/05/17 TO 2005/05/24

### 測試結果

測試部位 NO.1 : 銅合金樣(請參照附件圖片)

測試項目:	單位	測試方法	偵測極限值	結果
				NO.1
六價鉻	ppm	依照US EPA 3060A方法,用UV-VIS做分析	2	N.D.
錳	ppm	依照 EN1122 方法B: 2001或其他酸消化方法,用感應耦合電漿原子發射光譜儀(ICP-AES)做分析	2	20.2
汞	ppm	依照 US EPA 3052 方法或其他酸消化方法,用感應耦合電漿原子發射光譜儀(ICP-AES)做分析	2	N.D.
鉛	ppm	依照 US EPA 3050B 方法或其他酸消化方法,用感應耦合電漿原子發射光譜儀(ICP-AES)做分析	2	35039.0

備註: (1) N.D. = Not detected (<MDL) / 未檢出(低於偵測極限值)  
(2) ppm = mg/kg / 百萬分之一  
(3) MDL = Method Detection Limit(偵測極限值)

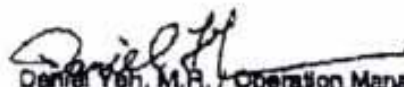
  
 Daniel Yen, M.R., Operation Manager  
 Signed for and on behalf of  
 SGS TAIWAN LTD.

The content of this PDF file is in accordance with the original issued reports for reference only. This Test Report cannot be reproduced, except in full, without prior written permission of the Company.



## Test Report

TAI MAO TECHNOLOGY CO., LTD.  
NO. 12, ALLEY 30, LANE 371, HUACHENG ROAD,  
SHINJUANG CITY, TAIPEI HSIEN, TAIWAN

Report No. : CE/2005/84740  
Date : 2005/08/26  
Page : 1 of 2

**The following merchandise was (were) submitted and identified by the client as :**

Type of Product : BERYLLIOM COPPER  
Style/Item No : C17300 M25  
Sample Received : 2005/8/19  
Testing Date : 2005/8/19 TO 2005/08/26

### Test Result

PART NAME NO.1 : COPPER COLORED METAL WIRE (PLEASE REFER TO THE PHOTO ATTACHED)

Test Item (s):	Unit	Method	MDL	Result
				No.1
Chromium VI (Cr+6)	ppm	UV-VIS after reference to US EPA 3060A.	2	N.D.
Cadmium (Cd)	ppm	ICP-AES after reference to EN 1122, method B:2001 or other acid digestion.	2	N.D.
Mercury (Hg)	ppm	ICP-AES after reference to US EPA 3052 or other acid digestion.	2	N.D.
Lead (Pb)	ppm	ICP-AES after reference to US EPA 3050B or other acid digestion.	2	3351.6

NOTE: (1) N.D. = Not detected (<MDL)  
(2) ppm = mg/kg  
(3) MDL = Method Detection Limit

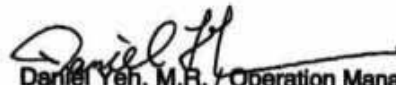
  
Daniel Yeh, M.R. / Operation Manager  
Signed for and on behalf of  
SGS TAIWAN LTD.

The content of this PDF file is in accordance with the original issued reports for reference only. This Test Report cannot be reproduced, except in full, without prior written permission of the Company



## Test Report

TAI MAO TECHNOLOGY CO., LTD.  
NO. 12, ALLEY 30, LANE 371, HUACHENG ROAD,  
SHINJUANG CITY, TAIPEI HSIEN, TAIWAN

Report No. : CE/2005/84740  
Date : 2005/08/26  
Page : 2 of 2



The content of this PDF file is in accordance with the original issued reports for reference only. This Test Report cannot be reproduced, except in full, without prior written permission of the Company





財團 台灣電子檢驗中心  
法人 ELECTRONICS TESTING CENTER, TAIWAN

地址：333 桃園縣蘆山鄉新善村文明路 29 巷 8 號  
電話：(03) 328-0026 轉 291、298  
傳真：(03) 327-6147

## 測 試 報 告

委託機構：宏庫貿易有限公司  
地址：台北市大安區青田街 8-1 號 1 樓

承辦日：94 年 09 月 16 日  
報告日：94 年 09 月 27 日

※注意事項：

1. 本報告僅對該樣品負責。
2. 非經本中心同意，本報告內容不得以任何方式復錄後印使用。(全部複印除外)

工服編號：ET940-09-035

審核：

全3頁 / 第1頁



財團法人台灣電子檢驗中心  
環境保護與工業安全衛生部



經 理



實驗室主管

### 備註：

1. N.D. 意即為偵測不到
2. 測試儀器中英文對照：
  - (1) ICP-OES 感應耦合電漿原子發射光譜儀
  - (2) UV-VIS 分光光度計
  - (3) GC-MS 氣相層析質譜儀

測試結果：-請見下頁-

財團 台灣電子檢驗中心  
法人 ELECTRONICS TESTING CENTER, TAIWAN地址：333 桃園縣龜山鄉熊蕃村文明路 29 巷 8 號  
電話：(03) 328-0026 轉 291、298  
傳真：(03) 327-6147

## 測 試 報 告

委託機構：宏庫貿易有限公司  
地址：台北市大安區青田街 8-1 號 1 樓承辦日：94 年 09 月 16 日  
報告日：94 年 09 月 27 日

※注意事項：

1. 本報告僅對該樣品負責。
2. 非經本中心同意，本報告內容不得以任何方式複錄後印使用。(全部複印除外)

工服編號：ET940-09-035

審核：

全3頁/第2頁

## NO.1

樣品編號 ET940-09-035

樣品名稱 PTFE

樣品型號 ----

測試項目	儀器設備	參考測試方法	測試結果 (單位:mg /kg; ppm)	
			NO.1	方法偵測極限
鉛	ICP-OES	US EPA 3051A & 6010B	N.D.	0.6
鎘	ICP-OES	US EPA 3051A & 6010B	N.D.	0.6
汞	ICP-OES	US EPA 3051A & 6010B	N.D.	1.0
六價鉻	UV-VIS	US EPA 3060A & 7196A	N.D.	0.5
多溴聯苯	GC-MS	US EPA 3540C/3550B & 8082A/8081A/8270C	N.D.	1.0
多溴二聯苯	GC-MS	US EPA 3540C/3550B & 8082A/8081A/8270C	N.D.	1.0





財團 台灣電子檢驗中心  
法人 ELECTRONICS TESTING CENTER, TAIWAN

地址：333 桃園縣蘆山鄉熊蕃村文明路 29 巷 8 號  
電話：(03) 328-0026 轉 291、298  
傳真：(03) 327-6147

## 測 試 報 告

委託機構：宏庫貿易有限公司  
地址：台北市大安區青田街 8-1 號 1 樓

承辦日：94 年 09 月 16 日  
報告日：94 年 09 月 27 日

※注意事項：

1. 本報告僅對送樣品負責。
2. 非經本中心同意，本報告內容不得以任何方式復錄複印使用。(全部複印除外)

工服編號：ET940-09-035

審核：

全3頁 / 第3頁





## 測試報告

祐電精密有限公司  
\*242 台北縣新莊市新樹路268巷74號

報告號碼 : CE/2006/80517  
日期 : 2006/08/04  
頁數 : 1 of 3



以下測試樣品係由客戶送樣，且由客戶聲稱並經客戶確認如下：

樣品名稱 : 硫酸鎳<1>  
收件日期 : 2006/08/02.  
測試期間 : 2006/08/02 TO 2006/08/04

=====  
測試結果 : - 請見下一頁 -

  
Daniel Yeh, M.R., Operation Manager  
Signed for and on behalf of  
SGS TAIWAN LTD.



## 測試報告

祐電精密有限公司  
\*242 台北縣新莊市新樹路268巷74號

報告號碼 : CE/2006/80517  
日期 : 2006/08/04  
頁數 : 2 of 3



### 測試結果

測試部位 NO.1 : 綠色液體

測試項目	單位	測試方法	方法偵測 極限值	結果
				NO.1
六價鉻	mg/Kg	參考US EPA 3060A方法, 用UV-VIS (US EPA 7196A)分析	2	N.D.
鎘	mg/Kg	參考 EN1122 方法B:2001, 用感應耦合電漿原子發射光譜儀(ICP-AES)分析	2	N.D.
汞	mg/Kg	參考 US EPA 3052 方法, 用感應耦合電漿原子發射光譜儀(ICP-AES)分析	2	N.D.
鉛	mg/Kg	參考 US EPA 3050B 方法, 用感應耦合電漿原子發射光譜儀(ICP-AES)分析	2	N.D.

- 備註：(1) N.D. = Not Detected.( $<MDL$ ) / 未檢出(低於方法偵測極限值)  
 (2) mg/Kg = ppm, 0.1% = 1000 ppm(mg/Kg), 0.0005% = 5 ppm(mg/Kg)  
 (3) 對於鉛鎘汞測項，樣品是完全消化，對於六價鉻，樣品是完全被萃取

## 測試報告

祐電精密有限公司  
\*242 台北縣新莊市新樹路268巷74號

報告號碼 : CE/2006/80517

日期 : 2006/08/04

頁數 : 3 of 3



\*\* 報告結尾 \*\*

## Test Report

WONDERFUL HI-TECH CO., LTD.  
NO. 17, PEI-YUAN ROAD, CHUNG-LI IND., PARK,  
TAOYUAN, TAIWAN, R. O. C.

Report No. : CE/2006/10628  
Date : 2006/01/10  
Page : 1 of 5

**The following merchandise was (were) submitted and identified by the client as :**

Type of Product : RF COAXIAL CABLE  
Style/Item No : RG-316/U, RG-179/U, RG-178B/U, RF-405A  
Sample Received : 2006/01/03  
Testing Date : 2006/01/03 TO 2006/01/10

=====

**Test Result** : - Please see the next page -

  
Daniel Yeh, M.R. / Operation Manager  
Signed for and on behalf of  
SGS TAIWAN LTD.

# Test Report

WONDERFUL HI-TECH CO., LTD.  
NO. 17, PEI-YUAN ROAD, CHUNG-LI IND., PARK,  
TAOYUAN, TAIWAN, R. O. C.

Report No. : CE/2006/10628  
Date : 2006/01/10  
Page : 2 of 5

## Test Result

PART NAME NO.1 : SILVER COLORED METAL WIRE  
PART NAME NO.2 : TRANSPARENT PLASTIC INSULATION  
PART NAME NO.3 : SILVER COLORED METAL WIRE (WEAVED)  
PART NAME NO.4 : BROWN PLASTIC JACKET

Test Item (s):	Unit	Method	MDL	Result			
				No.1	No.2	No.3	No.4
Monobromobiphenyl	%	With reference to USEPA3540C or USEPA3550C. Analysis was performed by HPLC/DAD, LC/MS or GC/MS. (prohibited by 2002/95/EC (RoHS), 83/264/EEC, and 76/769/EEC)	0.0005	---	N.D.	---	N.D.
Dibromobiphenyl	%		0.0005	---	N.D.	---	N.D.
Tribromobiphenyl	%		0.0005	---	N.D.	---	N.D.
Tetrabromobiphenyl	%		0.0005	---	N.D.	---	N.D.
Pentabromobiphenyl	%		0.0005	---	N.D.	---	N.D.
Hexabromobiphenyl	%		0.0005	---	N.D.	---	N.D.
Heptabromobiphenyl	%		0.0005	---	N.D.	---	N.D.
Octabromobiphenyl	%		0.0005	---	N.D.	---	N.D.
Nonabromobiphenyl	%		0.0005	---	N.D.	---	N.D.
Decabromobiphenyl	%		0.0005	---	N.D.	---	N.D.
<b>Total PBBs (Polybrominated biphenyls)/ Sum of above</b>	%		-	---	N.D.	---	N.D.
Monobromobiphenyl ether	%		With reference to USEPA3540C or USEPA3550C. Analysis was performed by HPLC/DAD, LC/MS or GC/MS. (prohibited by 2002/95/EC (RoHS), 83/264/EEC, and 76/769/EEC)	0.0005	---	N.D.	---
Dibromobiphenyl ether	%	0.0005		---	N.D.	---	N.D.
Tribromobiphenyl ether	%	0.0005		---	N.D.	---	N.D.
Tetrabromobiphenyl ether	%	0.0005		---	N.D.	---	N.D.
Pentabromobiphenyl ether	%	0.0005		---	N.D.	---	N.D.
Hexabromobiphenyl ether	%	0.0005		---	N.D.	---	N.D.
Heptabromobiphenyl ether	%	0.0005		---	N.D.	---	N.D.
Octabromobiphenyl ether	%	0.0005		---	N.D.	---	N.D.
Nonabromobiphenyl ether	%	0.0005		---	N.D.	---	N.D.
Decabromobiphenyl ether	%	0.0005		---	N.D.	---	N.D.
<b>Total PBBEs(PBDEs) (Polybrominated biphenyl ethers)/ Sum of above</b>	%	-		---	N.D.	---	N.D.
<b>Total of Mono to Nona-brominated biphenyl ether. (Note 4)</b>	%	-		---	N.D.	---	N.D.

# Test Report

WONDERFUL HI-TECH CO., LTD.  
NO. 17, PEI-YUAN ROAD, CHUNG-LI IND., PARK,  
TAOYUAN, TAIWAN, R. O. C.

Report No. : CE/2006/10628  
Date : 2006/01/10  
Page : 3 of 5

Test Item (s):	Unit	Method	MDL	Result			
				No.1	No.2	No.3	No.4
Chromium VI (Cr+6)	ppm	UV-VIS after reference to US EPA 3060A.	2	N.D.	N.D.	N.D.	N.D.
Cadmium (Cd)	ppm	ICP-AES after reference to EN 1122, method B:2001 or other acid digestion.	2	N.D.	N.D.	N.D.	N.D.
Mercury (Hg)	ppm	ICP-AES after reference to US EPA 3052 or other acid digestion.	2	N.D.	N.D.	N.D.	N.D.
Lead (Pb)	ppm	ICP-AES after reference to US EPA 3050B or other acid digestion.	2	N.D.	N.D.	N.D.	N.D.

- NOTE: (1) N.D. = Not detected (<MDL)  
 (2) ppm = mg/kg  
 (3) MDL = Method Detection Limit  
 (4) Decabromodiphenyl ether (DecaBDE) in polymeric applications is exempted by Commission Decision of 13 Oct 2005 amending Directive 2002/95/EC notified under document 2005/717/EC.  
 (5) PBBEs=PBDEs=Polybrominated Diphenyl Ethers=PBDOs=PBBOs.  
 (6) " - " = Not Regulation  
 (7) " --- " = Not Applicable



## Test Report

WONDERFUL HI-TECH CO., LTD.  
NO. 17, PEI-YUAN ROAD, CHUNG-LI IND., PARK,  
TAOYUAN, TAIWAN, R. O. C.

Report No. : CE/2006/10628  
Date : 2006/01/10  
Page : 4 of 5





## Test Report

WONDERFUL HI-TECH CO., LTD.  
NO. 17, PEI-YUAN ROAD, CHUNG-LI IND., PARK,  
TAOYUAN, TAIWAN, R. O. C.

Report No. : CE/2006/10628  
Date : 2006/01/10  
Page : 5 of 5

