

WT30

FA Wireless SS Terminal

OPERATION MANUAL

OMRON

Notice

- (1) This manual may not be copied, reproduced, or reprinted, in whole or in part, without permission from OMRON.
- (2) The specifications listed within this manual may be revised without prior notice.
- (3) The information in this manual was compiled with the utmost care. However, if you should find any errors or inconsistencies, please contact the OMRON business office. Be sure to tell us the revision number of the manual in which you found the error.

Introduction

OMRON products are manufactured for use according to proper procedures by a qualified operator and only for the purposes described in this manual.

Thank you for purchasing this WT30 FA Wireless SS Terminal (also referred to as WT30 or WT30 Terminal in this manual).

The WT30 System consists of a Serial Master Station and I/O Slave Stations. The Serial Master Station is a wireless terminal that collects ON/OFF data using wireless communications and is connected to a device with an RS-232C interface (e.g., a personal computer or PLC). I/O Slave Stations with I/O terminals can also be connected to a DeviceNet-compatible WD30 Master.

Intended Audience

This manual is intended for the following readers.

- Persons in charge of introducing FA devices
- Persons who design FA systems
- Persons who install or connect FA devices
- Persons who manage working FA installations

Persons who use this product must have sufficient knowledge of electrical systems (i.e., an electrical engineer or the equivalent).

READ AND UNDERSTAND THIS DOCUMENT

Please read and understand this document before using the product. Please consult your OMRON representative if you have any questions or comments.

WARRANTY

OMRON's exclusive warranty is that the products are free from defects in materials and workmanship for a period of one year (or other period if specified) from date of sale by OMRON.

OMRON MAKES NO WARRANTY OR REPRESENTATION, EXPRESS OR IMPLIED, REGARDING NON-INFRINGEMENT, MERCHANTABILITY, OR FITNESS FOR PARTICULAR PURPOSE OF THE PRODUCTS. ANY BUYER OR USER ACKNOWLEDGES THAT THE BUYER OR USER ALONE HAS DETERMINED THAT THE PRODUCTS WILL SUITABLY MEET THE REQUIREMENTS OF THEIR INTENDED USE. OMRON DISCLAIMS ALL OTHER WARRANTIES, EXPRESS OR IMPLIED.

LIMITATIONS OF LIABILITY

OMRON SHALL NOT BE RESPONSIBLE FOR SPECIAL, INDIRECT, OR CONSEQUENTIAL DAMAGES, LOSS OF PROFITS OR COMMERCIAL LOSS IN ANY WAY CONNECTED WITH THE PRODUCTS, WHETHER SUCH CLAIM IS BASED ON CONTRACT, WARRANTY, NEGLIGENCE, OR STRICT LIABILITY.

In no event shall responsibility of OMRON for any act exceed the individual price of the product on which liability is asserted.

IN NO EVENT SHALL OMRON BE RESPONSIBLE FOR WARRANTY, REPAIR, OR OTHER CLAIMS REGARDING THE PRODUCTS UNLESS OMRON'S ANALYSIS CONFIRMS THAT THE PRODUCTS WERE PROPERLY HANDLED, STORED, INSTALLED, AND MAINTAINED AND NOT SUBJECT TO CONTAMINATION, ABUSE, MISUSE, OR INAPPROPRIATE MODIFICATION OR REPAIR.

SUITABILITY FOR USE

THE PRODUCTS CONTAINED IN THIS DOCUMENT ARE NOT SAFETY RATED. THEY ARE NOT DESIGNED OR RATED FOR ENSURING SAFETY OF PERSONS, AND SHOULD NOT BE RELIED UPON AS A SAFETY COMPONENT OR PROTECTIVE DEVICE FOR SUCH PURPOSES. Please refer to separate catalogs for OMRON's safety rated products.

OMRON shall not be responsible for conformity with any standards, codes, or regulations that apply to the combination of products in the customer's application or use of the product.

At the customer's request, OMRON will provide applicable third party certification documents identifying ratings and limitations of use that apply to the products. This information by itself is not sufficient for a complete determination of the suitability of the products in combination with the end product, machine, system, or other application or use.

The following are some examples of applications for which particular attention must be given. This is not intended to be an exhaustive list of all possible uses of the products, nor is it intended to imply that the uses listed may be suitable for the products:

- Outdoor use, uses involving potential chemical contamination or electrical interference, or conditions or uses not described in this document.
- Nuclear energy control systems, combustion systems, railroad systems, aviation systems, medical equipment, amusement machines, vehicles, safety equipment, and installations subject to separate industry or government regulations.
- Systems, machines, and equipment that could present a risk to life or property.

Please know and observe all prohibitions of use applicable to the products.

NEVER USE THE PRODUCTS FOR AN APPLICATION INVOLVING SERIOUS RISK TO LIFE OR PROPERTY WITHOUT ENSURING THAT THE SYSTEM AS A WHOLE HAS BEEN DESIGNED TO ADDRESS THE RISKS, AND THAT THE OMRON PRODUCT IS PROPERLY RATED AND INSTALLED FOR THE INTENDED USE WITHIN THE OVERALL EQUIPMENT OR SYSTEM.

PERFORMANCE DATA

Performance data given in this document is provided as a guide for the user in determining suitability and does not constitute a warranty. It may represent the result of OMRON's test conditions, and the users must correlate it to actual application requirements. Actual performance is subject to the OMRON Warranty and Limitations of Liability.

CHANGE IN SPECIFICATIONS

Product specifications and accessories may be changed at any time based on improvements and other reasons.

It is our practice to change model numbers when published ratings or features are changed, or when significant construction changes are made. However, some specifications of the product may be changed without any notice. When in doubt, special model numbers may be assigned to fix or establish key specifications for your application on your request. Please consult with your OMRON representative at any time to confirm actual specifications of purchased products.

DIMENSIONS AND WEIGHTS

Dimensions and weights are nominal and are not to be used for manufacturing purposes, even when tolerances are shown.

ERRORS AND OMISSIONS

The information in this document has been carefully checked and is believed to be accurate; however, no responsibility is assumed for clerical, typographical, or proofreading errors, or omissions.

PROGRAMMABLE PRODUCTS

OMRON shall not be responsible for the user's programming of a programmable product, or any consequence thereof.

COPYRIGHT AND COPY PERMISSION

This document shall not be copied for sales or promotions without permission.

This document is protected by copyright and is intended solely for use in conjunction with the product. Please notify us before copying or reproducing this document in any manner, for any other purpose. If copying or transmitting this document to another, please copy or transmit it in its entirety.

Approved Standards

Conforming Wireless Standards:

Japan: ARIB STD-T66

USA: FCC part 15.247

Europe: EN 300 440-2

Conforming Safety Standards: UL508 (Listing)
EN 60950-1

Conforming EMC Standards: EN 301 489-3
EN 301 489-17

Conforming EMF Standards: EN 50371

Applicable Countries

This product has been approved for wireless standards in the countries listed below. This product cannot be used in any other countries.

Austria, Belgium, Cyprus, Czech Republic, Denmark, Estonia, Finland, France, Germany, Greece, Hungary, Iceland, Ireland, Italy, Japan, Latvia, Lithuania, Luxembourg, Malta, Netherlands, Norway, Poland, Portugal, Slovakia, Slovenia, Spain, Sweden, Switzerland, UK, USA

Conformance to EN Standards

Use a DC power line less than 3 m to conform to EN standards. If a power line of 3 m or longer is required, extend the length at the Switching Power Supply's primary side (i.e., the AC power line).

Conformance to UL Standards

Always use a Class 2 power supply to conform to UL standards.

FCC Notice

This device complies with part 15 of the FCC Rules. Operation is subject to the following two conditions: (1) This device may not cause harmful interference, and (2) this device must accept any interference received, including interference that may cause undesired operation.

Caution

To ensure that the WLAN transmitter complies with current FCC regulations limiting both maximum RF output power and human exposure to radio frequency radiation, a separation distance of at least 20 cm must be maintained between the Unit's antenna and the body of the user and any nearby persons at all times and in all applications and uses.

FCC WARNING

Changes or modifications not expressly approved by the party responsible for compliance could void the user's authority to operate the equipment.

FCC RF Radiation Exposure Statement

This transmitter must not be co-located or operating in conjunction with any other antenna or transmitter.

CE NOTICE

	
Česky [Czech]	Omron Corporation tímto prohlašuje, že tento WT30 je ve shodě se základními požadavky a dalšími příslušnými ustanoveními směrnice 1999/5/ES.
Dansk [Danish]	Undertegnede Omron Corporation erklærer herved, at følgende udstyr WT30 overholder de væsentlige krav og øvrige relevante krav i direktiv 1999/5/EF.
Deutsch [German]	Hiermit erkläre Omron Corporation, dass sich das Gerät WT30 in Übereinstimmung mit den grundlegenden Anforderungen und den übrigen einschlägigen Bestimmungen der Richtlinie 1999/5/EG befindet.
Eesti [Estonian]	Käesolevaga kinnitab Omron Corporation seadme WT30 vastavust direktiivi 1999/5/EÜ põhinõuetele ja nimetatud direktiivist tulenevatele teistele asjakohastele sätetele.
English	Hereby, Omron Corporation, declares that this WT30 is in compliance with the essential requirements and other relevant provisions of Directive 1999/5/EC.
Español [Spanish]	Por medio de la presente Omron Corporation declara que el WT30 cumple con los requisitos esenciales y cualesquiera otras disposiciones aplicables o exigibles de la Directiva 1999/5/CE.
Ελληνική [Greek]	ΜΕ ΤΗΝ ΠΑΡΟΥΣΑ Omron Corporation ΔΗΛΩΝΕΙ ΟΤΙ WT30 ΣΥΜΜΟΡΦΩΝΕΤΑΙ ΠΡΟΣ ΤΙΣ ΟΥΣΙΩΔΕΙΣ ΑΠΑΙΤΗΣΕΙΣ ΚΑΙ ΤΙΣ ΛΟΙΠΕΣ ΣΧΕΤΙΚΕΣ ΔΙΑΤΑΞΕΙΣ ΤΗΣ ΟΔΗΓΙΑΣ 1999/5/EK.
Français [French]	Par la présente Omron Corporation déclare que l'appareil WT30 est conforme aux exigences essentielles et aux autres dispositions pertinentes de la directive 1999/5/CE.
Italiano [Italian]	Con la presente Omron Corporation dichiara che questo WT30 è conforme ai requisiti essenziali ed alle altre disposizioni pertinenti stabilite dalla direttiva 1999/5/CE.
Latviski [Latvian]	Ar šo Omron Corporation deklarē, ka WT30 atbilst Direktīvas 1999/5/EK būtiskajām prasībām un citiem ar to saistītajiem noteikumiem.
Lietuvių [Lithuanian]	Šiuo Omron Corporation deklaruoja, kad šis WT30 atitinka esminius reikalavimus ir kitas 1999/5/EB Direktyvos nuostatas.
Nederlands [Dutch]	Hierbij verklaart Omron Corporation dat het toestel WT30 in overeenstemming is met de essentiële eisen en de andere relevante bepalingen van richtlijn 1999/5/EG.
Malti [Maltese]	Hawnhekk, Omron Corporation, jiddikjara li dan WT30 jikkonforma mal-htigijiet essenzjali u ma provvedimenti oħrajn rilevanti li hemm fid-Dirrettiva 1999/5/EC.
Magyar [Hungarian]	Alulírott, Omron Corporation nyilatkozom, hogy a WT30 megfelel a vonatkozó alapvető követelményeknek és az 1999/5/EC irányelv egyéb előírásainak.
Polski [Polish]	Niniejszym Omron Corporation oświadcza, że WT30 jest zgodny z zasadniczymi wymogami oraz pozostałymi stosownymi postanowieniami Dyrektywy 1999/5/EC.
Português [Portuguese]	Omron Corporation declara que este WT30 está conforme com os requisitos essenciais e outras disposições da Directiva 1999/5/CE.
Slovensko [Slovenian]	Omron Corporation izjavlja, da je ta WT30 v skladu z bistvenimi zahtevami in ostalimi relevantnimi določili direktive 1999/5/ES.
Slovensky [Slovak]	Omron Corporation týmto vyhlasuje, že WT30 spĺňa základné požiadavky a všetky príslušné ustanovenia Smernice 1999/5/ES.
Suomi [Finnish]	Omron Corporation vakuuttaa täten että WT30 tyyppinen laite on direktiivin 1999/5/EY oleellisten vaatimusten ja sitä koskevien direktiivin muiden ehtojen mukainen.
Svenska [Swedish]	Härmed intygar Omron Corporation att denna WT30 står i överensstämmelse med de väsentliga egenskapskrav och övriga relevanta bestämmelser som framgår av direktiv 1999/5/EG.
Íslenska [Icelandic]	Hér með lýsir Omron Corporation yfir því að WT30 er í samræmi við grunnkröfur og aðrar kröfur, sem gerðar eru í tilskipun 1999/5/EC.
Norsk [Norwegian]	Omron Corporation erklærer herved at utstyret WT30 er i samsvar med de grunnleggende krav og øvrige relevante krav i direktiv 1999/5/EF.

Overseas Use

Export permission must be obtained from the Japanese government before exporting (or providing to a non-resident) items or technology classified as export-restricted under the Japanese Foreign Exchange and Foreign Trade Control Law.

Safety Precautions

Definition of Precautionary Information

The following notation is used in this manual to provide precautions required to ensure safe usage of the product.





The safety precautions that are provided are extremely important to safety. Always read and heed the information provided in all safety precautions.

The following notation is used.





 WARNING	Indicates a potentially hazardous situation which, if not avoided, will result in minor or moderate injury, or may result in serious injury or death. Additionally there may be significant property damage.
--	--

 CAUTION	Indicates a potentially hazardous situation which, if not avoided, may result in minor or moderate injury or in property damage.
--	--

Symbols

Symbol		Meaning
Caution		General Caution Indicates non-specific general cautions, warnings, and dangers.
		Electrical Shock Caution Indicates possibility of electric shock under specific conditions.
Prohibition		General Prohibition Indicates non-specific, general prohibitions.
		Disassembly Prohibition Indicates prohibitions when there is a possibility of injury, such as from electric shock, as the result of disassembly.
Mandatory Caution		General Caution Indicates non-specific, general cautions, warnings, and dangers.

Precautions

 WARNING	
<p>Always provide protective circuits in the network. Without protective circuits, malfunctions may possibly result in accidents that cause serious injury or significant property damage. Provide double or triple safety measures in external control circuits, such as emergency stop circuits, interlock circuits, or limit circuits, to ensure safety in the system if an abnormality occurs due to malfunction of the product or another external factor affecting the product's operation.</p>	
<p>Design the system to ensure safety in the event of temporary interruptions in communications due to interference with the electromagnetic waves used for communications caused by the ambient environment and application methods.</p>	
<p>Do not use this product for real-time control.</p>	
<p>Using the FA Wireless SS Terminal near a pacemaker or other medical device may affect the operation of the medical device, possibly resulting in serious injury. Never use the FA Wireless SS Terminal near pacemakers or other medical devices.</p>	
 CAUTION	
<p>Make sure that the direction and polarity (+/-) are correct when connecting terminal blocks and connectors. Turning ON the power to I/O circuits with the I/O cables connected in reverse, may result in a blown output fuse.</p>	
<p>Do not apply a voltage or connect a load to the outputs that exceeds the maximum switching capacity.</p>	
<p>Leave the dustproof label attached to the Unit when wiring. Be sure to remove the label after the completion of wiring, however, to ensure proper heat dissipation. Removing the label during wiring or leaving the label attached after wiring may result in fire.</p>	
<p>Do not allow pieces of metal, wire clippings, or fine metallic shavings or filings from installation to enter the product. Doing so may occasionally result in minor electric shock, fire, or malfunctions.</p>	
<p>Do not attempt to disassemble, repair, or modify the product, or touch the internal parts of the product. Doing so may occasionally result in minor electric shock, fire, or malfunctions. In Japan, disassembly and modification is also prohibited under Japan's Radio Law and may be punishable by law.</p>	

Precautions for Safe Use

Be sure to observe the following precautions to ensure safe use of the product.

1. Transport the product in the box in which the product was packaged, making sure the product is not subjected to excessive vibrations or shock, or dropped.
2. Store the product within the specified environment. Allow the product to warm up to room temperature for at least 3 hours after it has been stored at -10°C or lower.
3. Use the product within the specified temperature and humidity ranges.
4. Do not use the product in the following locations.
 - Locations subject to extreme temperature changes resulting in condensation
 - Locations subject to static electricity, excessive noise, or electric fields
 - Locations where the product may come into contact with water, oil, or chemicals
 - Locations where corrosive gases or flammable gases are present
 - Locations where large amounts of dust or dirt are present
 - Locations subject to spatters, iron chips, or filings
5. Do not install the product outdoors (outside a control panel).
6. Use tape, cord, or other means to hold the product while adjusting the installation position to prevent the product from damage due to falling.
7. Do not install the product in areas where it will be subject to excessive external force, or in walkways.
8. Tighten the mounting screws to the specified torque of 0.5 to 0.6 N-m.
9. Provide sufficient space around the product for heat dissipation.
10. Do not install the product in walkways or locations subject to traffic when installing the product outside a control panel.
11. Do not reverse the power supply connection or connect the product to an AC power supply.
12. Use the correct power supply voltage.
13. Use AWG22 to AWG16 to connect wires for post terminals. For solid or stranded wires, however, use AWG20 to AWG16 (0.52 to 1.5 mm^2). The length of exposed wire is 10 mm.
14. Do not apply voltage to the inputs exceeding the rated voltage range.
15. Use communications cables (RS-232C cables) with a length of 15 m maximum and a load of 2,500 pF maximum.
16. Do not lay communications cables (RS-232C cables) and antenna cables near other high-voltage cables or power lines.
17. Use the specified cables for communications cables (RS-232C cables).
18. Be sure to perform communications tests to confirm operation after wiring before using the product.

19. Always set the product after it is installed or replaced. Set the product correctly according to the manual, and be sure to perform the tests provided with the product (e.g., communications tests) before operating it.
20. When operating the product without checking serial numbers, check whether an existing system is present, and design the system carefully to prevent radio interference.
21. Do not apply excess vibrations or shock to this product. Do not drop this product.
22. Make sure that wiring and switch settings are correct before starting operations.
23. Other wireless devices operating within the same frequency band may interfere with this product or be adversely affected by this product. Therefore, be sure to perform the tests provided with the product (e.g., installation tests) before operating it.
24. Make sure that the antenna is not disconnected during operation.
25. Do not use this product near other devices that may malfunction due to the electromagnetic waves emitted by this product.
26. Turn OFF the power supply before performing any wiring or replacing devices.
27. Do not touch the product with wet hands.
28. Dispose of the product as industrial waste.

Precautions for Correct Use

Always heed these precautions to prevent faulty operation, malfunction, or adverse affect on the product's performance and functionality.

1. Communications performance will vary according to the operating environment. Always check operations before using the product.
2. Do not install the antenna in a location surrounded by metal, such as in a control panel.
3. Install the antenna so that it is as far away as possible from and not parallel to electric wires or metal plates.
4. Do not use this product in areas exposed to extremely high humidity, near televisions or radios, near motors or drills that emit sparks, near strong magnets, or near fluorescent lights.
5. Make sure that the terminal blocks, communications cables (RS-232C cables), and other items with locking devices are properly locked into place.
6. Do not pull or bend cables with force.
7. Do not change the mode selection switch during operation.

Package Contents

- WT30 FA Wireless SS Terminal
- Instruction Sheet
- Terminal labels (I/O Slave Stations only)
- Non-slip feet (Serial Master Stations only)

Application Guide

Select the required communications configuration and refer to the relevant pages.

WT30 Basic Communications Configuration

The basic configuration uses 8 inputs and 8 outputs, or 16 inputs.

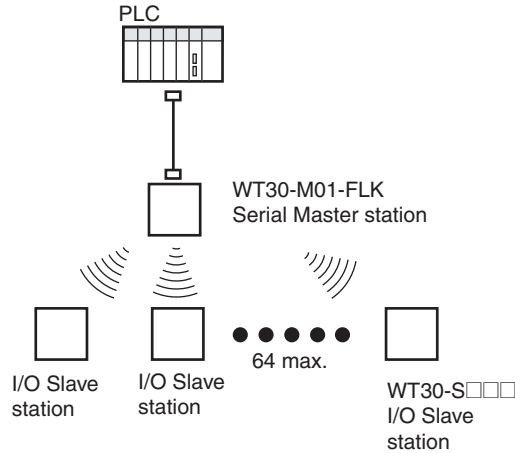

Note Refer to Features . Select from either of two patterns of points for the input/output terminals of the I/O Slave Station in a system configured using WT30. A maximum of 16 input terminals per station can be used.

Extending the Communications Distance Using Relay Function

Using Relay Stations

Extending Communications Distance

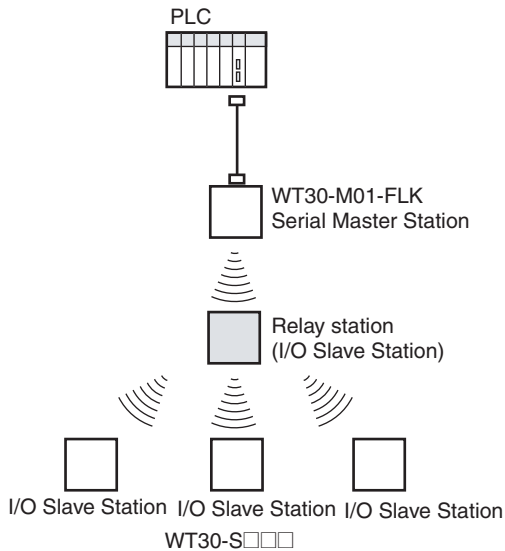

Switching Communications Path

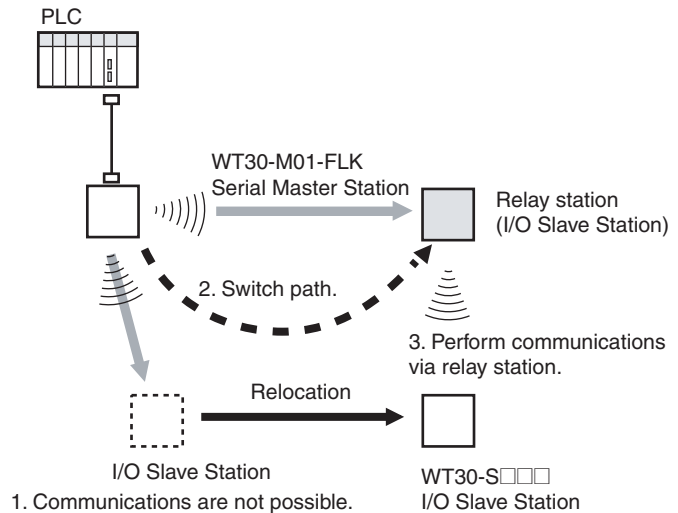

Note Refer to 4-1 Relay Function on page 60. The communications distance can be extended by using an I/O Slave Station as a Relay Station.

Communications between WT30 Terminals

Communications with Unregistered Slaves (No Scan List Registration)

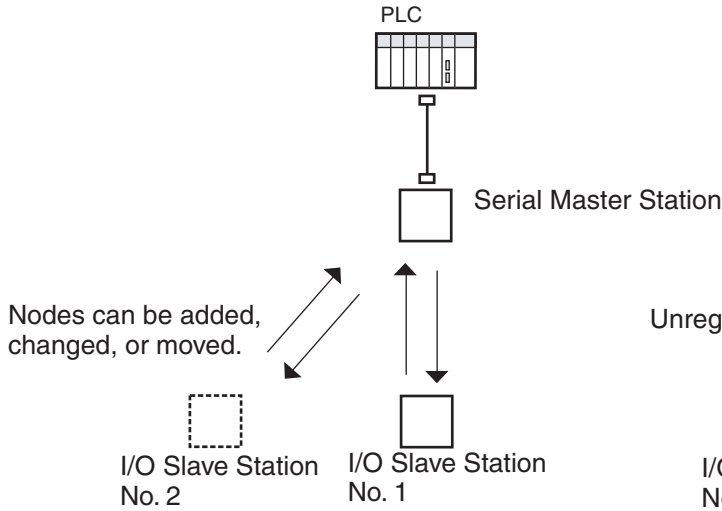

Communications are performed with specified I/O Slave Stations on the same frequency channel within the signal range. Scan list registration is not required, so I/O Slave Stations can be added and replaced using switch settings only. (See note 1.)

Communications with Registered Slaves (Scan List Registration)

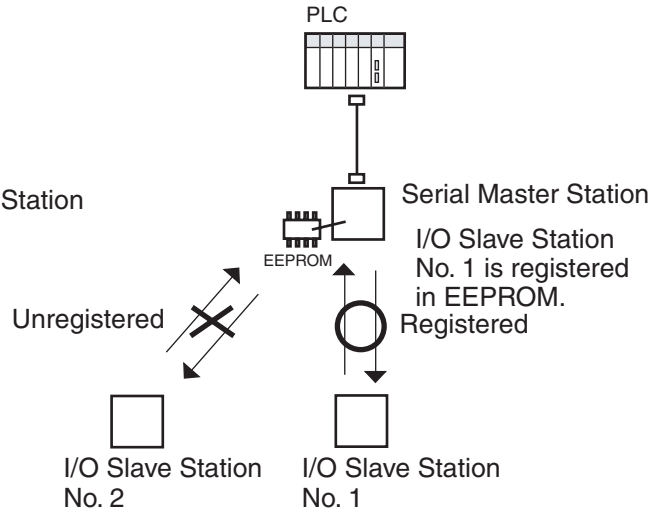

Communications are performed only with those I/O Slave Stations within the signal range with the same frequency channel and that are registered in the Serial Master Station. Select whether to register the serial number of the I/O Slave Station when registering it in the Serial Master Station. (See note 2.)

- Note**
1. Refer to *3-4 Using Unregistered Communications Partners* on page 42.
 2. Refer to *3-5 Registering the Communications Partner* on page 45.

Applied Functions

Communications Error Output Control

Select the status of output terminals if errors occur during wireless communications.

- Note** Refer to *3-6-6 Output Control for Communications Errors* on page 56 under *3-6 Function Setting Switch*.

Serial Number Check

Perform communications with a specific I/O Slave Station registered in the Serial Master Station including the serial number (the serial number is the product's unique number).

- Note** Refer to *3-6-1 Scan List Registration* on page 50 under *3-6 Function Setting Switch*.

Replacing WT30 Terminals

Refer to page 73.

Installation Methods

Refer to page 22.

Available Frequencies

Refer to page 105.

I/O Terminal Details

Refer to page 28.

Useful Functions

Monitoring All Wireless Channels Automatically

Refer to page 38.

Manual Outline

Outline of This Manual

Section 1 Introduction

This section explains the features of the WT30 Terminal, including the system configuration and the names and functions of parts.

Section 2 Hardware Installation and Connection

This section provides information on connection methods and precautions related to installation.

Section 3 Basic Settings

This section describes the procedures for making the WT30 settings and also provides information on the basic system configuration.

Section 4 Relay Function

This section provides information on the setting methods used to extend the communications distance.

Section 5 Troubleshooting and Maintenance

This section describes error processing, daily inspection, and troubleshooting and maintenance procedures needed to keep the wireless network operating properly. We recommend reading through the error processing procedures before operation so that operating errors can be identified and corrected more quickly.

Section 6 CompoWay/F

This section describes the CompoWay/F communications format and the variables that store the ON/OFF data and received signal strength readings.

Appendices

The appendices provide information on the WT30 specifications and optional accessories. .

TABLE OF CONTENTS

Introduction	i
Safety Precautions	vii
Precautions for Safe Use	ix
Precautions for Correct Use	x
Package Contents	xi
Application Guide	xii
Manual Outline	xiv
SECTION 1	
Introduction	1
1-1 Features	2
1-2 Nomenclature and Functions	6
SECTION 2	
Hardware Installation and Connection	13
2-1 Installation	14
2-2 Connections	24
2-3 Wireless System Design Considerations	32
SECTION 3	
Basic Settings	35
3-1 Scan List	36
3-2 Monitoring Unused Frequencies	37
3-3 Setting Flowchart	41
3-4 Using Unregistered Communications Partners	42
3-5 Registering the Communications Partner	45
3-6 Function Setting Switch	50
SECTION 4	
Relay Function	59
4-1 Relay Function	60
4-2 Setting Flowchart	62
4-3 Using Relays	63
SECTION 5	
Troubleshooting and Maintenance	67
5-1 Troubleshooting	68
5-2 Maintenance and Replacement	72
5-3 Replacing WT30 Terminals	73

TABLE OF CONTENTS

SECTION 6

CompoWay/F	75
6-1 Frame Structure	76
6-2 List of Response Codes	78
6-3 Detailed Description of the Services	78
6-4 Variable Area (Setting Range) List	86
6-5 Slave Station Entry Status	88
6-6 Slave Station Input Data	89
6-7 Slave Station Status	90
6-8 Number of Communications Errors	91
6-9 Slave Station Route Information	91
6-10 Slave Station Output Data	92
6-11 Slave Station I/O Size	92
6-12 Serial Number Registration Status	93
6-13 CompoWay/F Communications	93

Appendix

A Comparison between WT30 and WD30	96
B List of Supported Devices	97
C I/O Response Time	99
D Optional Accessories	101
E Specifications	103
F Frequency Table	105

Index..... 107

Revision History 111

SECTION 1

Introduction

This section describes the WT30 Terminal features, communications configuration, and part names and their functions.

- 1-1 Features 2
 - 1-1-1 Overview..... 2
 - 1-1-2 System Configuration..... 3
 - 1-1-3 Available Models 5
- 1-2 Nomenclature and Functions 6
 - 1-2-1 WT30 Terminals: Serial Master Stations 6
 - 1-2-2 WT30 Terminals: I/O Slave Stations 10

1-1 Features

Information on systems using WT30 FA Wireless SS Terminals (also referred to as WT30 or WT30 Terminals in this manual) is provided here.

1-1-1 Overview

The WT30 System consists of a Serial Master Station and I/O Slave Stations. The Serial Master Station is a wireless terminal that collects ON/OFF data using wireless communications and is connected to a device with an RS-232C interface (e.g., a personal computer or PLC). I/O Slave Stations with I/O terminals can also be connected to a DeviceNet-compatible WD30 Master.

Simple Relay Functions

The relay functions enable an increase in the communications area. The WT30 system supports a maximum of one relay stage using an I/O Slave Station as the Relay Station.

Install Multiple Sets in the Same Area

Changing frequencies removes interference between different sets installed in the same area. This enables you to construct a wireless system consisting of up to 10 sets (depending on the installation environment).

Advantage of Full Range of Channels

Supporting up to 67 channels, you can construct multiple systems without interference caused by intermodulation.

Easy Installation and Settings

DIN Rail mounting makes installation easy. The system can be registered simply by setting the switches on the WT30 Terminal, so Support Software is not required.

I/O Slave Stations with Built-in I/O

I/O Slave Stations are available in three types: With 16 inputs (DC inputs), 8 inputs/8 outputs (DC inputs/transistor outputs), or with different output terminal polarity.

High-level Security Wireless Communications

Registering the I/O Slave Station data (serial number and I/O size) in the Serial Master Station enables communications to be performed with specified I/O Slave Stations only.

Determine Operating Status from the LED Display

The LED display on the WT30 Terminal can be used to check the WT30's error status, whether wireless communications are normal, and the received signal strength.

Path Switching Function

Communications will continue via the Relay Station even if communications with the Serial Master Station and I/O Slave Station are unstable, or if the I/O Slave Station is removed.

Antennas (Optional)

Three antenna types are available: Magnet-base Antennas, Flat Antennas, and Pencil Antennas.

Compatible with General-purpose RS-232C Interface

A CompoWay/F command must be created to read (write) ON/OFF or other data. By using the OMRON Function Block Library, PLC users can reduce the amount of programming required.

Supported in OMRON Function Block Library for SYSMAC CS/CJ-series PLCs

The WT30 is supported the OMRON Function Block Library for SYSMAC CS/CJ-series Programmable Controllers. The I/O Slave Station's input conditions, output controls, and wireless communications status can be read simply via the WT30-M01-FLK Serial Master Station connected to the PLC. Using the OMRON Function Block Library eliminates the need to create communications programs for the WT30, reduces the load on system startup and maintenance, and improves software quality through programming standardization. For details on the OMRON Function Block Library, refer to the *OMRON FB Library Start-Up Guide* (Cat. No. R123).

1-1-2 System Configuration

The Serial Master Station is connected to the PLC (Programmable Controller) or personal computer to perform ON/OFF data communications with the I/O Slave Stations. The I/O Slave Station can also be used as a Relay Station to select the path and extend the communications area.

Basic Configuration

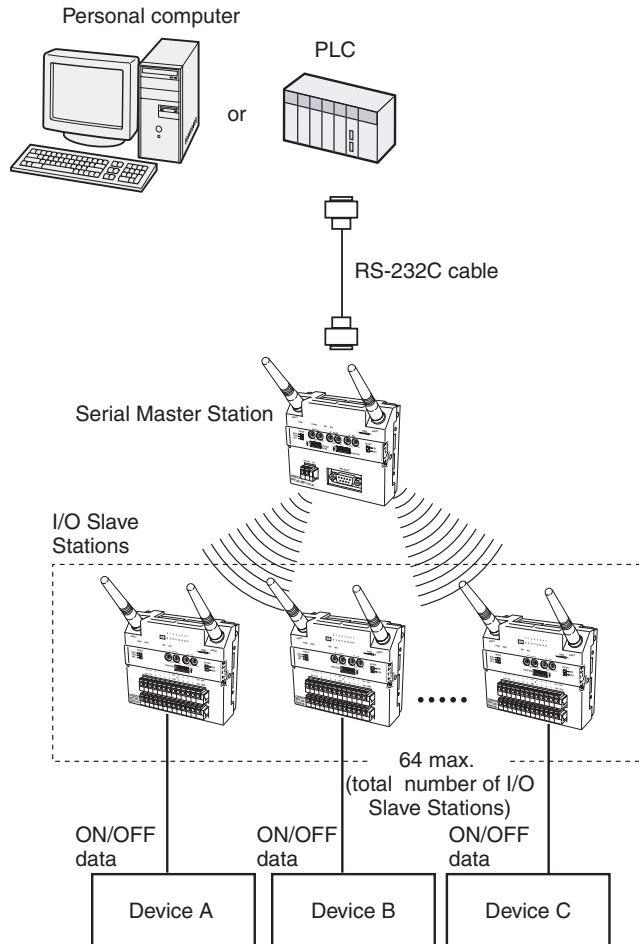

Relay Configuration

The communications area can be extended by using a Relay Station, and the communications path can also be switched when the WT30 Terminals are moved due to layout changes.

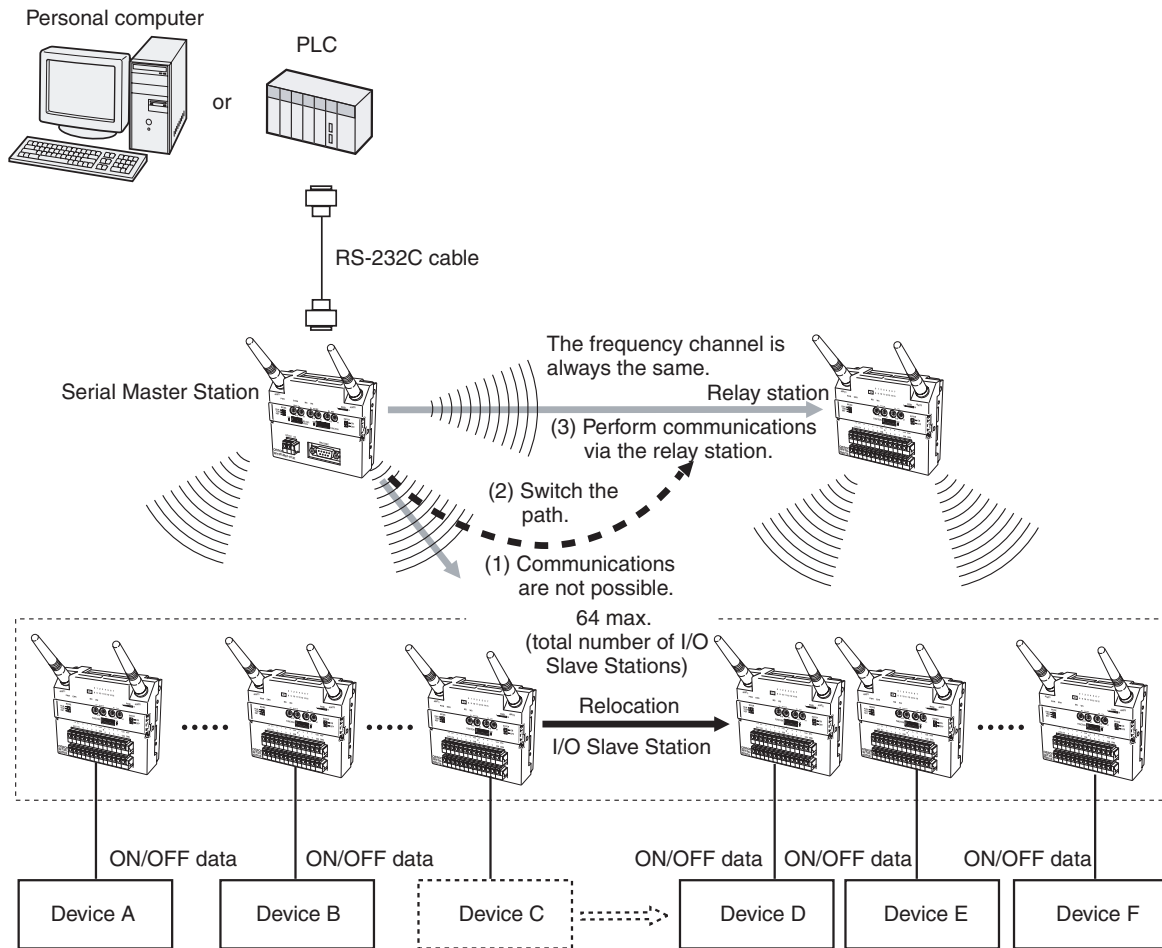

Connecting Multiple Serial Master Stations

The K3SC RS-232C/RS-485 Interface Converter can be used to configure a network requiring two or more Serial Master Stations (31 stations max.) or in environments in which communications are not possible even when Relay Stations are used in the system. Make sure that the Serial Master Stations are each allocated unique unit numbers and frequency channels. For details on wiring cables, refer to the operation manual provided with the K3SC Interface Converter.

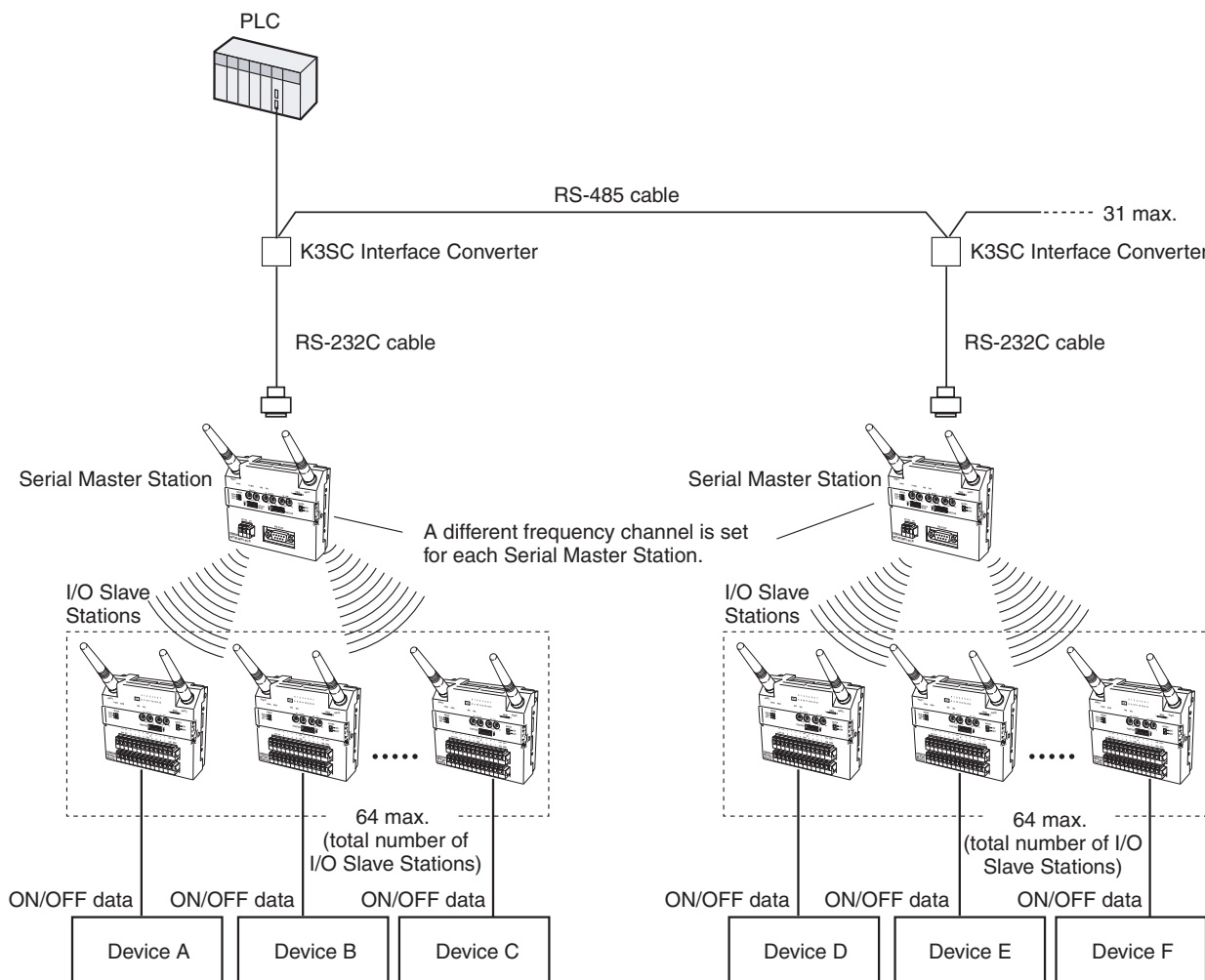

1-1-3 Available Models

The following models are available in the WT30 Series according to the polarity (NPN/PNP) of the terminals and number of I/O points.

WT30 Terminal model	Type	Specifications
WT30-M01-FLK	Serial Master Station	RS-232C
WT30-SID16	I/O Slave Stations	16 DC inputs (NPN/PNP)
WT30-SMD16		8 DC inputs (NPN/PNP) + 8 transistor outputs (NPN)
WT30-SMD16-1		8 DC inputs (NPN/PNP) + 8 transistor outputs (PNP)

Note The Antenna and Mounting Brackets are not included with the WT30 Terminals.

1-2 Nomenclature and Functions

1-2-1 WT30 Terminals: Serial Master Stations

Appearance

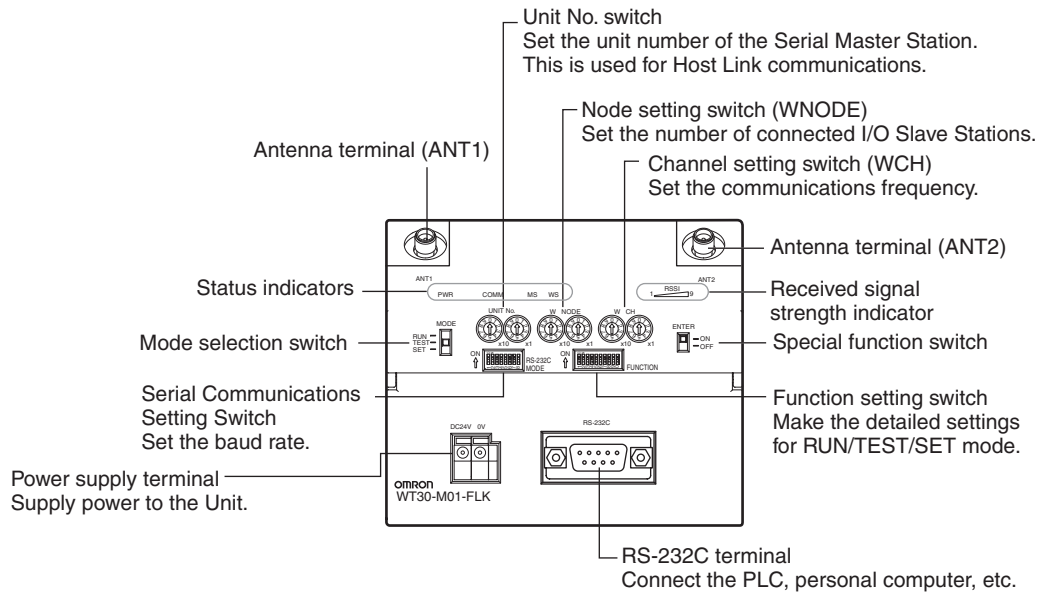
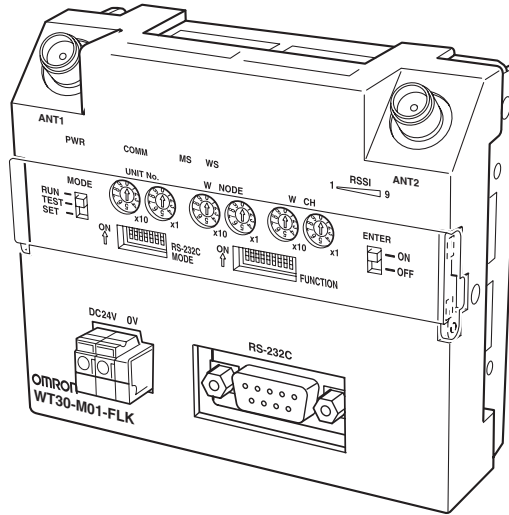

Settings

Unit No. Switch

Set the unit number for the Serial Master Station. The setting is read when the power is turned ON. The default is 00.

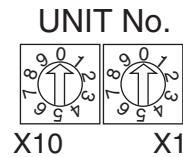

Node Setting Switch (WNODE)

Set the number of I/O Slave Stations connected to the Serial Master Station. The setting is read when the power is turned ON. The default is 01.

W NODE

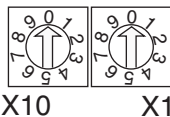

Channel Setting Switch (WCH)

Set the communications frequency. The setting is read when the power is turned ON. For details on frequencies, refer to *Appendix F Frequency Table* on page 105. The default is 02.

W CH

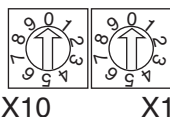

Setting range: 01 to 34, 51 to 83
(The channels 01/51 cannot be used for this product in China.)

Mode Selection Switch

Set the operation mode of the Serial Master Station (three positions).

RUN ●

TEST ●

SET ●

Switch setting	Operation mode
RUN	RUN mode
TEST	TEST mode
SET	SET mode

By switching the operating mode, a software reset is performed, and the set value (setting switch setting) is read.

Special Function Switch

Use this switch to end operation during scan list registration or as a trigger to return to the factory settings.

ENTER

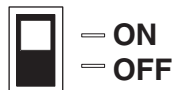

Function Setting Switch

Make the detailed settings for RUN/TEST/SET mode.

No.	Applicable mode	ON functions	OFF functions
1	RUN mode	Holds I/O status data when a communications error occurs.	Clears I/O status data when a communications error occurs.
2		Enable scan list	Disable scan list
3		Relays used	Relays not used
4	TEST mode	Signal strength monitor disabled	Signal strength monitor enabled
5		All channels automatically selected	Specified channel selected
6		---	---
7	SET mode	Scan list recognition	Nothing done
8		Registers specified I/O Slave	Registers all I/O Slaves automatically
9		Recognizes serial numbers (See note.)	Ignores serial numbers
10	Not used.	---	---

Note The serial number indicates the product's unique number.

Serial Communications Setting Switch

Set the baud rate and other settings.

No.	Function	ON operation	OFF operation
1	Communications setting selection	Detailed settings (settings for No. 2 to 8 used)	Default settings (baud rate: 9,600 bps; data length: 7 bits; parity: even; stop bits: 2) Settings for No. 2 to 8 are ignored.
2	Baud rate (bps) (See note.)	1	0
3		2	0
4		4	0
	Total value = 0: 1,200 = 1: 2,400 = 2: 4,800 = 3: 9,600 = 4: 19,200 = 5: 38,400 = 6: 57,600 = 7: 115,200		
5	Data length	8 bits	7 bits
6	Parity	None	Yes
7		Odd	Even
8	Stop bits	1 bit	2 bits

Note For example, if pin numbers 2, 3, and 4 are all ON, the total is 7, which corresponds to a baud rate of 115,200 bps.

Power Supply Terminal

Supplies 24-VDC (allowable voltage range: 20.4 or 26.4 VDC) power to the WT30 Terminal. The terminal construction uses a screwless terminal block (Phoenix Contact: FFKDS/V1-5.08 or equivalent).

RS-232C Terminal

The serial terminal construction uses D-sub, 9-pin (female) inch screws (OMRON XM2F-0910-132 or equivalent)

Antenna Terminal

Install an Antenna on both the right and left sides. Always use two Antennas.

Display

Status Indicators for Serial Master Station



Indicator	Color	Status	Meaning (primary error)
(1) PWR	Green	Lit	Power is being supplied.
		Not lit	Power is not being supplied.
(2) COMM	Yellow	Lit	Serial communications in progress.
		Not lit	No serial communications.
(3) MS (Module Status)	Red	Lit	A fatal error has occurred that cannot be recovered from, such as a watchdog timer error, EEPROM, or hardware error. Replace the WT30 Terminal.
		Flashing	A non-fatal error, illegal switch settings, or EEPROM checksum error has occurred that can be recovered from by resetting the system.
	Green	Lit	Communications are normal.
		Flashing	TEST mode or SET mode has been activated.
	---	Not lit	Power is not being supplied or the system is resetting.

Indicator	Color	Status	Meaning (primary error)
(4) WS (Wireless Status)	Red	Lit	A fatal wireless communications error or code sense error has occurred.
		Flashing	A non-fatal wireless communications error or verification error (slave station I/O size mismatch) has occurred, or the slave is not registered.
	Green	Lit	RUN mode: Connection to wireless communications is completed or remote I/O communications are in progress. SET mode: Scan list creation completed.
		Flashing	RUN mode: There is no wireless communications connection or there are no slaves participating in remote I/O communications. TEST mode: The received signal strength is being monitored. SET mode: Scan list is being created.
	---	Not lit	Wireless communications are not in progress.
(5) RSSI (See note 2.) (Received Signal Strength Indicator)	Red/yellow/green	0 to 9 lit	Displays the received signal strength in 10 levels. The field strength is determined by the number of indicators lit: weak for a small number and strong for a large number.
	Green	Flashing	Special function operation has completed.

- Note**
- (1) For details on troubleshooting, refer to *5-1 Troubleshooting* on page 68.
 - (2) The RSSI can be used to confirm the operation status.

Field strength	Red indicators			Yellow indicators			Green indicators			
	Weak			Medium			Strong			
Number of indicators lit	0	1	2	3	4	5	6	7	8	9
RUN mode	Unstable communications range					Stable communications range				
Test mode										
Field strength monitor test	Range in which specified channel can be used.			Range in which specified channel cannot be used.						
Installation/confirmation test	Unstable communications range					Stable communications range				

The received signal strength is indicated using 10 levels. Check the communications status, referring to the field strength level.

1-2-2 WT30 Terminals: I/O Slave Stations

Appearance

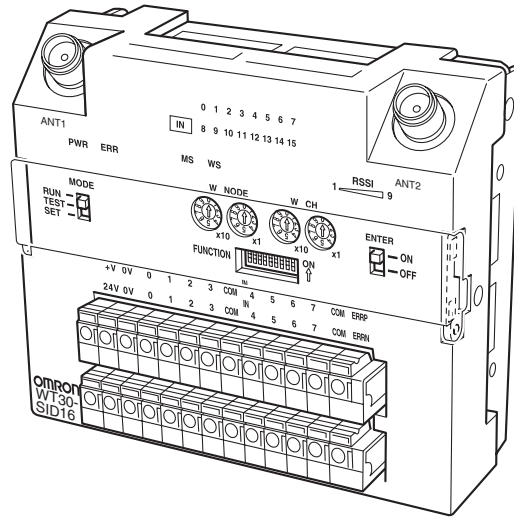

(WT30-SID16)

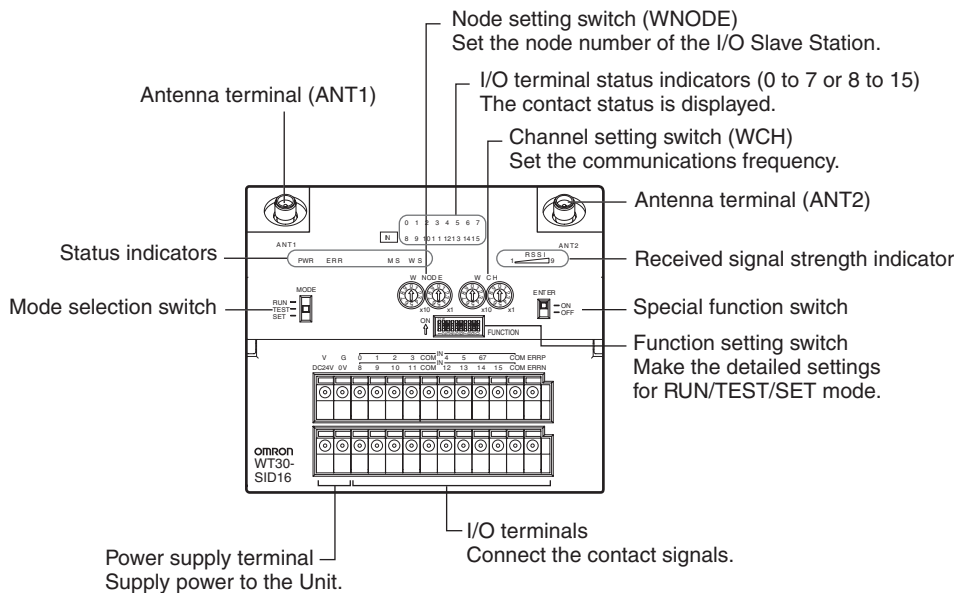

Settings

Node Setting Switch (W NODE)

Set the node number of the I/O Slave Station (64 max.). The setting is read when the power is turned ON. After the power is turned ON, any changes to the switch setting are ignored. The setting for WT30 Terminals used as Relay Stations is always 99. The default is 01.

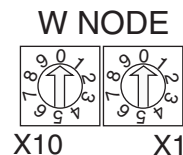

Channel Setting Switch (WCH)

Set the communications frequency. For details on frequencies, refer to *Appendix F Frequency Table* on page 105. The default is 02.

W CH



X10



X1

Setting range: 01 to 34, 51 to 83
(The channels 01/51 cannot be used for this product in China.)

Mode Selection Switch

Set the operation mode of the Serial Slave Station (three positions).

RUN ●

TEST ●

SET ●



Switch setting	Operation mode
RUN	RUN mode
TEST	TEST mode
SET	SET mode

By switching the operating mode, a software reset is performed, and the set value (setting switch setting) is read.

Special Function Switch

Use this switch to clear the recorded signal strength or to return to the factory settings.

ENTER



= ON

= OFF

Power Supply Terminals

Supplies 24-VDC (allowable voltage range: 20.4 or 26.4 VDC) power to the WT30 Terminal. The terminal construction uses a screwless terminal block (Phoenix Contact: FFKDS/V1-5.08 or equivalent).

I/O Terminals

Connect the I/O contact signals.

Antenna Terminal

Install an antenna on both the right and left sides. Always use two antennas.

Function Setting Switch

Make the detailed settings for I/O Slave Station operations in RUN mode, TEST mode, and SET mode.

No.	Mode	ON functions	OFF functions
1	RUN mode	Holds I/O status data when a communications error occurs.	Clears I/O status data when a communications error occurs.
2		Input hold	Normal mode
3		Input filter: 100 ms	Input filter: 10 ms
4	TEST mode	Signal strength monitor disabled	Signal strength monitor enabled
5		All channels automatically selected	Specified channel selected
6		Installation test function	Nothing done.
7 to 10	Not used.	---	---

Display

Status Indicators for I/O Slave Stations

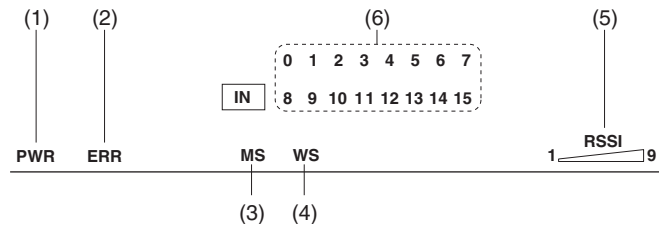

Indicator	Color	Status	Meaning (primary error)
(1) PWR	Green	Lit	Power is being supplied.
		Not lit	Power is not being supplied.
(2) ERR	Red	Lit	Error output is ON: Wireless device error, wireless communications error, or host network error has occurred preventing normal I/O communications.
		Not lit	Error output is OFF: Causes of the above conditions have been removed.
(3) MS (Module Status)	Red	Lit	A fatal error has occurred that cannot be recovered from, such as a watchdog timer error, EEPROM error, or hardware error. Replace the WT30 Terminal.
		Flashing	A non-fatal error, illegal switch settings, or EEPROM checksum error has occurred that can be recovered from by resetting the system.
	Green	Lit	Communications are normal.
		Flashing	TEST mode or SET mode has been activated.
	---	Not lit	Power is not being supplied or the system is resetting.
(4) WS (Wireless Status)	Red	Lit	A fatal wireless communications error has occurred, or duplicate wireless node addresses have been set.
		Flashing	A non-fatal communications error, disconnection, or communications timeout has occurred.
	Green	Lit	RUN mode: Connection to wireless communications is completed.
		Flashing	RUN mode: Wireless communications not connected. TEST mode: Received signal strength monitoring in progress.
	---	Not lit	No wireless communications
(5) RSSI (See note 2.) (Received Signal Strength Indicator)	Red/yellow/green	0 to 9 lit	Displays the received signal strength in 10 levels. The field strength is determined by the number of indicators lit: weak for a small number and strong for a large number.
	Green	Flashing	Special function operation has completed.
(6) 0 to 15	Yellow	Lit/not lit	Input or output signal ON/OFF status (0 to 7, 8 to 15)

Note (1) For details on troubleshooting, refer to *5-1 Troubleshooting* on page 68.
 (2) The RSSI can be used to confirm the operation status.

Field strength	Red indicators			Yellow indicators			Green indicators			
	Weak			Medium			Strong			
Number of indicators lit	0	1	2	3	4	5	6	7	8	9
RUN mode	Unstable communications range					Stable communications range				
TEST mode										
Field strength monitor test	Range in which specified channel can be used.			Range in which specified channel cannot be used.						
Installation/confirmation test	Unstable communications range					Stable communications range				

The received signal strength is indicated using 10 levels. Check the communications status, referring to the field strength level.

SECTION 2

Hardware Installation and Connection

This section provides information on connection methods and precautions related to installation.

2-1	Installation	14
2-1-1	Installation location	14
2-1-2	Installation Precautions	14
2-1-3	Determining the Antenna Installation Position	14
2-1-4	Flat Diversity Antennas	18
2-1-5	Dimensions	19
2-1-6	Installation	22
2-2	Connections	24
2-2-1	Cable Connections	24
2-2-2	Wiring Precautions	26
2-2-3	WT30 Power Supply Wiring	27
2-2-4	I/O Terminal Wiring	28
2-3	Wireless System Design Considerations	32
2-3-1	Construction of Multiple Wireless Systems	32
2-3-2	Communications Errors Caused by Intermodulation	33
2-3-3	Serial Master Station Input/Output Data	33

2-1 Installation

Make sure that the radio wave conditions at the installation site are favorable before actually installing the WT30 Terminals.

2-1-1 Installation location

Do not install this device in locations such as the following:

- Areas exposed to direct sunlight
- Areas with extremely high humidity
- Near devices such as televisions, radios, and computers
- Near devices that emit sparks, such as motors, drills, and welding equipment
- Near strong magnets
- Near fluorescent lights
- Inside metal panels or locations surrounded by metal or concrete

If the WT30 Terminal is installed in a metal panel, be sure to mount the entire Antenna outside the panel where there are no interfering objects.

2-1-2 Installation Precautions

- Install the Antennas for the Serial Master Station and I/O Slave Stations or the Relay Stations and I/O Slave Stations in parallel.
- Install the Antennas as far away as possible from and not parallel to electric wires or metal panels.
- Use wood screws when installing the WT30 on a wooden surface.
- Use M4 screws for installation if the provided installation screws are not used.
- Communications are not possible if the Terminals is too close to each other (within 1 m). Make sure that sufficient distance is provided between WT30 Terminals.

2-1-3 Determining the Antenna Installation Position

The WT30 uses radio waves with a frequency of 2.4 GHz, which is very high. High-frequency waves exhibit strong rectilinear propagation and are reflected easily. For this reason, careful consideration of the Antenna installation position is required to achieve optimum wireless performance.

1,2,3...

1. If possible, install Antennas so that there is a direct line of sight between them.

High-frequency waves, which exhibit strong rectilinear propagation, are used and so it is difficult for the waves to reach areas that are not in a direct line of sight, as shown in the following diagram. This is a particularly important point for communications at long distances (e.g., exceeding 50 m or 60 m.)

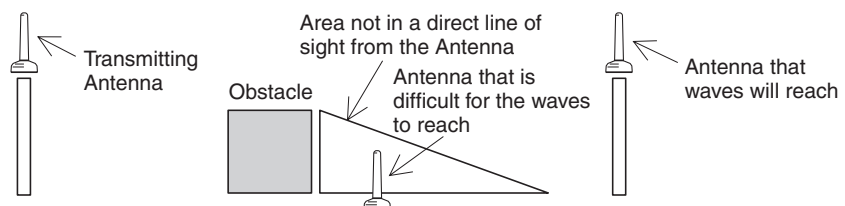

If the Antennas are installed in locations with relatively high ceilings and a lot of open space, even if there is no direct line of sight between the Antennas, if one of the Antennas is installed in a high location, communications may still be possible via radio waves that are reflected off the ceiling.

2. Install in as high a location as possible.

As mentioned in the preceding paragraph, if the Antennas are installed in high locations, because the space surrounding the Antennas will be more open, there will be less influence from obstacles, and the radio waves will propagate more easily.

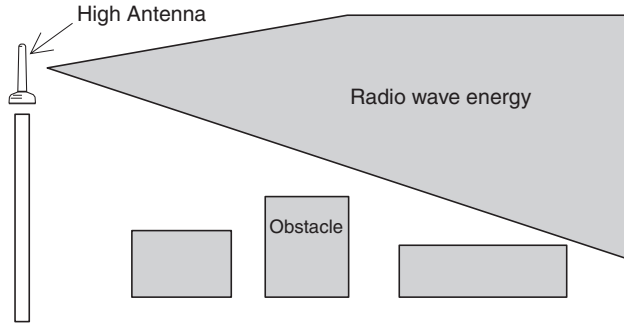

3. Do not place obstacles (especially metal objects) near the Antennas.
If there are obstacles near the Antennas (in particular, in the direction of radio wave propagation), the radio waves may not be propagated due to the influence of the objects. Metal objects have the greatest influence as they reflect radio waves, whereas glass and plastic objects allow the waves to pass through and so have the least influence. Be sure to install Antennas at least 30 cm away from any obstacles.

4. Cable Loss in Magnet-base Antennas
Loss occurs in the cable when using WT30-AT001 Magnet-base Antennas. Therefore, the maximum communications distance is approximately 50 m indoors, which is shorter than for Pencil Antennas.

5. Cable Bending Radius
The minimum bending radius for WT30-AT001 Magnet-base Antennas is 38 mm. Also, do not bend the cable at points less than 34 mm from the end connected to the WT30 Terminal or at points less than 40 mm from the end connected to the Antenna.

The minimum bending radius for WT30-AT002 Flat Diversity Antennas is 50 mm. Also, do not bend the cable at points less than 23 mm from the end connected to the WT30 Terminal or at points less than 20 mm from the end connected to the Antenna.

Cable Bending Radius and Dimensions (Unit: mm)

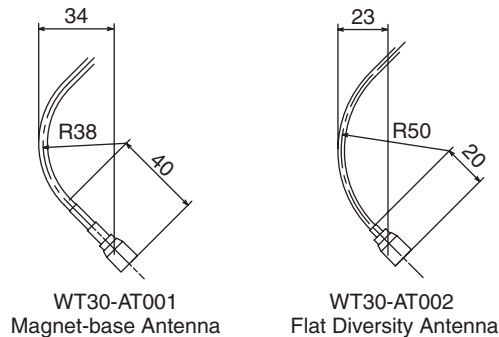

6. Separate different sets of Antennas as much as possible.
If different sets of Antennas are close to each other, they will influence each other and thereby influence wireless communications, causing an increase in the number of retries, and a reduction in the possible communications distance. Separate different sets of Antennas by at least 2 m if possible.
7. Do not install the two Magnet-base Antennas close to each other.
If the two Antennas are close to each other, the diversity effect will not be utilized. Magnet-mounting allows the positions to be adjusted easily. If possible, separate the Antennas by an even greater distance.
8. Install the Antennas with the same orientation.
Install Antennas that are performing communications with the same orientation, as shown in the following diagram. Install Flat Diversity Antennas in the same way. If they are installed at an angle of 90° to each other, the possible communications distance will be shortened.

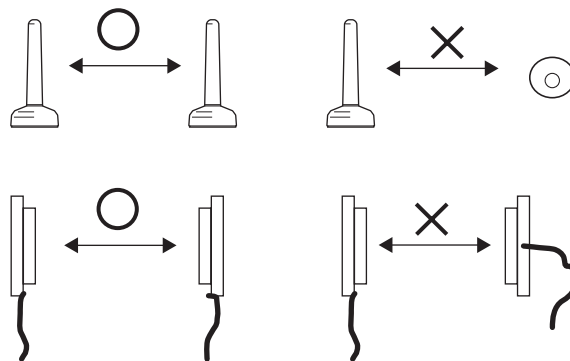

9. Separate the Antennas from ID Tags by at least 3 m.
The OMRON V690 Microwave RFID System uses frequencies within the range used by the WT30 Terminals. Therefore, if the two systems are used on the same floor, observe the following points when installing the systems.
 - Separate the Antennas and ID Tags by at least 3 m.
 - Set the frequency to a channel other than channels 12 to 30 or channels 62 to 79.
10. Direction of Waves Emitted from Magnet-base Antennas
Antennas emit waves in certain directions, and there are certain directions in which waves are received easily. These directions are known as the “directional characteristics.” The directional characteristics for Pencil Antennas and Magnet-base Antennas when they are installed vertically are donut-shaped, spreading outwards horizontally. Radio waves are emitted in every horizontal direction but are not emitted upwards or downwards. Radio wave emissions from the tip of the Antenna are low, so the communications distance will be shortened if the tips of the Antennas for both the WT30 Terminals are installed facing each other.

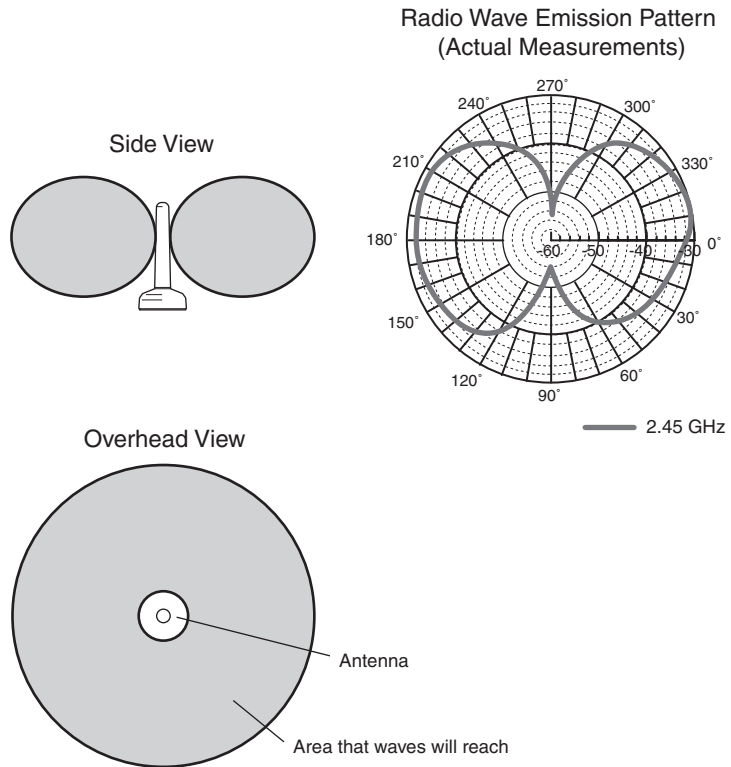

11. Other Points about Magnet-base Antennas

- The magnet on the Magnet-base Antenna is very strong. Do not remove the Antenna by pulling on the cover or cable. Doing so may damage the Antenna. Always hold the base when handling the Antenna.
- Twist the cable as little as possible.
- Design the hole for passing the cable through so that the cable is protected.

12. Direction of Waves Emitted from Flat Diversity Antennas

Flat Diversity Antennas also have directional characteristics, in the same way as Magnet-base Antennas.

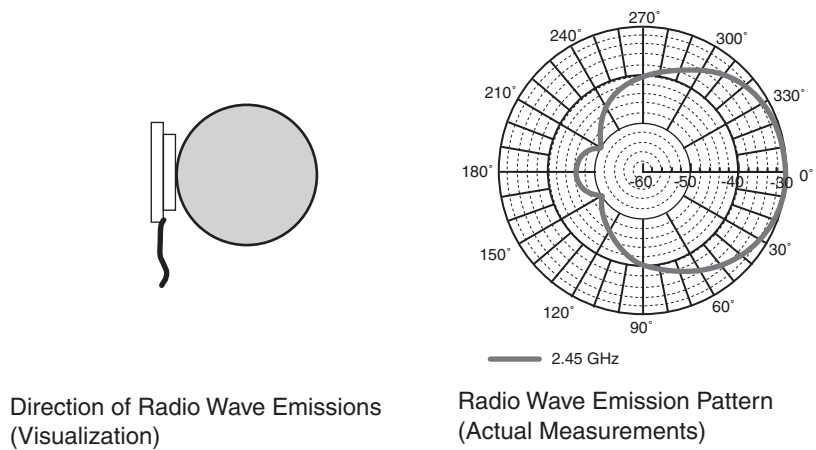

- 13. Do not subject the Antenna to shock.
Do not install the Antenna in a location in which it may be hit by other objects. If installation in such a location is required, take sufficient measures to protect the Antenna. Subjecting the Antenna to strong shock may cause either external or internal damage to the Antenna. Internal damage that is not necessarily externally visible may prevent communications, such as broken wires.

2-1-4 Flat Diversity Antennas

Secure the Flat Diversity Antenna to the Mounting Bracket with screws. The Mounting Bracket includes a magnet for attachment to metal surfaces. Do not tighten the vertical and horizontal angle adjustment knobs at first to allow adjustment of the Antenna position and angle. After adjusting to the correct position, tighten the knobs securely.

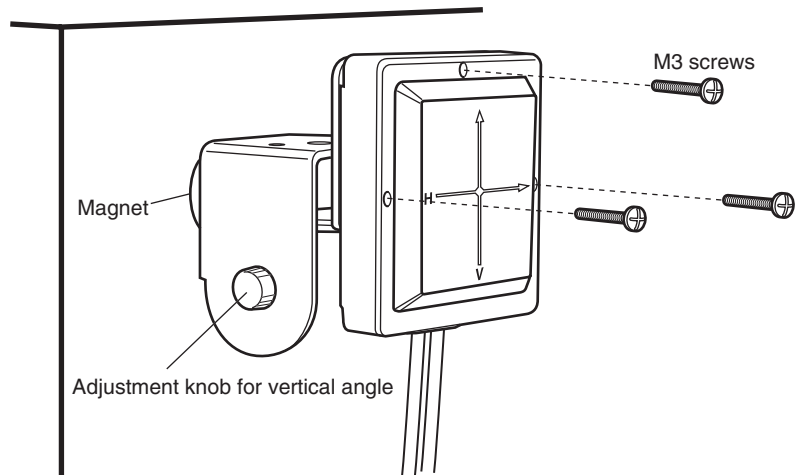

WT30-FT011 Flat Diversity Antenna Mounting Bracket

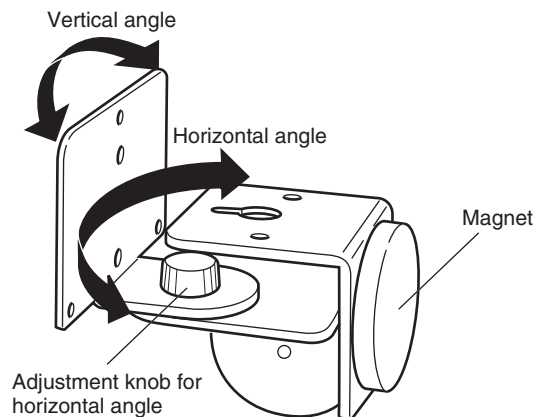

2-1-5 Dimensions

WT30 FA Wireless SS Terminals

Serial Master Station

(Unit: mm)

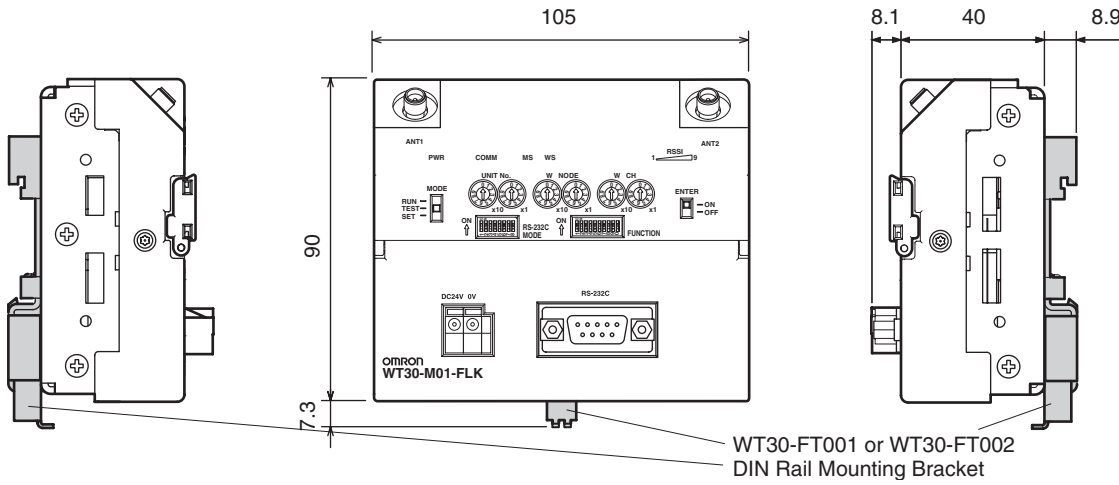

I/O Slave Station
(Example: WT30-SID16)

(Unit: mm)

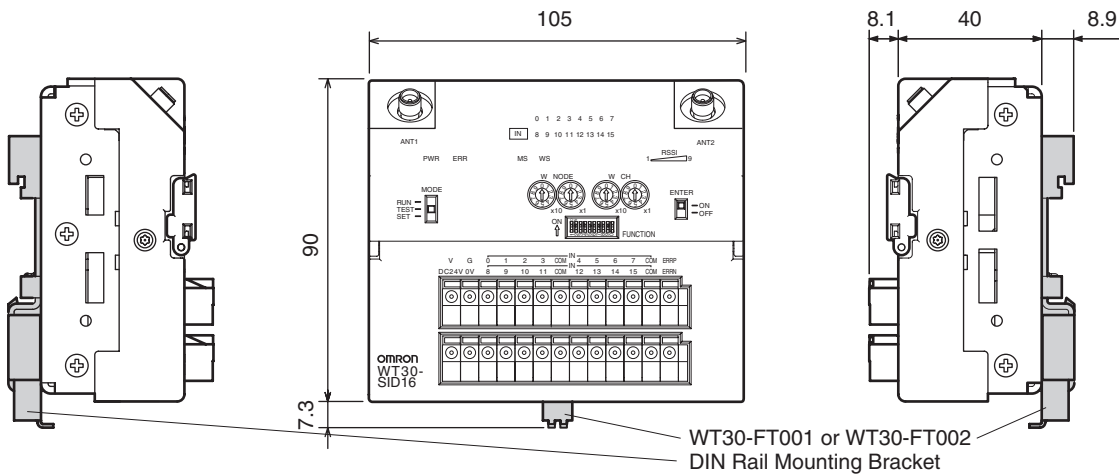

With Antenna Installed
 (Same for Serial Master Station and Slave I/O Stations)

(Unit: mm)

Cable Bending Angle and Dimensions

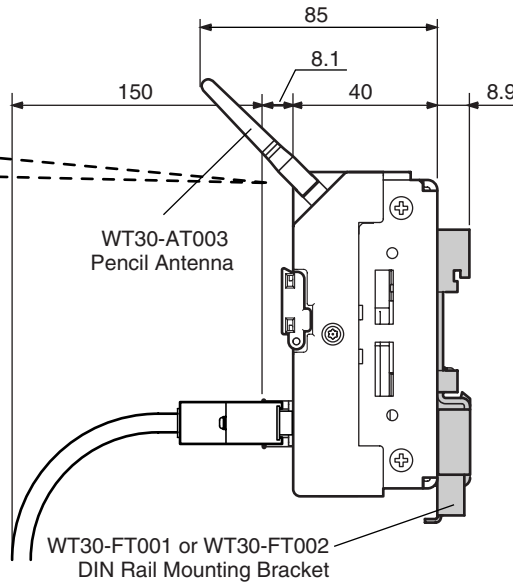
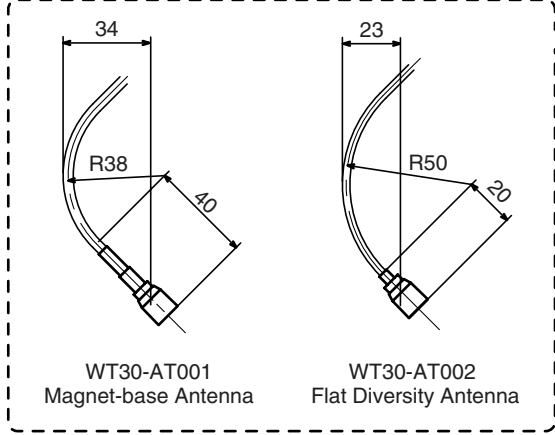

Magnet-base Antenna

WT30-AT001

(Unit: mm)

Flat Diversity Antenna

WT30-AT002

(Unit: mm)

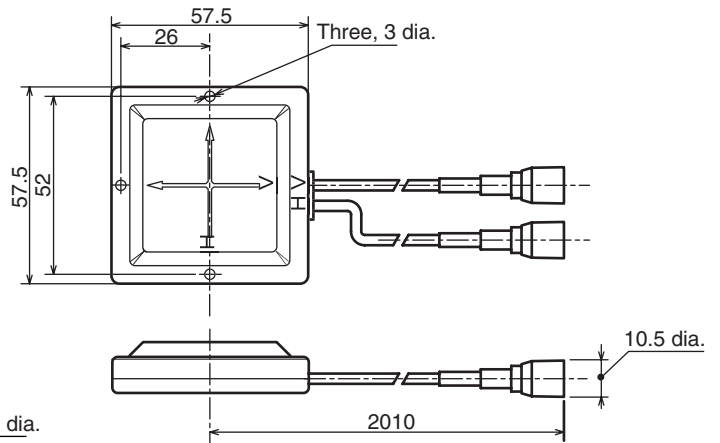
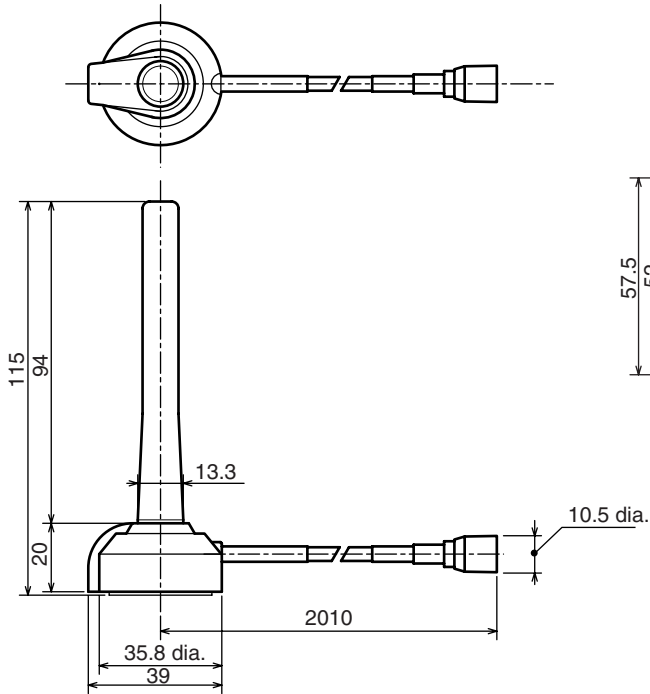

Pencil Antenna

WT30-AT003

(Unit: mm)

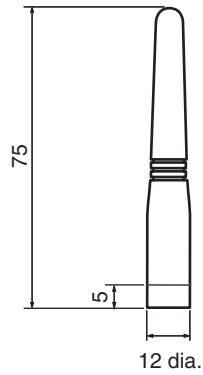

Flat Diversity Antenna Mounting Bracket

WT30-FT011

(Unit: mm)

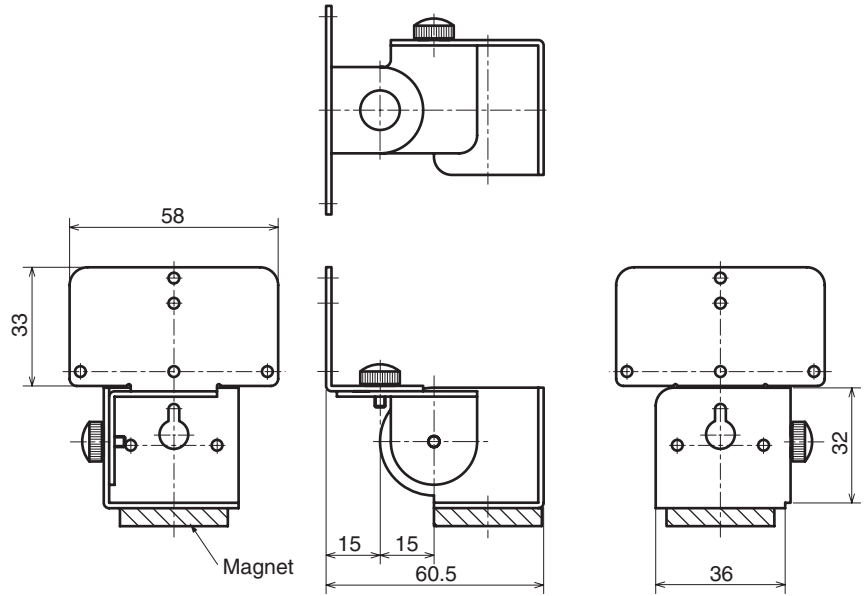

2-1-6 Installation

The WT30 Terminal can be installed either by standing it on a table top, fixing it with screws, or mounting it to a DIN Rail. When fixing with screws, mount the WT30 Terminal to the L-shaped Surface Mounting Bracket before mounting to a panel or other surface.

Table-top Mounting

Attach the adhesive non-slip feet to the bottom of the Serial Master Station and stand the Serial Master Station on a flat surface.

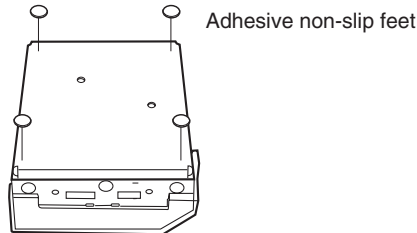

Using an L-shaped Bracket

Holes are required for mounting with L-shaped Brackets.

Mounting Hole Dimensions (Unit: mm)

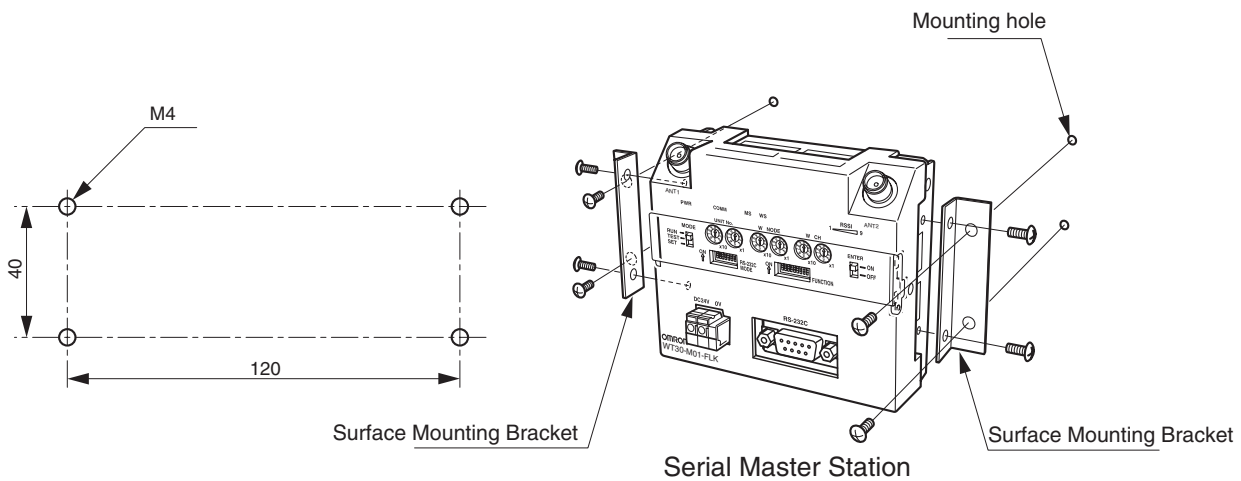

Mounting Hole Dimensions (Unit: mm)

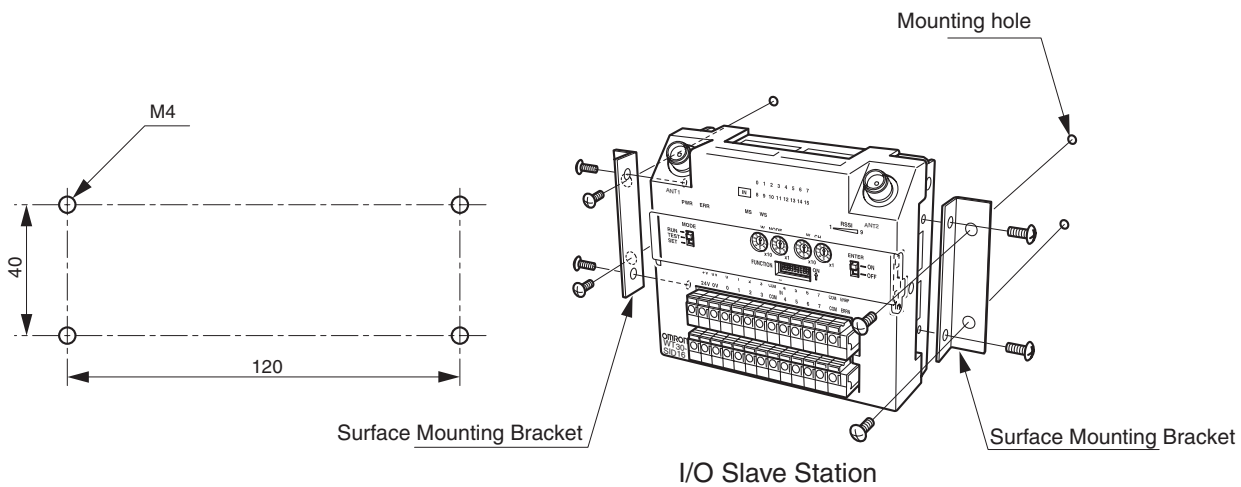

Tighten the WT30 mounting screws using the specified torque of 0.5 to 0.6 N·m.

Using a DIN Rail

Do not install the WT30 in a metal panel when using a Pencil Antenna. Doing so will decrease the wireless performance significantly. To install the WT30 in a panel, use either a Magnet-base Antenna or Flat Antenna and install the Antenna on the outside of the panel. Refer to *Appendix D Optional Accessories* on page 101.

Suitable DIN Rails

Two types of suitable DIN Rail are available. Both have a width of 35 mm. The height is either 7.5 mm or 15 mm (conform to DIN, EN, IEC, and JIS C2812 standards).

Model	DIN Rail	Specifications
WT30-FT001	TH35-7.5	Rail width: 35 mm, Height: 7.5 mm
WT30-FT002	TH35-15	Rail width: 35 mm, Height: 15 mm

Mounting the DIN Rail Adapter

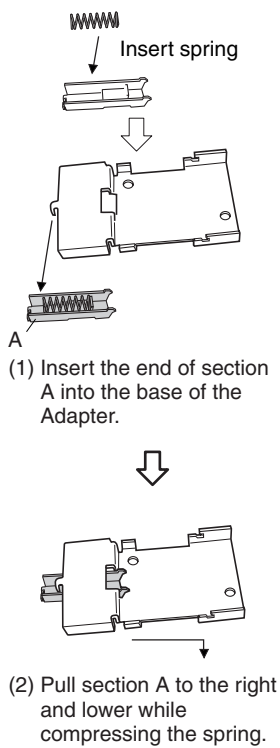

(3) Position the Adapter on the WT30 and secure with screws.

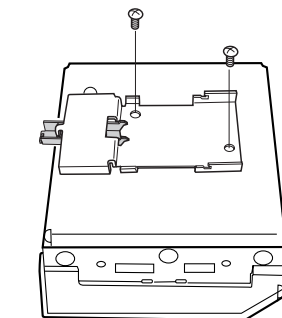

Tighten the WT30 mounting screws using the specified torque of 0.5 to 0.6 N·m.

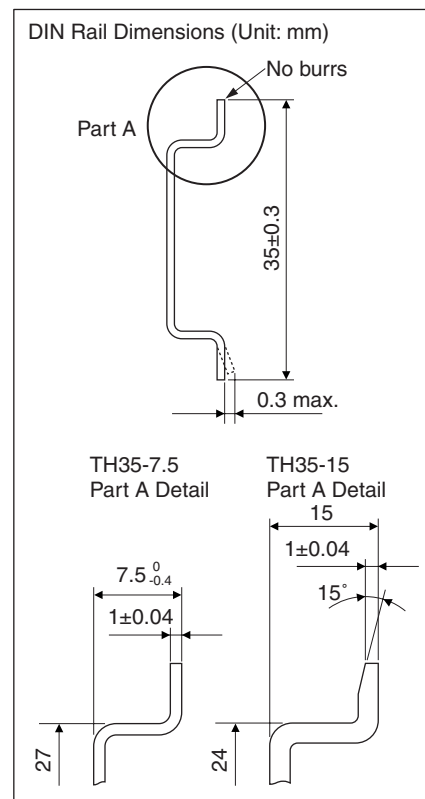

Mounting Method

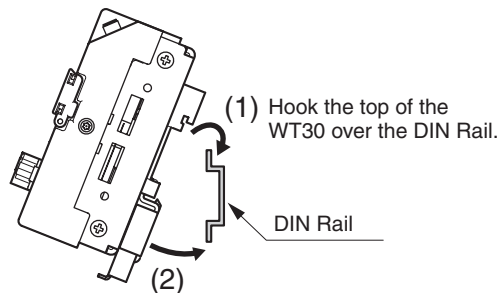

Removal Method

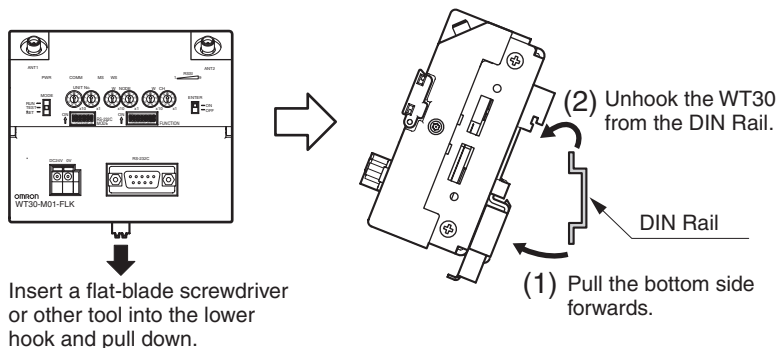

2-2 Connections

2-2-1 Cable Connections

WT30 (Serial Master Station)

Connect the Serial Master Station to the PLC or personal computer using RS-232C cable. If the WT30 is installed in a location subject to frequent vibration, secure the RS-232C cable close to the connector so that force will not be applied to the connector.

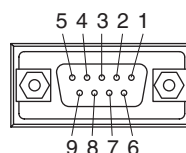
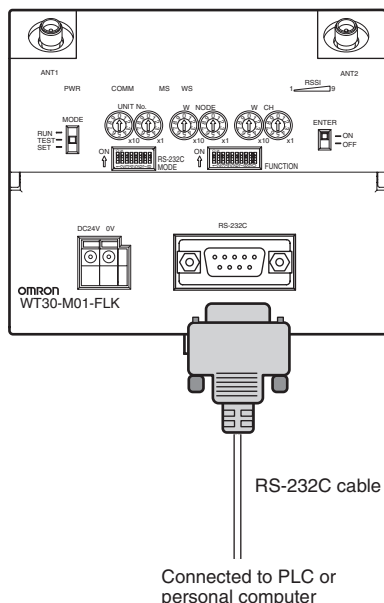

D-sub, 9-pin Female End at WT30

Pin No.	Signal	I/O direction
1	---	---
2	RD	Output
3	SD	Input
4	---	---
5	SG	---
6	---	---
7	---	---
8	---	---
9	---	---

Serial Connection Example 1

The serial setting for the personal computer is set to no flow control.

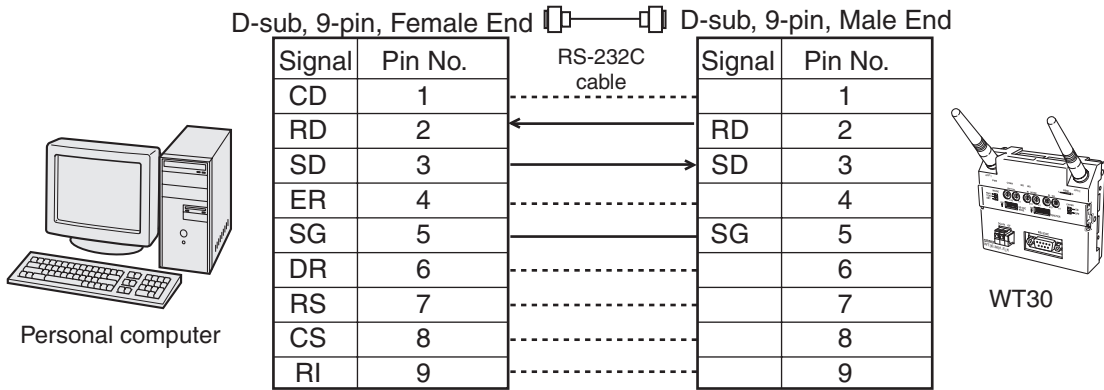

The connections indicated by dotted lines are used with the recommended cables, but are not a problem for operation.

Recommended Cables

Model	Cable length
XW2Z-0100U-3	1 m
XW2Z-0200U-3	2 m
XW2Z-0500U-3	5 m

Serial Connection Example 2

If the serial setting for the personal computer cannot be set to no flow control, prepare the cables short-circuiting pins 4 and 6, and pins 7 and 8.

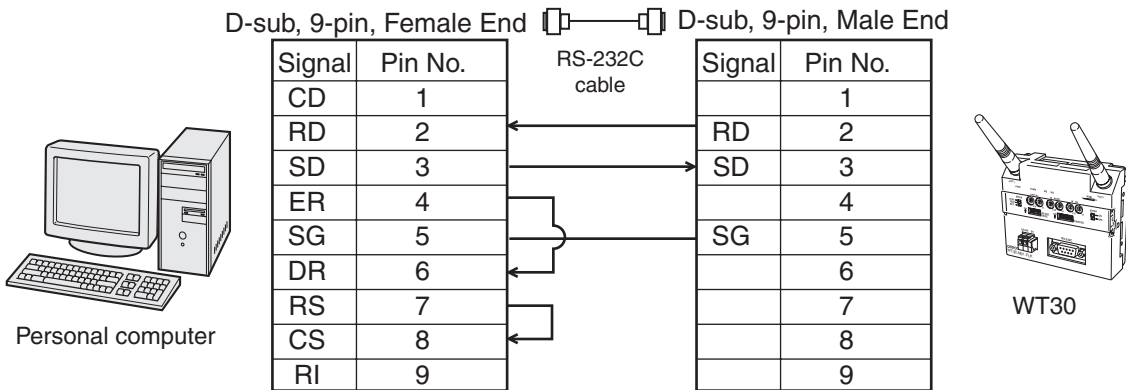

Serial Connection Example 3

The serial setting for the OMRON PLC is set to no flow control.

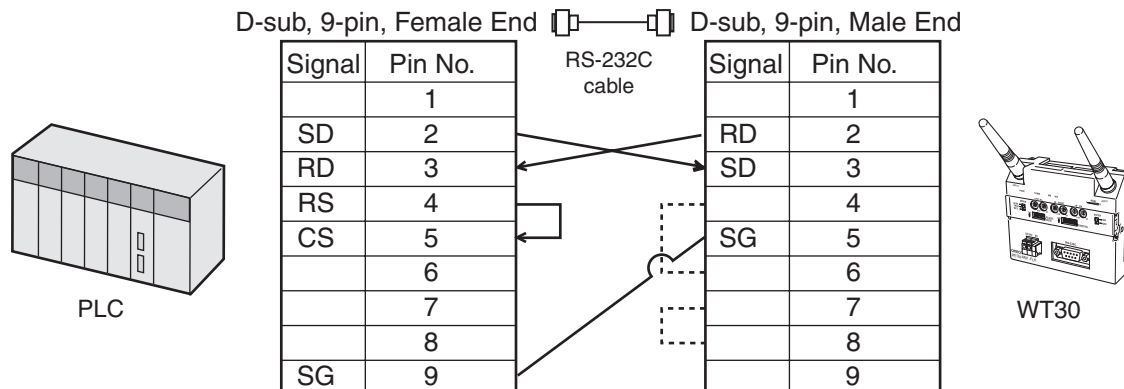

The connections indicated by dotted lines are used with the recommended cables, but are not a problem for operation.

Recommended Cables

Model	Cable length
XW2Z-0200U-5	2 m
XW2Z-0500U-5	5 m

When connecting to CS/CJ-series set the communications ports on the PLC side as shown in the following table.

Communications Settings: User Settings (User-specified Settings)

Item name	Set value	Connecting to a WT30 with initial settings
Serial communications mode	Serial Gateway	Serial Gateway
Parameters Data length Stop bits Parity	Matches the communications settings of the WT30 Terminal.	Data length: 7 bits Stop bits: 2 Parity: Even
Baud rate	Matches the communications settings of the WT30 Terminal.	9,600 bit/s
Send delay time	Sets a user-specified time (Default: None) Note: The communications port of the CPU Unit cannot be set.	Same
CTS control	Sets a user-specified time (Default: None) Note: The communications port of the CPU Unit cannot be set.	Same
Response timeout monitoring time	Sets a user-specified time (Default: 5 s)	Same

2-2-2 Wiring Precautions

- Wire the signal lines separately from power lines to prevent noise interference.
- Do not lay wiring close to the Antenna.
- Turn OFF the power before performing any wiring.

- Wire the terminals using the following post terminals and cables.

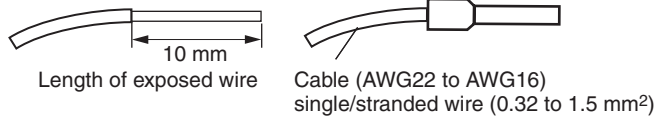

Use a tool of the appropriate size to crimp the post terminal. Make an incision in the cable and remove the covering so that the cable is either the same length as or approximately 0.5 mm longer than the post terminal, as shown in the following diagram. Make sure that no stray wires are protruding and the post terminal is not damaged.

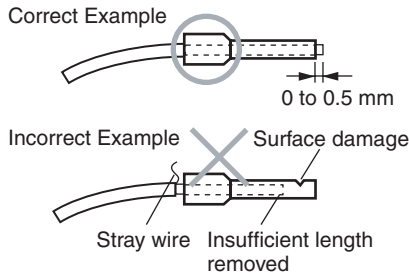

Manufactured by Phoenix Contact

Post terminal	AWG22	AI 0.34-12
	AWG20	AI 0.5-10
	AWG18	AI 0.75-10, AI 1-10
	AWG16	AI 1.5-10
Crimping tool	CRIMPFOX ZA3	

Insert a screwdriver into the screwless terminal block as shown in the following diagram, and keeping the screwdriver inserted, insert the post terminal. Use the same procedure to remove the post terminal. Secure the wiring close to the connector to prevent direct force from being applied to the wiring due to twisted cables or the weight of the cables.

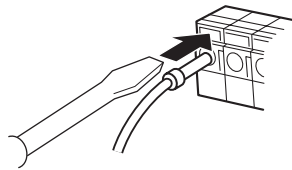

Dust-proof Label

Remove the dust-proof label after completing wiring.

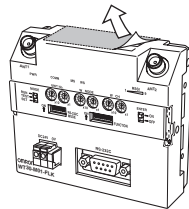

Attaching Terminal Labels (I/O Slave Stations Only)

Attach terminal labels inside the switch cover to the positions shown in the following diagram.

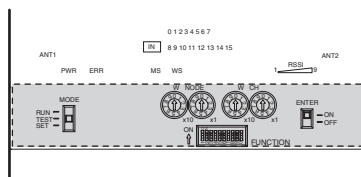

2-2-3 WT30 Power Supply Wiring

The power supply voltage for WT30 Terminals is 24 VDC.

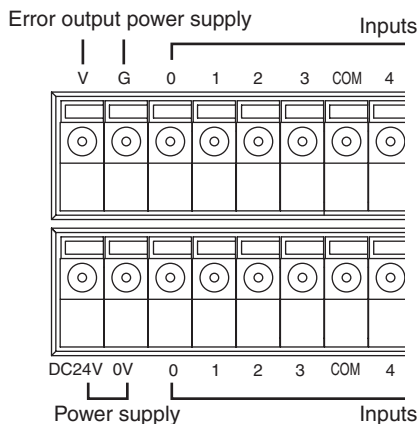

Power supply voltage	24 VDC
Allowable voltage range	20.4 to 26.4 VDC

WT30 Terminals require a 24-VDC power supply. Provide a power supply of at least 15 W, considering the inrush current generated at startup. An OMRON Switching Power Supply Unit is recommended. Refer to *Appendix B List of Supported Devices* on page 97 for details.

2-2-4 I/O Terminal Wiring

WT30-SID16 Input Unit

Input Characteristics

Item	Specifications
Input voltage	24 VDC
Allowable voltage range	20.4 to 26.4 VDC
Input impedance	4.7 kΩ (typical)
Input current	5 mA (typical)
ON voltage/current characteristics	17.4 VDC, 3.0 mA min.
OFF voltage/current characteristics	5.0 VDC, 1.0 mA max.
Input filter	10 ms/100 ms (Selected using switch.)

Error Output Characteristics

Item	Specifications
Input voltage	24 VDC
Allowable voltage range	20.4 to 26.4 VDC
Max. switching current	100 mA max. per output (at 20.4 to 26.4 VDC) Simultaneous usage of error output NPN/PNP is not possible.
Leakage current	0.1 mA max.
Residual voltage	1.0 V max.
Fuse	One for every two outputs except for error output circuits, which have one for every NPN/PNP output. (No fuses can be replaced by the user.)

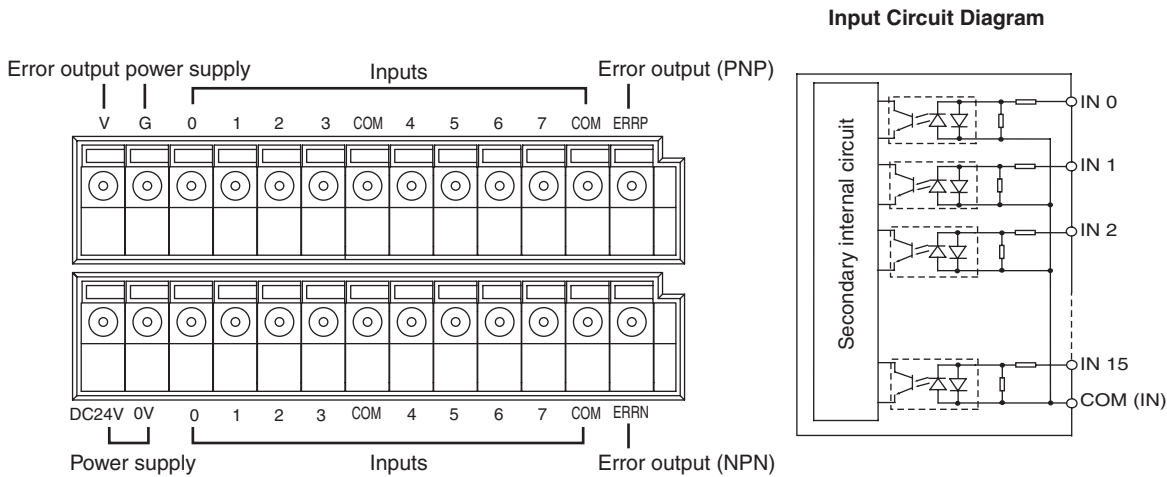

WT30-SMD16(-1) I/O Slave Stations

Output/Error Output Characteristics

Item	Specifications
Input voltage	24 VDC
Allowable voltage range	20.4 to 26.4 VDC
Max. switching current	100 mA max. per output (at 20.4 to 26.4 VDC) Simultaneous usage of error output NPN/PNP is not possible.
Leakage current	0.1 mA max.
Residual voltage	1.0 V max.
Fuse	One for every two outputs except for error output circuits, which have one for every NPN/PNP output. (No fuses can be replaced by the user.)

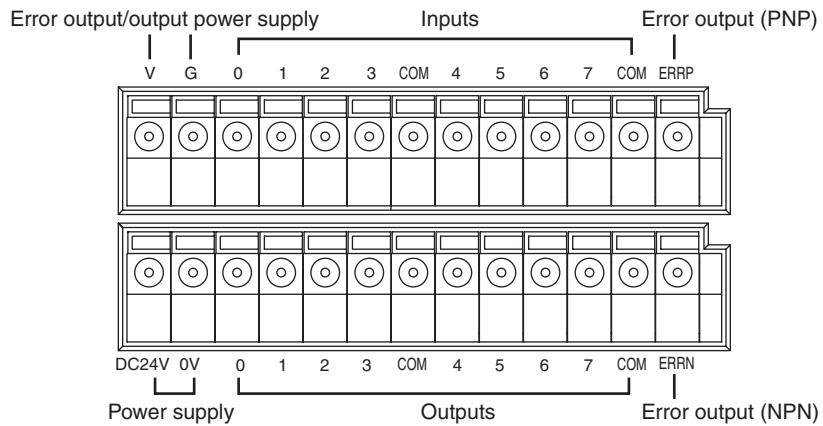

Error output/output power supply

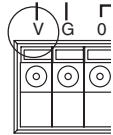

Error output/output power supply

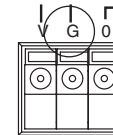

With WT30-SMD16 NPN outputs, the output COM terminal (lower level) is internally connected to the V terminal. When the error output ERRN terminal is used, the COM terminal on the output side can be shared. The polarity of PNP outputs is opposite from that of the error output ERRP terminal, and therefore the common cannot be shared.

With WT30-SMD16-1 PNP outputs, the output COM terminal (lower level) is internally connected to the G terminal. When the error output ERRP terminal is used, the COM terminal on the output side can be shared. The polarity of NPN outputs is opposite from that of the error output ERRN terminal, and therefore the common cannot be shared.

NPN Output Circuit Diagram

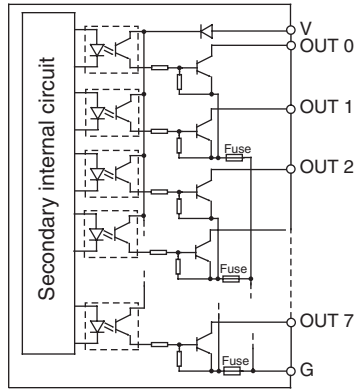

PNP Output Circuit Diagram

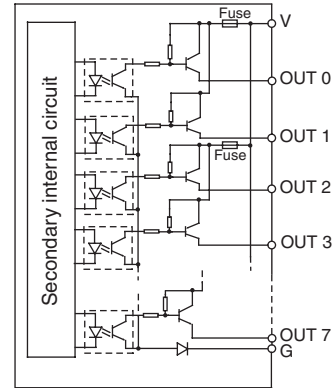

Error Output Circuit Diagram

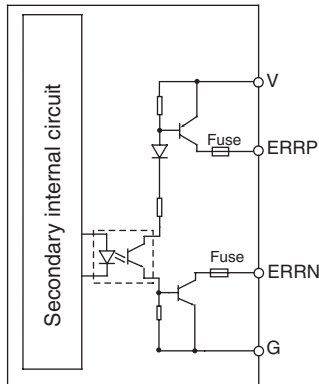

Connecting to Input Devices

Input Device with Contact Output

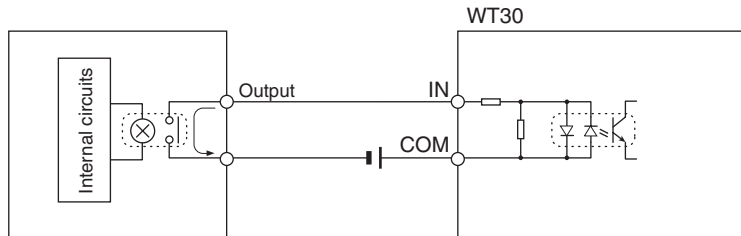

Input Device with NPN Open-collector Output

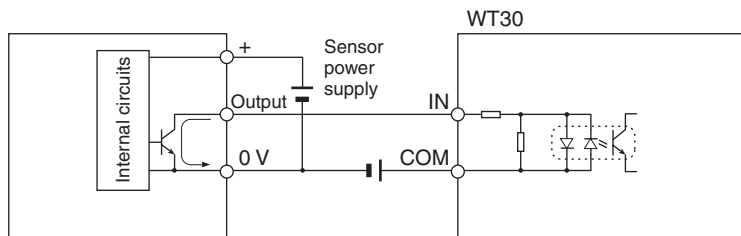

Input Device with Voltage Output

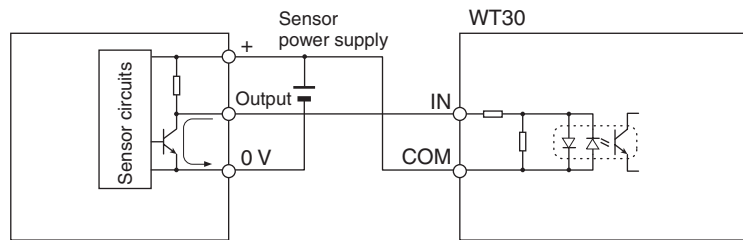

Input Device with NPN Output

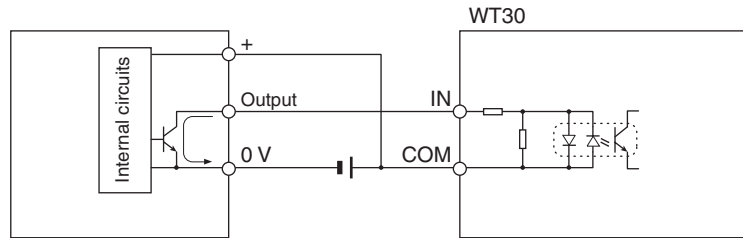

Input Device with PNP Output

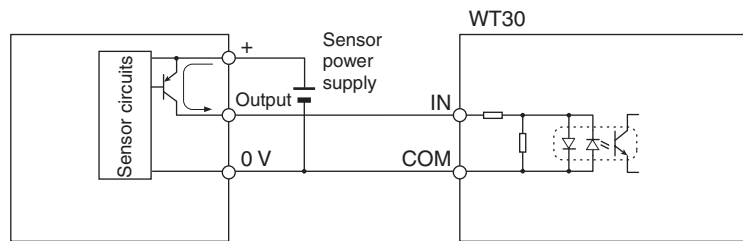

Connecting to Output Loads

PNP Output

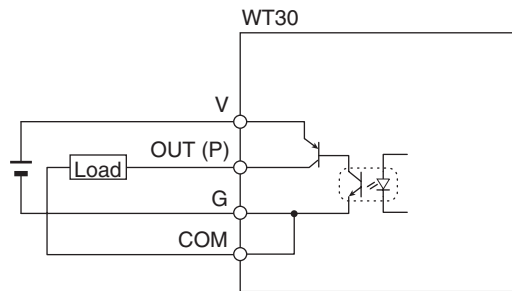

NPN Output

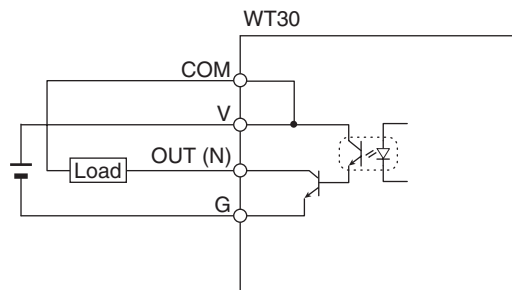

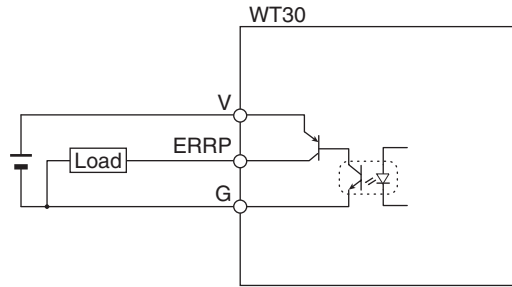
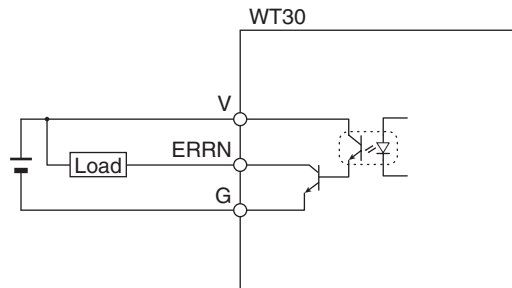
Connecting to Error Output**PNP Output****NPN Output**

2-3 Wireless System Design Considerations

2-3-1 Construction of Multiple Wireless Systems

When constructing a system for using multiple Serial Master Stations, the following points must be considered. Consult your OMRON representative.

Setting Wireless Channels

Frequencies that are not interfered with by radio waves must be selected for the wireless channels. (Radio interference can be handled by retry processes between the wireless networks, but will lengthen the system response time.)

The WT30 supports 67 wireless channels from which to select. As a rough guide, however, a maximum of 10 wireless systems can be used in a single area without radio interference on account of the following considerations.

1,2,3...

1. Do not select neighboring wireless channels as they have a large amount of interference.
2. Due to the fundamental nature of radio waves, if two or more waves with different frequencies are output at exactly the same time, mutual interference will occur between the different frequencies, and new waves will be generated with frequencies at intervals equal to the intervals between the output frequencies. (This phenomenon is called intermodulation.)
For example, if channels 5 and 9 are used, electromagnetic interference will be generated with channels 1 and 13, as shown in the following diagram. In this case, channels 2 and 14 can be used, but the frequency of channel 51 is located between the frequencies for channels 1 and 2, and the frequency of channel 63 is located between the frequencies for channels 13 and 14. Therefore, the channel with the frequency following channel 1 is channel 51. Channels 5, 9, 51, and 63 can be used without interference. For details on frequencies, refer to *Appendix F Frequency Table* on page 105.

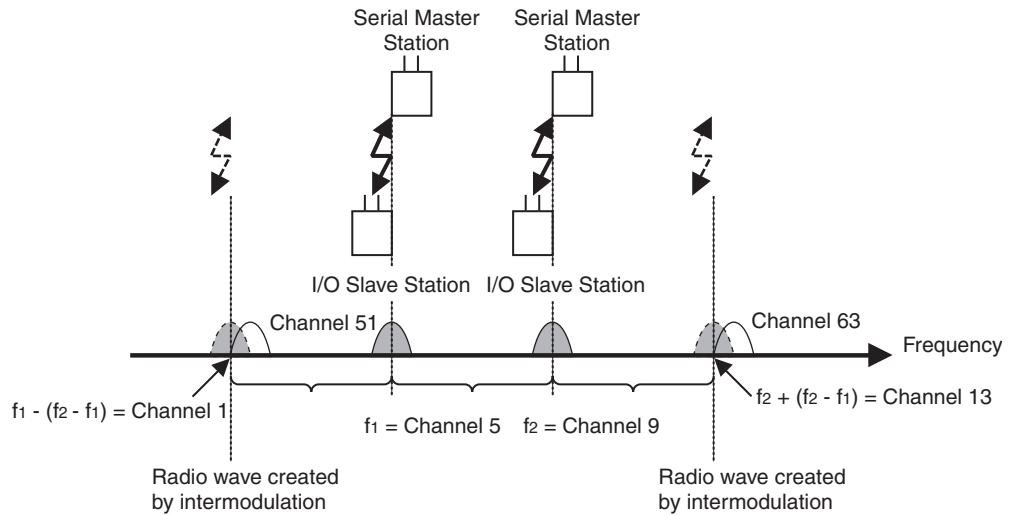

Do not select the frequencies of radio waves created by intermodulation.

Antenna Separation Distance

The distance between WT30 Terminals has a large influence on the amount of interference received. In particular, there may often be cases where Serial Master Stations are installed relatively closely to each other. Separate the Antennas for different Serial Master Stations by at least 2 m if possible.

Test Confirmation

Perform a test to see whether or not the WT30 Terminals are receiving interference. Use the RSSI (Received Signal Strength Indicator) on both the Serial Master Station and I/O Slave Station to check the interference.

2-3-2 Communications Errors Caused by Intermodulation

Communications errors and retry processing may occur due to intermodulation resulting in transmission delays. To eliminate the influence of intermodulation, do not set the wireless channels for WT30 Terminals in every system to frequencies at regular intervals.

2-3-3 Serial Master Station Input/Output Data

The Serial Master Station's input/output data is cleared by turning OFF the power. After turning ON the power, an output signal of all zeros (OFF) is sent to the output of the I/O Slave Stations from the Serial Master Station.

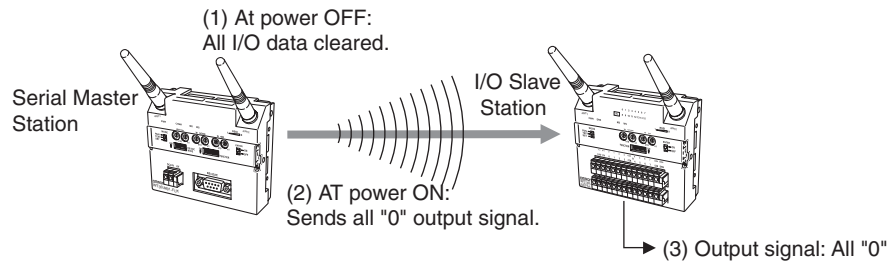

Intermodulation

Due to the fundamental nature of radio waves, if two or more waves with different frequencies are output at exactly the same time, mutual interference will occur between the different frequencies, and new waves will be generated with frequencies at intervals equal to the intervals between the output frequencies.

SECTION 3

Basic Settings

This section describes the procedures for making the WT30 settings and also provides information on the function settings.

3-1	Scan List	36
3-2	Monitoring Unused Frequencies	37
3-2-1	Wireless Channel Monitor for Specified Channels	37
3-2-2	Monitoring All Wireless Channels	38
3-2-3	Clearing the Recorded Peak Values for the Received Signal Strength	40
3-3	Setting Flowchart	41
3-4	Using Unregistered Communications Partners	42
3-4-1	Finding Unused Channels	42
3-4-2	Operation Settings	43
3-4-3	Confirming Connection Status	44
3-5	Registering the Communications Partner	45
3-5-1	Finding Unused Channels	46
3-5-2	Registering Communications Partners (All I/O Slave Stations)	47
3-5-3	Operation Settings	49
3-5-4	Confirming Connection Status	49
3-6	Function Setting Switch	50
3-6-1	Scan List Registration	50
3-6-2	Stopping Registration of All I/O Slave Stations	51
3-6-3	Scan List Enabled/Disabled Mode	52
3-6-4	Input Hold	53
3-6-5	Input Filter	55
3-6-6	Output Control for Communications Errors	56
3-6-7	Returning to Default Settings	56

3-1 Scan List

Communications are divided into two types depending on whether the communications partner (I/O Slave Station) is registered or unregistered. Registration of communications partners is referred to as scan list registration. The mode for communications with specified, registered communications partners is referred to as scan list enabled mode. The mode for communications between the Serial Master Station and unregistered I/O Slave Stations from the specified node number 1 up to the specified number of nodes is referred to as scan list disabled mode.

For details, refer to 3-6-1 Scan List Registration on page 50.

- Communications with Unregistered Communications Partner (Scan List **Disabled** Mode)
- Communications with Registered Communications Partner (Scan List **Enabled** Mode)

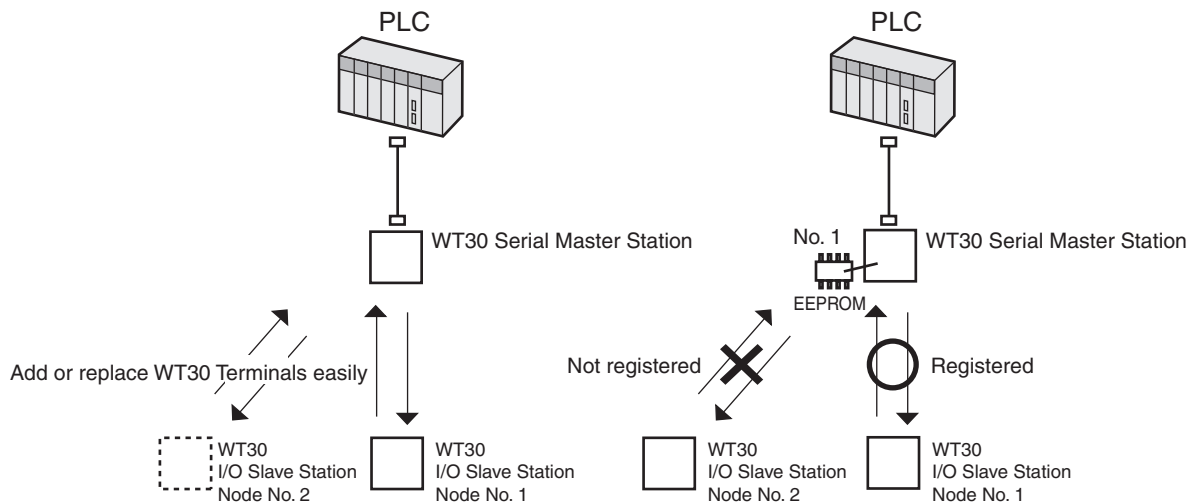

Unregistered Slaves	Registered Slaves
Mistaken recognition will occur if an I/O Slave Station set with the same node number or frequency channel is present in the radio signal range.	Communications are performed with registered I/O Slave Stations only. Therefore, mistaken recognition will not occur. Communications are also only performed with the specified I/O Slave Stations, thereby eliminating unnecessary polling and heightening security.
Immediate operation is possible by simply setting the frequency channel and node number for the I/O Slave Station after it is added or replaced. This usage is supported provided that the same frequency channel is not already being used nearby, and that the operation on a different frequency channel can be confirmed.	By registering the I/O Slave Station with the serial number check enabled, re-registration at the Serial Master Station is required when an I/O Slave Station is replaced.

For details on using unregistered slave stations, refer to 3-4 Using Unregistered Communications Partners and for using registered slave stations, refer to 3-5 Registering the Communications Partner.

3-2 Monitoring Unused Frequencies

The peak value of the received signal strength in the frequency band being used is monitored onsite, enabling selection of available channels (frequencies).

3-2-1 Wireless Channel Monitor for Specified Channels

The actual received signal strength for the channel specified using the channel setting switch can be monitored in realtime using the display.

- 1,2,3... 1. Before turning ON the power, set the function setting switch as follows:

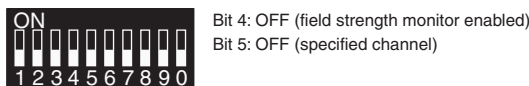

2. Set the frequency channel to be monitored using the channel setting switch (WCH switch).

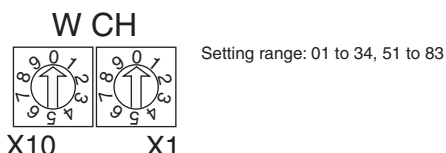

3. Set the mode setting switch to TEST mode, and turn ON the power. The MS and WS indicators will flash green.

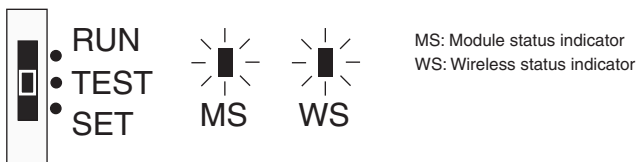

4. The monitoring results are displayed using the 10 levels of the RSSI (received signal strength indicator).

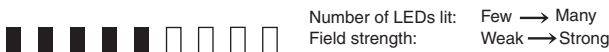

5. The received signal strength is indicated using 10 levels according to the frequency monitoring results obtained by setting the channel setting switch. The monitoring results are not recorded in the EEPROM.

Received Signal Strength Indicator

Field strength	Red indicators			Yellow indicators			Green indicators			
	Weak			Medium			Strong			
Number of indicators lit	0	1	2	3	4	5	6	7	8	9
RUN mode	Unstable communications range					Stable communications range				
TEST mode										
Field strength monitor test	Range in which specified channel can be used.			Range in which specified channel cannot be used.						
Installation/confirmation test	Unstable communications range					Stable communications range				

The received signal strength is indicated using 10 levels. Check the communications status, referring to the field strength level.

3-2-2 Monitoring All Wireless Channels

The received signal strength for all wireless channels is automatically scanned (the channel is changed every second), and the peak value is automatically recorded in EEPROM. (All channels are level 0 in the default settings.) The recorded peak value can be read during automatic scanning or when automatic scanning is stopped. Approximately 70 seconds is required to read the received signal strength for all channels. The automatic scan status can be confirmed using the WS indicator. In the first cycle, the WS indicator flashes green, and from the second and subsequent cycles, the WS indicator is lit green.

When starting the automatic scan to perform monitoring for the first time, allow a minimum of approximately 70 seconds before reading the peak values.

During automatic scanning, data is constantly overwritten. Therefore, to read data collected onsite from an office, for example, the data must be read when automatic scanning is stopped.

Note To change the installation position of the WT30 Terminal if the surrounding radio wave conditions change, the recorded peak values for the received signal strength must be cleared to enable an accurate reading of the surrounding radio wave conditions. Clear the recorded data and then start a new automatic scan.

- 1,2,3...** 1. Before turning ON the power, set the function setting switch as follows:



Bit 4: OFF (field strength monitor enabled)
Bit 5: ON (automatically select all channels)

2. Change the mode setting switch setting to TEST mode and turn ON the power. The MS/WS indicators will flash green.



MS: Module status indicator
WS: Wireless status indicator

The automatic scan will start for all channels. The automatic scan will start from the specified channel, proceed sequentially up to channel 83, and then return to channel 1. Scanning will continue until the power is turned OFF (for the total 67 channels).



- The WS indicator will change from flashing green to being lit green when the automatic scan completes one cycle (the received signal strength is recorded). Automatic scanning will continue.

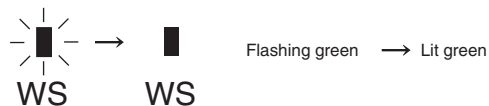

Automatic scanning executes a single scan for each channel. Radio waves may be received from channels for which the automatic scan has been completed. Therefore, executing the automatic scan for longer periods of time, and not for just a single cycle, is recommended.

- Specify the channel to be monitored using the channel setting switch.

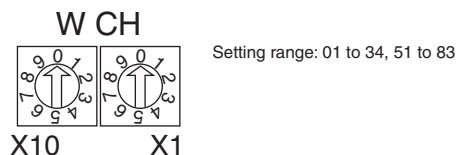

- The peak value for the recorded received signal strength is displayed using the 10 levels indicated by the RSSI.



Reading the Recorded Received Signal Strength after Stopping the Automatic Scan

This operation is used to monitor the peak value after first stopping the automatic scan temporarily so that the recorded received signal strength peak values will not be overwritten.

1,2,3...

- Set the function setting switch as shown below and change the setting of the mode setting switch from RUN mode to TEST mode. The MS indicator will flash green.

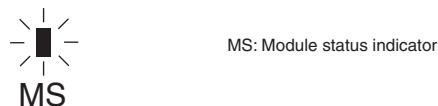

- Set the frequency channel to be monitored using the channel setting switch.

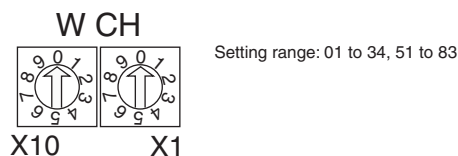

- The peak value for the recorded received signal strength is displayed using the 10 levels indicated by the RSSI.



3-2-3 Clearing the Recorded Peak Values for the Received Signal Strength

Use the following procedure to clear the peak values recorded for all the channels.

- 1,2,3... 1. Set the function setting switch as follows:



Bit 4: ON (field strength monitor disabled)

2. Change the setting for the mode setting switch from RUN mode to TEST mode.



3. Change the setting of the special function switch as follows:

ENTER



— ON OFF → ON → OFF
— OFF

4. Confirm that data has been cleared using the RSSI. The RSSI's green indicators will flash 4 or 5 times to indicate that data has been cleared.

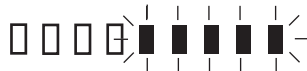

RSSI display: Green indicators flashing

3-3 Setting Flowchart

The setup procedure for the WT30 is described below. To perform simple communications without registering I/O Slave Stations, perform the following settings omitting step 2.

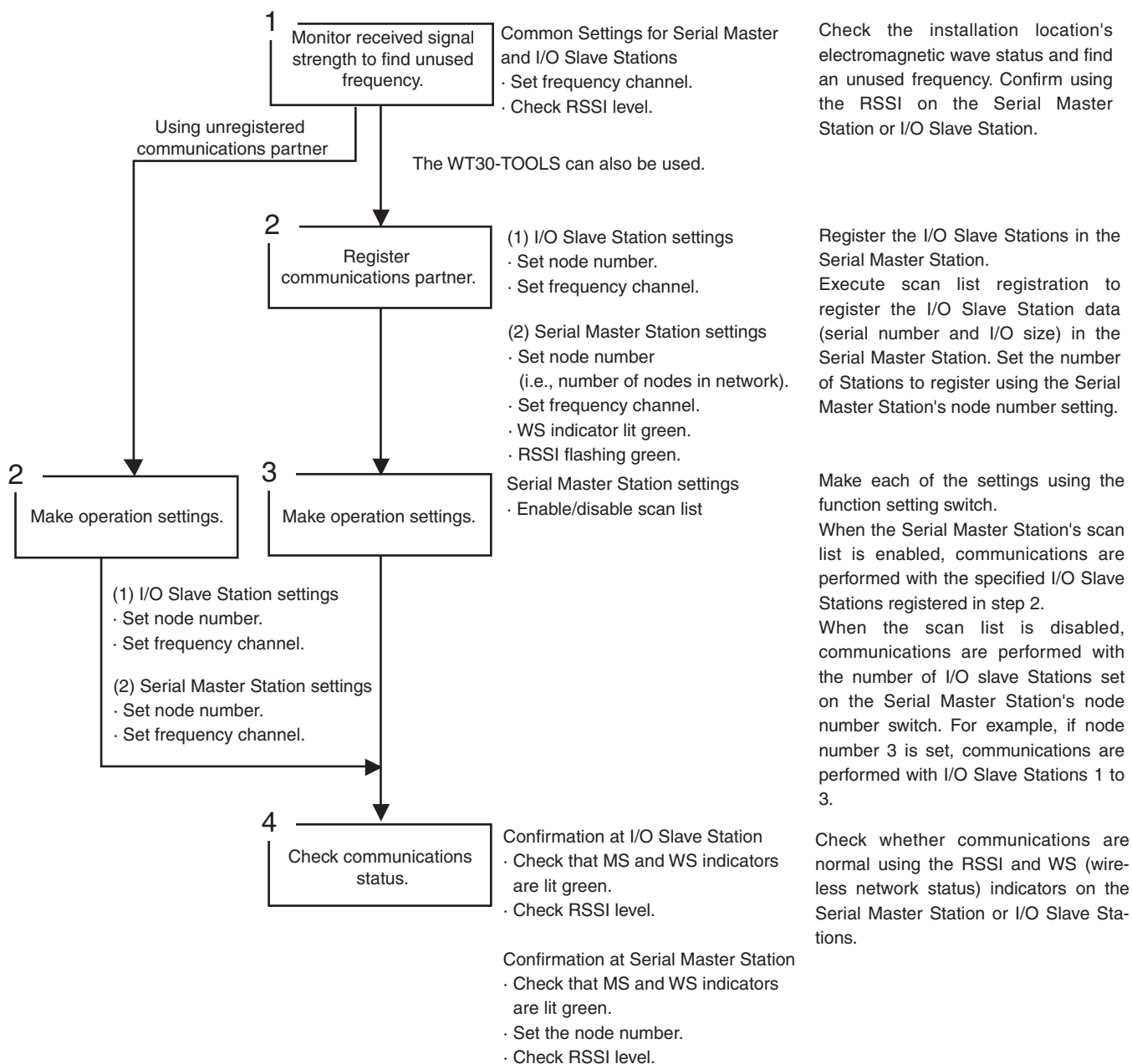

**WT30 Utility
WT30-TOOLS**

The WT30 utility called WT30-TOOLS can be downloaded free of charge from the OMRON website. Be sure to read the software licence agreement before downloading the utility.

3-4 Using Unregistered Communications Partners

Use the following procedure to operate a system configured with a Serial Master Station and either a PLC or personal computer connected via RS-232C in which the I/O Slave Stations have not been registered.

3-4-1 Finding Unused Channels

Specify the frequency channel using the channel setting switch and monitor the actual measurement values for the received signal strength in real time.

Common Settings for Serial Master Station and I/O Slave Stations

- 1,2,3... 1. Before turning ON the power, set the function setting switch as follows:



Bit 4: OFF (field strength monitor enabled)
Bit 5: OFF (specified channel)

2. Change the setting for the mode setting switch to TEST mode, and then turn ON the power.



3. Specify the channel to be monitored using the channel setting switch.

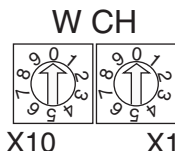

Setting range: 01 to 34, 51 to 83

Note For details on monitoring wireless channels when all wireless channels are specified, refer to 3-2-2 *Monitoring All Wireless Channels* on page 38.

4. Check the monitoring results on the RSSI display indicated using 10 levels.



In the RSSI shown in the following table, if one or less indicator is lit, the corresponding channel being monitored can be used.

Received Signal Strength Indicator

Field strength	Red indicators			Yellow indicators			Green indicators			
	Weak			Medium			Strong			
Number of indicators lit	0	1	2	3	4	5	6	7	8	9
RUN mode	Unstable communications range					Stable communications range				
TEST mode										
Field strength monitor test	Range in which specified channel can be used.			Range in which specified channel cannot be used.						
Installation/confirmation test	Unstable communications range					Stable communications range				

The received signal strength is indicated using 10 levels. Check the communications status, referring to the field strength level.

3-4-2 Operation Settings

I/O Slave Station Settings

- 1,2,3... 1. Before turning ON the power, set the function setting switch as required.



Bit 1: Hold/clear I/O data if communications errors occur
 Bit 2: Input hold/normal mode
 Bit 3: Input filter (100 ms/10 ms)

2. Set the node number of the I/O Slave Station using the node setting switch.

W NODE

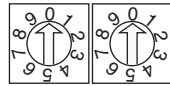

Setting range: 01 to 64

3. Set the same frequency channel used by the Serial Master Station using the channel setting switch.

W CH

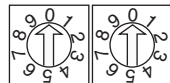

Setting range: 01 to 34, 51 to 83

4. Change the setting for the mode setting switch to RUN mode, and then turn ON the power.



Serial Master Station Settings

- 1,2,3... 1. Before turning ON the power set the function setting switch as required.



Bit 1: Hold/clear I/O data if communications errors occur
 Bit 2: OFF (scan list disabled)

Note When the scan list is disabled, communications are performed with the number of I/O Slave Stations set using the node setting switch.
 Example 1: If the node setting switch is set to 2, communications will be performed with up to 02 I/O Slave Stations.
 Example 2: If the node setting switch is set to 64, communications will be performed with up to 64 I/O Slave Stations.

2. Set the number of I/O Slave Stations to be connected using the node setting switch.

Polling will be performed for the number of I/O Slave Stations set here. For example, if the number is set to 2, communications will be performed with only 2 Stations even if 3 or more Stations actually exist.

W NODE

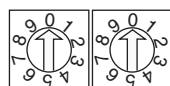

Setting range: 01 to 64

- Set the frequency channel using the channel setting switch.

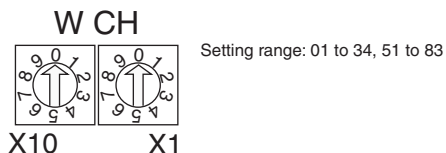

- Change the setting for the mode setting switch to RUN mode, and then turn ON the power.



3-4-3 Confirming Connection Status

Confirm the communications status between the I/O Slave Stations and Serial Master Station using the RSSI (received signal strength indicator) display. To confirm the status from the Serial Master Station, specify the I/O Slave Station to be monitored using the node setting switch. Be sure to turn ON the power to the I/O Slave Station in RUN mode before the Serial Master Station.

I/O Slave Stations

1,2,3...

- Confirm that the mode setting switch on the I/O Slave Station is set to RUN mode.



- Confirm that the MS and WS indicators on the I/O Slave Station are lit green.

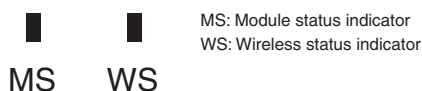

- Check the strength of the received signal from the Serial Master Station indicated using 10 levels on the RSSI display.



Serial Master Station

1,2,3...

- Confirm that the mode setting switch on the Serial Master Station is set to RUN mode.



- Confirm that the MS and WS indicators on the Serial Master Station are lit green.

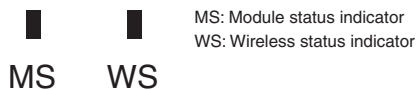

- Specify the node number of the I/O Slave Station to be monitored on the Serial Master Station's node setting switch.

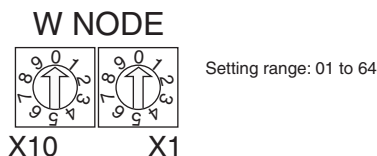

Note The Serial Master Station node number is set to the maximum number of I/O Slave Stations. When the maximum number of nodes is set to a number higher than the number of nodes connected, however, the highest node number is not used. The communications partner for this node number does not exist, so no display is shown on the RSSI. If the node number is changed to that of a node that is actually connected, the RSSI display will indicate the corresponding signal strength.

- Check the strength of the received signal from the I/O Slave Station specified by the node setting switch. The strength is indicated using 10 levels on the RSSI display.



Received Signal Strength Indicator

	Red indicators			Yellow indicators			Green indicators			
Field strength	Weak			Medium			Strong			
Number of indicators lit	0	1	2	3	4	5	6	7	8	9
RUN mode	Unstable communications range					Stable communications range				
TESTmode										
Field strength monitor test	Range in which specified channel can be used.			Range in which specified channel cannot be used.						
Installation/confirmation test	Unstable communications range					Stable communications range				

The received signal strength is indicated using 10 levels. Check the communications status, referring to the field strength level.

3-5 Registering the Communications Partner

Use the following procedure to operate a system configured with a Serial Master Station and either a PLC or personal computer connected via RS-232C in which the I/O Slave Stations have been registered.

3-5-1 Finding Unused Channels

Specify the frequency channel using the channel setting switch and monitor the actual measurement values for the received signal strength in real time.

Common Settings for the Serial Master Station and I/O Slave Stations

- 1,2,3... 1. Before turning ON the power, set the function setting switch as follows:



Bit 4: OFF (field strength monitor enabled)
Bit 5: OFF (specified channel)

2. Change the setting for the mode setting switch to TEST mode, and then turn ON the power.



3. Specify the channel to be monitored using the channel setting switch.

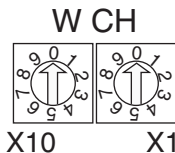

Setting range: 01 to 34, 51 to 83

Note For details on monitoring wireless channels when all wireless channels are specified, refer to 3-2-2 *Monitoring All Wireless Channels* on page 38.

4. Check the monitoring results on the RSSI display indicated using 10 levels.



In the RSSI shown in the following table, if one or less indicator is lit, the corresponding channel being monitored can be used.

Received Signal Strength Indicator

Field strength	Red indicators			Yellow indicators			Green indicators			
	Weak			Medium			Strong			
Number of indicators lit	0	1	2	3	4	5	6	7	8	9
RUN mode	Unstable communications range					Stable communications range				
TEST mode										
Field strength monitor test	Range in which specified channel can be used.			Range in which specified channel cannot be used.						
Installation/confirmation test	Unstable communications range					Stable communications range				

The received signal strength is indicated using 10 levels. Check the communications status, referring to the field strength level.

3-5-2 Registering Communications Partners (All I/O Slave Stations)

Register I/O Slave Stations at the Serial Master Station. The Serial Master Station performs wireless communications only with those I/O Slave Stations that are registered. This prevents unwanted I/O Slave Stations from joining the network. When registering, the serial number check can also be enabled or disabled. Serial number recognition is the function that writes the I/O Slave Station's unique number to the Serial Master Station.

Scan List Registration with Serial Number Check

The serial number is registered at the same time as the corresponding I/O Slave Station. This function has the advantage of preventing mistaken Slave recognition even if a WT30 Terminal with the same channel (frequency), same node number, and same model is in the radio signal range. The disadvantage is that I/O Slave Stations that are replaced must be re-registered.

Note When the serial number check is not required, turn OFF bit 9 of the Serial Master Station's function setting switch (serial number check disabled).

I/O Slave Station Settings

1,2,3...

1. Before turning ON the power, set the function setting switch as required.



Bit 1: Hold/clear I/O data if communications errors occur
 Bit 2: Input hold/normal mode
 Bit 3: Input filter 100 ms/10 ms

2. Set the node number of the I/O Slave Station using the node setting switch.

W NODE

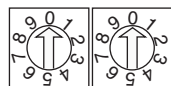

Setting range: 01 to 64

X10 X1

3. Set the same channel used by the Serial Master Station using the channel setting switch.

W CH

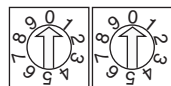

Setting range: 01 to 34, 51 to 83

X10 X1

4. Change the setting for the mode setting switch to RUN mode, and then turn ON the power.



Serial Master Station

1,2,3...

1. Before turning ON the power, set the function setting switch on the Serial Master Station as follows:



Bit 7: ON (scan list registration enabled)
 Bit 8: OFF (automatically register all I/O Slave stations)
 Bit 9: ON (serial number check enabled)

- Set the highest node number of the connected I/O Slave Stations using the node setting switch.

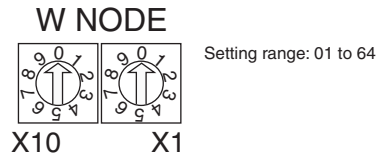

- Set the frequency channel using the channel setting switch.

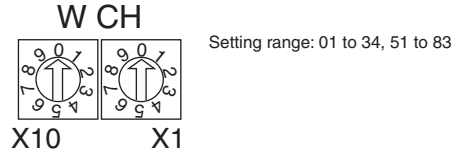

- Change the mode setting switch to SET mode, and then turn ON the power.



The scan list registration will now start. During scan list registration the WS indicator will flash green.

- The WS indicator will change from flashing green to being lit green when registration of the I/O Slave Stations (scan list registration) is completed.

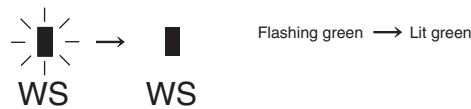

Confirm scan list registration using the RSSI. The RSSI's green indicators will flash 4 or 5 times to indicate that registration has been completed.



Note Be sure to allocate node numbers to I/O Slave Stations in sequence. If the I/O Slave Station numbers are allocated out of sequence, registration will not be completed. Registration will also not be completed under the following conditions.

- I/O Slave Stations are present for which the power is not turned ON.
- Communications are unstable and cannot be confirmed.

3-5-3 Operation Settings

Serial Master Station Settings

- 1,2,3... 1. Before turning ON the power, set the function setting switch as shown below to enable communications with the registered I/O Slave Stations.



Bit 2: ON (scan list enabled)

Note When the scan list is disabled, however, communications are performed with the number of I/O Slave Stations set using the node setting switch.

Example 1: If the node setting switch is set to 2, communications will be performed with I/O Slave Stations 01 and 02.

Example 2: If the node setting switch is set to 64, communications will be performed with I/O Slave Stations 01 to 64.

2. Change the setting for the mode setting switch to RUN mode, and then turn ON the power.



3-5-4 Confirming Connection Status

Confirm the communications status between the I/O Slave Stations and Serial Master Station using the RSSI (received signal strength indicator) display. Be sure to turn ON the power to the I/O Slave Station in RUN mode before the Serial Master Station.

I/O Slave Stations

- 1,2,3... 1. Confirm that the mode setting switch on the I/O Slave Station is set to RUN mode.



2. Confirm that the MS and WS indicators on the I/O Slave Station are lit green.

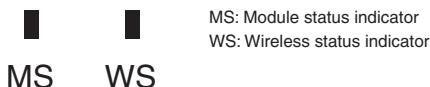

3. Check the strength of the received signal from the Serial Master Station indicated using 10 levels on the RSSI display.



Serial Master Station

- 1,2,3... 1. Confirm that the mode setting switch on the Serial Master Station is set to RUN mode.



2. Confirm that the MS and WS indicators on the Serial Master Station are lit green.

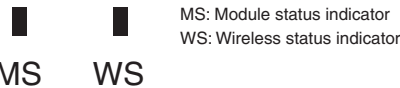

3. Specify the node number of the I/O Slave Station to be monitored on the Serial Master Station's node setting switch.

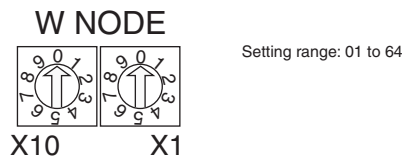

Note The Serial Master Station node number is set to the maximum number of I/O Slave Stations. When the maximum number of nodes is set to a number higher than the number of nodes connected, however, the highest node number is not used. The communications partner for this node number does not exist, so no display is shown on the RSSI. If the node number is changed to that of a node that is actually connected, the RSSI display will indicate the corresponding signal strength.

4. Check the strength of the received signal from the I/O Slave Station specified by the node setting switch. The strength is indicated using 10 levels on the RSSI display.



3-6 Function Setting Switch

The details of the function setting switch are provided below.

3-6-1 Scan List Registration

Scan list registration is used to join and register I/O Slave Stations as communications partners in the network using the Serial Slave Station. This enables communications to be performed with specified communications partners. Set the operation mode to SET mode.



Scan list registration is performed from the Serial Master Station using either of the following two registration methods.

1. Registering all I/O Slave Stations automatically
2. Registering specified I/O Slave Stations

Select to either register all I/O Slave Stations automatically by specifying the highest I/O Slave Station node number, or register specified I/O Slave Stations by specifying the I/O Slave Station node numbers individually. When registering all I/O Slave Stations at the same time, it is recommended to set the I/O Slave Station node numbers in the same frequency in sequence from node number 1 up to the number of connected nodes. Before registering, start up all the connected I/O Slave Stations in RUN mode.

Registering All I/O Slave Stations Automatically

All the I/O Slave Stations up to the highest node number are registered.



Bit 8: OFF (register all I/O Slave Stations automatically)

Registering Specified I/O Slave Stations

The I/O Slave Station for the node number specified at the Serial Master Station is registered. Set the special function switch from OFF to ON, and then OFF again.



Bit 8: ON (register specified I/O Slave Stations)

Scan List Registration with Serial Number Check Enabled

The serial number is registered at the same time as the corresponding I/O Slave Station. The serial number is the product's unique number, i.e., no two serial numbers are the same. This setting has the advantage of preventing mistaken Slave recognition even if a WT30 Terminal with the same channel (frequency), same node number, and same model is in the radio signal range. The disadvantage is that I/O Slave Stations that are replaced must be re-registered.

When the serial number check is enabled (bit 9 is ON), the I/O Slave Station's serial number is registered in the Serial Master Station.



Bit 9: ON (serial number check enabled)

Scan List Registration with Serial Number Check Disabled

The serial number is not registered when the scan list is registered. This setting has the advantage of not requiring I/O Slave Stations to be re-registered from the Serial Master Station after replacement. The disadvantage is that mistaken Slave recognition may occur if a WT30 Terminal with the same channel (frequency), same node number, and same model is in the radio signal range.

When the serial number check is disabled (bit 9 is OFF), the I/O Slave Station's serial number is not registered.



Bit 9: OFF (serial number check disabled)

3-6-2 Stopping Registration of All I/O Slave Stations

Scan list registration cannot be completed if the power is not turned ON for all the I/O Slave Stations, or the node numbers are not assigned sequentially, or if the I/O Slave Stations are not within the radio signal range. Use the following settings to stop scan list registration if required. When registration of all I/O Slave Stations is stopped, scan list details will not be written to EEPROM unless this operation is performed.

Set the special function switch as follows:

ENTER

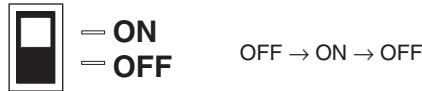

Confirm scan list registration using the RSSI display. The RSSI's green indicators will flash 4 or 5 times to indicate that the operation has been completed.

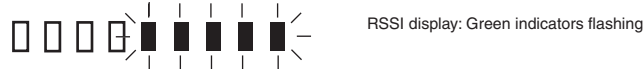

3-6-3 Scan List Enabled/Disabled Mode

The scan list enabled/disabled mode is set during RUN mode. In scan list enabled mode, communications are performed with the specified, registered communications partners. In scan list disabled mode, communications are performed without registering any communications partners.

1. Scan list registration is not required: Use scan list disabled mode
2. Scan list registration without serial number check is required: Use scan list enabled mode
3. Scan list registration with serial number check is required: Use scan list enabled mode

Scan List Disabled Mode

In scan list disabled mode, communications are performed without registering I/O Slave Stations starting from the node number 1 specified at the Serial Master Station up to the specified number of nodes. Scan list registration is not required in this mode, and I/O Slave Stations can be added and replaced using switch settings only. I/O Slave Stations are detected again, however, when a power interruption occurs at the Serial Master Station. Therefore, the Serial Master Stations cannot determine whether I/O Slave Stations have been changed (connecting a different model to the same node number). Even if only the power to the I/O Slave Station has been interrupted, a different station will not be detected.

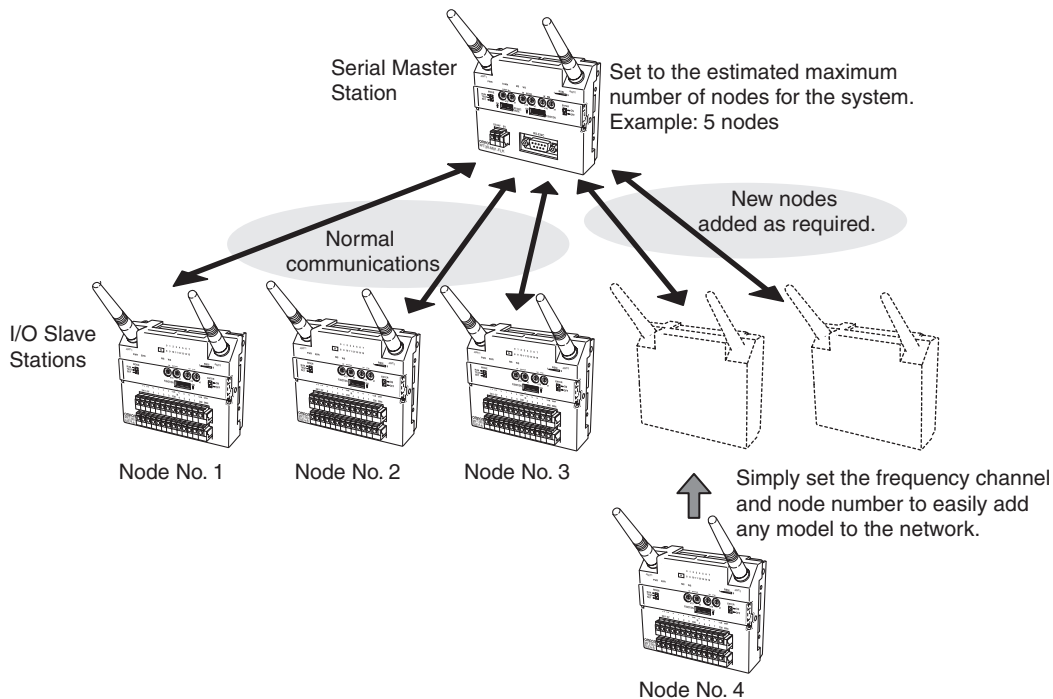

Scan List Disabled

Set the function setting switch as follows (Serial Master Station only):



Bit 2: OFF (scan list disabled)

Scan List Enabled Mode

In scan list enabled mode, the scan list must be registered. If scan list registration is performed without the serial number check, I/O Slave Stations can be replaced by simply setting the switches. Scan list registration must be performed again when an I/O Slave Station is added regardless of whether the serial number check is enabled, and also when replacing I/O Slave Stations if the serial number check is enabled. The Serial Master Station performs wireless communications only with the I/O Slave Stations registered in the scan list, preventing unwanted I/O Slave Stations from joining the network. If the serial number check is disabled, replacement of the same node number with the same model will not be detected.

Scan List Enabled

Set the function setting switch as follows (Serial Master Station only):



Bit 2: ON (scan list enabled)

3-6-4 Input Hold

In normal mode, input data is read, and sent to the Serial Master Station as is. The input data is saved according to the polling timing from the Serial Master Station. For example, after an input turns ON, if the input from the Serial Master Station turns OFF during polling, the input OFF data is transmitted to the Serial Master Station and the ON data input in the I/O Slave Station is not correctly transferred.

When the input hold is set, the ON data that has been input in the I/O Slave Station is held until it is sent to the Serial Master Station. Therefore, ON data that has been input can be sent accurately to the Serial Master Station. Up to two polling cycles are required for the input terminal status to be reflected.

Communications Timing with the Personal Computer or PLC

In normal mode, when the signal from the input terminal is shorter than one polling cycle, the ON signal may not be received by the Serial Master Station, depending on the polling timing. When the input hold is set, the ON signal is held for twice the polling cycle time. Read the data from the Serial Master Station using this timing. For details on calculating the polling cycle, refer to *Wireless Communications Delay (TWCY)* on page 100. The length is approximately $TWCY = 10 \text{ ms} \times n \text{ stations}$. Commands are sent to the Serial Master Station from the personal computer or PLC, and the response is received within 50 ms. Allow a command interval that is less than two polling cycles, as shown below.

$$(\text{Command send time} + \text{Wait time (approx. 50 ms)} + \text{Response receive time}) < \text{Two polling cycles}$$

If a small number of I/O Slave Stations is used, the polling cycle will be shortened, and the time for a response to be received after sending the command to the personal computer or PLC may be exceed two polling cycles. In the following polling cycle, the requested data will be deleted and overwritten by the next data. Determine whether communications are valid, referring to the table on the following page.

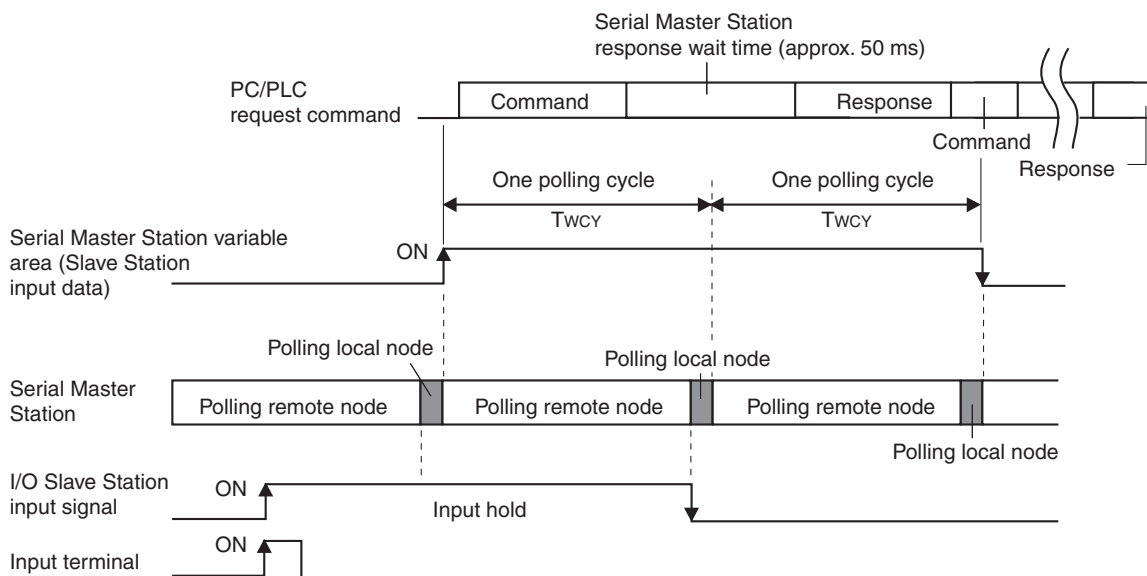

If inputs are turned ON multiple times while data is being sent to the Serial Master Station, the data will be cleared after being held for two polling cycles.

Note Polling refers to the operation in which I/O Data is sent and received for each I/O Slave Station when communications are performed between a single Serial Master Station and multiple I/O Slave Stations. The cycle time refers to the time required for communications to be completed with all I/O Slave Stations.

The following example provides an explanation for the holding time while in input hold mode (two polling cycles in the table), with a communications baud rate of 9,600 or 38,400 bps.

Command: 24 bytes

STX 00 00 0 01 01 80 0000 00 00** ETX BCC

** indicates the number of Slave Stations.

Response: 33 bytes + (4 × Number of Slave Stations)

STX 00 00 00 01 01 00 00
 0000 0000 0000 0000 ← Entry data
 0000 ← Data

ETX BCC

Transmission data length (bytes) = Command + Response

For 5 stations, 24 + 33 + (4 × 5) = 77 bytes.

The value obtained when this total value is converted using the communications baud rate is the personal compute/PLC communications time.

List of Communications Cycle Times

Number of connected Stations	1 polling cycle × 2 (ms)	Personal computer/PLC communications time	
		9,600 bps (ms)	38,400 bps (ms)
1	20	114	66
5	100	131	71
10	200	152	76
64	1280	377	132

Note The shaded area indicates the combinations for which communications are enabled.

Example 1: When 5 stations are connected, and a baud rate of 38,400 bps is used, two polling cycles are 100 ms > 71 ms (personal computer/PLC communications time). Therefore, data can be read.

If communications are performed at 9,600 bps, however, the two polling cycles will be 131 ms, and communications will not be able to be performed within the two polling cycles. Refer to the above table and consider the serial baud rate and number of connected stations when creating the program.

Normal Mode

Set the function setting switch as follows (I/O Slave Stations only):



Bit 2: OFF (normal mode)

Input Hold

Set the function setting switch as follows (I/O Slave Stations only):



Bit 2: ON (input hold)

3-6-5 Input Filter

Set the filter for I/O Slave Station input. The input filter can be set to 10 ms or 100 ms. The 10-ms filter recognizes ON inputs only when the input's contact status (ON/OFF) is held for at least 10 ms. The 100-ms filter functions in the same way.

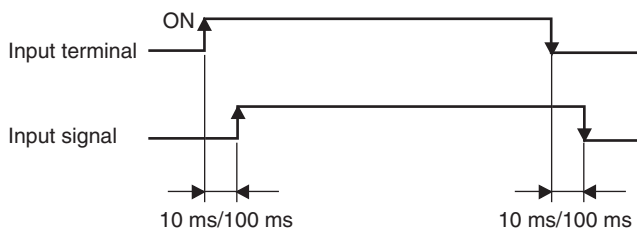

10-ms Filter

Set the function setting switch as follows (I/O Slave Stations only):



Bit 3: OFF (10-ms input filter)

100-ms Filter

Set the function setting switch as follows (I/O Slave Stations only):



Bit 3: ON (100-ms input filter)

3-6-6 Output Control for Communications Errors

Select whether to hold or clear data when a communications error occurs. This function is enabled at the Serial Master Station for the input status from the I/O Slave Station, and at the I/O Slave Stations for the output commands from the Serial Master Station.

For example, when an input of the I/O Slave Station is ON, the ON data is transmitted to the Serial Master Station provided that communications are normal. If a communications error occurs and the WT30 Terminal is set to hold I/O status data if a communications error occurs, the data held in the Serial Master Station turns ON. If the WT30 Terminal is set for data to be cleared if a communications error occurs, the data held by the Serial Master Station will be cleared to OFF.

Hold I/O Data when a Communications Error Occurs

Set the function setting switch as follows (Serial Master Station and I/O Slave Stations):



Bit 1: ON (hold I/O data when a communications error occurs)

Clear I/O Data when a Communications Error Occurs

Set the function setting switch as follows (Serial Master Station and I/O Slave Stations):



Bit 1: OFF (clear I/O data when a communications error occurs)

3-6-7 Returning to Default Settings

Use the following procedure to return to the default settings. The serial numbers and I/O sizes for I/O Slave Stations registered in the Serial Master Station (EEPROM) will be cleared.

1. Before turning ON the power, set the function setting switch as follows:



2. Set the node setting switch as follows:

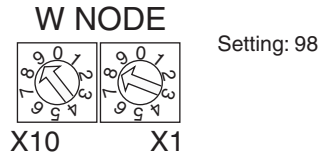

3. Change the setting for the mode setting switch to SET mode, and then turn ON the power.



4. Set the special function switch as follows:



5. Confirm that settings have returned to the default status using the RSSI display. The RSSI's green indicators will flash 4 or 5 times to indicate that the operation has been completed.



SECTION 4

Relay Function

This section describes the setting methods used to extend the communications distance.

4-1	Relay Function	60
4-1-1	Using WT30 Terminal as a Relay Station	60
4-2	Setting Flowchart	62
4-3	Using Relays	63
4-3-1	System Configuration Example	63
4-3-2	I/O Slave Station Settings	63
4-3-3	Relay Station Settings	63
4-3-4	Serial Master Station Settings	64
4-3-5	Confirming Communications	64

4-1 Relay Function

The relay function extends the communications distance using an I/O Slave Station as a Relay Station. Even if equipment is relocated, making communications between the Serial Master Station and I/O Slave Stations unstable or resulting in a disconnection, the communications path can be switched, enabling communications to continue automatically via a Relay Station.

4-1-1 Using WT30 Terminal as a Relay Station

Extending Communications Distance

When the Serial Master Station and I/O Slave Stations are separated by a long communications distance, communications with stations for which radio waves are difficult to reach can be made possible with the use of a Relay Station. I/O Slave Stations are also registered through the Relay Station. Only a single Relay Station can be used, but up to 64 I/O Slave Stations can be connected to the Relay Station.

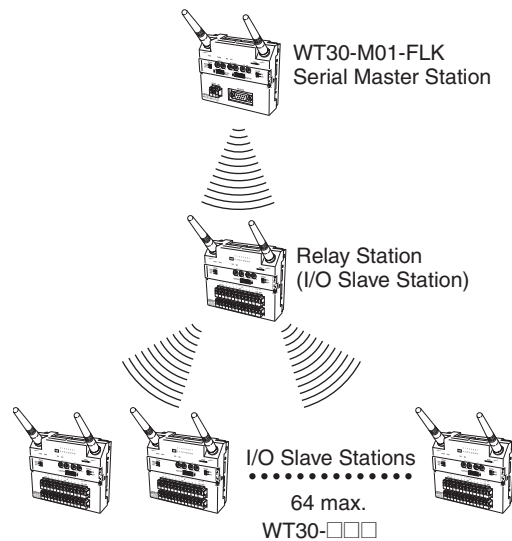

Note The I/O terminals and error output terminal settings on the I/O Slave Station being used as the Relay Station are disabled. If an I/O Slave Station is within the communications range for the Serial Master Station, communications with the Serial Master Station can be performed directly even if a Relay Station is installed. Relays are supported for only one stage, i.e., only for one Relay Station.

**Switching
Communications Path**

The communications path can be automatically switched to perform communications via a Relay Station. With this function, even if an I/O Slave Station moves out of the communications area with the Serial Master Station, communications will continue after switching the communications path.

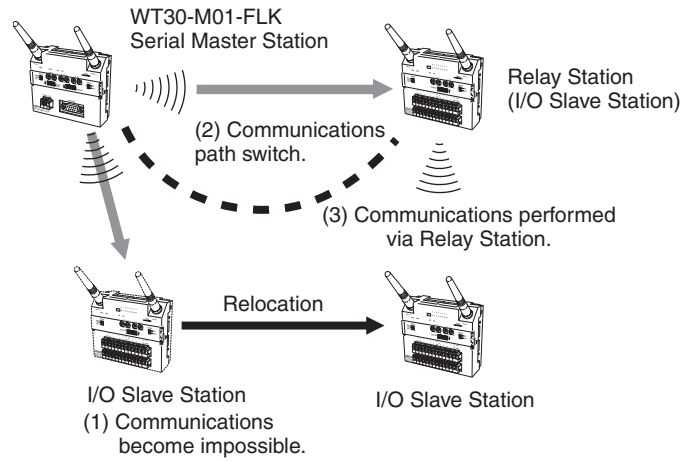

4-2 Setting Flowchart

The settings required to perform communications using the relay function are described using the following flowchart.

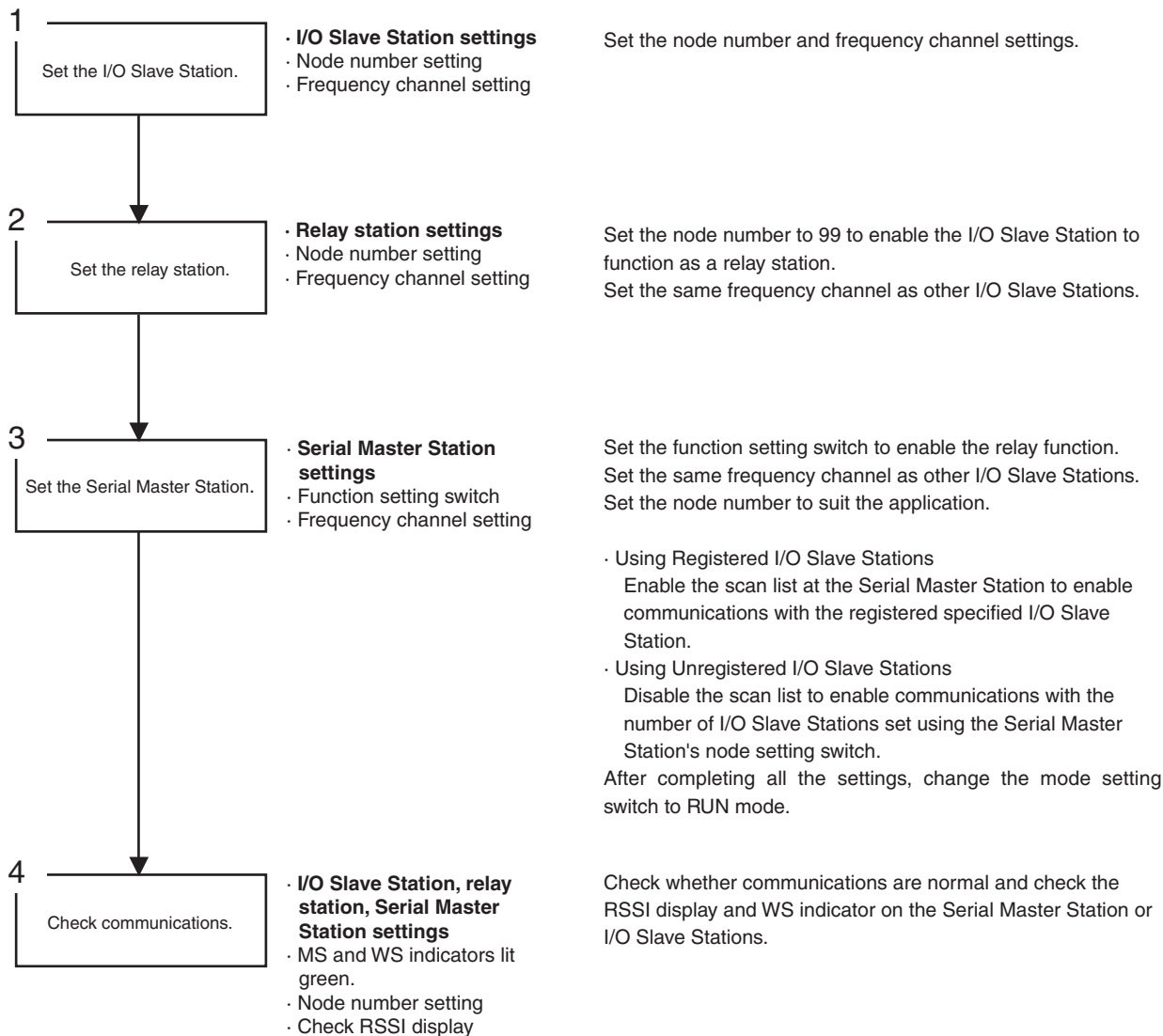

The above example shows the procedure for setting the I/O Slave Stations, followed by the Relay Station, and finally the Serial Master Station. When performing communications, turn ON the power starting from the I/O Slave Stations in the same order as settings are made. Enable the relay function for the I/O Slave Station to be used as a Relay Station by setting the corresponding WT30 Terminal's node setting switch to 99. Set bit 3 of the Serial Master Station's function setting switch to ON to enable detection of and communications with the Relay Station.

4-3 Using Relays

4-3-1 System Configuration Example

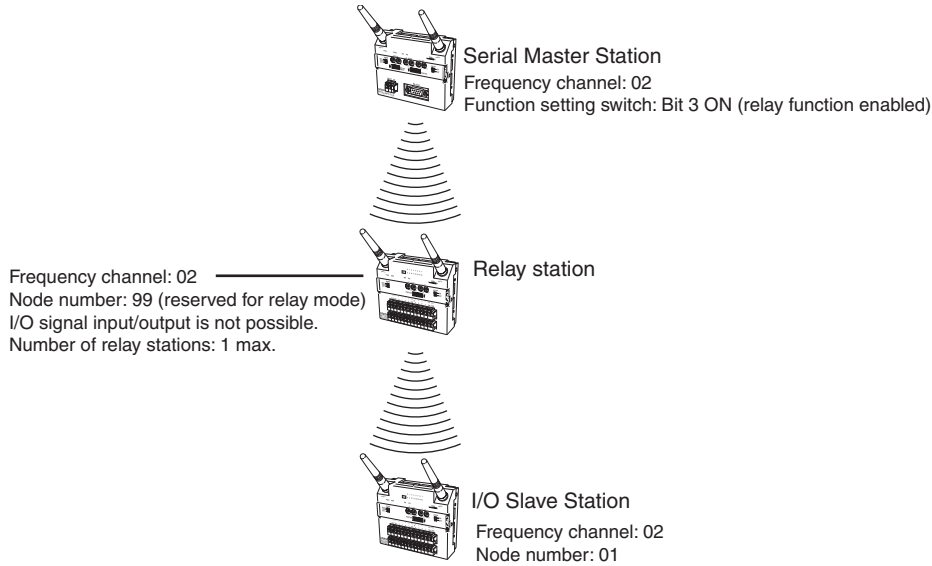

4-3-2 I/O Slave Station Settings

- 1,2,3... 1. Set the node setting switch to 01.

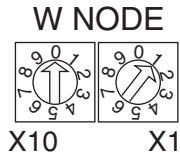

2. Set the channel setting switch. (Example: 02)

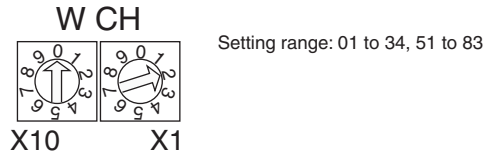

4-3-3 Relay Station Settings

- 1,2,3... 1. Set the node setting switch to 99. Setting the node number to 99 reserves the WT30 Terminal for use as a Relay Station only.

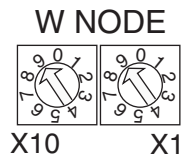

2. Set the channel setting switch. (Example: 02)

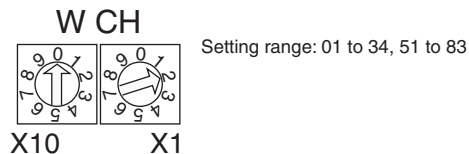

4-3-4 Serial Master Station Settings

- 1,2,3... 1. Turn ON bit 3 of the function setting switch. This setting enables the relay function.



2. Set the channel setting switch. (Example: 02)

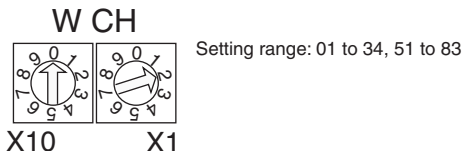

4-3-5 Confirming Communications

To check the signal strength between the Serial Master Station and Relay Station using the RSSI display, switch to RUN mode and set the node setting switch on the Serial Master Station to the I/O Slave Station functioning as the Relay Station.

The actual measurement values for the received signal strength of the frequency channel specified using the channel setting switch are monitored in real time.

- 1,2,3... 1. Change the setting of the mode setting switch to RUN mode for the I/O Slave Stations, Relay Station, and Serial Master Station, and then turn ON the power to the I/O Slave Stations, Relay Station, and Serial Master Station, in that order.



To communicate with the registered I/O Slave Stations, bit 2 of the Serial Master Station's function setting switch must be set to ON (scan list enabled).

2. Confirm that the MS and WS indicators on the I/O Slave Stations are lit green. The WS indicator on the Relay Station flashes green.

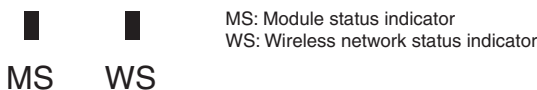

3. Set the node setting switch to 01.

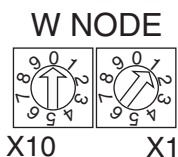

4. The monitoring results are displayed on the RSSI display in 10 levels.



Relay Function Precautions

The received signal strength of the I/O Slave Stations can be confirmed on the Serial Master Station. When a Relay Station is used, however, only the signal strength between the Serial Master and Relay Station can be monitored. To monitor the received signal strength at I/O Slave Stations connected to the Relay Station, check the RSSI display on the I/O Slave Stations.

Received Signal Strength Indicator

Field strength	Red indicators			Yellow indicators			Green indicators			
	Weak	Medium			Strong					
Number of indicators lit	0	1	2	3	4	5	6	7	8	9
RUN mode	Unstable communications range					Stable communications range				
TEST mode										
Field strength monitor test	Range in which specified channel can be used.			Range in which specified channel cannot be used.						
Installation/confirmation test	Unstable communications range					Stable communications range				

The received signal strength is indicated using 10 levels. Check the communications status, referring to the received signal strength level.

SECTION 5

Troubleshooting and Maintenance

This section describes error processing, daily inspection, and troubleshooting and maintenance procedures needed to keep the wireless network operating properly. We recommend reading through the error processing procedures before operation so that operating errors can be identified and corrected more quickly.

5-1	Troubleshooting	68
5-1-1	System Errors	68
5-1-2	Troubleshooting with Indicator Displays	70
5-2	Maintenance and Replacement	72
5-2-1	Cleaning	72
5-2-2	Inspection	72
5-2-3	Replacing Nodes.	73
5-3	Replacing WT30 Terminals	73
5-3-1	I/O Slave Station Replacement Procedure	73

5-1 Troubleshooting

Use the information provided here to identify the cause and location of errors that may occur in the WT30 Terminals and perform troubleshooting.

5-1-1 System Errors

Errors that occur in the wireless system are classified as hardware errors and wireless communications errors. WT30 Terminal hardware errors and wireless communications errors can be checked using the indicators.

Serial Master Station

MS indicator	Status	Countermeasure
Lit red	A fatal error has occurred (watchdog timer error, EEPROM error, or hardware error). Replacement of the WT30 Terminal is required.	First reset the power supply or initialize the WT30 Terminal. If the WT30 does not recover, contact your OMRON representative.
Flashing red	A non-fatal error has occurred. Illegal switch settings have been made. Recovery is possible by correcting the settings.	Check the switch settings and make sure they are correct.
	An EEPROM checksum error has occurred.	Initialize the WT30 Terminal. If it does not recover, replace the WT30 Terminal. Contact your OMRON representative for details.

WS indicator	Status	Countermeasure
Lit red	A fatal wireless communications error has occurred. A code sense error has occurred.	A WT30 or WD30 is already present on the same wireless channel. Change the frequency channel and start up the WT30 Terminal again.
Flashing red	A non-fatal wireless communications error has occurred. A verification error (I/O size mismatch) has occurred.	The I/O size for the I/O Slave Station registered in the Serial Master Station is different from the I/O size of the I/O Slave Station performing communications. Refer to <i>5-3 Replacing WT30 Terminals</i> on page 73 and either re-register the I/O Slave Station to perform communications or change the I/O Slave Station model (change from 16 inputs to 8 inputs/8 outputs or from 8 inputs/8 outputs to 16 inputs).

I/O Slave Stations

MS indicator	Status	Countermeasure
Lit red	A fatal error has occurred (watchdog timer error, EEPROM error, or hardware error). Replacement of the WT30 Terminal is required.	First reset the power supply or initialize the WT30 Terminal. If it does not recover, contact your OMRON representative.
Flashing red	A non-fatal error has occurred. Illegal switch settings have been made. Recovery is possible by correcting the settings.	Check the switch settings and make sure they are correct.
	An EEPROM checksum error has occurred.	Initialize the WT30 Terminal. If it does not recover, replace the WT30 Terminal. Contact your OMRON representative for details.

WS indicator	Status	Countermeasure
Lit red	A fatal wireless communications error has occurred. Duplicate wireless node numbers have been detected.	Another I/O Slave Station with the same frequency channel and node number settings may be present. Check whether an I/O Slave Station with the same frequency channel and node number settings is within the radio wave range. If an I/O Slave Station with duplicate settings is found, change the frequency channel and node number setting and then restart the system. If the system does not recover, reset the affected I/O Slave Station to a frequency without interference.
Flashing red	A non-fatal wireless communications error has occurred. A disconnection has occurred, a communications timeout, or a verification error (I/O size mismatch) has occurred.	If the RSSI display is not lit, this indicates a disconnection. Change the frequency channel and relocate the WT30 Terminal to a position in which stable wireless communications are possible. If the RSSI display is lit, this indicates an I/O size mismatch error. Re-register the I/O Slave Station from the Serial Master Station.

5-1-2 Troubleshooting with Indicator Displays

The status of the MS and WS indicators depends on the communications status, as follows:

MS and WS Indicators

The MS (Module Status) indicator shows the status of the local node. The WS (Wireless Status) indicator shows the status of the wireless system. During normal operation these two indicators are lit green on both the Serial Master Station and the I/O Slave Stations.

Serial Master Station Indicators



Indicator	Color	Status	Meaning (primary error)
(1) PWR	Green	Lit	Power is being supplied.
		Not lit	Power is not being supplied.
(2) COMM	Yellow	Lit	Serial communications in progress.
		Not lit	No serial communications.
(3) MS (Module Status)	Red	Lit	A fatal error has occurred that cannot be recovered from, such as a watchdog timer error, EEPROM, or hardware error. Replace the WT30 Terminal.
		Flashing	A non-fatal error, illegal switch settings, or EEPROM checksum error has occurred that can be recovered from by resetting the system.
	Green	Lit	Communications are normal.
		Flashing	TEST mode or SET mode has been activated.
	---	Not lit	Power is not being supplied or the system is resetting.
(4) WS (Wireless Status)	Red	Lit	A fatal wireless communications error or code sense error has occurred.
		Flashing	A non-fatal wireless communications error or verification error (slave I/O size mismatch) has occurred, or the slave is not registered.
	Green	Lit	RUN mode: Connection to wireless communications is completed or remote I/O communications are in progress. SET mode: Scan list creation completed.
		Flashing	RUN mode: There is no wireless communications connection or there are no slaves participating in remote I/O communications. TEST mode: The received signal strength is being monitored. SET mode: Scan list is being created.
	---	Not lit	Wireless communications are not in progress.
(5) RSSI (Received Signal Strength Indicator)	Red/yellow/green	0 to 9 lit	Displays the received signal strength in 10 levels. The field strength is determined by the number of indicators lit: weak for a small number and strong for a large number.
	Green	Flashing	Special function operation has completed.

I/O Slave Station Indicators

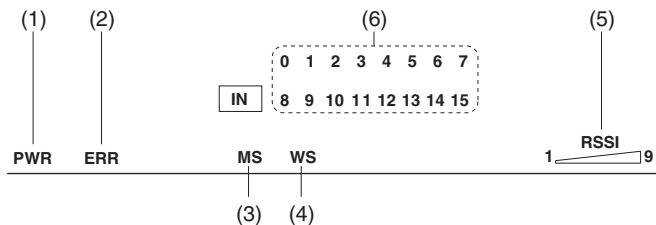

Indicator	Color	Status	Meaning (primary error)
(1) PWR	Green	Lit	Power is being supplied.
		Not lit	Power is not being supplied.
(2) ERR	Yellow	Lit	Error output is ON: Wireless device error, wireless communications error, or host network error has occurred preventing normal I/O communications.
		Not lit	Error output is OFF: Causes of the above conditions have been removed.
(3) MS (Module Status)	Red	Lit	A fatal error has occurred that cannot be recovered from, such as a watchdog timer error, EEPROM error, or hardware error. Replace the WT30 Terminal.
		Flashing	A non-fatal error, illegal switch settings, or EEPROM checksum error has occurred that can be recovered from by resetting the system.
	Green	Lit	Communications are normal.
		Flashing	TEST mode or SET mode has been activated.
---	Not lit	Power is not being supplied or the system is resetting.	
(4) WS (Wireless Status)	Red	Lit	A fatal wireless communications error has occurred, or duplicate wireless node addresses have been set.
		Flashing	A non-fatal communications error, disconnection, or communications timeout has occurred.
	Green	Lit	RUN mode: Connection to wireless communications is completed.
		Flashing	RUN mode: Wireless communications not connected. TEST mode: Received signal strength monitoring in progress.
---	Not lit	No wireless communications	
(5) RSSI (Received Signal Strength Indicator)	Red/yellow/green	0 to 9 lit	Displays the received signal strength in 10 levels. The field strength is determined by the number of indicators lit: weak for a small number and strong for a large number.
		Green	Flashing
(6) 0 to 15	Yellow	Lit/not lit	Input or output signal ON/OFF status (0 to 7, 8 to 15)

5-2 Maintenance and Replacement

This section describes the routine cleaning and inspection required and the equipment handling procedure required for replacement.

5-2-1 Cleaning

Clean the devices in the network regularly as described below in order to keep the network in its optimal operating condition.

- Wipe the WT30 Terminal daily with a dry, soft cloth.
- When a spot cannot be removed with a dry cloth, dampen the cloth with a neutral cleanser (diluted to 2%), wring out the cloth, and wipe the WT30 Terminal.
- A smudge may remain on the WT30 Terminal from gum, vinyl, or tape that was left on for a long time. Remove the smudge when cleaning.

 **Caution** Never use volatile solvents such as paint thinner, benzene, or chemical wipes. These substances could damage the surface of the WT30 Terminal.

5-2-2 Inspection

Be sure to inspect the system periodically to keep it in its optimal operating condition. In general, inspect the system once every 6 to 12 months, but inspect more frequently if the system is used at high temperatures or humidity or under dirty/dusty conditions.

Inspection Equipment

Prepare the following equipment before inspecting the system.

Required Equipment

- Standard and Phillips screwdrivers
- Multimeter (or digital volt meter)
- Alcohol and all-cotton cloth

Equipment Required Occasionally

- Synchroscope
- Thermometer, hygrometer

Inspection Procedure

Check the items in the following table to make sure that the WT30 Terminal meets the standard.

If the WT30 Terminal does not meet the required standards, improve the surrounding environment so that the standards are met or adjust the WT30 Terminal.

Item	Inspection details	Standard	Inspection method
Environmental conditions	Ambient and in-panel temperature	See below.	Thermometer
	Ambient and in-panel humidity	See below.	Hygrometer
	Dust/dirt accumulation	None	Visual
Installation	Are the WT30 Terminals installed securely?	No looseness	Tighten screws
	Are the communications cables securely connected?	No looseness	Tighten screws
	Is the antenna tightened?	No looseness	Tighten antenna
Power supply voltage	Is the voltage within 20.4 to 26.4 VDC	Within rated voltage range	Multimeter

Ambient Operating Temperature and Humidity Ranges for each WT30 Terminal

WT30 Terminal	Acceptable temperature	Acceptable humidity
Serial Master Station	-10 to 55°C	25% to 85% (with no condensation or icing)
I/O Slave Station	-10 to 55°C	25% to 85% (with no condensation or icing)

5-2-3 Replacing Nodes

Replacement Precautions

Observe the following precautions when replacing a WT30 Terminal found to be faulty during inspection or by other means.

- After replacement make sure there are no errors with the new WT30 Terminal.
- When a WT30 Terminal is being returned for repair, attach a sheet of paper detailing the problem and return the WT30 Terminal to your OMRON representative.
- If there is a faulty contact, try wiping the contact with a clean, all-cotton cloth dampened with alcohol.

⚠ Caution To prevent electric shock when replacing a WT30 Terminal, be sure to turn OFF the power supplies before removing the faulty WT30 Terminal.

5-3 Replacing WT30 Terminals

The procedure for replacing I/O Slave Stations registered in the scan list is explained here. When replacing I/O Slave Stations that are not registered in the scan list, registration at the Serial Master Station is not required. Before replacing the I/O Slave Station, set the node number, frequency channel, and function setting switch. Then, either cycle the Serial Master Station power or change the mode setting switch.

5-3-1 I/O Slave Station Replacement Procedure

I/O Slave Station Settings

- 1,2,3... 1. Before turning ON the power, set the function setting switch to the same setting used before replacement.



Bit 1: Hold/clear I/O data if communications errors occur
 Bit 2: Input hold/normal mode
 Bit 3: Input filter (100 ms/10 ms)

2. Set the node number of the I/O Slave Station using the node setting switch.

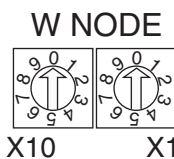

Setting range: 01 to 64

3. Set the frequency channel using the channel setting switch.

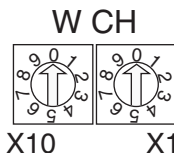

Setting range: 01 to 34, 51 to 83

4. Change the setting for the mode setting switch to RUN mode, and then turn ON the power.



Serial Master Station Settings

When the I/O Slave Station being set is registered in the Serial Master Station (scan list registration), the I/O Slave Station must be re-registered in the Serial Master Station after replacement, regardless of whether the serial number check is enabled or disabled. Re-registration is not required, however, if the serial number check is disabled and the model is the same as that being replaced. To automatically register all I/O Slave Stations, turn OFF bit 8 of the function setting switch (automatically register all I/O Slave Stations).

1,2,3...

1. Before turning ON the power, set the function setting switch on the Serial Master Station as follows:



Bit 7: ON (register scan list enabled)
 Bit 8: ON (register specified I/O Slave Station)
 Bit 9: ON (serial number check enabled)

2. Set the node number of the I/O Slave Station to be connected using the node setting switch.

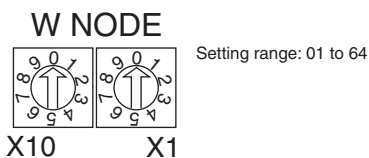

3. Set the frequency channel using the channel setting switch.

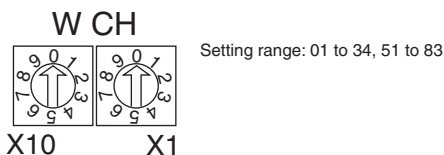

4. Change the mode setting switch to SET mode, and then turn ON the power.



5. Set the special function switch as follows:



6. The WS indicator will change from flashing green to being lit green when scan list registration is completed.



7. Change the mode setting switch to RUN mode.



SECTION 6

CompoWay/F

This section describes the CompoWay/F communications format and the variables that store the ON/OFF data and received signal strength readings.

6-1	Frame Structure	76
6-1-1	Command Frame Structure	76
6-1-2	List of Services	76
6-1-3	Response Frame	77
6-2	List of Response Codes	78
6-3	Detailed Description of the Services	78
6-3-1	Read Variable Area (0101)	78
6-3-2	Write Variable Area (0102)	80
6-3-3	Read Controller Data (0501)	82
6-3-4	Read Machine Attributes (0503)	83
6-3-5	Read Controller Status (0601)	83
6-3-6	Echoback Test (0801)	84
6-3-7	Operation Commands (3005)	85
6-4	Variable Area (Setting Range) List	86
6-5	Slave Station Entry Status	88
6-6	Slave Station Input Data	89
6-7	Slave Station Status	90
6-8	Number of Communications Errors	91
6-9	Slave Station Route Information	91
6-10	Slave Station Output Data	92
6-11	Slave Station I/O Size	92
6-12	Serial Number Registration Status	93
6-13	CompoWay/F Communications	93

6-1 Frame Structure

CompoWay/F is used as the communications protocol. Command frames are sent to the WT30 from the host, these commands are processed by the WT30, and response frames are returned to the host.

6-1-1 Command Frame Structure

Addresses, response codes, and end codes are all expressed in hexadecimal. If a value is followed by H (e.g., 02H), the value is a hexadecimal number. Values expressed as normal numerical values are in ASCII. The values under the frame are the numbers of bytes.

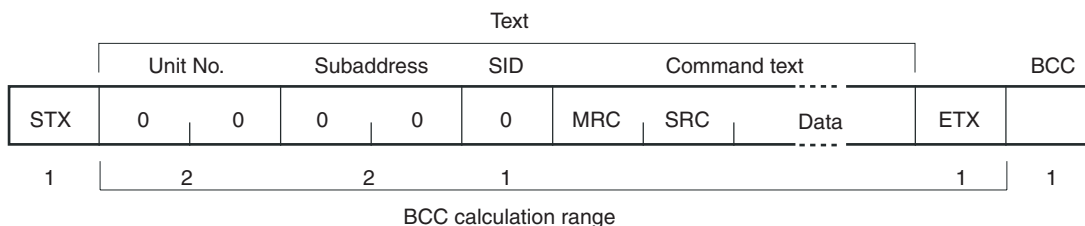

STX	A code, 02 hex, indicating the beginning of a communications frame (text). This code must always be set as the first byte. When STX is received again during reception, reception is executed again from the point where STX was received.			
Unit No.	Identifies the unit number (UNIT No.) of the Serial Master Station. <ul style="list-style-type: none"> • A BCD value between 00 to 99 can be set. • No response will be returned for stations with unit numbers outside the above range. 			
Subaddress	Always set to 00.			
SID (Service ID)	Always set to 0.			
Command text	Application layer (service request/response PDU).			
	<table border="1"> <tr> <td>MRC</td> <td>Indicates the main request code. Refer to 6-1-2 List of Services on page 76.</td> </tr> <tr> <td>SRC</td> <td>Indicates the sub request code. Refer to 6-1-2 List of Services on page 76.</td> </tr> </table>	MRC	Indicates the main request code. Refer to 6-1-2 List of Services on page 76.	SRC
MRC	Indicates the main request code. Refer to 6-1-2 List of Services on page 76.			
SRC	Indicates the sub request code. Refer to 6-1-2 List of Services on page 76.			
ETX	A code, 03 hex, indicating the end of text.			
BCC	The block check character. The value is an exclusive OR of all data from the unit number to the ETX for each byte.			

6-1-2 List of Services

MRC	SRC	Name of service	Processing
01	01	Read Variable Area	This service reads from variable areas.
01	02	Write Variable Area	This service writes to variable areas.
05	01	Read Controller Data	This service reads the model number and version codes.
05	03	Read Machine Attributes	This service reads the model number and communications buffer size.
06	01	Read Controller Status	This service reads the operating status.
08	01	Echoback Test	This service performs an echoback test.
30	05	Operation Commands	This service performs operations such as software resets.

No services will be accepted and no responses will not be returned while the WT30 is in initial status (status until initialization is finished) or if a memory error (RAM error) has occurred.

BCC Calculation Example

The BCC (Block Check Character) is determined by calculating the exclusive OR of the individual bytes from the node number up to ETX. The 8-bit result is written to the BCC byte at the end of the frame.

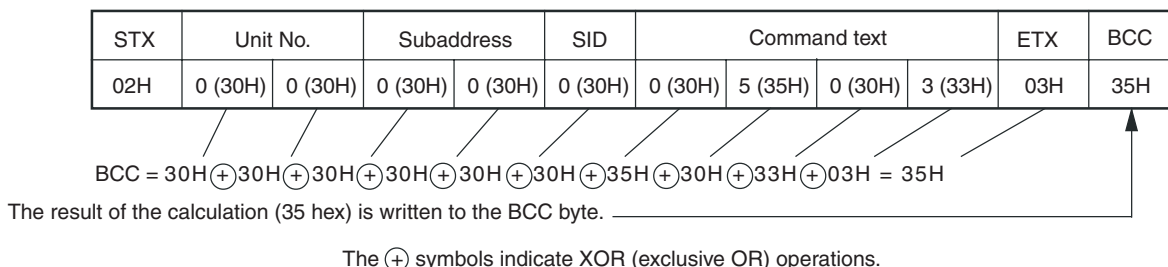

6-1-3 Response Frame

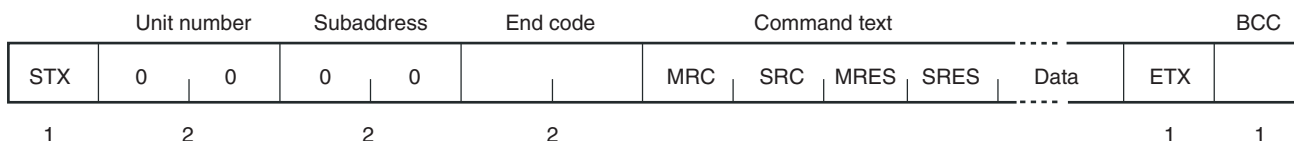

End code (hex)	Name	Description	Error detection priority
00	Normal completion	The command ended normally without error.	None
0F	FINS command error	The specified FINS command could not be executed. The FINS response code should indicate why the command could not be executed.	8
10	Parity error	The sum total of bits whose received data is "1" does not match the set value of the "communications parity" bit.	2
11	Framing error	Stop bit is "0."	1
12	Overrun error	An attempt was made to transfer new data when the reception data buffer was already full.	3
13	BCC error	The calculated BCC value is different from the received BCC value.	5
14	Format error	<ul style="list-style-type: none"> • The command text contains characters other than 0 to 9, and A to F. This error does not apply to Echoback Tests. (Refer to 6-3-6 Echoback Test (0801) on page 84 for details.) • There was no SID and command text. There was no command text. • "MRC/SRC" not included in command text. 	7
16	Subaddress error	Illegal (unsupported) subaddress. Set the command code to "00."	6
18	Frame length error	The received frame exceeds the specified (supported) number of bytes.	4

- An end code is returned for each command frame received that was addressed to the local node.
- No response will be returned unless the frame contained all elements up to the ETX and BCC.

- The “Error Detection Priority” indicates the priority when two or more errors occur simultaneously.

Command text	Response layer (service request/response PDU)	
	MRC	The main request code. Refer to 6-1-2 List of Services on page 76.
	SRC	The sub-request code. Refer to 6-1-2 List of Services on page 76.
	MRES	The main response code. Refer to 6-2 List of Response Codes on page 78.
	SRES	The sub-response code. Refer to 6-2 List of Response Codes on page 78.

6-2 List of Response Codes

Response code (hex)	Name	Description	Error detection priority
0000	Normal completion	No errors were found.	None
0401	Unsupported command	The service function for the relevant command is not supported.	1
1001	Command too long	The command is too long.	2
1002	Command too short	The command is too short.	3
1101	Area type error	The variable type is wrong.	4
1103	Start address out-of-range error	The read/write start address is out of range.	5
1104	End address out-of-range error	• The write end address (write start address + number of elements) exceeds the end address of the variable area.	6
1003	Number of elements/data mismatch	The number of data does not match the number of elements.	7
110B	Response too long	The response exceeds the communications buffer size (when the number of elements is larger than 0044).	8
1100	Parameter error	• Bit position is not “00.” • The write data is out of the setting range. • The command code and related information for the operation command are incorrect.	9
3003	Read-only error	Variable type “80” “82” was written to.	10
2203	Operation error	• Operation cannot be executed for the request/command. The service cannot be executed in the present mode. • EEPROM error	11

6-3 Detailed Description of the Services

6-3-1 Read Variable Area (0101)

This service reads data from a variable area.

Service Request PDU

MRC	SRC	Variable type	Read start address	Bit position	Number of elements
0 1	0 1			0 0	
2	2	2	4	2	4

Service Response PDU

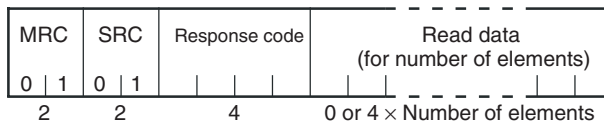

Variable Type and Read Start Address

For details on variable types and read start addresses, see 6-4 Variable Area (Setting Range) List on page 86.

Bit Position

The WT30 does not support bit access. Fixed to “00.”

Number of Elements

Number of elements	Processing
0000	The read operation is not performed (read data is not appended to the service response PDU), and processing ends in “normal completion.”
0001 to 0044	The read operation is performed, and processing ends in “normal completion.”

Note If the read start address is within the variable area, but the read end address (read start address + number of elements) exceeds the end address of the variable area, reading will be completed normally, provided that the number of data is within the specified range for the number of elements. Refer to the following information.

- When the end address is specified as the read start address for two data elements, only the end address will be read (variable type 80 in this example).

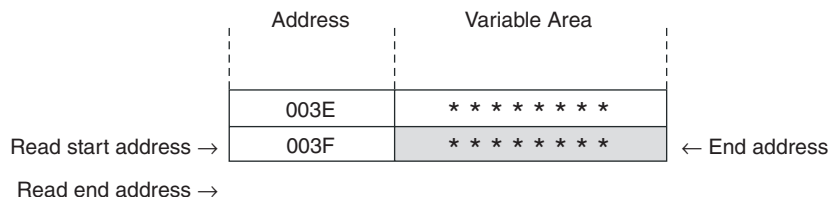

Response Code

Response code (hex)	Error name	Cause
1001	Command too long	The command is too long.
1002	Command too short	The command is too short.
1101	Area type error	The variable type is wrong.
1103	Start address out-of-range error	The read start address is out of range.
110B	Response too long	The response exceeds the communications buffer size. • The number of elements is larger than 0044.
1100	Parameter error	Other parameter error has occurred. • Bit position is not “00.”

Response code (hex)	Error name	Cause
2203	Operation error	Operation cannot be executed for the request/command. The service cannot be executed in the present mode. • EEPROM error
0000	Normal completion	No errors were found.

6-3-2 Write Variable Area (0102)

This service writes data to a variable area.

Service Request PDU

MRC	SRC	Variable type	Start write address	Bit position	Number of elements	Write Data (for number of elements)
0 1	0 2			0 0		
2	2	2	4	2	4	0 or 4 × Number of elements

Service Response PDU

MRC	SRC	Response code
0 1	0 2	
2	2	4

Variable Type and Write Start Address

For details on variable types and write start addresses, refer to *6-4 Variable Area (Setting Range) List* on page 86.

Bit Position

The WT30 does not support bit access. Fixed to "00."

Number of Elements

Number of elements	Processing
0000	The write operation is not performed (do not append write data to the service request PDU) and processing ends in "normal completion."
0001 to 0044	The write operation is performed and processing ends in "normal completion."

Response Code

Response code	Name	Description
1002	Command too short	The command is too short.
1101	Area type error	The variable type is wrong.
1103	Start address out-of-range error	Write start address is out of range.
1104	End address out-of-range error	The write end address (write start address + number of elements) exceeds the end address of the variable area.
1003	Number of elements/data mismatch	The number of data does not match the number of elements.

Response code	Name	Description
1100	Parameter error	Other parameter error. <ul style="list-style-type: none"> • Bit position is not "00." • The write data is out of the setting range.
3003	Read-only error	Attempted to write to a read-only parameter.
2203	Operation error	Operation cannot be executed for the request/command. The service cannot be executed in the present mode.
0000	Normal completion	No errors were found.

- Note**
- (1) A command too long error will not occur for the Write Variable Area service. If the data exists for the specified number of elements in the service request PDU, a number of elements/data mismatch error will occur instead.
 - (2) The specified range for the number of elements is checked when the end address range exceeded error and number of elements/data mismatch error are checked. Refer to the following information.

End Address Range Exceeded Error

This error occurs under the following conditions.

- The end address is specified for the write start address setting, so an error will occur if there are two or more data elements (variable type 81 in this example).

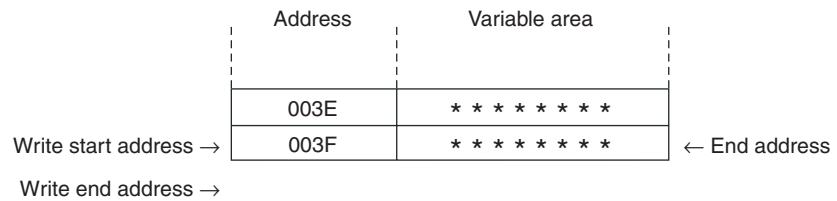

Number of Elements/Data Mismatch Error

The number of elements/data mismatch error will occur as follows (variable type 81 in this example).

- The number of elements is 2, and the number of write data is 3, so both are within the specified range, but the number of elements and number of data do not match.

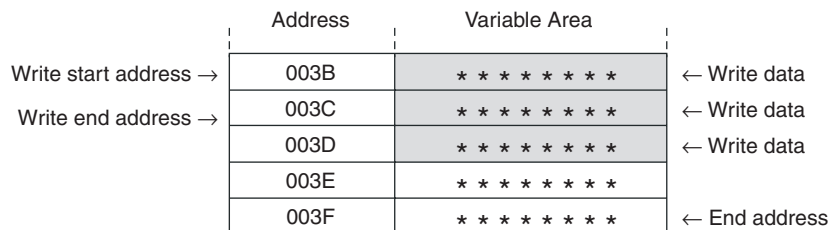

- The number of elements is 2 and the write data is 1, so both are within the specified range, but the number of elements and number of data do not match.

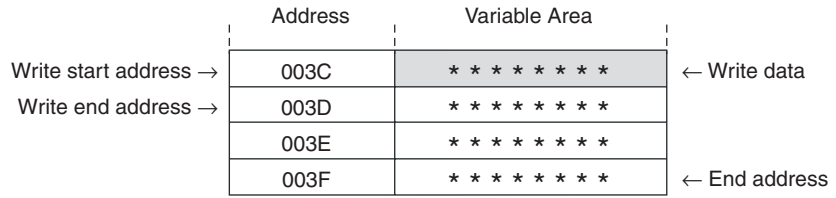

Note If the number of elements is two and either of the two write data exceed the specified range, writing will begin from the start address and a parameter error will occur from the point where the setting range is exceeded.

6-3-3 Read Controller Data (0501)

This service reads the model number and version code.

Service Request PDU

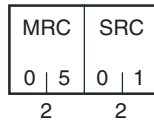

Service Response PDU

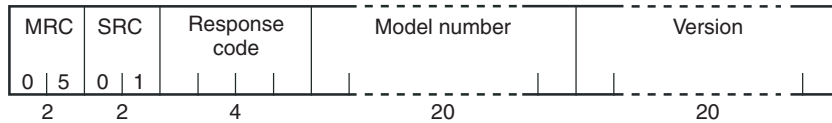

Model Number

The model number is expressed in 20-byte ASCII.

Model	Type	Interface
WT30-M01-FLK	Serial Master Station	RS-232C

Version

The version code is expressed in 20-byte ASCII.

Response Code

Response code (hex)	Name	Description
1001	Command too long	The command is too long.
2203	Operation error	EEPROM error
0000	Normal completion	No errors were found.

6-3-4 Read Machine Attributes (0503)

This service reads the model number and communications buffer size.

Service Request PDU

MRC	SRC
0 5	0 3
2	2

Service Response PDU

MRC	SRC	Response code	Model number	Buffer size
0 5	0 3			0 1 2 1
2	2	4	10	4

Model Number

The model number is expressed in 10-byte ASCII.

Model	Type	Interface
WT30-M01-FLK	Serial Master Station	RS-232C

Buffer Size

The communications buffer size is expressed in 2-byte hexadecimal and then converted to 4-byte ASCII. The command that requires the largest buffer size is the Read Variable Area service request PDU, using 289 bytes. Therefore, the buffer size is 289 bytes (= 0121H). (The buffer size indicates the response data size when reading for 68 elements using Read Variable Area.)

Response Code

Response code (hex)	Name	Description
1001	Command too long	The command is too long.
2203	Operation error	EEPROM error
0000	Normal completion	No errors were found.

6-3-5 Read Controller Status (0601)

This service reads the operating status and error status.

Service Request PDU

MRC	SRC
0 6	0 1
2	2

Service Response PDU

MRC	SRC	Response code	Operating status	Related information
0 6	0 1			
2	2	4	2	2

Operating Status

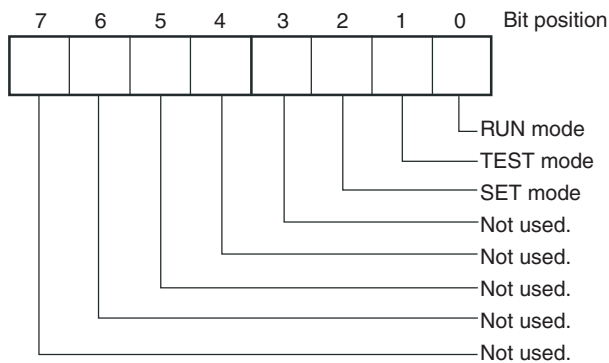

Related Information

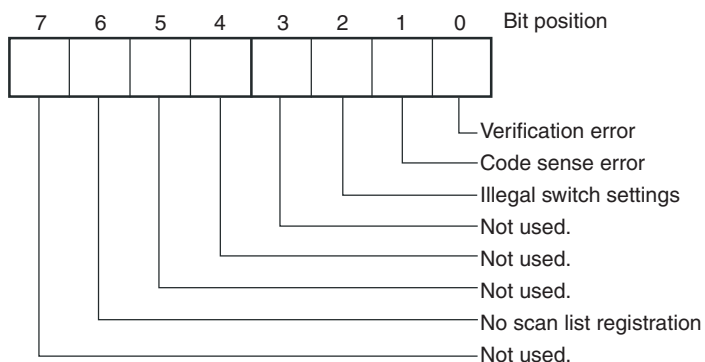

Response Code

Response code (hex)	Name	Description
1001	Command too long	The command is too long.
2203	Operation error	EEPROM error
0000	Normal completion	No errors were found.

6-3-6 Echoback Test (0801)

Performs an echoback test.

Service Request PDU

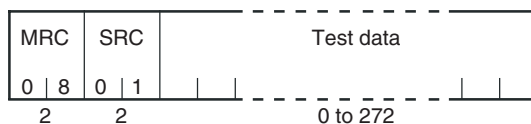

Service Response PDU

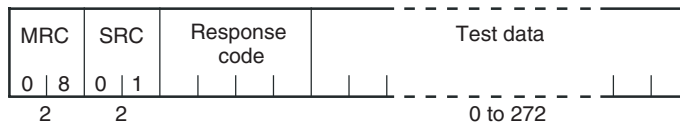

(1) Test Data

Set between 0 and 272 bytes of test data (communications buffer holds up to 289 bytes of test data) within the following ranges according to the communications data length setting.

Data length	Test data
8 bits	ASCII code 20H to 7EH, A1H to FEH
7 bits	ASCII code 20H to 7EH

(2) Response Code

Response code (hex)	Name	Description
1001	Command length too long	The command is too long.
2203	Operation error	EEPROM error
0000	Normal end	No errors were found.

6-3-7 Operation Commands (3005)

This service is used to execute operation commands.

Service Request PDU

MRC	SRC	Operation code	Related information
3 0	0 5		
2	2	2	2

Service Response PDU

MRC	SRC	Response code
3 0	0 5	
2	2	4

(1) Operation Code and Related Information

Operation code	Description	Related information
06	Software reset	00

Note There is no response (i.e., service response PDU) for a software reset.

Response Code

Response code (hex)	Name	Description
1001	Command too long	The command is too long.
1002	Command too short	The command is too short.
1100	Parameter error	The operation code or related information is not correct.
2203	Operation error	<ul style="list-style-type: none"> Unable to execute command. Refer to (3) <i>Explanation and Precautions</i> below for details. EEPROM error
0000	Normal completion	No errors were found.

(3) Explanation and Precautions**Software Reset**

Processing is restarted from the reset routine when the power is turned ON. There is no response (i.e., no service response PDU) for a software reset only. Responses are returned for all other operation codes.

6-4 Variable Area (Setting Range) List

The following table lists the variable areas. Items expressed in hexadecimal in the *Set (monitor) value* column are the setting ranges for CompoWay/F communications. When there is a section reference for a parameter setting, refer to that reference for details.

Variable type (hex)	Address (hex)	Parameter name	Set (monitor) value						
80	0000	Slave Station entry status (unit numbers 1 to 16)	0000H to FFFFH (Refer to 6-5 <i>Slave Station Entry Status</i> .)						
	0001	Slave Station entry status (unit numbers 17 to 32)							
	0002	Slave Station entry status (unit numbers 33 to 48)							
	0003	Slave Station entry status (unit numbers 49 to 64)							
80	0004	Slave Station input data (unit number 1)	0000H to FFFFH (Refer to 6-6 <i>Slave Station Input Data</i> on page 89.)						
	0005	Slave Station input data (unit number 2)							
	0006	Slave Station input data (unit number 3)							
	to	to							
	0043	Slave Station input data (unit number 64)							
80	0044	Slave Station status (unit number 1)	0000H to FFFFH (Refer to 6-7 <i>Slave Station Status</i> on page 90.)						
	0045	Slave Station status (unit number 2)							
	0046	Slave Station status (unit number 3)							
	to	to							
	0083	Slave Station status (unit number 64)							
80	0084	Communications error (unit number 1)	0000H to FFFFH (Refer to 6-8 <i>Number of Communications Errors</i> on page 91.)						
	0085	Communications error (unit number 2)							
	0086	Communications error (unit number 3)							
	to	to							
	00C3	Communications error (unit number 64)							
80	00C4	Received signal strength (unit number 1)	0000H to 09FFH Reads the received signal strength during operation for each I/O Slave Station.						
	00C5	Received signal strength (unit number 2)							
	00C6	Received signal strength (unit number 3)							
	to	to							
	0103	Received signal strength (unit number 64)							
			<table border="1"> <thead> <tr> <th>Data</th> <th>Description</th> </tr> </thead> <tbody> <tr> <td>Lower byte</td> <td>Received signal strength details. Uses 256 levels from 00H to FF.</td> </tr> <tr> <td>Upper byte</td> <td>RSSI display level. Uses 10 levels from 00H to 09H.</td> </tr> </tbody> </table>	Data	Description	Lower byte	Received signal strength details. Uses 256 levels from 00H to FF.	Upper byte	RSSI display level. Uses 10 levels from 00H to 09H.
Data	Description								
Lower byte	Received signal strength details. Uses 256 levels from 00H to FF.								
Upper byte	RSSI display level. Uses 10 levels from 00H to 09H.								
80	0104	Frequency presently in use	0001H to 0053H (Indicates the frequency currently being used.)						

Variable type (hex)	Address (hex)	Parameter name	Set (monitor) value
80	0105	Cycle time between WT30 Terminals	0000H to FFFFH (Data range displayed in 1-ms units.)
80	0106	Slave Station route information (unit number 1 to 16)	0000H to FFFFH (Refer to 6-9 Slave Station Route Information on page 91.)
	0107	Slave Station route information (unit number 17 to 32)	
	0108	Slave Station route information (unit number 33 to 48)	
	0109	Slave Station route information (unit number 49 to 64)	
81	0000	Slave Station output data (unit number 1)	0000H to FFFFH (Refer to 6-10 Slave Station Output Data on page 92.)
	0001	Slave Station output data (unit number 2)	
	0002	Slave Station output data (unit number 3)	
	to	to	
	003F	Slave Station output data (unit number 64)	
82	0000	Slave Station I/O size (unit number 1)	0000H to FFFFH (Refer to 6-11 Slave Station I/O Size on page 92.)
	0001	Slave Station I/O size (unit number 2)	
	0002	Slave Station I/O size (unit number 3)	
	to	to	
	003F	Slave Station I/O size (unit number 64)	
82	0040	Received signal strength monitor (unit number 1)	0000H to 09FFH Reads the monitored data for the received signal strength monitor when automatically switching among all channels. Data will be given in 10 levels from 0000H to 09FFH.
	0041	Received signal strength monitor (unit number 2)	
	0042	Received signal strength monitor (unit number 3)	
	to	to	
	0061	Received signal strength monitor (unit number 34)	
	0062	Received signal strength monitor (unit number 51)	
	to	to	
	0082	Received signal strength monitor (unit number 83)	
82	0083	Serial number registration status (unit numbers 1 to 16)	0000H to FFFFH (Refer to 6-12 Serial Number Registration Status on page 93.)
	0084	Serial number registration status (unit numbers 17 to 32)	
	0085	Serial number registration status (unit numbers 33 to 48)	
	0086	Serial number registration status (unit numbers 49 to 64)	

Data	Description
Lower byte	Detailed received signal strength. Uses 256 levels from 00H to FF.
Upper byte	RSSI display level. Uses 10 levels from 00H to 09H.

Variable type (hex)	Address (hex)	Parameter name	Set (monitor) value
83	0000	Number of retries (unit number 1)	0000H to 000FH Set the number of retries until an I/O Slave Station disconnection is determined (default: 3 times).
	0001	Number of retries (unit number 2)	
	0002	Number of retries (unit number 3)	
	to	to	
	003F	Number of retries (unit number 64)	

6-5 Slave Station Entry Status

The following diagram shows the structure of the status indicating participation in the network by Slave Stations. Slave Station entry status indicates which I/O Slave Stations are communicating with the Serial Master Station according to the unit number. The entry status (variables) for I/O Slave Stations with unit numbers 1 to 64 are stored in addresses 0000H to 0003H of variable type 80.

Example: Unit Numbers 1 to 3 Have Entered the Network

0000 0000 0000 0111

The value 0007H is stored in address 0000H.

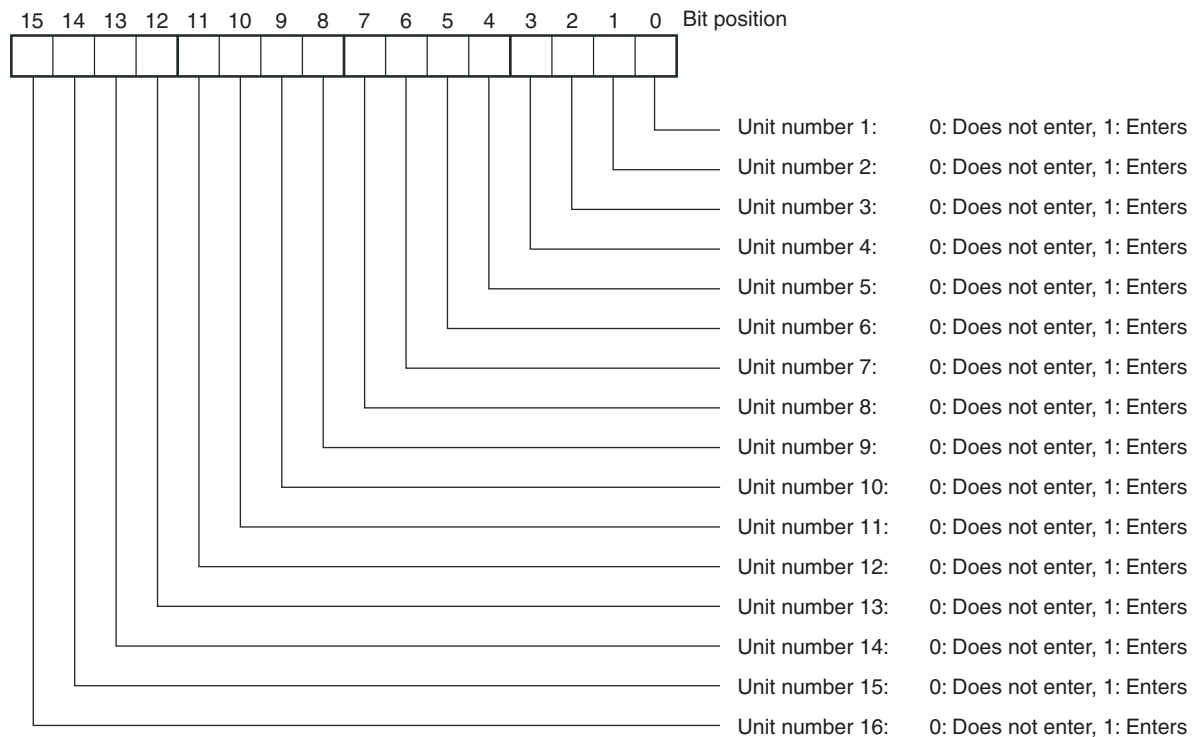

6-6 Slave Station Input Data

The following diagram shows the structure of the input data for the Slave Station. The input contact data (variables) for I/O Slave Stations from unit number 1 to 64 are stored in addresses 0004H to 0043H of variable type 80. The Serial Master Station's input/output data is cleared when the power is turned OFF.

Example: Inputs 0 to 3 for Unit Number 1 Are ON

0000 0000 0000 1111

The value 000FH is stored in address 0004H.

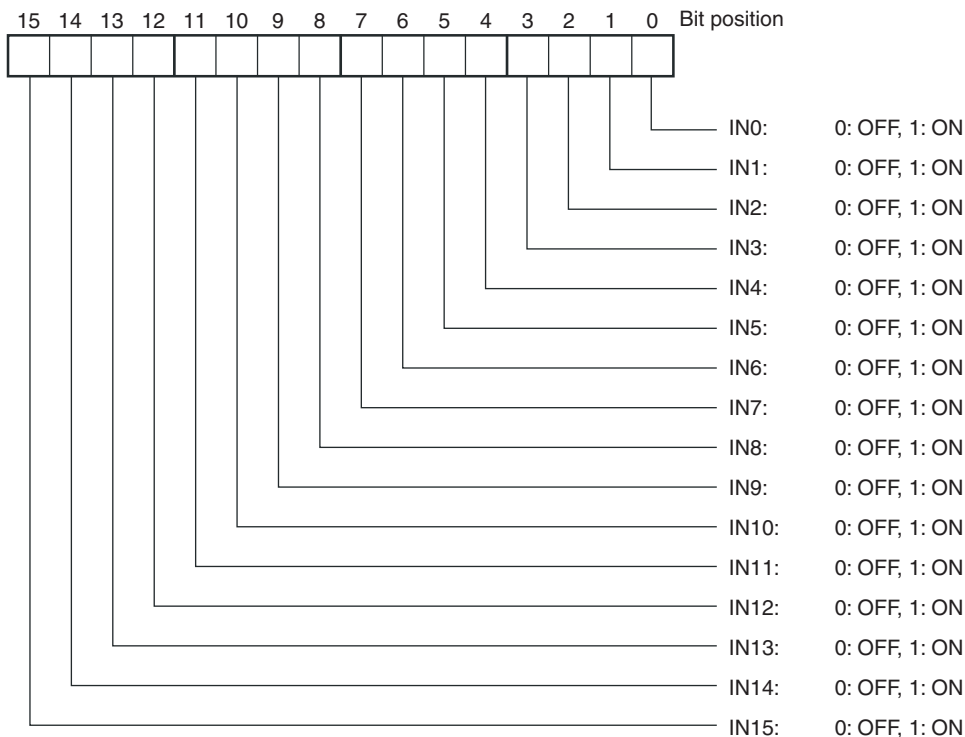

Sending Commands to Serial Master Station

When reading Slave Station input data in a batch for a specified range of node numbers, an error will not occur if I/O Slave Stations that cannot communicate are present.

6-7 Slave Station Status

The following diagram shows the structure of slave station status data.

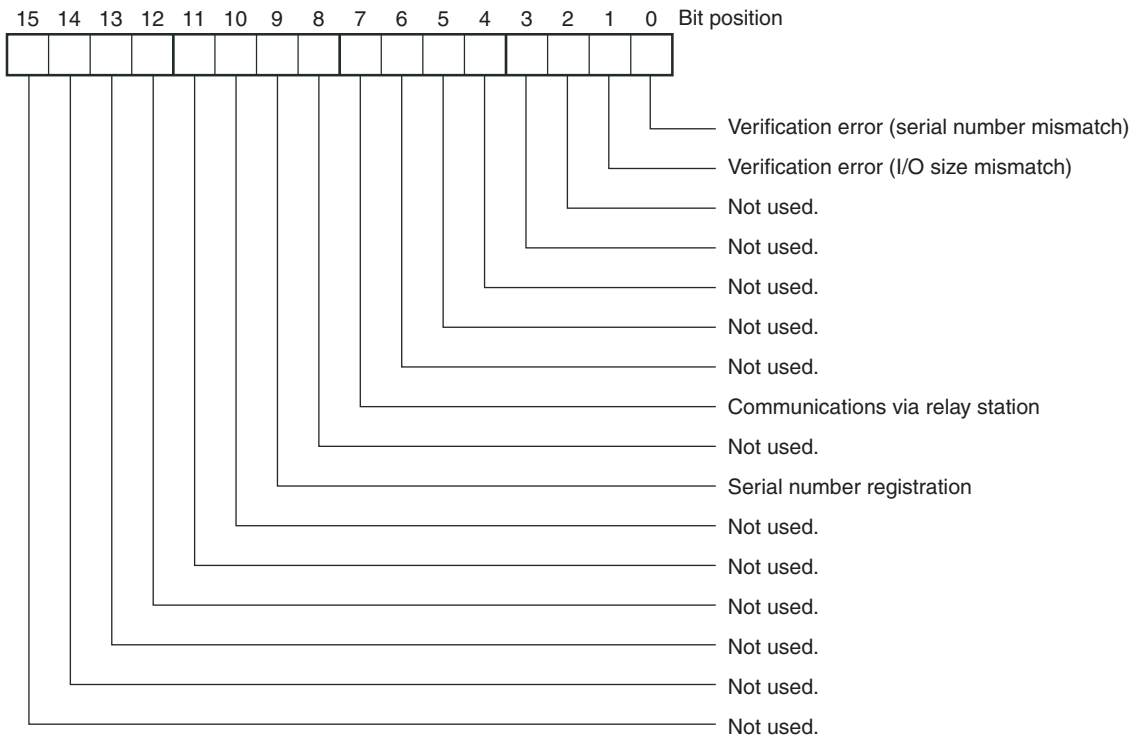

The following table shows the status details.

Bit position	Status	Bit description	
		0	1
0	Verification error (serial number mismatch)	No error	Error
1	Verification error (I/O size mismatch)	No error	Error
2	Not used.		
3	Not used.		
4	Not used.		
5	Not used.		
6	Not used.		
7	Communications via Relay Station	No relay	Via relay
8	Not used.		
9	Serial number registration	Not registered	Registered
10	Not used.		
11	Not used.		
12	Not used.		
13	Not used.		
14	Not used.		
15	Not used.		

Note Unused bits are always OFF (0).

6-8 Number of Communications Errors

The number of communications errors is counted as the number of communications errors that occur after the power is turned ON and the WT30 Terminal has entered the network. The count returns to 0000H after reaching FFFFH. If operation is started with the scan list enabled, however, communications errors are also counted even if the I/O Slave Stations have not entered the network yet.

6-9 Slave Station Route Information

The following diagram shows the structure of slave station route data.

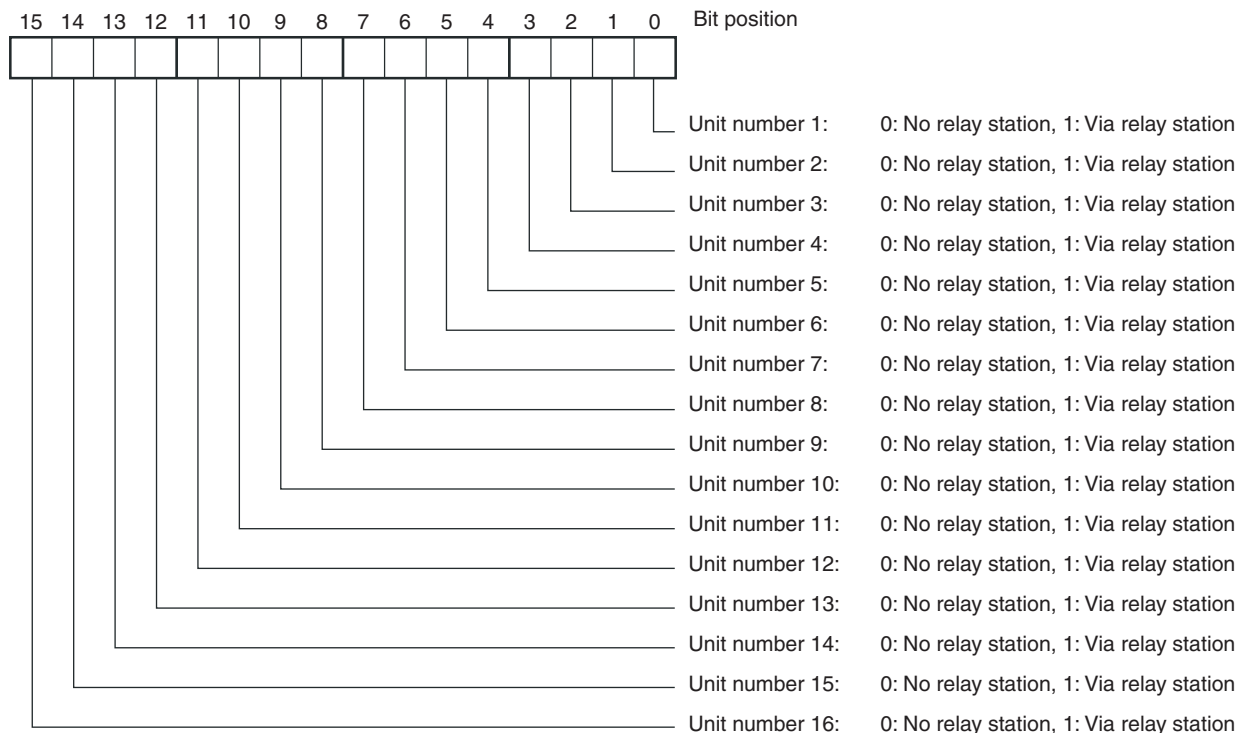

6-10 Slave Station Output Data

The following diagram shows the structure of the slave station's output data. The output status for I/O Slave Stations from unit number 1 to 64 is specified in addresses 000H to 003FH of variable type 81. The Serial Master Station's input/output data is cleared when the power is turned OFF.

Example: Outputs 0 to 2 for Unit Number 1 Are OFF

0000 0000 0000 0111

When 0007H is specified in address 0000H, outputs 0 to 2 for unit number 1 are turned ON.

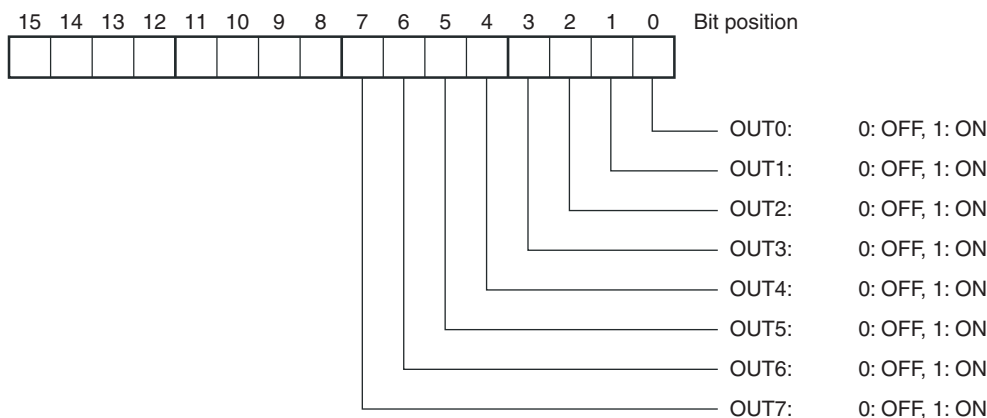

Sending Commands to a Serial Master Station

When writing Slave Station output data in a batch for a specified range of node numbers, an error will occur if I/O Slave Stations that cannot communicate are present. Errors will also occur under the following conditions.

- Using I/O Slave Stations with 16 inputs.
- Using I/O Slave Stations in scan list disabled mode that have not entered the network.
- Using unregistered I/O Slave Stations in scan list enabled mode.

Write 0000 as the data for I/O Slave Stations that are not used or cannot communicate.

6-11 Slave Station I/O Size

The following table shows the structure of the Slave Station I/O size (number of points).

Data	Description
Lower byte	Input size: 08H, 10H
Upper byte	Output size: 00H, 08H

The I/O size data that is read depends on the setting status at the time the data is read, as follows.

- In RUN mode without using the scan list: Reads I/O size of I/O Slave Stations that entered the network using entry processing.
- In SET mode with all I/O Slave Stations registered: Reads I/O size of I/O Slave Stations during temporary registration in the scan list.
- Other setting status: Reads I/O size of I/O Slave Stations registered in the scan list.

Example: WT30-SID16: 0010H
 WT30-SMD16/SMD16-1: 0808H

6-12 Serial Number Registration Status

The following diagram shows the structure of serial number registration status. Serial number registration status indicates whether the serial number is also registered when registering an I/O Slave Station. The serial number registration status for I/O Slave Stations from unit number 1 to 64 are stored in addresses 0083H to 0086H of variable type 82.

Example: Serial Numbers for Unit Numbers 1 to 3 Are Registered

0000 0000 0000 0111

The value 0007H is stored in address 0083H.

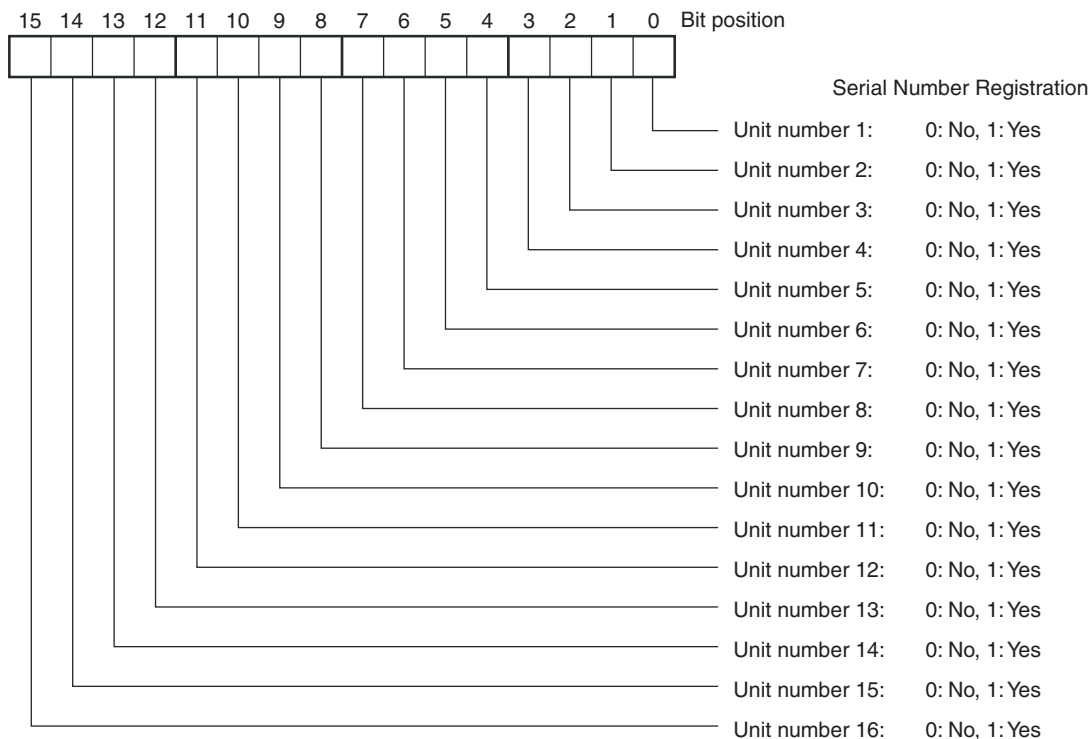

6-13 CompoWay/F Communications

The following table shows which commands are supported for each status.

Status	Variable area								READ CON- TROLLER DATA	READ MACHINE ATTRIBUTES	READ CON- TROLLER STATUS	ECHO- BACK TEST	OPERATION COMMANDS
	Read				Write								
	80	81	82	83	80	81	82	83					
RUN mode	Read-only		Read-only	Read-only	Read-only		Read-only	Operation error					No response, but command is executed
TEST mode	Operation error	Operation error	Read-only	Read-only	Read-only	Operation error	Read-only	Operation error					No response, but command is executed
SET mode	Operation error	Operation error	Read-only		Read-only	Operation error	Read-only						No response, but command is executed
EEPROM error	Operation error	Operation error	Operation error	Operation error	Operation error	Operation error	Operation error	Operation error	Operation error	Operation error	Operation error	Operation error	Operation error
Initial status	No response												

Note The blank boxes indicate that a normal response is returned if the parameters are enabled and the command is executed normally.

Appendix

This sections describes the WT30 specifications and options.

Appendix A Comparison between WT30 and WD30	96
Appendix B List of Supported Devices	97
Power Supplies	97
Appendix C I/O Response Time	99
I/O Response Time	99
Wireless Communications Delay (TWCY)	100
Appendix D Optional Accessories	101
Antennas	101
Communications Cables	101
Other Accessories	101
Appendix E Specifications	103
List of Models	104
Appendix F Frequency Table	105

Appendix A

Comparison between WT30 and WD30

The major differences between the WT30 and WD30 are described in the following diagram.

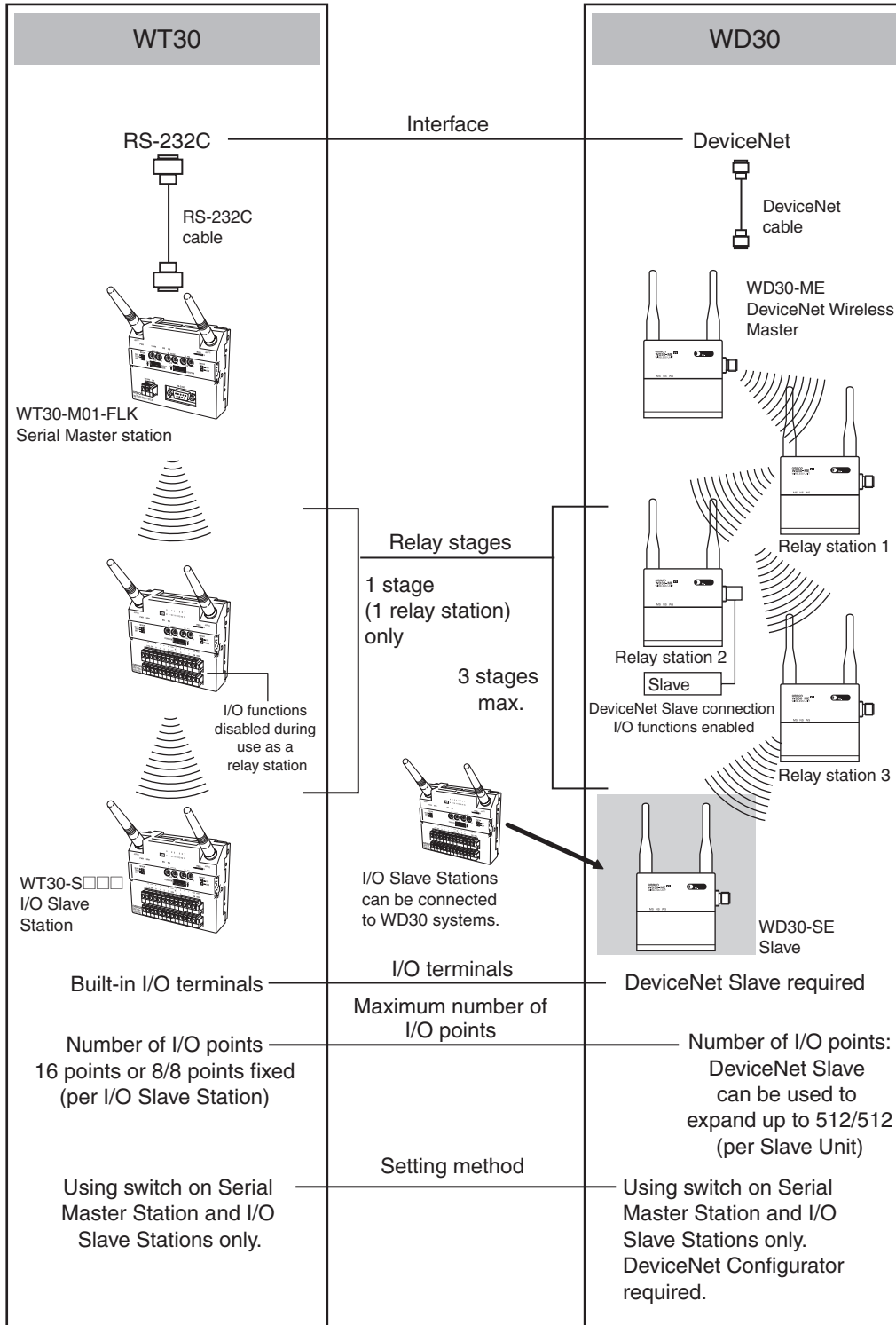

Appendix B

List of Supported Devices

Power Supplies

The following Switching Power Supply Units can be connected to the WT30.

Model	Specifications	Manufacturer
S8VS-01524□ (See note 1.) S8VS-03024□ (See note 1.) S8VS-06024□ (See note 1.) S8VS-09024□ S8VS-12024□ S8VS-24024□	15 W or higher only	OMRON
S8TS-06024□ (See notes 1 and 2.)		
S82J-02524□ (See note 1.) S82J-05024□ (See note 1.) S82J-10024□ S82J-15024□		
S82K-01524 (See note 1.) S82K-03024 (See note 1.) S82K-05024 (See note 1.) S82K-09024 (See note 1.) S82K-10024 (See note 1.) S82K-24024		

Note (1) These products are Class 2 power supplies according to UL standards.

(2) Class 2 is not satisfied if the Power Supply Units are operated in parallel.

WT30 Terminals require a 24-VDC power supply. Provide a power supply of at least 15 W, considering the inrush current generated at startup. An OMRON Switching Power Supply Unit is recommended.

Appendix C

I/O Response Time

I/O Response Time

Compared with a wired network, wireless communications may be delayed due to the influence of the surrounding electromagnetic environment, making it difficult to achieve the calculated response time. The calculation method is provided here as a guide.

The response time required until an input signal from the I/O Slave Station reaches the personal computer or PLC via the Serial Master Station can be estimated as follows:

T1: I/O Slave Station input filter (10 ms/100 ms)

T2: Serial Master Station wireless communications delay (TWCY) × 2

T3: The CompoWay/F command and response execution time and the time required for the Serial Master Station to return a response. This value depends on the communications baud rate and number of data.

TOUT: I/O Unit output ON (OFF) delay time

TcMD: Command send time

Input

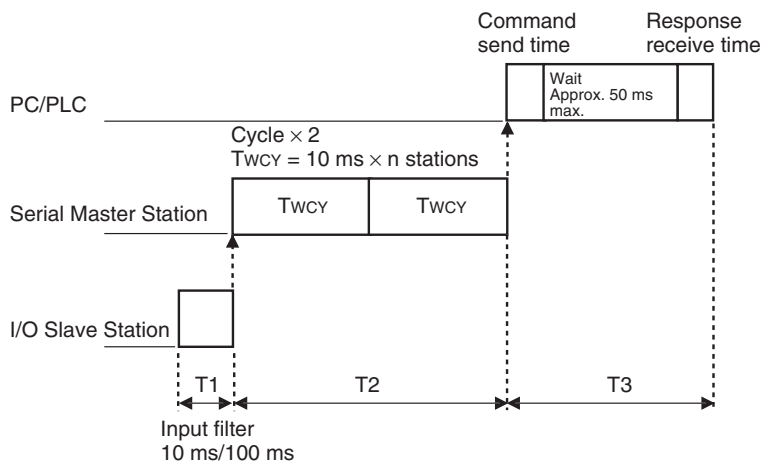

Output

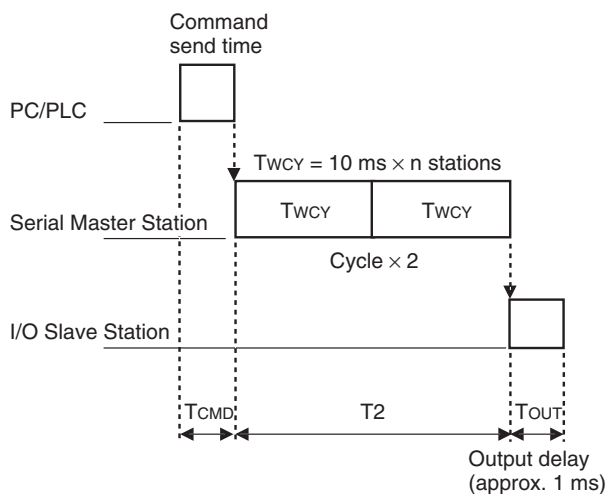

For details on the command send time, refer to 3-6-4 *Input Hold* on page 53.

Wireless Communications Delay (T_{wcy})

The response time required until an input signal from the I/O Slave Station is reflected in the Serial Master Station's memory is a total of approximately 10 ms per I/O Slave Station plus the input filter time, as follows:

Response time = T_{wcy} × 2 (See note 1.) + Input filter (See note 2.) (= T₁ + T₂)

- Note**
- (1) The wireless communications delay is multiplied by two to account for the internal processing of the Serial Master Station (time required until data is stored in the memory area).
 - (2) The input filter is 10 ms or 100 ms (depending on the switch setting).

$$\begin{aligned} T_{wcy} &= \sum_{WNODE} \text{(Sum total of cycle times for all I/O Slave Stations)} \\ &= \sum_{WNODE} (10 \text{ ms} \times n \text{ stations}) \end{aligned}$$

Using Relay Stations

The wireless communications delay is doubled when a Relay Station is used.

$$= \sum_{WNODE} (10 \text{ ms} \times n \text{ stations} \times 2)$$

Example 1: Using one Master Station, four I/O Slave Stations, and an input filter of 10 ms.

$$10 \times 4 \times 2 + 10 = 90 \text{ ms}$$

Example 2: Using one Master Station, one Relay Station, four I/O Slave Stations, and an input filter of 10 ms.

$$10 \times 4 \times 2 \times 2 + 10 = 170 \text{ ms}$$

The calculations shown here indicate theoretical values and should be considered as a rough guide only. The actual values obtained will depend on the installation environment.

Appendix D

Optional Accessories

Antennas

WT30-AT001 Magnet-base Antennas

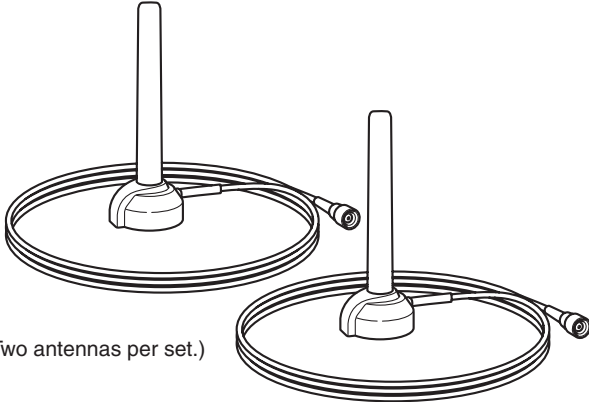

(Two antennas per set.)

WT30-AT002 Flat Diversity Antenna

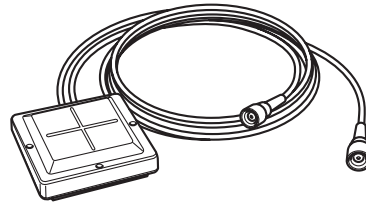

WT30-AT003 Pencil Antennas

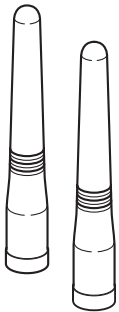

(Two antennas per set.)

Communications Cables

Model	Length	Application
XW2Z-0100U-3	1 m	To connect personal computers
XW2Z-0200U-3	2 m	
XW2Z-0500U-3	5 m	
XW2Z-0200U-5	2 m	To connect PLCs
XW2Z-0500U-5	5 m	

Other Accessories

Model	Description
WT30-FT001	DIN Rail Mounting Bracket (for TH35-7.5)
WT30-FT002	DIN Rail Mounting Bracket (for TH35-15)
WT30-FT003	Surface Mounting Bracket (screw-mounting) 2 brackets per set
WT30-FT011	Flat Diversity Antenna Mounting Brackets (with magnets)
WT30-CA2M	Antenna Extension Cable (1 cable, 2 m)

Appendix E

Specifications

Ratings

Item		WT30-M01-FLK Serial Master	WT30-SID16/SMD16/SMD16-1 I/O Slaves
Power supply (wireless communications power supply)	Rated voltage	24 VDC	
	Allowable voltage range	20.4 to 26.4 VDC	
	Power consumption	3 W max.	
Output/error output power supply (for output circuits)	Rated voltage	---	24 VDC
	Allowable voltage range	---	20.4 to 26.4 VDC
Insulation resistance		20 MΩ min. (at 100 VDC) between the power supply and all the parts.	20 MΩ min. (at 100 VDC) between the power supply and all I/O and I/O power supply and between the power supply and chassis
Dielectric strength		1,500 VAC for 1 min between the power supply and all the parts	1,500 VAC for 1 min between the power supply and all I/O and I/O power supply and between the power supply and chassis
Noise immunity		IEC61000-4-4. 1 kW (power supply line)	
Vibration resistance (See note.)		Conforms to JIS C0040 Frequency: 10 to 55 Hz; Amplitude of 0.35 mm or acceleration of 50 m/s ² , whichever is smaller (DIN Rail mounting: single-amplitude of 0.1 mm or acceleration of 15 m/s ²) 10 sweeps of 8 min each (i.e., 80 min in total) in X, Y, and Z directions	
Shock resistance		Conforms to JIS C0041: 300 m/s ² 3 times each in X, Y, and Z directions	
Ambient operating temperature		-10 to 55°C (with no icing or condensation) (with the Terminal mounted with the dust-proof label facing up)	Number of simultaneously ON I/O points 10 max.: -10 to 55°C 16 max.: -10 to 50°C (with no icing or condensation) (with the Terminal mounted with the dust-proof label facing up)
Ambient operating humidity		25% to 85% (with no icing or condensation)	
Ambient environment		No corrosive gases	
Storage temperature		-25 to 65°C (with no icing or condensation)	
Protective structure		IP20	
Terminal construction	Power supply/I/O terminal	Screwless terminal block (Phoenix Contact FFKDS/V1-5.08 or equivalent)	
	Serial	D-sub, 9-pin (female) Inch screws (OMRON XM2F-0910-132 or equivalent)	---
Safety standards		UL: UL508 (Listing)	
Weight		330 g max.	
Number of EEPROM overwrite operations		Approximately 1,000,000 operations	

Note Use the WT30-FT003 Surface Mounting Bracket when installing the WT30 in environments subject to vibration.

Wireless Interface Specifications

Item	Specifications
Wave type	Spread Spectrum (direct sequence; SS-DS)
Communication method	Simplex
Frequency band	2,401 to 2,480.2 MHz
Number of channels	66 channels (based on switching)
Transmitter output power	10 mW/MHz
Baud rate between WT30 Terminals	100 kbit/s
Communications distance (See note.)	Indoors: 60 m min. (approx. 50 m min. with Magnet-base Antennas and Flat Diversity Antennas) Outdoors: Approx. 300 m min. (anticipated distances) (without using relay stations)
Relay functions	One stage (a single station only) using I/O Slave for the Serial Master configuration.
Number of stations per area	10 sets max. (recommended)
Number of I/O Slaves connected	64 max.
Error detection method	CRC-CCITT (16 bits)

Note Varies according to the installation environment.

List of Models

WT30 Terminals

WT30 Terminal model	Type	Description
WT30-M01-FLK	Serial Master Station	RS-232C
WT30-SID16	I/O Slave Stations	16 DC inputs (NPN, PNP)
WT30-SMD16		8 DC inputs (NPN, PNP) + 8 transistor outputs (NPN)
WT30-SMD16-1		8 DC inputs (NPN, PNP) + 8 transistor outputs (PNP)

Note Antennas and Mounting Brackets are not included with the WT30 Terminals and must be ordered separately.

Appendix F

Frequency Table

Channel	WCH setting		Center frequency (MHz)	Channel	WCH setting		Center frequency (MHz)
	×10	×1			×10	×1	
1	0	1	2401.0				
2	0	2	2403.4	51	5	1	2402.2
3	0	3	2405.8	52	5	2	2404.6
4	0	4	2408.2	53	5	3	2407.0
5	0	5	2410.6	54	5	4	2409.4
6	0	6	2413.0	55	5	5	2411.8
7	0	7	2415.4	56	5	6	2414.2
8	0	8	2417.8	57	5	7	2416.6
9	0	9	2420.2	58	5	8	2419.0
10	1	0	2422.6	59	5	9	2421.4
11	1	1	2425.0	60	6	0	2423.8
12	1	2	2427.4	61	6	1	2426.2
13	1	3	2429.8	62	6	2	2428.6
14	1	4	2432.2	63	6	3	2431.0
15	1	5	2434.6	64	6	4	2433.4
16	1	6	2437.0	65	6	5	2435.8
17	1	7	2439.4	66	6	6	2438.2
18	1	8	2441.8	67	6	7	2440.6
19	1	9	2444.2	68	6	8	2443.0
20	2	0	2446.6	69	6	9	2445.4
21	2	1	2449.0	70	7	0	2447.8
22	2	2	2451.4	71	7	1	2450.2
23	2	3	2453.8	72	7	2	2452.6
24	2	4	2456.2	73	7	3	2455.0
25	2	5	2458.6	74	7	4	2457.4
26	2	6	2461.0	75	7	5	2459.8
27	2	7	2463.4	76	7	6	2462.2
28	2	8	2465.8	77	7	7	2464.6
29	2	9	2468.2	78	7	8	2467.0
30	3	0	2470.6	79	7	9	2469.4
31	3	1	2473.0	80	8	0	2471.8
32	3	2	2475.4	81	8	1	2474.2
33	3	3	2477.8	82	8	2	2476.6
34	3	4	2480.2	83	8	3	2479.0

Index

A

- accessories, 101
- Antenna Extension Cable, 101
- Antenna terminal
 - I/O Slave Stations, 11
 - Serial Master Stations, 8
- Antennas, 101
 - distance, 33
 - installation position, 14
 - precautions, 14
- application guide, xii
- automatic scan, 38
 - stopping temporarily, 39

B

- baud rate, 104
- BCC (Block Check Character), 77

C

- channel setting switch
 - I/O Slave Stations, 11
 - Serial Master Stations, 7
- channels
 - automatic scan, 38
 - finding unused
 - registered I/O Slave Stations, 46
 - unregistered I/O Slave Stations, 42
 - monitoring, 37, 38
 - number, 104
 - peak values, 38
- cleaning, 72
- communications
 - basic configuration, xii
 - between WT30 Terminals, xiii
 - extending distance, 60
 - setup, 62
 - using relay stations, xii
- communications cables, 101
- communications errors
 - clearing I/O data, 56
 - holding I/O data, 56
 - intermodulation, 33
 - output control, 56
- communications status
 - Serial Master Stations, 44

- unregistered I/O Slave Stations, 44
- communications timing, 54
- CompoWay/F
 - BCC calculation, 77
 - command frame structure, 76
 - end codes, 77
 - number of communications errors, 91
 - response codes, 78
 - response frame format, 77
 - serial number registration status, 93
 - services, 76
 - Echoback Test (0801), 84
 - Operation Commands (3005), 85
 - Read Controller Data (0501), 82
 - Read Controller Status (0601), 83
 - Read Machine Attributes (0503), 83
 - Read Variable Area (0101), 78
 - Write Variable Area (0102), 80
 - setting ranges, 86
 - Slave Station entry status, 88
 - Slave Station I/O size, 92
 - Slave Station input data, 89
 - Slave Station output data, 92
 - Slave Station route information, 91
 - Slave Station status, 90
 - supported commands, 93
 - variable areas, 86
- connections
 - input devices, 30
 - output loads, 31
 - Serial Master Stations, 24
 - multiple, 5

D

- default settings
 - reinstating, 56
- degree of protection, 103
- dielectric strength, 103
- dimensions
 - Flat Diversity Antenna Mounting Brackets, 21
 - Flat Diversity Antennas, 20
 - Magnet-base Antennas, 20
 - Pencil Antennas, 21
 - WT30 Terminals, 19
- DIN Rail Adapters, 23
- DIN Rail Mounting Brackets, 101
- DIN Rails, 23

E

EEPROM overwrite operations, 103

EMC standards, iv

EMF standards, iv

error output, 28

errors

 detection method, 104

 system, 68

 troubleshooting with indicators, 68

F

FCC Rules, iv

features, 2

Flat Diversity Antenna Mounting Brackets, 101

Flat Diversity Antennas, 18, 101

frequency

 band, 104

 monitoring, 37

 table, 105

function setting switch

 details, 50

 I/O Slave Stations, 11

 Serial Master Stations, 7

functions

 overview, xiii

I

I/O response time, 99

I/O Slave Stations

 Antenna terminal, 11

 appearance, 10

 channel setting switch, 11

 communications status, 44

 function setting switch, 11

 I/O terminals, 11

 indicators, 12

 mode selection switch, 11

 node setting switch, 10

 part names, 10

 power supply terminals, 11

 Received Signal Strength Indicator (RSSI), 12

 registering, 36

 all, 47, 51

 specific, 51

 special function switch, 11

 terminal labels, 27

 using registered, 45

 confirming connection, 49

 finding unused channels, 46

 operation settings, 49

 using unregistered, 42

 confirming connection, 44

 finding unused channels, 42

 operation settings, 43

I/O terminals

 I/O Slave Stations, 11

 wiring, 28

indicators

 I/O Slave Stations, 12, 71

 Serial Master Stations, 8, 70

 troubleshooting, 70

input filter, 55

input hold, 53

inspection, 72

installation

 Antenna, 14

 DIN Rail mounting, 23

 location, 14

 L-shaped Brackets, 22

 precautions, 14

 table-top mounting, 22

insulation resistance, 103

intermodulation, 33

L

L-shaped Brackets, 22

M

Magnet-base Antennas, 101

maintenance, 72

mode selection switch

 I/O Slave Stations, 11

 Serial Master Stations, 7

models, 5

 list, 104

 WT30-M01-FLK, 104

 WT30-SID16, 104

 WT30-SMD16, 104

 WT30-SMD16-1, 104

monitoring

 all channels, 38

 specified channels, 37

 unused frequencies, 37

N

- node setting switch
 - I/O Slave Stations, 10
 - Serial Master Stations, 7
- noise immunity, 103

O

- operating humidity, 103
- operating temperature, 103
- operation settings
 - registered I/O Slave Stations, 49
 - Serial Master Stations, 43
 - unregistered I/O Slave Stations, 43
- output control
 - communications errors, 56
- overseas use, v

P

- package contents, xi
- part names
 - I/O Slave Stations, 10
 - Serial Master Stations, 6
- peak values
 - automatic recording, 38
- Pencil Antennas, 101
- power supplies, 97
 - wiring, 27
- power supply terminals
 - I/O Slave Stations, 11
 - Serial Master Stations, 8
- precautions
 - Antennas, 14
 - correct use, x
 - general, viii
 - installation, 14
 - replacement, 73
 - safety, vii, ix
 - system design, 32
 - wiring, 26

R

- rated voltage, 103
- received signal strength
 - all channels, 38

- clearing recorded peak values, 40
- reading recorded values, 39
- specified channels, 37

- Received Signal Strength Indicator (RSSI), 37
 - I/O Slave Stations, 12
 - Serial Master Stations, 9
- registered I/O Slave Stations
 - operation settings, 49
- registering I/O Slave Stations, 36, 45
 - all, 51
 - specific, 51
- relay configuration, 4
- relay function, 60, 104
- Relay Stations, xii
 - confirming communications, 64
 - I/O Slave Station settings, 63
 - Serial Master Station settings, 64
 - settings, 63
 - using a WT30 Terminal, 60
 - wireless communications delay, 100
- replacing WT30 Terminals, 72, 73
 - I/O Slave Stations, 73
 - precautions, 73
 - Serial Master Station settings, 73
- RS-232C terminal
 - Serial Master Stations, 8

S

- safety precautions, vii, ix
- scan list
 - registration, 47, 50, 51
 - scan list disabled mode, 36, 52
 - scan list enabled mode, 36, 53
 - stopping registration, 51
- serial communications setting switch
 - Serial Master Stations, 8
- Serial Master Stations
 - Antenna terminal, 8
 - channel setting switch, 7
 - communications status, 44
 - function setting switch, 7
 - indicators, 8
 - mode selection switch, 7
 - node setting switch, 7, 10, 11
 - part names, 6
 - power supply terminals, 8
 - Received Signal Strength Indicator (RSSI), 9
 - RS-232C Terminal, 8
 - serial communications setting switch, 8

- special function switch, 7
- unit No. switch, 6
- serial number check, 47, 51
- setup flowchart, 41
 - communications with relay function, 62
- shock resistance, 103
- special function switch
 - I/O Slave Stations, 11
 - Serial Master Stations, 7
- specifications, 103
 - wireless interface, 104
 - WT30-SID16 Input Unit, 28
 - WT30-SMD16(-1) I/O Slave Stations, 29
- standards, iv
- storage temperature, 103
- Surface Mounting Brackets, 101
- Switching Power Supply Units, 97
- system configuration, 3
 - basic, 3
 - multiple Serial Master Stations, 5
 - using Relay Stations, 4, 63
- system design, 32
- system errors, 68

T

- terminal construction, 103
- terminal labels, 27
- transmission output, 104
- troubleshooting, 68
 - with indicators, 68, 70

U

- UL standards, iv
 - power supplies, 97
- unit No. switch
 - Serial Master Stations, 6
- unregistered I/O Slave Stations, 42
 - confirming connection, 44
 - finding unused channels, 42
 - operation settings, 43

V

- vibration resistance, 103

W

- WD30
 - comparison with WT30, 96
- weight, 103
- wireless channels, 32
- wireless communications delay (TWCY), 100
 - using Relay Stations, 100
- wiring
 - I/O terminals, 28
 - power supply, 27
 - precautions, 26
- WT30-TOOLS, 41

Revision History

A manual revision code appears as a suffix to the catalog number on the front cover of the manual.

Cat. No. N138-E1-01



Revision code

The following table outlines the changes made to the manual during each revision. Page numbers refer to the previous version.

Revision code	Date	Revised content
01	March 2005	Original production

Revision History

OMRON CORPORATION
Industrial Automation Company

Industrial Devices and Components Division H.Q.
Wireless Components Department
Shiokoji Horikawa, Shimogyo-ku,
Kyoto, 600-8530 Japan
Tel: (81)75-344-7116/Fax: (81)75-344-7189

Regional Headquarters

OMRON EUROPE B.V.
Wegalaan 67-69, NL-2132 JD Hoofddorp
The Netherlands
Tel: (31)2356-81-300/Fax: (31)2356-81-388

OMRON ELECTRONICS LLC
1 East Commerce Drive, Schaumburg, IL 60173
U.S.A.
Tel: (1)847-843-7900/Fax: (1)847-843-8568

OMRON ASIA PACIFIC PTE. LTD.
83 Clemenceau Avenue,
#11-01, UE Square,
239920 Singapore
Tel: (65)6835-3011/Fax: (65)6835-2711

OMRON CHINA CO., LTD. BEIJING OFFICE
Room 1028, Office Building,
Beijing Capital Times Square,
No. 88 West Chang'an Road,
Beijing, 100031 China
Tel: (86)10-8391-3005/Fax: (86)10-8391-3688

OMRON

Authorized Distributor: