

FCC Test Report

Report No.: RFBGTL-WTW-P20100273

FCC ID: RX3-WBU053VZBT

Test Model: WBU053-VZBT

Received Date: Oct. 21, 2020

Test Date: Oct. 26 ~ Oct. 29, 2020

Issued Date: Nov. 06, 2020

Applicant: Hon Hai Precision Industry Co., Ltd.

Address: No.151, Sec. 1, Nankan Rd., Lujhu Dist., Taoyuan County 33859, Taiwan
(R.O.C.)

Issued By: Bureau Veritas Consumer Products Services (H.K.) Ltd., Taoyuan Branch
Lin Kou Laboratories

Lab Address: No. 47-2, 14th Ling, Chia Pau Vil., Lin Kou Dist., New Taipei City, Taiwan

Test Location: No.19, Hwa Ya 2nd Rd., Wen Hwa Vil., Kwei Shan Dist., Taoyuan City
33383, Taiwan

**FCC Registration /
Designation Number:** 788550 / TW0003



This report is for your exclusive use. Any copying or replication of this report to or for any other person or entity, or use of our name or trademark, is permitted only with our prior written permission. This report sets forth our findings solely with respect to the test samples identified herein. The results set forth in this report are not indicative or representative of the quality or characteristics of the lot from which a test sample was taken or any similar or identical product unless specifically and expressly noted. Our report includes all of the tests requested by you and the results thereof based upon the information that you provided to us. You have 60 days from date of issuance of this report to notify us of any material error or omission caused by our negligence, provided, however, that such notice shall be in writing and shall specifically address the issue you wish to raise. A failure to raise such issue within the prescribed time shall constitute your unqualified acceptance of the completeness of this report, the tests conducted and the correctness of the report contents. Unless specific mention, the uncertainty of measurement has been explicitly taken into account to declare the compliance or non-compliance to the specification.

Table of Contents

Release Control Record	4
1 Certificate of Conformity	5
2 Summary of Test Results	6
2.1 Measurement Uncertainty	7
2.2 Modification Record	7
3 General Information	8
3.1 General Description of EUT	8
3.2 Description of Test Modes	9
3.2.1 Test Mode Applicability and Tested Channel Detail	10
3.3 Duty Cycle of Test Signal	12
3.4 Description of Support Units	13
3.4.1 Configuration of System under Test	13
3.5 General Description of Applied Standards and References	14
4 Test Types and Results	15
4.1 Radiated Emission and Bandedge Measurement	15
4.1.1 Limits of Radiated Emission and Bandedge Measurement	15
4.1.2 Test Instruments	16
4.1.3 Test Procedures	17
4.1.4 Deviation from Test Standard	17
4.1.5 Test Set Up	18
4.1.6 EUT Operating Conditions	19
4.1.7 Test Results	20
4.2 Conducted Emission Measurement	36
4.2.1 Limits of Conducted Emission Measurement	36
4.2.2 Test Instruments	36
4.2.3 Test Procedures	37
4.2.4 Deviation from Test Standard	37
4.2.5 Test Setup	37
4.2.6 EUT Operating Condition	37
4.2.7 Test Results	38
4.3 Number of Hopping Frequency Used	42
4.3.1 Limits of Hopping Frequency Used Measurement	42
4.3.2 Test Setup	42
4.3.3 Test Instruments	42
4.3.4 Test Procedure	42
4.3.5 Deviation from Test Standard	42
4.3.6 Test Results	43
4.4 Dwell Time on Each Channel	44
4.4.1 Limits of Dwell Time on Each Channel Measurement	44
4.4.2 Test Setup	44
4.4.3 Test Instruments	44
4.4.4 Test Procedures	44
4.4.5 Deviation from Test Standard	44
4.4.6 Test Results	45
4.5 Channel Bandwidth	47
4.5.1 Limits of Channel Bandwidth Measurement	47
4.5.2 Test Setup	47
4.5.3 Test Instruments	47
4.5.4 Test Procedure	47
4.5.5 Deviation from Test Standard	47
4.5.6 EUT Operating Condition	47
4.5.7 Test Results	48
4.6 Occupied Bandwidth Measurement	49

4.6.1	Test Setup	49
4.6.2	Test Instruments	49
4.6.3	Test Procedure	49
4.6.4	Deviation from Test Standard	49
4.6.5	EUT Operating Conditions	49
4.6.6	Test Results	50
4.7	Hopping Channel Separation	51
4.7.1	Limits of Hopping Channel Separation Measurement	51
4.7.2	Test Setup	51
4.7.3	Test Instruments	51
4.7.4	Test Procedure	51
4.7.5	Deviation from Test Standard	51
4.7.6	Test Results	52
4.8	Maximum Output Power	53
4.8.1	Limits of Maximum Output Power Measurement	53
4.8.2	Test Setup	53
4.8.3	Test Instruments	53
4.8.4	Test Procedure	53
4.8.5	Deviation from Test Standard	53
4.8.6	EUT Operating Condition	53
4.8.7	Test Results	54
4.9	Conducted Out of Band Emission Measurement	55
4.9.1	Limits Of Conducted Out of Band Emission Measurement	55
4.9.2	Test Instruments	55
4.9.3	Test Procedure	55
4.9.4	Deviation from Test Standard	55
4.9.5	EUT Operating Condition	55
4.9.6	Test Results	55
5	Pictures of Test Arrangements	60
	Annex A- Band Edge Measurement	61
	Appendix – Information of the Testing Laboratories	65

Release Control Record

Issue No.	Description	Date Issued
RFBGTL-WTW-P20100273	Original Release	Nov. 06, 2020

1 Certificate of Conformity

Product: 802.11a/b/g/n 2T2R with Bluetooth combo wireless module

Brand: Foxconn

Test Model: WBU053-VZBT

Sample Status: Engineering Sample

Applicant: Hon Hai Precision Industry Co., Ltd.

Test Date: Oct. 26 ~ Oct. 29, 2020

Standards: 47 CFR FCC Part 15, Subpart C (Section 15.247)
ANSI C63.10:2013

The above equipment has been tested by **Bureau Veritas Consumer Products Services (H.K.) Ltd., Taoyuan Branch**, and found compliance with the requirement of the above standards. The test record, data evaluation & Equipment Under Test (EUT) configurations represented herein are true and accurate accounts of the measurements of the sample's RF characteristics under the conditions specified in this report.

Prepared by : Gina Liu, **Date:** Nov. 06, 2020
Gina Liu / Specialist

Approved by : Dylan Chiou, **Date:** Nov. 06, 2020
Dylan Chiou / Senior Project Engineer

2 Summary of Test Results

47 CFR FCC Part 15, Subpart C (Section 15.247)			
FCC Clause	Test Item	Result	Remarks
15.207	AC Power Conducted Emission	Pass	Meet the requirement of limit. Minimum passing margin is -12.75 dB at 0.43924 MHz.
15.247(a)(1)(iii)	Number of Hopping Frequency Used	Pass	Meet the requirement of limit.
15.247(a)(1)(iii)	Dwell Time on Each Channel	Pass	Meet the requirement of limit.
15.247(a)(1)	1. Hopping Channel Separation 2. Spectrum Bandwidth of a Frequency Hopping Sequence Spread Spectrum System	Pass	Meet the requirement of limit.
15.247(a)(1)	Maximum Peak Output Power	Pass	Meet the requirement of limit.
---	Occupied Bandwidth Measurement	Pass	Reference only
15.205 & 209	Radiated Emissions	Pass	Meet the requirement of limit. Minimum passing margin is -0.64 dB at 145.43 MHz.
15.247(d)	Band Edge Measurement	Pass	Meet the requirement of limit.
15.247(d)	Antenna Port Emission	Pass	Meet the requirement of limit.
15.203	Antenna Requirement	Pass	No antenna connector is used.

Note:

1. If the Frequency Hopping System operating in 2400-2483.5 MHz band and the output power less than 125 mW. The hopping channel carrier frequencies separated by a minimum of 25 kHz or two-thirds of the 20 dB bandwidth of hopping channel whichever is greater.
2. For 2.4G band compliance with rule 15.247(d) of the band-edge items, the test plots were recorded in Annex A. Test Procedures refer to report 4.1.3.
3. Determining compliance based on the results of the compliance measurement, not taking into account measurement instrumentation uncertainty.

2.1 Measurement Uncertainty

Where relevant, the following measurement uncertainty levels have been estimated for tests performed on the EUT as specified in CISPR 16-4-2:

Measurement	Frequency	Expanded Uncertainty (k=2) (\pm)
Conducted Emissions at mains ports	150 kHz ~ 30 MHz	2.79 dB
Radiated Emissions up to 1 GHz	9 kHz ~ 30 MHz	3.04 dB
	30 MHz ~ 200 MHz	2.93 dB
	200 MHz ~ 1000 MHz	2.95 dB
Radiated Emissions above 1 GHz	1 GHz ~ 18 GHz	2.26 dB
	18 GHz ~ 40 GHz	1.94 dB

2.2 Modification Record

There were no modifications required for compliance.

3 General Information

3.1 General Description of EUT

Product	802.11a/b/g/n 2T2R with Bluetooth combo wireless module
Brand	Foxconn
Test Model	WBU053-VZBT
Status of EUT	Engineering Sample
Power Supply Rating	4.5 ~ 5.5 Vdc (from Host equipment)
Modulation Type	GFSK, $\pi/4$ -DQPSK, 8DPSK
Transfer Rate	1/2/3 Mbps
Operating Frequency	2402 ~ 2480 MHz
Number of Channel	79
Output Power	6.982 mW
Antenna Type	Refer to Note as below
Antenna Connector	N/A
Accessory Device	N/A
Data Cable Supplied	N/A

Note:

1. The antenna information is listed as below.

No.	Functionality	Manufacturer	Model	Cable Length	Type	Antenna Gain (dBi)
1	BT	Foxconn	6903B0000N000	240mm	PIFA	2.27
2			6903B0000P000	390mm		2.47

2. The above Antenna information is declared by manufacturer and for more detailed features description, please refer to the manufacturer's specifications, the laboratory shall not be held responsible.
3. The above EUT information is declared by manufacturer and for more detailed features description, please refers to the manufacturer's specifications or User's Manual.

3.2 Description of Test Modes

79 channels are provided to this EUT:

Channel	Freq. (MHz)	Channel	Freq. (MHz)	Channel	Freq. (MHz)	Channel	Freq. (MHz)
0	2402	20	2422	40	2442	60	2462
1	2403	21	2423	41	2443	61	2463
2	2404	22	2424	42	2444	62	2464
3	2405	23	2425	43	2445	63	2465
4	2406	24	2426	44	2446	64	2466
5	2407	25	2427	45	2447	65	2467
6	2408	26	2428	46	2448	66	2468
7	2409	27	2429	47	2449	67	2469
8	2410	28	2430	48	2450	68	2470
9	2411	29	2431	49	2451	69	2471
10	2412	30	2432	50	2452	70	2472
11	2413	31	2433	51	2453	71	2473
12	2414	32	2434	52	2454	72	2474
13	2415	33	2435	53	2455	73	2475
14	2416	34	2436	54	2456	74	2476
15	2417	35	2437	55	2457	75	2477
16	2418	36	2438	56	2458	76	2478
17	2419	37	2439	57	2459	77	2479
18	2420	38	2440	58	2460	78	2480
19	2421	39	2441	59	2461		

3.2.1 Test Mode Applicability and Tested Channel Detail

EUT Configure Mode	Applicable To				Description
	RE \geq 1G	RE $<$ 1G	PLC	APCM	
A	√	√	√	-	Ant. 1
B	√	√	√	√	Ant. 2

Where **RE \geq 1G**: Radiated Emission above 1 GHz **RE $<$ 1G**: Radiated Emission below 1 GHz
PLC: Power Line Conducted Emission **APCM**: Antenna Port Conducted Measurement

Note:

1. For radiated emission (below 1GHz) and power line conducted emission test items, the worst maximum power was selected.
2. The EUT had been pre-tested on the positioned of each 3 axis. The worst case was found when positioned on **X-plane** for Mode A and **Y-plane** for Mode B.
3. "-" means no effect.

Radiated Emission Test (Above 1 GHz):

- Pre-Scan has been conducted to determine the worst-case mode from all possible combinations between available modulations, data rates and antenna ports (if EUT with antenna diversity architecture).
- Following channel(s) was (were) selected for the final test as listed below.

EUT Configure Mode	Available Channel	Tested Channel	Modulation Technology	Modulation Type	Packet Type
A, B	0 to 78	0, 39, 78	FHSS	GFSK	DH5
	0 to 78	0, 39, 78	FHSS	8DPSK	3DH5

Radiated Emission Test (Below 1 GHz):

- Pre-Scan has been conducted to determine the worst-case mode from all possible combinations between available modulations, data rates and antenna ports (if EUT with antenna diversity architecture).
- Following channel(s) was (were) selected for the final test as listed below.

EUT Configure Mode	Available Channel	Tested Channel	Modulation Technology	Modulation Type	Packet Type
A	0 to 78	78	FHSS	GFSK	DH5
B	0 to 78	78	FHSS	8DPSK	3DH5

Power Line Conducted Emission Test:

- Pre-Scan has been conducted to determine the worst-case mode from all possible combinations between available modulations, data rates and antenna ports (if EUT with antenna diversity architecture).
- Following channel(s) was (were) selected for the final test as listed below.

EUT Configure Mode	Available Channel	Tested Channel	Modulation Technology	Modulation Type	Packet Type
A	0 to 78	78	FHSS	GFSK	DH5
B	0 to 78	78	FHSS	8DPSK	3DH5

Antenna Port Conducted Measurement:

- This item includes all test value of each mode, but only includes spectrum plot of worst value of each mode.
- Pre-Scan has been conducted to determine the worst-case mode from all possible combinations between available modulations, data rates and antenna ports (if EUT with antenna diversity architecture).
- Following channel(s) was (were) selected for the final test as listed below.

EUT Configure Mode	Available Channel	Tested Channel	Modulation Technology	Modulation Type	Packet Type
B	0 to 78	0, 39, 78	FHSS	GFSK	DH5
	0 to 78	0, 39, 78	FHSS	8DPSK	3DH5

Test Condition:

Applicable To	Environmental Conditions	Input Power	Tested by
RE \geq 1G	25 deg. C, 65 % RH	120 Vac, 60 Hz	Getaz Yang
RE $<$ 1G	25 deg. C, 65 % RH	120 Vac, 60 Hz	Cyril Chen
PLC	25 deg. C, 65 % RH	120 Vac, 60 Hz	Getaz Yang
APCM	25 deg. C, 60 % RH	5 Vdc	Ivan Tseng

3.3 Duty Cycle of Test Signal

Mode A

GFSK

Duty cycle = $2.9 \times 1/100 = 0.029$, Duty factor = $20 \times \log(0.029) = -30.75$



Mode B

GFSK

Duty cycle = $2.898 \times 1/100 = 0.02898$, Duty factor = $20 \times \log(0.02898) = -30.76$



3.4 Description of Support Units

The EUT has been tested as an independent unit together with other necessary accessories or support units. The following support units or accessories were used to form a representative test configuration during the tests.

No.	Product	Brand	Model No.	Serial No.	FCC ID
1.	Notebook	Dell	E5420	FHP75S1	N/A

Note:

1. All power cords of the above support units are non-shielded (1.8m).
2. Item 1 acted as communication partners to transfer data.

3.4.1 Configuration of System under Test

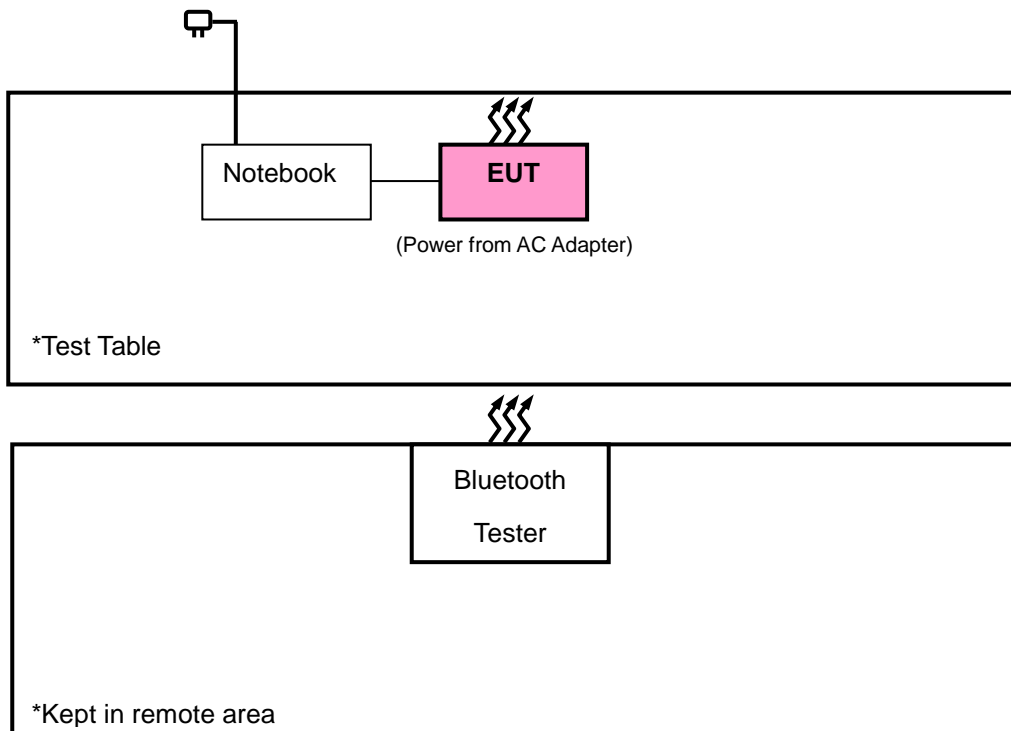

3.5 General Description of Applied Standards and References

The EUT is a RF Product. According to the specifications of the manufacturer, it must comply with the requirements of the following standards and references:

Test Standard:

FCC Part 15, Subpart C (15.247)

ANSI C63.10-2013

All test items have been performed and recorded as per the above standards.

References Test Guidance:

KDB 558074 D01 15.247 Meas Guidance v05r02

All test items have been performed as a reference to the above KDB test guidance.

4 Test Types and Results

4.1 Radiated Emission and Bandedge Measurement

4.1.1 Limits of Radiated Emission and Bandedge Measurement

Radiated emissions which fall in the restricted bands must comply with the radiated emission limits specified as below table. Other emissions shall be at least 20 dB below the highest level of the desired power:

Frequencies (MHz)	Field Strength (microvolts/meter)	Measurement Distance (meters)
0.009 ~ 0.490	2400/F (kHz)	300
0.490 ~ 1.705	24000/F (kHz)	30
1.705 ~ 30.0	30	30
30 ~ 88	100	3
88 ~ 216	150	3
216 ~ 960	200	3
Above 960	500	3

Note:

- a. The lower limit shall apply at the transition frequencies.
- b. Emission level (dBuV/m) = 20 log Emission level (uV/m).
- c. For frequencies above 1000 MHz, the field strength limits are based on average detector, however, the peak field strength of any emission shall not exceed the maximum permitted average limits, specified above by more than 20 dB under any condition of modulation.

4.1.2 Test Instruments

Description & Manufacturer	Model No.	Serial No.	Date of Calibration	Due Date of Calibration
Test Receiver Agilent	N9038A	MY51210203	Mar. 18, 2020	Mar. 17, 2021
Spectrum Analyzer Agilent	N9010A	MY52220314	Dec. 12, 2019	Dec. 11, 2020
Spectrum Analyzer ROHDE & SCHWARZ	FSU43	101261	Apr. 16, 2020	Apr. 15, 2021
Spectrum Analyzer ROHDE & SCHWARZ	FSV40	100980	Apr. 20, 2020	Apr. 19, 2021
HORN Antenna SCHWARZBECK	BBHA 9120D	9120D-969	Nov. 24, 2019	Nov. 23, 2020
BILOG Antenna SCHWARZBECK	VULB 9168	9168-472	Nov. 08, 2019	Nov. 07, 2020
Fixed Attenuator WOKEN	MDCS18N-10	MDCS18N-10-01	Apr. 14, 2020	Apr. 13, 2021
Loop Antenna	EM-6879	269	Sep. 17, 2020	Sep. 16, 2021
Preamplifier EMCI	EMC001340	980201	Oct. 21, 2020	Oct. 20, 2021
Bluetooth Tester	CBT	100946	Aug. 06, 2020	Aug. 05, 2022
Preamplifier EMCI	EMC 012645	980115	Oct. 07, 2020	Oct. 06, 2021
Preamplifier EMCI	EMC 184045	980116	Oct. 07, 2020	Oct. 06, 2021
Preamplifier EMCI	EMC 330H	980112	Oct. 07, 2020	Oct. 06, 2021
Power Meter Anritsu	ML2495A	1012010	Sep. 01, 2020	Aug. 31, 2021
Power Sensor Anritsu	MA2411B	1315050	Sep. 01, 2020	Aug. 31, 2021
RF Coaxial Cable EMCI	EMC104-SM-SM-80 00	171005	Oct. 07, 2020	Oct. 06, 2021
RF Coaxial Cable HUBER+SUHNNER	SUCOFLEX 104	EMC104-SM-SM-10 00(140807)	Oct. 07, 2020	Oct. 06, 2021
RF Coaxial Cable WOKEN	8D-FB	Cable-Ch10-01	Oct. 07, 2020	Oct. 06, 2021
Boresight Antenna Fixture	FBA-01	FBA-SIP01	NA	NA
Software BV ADT	E3 6.120103	NA	NA	NA
Antenna Tower MF	MFA-440H	NA	NA	NA
Turn Table MF	MFT-201SS	NA	NA	NA
Antenna Tower & Turn Table Controller MF	MF-7802	NA	NA	NA
USB Wideband Power Sensor KEYSIGHT	U2021XA	MY55050005/MY551 90004/MY55190007/ MY55210005	Jul. 13, 2020	Jul. 12, 2021

Note: 1. The calibration interval of the above test instruments is 12 / 24 months and the calibrations are traceable to NML/ROC and NIST/USA.

2. The test was performed in HwaYa Chamber 10.

4.1.3 Test Procedures

For Radiated Emission below 30 MHz

- a. The EUT was placed on the top of a rotating table 0.8 meters above the ground at a 3 meter chamber room. The table was rotated 360 degrees to determine the position of the highest radiation.
- b. The EUT was set 3 meters away from the interference-receiving antenna, which was mounted on the top of a variable-height antenna tower.
- c. Parallel, perpendicular, and ground-parallel orientations of the antenna are set to make the measurement.
- d. For each suspected emission, the EUT was arranged to its worst case and the rotatable table was turned from 0 degrees to 360 degrees to find the maximum reading.
- e. The test-receiver system was set to Quasi-Peak Detect Function and Specified Bandwidth with Maximum Hold Mode.

Note:

1. The resolution bandwidth and video bandwidth of test receiver/spectrum analyzer is 9 kHz at frequency below 30 MHz.

For Radiated Emission above 30 MHz

- a. The EUT was placed on the top of a rotating table 0.8 meters (for 30 MHz ~ 1 GHz) / 1.5 meters (for above 1 GHz) above the ground at 3 meter chamber room for test. The table was rotated 360 degrees to determine the position of the highest radiation.
- b. The EUT was set 3 meters away from the interference-receiving antenna, which was mounted on the top of a variable-height antenna tower.
- c. The height of antenna is varied from one meter to four meters above the ground to determine the maximum value of the field strength. Both horizontal and vertical polarizations of the antenna are set to make the measurement.
- d. For each suspected emission, the EUT was arranged to its worst case and then the antenna was tuned to heights from 1 meter to 4 meters and the rotatable table was turned from 0 degrees to 360 degrees to find the maximum reading.
- e. The test-receiver system was set to quasi-peak detect function and specified bandwidth with maximum hold mode when the test frequency is below 1 GHz.
- f. The test-receiver system was set to peak and average detected function and specified bandwidth with maximum hold mode when the test frequency is above 1 GHz. If the peak reading value also meets average limit, measurement with the average detector is unnecessary.

Note:

1. The resolution bandwidth and video bandwidth of test receiver/spectrum analyzer is 120 kHz for Quasi-peak detection (QP) or Peak detection (PK) at frequency below 1 GHz.
2. The resolution bandwidth of test receiver/spectrum analyzer is 1 MHz and the video bandwidth is 3 MHz for Peak detection (PK) and Average detection (AV) at frequency above 1 GHz. For fundamental and harmonic signal measurement, according to ANSI C63.10 section 7.5, the average value = peak value + duty cycle correction factor. The duty cycle correction factor refer to Chapter 3.3 of this report.
3. All modes of operation were investigated and the worst-case emissions are reported.

4.1.4 Deviation from Test Standard

No deviation.

4.1.5 Test Set Up

<Radiated Emission below 30 MHz>

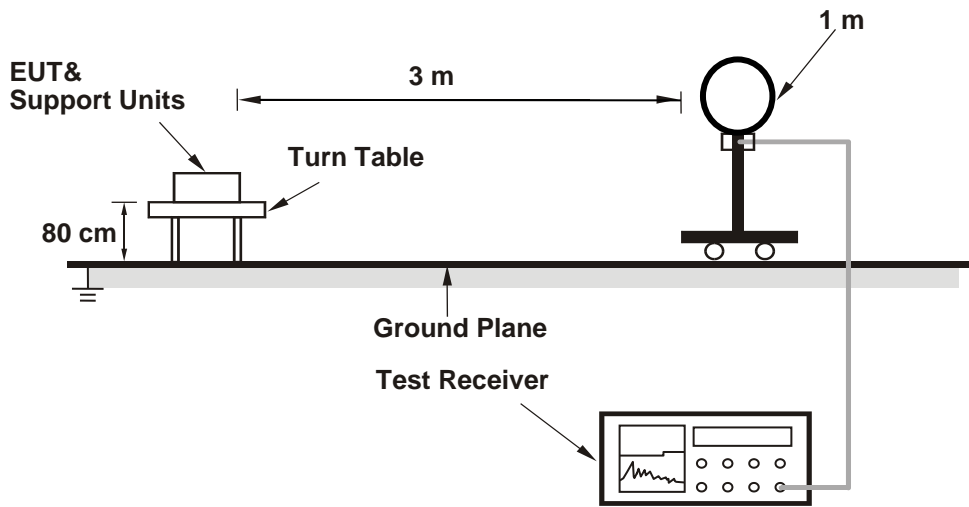

<Radiated Emission 30 MHz to 1 GHz>

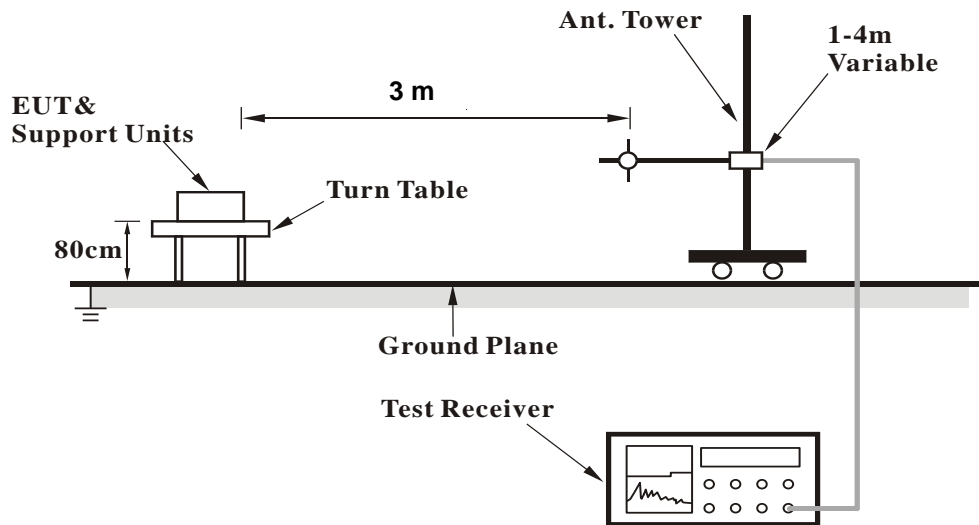

<Radiated Emission above 1 GHz>

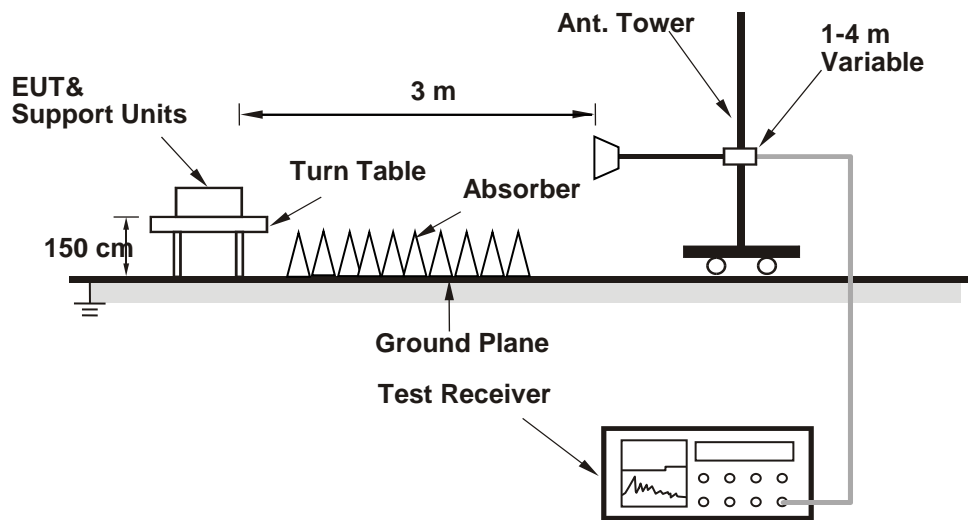

For the actual test configuration, please refer to the attached file (Test Setup Photo).

4.1.6 EUT Operating Conditions

Set the EUT under transmission condition continuously at specific channel frequency.

4.1.7 Test Results

Above 1 GHz Data:
Mode A
GFSK

EUT Test Condition		Measurement Detail	
Channel	Channel 0	Frequency Range	1 GHz ~ 25 GHz
Input Power	120 Vac, 60 Hz	Detector Function	Peak (PK) Average (AV)
Environmental Conditions	25 deg. C, 65 % RH	Tested By	Getaz Yang

Antenna Polarity & Test Distance: Horizontal at 3 m								
Frequency (MHz)	Emission Level (dBuV/m)	Read Level (dBuV)	Factor (dB/m)	Limit (dBuV/m)	Margin (dB)	Antenna Height (cm)	Table Angle (Degree)	Remark
2390	43.68	12.08	31.6	54	-10.32	181	40	Average
2390	45.25	51.17	-5.92	74	-28.75	181	40	Peak
2402	64	69.94	-5.94	-----	-----	181	40	Average
2402	94.75	100.69	-5.94	-----	-----	181	40	Peak
4804	11.25	26.89	-15.64	54	-42.75	123	139	Average
4804	42	57.64	-15.64	74	-32	123	139	Peak
Antenna Polarity & Test Distance: Vertical at 3 m								
Frequency (MHz)	Emission Level (dBuV/m)	Read Level (dBuV)	Factor (dB/m)	Limit (dBuV/m)	Margin (dB)	Antenna Height (cm)	Table Angle (Degree)	Remark
2390	43.78	12.18	31.6	54	-10.22	116	72	Average
2390	45.54	51.46	-5.92	74	-28.46	116	72	Peak
2402	64.86	70.8	-5.94	-----	-----	116	72	Average
2402	95.61	101.55	-5.94	-----	-----	116	72	Peak
4804	12.01	27.65	-15.64	54	-41.99	133	179	Average
4804	42.76	58.4	-15.64	74	-31.24	133	179	Peak

Remarks:

- Emission Level = Read Level + Factor
Margin value = Emission level – Limit value
- 2402 MHz: Fundamental frequency.
- The emission levels of other frequencies were very low against the limit.

EUT Test Condition		Measurement Detail	
Channel	Channel 39	Frequency Range	1 GHz ~ 25 GHz
Input Power	120 Vac, 60 Hz	Detector Function	Peak (PK) Average (AV)
Environmental Conditions	25 deg. C, 65 % RH	Tested By	Getaz Yang

Antenna Polarity & Test Distance: Horizontal at 3 m								
Frequency (MHz)	Emission Level (dBuV/m)	Read Level (dBuV)	Factor (dB/m)	Limit (dBuV/m)	Margin (dB)	Antenna Height (cm)	Table Angle (Degree)	Remark
2441	63.89	69.7	-5.81	-----	-----	176	41	Average
2441	94.64	100.45	-5.81	-----	-----	176	41	Peak
4882	9.35	24.91	-15.56	54	-44.65	120	132	Average
4882	40.1	55.66	-15.56	74	-33.9	120	132	Peak
Antenna Polarity & Test Distance: Vertical at 3 m								
Frequency (MHz)	Emission Level (dBuV/m)	Read Level (dBuV)	Factor (dB/m)	Limit (dBuV/m)	Margin (dB)	Antenna Height (cm)	Table Angle (Degree)	Remark
2441	66.56	72.37	-5.81	-----	-----	110	68	Average
2441	97.31	103.12	-5.81	-----	-----	110	68	Peak
4882	10.95	26.51	-15.56	54	-43.05	138	196	Average
4882	41.7	57.26	-15.56	74	-32.3	138	196	Peak

Remarks:

- Emission Level = Read Level + Factor
Margin value = Emission level – Limit value
- 2441 MHz: Fundamental frequency.
- The emission levels of other frequencies were very low against the limit.

EUT Test Condition		Measurement Detail	
Channel	Channel 78	Frequency Range	1 GHz ~ 25 GHz
Input Power	120 Vac, 60 Hz	Detector Function	Peak (PK) Average (AV)
Environmental Conditions	25 deg. C, 65 % RH	Tested By	Getaz Yang

Antenna Polarity & Test Distance: Horizontal at 3 m								
Frequency (MHz)	Emission Level (dBuV/m)	Read Level (dBuV)	Factor (dB/m)	Limit (dBuV/m)	Margin (dB)	Antenna Height (cm)	Table Angle (Degree)	Remark
2480	67.63	73.33	-5.7	-----	-----	189	41	Average
2480	98.38	104.08	-5.7	-----	-----	189	41	Peak
2483.5	16.91	22.61	-5.7	54	-37.09	189	41	Average
2483.5	47.66	53.36	-5.7	74	-26.34	189	41	Peak
4960	10.48	25.93	-15.45	54	-43.52	122	115	Average
4960	41.23	56.68	-15.45	74	-32.77	122	115	Peak
Antenna Polarity & Test Distance: Vertical at 3 m								
Frequency (MHz)	Emission Level (dBuV/m)	Read Level (dBuV)	Factor (dB/m)	Limit (dBuV/m)	Margin (dB)	Antenna Height (cm)	Table Angle (Degree)	Remark
2480	70.68	76.38	-5.7	-----	-----	112	69	Average
2480	101.43	107.13	-5.7	-----	-----	112	69	Peak
2483.5	18.59	24.29	-5.7	54	-35.41	112	69	Average
2483.5	49.34	55.04	-5.7	74	-24.66	112	69	Peak
4960	11.26	26.71	-15.45	54	-42.74	141	169	Average
4960	42.01	57.46	-15.45	74	-31.99	141	169	Peak

Remarks:

- Emission Level = Read Level + Factor
Margin value = Emission level – Limit value
- 2480 MHz: Fundamental frequency.
- The emission levels of other frequencies were very low against the limit.

8DPSK

EUT Test Condition		Measurement Detail	
Channel	Channel 0	Frequency Range	1 GHz ~ 25 GHz
Input Power	120 Vac, 60 Hz	Detector Function	Peak (PK) Average (AV)
Environmental Conditions	25 deg. C, 65 % RH	Tested By	Getaz Yang

Antenna Polarity & Test Distance: Horizontal at 3 m								
Frequency (MHz)	Emission Level (dBuV/m)	Read Level (dBuV)	Factor (dB/m)	Limit (dBuV/m)	Margin (dB)	Antenna Height (cm)	Table Angle (Degree)	Remark
2390	43.43	11.83	31.6	54	-10.57	180	41	Average
2390	45.68	51.6	-5.92	74	-28.32	180	41	Peak
2402	66.01	71.95	-5.94	-----	-----	180	41	Average
2402	96.76	102.7	-5.94	-----	-----	180	41	Peak
4804	11.01	26.65	-15.64	54	-42.99	132	134	Average
4804	41.76	57.4	-15.64	74	-32.24	132	134	Peak
Antenna Polarity & Test Distance: Vertical at 3 m								
Frequency (MHz)	Emission Level (dBuV/m)	Read Level (dBuV)	Factor (dB/m)	Limit (dBuV/m)	Margin (dB)	Antenna Height (cm)	Table Angle (Degree)	Remark
2390	43.59	11.99	31.6	54	-10.41	114	67	Average
2390	45.36	51.28	-5.92	74	-28.64	114	67	Peak
2402	66.79	72.73	-5.94	-----	-----	114	67	Average
2402	97.54	103.48	-5.94	-----	-----	114	67	Peak
4804	10.4	26.04	-15.64	54	-43.6	138	173	Average
4804	41.15	56.79	-15.64	74	-32.85	138	173	Peak

Remarks:

- Emission Level = Read Level + Factor
Margin value = Emission level – Limit value
- 2402 MHz: Fundamental frequency.
- The emission levels of other frequencies were very low against the limit.

EUT Test Condition		Measurement Detail	
Channel	Channel 39	Frequency Range	1 GHz ~ 25 GHz
Input Power	120 Vac, 60 Hz	Detector Function	Peak (PK) Average (AV)
Environmental Conditions	25 deg. C, 65 % RH	Tested By	Getaz Yang

Antenna Polarity & Test Distance: Horizontal at 3 m								
Frequency (MHz)	Emission Level (dBuV/m)	Read Level (dBuV)	Factor (dB/m)	Limit (dBuV/m)	Margin (dB)	Antenna Height (cm)	Table Angle (Degree)	Remark
2441	65.69	71.5	-5.81	-----	-----	177	40	Average
2441	96.44	102.25	-5.81	-----	-----	177	40	Peak
4882	11.49	27.05	-15.56	54	-42.51	120	120	Average
4882	42.24	57.8	-15.56	74	-31.76	120	120	Peak
Antenna Polarity & Test Distance: Vertical at 3 m								
Frequency (MHz)	Emission Level (dBuV/m)	Read Level (dBuV)	Factor (dB/m)	Limit (dBuV/m)	Margin (dB)	Antenna Height (cm)	Table Angle (Degree)	Remark
2441	68.24	74.05	-5.81	-----	-----	110	71	Average
2441	98.99	104.8	-5.81	-----	-----	110	71	Peak
4882	12.52	28.08	-15.56	54	-41.48	135	188	Average
4882	43.27	58.83	-15.56	74	-30.73	135	188	Peak

Remarks:

- Emission Level = Read Level + Factor
Margin value = Emission level – Limit value
- 2441 MHz: Fundamental frequency.
- The emission levels of other frequencies were very low against the limit.

EUT Test Condition		Measurement Detail	
Channel	Channel 78	Frequency Range	1 GHz ~ 25 GHz
Input Power	120 Vac, 60 Hz	Detector Function	Peak (PK) Average (AV)
Environmental Conditions	25 deg. C, 65 % RH	Tested By	Getaz Yang

Antenna Polarity & Test Distance: Horizontal at 3 m								
Frequency (MHz)	Emission Level (dBuV/m)	Read Level (dBuV)	Factor (dB/m)	Limit (dBuV/m)	Margin (dB)	Antenna Height (cm)	Table Angle (Degree)	Remark
2480	69.51	75.21	-5.7	-----	-----	182	40	Average
2480	100.26	105.96	-5.7	-----	-----	182	40	Peak
2483.5	17.49	23.19	-5.7	54	-36.51	182	40	Average
2483.5	48.24	53.94	-5.7	74	-25.76	182	40	Peak
4960	10.73	26.18	-15.45	54	-43.27	118	124	Average
4960	41.48	56.93	-15.45	74	-32.52	118	124	Peak
Antenna Polarity & Test Distance: Vertical at 3 m								
Frequency (MHz)	Emission Level (dBuV/m)	Read Level (dBuV)	Factor (dB/m)	Limit (dBuV/m)	Margin (dB)	Antenna Height (cm)	Table Angle (Degree)	Remark
2480	72.26	77.96	-5.7	-----	-----	111	68	Average
2480	103.01	108.71	-5.7	-----	-----	111	68	Peak
2483.5	19.04	24.74	-5.7	54	-34.96	111	68	Average
2483.5	49.79	55.49	-5.7	74	-24.21	111	68	Peak
4960	11.4	26.85	-15.45	54	-42.6	144	177	Average
4960	42.15	57.6	-15.45	74	-31.85	144	177	Peak

Remarks:

- Emission Level = Read Level + Factor
Margin value = Emission level – Limit value
- 2480 MHz: Fundamental frequency.
- The emission levels of other frequencies were very low against the limit.

Mode B
GFSK

EUT Test Condition		Measurement Detail	
Channel	Channel 0	Frequency Range	1 GHz ~ 25 GHz
Input Power	120 Vac, 60 Hz	Detector Function	Peak (PK) Average (AV)
Environmental Conditions	25 deg. C, 65 % RH	Tested By	Cyril Chen

Antenna Polarity & Test Distance: Horizontal at 3 m

Frequency (MHz)	Emission Level (dBuV/m)	Read Level (dBuV)	Factor (dB/m)	Limit (dBuV/m)	Margin (dB)	Antenna Height (cm)	Table Angle (Degree)	Remark
2390	42.72	11.12	31.6	54	-11.28	132	6	Average
2390	45.35	51.27	-5.92	74	-28.65	132	6	Peak
2402	72.59	78.53	-5.94	-----	-----	132	6	Average
2402	103.35	109.29	-5.94	-----	-----	132	6	Peak
4804	11.71	27.35	-15.64	54	-42.29	181	122	Average
4804	42.47	58.11	-15.64	74	-31.53	181	122	Peak

Antenna Polarity & Test Distance: Vertical at 3 m

Frequency (MHz)	Emission Level (dBuV/m)	Read Level (dBuV)	Factor (dB/m)	Limit (dBuV/m)	Margin (dB)	Antenna Height (cm)	Table Angle (Degree)	Remark
2390	43.98	12.38	31.6	54	-10.02	266	4	Average
2390	45.85	51.77	-5.92	74	-28.15	266	4	Peak
2402	70.32	76.26	-5.94	-----	-----	266	4	Average
2402	101.08	107.02	-5.94	-----	-----	266	4	Peak
4804	11.3	26.94	-15.64	54	-42.7	126	184	Average
4804	42.06	57.7	-15.64	74	-31.94	126	184	Peak

Remarks:

- Emission Level = Read Level + Factor
Margin value = Emission level – Limit value
- 2402 MHz: Fundamental frequency.
- The emission levels of other frequencies were very low against the limit.

EUT Test Condition		Measurement Detail	
Channel	Channel 39	Frequency Range	1 GHz ~ 25 GHz
Input Power	120 Vac, 60 Hz	Detector Function	Peak (PK) Average (AV)
Environmental Conditions	25 deg. C, 65 % RH	Tested By	Cyril Chen

Antenna Polarity & Test Distance: Horizontal at 3 m								
Frequency (MHz)	Emission Level (dBuV/m)	Read Level (dBuV)	Factor (dB/m)	Limit (dBuV/m)	Margin (dB)	Antenna Height (cm)	Table Angle (Degree)	Remark
2441	72.54	78.35	-5.81	-----	-----	146	12	Average
2441	103.3	109.11	-5.81	-----	-----	146	12	Peak
4882	12.04	27.6	-15.56	54	-41.96	179	175	Average
4882	42.8	58.36	-15.56	74	-31.2	179	175	Peak
Antenna Polarity & Test Distance: Vertical at 3 m								
Frequency (MHz)	Emission Level (dBuV/m)	Read Level (dBuV)	Factor (dB/m)	Limit (dBuV/m)	Margin (dB)	Antenna Height (cm)	Table Angle (Degree)	Remark
2441	70.48	76.29	-5.81	-----	-----	276	3	Average
2441	101.24	107.05	-5.81	-----	-----	276	3	Peak
4882	10.26	25.82	-15.56	54	-43.74	127	189	Average
4882	41.05	56.61	-15.56	74	-32.95	127	189	Peak

Remarks:

- Emission Level = Read Level + Factor
Margin value = Emission level – Limit value
- 2441 MHz: Fundamental frequency.
- The emission levels of other frequencies were very low against the limit.

EUT Test Condition		Measurement Detail	
Channel	Channel 78	Frequency Range	1 GHz ~ 25 GHz
Input Power	120 Vac, 60 Hz	Detector Function	Peak (PK) Average (AV)
Environmental Conditions	25 deg. C, 65 % RH	Tested By	Cyril Chen

Antenna Polarity & Test Distance: Horizontal at 3 m								
Frequency (MHz)	Emission Level (dBuV/m)	Read Level (dBuV)	Factor (dB/m)	Limit (dBuV/m)	Margin (dB)	Antenna Height (cm)	Table Angle (Degree)	Remark
2480	70.64	76.34	-5.7	-----	-----	126	13	Average
2480	101.4	107.1	-5.7	-----	-----	126	13	Peak
2483.5	17.57	23.27	-5.7	54	-36.43	126	13	Average
2483.5	48.33	54.03	-5.7	74	-25.67	126	13	Peak
4960	11.57	27.02	-15.45	54	-42.43	168	161	Average
4960	42.34	57.79	-15.45	74	-31.66	168	161	Peak
Antenna Polarity & Test Distance: Vertical at 3 m								
Frequency (MHz)	Emission Level (dBuV/m)	Read Level (dBuV)	Factor (dB/m)	Limit (dBuV/m)	Margin (dB)	Antenna Height (cm)	Table Angle (Degree)	Remark
2480	68.78	74.48	-5.7	-----	-----	261	3	Average
2480	99.54	105.24	-5.7	-----	-----	261	3	Peak
2483.5	16.91	22.61	-5.7	54	-37.09	261	3	Average
2483.5	47.67	53.37	-5.7	74	-26.33	261	3	Peak
4960	10.88	26.33	-15.45	54	-43.12	130	158	Average
4960	41.64	57.09	-15.45	74	-32.36	130	158	Peak

Remarks:

- Emission Level = Read Level + Factor
Margin value = Emission level – Limit value
- 2480 MHz: Fundamental frequency.
- The emission levels of other frequencies were very low against the limit.

8DPSK

EUT Test Condition		Measurement Detail	
Channel	Channel 0	Frequency Range	1 GHz ~ 25 GHz
Input Power	120 Vac, 60 Hz	Detector Function	Peak (PK) Average (AV)
Environmental Conditions	25 deg. C, 65 % RH	Tested By	Cyril Chen

Antenna Polarity & Test Distance: Horizontal at 3 m

Frequency (MHz)	Emission Level (dBuV/m)	Read Level (dBuV)	Factor (dB/m)	Limit (dBuV/m)	Margin (dB)	Antenna Height (cm)	Table Angle (Degree)	Remark
2390	45.8	14.2	31.6	54	-8.2	113	5	Average
2390	46.04	51.96	-5.92	74	-27.96	113	5	Peak
2402	71.97	77.91	-5.94	-----	-----	113	5	Average
2402	102.64	108.58	-5.94	-----	-----	113	5	Peak
4804	11.73	27.37	-15.64	54	-42.27	131	149	Average
4804	42.49	58.13	-15.64	74	-31.51	131	149	Peak

Antenna Polarity & Test Distance: Vertical at 3 m

Frequency (MHz)	Emission Level (dBuV/m)	Read Level (dBuV)	Factor (dB/m)	Limit (dBuV/m)	Margin (dB)	Antenna Height (cm)	Table Angle (Degree)	Remark
2390	42.65	11.05	31.6	54	-11.35	224	14	Average
2390	45.68	51.6	-5.92	74	-28.32	224	14	Peak
2402	66.27	72.21	-5.94	-----	-----	224	14	Average
2402	97.03	102.97	-5.94	-----	-----	224	14	Peak
4804	10.97	26.61	-15.64	54	-43.03	157	263	Average
4804	41.73	57.37	-15.64	74	-32.27	157	263	Peak

Remarks:

- Emission Level = Read Level + Factor
Margin value = Emission level – Limit value
- 2402 MHz: Fundamental frequency.
- The emission levels of other frequencies were very low against the limit.

EUT Test Condition		Measurement Detail	
Channel	Channel 39	Frequency Range	1 GHz ~ 25 GHz
Input Power	120 Vac, 60 Hz	Detector Function	Peak (PK) Average (AV)
Environmental Conditions	25 deg. C, 65 % RH	Tested By	Cyril Chen

Antenna Polarity & Test Distance: Horizontal at 3 m								
Frequency (MHz)	Emission Level (dBuV/m)	Read Level (dBuV)	Factor (dB/m)	Limit (dBuV/m)	Margin (dB)	Antenna Height (cm)	Table Angle (Degree)	Remark
2441	70.93	76.74	-5.81	-----	-----	116	16	Average
2441	101.69	107.5	-5.81	-----	-----	116	16	Peak
4882	11.78	27.34	-15.56	54	-42.22	161	138	Average
4882	42.54	58.1	-15.56	74	-31.46	161	138	Peak
Antenna Polarity & Test Distance: Vertical at 3 m								
Frequency (MHz)	Emission Level (dBuV/m)	Read Level (dBuV)	Factor (dB/m)	Limit (dBuV/m)	Margin (dB)	Antenna Height (cm)	Table Angle (Degree)	Remark
2441	66.75	72.56	-5.81	-----	-----	232	11	Average
2441	97.51	103.32	-5.81	-----	-----	232	11	Peak
4882	11.61	27.17	-15.56	54	-42.39	163	181	Average
4882	42.37	57.93	-15.56	74	-31.63	163	181	Peak

Remarks:

- Emission Level = Read Level + Factor
Margin value = Emission level – Limit value
- 2441 MHz: Fundamental frequency.
- The emission levels of other frequencies were very low against the limit.

EUT Test Condition		Measurement Detail	
Channel	Channel 78	Frequency Range	1 GHz ~ 25 GHz
Input Power	120 Vac, 60 Hz	Detector Function	Peak (PK) Average (AV)
Environmental Conditions	25 deg. C, 65 % RH	Tested By	Cyril Chen

Antenna Polarity & Test Distance: Horizontal at 3 m								
Frequency (MHz)	Emission Level (dBuV/m)	Read Level (dBuV)	Factor (dB/m)	Limit (dBuV/m)	Margin (dB)	Antenna Height (cm)	Table Angle (Degree)	Remark
2480	69.59	75.29	-5.7	-----	-----	128	14	Average
2480	100.35	106.05	-5.7	-----	-----	128	14	Peak
2483.5	17.31	23.01	-5.7	54	-36.69	128	14	Average
2483.5	48.07	53.77	-5.7	74	-25.93	128	14	Peak
4960	12.15	27.6	-15.45	54	-41.85	185	186	Average
4960	42.91	58.36	-15.45	74	-31.09	185	186	Peak
Antenna Polarity & Test Distance: Vertical at 3 m								
Frequency (MHz)	Emission Level (dBuV/m)	Read Level (dBuV)	Factor (dB/m)	Limit (dBuV/m)	Margin (dB)	Antenna Height (cm)	Table Angle (Degree)	Remark
2480	68.72	74.42	-5.7	-----	-----	272	4	Average
2480	99.48	105.18	-5.7	-----	-----	272	4	Peak
2483.5	17.49	23.19	-5.7	54	-36.51	272	4	Average
2483.5	48.25	53.95	-5.7	74	-25.75	272	4	Peak
4960	11.47	26.92	-15.45	54	-42.53	138	176	Average
4960	42.23	57.68	-15.45	74	-31.77	138	176	Peak

Remarks:

- Emission Level = Read Level + Factor
Margin value = Emission level – Limit value
- 2480 MHz: Fundamental frequency.
- The emission levels of other frequencies were very low against the limit.

9 kHz ~ 30 MHz Data:

The amplitude of spurious emissions attenuated more than 20 dB below the permissible value is not required to be report.

30 MHz ~ 1 GHz Worst-Case Data:

Mode A

EUT Test Condition		Measurement Detail	
Channel	Channel 78	Frequency Range	30 MHz ~ 1 GHz
Input Power	120 Vac, 60 Hz	Detector Function	Peak (PK) Quasi-peak (QP)
Environmental Conditions	25 deg. C, 65 % RH	Tested By	Cyril Chen

Horizontal

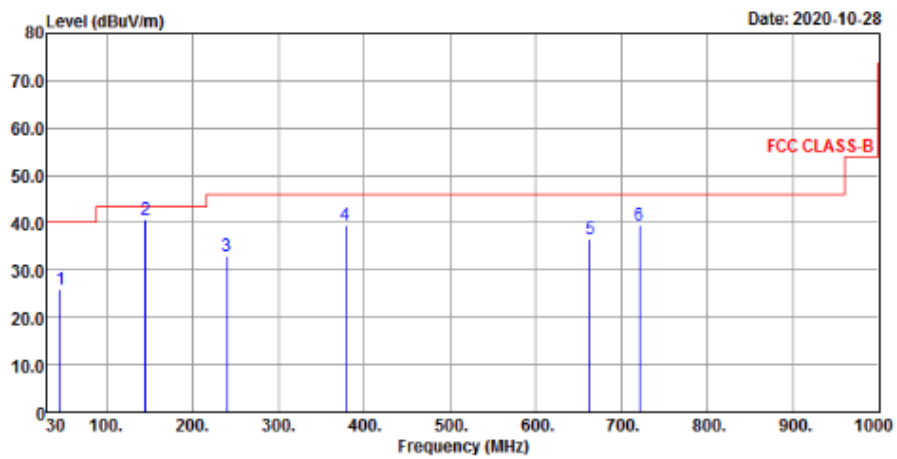

Vertical

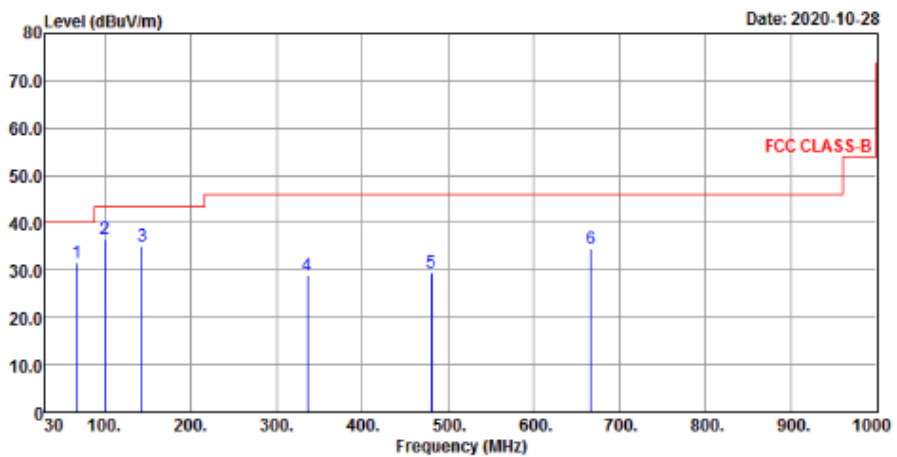

Antenna Polarity & Test Distance: Horizontal at 3 m								
Frequency (MHz)	Emission Level (dBuV/m)	Read Level (dBuV)	Factor (dB/m)	Limit (dBuV/m)	Margin (dB)	Antenna Height (cm)	Table Angle (Degree)	Remark
45.52	26.03	37.81	-11.78	40	-13.97	199	207	QP
144.46	40.8	52.64	-11.84	43.5	-2.7	180	217	QP
239.52	33.13	46.53	-13.4	46	-12.87	132	247	QP
378.23	39.61	48.38	-8.77	46	-6.39	157	263	QP
663.41	36.75	38.17	-1.42	46	-9.25	145	289	QP
720.64	39.55	39.74	-0.19	46	-6.45	168	184	QP
Antenna Polarity & Test Distance: Vertical at 3 m								
Frequency (MHz)	Emission Level (dBuV/m)	Read Level (dBuV)	Factor (dB/m)	Limit (dBuV/m)	Margin (dB)	Antenna Height (cm)	Table Angle (Degree)	Remark
66.86	31.51	44.7	-13.19	40	-8.49	196	330	QP
99.84	36.61	52.64	-16.03	43.5	-6.89	133	158	QP
143.49	35.02	46.93	-11.91	43.5	-8.48	198	157	QP
335.55	28.79	38.76	-9.97	46	-17.21	174	133	QP
480.08	29.67	35.48	-5.81	46	-16.33	168	152	QP
666.32	34.62	35.97	-1.35	46	-11.38	121	173	QP

Remarks:

- Emission Level = Read Level + Factor
Margin value = Emission level – Limit value
- The emission levels of other frequencies were very low against the limit.

Mode B

EUT Test Condition		Measurement Detail	
Channel	Channel 78	Frequency Range	30 MHz ~ 1 GHz
Input Power	120 Vac, 60 Hz	Detector Function	Peak (PK) Quasi-peak (QP)
Environmental Conditions	25 deg. C, 65 % RH	Tested By	Cyril Chen

Horizontal

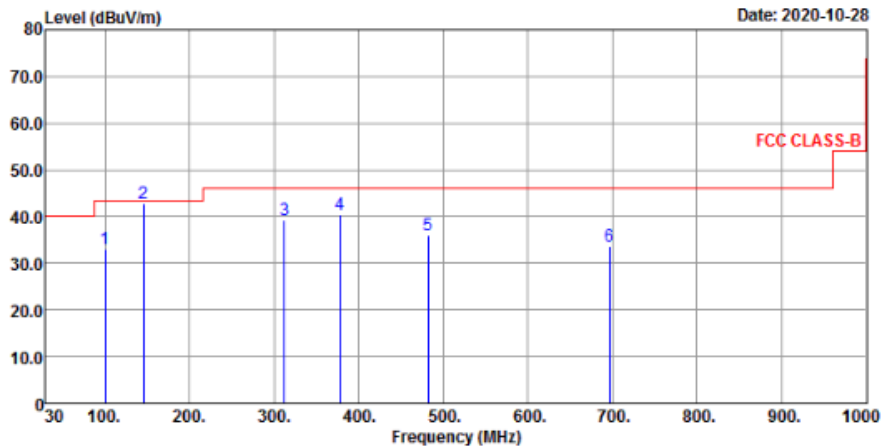

Vertical

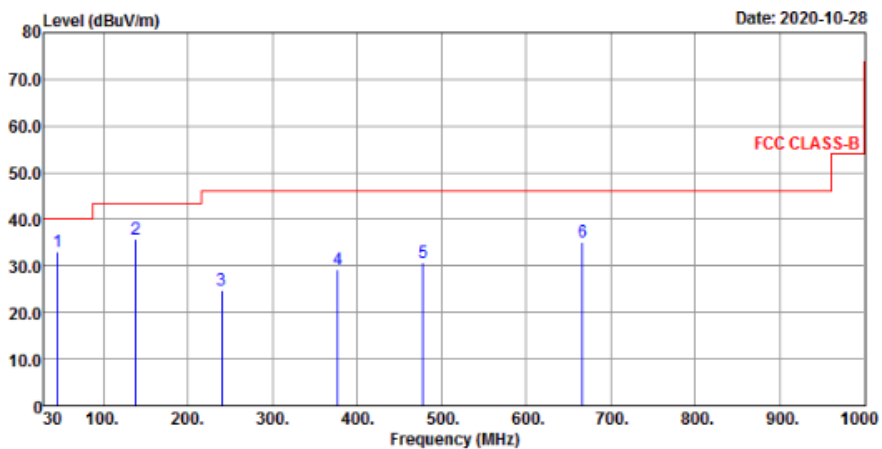

Antenna Polarity & Test Distance: Horizontal at 3 m								
Frequency (MHz)	Emission Level (dBuV/m)	Read Level (dBuV)	Factor (dB/m)	Limit (dBuV/m)	Margin (dB)	Antenna Height (cm)	Table Angle (Degree)	Remark
99.84	32.95	48.98	-16.03	43.5	-10.55	151	214	QP
145.43	42.86	54.66	-11.8	43.5	-0.64	177	194	QP
312.27	39.39	50.09	-10.7	46	-6.61	133	231	QP
378.23	40.38	49.15	-8.77	46	-5.62	155	180	QP
482.02	35.89	41.69	-5.8	46	-10.11	105	124	QP
696.39	33.75	34.46	-0.71	46	-12.25	164	189	QP
Antenna Polarity & Test Distance: Vertical at 3 m								
Frequency (MHz)	Emission Level (dBuV/m)	Read Level (dBuV)	Factor (dB/m)	Limit (dBuV/m)	Margin (dB)	Antenna Height (cm)	Table Angle (Degree)	Remark
45.52	33.03	44.81	-11.78	40	-6.97	128	154	QP
138.64	35.79	47.94	-12.15	43.5	-7.71	177	188	QP
239.52	24.8	38.2	-13.4	46	-21.2	154	231	QP
377.26	29.21	38	-8.79	46	-16.79	118	210	QP
478.14	30.59	36.42	-5.83	46	-15.41	199	201	QP
666.32	35.02	36.37	-1.35	46	-10.98	156	188	QP

Remarks:

- Emission Level = Read Level + Factor
Margin value = Emission level – Limit value
- The emission levels of other frequencies were very low against the limit.

4.2 Conducted Emission Measurement

4.2.1 Limits of Conducted Emission Measurement

Frequency (MHz)	Conducted Limit (dBUV)	
	Quasi-Peak	Average
0.15 - 0.5	66 - 56	56 - 46
0.50 - 5.0	56	46
5.0 - 30.0	60	50

- Note: 1. The lower limit shall apply at the transition frequencies.
 2. The limit decreases in line with the logarithm of the frequency in the range of 0.15 to 0.50 MHz.

4.2.2 Test Instruments

Description & Manufacturer	Model No.	Serial No.	Date of Calibration	Due Date of Calibration
Test Receiver ROHDE & SCHWARZ	ESCI	100613	Dec. 11, 2019	Dec. 10, 2020
RF signal cable Woken	5D-FB	Cable-cond1-01	Sep. 04, 2020	Sep. 03, 2021
LISN ROHDE & SCHWARZ (EUT)	ENV216	101826	Feb. 20, 2020	Feb. 19, 2021
LISN ROHDE & SCHWARZ (Peripheral)	ESH3-Z5	100311	Aug. 28, 2020	Aug. 27, 2021
Software ADT	BV ADT_Cond_ V7.3.7.4	NA	NA	NA

- Note: 1. The calibration interval of the above test instruments is 12 months and the calibrations are traceable to NML/ROC and NIST/USA.
 2. The test was performed in HwaYa Shielded Room 1 (Conduction 1).
 3. The VCCI Site Registration No. is C-12040.

4.2.3 Test Procedures

- The EUT was placed 0.4 meters from the conducting wall of the shielded room with EUT being connected to the power mains through a line impedance stabilization network (LISN). Other support units were connected to the power mains through another LISN. The two LISNs provide 50 ohm/ 50 uH of coupling impedance for the measuring instrument.
- Both lines of the power mains connected to the EUT were checked for maximum conducted interference.
- The frequency range from 150 kHz to 30 MHz was searched. Emission levels under (Limit – 20 dB) was not recorded.

Note: The resolution bandwidth and video bandwidth of test receiver is 9 kHz for quasi-peak detection (QP) and average detection (AV) at frequency 0.15 MHz - 30 MHz.

4.2.4 Deviation from Test Standard

No deviation.

4.2.5 Test Setup

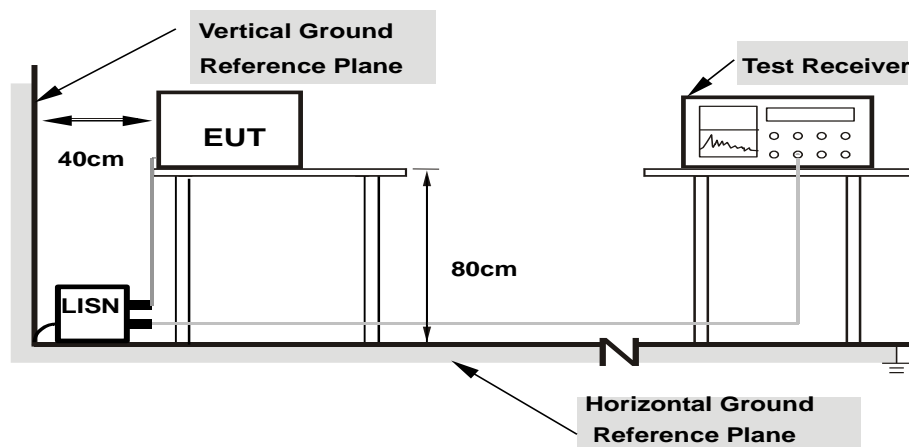

- Note:**
- Support units were connected to second LISN.
 - Both of LISNs (AMN) are 80 cm from EUT and at least 80 cm from other units and other metal planes

For the actual test configuration, please refer to the attached file (Test Setup Photo).

4.2.6 EUT Operating Condition

Set the EUT under transmission condition continuously at specific channel frequency.

4.2.7 Test Results

CONDUCTED WORST-CASE DATA : GFSK

Mode A

Frequency Range	150kHz ~ 30MHz	Detector Function & Resolution Bandwidth	Quasi-Peak (QP) / Average (AV), 9kHz
Input Power	120Vac, 60Hz	Environmental Conditions	25°C, 65%RH
Tested by	Getaz Yang	Test Date	2020/10/27

Phase Of Power : Line (L)										
No	Frequency (MHz)	Correction Factor (dB)	Reading Value (dBuV)		Emission Level (dBuV)		Limit (dBuV)		Margin (dB)	
			Q.P.	AV.	Q.P.	AV.	Q.P.	AV.	Q.P.	AV.
1	0.15782	9.65	32.51	24.19	42.16	33.84	65.58	55.58	-23.42	-21.74
2	0.18508	9.66	31.60	23.26	41.26	32.92	64.25	54.25	-22.99	-21.33
3	0.43924	9.66	31.45	24.67	41.11	34.33	57.08	47.08	-15.97	-12.75
4	1.38556	9.68	26.67	18.48	36.35	28.16	56.00	46.00	-19.65	-17.84
5	2.76579	9.72	26.51	17.99	36.23	27.71	56.00	46.00	-19.77	-18.29
6	18.77333	9.86	15.85	8.54	25.71	18.40	60.00	50.00	-34.29	-31.60

Remarks:

1. Q.P. and AV. are abbreviations of quasi-peak and average individually.
2. The emission levels of other frequencies were very low against the limit.
3. Margin value = Emission level – Limit value
4. Correction factor = Insertion loss + Cable loss
5. Emission Level = Correction Factor + Reading Value

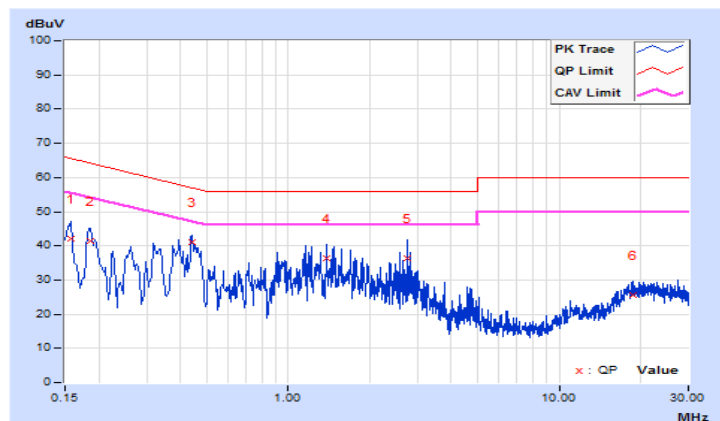

Frequency Range	150kHz ~ 30MHz	Detector Function & Resolution Bandwidth	Quasi-Peak (QP) / Average (AV), 9kHz
Input Power	120Vac, 60Hz	Environmental Conditions	25°C, 65%RH
Tested by	Getaz Yang	Test Date	2020/10/27
Test Mode	Mode 1		

Phase Of Power : Neutral (N)										
No	Frequency (MHz)	Correction Factor (dB)	Reading Value (dBuV)		Emission Level (dBuV)		Limit (dBuV)		Margin (dB)	
			Q.P.	AV.	Q.P.	AV.	Q.P.	AV.	Q.P.	AV.
1	0.20083	9.68	30.94	24.89	40.62	34.57	63.58	53.58	-22.96	-19.01
2	0.25948	9.68	26.78	21.99	36.46	31.67	61.45	51.45	-24.99	-19.78
3	0.45498	9.68	28.96	21.24	38.64	30.92	56.78	46.78	-18.14	-15.86
4	1.22134	9.70	26.56	18.82	36.26	28.52	56.00	46.00	-19.74	-17.48
5	2.76970	9.75	25.83	17.35	35.58	27.10	56.00	46.00	-20.42	-18.90
6	4.56439	9.78	17.86	9.84	27.64	19.62	56.00	46.00	-28.36	-26.38

Remarks:

1. Q.P. and AV. are abbreviations of quasi-peak and average individually.
2. The emission levels of other frequencies were very low against the limit.
3. Margin value = Emission level – Limit value
4. Correction factor = Insertion loss + Cable loss
5. Emission Level = Correction Factor + Reading Value

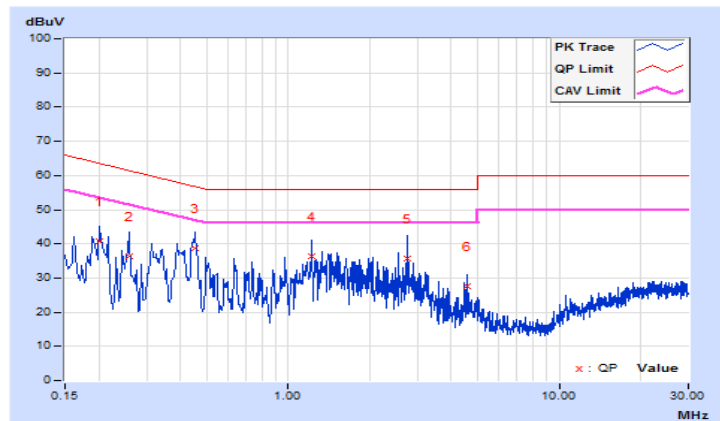

Mode B

Frequency Range	150kHz ~ 30MHz	Detector Function & Resolution Bandwidth	Quasi-Peak (QP) / Average (AV), 9kHz
Input Power	120Vac, 60Hz	Environmental Conditions	25°C, 65%RH
Tested by	Getaz Yang	Test Date	2020/10/28

Phase Of Power : Line (L)										
No	Frequency (MHz)	Correction Factor (dB)	Reading Value (dBuV)		Emission Level (dBuV)		Limit (dBuV)		Margin (dB)	
			Q.P.	AV.	Q.P.	AV.	Q.P.	AV.	Q.P.	AV.
1	0.18903	9.66	34.38	26.08	44.04	35.74	64.08	54.08	-20.04	-18.34
2	0.32595	9.66	27.52	21.29	37.18	30.95	59.55	49.55	-22.37	-18.60
3	0.47039	9.66	27.19	19.47	36.85	29.13	56.51	46.51	-19.66	-17.38
4	1.29563	9.68	24.33	18.05	34.01	27.73	56.00	46.00	-21.99	-18.27
5	2.65629	9.71	23.62	16.07	33.33	25.78	56.00	46.00	-22.67	-20.22
6	19.15651	9.86	15.86	8.10	25.72	17.96	60.00	50.00	-34.28	-32.04

Remarks:

1. Q.P. and AV. are abbreviations of quasi-peak and average individually.
2. The emission levels of other frequencies were very low against the limit.
3. Margin value = Emission level – Limit value
4. Correction factor = Insertion loss + Cable loss
5. Emission Level = Correction Factor + Reading Value

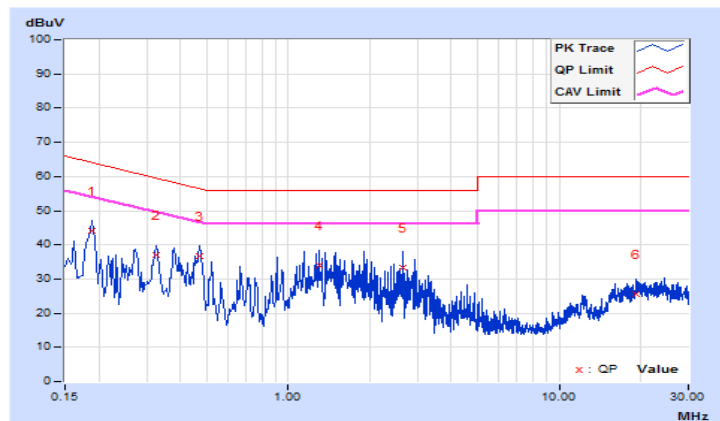

Frequency Range	150kHz ~ 30MHz	Detector Function & Resolution Bandwidth	Quasi-Peak (QP) / Average (AV), 9kHz
Input Power	120Vac, 60Hz	Environmental Conditions	25°C, 65%RH
Tested by	Getaz Yang	Test Date	2020/10/28

Phase Of Power : Neutral (N)										
No	Frequency (MHz)	Correction Factor (dB)	Reading Value (dBuV)		Emission Level (dBuV)		Limit (dBuV)		Margin (dB)	
			Q.P.	AV.	Q.P.	AV.	Q.P.	AV.	Q.P.	AV.
1	0.19301	9.68	33.17	24.36	42.85	34.04	63.91	53.91	-21.06	-19.87
2	0.37678	9.68	26.55	17.37	36.23	27.05	58.35	48.35	-22.12	-21.30
3	0.45889	9.68	28.88	20.46	38.56	30.14	56.71	46.71	-18.15	-16.57
4	1.38165	9.71	25.97	18.18	35.68	27.89	56.00	46.00	-20.32	-18.11
5	2.62503	9.74	26.89	19.62	36.63	29.36	56.00	46.00	-19.37	-16.64
6	23.58654	9.97	15.36	8.18	25.33	18.15	60.00	50.00	-34.67	-31.85

Remarks:

1. Q.P. and AV. are abbreviations of quasi-peak and average individually.
2. The emission levels of other frequencies were very low against the limit.
3. Margin value = Emission level – Limit value
4. Correction factor = Insertion loss + Cable loss
5. Emission Level = Correction Factor + Reading Value

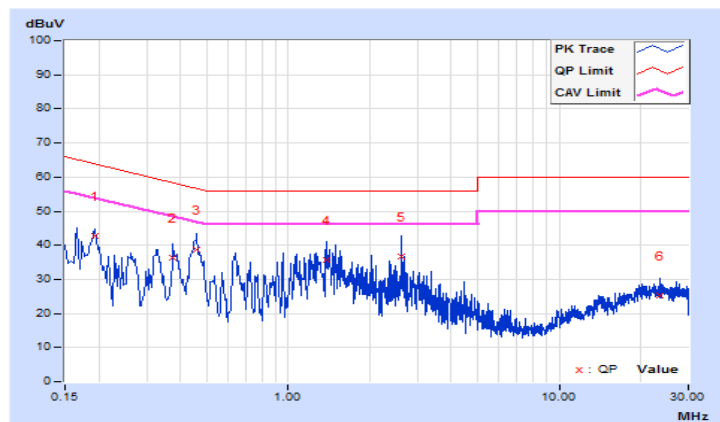

4.3 Number of Hopping Frequency Used

4.3.1 Limits of Hopping Frequency Used Measurement

At least 15 channels frequencies, and should be equally spaced.

4.3.2 Test Setup



4.3.3 Test Instruments

Refer to section 4.1.2 to get information of above instrument.

4.3.4 Test Procedure

- a. Check the calibration of the measuring instrument (SA) using either an internal calibrator or a known signal from an external generator.
- b. Turn on the EUT and connect its antenna terminal to measurement via a low loss cable. Then set it to any one measured frequency within its operating range and make sure the instrument is operated in its linear range.
- c. Set the SA on MaxHold Mode, and then keep the EUT in hopping mode. Record all the signals from each channel until each one has been recorded.
- d. Set the SA on View mode and then plot the result on SA screen.
- e. Repeat above procedures until all frequencies measured were complete.

4.3.5 Deviation from Test Standard

No deviation.

4.3.6 Test Results

There are 79 hopping frequencies in the hopping mode. Please refer to next page for the test result. On the plots, it shows that the hopping frequencies are equally spaced.

<GFSK>

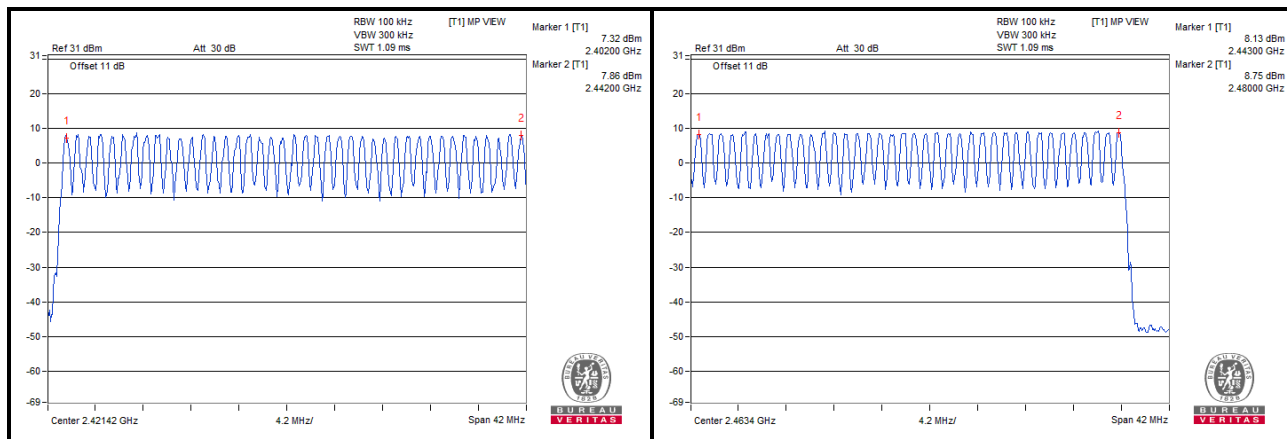

<8DPSK>

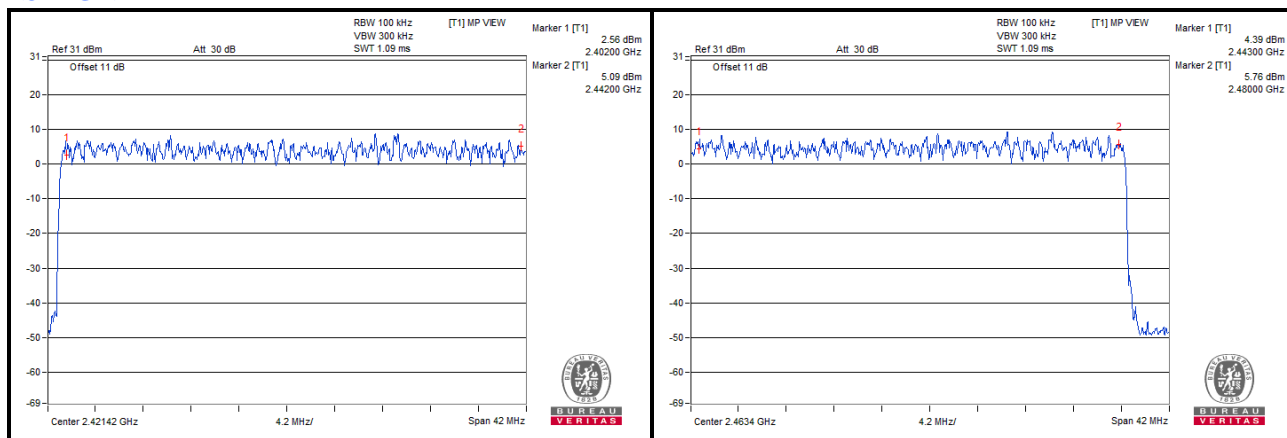

4.4 Dwell Time on Each Channel

4.4.1 Limits of Dwell Time on Each Channel Measurement

The average time of occupancy on any channel shall not be greater than 0.4 seconds within a period of 0.4 seconds multiplied by the number of hopping channels employed.

4.4.2 Test Setup

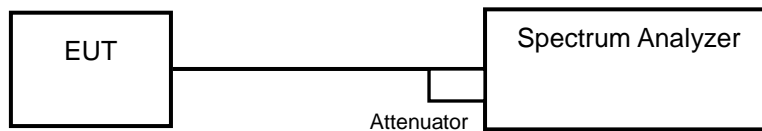

4.4.3 Test Instruments

Refer to section 4.1.2 to get information of above instrument.

4.4.4 Test Procedures

- a. Check the calibration of the measuring instrument (SA) using either an internal calibrator or a known signal from an external generator.
- b. Turn on the EUT and connect its antenna terminal to measurement via a low loss cable. Then set it to any one measured frequency within its operating range and make sure the instrument is operated in its linear range.
- c. Adjust the center frequency of SA on any frequency be measured and set SA to zero span mode. And then, set RBW and VBW of spectrum analyzer to proper value.
- d. Measure the time duration of one transmission on the measured frequency. And then plot the result with time difference of this time duration.
- e. Repeat above procedures until all different time-slot modes have been completed.

4.4.5 Deviation from Test Standard

No deviation.

4.4.6 Test Results

GFSK

Mode	Number of Transmission in a 31.6 (79 Hopping*0.4)	Length of Transmission Time (msec)	Result (msec)	Limit (msec)
DH1	50 (times / 5 sec) * 6.32 = 316 times	0.46	145.36	400
DH3	27 (times / 5 sec) * 6.32 = 171 times	1.71	292.41	400
DH5	16 (times / 5 sec) * 6.32 = 102 times	2.98	303.96	400

Note: Test plots of the transmitting time slot are shown as below.

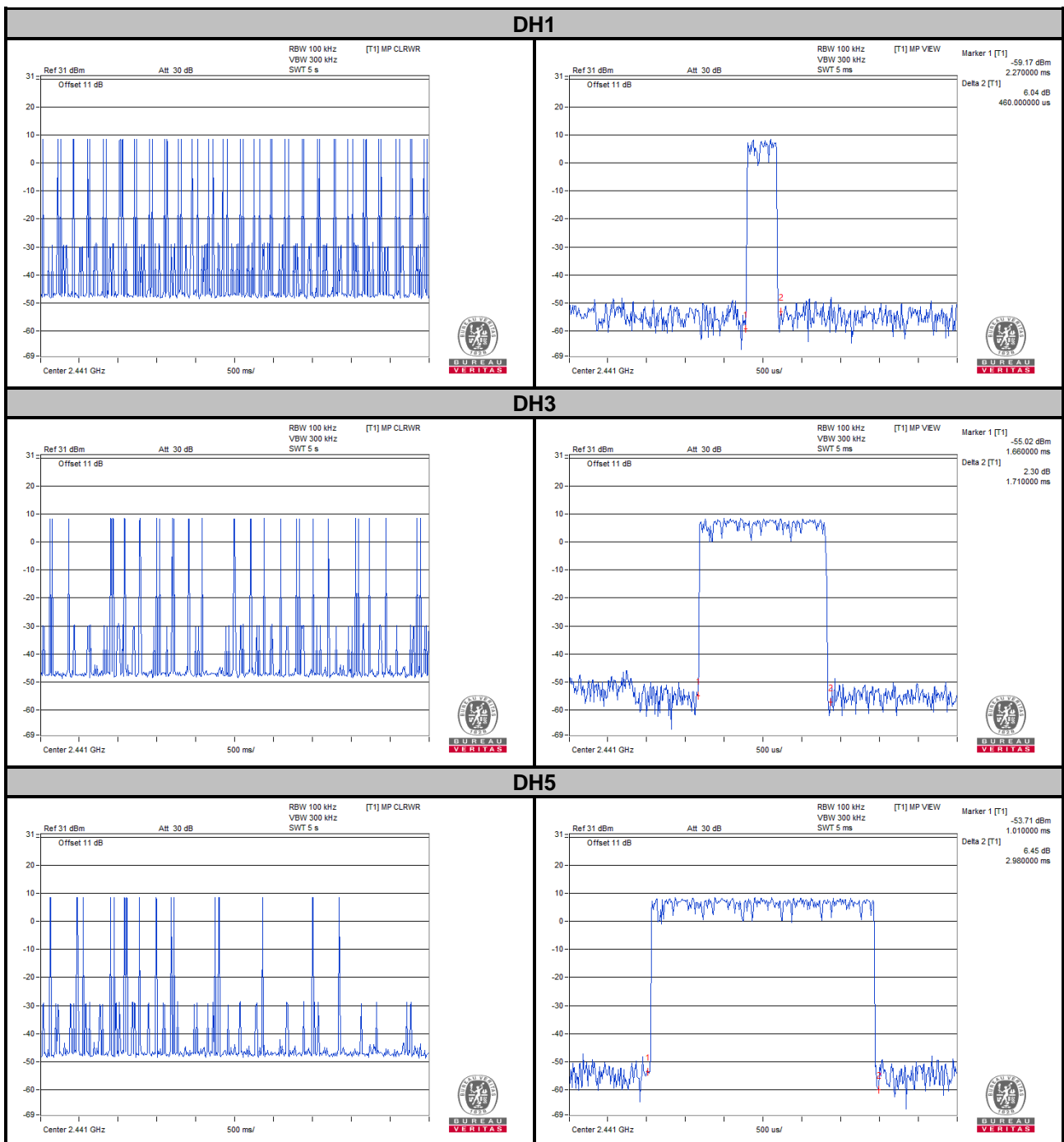

8DPSK

Mode	Number of Transmission in a 31.6 (79 Hopping*0.4)	Length of Transmission Time (msec)	Result (msec)	Limit (msec)
3DH1	50 (times / 5 sec) * 6.32 = 316 times	0.43	135.88	400
3DH3	27 (times / 5 sec) * 6.32 = 171 times	1.68	287.28	400
3DH5	17 (times / 5 sec) * 6.32 = 108 times	2.98	321.84	400

Note: Test plots of the transmitting time slot are shown as below.

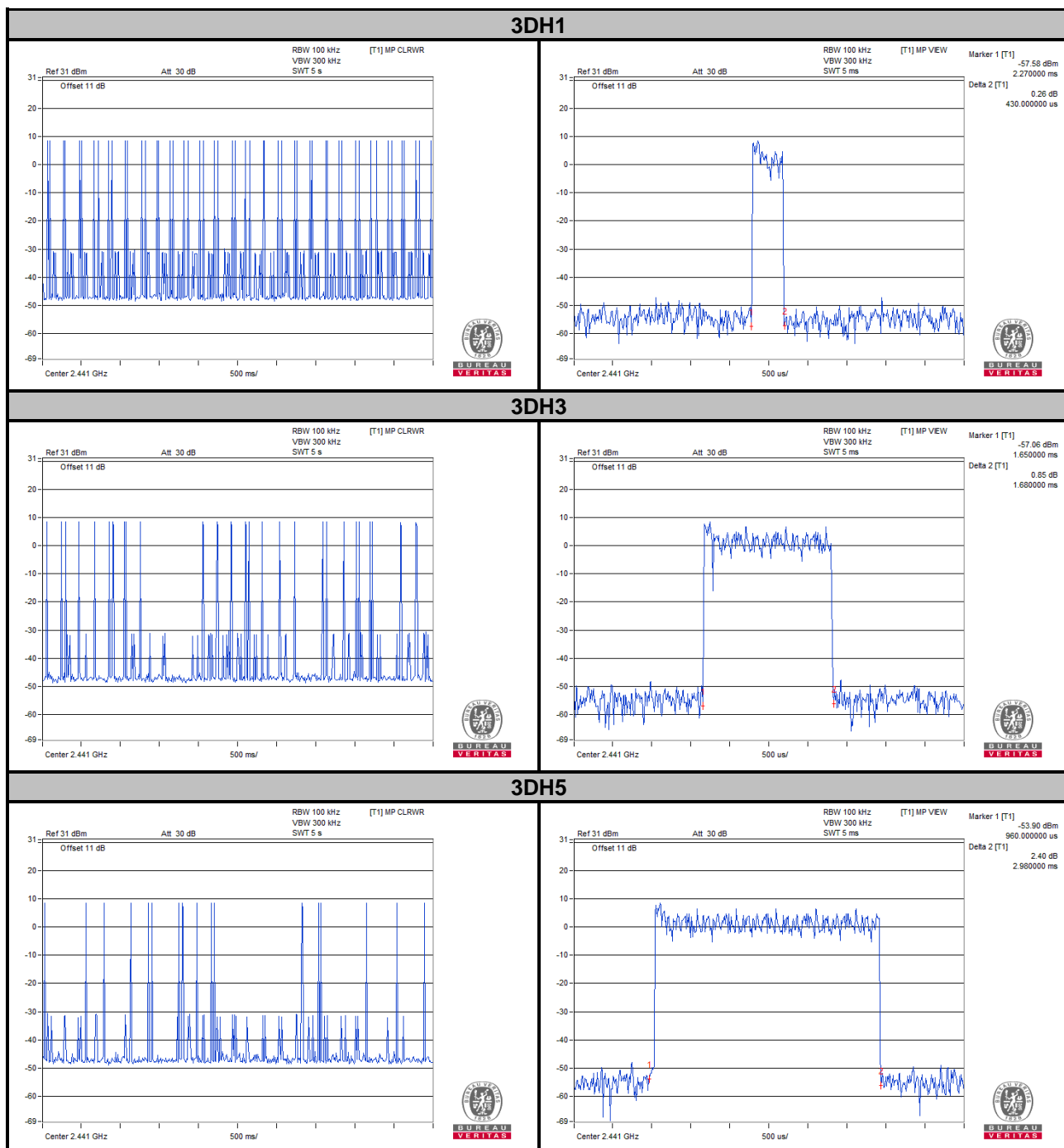

4.5 Channel Bandwidth

4.5.1 Limits of Channel Bandwidth Measurement

For frequency hopping system operating in the 2400-2483.5 MHz, if the 20 dB bandwidth of hopping channel is greater than 25 kHz, two-thirds 20 dB bandwidth of hopping channel shall be a minimum limit for the hopping channel separation.

4.5.2 Test Setup



4.5.3 Test Instruments

Refer to section 4.1.2 to get information of above instrument.

4.5.4 Test Procedure

- Check the calibration of the measuring instrument using either an internal calibrator or a known signal from an external generator.
- Turn on the EUT and connect it to measurement instrument. Then set it to any one convenient frequency within its operating range. Set a reference level on the measuring instrument equal to the highest peak value.
- Measure the frequency difference of two frequencies that were attenuated 20 dB from the reference level. Record the frequency difference as the emission bandwidth.
- Repeat above procedures until all frequencies measured were complete.

4.5.5 Deviation from Test Standard

No deviation.

4.5.6 EUT Operating Condition

The software provided by client enabled the EUT to transmit and receive data at lowest, middle and highest channel frequencies individually.

4.5.7 Test Results

Channel	Frequency (MHz)	20 dB Bandwidth (MHz)	
		GFSK	8DPSK
0	2402	0.96	1.30
39	2441	0.96	1.30
78	2480	0.96	1.30

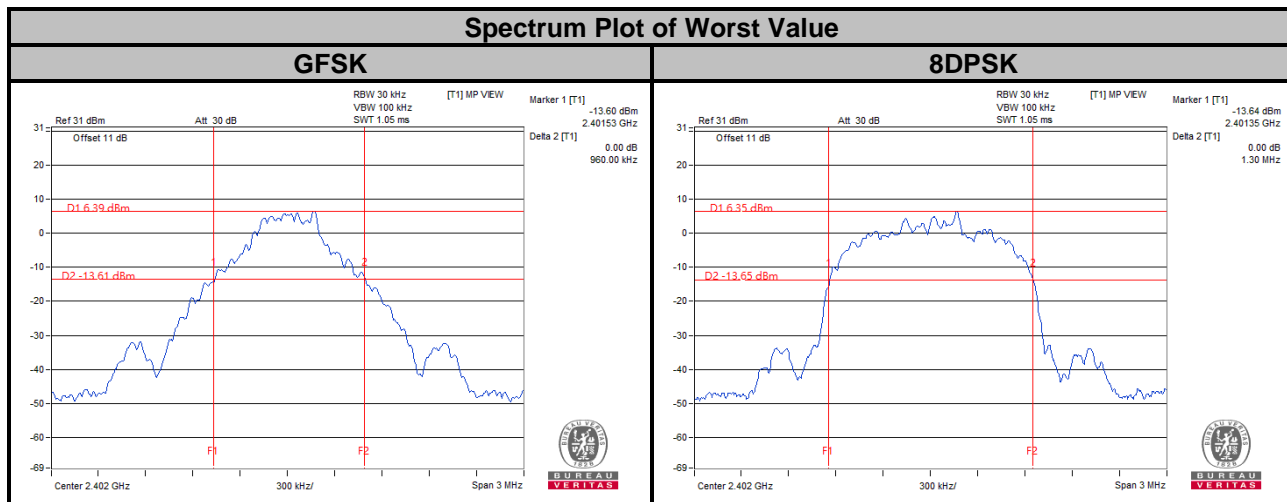

4.6 Occupied Bandwidth Measurement

4.6.1 Test Setup

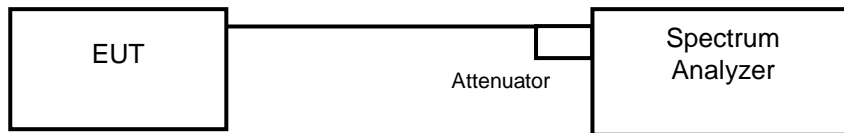

4.6.2 Test Instruments

Refer to section 4.1.2 to get information of above instrument

4.6.3 Test Procedure

The transmitter output was connected to the spectrum analyzer through an attenuator. The bandwidth of the fundamental frequency was measured by spectrum analyzer with resolution bandwidth in the range of 1 % to 5 % of the anticipated emission bandwidth, and a video bandwidth at least 3x the resolution bandwidth and set the detector to sampling. The width of a frequency band such that, below the lower and above the upper frequency limits, the mean powers emitted are each equal to a specified percentage 0.5 % of the total mean power of a given emission.

4.6.4 Deviation from Test Standard

No deviation.

4.6.5 EUT Operating Conditions

The software provided by client to enable the EUT under transmission condition continuously at lowest, middle and highest channel frequencies individually.

4.6.6 Test Results

Channel	Frequency (MHz)	Occupied Bandwidth (MHz)	
		GFSK	8DPSK
0	2402	0.88	1.17
39	2441	0.87	1.17
78	2480	0.87	1.17

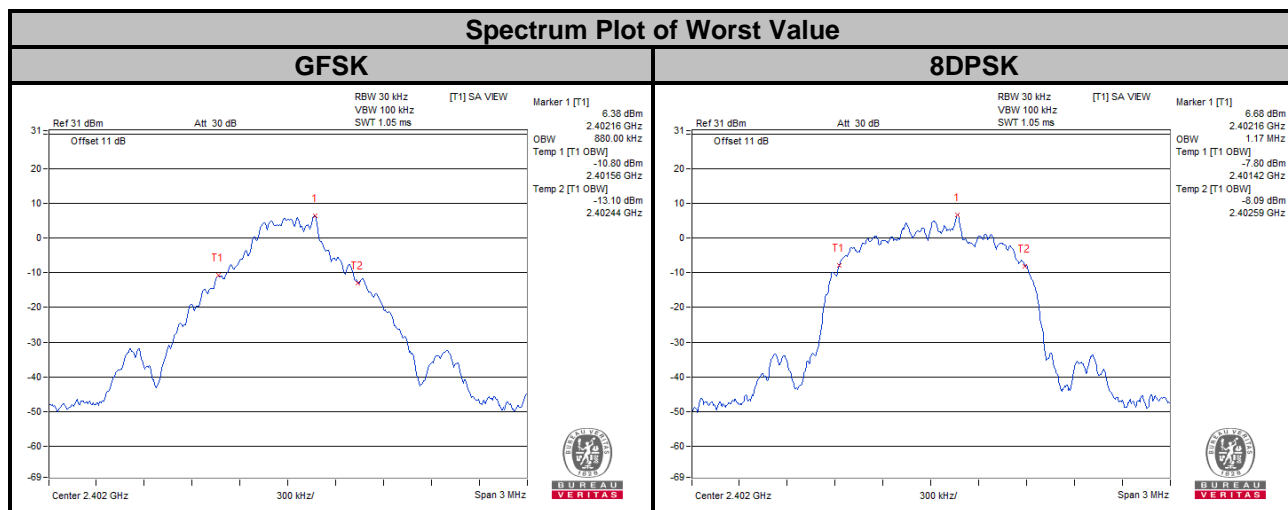

4.7 Hopping Channel Separation

4.7.1 Limits of Hopping Channel Separation Measurement

At least 25 kHz or two-third of 20 dB hopping channel bandwidth (whichever is greater).

4.7.2 Test Setup

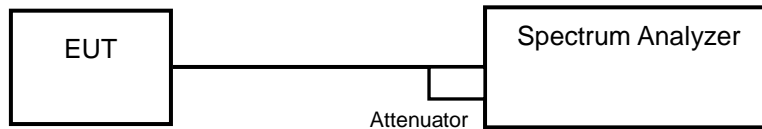

4.7.3 Test Instruments

Refer to section 4.1.2 to get information of above instrument.

4.7.4 Test Procedure

Measurement Procedure REF

- Check the calibration of the measuring instrument using either an internal calibrator or a known signal from an external generator.
- Turn on the EUT and connect it to measurement instrument. Then set it to any one convenient frequency within its operating range.
- By using the MaxHold function record the separation of two adjacent channels.
- Measure the frequency difference of these two adjacent channels by SA MARK function. And then plot the result on SA screen.
- Repeat above procedures until all frequencies measured were complete.

4.7.5 Deviation from Test Standard

No deviation.

4.7.6 Test Results

Channel	Freq. (MHz)	Adjacent Channel Separation (MHz)		20 dB Bandwidth (MHz)		Minimum Limit (MHz)		Pass / Fail
		GFSK	8DPSK	GFSK	8DPSK	GFSK	8DPSK	
0	2402	1.00	1.00	0.96	1.30	0.64	0.87	Pass
39	2441	1.00	1.00	0.96	1.30	0.64	0.87	Pass
78	2480	1.00	1.00	0.96	1.30	0.64	0.87	Pass

Note: The minimum limit is two-third 20 dB bandwidth.

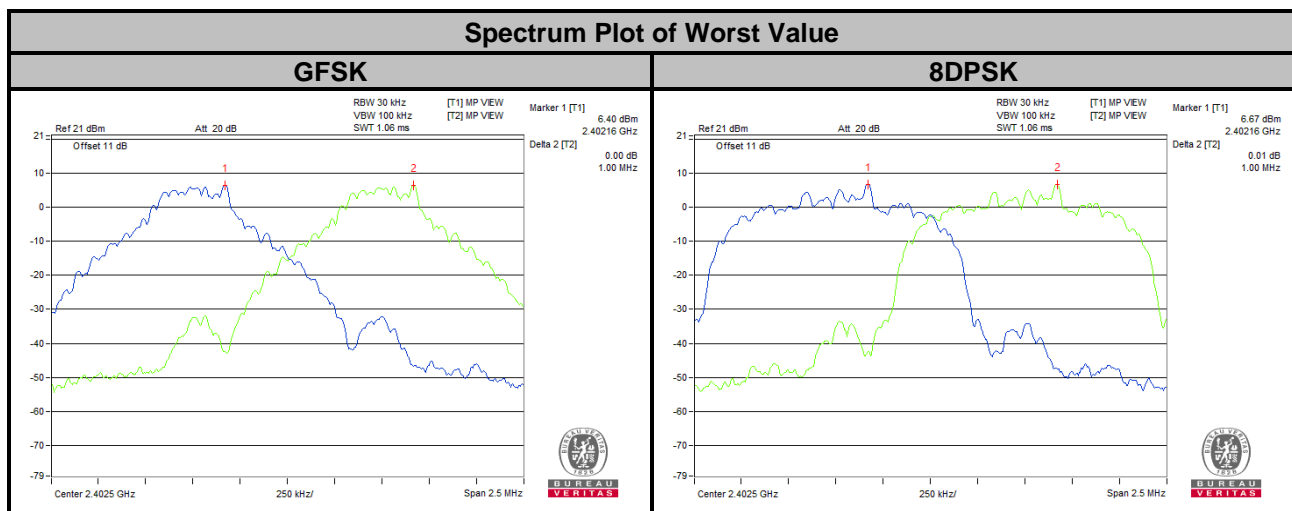

4.8 Maximum Output Power

4.8.1 Limits of Maximum Output Power Measurement

For frequency hopping systems operating in the 2400-2483.5 MHz band employing at least 75 non-overlapping hopping channels: 1 watt.

For all other frequency hopping systems in the 2400-2483.5 MHz band: 0.125 watts.

4.8.2 Test Setup

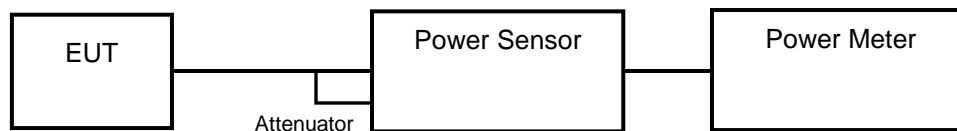

4.8.3 Test Instruments

Refer to section 4.1.2 to get information of above instrument.

4.8.4 Test Procedure

A peak power sensor was used on the output port of the EUT. A power meter was used to read the response of the peak power sensor. Record the power level.

Average power sensor was used to perform output power measurement, trigger and gating function of wide band power meter is enabled to measure max output power of TX on burst. Duty factor is not added to measured value.

4.8.5 Deviation from Test Standard

No deviation.

4.8.6 EUT Operating Condition

The software provided by client enabled the EUT to transmit and receive data at lowest, middle and highest channel frequencies individually.

4.8.7 Test Results

<GFSK>

Channel	Freq. (MHz)	Peak Power		Power Limit (mW)	Pass / Fail
		(mW)	(dBm)		
0	2402	2.972	4.73	125 / 1000 ^{Note}	Pass
39	2441	3.459	5.39	125 / 1000 ^{Note}	Pass
78	2480	3.855	5.86	125 / 1000 ^{Note}	Pass

Note: RF Output Power limit depends on the operating channel numbers, please refer to section 4.3 of the results.

Channel	Freq. (MHz)	Average Power	
		(mW)	(dBm)
0	2402	2.692	4.30
39	2441	3.155	4.99
78	2480	3.516	5.46

<8DPSK>

Channel	Freq. (MHz)	Peak Power		Power Limit (mW)	Pass / Fail
		(mW)	(dBm)		
0	2402	5.420	7.34	125 / 1000 ^{Note}	Pass
39	2441	6.281	7.98	125 / 1000 ^{Note}	Pass
78	2480	6.982	8.44	125 / 1000 ^{Note}	Pass

Note: RF Output Power limit depends on the operating channel numbers, please refer to section 4.3 of the results.

Channel	Freq. (MHz)	Average Power	
		(mW)	(dBm)
0	2402	2.606	4.16
39	2441	3.041	4.83
78	2480	3.428	5.35

4.9 Conducted Out of Band Emission Measurement

4.9.1 Limits Of Conducted Out of Band Emission Measurement

Below -20 dB of the highest emission level of operating band (in 100 kHz RBW).

4.9.2 Test Instruments

Refer to section 4.1.2 to get information of above instrument.

4.9.3 Test Procedure

The transmitter output was connected to the spectrum analyzer via a low lose cable. Set both RBW and VBW of spectrum analyzer to 100 kHz and 300 kHz with suitable frequency span including 100 MHz bandwidth from band edge. The band edges was measured and recorded.

4.9.4 Deviation from Test Standard

No deviation.

4.9.5 EUT Operating Condition

The software provided by client enabled the EUT to transmit and receive data at lowest, middle and highest channel frequencies individually.

4.9.6 Test Results

The spectrum plots are attached on the following images. D1 line indicates the highest level, D2 line indicates the 20 dB offset below D1. It shows compliance with the requirement.



BUREAU VERITAS

GFSK

Hopping Disabled_Low Channel

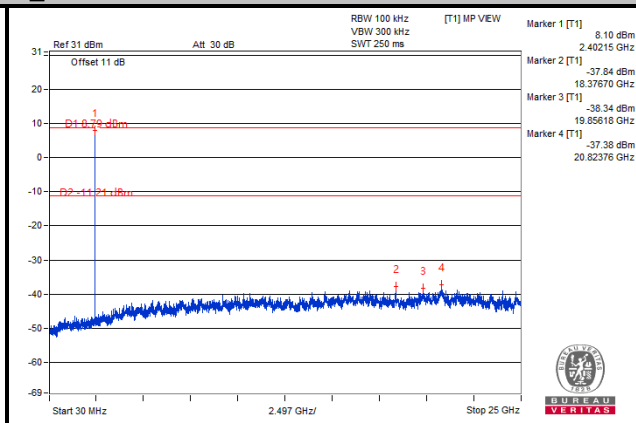
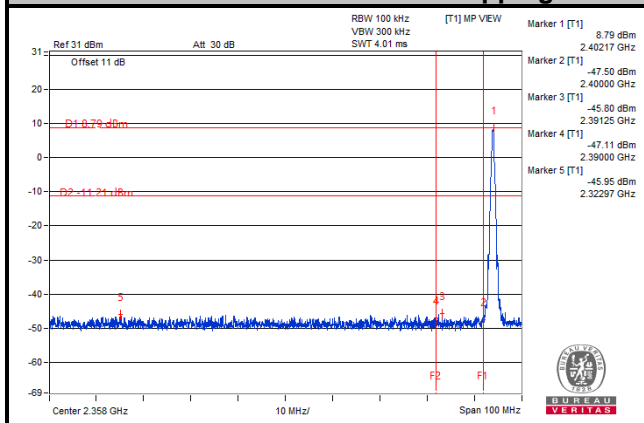

Hopping Disabled_High Channel

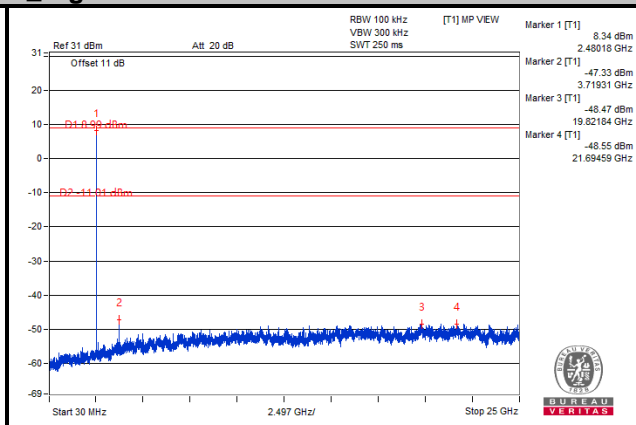
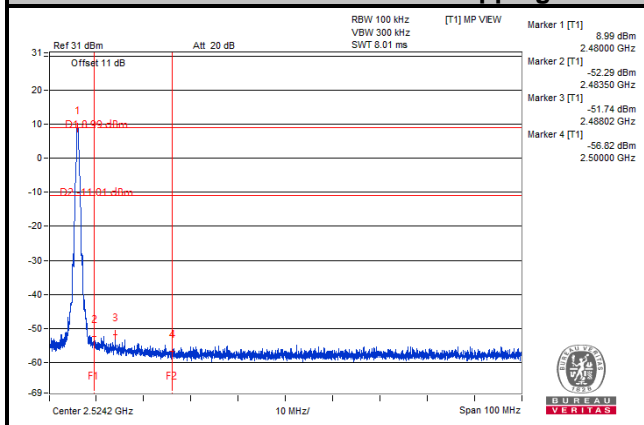

Hopping Enabled_Low Channel

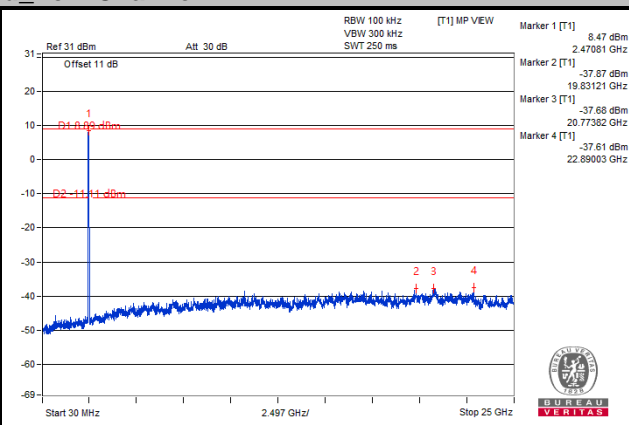
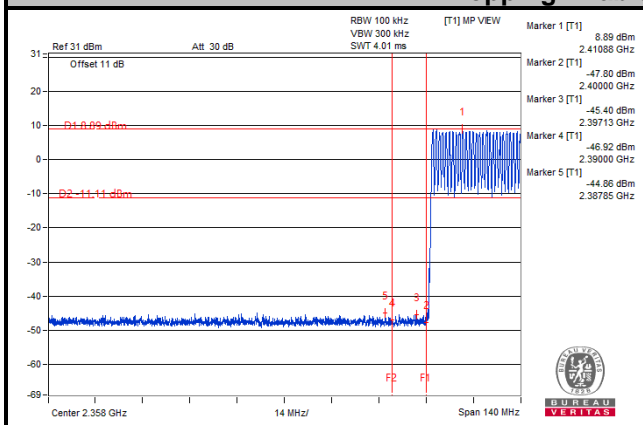

Hopping Enabled_High Channel

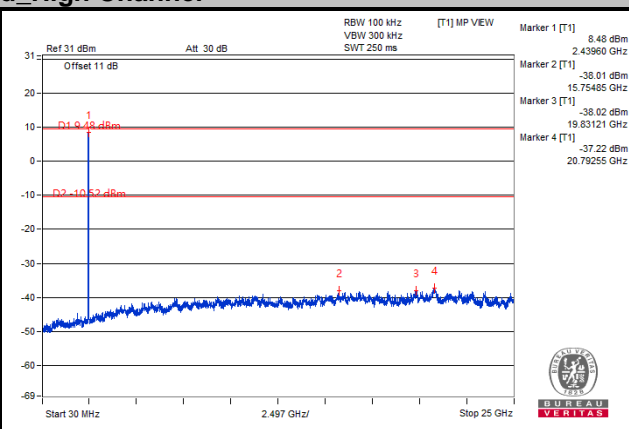
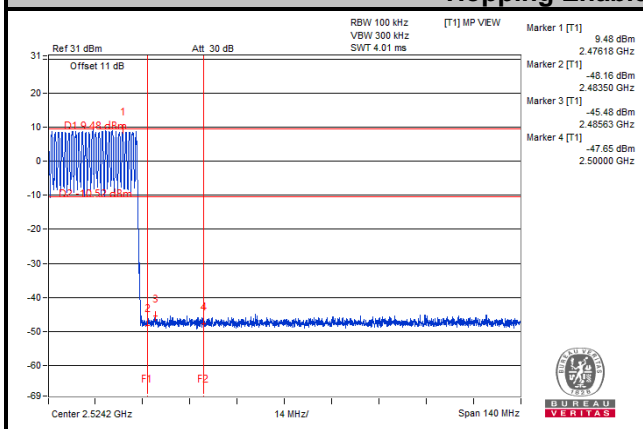

8DPSK

Hopping Disabled_Low Channel

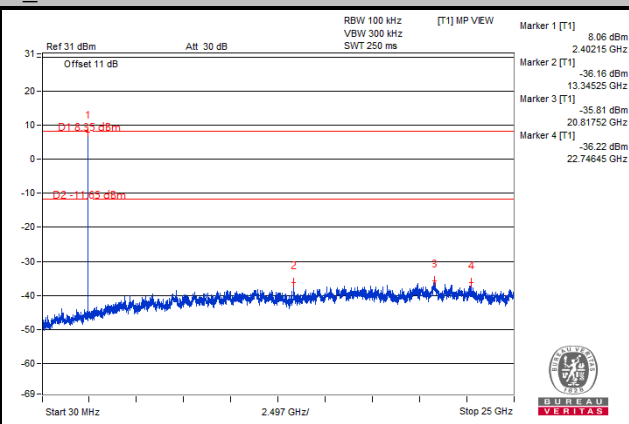
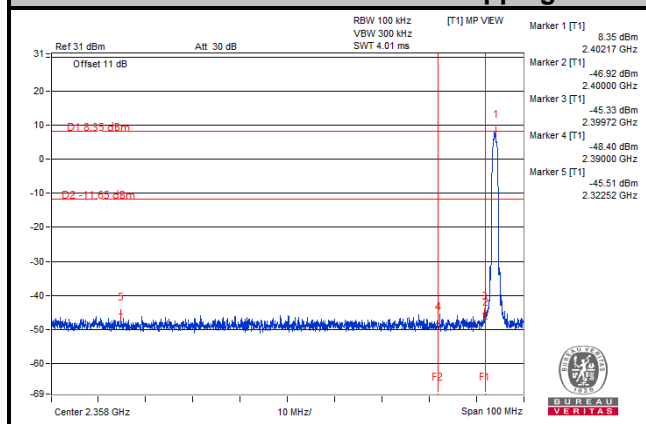

Hopping Disabled_High Channel

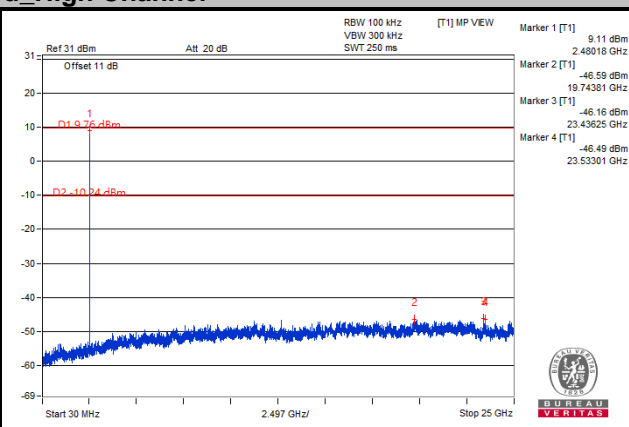
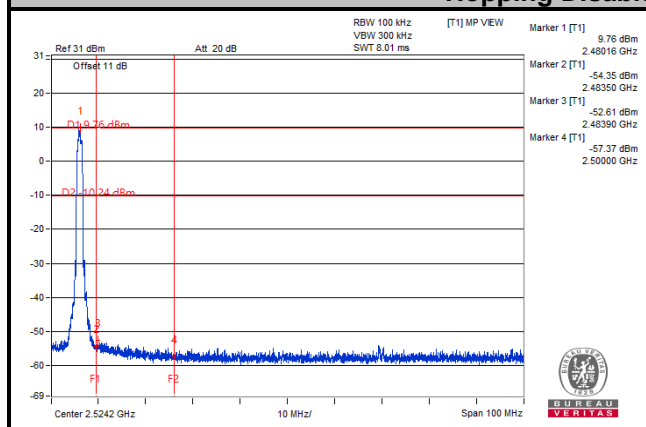

Hopping Enabled_Low Channel

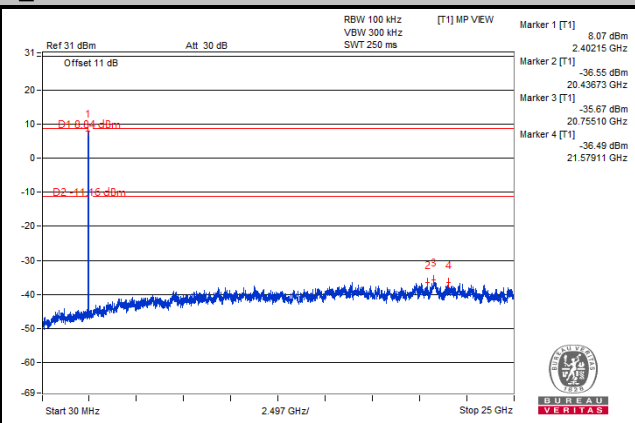
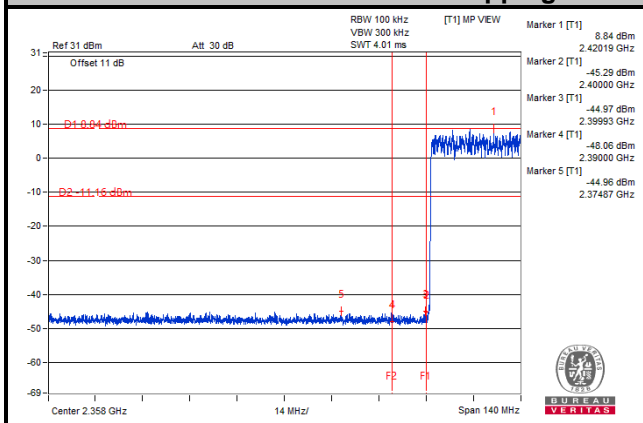

Hopping Enabled_High Channel

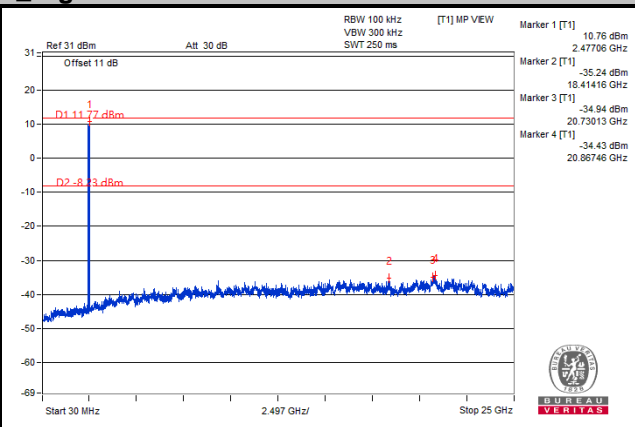
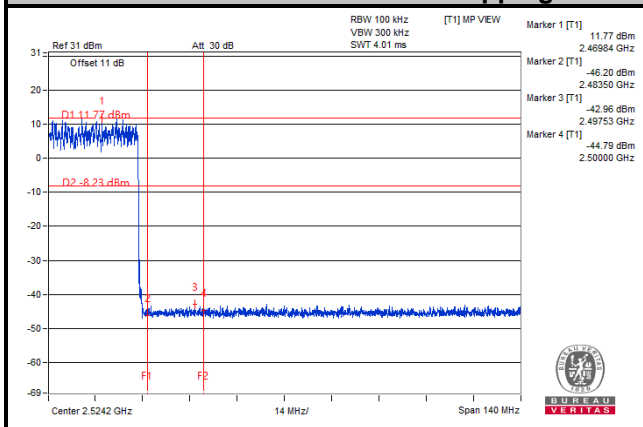

5 Pictures of Test Arrangements

Please refer to the attached file (Test Setup Photo).

Annex A- Band Edge Measurement

Mode A
GFSK

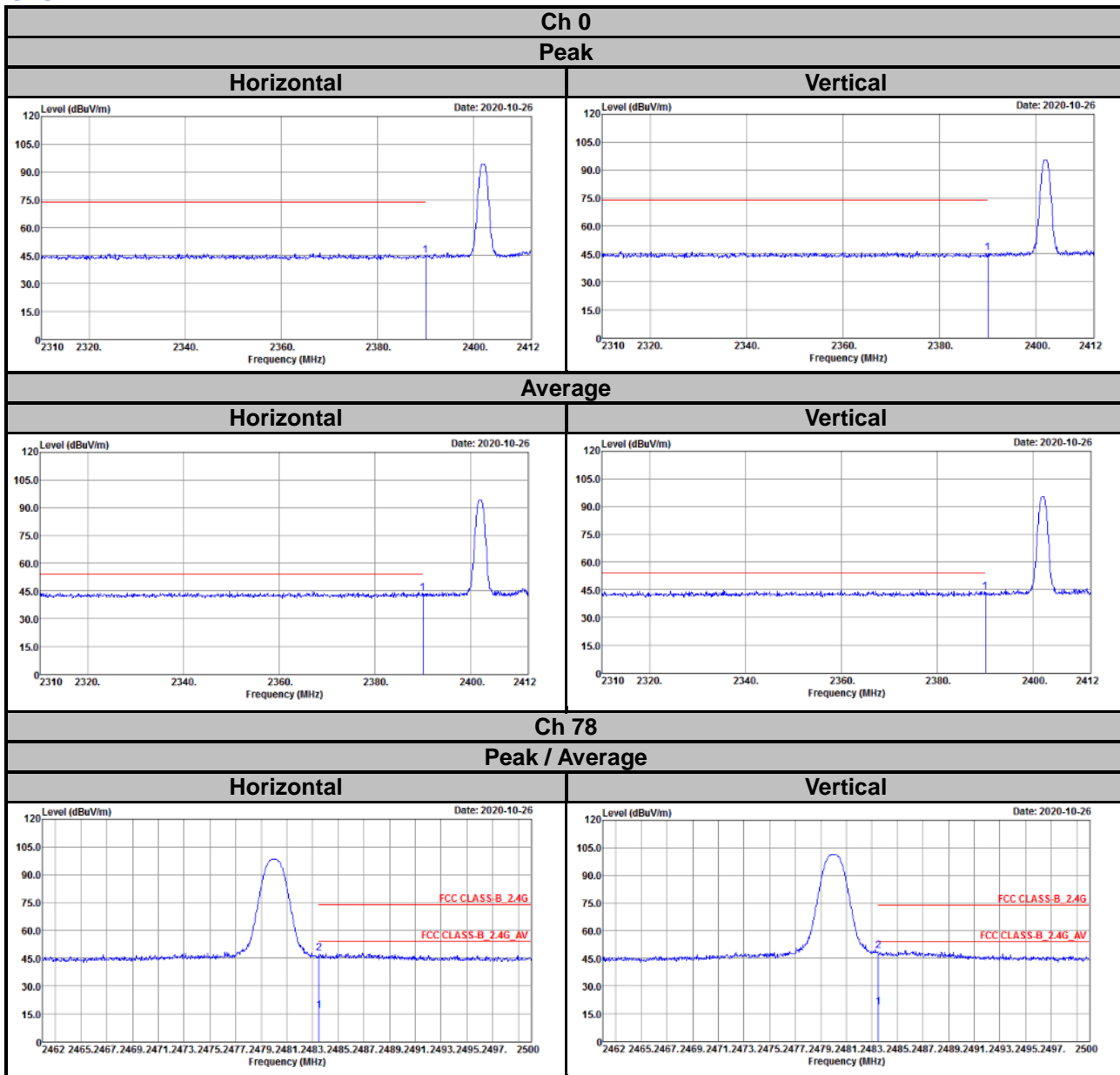

8DPSK

Ch 0

Peak

Horizontal

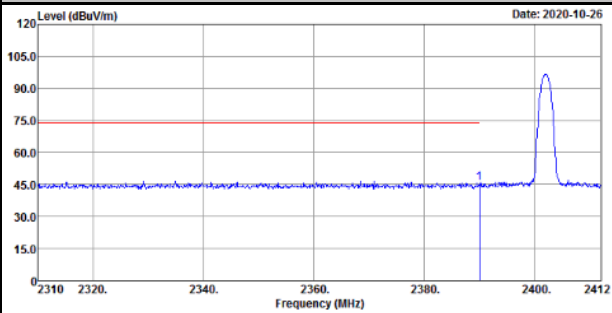

Vertical

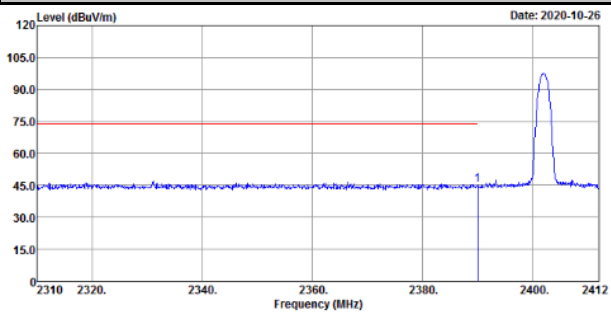

Average

Horizontal

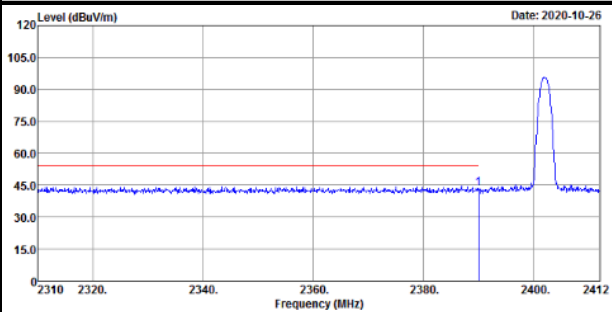

Vertical

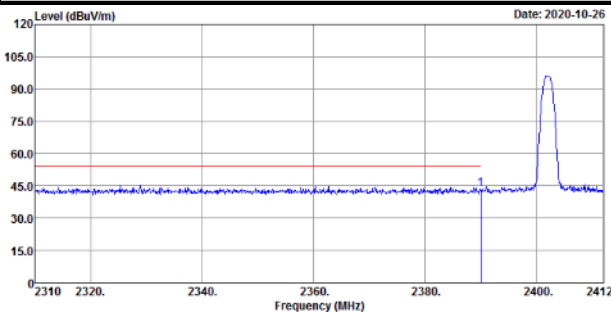

Ch 78

Peak / Average

Horizontal

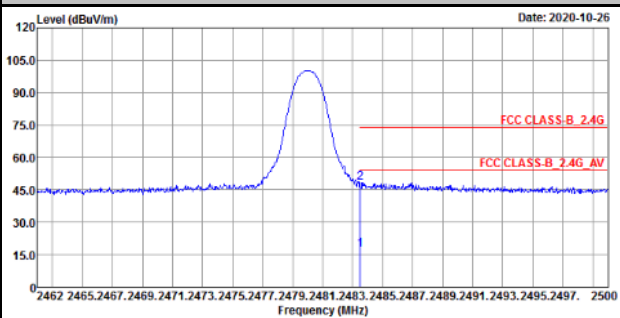

Vertical

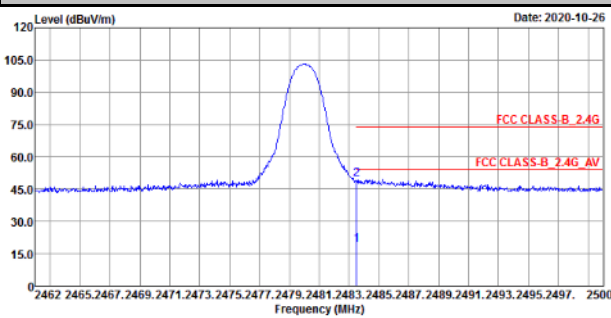

**Mode B
GFSK**

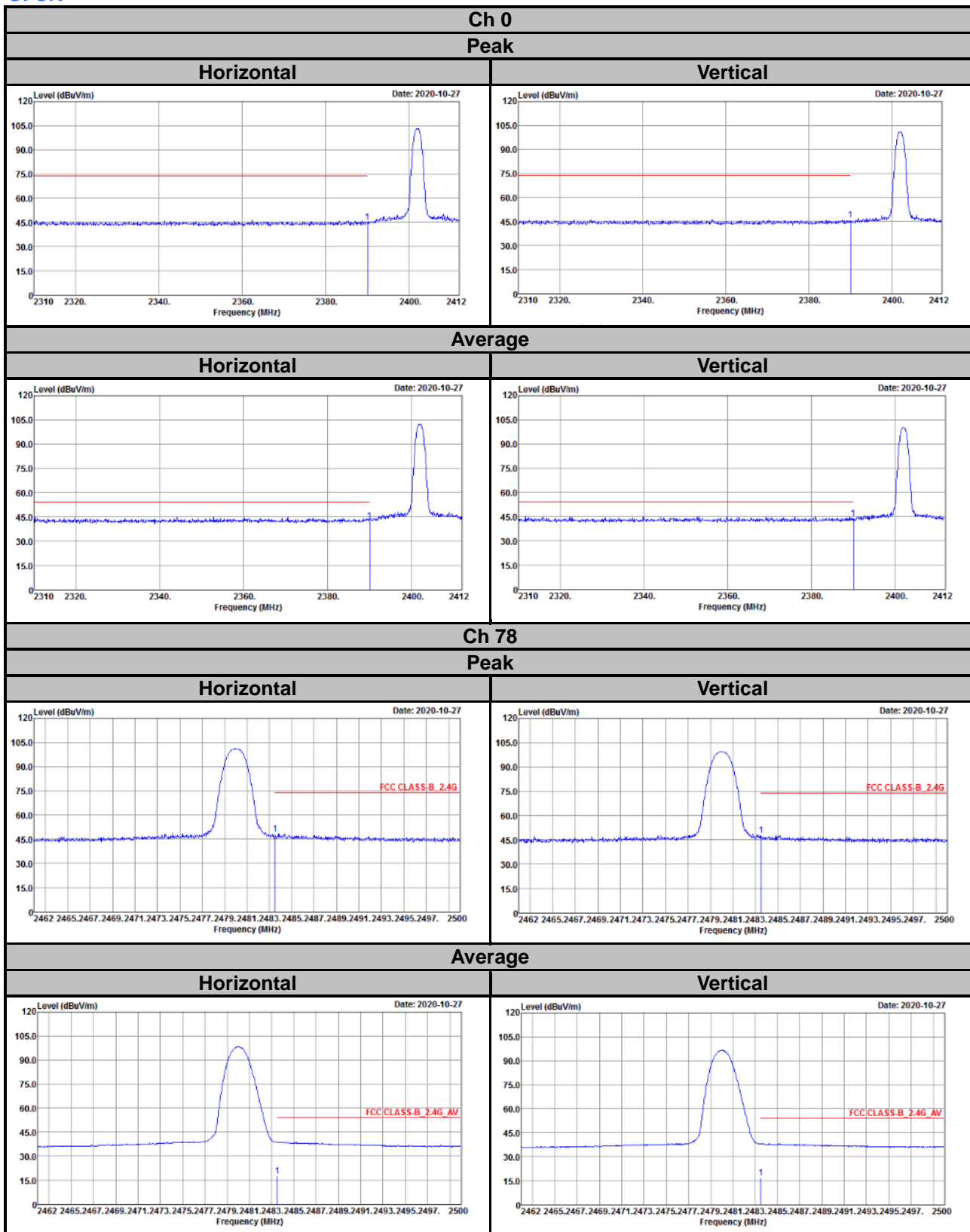

8DPSK

Ch 0

Peak

Horizontal

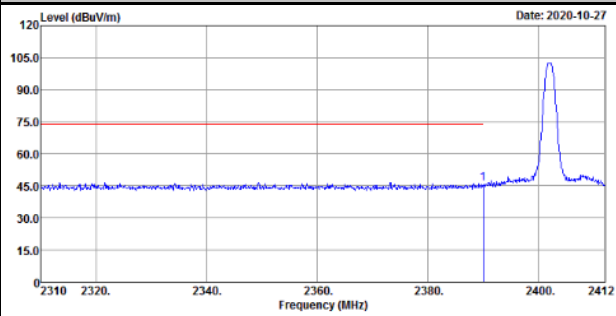

Vertical

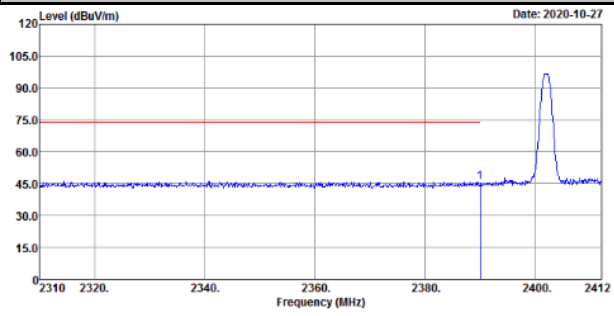

Average

Horizontal

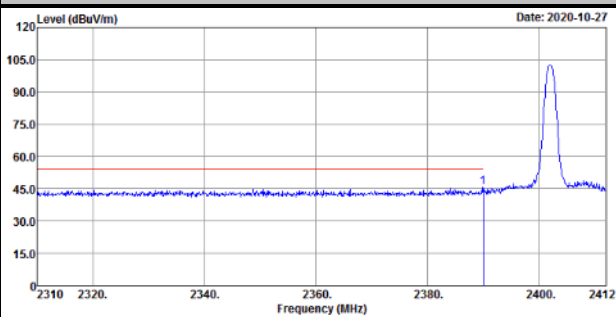

Vertical

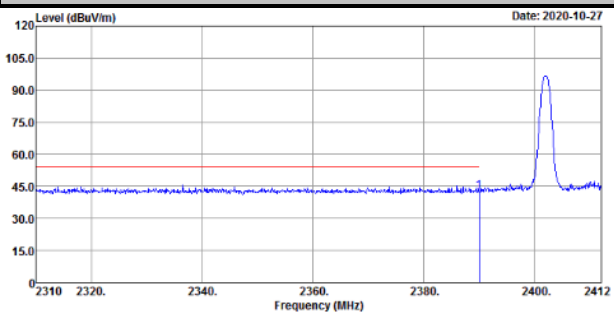

Ch 78

Peak

Horizontal

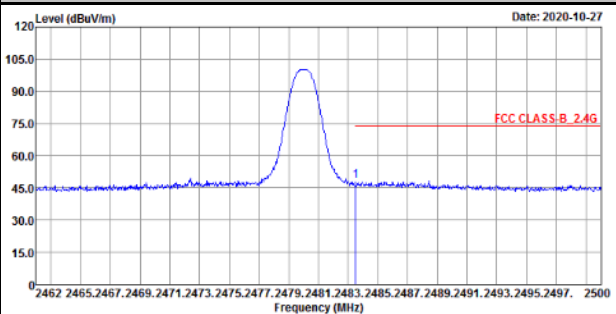

Vertical

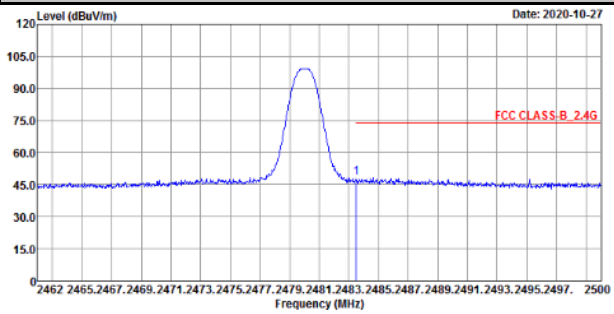

Average

Horizontal

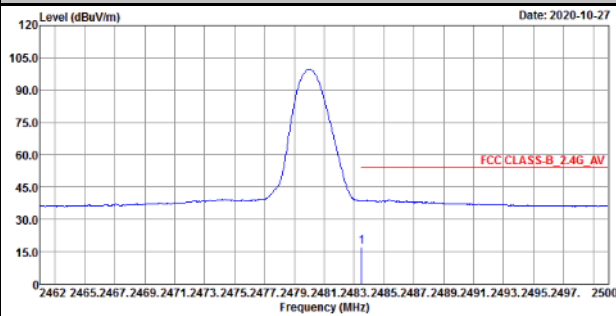

Vertical

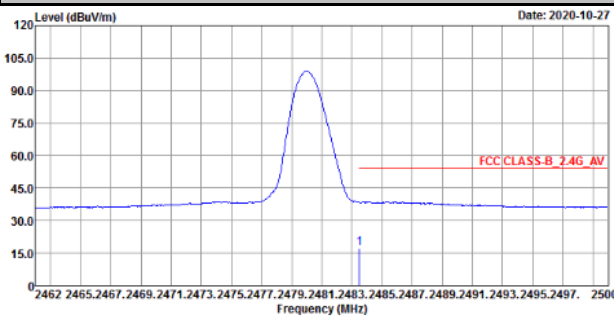

Appendix – Information of the Testing Laboratories

We, Bureau Veritas Consumer Products Services (H.K.) Ltd., Taoyuan Branch, were founded in 1988 to provide our best service in EMC, Radio, Telecom and Safety consultation. Our laboratories are FCC recognized accredited test firms and accredited according to ISO/IEC 17025.

If you have any comments, please feel free to contact us at the following:

Lin Kou EMC/RF Lab

Tel: 886-2-26052180

Fax: 886-2-26051924

Hsin Chu EMC/RF/Telecom Lab

Tel: 886-3-6668565

Fax: 886-3-6668323

Hwa Ya EMC/RF/Safety Lab

Tel: 886-3-3183232

Fax: 886-3-3270892

Email: service.adt@tw.bureauveritas.com

Web Site: www.bureauveritas-adt.com

The address and road map of all our labs can be found in our web site also.

--- END ---