

## FCC Test Report (Co-Located)

**Report No.:** RFBGTL-WTW-P20100273-2

**FCC ID:** RX3-WBU053VZBT

**Test Model:** WBU053-VZBT

**Received Date:** Oct. 21, 2020

**Test Date:** Oct. 27 ~ Oct. 28, 2020

**Issued Date:** Nov. 06, 2020

**Applicant:** Hon Hai Precision Industry Co., Ltd.

**Address:** No.151, Sec. 1, Nankan Rd., Lujhu Dist., Taoyuan County 33859, Taiwan (R.O.C.)

**Issued By:** Bureau Veritas Consumer Products Services (H.K.) Ltd., Taoyuan Branch  
Lin Kou Laboratories

**Lab Address:** No. 47-2, 14th Ling, Chia Pau Vil., Lin Kou Dist., New Taipei City, Taiwan

**Test Location:** No. 19, Hwa Ya 2nd Rd., Wen Hwa Vil., Kwei Shan Dist., Taoyuan City 33383, TAIWAN

**FCC Registration / Designation Number:** 788550 / TW0003



This report is for your exclusive use. Any copying or replication of this report to or for any other person or entity, or use of our name or trademark, is permitted only with our prior written permission. This report sets forth our findings solely with respect to the test samples identified herein. The results set forth in this report are not indicative or representative of the quality or characteristics of the lot from which a test sample was taken or any similar or identical product unless specifically and expressly noted. Our report includes all of the tests requested by you and the results thereof based upon the information that you provided to us. You have 60 days from date of issuance of this report to notify us of any material error or omission caused by our negligence, provided, however, that such notice shall be in writing and shall specifically address the issue you wish to raise. A failure to raise such issue within the prescribed time shall constitute your unqualified acceptance of the completeness of this report, the tests conducted and the correctness of the report contents. Unless specific mention, the uncertainty of measurement has been explicitly taken into account to declare the compliance or non-compliance to the specification.

## Table of Contents

<b>Release Control Record</b> .....	<b>3</b>
<b>1 Certificate of Conformity</b> .....	<b>4</b>
<b>2 Summary of Test Results</b> .....	<b>5</b>
2.1 Measurement Uncertainty .....	5
2.2 Modification Record .....	5
<b>3 General Information</b> .....	<b>6</b>
3.1 General Description of EUT .....	6
3.2 Description of Test Modes .....	8
3.2.1 Test Mode Applicability and Tested Channel Detail .....	12
3.3 Description of Support Units .....	13
3.3.1 Configuration of System under Test .....	13
3.4 General Description of Applied Standards .....	14
<b>4 Test Types and Results</b> .....	<b>15</b>
4.1 Radiated Emission and Bandedge Measurement .....	15
4.1.1 Limits of Radiated Emission and Bandedge Measurement .....	15
4.1.2 Test Instruments .....	16
4.1.3 Test Procedures .....	17
4.1.4 Deviation from Test Standard .....	17
4.1.5 Test Setup .....	18
4.1.6 EUT Operating Conditions .....	19
4.1.7 Test Results .....	20
<b>5 Pictures of Test Arrangements</b> .....	<b>32</b>
<b>Appendix – Information of the Testing Laboratories</b> .....	<b>33</b>

### Release Control Record

Issue No.	Description	Date Issued
RFBGTL-WTW-P20100273-2	Original Release	Nov. 06, 2020

## 1 Certificate of Conformity

**Product:** 802.11a/b/g/n 2T2R with Bluetooth combo wireless module

**Brand:** Foxconn

**Test Model:** WBU053-VZBT

**Sample Status:** Engineering Sample

**Applicant:** Hon Hai Precision Industry Co., Ltd.

**Test Date:** Oct. 27 ~ Oct. 28, 2020

**Standards:** 47 CFR FCC Part 15, Subpart C (Section 15.247)  
47 CFR FCC Part 15, Subpart E (Section 15.407)  
ANSI C63.10:2013

The above equipment has been tested by **Bureau Veritas Consumer Products Services (H.K.) Ltd., Taoyuan Branch**, and found compliance with the requirement of the above standards. The test record, data evaluation & Equipment Under Test (EUT) configurations represented herein are true and accurate accounts of the measurements of the sample's RF characteristics under the conditions specified in this report.

**Prepared by :** Gina Liu, **Date:** Nov. 06, 2020  
Gina Liu / Specialist

**Approved by :** Dylan Chiou, **Date:** Nov. 06, 2020  
Dylan Chiou / Senior Project Engineer

## 2 Summary of Test Results

Applied Standard:	47 CFR FCC Part 15, Subpart C (Section 15.247) 47 CFR FCC Part 15, Subpart E (Section 15.407)		
FCC Clause	Test Item	Result	Remarks
15.205 / 15.209 / 15.247(d) 15.407(b) (1/2/3/4(i/ii)/6)	Radiated Emissions	Pass	Meet the requirement of limit. Minimum passing margin is -1.48dB at 145.43 MHz.

Note: Determining compliance based on the results of the compliance measurement, not taking into account measurement instrumentation uncertainty.

### 2.1 Measurement Uncertainty

Where relevant, the following measurement uncertainty levels have been estimated for tests performed on the EUT as specified in CISPR 16-4-2:

Measurement	Frequency	Expanded Uncertainty (k=2) ( $\pm$ )
Radiated Emissions up to 1 GHz	9 kHz ~ 30 MHz	3.04 dB
	30 MHz ~ 200 MHz	2.93 dB
	200 MHz ~ 1000 MHz	2.95 dB
Radiated Emissions above 1 GHz	1 GHz ~ 18 GHz	2.26 dB
	18 GHz ~ 40 GHz	1.94 dB

### 2.2 Modification Record

There were no modifications required for compliance.

### 3 General Information

#### 3.1 General Description of EUT

Product	802.11a/b/g/n 2T2R with Bluetooth combo wireless module	
Brand	Foxconn	
Test Model	WBU053-VZBT	
Sample Status	Engineering sample	
Power Supply rating	4.5 ~ 5.5 Vdc (from Host equipment)	
Modulation Type	WLAN	CCK, DQPSK, DBPSK for DSSS 64QAM, 16QAM, QPSK, BPSK for OFDM
	BT EDR	GFSK, $\pi/4$ -DQPSK, 8DPSK
	BT LE	GFSK
Transfer Rate	WLAN	802.11a: 54.0/ 48.0/ 36.0/ 24.0/ 18.0/ 12.0/ 9.0/ 6.0 Mbps 802.11b: 11.0 / 5.5 / 2.0 / 1.0 Mbps 802.11g: 54.0 / 48.0 / 36.0 / 24.0 / 18.0 / 12.0 / 9.0 / 6.0 Mbps 802.11n: up to 300.0 Mbps
	BT EDR	1/2/3 Mbps
	BT LE	1 Mbps & 2 Mbps
Operating Frequency	WLAN	2.4GHz: 2412 ~ 2462MHz 5.0GHz: 5180 ~ 5240 MHz, 5260 ~ 5320 MHz, 5500 ~ 5720 MHz, 5745 ~5825 MHz
	BT EDR	2402 ~ 2480 MHz
	BT LE	2402 ~ 2480 MHz
Number of Channel	WLAN	2412 ~ 2462MHz: 11 for 802.11b, 802.11g, 802.11n (HT20) 7 for 802.11n (HT40) 5180 ~ 5240 MHz: 4 for 802.11a, 802.11n (HT20) 2 for 802.11n (HT40) 5260 ~ 5320 MHz: 4 for 802.11a, 802.11n (HT20) 2 for 802.11n (HT40) 5500 ~ 5720 MHz: 12 for 802.11a, 802.11n (HT20) 6 for 802.11n (HT40) 5745 ~ 5825 MHz: 5 for 802.11a, 802.11n (HT20) 2 for 802.11n (HT40)
	BT EDR	79
	BT LE	40
Output Power	WLAN	427.173 mW for 2412 ~ 2462MHz 48.09 mW for 5180 ~ 5240 MHz 48.652 mW for 5260 ~ 5320 MHz 48.87 mW for 5500 ~ 5720 MHz 47.98 mW for 5745 ~ 5825 MHz
	BT EDR	6.982 mW
	BT LE	LE 4.2: 4.064 mW LE 5.0: 4.074. mW
Antenna Type	Refer to Note as below	
Antenna Connector	N/A	
Accessory Device	N/A	
Cable Supplied	N/A	

Note:

1. The antenna information is listed as below.

No.	Functionality	Manufacturer	Model	Cable Length	Type	Antenna Gain (dBi)				
						2400-2483.5 MHz	5180-5240 MHz	5260-5320 MHz	5500-5720 MHz	5745-5825 MHz
1	WLAN	Foxconn	-	240mm	PCB	0.95	-0.22	-0.22	2.89	1.86
2			-	390mm		0.62	1.86	1.86	3.07	2.44

No.	Functionality	Manufacturer	Model	Cable Length	Type	Antenna Gain (dBi)
1	BT	Foxconn	6903B0000N000	240mm	PIFA	2.27
2			6903B0000P000	390mm		2.47

2. The above Antenna information is declared by manufacturer and for more detailed features description, please refer to the manufacturer's specifications, the laboratory shall not be held responsible.
3. The above EUT information is declared by manufacturer and for more detailed features description, please refers to the manufacturer's specifications or User's Manual.

### 3.2 Description of Test Modes

#### WLAN 2.4G:

11 channels are provided for 802.11b, 802.11g and 802.11n (HT20):

Channel	Frequency (MHz)	Channel	Frequency (MHz)
1	2412	7	2442
2	2417	8	2447
3	2422	9	2452
4	2427	10	2457
5	2432	11	2462
6	2437		

7 channels are provided for 802.11n (HT40):

Channel	Frequency (MHz)	Channel	Frequency (MHz)
3	2422	7	2442
4	2427	8	2447
5	2432	9	2452
6	2437		



**For 5180 ~ 5240 MHz**

4 channels are provided for 802.11a, 802.11n (HT20):

Channel	Frequency (MHz)	Channel	Frequency (MHz)
36	5180	44	5220
40	5200	48	5240

2 channels are provided for 802.11n (HT40):

Channel	Frequency (MHz)	Channel	Frequency (MHz)
38	5190	46	5230

**For 5260 ~ 5320 MHz**

4 channels are provided for 802.11a, 802.11n (HT20):

Channel	Frequency (MHz)	Channel	Frequency (MHz)
52	5260	60	5300
56	5280	64	5320

2 channels are provided for 802.11n (HT40):

Channel	Frequency (MHz)	Channel	Frequency (MHz)
54	5270	62	5310

**For 5500 ~ 5720 MHz**

12 channels are provided for 802.11a, 802.11n (HT20):

Channel	Frequency (MHz)	Channel	Frequency (MHz)
100	5500	124	5620
104	5520	128	5640
108	5540	132	5660
112	5560	136	5680
116	5580	140	5700
120	5600	144	5720

6 channels are provided for 802.11n (HT40):

Channel	Frequency (MHz)	Channel	Frequency (MHz)
102	5510	126	5630
110	5550	134	5670
118	5590	142	5710

**For 5745 ~ 5825 MHz:**

5 channels are provided for 802.11a, 802.11n (HT20):

Channel	Frequency (MHz)	Channel	Frequency (MHz)
149	5745	161	5805
153	5765	165	5825
157	5785		

2 channels are provided for 802.11n (HT40):

Channel	Frequency (MHz)	Channel	Frequency (MHz)
151	5755	159	5795

**BT EDR**

79 channels are provided to this EUT:

Channel	Freq. (MHz)	Channel	Freq. (MHz)	Channel	Freq. (MHz)	Channel	Freq. (MHz)
0	2402	20	2422	40	2442	60	2462
1	2403	21	2423	41	2443	61	2463
2	2404	22	2424	42	2444	62	2464
3	2405	23	2425	43	2445	63	2465
4	2406	24	2426	44	2446	64	2466
5	2407	25	2427	45	2447	65	2467
6	2408	26	2428	46	2448	66	2468
7	2409	27	2429	47	2449	67	2469
8	2410	28	2430	48	2450	68	2470
9	2411	29	2431	49	2451	69	2471
10	2412	30	2432	50	2452	70	2472
11	2413	31	2433	51	2453	71	2473
12	2414	32	2434	52	2454	72	2474
13	2415	33	2435	53	2455	73	2475
14	2416	34	2436	54	2456	74	2476
15	2417	35	2437	55	2457	75	2477
16	2418	36	2438	56	2458	76	2478
17	2419	37	2439	57	2459	77	2479
18	2420	38	2440	58	2460	78	2480
19	2421	39	2441	59	2461		

**BT LE:**

40 channels are provided provided to this EUT:

Channel	Freq. (MHz)	Channel	Freq. (MHz)	Channel	Freq. (MHz)	Channel	Freq. (MHz)
0	2402	10	2422	20	2442	30	2462
1	2404	11	2424	21	2444	31	2464
2	2406	12	2426	22	2446	32	2466
3	2408	13	2428	23	2448	33	2468
4	2410	14	2430	24	2450	34	2470
5	2412	15	2432	25	2452	35	2472
6	2414	16	2434	26	2454	36	2474
7	2416	17	2436	27	2456	37	2476
8	2418	18	2438	28	2458	38	2478
9	2420	19	2440	29	2460	39	2480

### 3.2.1 Test Mode Applicability and Tested Channel Detail

EUT Configure Mode	Applicable to		Description
	RE $\geq$ 1G	RE<1G	
A	√	√	BT Ant. 1
B	√	√	BT Ant. 2

Where RE $\geq$ 1G: Radiated Emission above 1GHz & Bandedge Measurement RE<1G: Radiated Emission below 1GHz

**NOTE:** For radiated emission (below 1GHz) and power line conducted emission test items, the worst radiated emission mode was selected.

**NOTE:** The EUT had been pre-tested on the positioned of each 3 axis. The worst case was found when positioned on **X-plane** for Mode A and **Y-plane** for Mode B

**NOTE:** "-" means no effect.

#### Radiated Emission Test (Above 1 GHz):

Pre-Scan has been conducted to determine the worst-case mode from all possible combinations between available modulations, data rates and antenna ports (if EUT with antenna diversity architecture).

Following channel(s) was (were) selected for the final test as listed below.

EUT Configure Mode	Mode	Freq. Range (MHz)	Available Channel	Tested Channel	Modulation Technology
A	802.11n (HT40) + BT	2412 ~ 2462	3 to 9	9 + 0	OFDM
		BT	0 to 78		GFSK
A	802.11n (HT40) + BT	5500 ~ 5720	102 to 142	102 + 0	OFDMA
		BT	0 to 78		GFSK
B	802.11n (HT40) + BT	2412 ~ 2462	3 to 9	9 + 0	OFDM
		BT	0 to 78		GFSK
B	802.11n (HT40) + BT	5500 ~ 5720	102 to 142	102 + 0	OFDMA
		BT	0 to 78		GFSK

#### Radiated Emission Test (Below 1GHz):

Pre-Scan has been conducted to determine the worst-case mode from all possible combinations between available modulations, data rates and antenna ports (if EUT with antenna diversity architecture).

Following channel(s) was (were) selected for the final test as listed below.

EUT Configure Mode	Mode	Freq. Range (MHz)	Available Channel	Tested Channel	Modulation Technology
A	802.11n (HT40) + BT	2412 ~ 2462	3 to 9	9 + 0	OFDM
		BT	0 to 78		GFSK
A	802.11n (HT40) + BT	5500 ~ 5720	102 to 142	102 + 0	OFDMA
		BT	0 to 78		GFSK
B	802.11n (HT40) + BT	2412 ~ 2462	3 to 9	9 + 0	OFDM
		BT	0 to 78		GFSK
B	802.11n (HT40) + BT	5500 ~ 5720	102 to 142	102 + 0	OFDMA
		BT	0 to 78		GFSK

#### Test Condition:

Applicable to	Environmental Conditions	Input Power (System)	Tested by
RE $\geq$ 1G	23 deg. C, 67% RH	120 Vac, 60 Hz	Getaz Yang
RE<1G	23 deg. C, 67% RH	120 Vac, 60 Hz	Getaz Yang

### 3.3 Description of Support Units

The EUT has been tested as an independent unit together with other necessary accessories or support units. The following support units or accessories were used to form a representative test configuration during the tests.

No.	Product	Brand	Model No.	Serial No.	FCC ID
A.	Notebook	Dell	E5420	FHP75S1	N/A

Note:

1. All power cords of the above support units are non-shielded (1.8m).
2. Item A acted as communication partners to transfer data.

#### 3.3.1 Configuration of System under Test

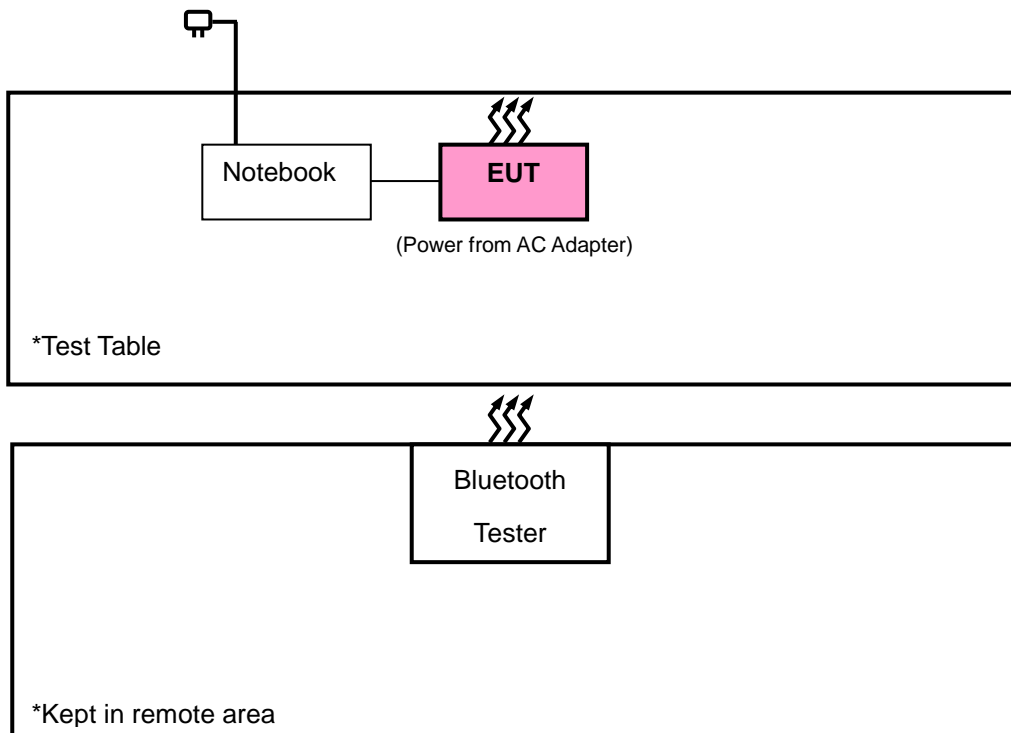

### **3.4 General Description of Applied Standards**

The EUT is a RF Product. According to the specifications of the manufacturer, it must comply with the requirements of the following standards and references:

#### **Test Standard:**

**FCC Part 15, Subpart C (15.247)**

**FCC Part 15, Subpart E (15.407)**

ANSI C63.10-2013

All test items have been performed and recorded as per the above standards.

#### **References Test Guidance:**

**KDB 558074 D01 Meas Guidance v05r02**

**KDB 662911 D01 Multiple Transmitter Output v02r01**

**KDB 789033 D02 General UNII Test Procedures New Rules v02r01**

All test items have been performed as a reference to the above KDB test guidance.

## 4 Test Types and Results

### 4.1 Radiated Emission and Bandedge Measurement

#### 4.1.1 Limits of Radiated Emission and Bandedge Measurement

Radiated emissions which fall in the restricted bands must comply with the radiated emission limits specified as below table.

Frequencies (MHz)	Field Strength (microvolts/meter)	Measurement Distance (meters)
0.009 ~ 0.490	2400/F(kHz)	300
0.490 ~ 1.705	24000/F(kHz)	30
1.705 ~ 30.0	30	30
30 ~ 88	100	3
88 ~ 216	150	3
216 ~ 960	200	3
Above 960	500	3

Note:

1. The lower limit shall apply at the transition frequencies.
2. Emission level (dBuV/m) = 20 log Emission level (uV/m).
3. For frequencies above 1000MHz, the field strength limits are based on average detector, however, the peak field strength of any emission shall not exceed the maximum permitted average limits, specified above by more than 20dB under any condition of modulation.

Limits of unwanted emission out of the restricted bands

Applicable To		Limit	
789033 D02 General UNII Test Procedure New Rules v02r01		Field Strength at 3m	
		PK: 74 (dBµV/m)	AV: 54 (dBµV/m)
Frequency Band	Applicable To	EIRP Limit	Equivalent Field Strength at 3m
5150~5250 MHz	15.407(b)(1)	PK: -27 (dBm/MHz)	PK: 68.2(dBµV/m)
5250~5350 MHz	15.407(b)(2)		
5470~5725 MHz	15.407(b)(3)		
5725~5850 MHz	<input checked="" type="checkbox"/> 15.407(b)(4)(i)	PK: -27 (dBm/MHz) <sup>*1</sup> PK: 10 (dBm/MHz) <sup>*2</sup> PK: 15.6 (dBm/MHz) <sup>*3</sup> PK: 27 (dBm/MHz) <sup>*4</sup>	PK: 68.2(dBµV/m) <sup>*1</sup> PK: 105.2 (dBµV/m) <sup>*2</sup> PK: 110.8(dBµV/m) <sup>*3</sup> PK: 122.2 (dBµV/m) <sup>*4</sup>
	<input type="checkbox"/> 15.407(b)(4)(ii)	Emission limits in section 15.247(d)	
*1 beyond 75 MHz or more above of the band edge.		*2 below the band edge increasing linearly to 10 dBm/MHz at 25 MHz above.	
*3 below the band edge increasing linearly to a level of 15.6 dBm/MHz at 5 MHz above.		*4 from 5 MHz above or below the band edge increasing linearly to a level of 27 dBm/MHz at the band edge.	

Note: The following formula is used to convert the equipment isotropic radiated power (eirp) to field strength:

$$E = \frac{1000000\sqrt{30P}}{3} \mu\text{V/m, where P is the eirp (Watts).}$$

#### 4.1.2 Test Instruments

Description & Manufacturer	Model No.	Serial No.	Date of Calibration	Due Date of Calibration
Test Receiver Agilent	N9038A	MY51210203	Mar. 18, 2020	Mar. 17, 2021
Spectrum Analyzer Agilent	N9010A	MY52220314	Dec. 12, 2019	Dec. 11, 2020
Spectrum Analyzer ROHDE & SCHWARZ	FSU43	101261	Apr. 16, 2020	Apr. 15, 2021
HORN Antenna SCHWARZBECK	BBHA 9120D	9120D-969	Nov. 24, 2019	Nov. 23, 2020
BILOG Antenna SCHWARZBECK	VULB 9168	9168-472	Nov. 08, 2019	Nov. 07, 2020
Fixed Attenuator WOKEN	MDCS18N-10	MDCS18N-10-01	Apr. 14, 2020	Apr. 13, 2021
Loop Antenna	EM-6879	269	Sep. 17, 2020	Sep. 16, 2021
Preamplifier EMCI	EMC001340	980201	Oct. 21, 2020	Oct. 20, 2021
Bluetooth Tester	CBT	100946	Aug. 06, 2020	Aug. 05, 2022
Preamplifier EMCI	EMC 012645	980115	Oct. 07, 2020	Oct. 06, 2021
Preamplifier EMCI	EMC 184045	980116	Oct. 07, 2020	Oct. 06, 2021
Preamplifier EMCI	EMC 330H	980112	Oct. 07, 2020	Oct. 06, 2021
Power Meter Anritsu	ML2495A	1012010	Sep. 01, 2020	Aug. 31, 2021
Power Sensor Anritsu	MA2411B	1315050	Sep. 01, 2020	Aug. 31, 2021
RF Coaxial Cable EMCI	EMC104-SM-SM-8000	171005	Oct. 07, 2020	Oct. 06, 2021
RF Coaxial Cable HUBER+SUHNNER	SUCOFLEX 104	EMC104-SM-SM-1000(140807)	Oct. 07, 2020	Oct. 06, 2021
RF Coaxial Cable WOKEN	8D-FB	Cable-Ch10-01	Oct. 07, 2020	Oct. 06, 2021
Boresight Antenna Fixture	FBA-01	FBA-SIP01	NA	NA
Software BV ADT	E3 6.120103	NA	NA	NA
Antenna Tower MF	MFA-440H	NA	NA	NA
Turn Table MF	MFT-201SS	NA	NA	NA
Antenna Tower & Turn Table Controller MF	MF-7802	NA	NA	NA

Note: 1. The calibration interval of the above test instruments is 12 / 24 months and the calibrations are traceable to NML/ROC and NIST/USA.

2. The test was performed in HwaYa Chamber 10.



### 4.1.3 Test Procedures

#### For Radiated emission below 30MHz

- a. The EUT was placed on the top of a rotating table 0.8 meters above the ground at a 3 meter chamber room. The table was rotated 360 degrees to determine the position of the highest radiation.
- b. The EUT was set 3 meters away from the interference-receiving antenna, which was mounted on the top of a variable-height antenna tower.
- c. Parallel, perpendicular, and ground-parallel orientations of the antenna are set to make the measurement.
- d. For each suspected emission, the EUT was arranged to its worst case and the rotatable table was turned from 0 degrees to 360 degrees to find the maximum reading.
- e. The test-receiver system was set to Quasi-Peak Detect Function and Specified Bandwidth with Maximum Hold Mode.

Note:

1. The resolution bandwidth and video bandwidth of test receiver/spectrum analyzer is 9kHz at frequency below 30MHz.

#### For Radiated emission above 30MHz

- a. The EUT was placed on the top of a rotating table 0.8 meters (for 30MHz ~ 1GHz) / 1.5 meters (for above 1GHz) above the ground at 3 meter chamber room for test. The table was rotated 360 degrees to determine the position of the highest radiation.
- b. The EUT was set 3 meters away from the interference-receiving antenna, which was mounted on the top of a variable-height antenna tower.
- c. The height of antenna is varied from one meter to four meters above the ground to determine the maximum value of the field strength. Both horizontal and vertical polarizations of the antenna are set to make the measurement.
- d. For each suspected emission, the EUT was arranged to its worst case and then the antenna was tuned to heights from 1 meter to 4 meters and the rotatable table was turned from 0 degrees to 360 degrees to find the maximum reading.
- e. The test-receiver system was set to quasi-peak detect function and specified bandwidth with maximum hold mode when the test frequency is below 1 GHz.
- f. The test-receiver system was set to peak and average detect function and specified bandwidth with maximum hold mode when the test frequency is above 1 GHz. If the peak reading value also meets average limit, measurement with the average detector is unnecessary.

Note:

1. The resolution bandwidth and video bandwidth of test receiver/spectrum analyzer is 120kHz for Quasi-peak detection (QP) at frequency below 1GHz.
2. For Bluetooth FHSS device measurement, the resolution bandwidth of test receiver/spectrum analyzer is 1 MHz and the video bandwidth is 3 MHz for Peak detection (PK) and Average detection (AV) at frequency above 1 GHz. For fundamental and harmonic signal measurement, according to ANSI C63.10 section 7.5, the average value = peak value + duty cycle correction factor. The duty cycle correction factor refer to Chapter 3.3 of the BV CPS report no: RFBGTL-WTW-P20100273.
3. For WLAN device measurement, the resolution bandwidth of test receiver/spectrum analyzer is 1 MHz and the video bandwidth is 3 MHz for Peak detection (PK) at frequency above 1 GHz. The resolution bandwidth of test receiver/spectrum analyzer is 1MHz and the video bandwidth is  $\geq 1/T$  (Duty cycle < 98%) or 10Hz (Duty cycle  $\geq 98\%$ ) for Average detection (AV) at frequency above 1GHz.
4. All modes of operation were investigated and the worst-case emissions are reported.

#### 4.1.4 Deviation from Test Standard

No deviation.

#### 4.1.5 Test Setup

For Radiated emission below 30MHz

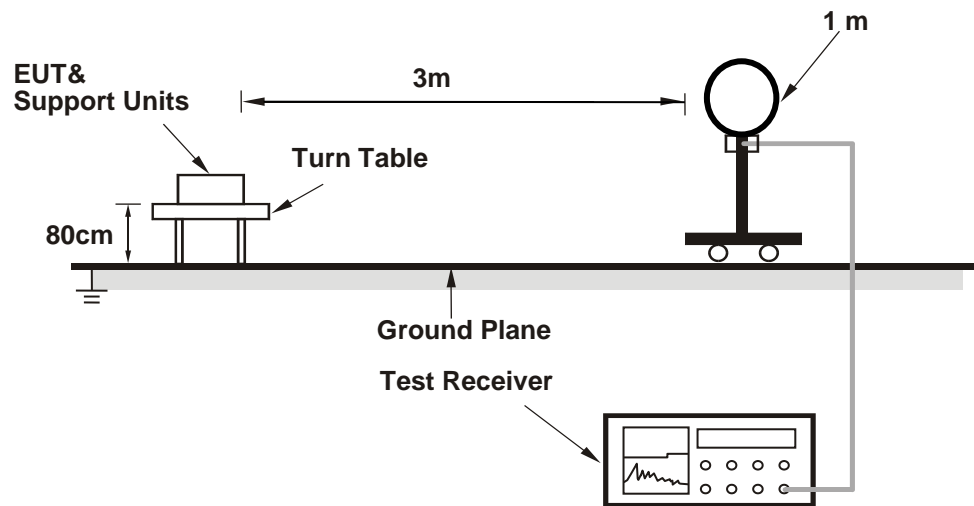

For Radiated emission 30MHz to 1GHz

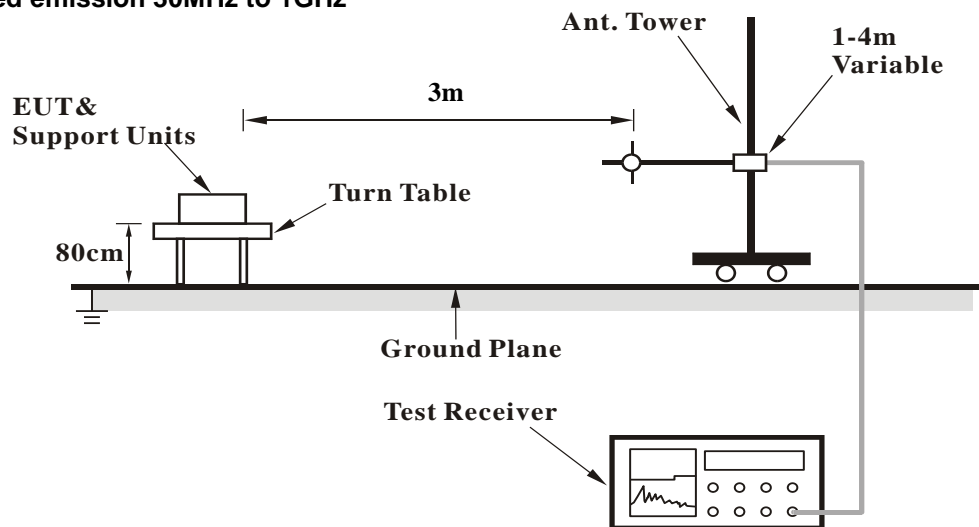

### For Radiated emission above 1GHz

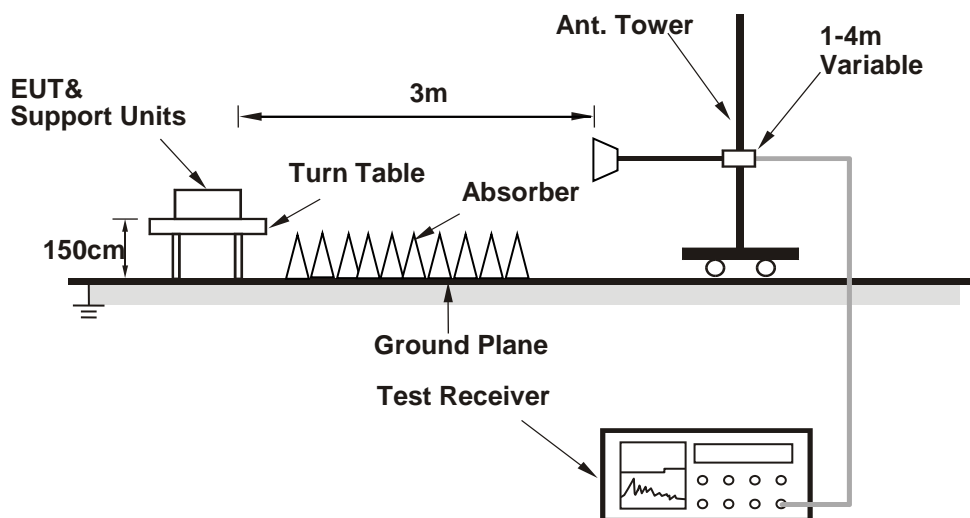

For the actual test configuration, please refer to the attached file (Test Setup Photo).

#### 4.1.6 EUT Operating Conditions

- a. Placed the EUT on the testing table.
- b. Prepared a notebook to act as a communication partner and placed it outside of testing area.
- c. The communication partner connected with EUT via a RJ45 cable and ran a test program (provided by manufacturer) to enable EUT under transmission condition continuously at specific channel frequency.
- d. The communication partner sent data to EUT by command "PING".

#### 4.1.7 Test Results

Above 1GHz Data:

Mode A:

802.11n (HT40) + BT

EUT Test Condition		Measurement Detail	
Channel	Channel 9 + Channel 0	Frequency Range	1 GHz ~ 40 GHz
Input Power	120 Vac, 60 Hz	Detector Function	Peak (PK) Average (AV)
Environmental Conditions	25 deg. C, 65 % RH	Tested By	Getaz Yang

Antenna Polarity & Test Distance: Horizontal at 3 m								
Frequency (MHz)	Emission Level (dBuV/m)	Read Level (dBuV)	Factor (dB/m)	Limit (dBuV/m)	Margin (dB)	Antenna Height (cm)	Table Angle (Degree)	Remark
2390	44.12	12.52	31.6	54	-9.88	196	238	Average
2390	36.85	42.77	-5.92	54	-17.15	130	111	Average
2390	46.56	52.48	-5.92	74	-27.44	130	111	Peak
2390	45.62	51.54	-5.92	74	-28.38	196	238	Peak
2402	64.95	70.89	-5.94	-----	-----	196	238	Average
2402	95.7	101.64	-5.94	-----	-----	196	238	Peak
2452	85.48	91.3	-5.82	-----	-----	130	111	Average
2452	92.82	98.64	-5.82	-----	-----	130	111	Peak
2483.5	44.01	49.71	-5.7	54	-9.99	130	111	Average
2483.5	58.1	63.8	-5.7	74	-15.9	130	111	Peak
4804	32.69	48.33	-15.64	54	-21.31	138	145	Average
4804	42.78	58.42	-15.64	74	-31.22	138	145	Peak
4904	33.83	49.38	-15.55	54	-20.17	158	139	Average
4904	43.06	58.61	-15.55	74	-30.94	158	139	Peak
Antenna Polarity & Test Distance: Vertical at 3 m								
Frequency (MHz)	Emission Level (dBuV/m)	Read Level (dBuV)	Factor (dB/m)	Limit (dBuV/m)	Margin (dB)	Antenna Height (cm)	Table Angle (Degree)	Remark
2390	43.24	11.64	31.6	54	-10.76	105	59	Average
2390	36.66	42.58	-5.92	54	-17.34	321	264	Average
2390	46.27	52.19	-5.92	74	-27.73	321	264	Peak
2390	45.64	51.56	-5.92	74	-28.36	105	59	Peak
2402	60.68	66.62	-5.94	-----	-----	105	59	Average
2402	91.43	97.37	-5.94	-----	-----	105	59	Peak
2452	84.66	90.48	-5.82	-----	-----	321	264	Average
2452	91.36	97.18	-5.82	-----	-----	321	264	Peak
2483.5	44.28	49.98	-5.7	54	-9.72	321	264	Average
2483.5	58.57	64.27	-5.7	74	-15.43	321	264	Peak
4804	32.65	48.29	-15.64	54	-21.35	138	182	Average
4804	42.86	58.5	-15.64	74	-31.14	138	182	Peak
4904	34.2	49.75	-15.55	54	-19.8	100	47	Average
4904	43.85	59.4	-15.55	74	-30.15	100	47	Peak

Remarks:

1. Emission Level(dBuV/m) = Raw Value(dBuV) + Correction Factor(dB/m).
2. Correction Factor(dB/m) = Antenna Factor(dB/m) + Cable Factor(dB) – Pre-Amplifier Factor(dB).
3. Margin value = Emission Level – Limit value.
4. The other emission levels were very low against the limit.
5. " \* ": Fundamental frequency.

802.11n (HT40) + BT

EUT Test Condition		Measurement Detail	
Channel	Channel 102 + Channel 0	Frequency Range	1 GHz ~ 40 GHz
Input Power	120 Vac, 60 Hz	Detector Function	Peak (PK) Average (AV)
Environmental Conditions	25 deg. C, 65 % RH	Tested By	Getaz Yang

Antenna Polarity & Test Distance: Horizontal at 3 m								
Frequency (MHz)	Emission Level (dBuV/m)	Read Level (dBuV)	Factor (dB/m)	Limit (dBuV/m)	Margin (dB)	Antenna Height (cm)	Table Angle (Degree)	Remark
2390	43.31	11.71	31.6	54	-10.69	217	236	Average
2390	46	51.92	-5.92	74	-28	217	236	Peak
2402	66.19	72.13	-5.94	-----	-----	217	236	Average
2402	96.94	102.88	-5.94	-----	-----	217	236	Peak
4804	32.59	48.23	-15.64	54	-21.41	133	162	Average
4804	42	57.64	-15.64	74	-32	133	162	Peak
5460	44.88	44.13	0.75	54	-9.12	113	36	Average
5460	53.18	52.43	0.75	74	-20.82	113	36	Peak
5470	60.46	59.69	0.77	68.2	-7.74	113	36	Peak
5510	93.87	93	0.87	-----	-----	113	36	Average
5510	100.52	99.65	0.87	-----	-----	113	36	Peak
5725	49.29	48.42	0.87	68.2	-18.91	113	36	Peak
11020	47.62	48.95	-1.33	54	-6.38	149	173	Average
11020	58.11	59.44	-1.33	74	-15.89	149	173	Peak

Antenna Polarity & Test Distance: Vertical at 3 m								
Frequency (MHz)	Emission Level (dBuV/m)	Read Level (dBuV)	Factor (dB/m)	Limit (dBuV/m)	Margin (dB)	Antenna Height (cm)	Table Angle (Degree)	Remark
2390	42.85	11.25	31.6	54	-11.15	100	59	Peak
2390	45.43	51.35	-5.92	74	-28.57	100	59	Peak
2402	61.05	66.99	-5.94	-----	-----	100	59	Average
2402	91.8	97.74	-5.94	-----	-----	100	59	Peak
4804	32.68	48.32	-15.64	54	-21.32	133	149	Average
4804	42.08	57.72	-15.64	74	-31.92	133	149	Peak
5460	42.65	41.9	0.75	54	-11.35	367	90	Average
5460	50.47	49.72	0.75	74	-23.53	367	90	Peak
5470	58.53	57.76	0.77	68.2	-9.67	367	90	Peak
5510	91.31	90.44	0.87	-----	-----	367	90	Average
5510	98.82	97.95	0.87	-----	-----	367	90	Peak
5725	50.54	49.67	0.87	68.2	-17.66	367	90	Peak
11020	47.42	48.75	-1.33	54	-6.58	112	224	Average
11020	57.8	59.13	-1.33	74	-16.2	112	224	Peak

Remarks:

1. Emission Level(dBuV/m) = Raw Value(dBuV) + Correction Factor(dB/m).
2. Correction Factor(dB/m) = Antenna Factor(dB/m) + Cable Factor(dB) – Pre-Amplifier Factor(dB).
3. Margin value = Emission Level – Limit value.
4. The other emission levels were very low against the limit.
5. " \* ": Fundamental frequency.

Mode B:

802.11n (HT40) + BT

EUT Test Condition		Measurement Detail	
Channel	Channel 9 + Channel 0	Frequency Range	1 GHz ~ 40 GHz
Input Power	120 Vac, 60 Hz	Detector Function	Peak (PK) Average (AV)
Environmental Conditions	25 deg. C, 65 % RH	Tested By	Getaz Yang

Antenna Polarity & Test Distance: Horizontal at 3 m								
Frequency (MHz)	Emission Level (dBuV/m)	Read Level (dBuV)	Factor (dB/m)	Limit (dBuV/m)	Margin (dB)	Antenna Height (cm)	Table Angle (Degree)	Remark
2390	44.31	12.71	31.6	54	-9.69	146	224	Average
2390	37	42.92	-5.92	54	-17	130	108	Average
2390	46.09	52.01	-5.92	74	-27.91	130	108	Peak
2390	45.77	51.69	-5.92	74	-28.23	146	224	Peak
2402	69.92	75.86	-5.94	-----	-----	146	224	Average
2402	100.59	106.53	-5.94	-----	-----	146	224	Peak
2452	56.83	62.65	-5.82	-----	-----	130	108	Average
2452	93.72	99.54	-5.82	-----	-----	130	108	Peak
2483.5	44.79	50.49	-5.7	54	-9.21	130	108	Average
2483.5	59.58	65.28	-5.7	74	-14.42	130	108	Peak
4800	32.7	48.34	-15.64	54	-21.3	133	159	Average
4800	41.64	57.28	-15.64	74	-32.36	133	159	Peak
4904	34.22	49.77	-15.55	54	-19.78	148	127	Average
4904	42.42	57.97	-15.55	74	-31.58	148	127	Peak
Antenna Polarity & Test Distance: Vertical at 3 m								
Frequency (MHz)	Emission Level (dBuV/m)	Read Level (dBuV)	Factor (dB/m)	Limit (dBuV/m)	Margin (dB)	Antenna Height (cm)	Table Angle (Degree)	Remark
2390	43.42	11.82	31.6	54	-10.58	202	74	Average
2390	36.63	42.55	-5.92	54	-17.37	318	261	Average
2390	46.44	52.36	-5.92	74	-27.56	318	261	Peak
2390	46.98	52.9	-5.92	74	-27.02	202	74	Peak
2402	64.25	70.19	-5.94	-----	-----	202	74	Average
2402	95.01	100.95	-5.94	-----	-----	202	74	Peak
2452	84.54	90.36	-5.82	-----	-----	318	261	Average
2452	91.25	97.07	-5.82	-----	-----	318	261	Peak
2483.5	45.27	50.97	-5.7	54	-8.73	318	261	Average
2483.5	59.48	65.18	-5.7	74	-14.52	318	261	Peak
4804	32.87	48.51	-15.64	54	-21.13	160	271	Average
4804	41.18	56.82	-15.64	74	-32.82	160	271	Peak
4904	33.17	48.72	-15.55	54	-20.83	108	41	Average
4904	42.01	57.56	-15.55	74	-31.99	108	41	Peak

Remarks:

1. Emission Level(dBuV/m) = Raw Value(dBuV) + Correction Factor(dB/m).
2. Correction Factor(dB/m) = Antenna Factor(dB/m) + Cable Factor(dB) – Pre-Amplifier Factor(dB).
3. Margin value = Emission Level – Limit value.
4. The other emission levels were very low against the limit.
5. " \* ": Fundamental frequency.

802.11n (HT40) + BT

EUT Test Condition		Measurement Detail	
Channel	Channel 102 + Channel 0	Frequency Range	1 GHz ~ 40 GHz
Input Power	120 Vac, 60 Hz	Detector Function	Peak (PK) Average (AV)
Environmental Conditions	25 deg. C, 65 % RH	Tested By	Getaz Yang

Antenna Polarity & Test Distance: Horizontal at 3 m								
Frequency (MHz)	Emission Level (dBuV/m)	Read Level (dBuV)	Factor (dB/m)	Limit (dBuV/m)	Margin (dB)	Antenna Height (cm)	Table Angle (Degree)	Remark
2390	42.99	11.39	31.6	54	-11.01	100	222	Average
2390	45.07	50.99	-5.92	74	-28.93	100	222	Peak
2402	69.92	75.86	-5.94	-----	-----	100	222	Average
2402	100.68	106.62	-5.94	-----	-----	100	222	Peak
4800	32.61	48.25	-15.64	54	-21.39	144	134	Average
4800	43.12	58.76	-15.64	74	-30.88	144	134	Peak
5460	44.81	44.06	0.75	54	-9.19	118	61	Average
5460	52.87	52.12	0.75	74	-21.13	118	61	Peak
5470	60.52	59.75	0.77	68.2	-7.68	118	61	Peak
5510	93.93	93.06	0.87	-----	-----	118	61	Average
5510	100.74	99.87	0.87	-----	-----	118	61	Peak
5725	48.43	47.56	0.87	68.2	-19.77	118	61	Peak
11020	47.37	48.7	-1.33	54	-6.63	144	167	Average
11020	57.83	59.16	-1.33	74	-16.17	144	167	Peak

Antenna Polarity & Test Distance: Vertical at 3 m								
Frequency (MHz)	Emission Level (dBuV/m)	Read Level (dBuV)	Factor (dB/m)	Limit (dBuV/m)	Margin (dB)	Antenna Height (cm)	Table Angle (Degree)	Remark
2390	43.09	11.49	31.6	54	-10.91	204	73	Average
2390	45.79	51.71	-5.92	74	-28.21	204	73	Peak
2402	64.65	70.59	-5.94	-----	-----	204	73	Average
2402	95.41	101.35	-5.94	-----	-----	204	73	Peak
4804	32.5	48.14	-15.64	54	-21.5	161	277	Average
4804	42.87	58.51	-15.64	74	-31.13	161	277	Peak
5460	43.34	42.59	0.75	54	-10.66	388	89	Average
5460	51.2	50.45	0.75	74	-22.8	388	89	Peak
5470	56.39	55.62	0.77	68.2	-11.81	388	89	Peak
5510	92.4	91.53	0.87	-----	-----	388	89	Average
5510	98.78	97.91	0.87	-----	-----	388	89	Peak
5725	49.65	48.78	0.87	68.2	-18.55	388	89	Peak
11020	48.09	49.42	-1.33	54	-5.91	106	215	Average
11020	57.84	59.17	-1.33	74	-16.16	106	215	Peak

Remarks:

1. Emission Level(dBuV/m) = Raw Value(dBuV) + Correction Factor(dB/m).
2. Correction Factor(dB/m) = Antenna Factor(dB/m) + Cable Factor(dB) – Pre-Amplifier Factor(dB).
3. Margin value = Emission Level – Limit value.
4. The other emission levels were very low against the limit.
5. " \* " : Fundamental frequency.

Below 1GHz data

Mode A

802.11n (HT40) + BT

EUT Test Condition		Measurement Detail	
Channel	Channel 9 + Channel 0	Frequency Range	30 MHz ~ 1 GHz
Input Power	120 Vac, 60 Hz	Detector Function	Peak (PK) Quasi-peak (QP)
Environmental Conditions	25 deg. C, 65 % RH	Tested By	Cyril Chen

### Horizontal

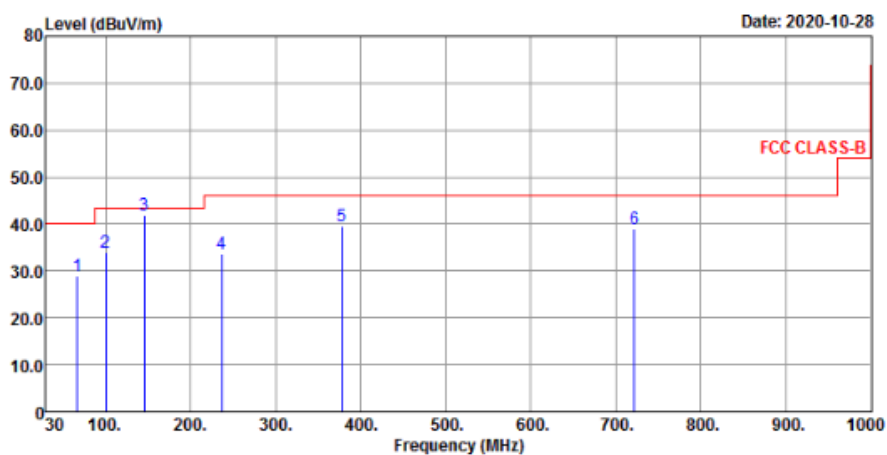

### Vertical

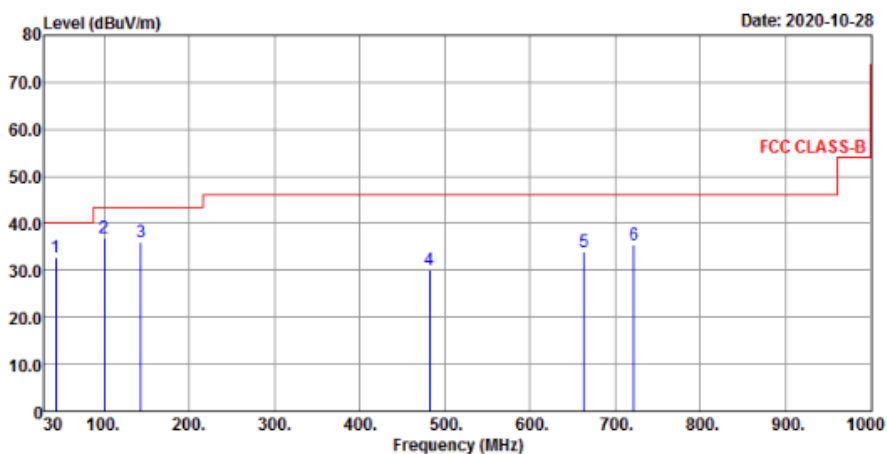



**Antenna Polarity & Test Distance: Horizontal at 3 m**

Frequency (MHz)	Emission Level (dBuV/m)	Read Level (dBuV)	Factor (dB/m)	Limit (dBuV/m)	Margin (dB)	Antenna Height (cm)	Table Angle (Degree)	Remark
66.86	28.93	42.12	-13.19	40	-11.07	157	258	QP
99.84	33.8	49.83	-16.03	43.5	-9.7	133	169	QP
145.43	42.02	53.82	-11.8	43.5	-1.48	125	184	QP
236.61	33.64	47.26	-13.62	46	-12.36	195	215	QP
378.23	39.66	48.43	-8.77	46	-6.34	184	186	QP
721.61	38.97	39.12	-0.15	46	-7.03	154	125	QP

**Antenna Polarity & Test Distance: Vertical at 3 m**

Frequency (MHz)	Emission Level (dBuV/m)	Read Level (dBuV)	Factor (dB/m)	Limit (dBuV/m)	Margin (dB)	Antenna Height (cm)	Table Angle (Degree)	Remark
43.58	32.71	44.63	-11.92	40	-7.29	110	158	QP
99.84	36.92	52.95	-16.03	43.5	-6.58	179	154	QP
143.49	36.09	48	-11.91	43.5	-7.41	169	247	QP
482.02	30.24	36.04	-5.8	46	-15.76	133	244	QP
663.41	33.99	35.41	-1.42	46	-12.01	155	169	QP
721.61	35.4	35.55	-0.15	46	-10.6	164	237	QP

Remarks:

- Emission Level = Read Level + Factor  
Margin value = Emission level – Limit value
- The emission levels of other frequencies were very low against the limit

802.11n (HT40) + BT

EUT Test Condition		Measurement Detail	
Channel	Channel 102 + Channel 0	Frequency Range	30 MHz ~ 1 GHz
Input Power	120 Vac, 60 Hz	Detector Function	Peak (PK) Quasi-peak (QP)
Environmental Conditions	25 deg. C, 65 % RH	Tested By	Cyril Chen

Horizontal

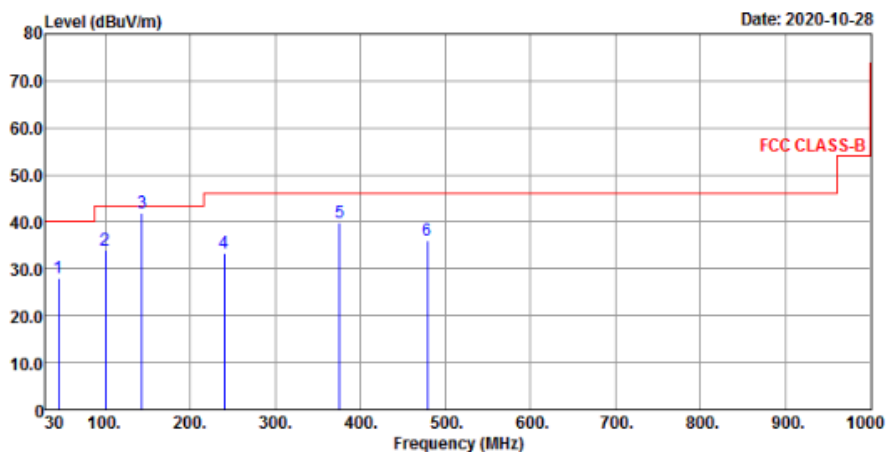

Vertical

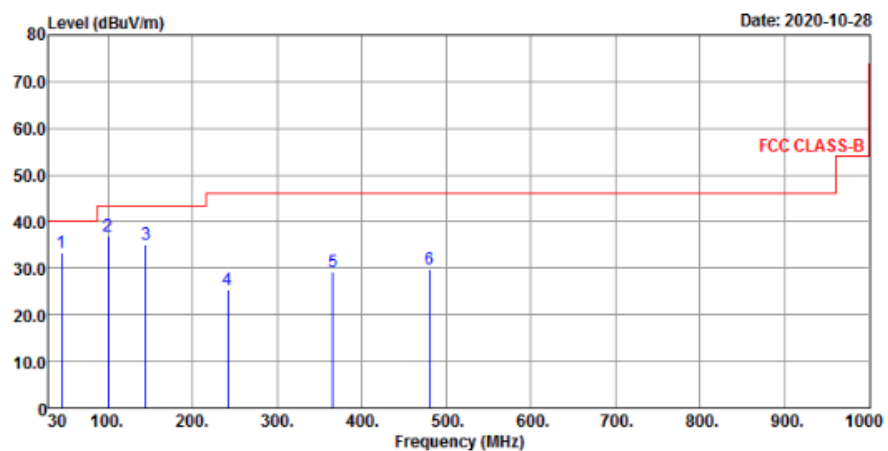

Antenna Polarity & Test Distance: Horizontal at 3 m								
Frequency (MHz)	Emission Level (dBuV/m)	Read Level (dBuV)	Factor (dB/m)	Limit (dBuV/m)	Margin (dB)	Antenna Height (cm)	Table Angle (Degree)	Remark
44.55	27.94	39.81	-11.87	40	-12.06	149	148	QP
99.84	34.09	50.12	-16.03	43.5	-9.41	106	123	QP
143.49	41.82	53.73	-11.91	43.5	-1.68	147	125	QP
239.52	33.44	46.84	-13.4	46	-12.56	107	159	QP
375.32	39.94	48.78	-8.84	46	-6.06	149	156	QP
479.11	35.88	41.71	-5.83	46	-10.12	106	128	QP
Antenna Polarity & Test Distance: Vertical at 3 m								
Frequency (MHz)	Emission Level (dBuV/m)	Read Level (dBuV)	Factor (dB/m)	Limit (dBuV/m)	Margin (dB)	Antenna Height (cm)	Table Angle (Degree)	Remark
44.55	33.45	45.32	-11.87	40	-6.55	142	133	QP
99.84	36.94	52.97	-16.03	43.5	-6.56	162	254	QP
144.46	35.15	46.99	-11.84	43.5	-8.35	164	237	QP
241.46	25.37	38.67	-13.3	46	-20.63	188	127	QP
365.62	29.11	38.32	-9.21	46	-16.89	163	182	QP
480.08	29.8	35.61	-5.81	46	-16.2	147	215	QP

Remarks:

- Emission Level = Read Level + Factor  
Margin value = Emission level – Limit value
- The emission levels of other frequencies were very low against the limit

Mode B

802.11n (HT40) + BT

EUT Test Condition		Measurement Detail	
Channel	Channel 9 + Channel 0	Frequency Range	30 MHz ~ 1 GHz
Input Power	120 Vac, 60 Hz	Detector Function	Peak (PK) Quasi-peak (QP)
Environmental Conditions	25 deg. C, 65 % RH	Tested By	Cyril Chen

Horizontal

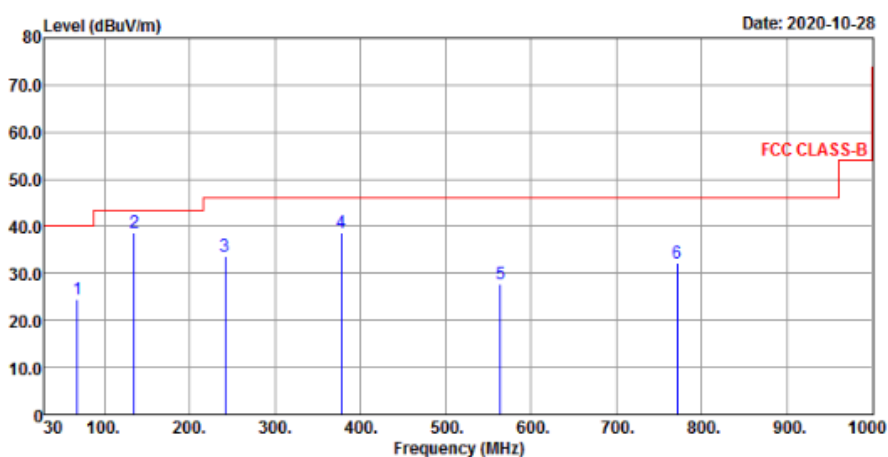

Vertical

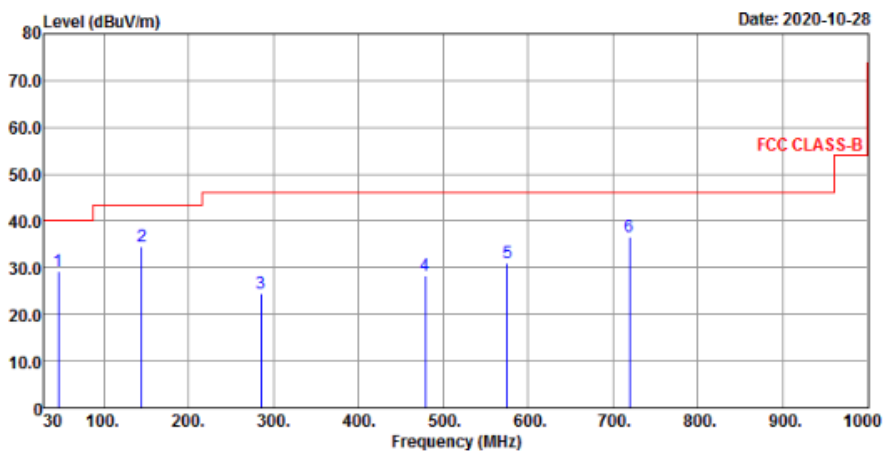

Antenna Polarity & Test Distance: Horizontal at 3 m								
Frequency (MHz)	Emission Level (dBuV/m)	Read Level (dBuV)	Factor (dB/m)	Limit (dBuV/m)	Margin (dB)	Antenna Height (cm)	Table Angle (Degree)	Remark
68.8	24.59	38.44	-13.85	40	-15.41	178	257	QP
134.76	38.71	51.21	-12.5	43.5	-4.79	146	130	QP
241.46	33.65	46.95	-13.3	46	-12.35	108	117	QP
378.23	38.78	47.55	-8.77	46	-7.22	153	262	QP
564.47	27.68	31.64	-3.96	46	-18.32	194	219	QP
771.08	32.14	30.87	1.27	46	-13.86	186	214	QP
Antenna Polarity & Test Distance: Vertical at 3 m								
Frequency (MHz)	Emission Level (dBuV/m)	Read Level (dBuV)	Factor (dB/m)	Limit (dBuV/m)	Margin (dB)	Antenna Height (cm)	Table Angle (Degree)	Remark
46.49	29.32	41.09	-11.77	40	-10.68	122	221	QP
144.46	34.49	46.33	-11.84	43.5	-9.01	141	157	QP
285.11	24.37	35.93	-11.56	46	-21.63	166	194	QP
479.11	28.29	34.12	-5.83	46	-17.71	198	151	QP
575.14	30.95	34.52	-3.57	46	-15.05	123	125	QP
719.67	36.49	36.73	-0.24	46	-9.51	156	158	QP

Remarks:

1. Emission Level = Read Level + Factor  
Margin value = Emission level – Limit value
2. The emission levels of other frequencies were very low against the limit

802.11n (HT40) + BT

EUT Test Condition		Measurement Detail	
Channel	Channel 102 + Channel 0	Frequency Range	30 MHz ~ 1 GHz
Input Power	120 Vac, 60 Hz	Detector Function	Peak (PK) Quasi-peak (QP)
Environmental Conditions	25 deg. C, 65 % RH	Tested By	Cyril Chen

Horizontal

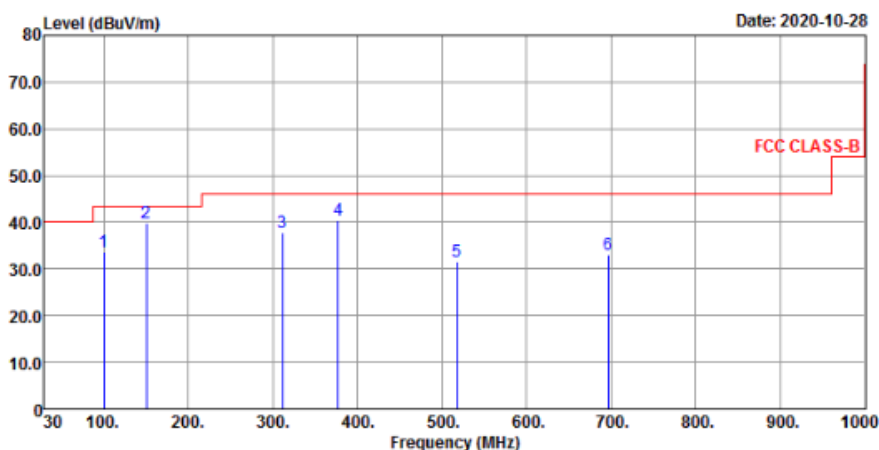

Vertical

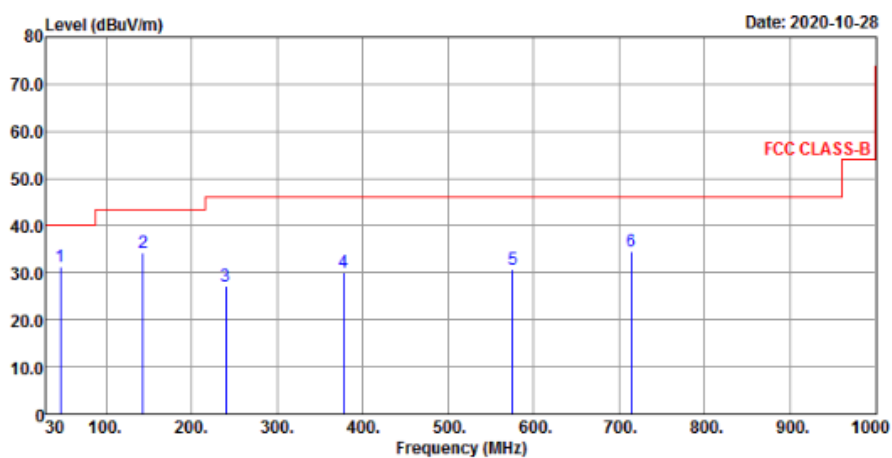

Antenna Polarity & Test Distance: Horizontal at 3 m								
Frequency (MHz)	Emission Level (dBuV/m)	Read Level (dBuV)	Factor (dB/m)	Limit (dBuV/m)	Margin (dB)	Antenna Height (cm)	Table Angle (Degree)	Remark
99.84	33.53	49.56	-16.03	43.5	-9.97	143	301	QP
150.28	39.94	51.65	-11.71	43.5	-3.56	166	299	QP
311.3	37.68	48.41	-10.73	46	-8.32	107	159	QP
377.26	40.34	49.13	-8.79	46	-5.66	155	288	QP
517.91	31.46	36.63	-5.17	46	-14.54	139	268	QP
696.39	33.16	33.87	-0.71	46	-12.84	152	144	QP
Antenna Polarity & Test Distance: Vertical at 3 m								
Frequency (MHz)	Emission Level (dBuV/m)	Read Level (dBuV)	Factor (dB/m)	Limit (dBuV/m)	Margin (dB)	Antenna Height (cm)	Table Angle (Degree)	Remark
46.49	31.41	43.18	-11.77	40	-8.59	170	281	QP
143.49	34.19	46.1	-11.91	43.5	-9.31	163	95	QP
239.52	27.02	40.42	-13.4	46	-18.98	138	210	QP
378.23	29.97	38.74	-8.77	46	-16.03	157	274	QP
575.14	30.56	34.13	-3.57	46	-15.44	139	228	QP
714.82	34.58	34.96	-0.38	46	-11.42	118	264	QP

Remarks:

- Emission Level = Read Level + Factor  
Margin value = Emission level – Limit value
- The emission levels of other frequencies were very low against the limit

## 5 Pictures of Test Arrangements

Please refer to the attached file (Test Setup Photo).



## Appendix – Information of the Testing Laboratories

We, Bureau Veritas Consumer Products Services (H.K.) Ltd., Taoyuan Branch, were founded in 1988 to provide our best service in EMC, Radio, Telecom and Safety consultation. Our laboratories are FCC recognized accredited test firms and accredited and approved according to ISO/IEC 17025.

If you have any comments, please feel free to contact us at the following:

### Lin Kou EMC/RF Lab

Tel: 886-2-26052180

Fax: 886-2-26051924

### Hsin Chu EMC/RF/Telecom Lab

Tel: 886-3-6668565

Fax: 886-3-6668323

### Hwa Ya EMC/RF/Safety

Tel: 886-3-3183232

Fax: 886-3-3270892

**Email:** [service.adt@tw.bureauveritas.com](mailto:service.adt@tw.bureauveritas.com)

**Web Site:** [www.bureauveritas-adt.com](http://www.bureauveritas-adt.com)

The address and road map of all our labs can be found in our web site also.

--- END ---