

WBU053-LGABT Product Specification

802.11a/b/g/n 2T2R with
Bluetooth combo wireless module

Approved:	Approved:	Prepared by:
		
Zeke Wu Senior Director	Ben Ho Supervisor	Kevin Yao Engineer

Revision History

Date	Version	Approver	Comments
October 7, 2020	1.0	Kevin Yao	Initial Released
October 29, 2020	1.1	Cathy Kuo	Updated Page 11, 12, 14 BT Power range

RESTRICTED AND CONFIDENTIAL INFORMATION STATEMENT

All information contained in this document is the exclusive property of Foxconn Technology Inc. and its development partners. Any reproduction or disclosure of all or part of this document without the expressed written consent of Foxconn Technology Inc. is strictly prohibited.

CHAPTER 1. MODULE OVERVIEW

WBU053-LGABT is highly integrated module which features a low power 2x2 11 a/b/g/n dual-band Wi-Fi subsystem and a Bluetooth subsystem. The Wi-Fi subsystem contains the 802.11 a/b/g/n radio, baseband, and MAC that are designed to meet both the low power and high throughput application.

WBU053-LGABT has a 32-bit RISC MCU that handles Wi-Fi and Bluetooth tasks, and an ARM Cortex-R4 MCU that could offload data frame processing in Wi-Fi host driver. The Bluetooth subsystem contains the Bluetooth radio, baseband, link controller. It also uses the 32-bit RISC MCU for the Bluetooth protocols.

1-1 Key Characteristic

- 32-bits RISC MCU for Wi-Fi protocols
- IEEE 802.11 a/b/g/n compliant
- Support 20MHz, 40MHz in 2.4GHz band 5GHz band
- Dual-band 2T2R mode with data rate up to 240Mbps
- Integrated LNA, PA, and T/R switch
- Security support for WFA WPA/WPA2 personal, WPS2.0, WAPI
- Integrated BALUN and PA
- USB device fully compliant to USB v3.0 specification
- Bluetooth specification 2.1+EDR
- Bluetooth 4.2 Low Energy (LE)
- Bluetooth 5.0

1-2 Pin Definition

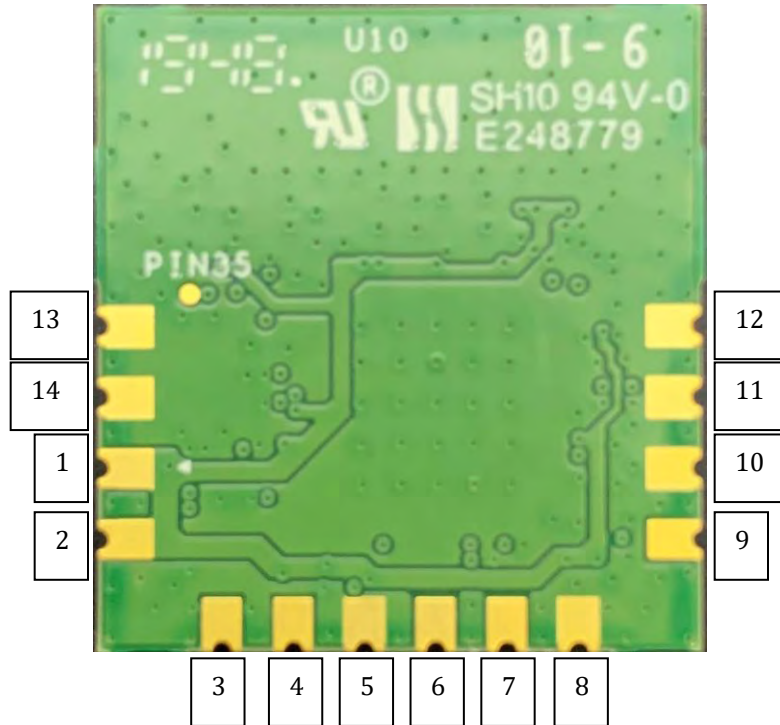

Figure 1 Pin Definitions (Module Top View)

Pin number	Symbol name	Type	Pin description
1	VBUS	Power	DC 3.3V
2	VBUS	Power	DC 3.3V
3	U2D-	I/O	USB data -
4	U2D+	I/O	USB data +
5	GND	GND	Ground
6	PMU_EN	I/O	reset
7	WIFI_INT_B	I/O	Wi-Fi_wake on
8	GND	GND	Ground
9	BGF_INT_B	I/O	BT_wake on
10-14	GND	GND	Ground

Table 1 Pin Definitions

1-3 Power Sequence

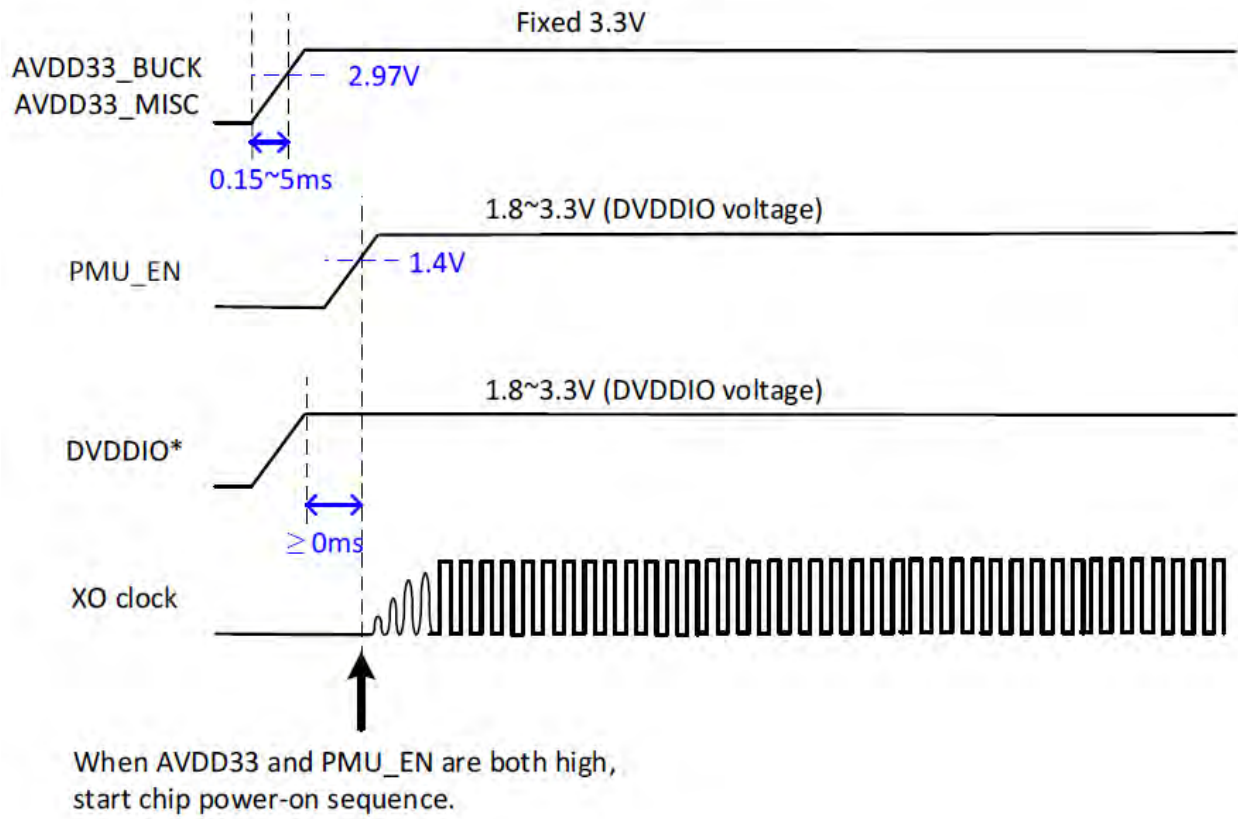

Figure 2 Power Sequence

1-4 Soldering Specification

Temperature

温度设置 (摄氏度)												
温区	1	2	3	4	5	6	7	8	9	10	11	12
上温区	135	155	160	173	175	180	185	215	240	250	249	220
下温区	135	155	160	173	175	180	185	215	240	250	249	220
传送带速度 (公分/分):	100.0											

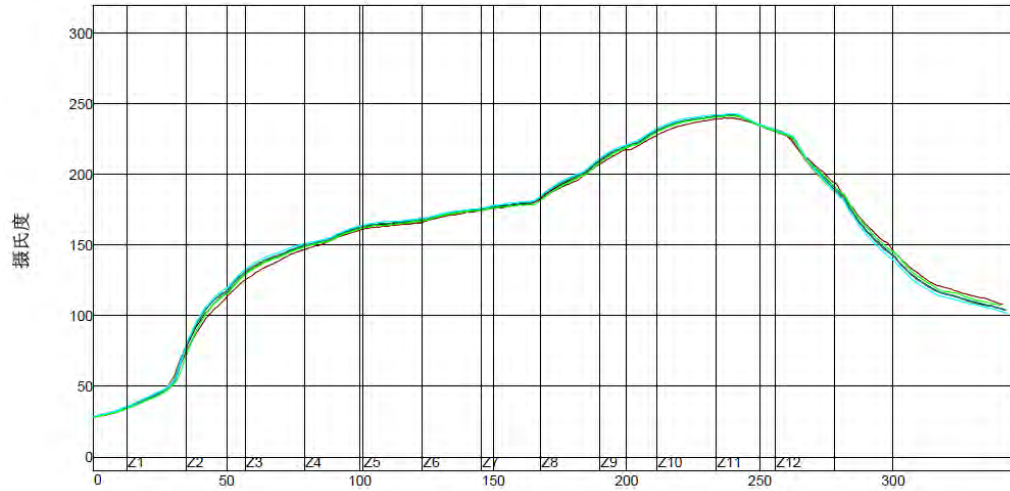

Figure 3 Soldering Specification

CHAPTER 2. ELECTRICAL AND RF SPECIFICATION

2-1 Recommended Operation Rating

	Condition	Min	Typ.	Max.	Unit
VDD	3	3.3	3	3.6	V
RF Interface	Zo		50		Ohm

Table 2 Operation Rating

2-2 Power Consumption

Description	Typical	Unit
IDLE	65	mA
2G/2T- N mode HT 40MHz MCS 7	128	mA
2G/2T- N mode HT 20MHz MCS 7	147	mA
2G/2T- G mode OFDM54M	158	mA
2G/2T- B mode CCK11M	237	mA
5G/2T- N mode HT 40MHz MCS 7	160	mA
5G/2T- N mode HT 20MHz MCS 7	180	mA
5G/2T- A mode OFDM54M	205	mA
2G/2R- N mode HT 40MHz MCS 7	78	mA
2G/2R- N mode HT 20MHz MCS 7	75	mA
2G/2R- G mode OFDM54M	76	mA
2G/2R- B mode CCK11M	75	mA
5G/2R- N mode HT 40MHz MCS 7	83	mA
5G/2R- N mode HT 20MHz MCS 7	79	mA
5G/2R- A mode OFDM54M	79	mA

Table 3 Power Consumption

2-3 WiFi RF Specification – TX

Table 4 IEEE 802.11 b/g/n TX Output Power (WLAN0&WLAN1)

Data Rate (Mbps)	Modulation	Tx Typical Power (dBm)	Data Rate (Mbps)	Modulation	Tx Typical Power (dBm)
1	DBPSK	12.5	HT20-MCS0	BPSK	11
2	DQPSK	12.5	HT20-MCS1	BPSK	11
5.5	CCK	12.5	HT20-MCS2	QPSK	11
11	CCK	12.5	HT20-MCS3	QPSK	11
6	OFDM	11.5	HT20-MCS4	16-QAM	11
9	OFDM	11.5	HT20-MCS5	16-QAM	11
12	OFDM	11.5	HT20-MCS6	64-QAM	11
18	OFDM	11.5	HT20-MCS7	64-QAM	11
24	OFDM	11.5	HT40-MCS0	BPSK	8
36	OFDM	11.5	HT40-MCS1	QPSK	8
48	OFDM	11.5	HT40-MCS2	QPSK	8
54	OFDM	11.5	HT40-MCS3	16-QAM	8
			HT40-MCS4	16-QAM	8
			HT40-MCS5	64-QAM	8
			HT40-MCS6	64-QAM	8
			HT40-MCS7	64-QAM	8

Tolerance: +/-2dBm

※Total Max. Power = WLAN0 Max. Power + WLAN1 Max. Power + 3dBm

Table 5 IEEE 802.11 a/n TX Output Power (WLAN0&WLAN1)

Data Rate (Mbps)	Modulation	Tx Typical Power (dBm)	Data Rate (Mbps)	Modulation	Tx Typical Power (dBm)
6	OFDM	8	HT20-MCS0	BPSK	8
9	OFDM	8	HT20-MCS1	BPSK	8
12	OFDM	8	HT20-MCS2	QPSK	8
18	OFDM	8	HT20-MCS3	QPSK	8
24	OFDM	8	HT20-MCS4	16-QAM	8
36	OFDM	8	HT20-MCS5	16-QAM	8
48	OFDM	8	HT20-MCS6	64-QAM	8
54	OFDM	8	HT20-MCS7	64-QAM	8
			HT40-MCS0	BPSK	10
			HT40-MCS1	QPSK	10
			HT40-MCS2	QPSK	10
			HT40-MCS3	16-QAM	10
			HT40-MCS4	16-QAM	10
			HT40-MCS5	64-QAM	10
			HT40-MCS6	64-QAM	10
			HT40-MCS7	64-QAM	10

Tolerance: +/-2dBm

※Total Max. Power = WLAN0 Max. Power + WLAN1 Max. Power + 3dBm

2-4 WiFi RF Specification – RX

Table 6 IEEE 802.11 b/g/n RX Sensitivity (WLAN0&WLAN1)

Data Rate (Mbps)	Modulation	Rx Sensitivity (dBm)		Data Rate (Mbps)	Modulation	Rx Sensitivity (dBm)	
		Max.	Typ.			Max.	Typ.
1	DBPSK	-83	-92	HT20-MCS0	BPSK	-82	-89
2	DQPSK	-80	-89	HT20-MCS1	QPSK	-79	-86
5.5	CCK	-79	-87	HT20-MCS2	QPSK	-77	-83
11	CCK	-76	-84	HT20-MCS3	16-QAM	-74	-80
6	OFDM	-85	-89	HT20-MCS4	16-QAM	-70	-77
9	OFDM	-84	-87	HT20-MCS5	64-QAM	-66	-72
12	OFDM	-82	-86	HT20-MCS6	64-QAM	-65	-71
18	OFDM	-80	-84	HT20-MCS7	64-QAM	-64	-70
24	OFDM	-77	-80	HT40-MCS0	BPSK	-79	-86
36	OFDM	-73	-77	HT40-MCS1	QPSK	-76	-82
48	OFDM	-69	-73	HT40-MCS2	QPSK	-74	-80
54	OFDM	-68	-71	HT40-MCS3	16-QAM	-71	-77
				HT40-MCS4	16-QAM	-67	-73
				HT40-MCS5	64-QAM	-63	-69
				HT40-MCS6	64-QAM	-62	-68
				HT40-MCS7	64-QAM	-61	-67

Table 7 IEEE 802.11 a/n RX Sensitivity (WLAN0&WLAN1))

Data Rate (Mbps)	Modulation	Rx Sensitivity (dBm)		Data Rate (Mbps)	Modulation	Rx Sensitivity (dBm)	
		Max.	Typ.			Max.	Typ.
6	OFDM	-85	-90	HT20-MCS0	BPSK	-82	-90
9	OFDM	-84	-88	HT20-MCS1	QPSK	-79	-87
12	OFDM	-82	-87	HT20-MCS2	QPSK	-77	-85
18	OFDM	-80	-85	HT20-MCS3	16-QAM	-74	-81
24	OFDM	-77	-82	HT20-MCS4	16-QAM	-70	-78
36	OFDM	-73	-78	HT20-MCS5	64-QAM	-66	-74
48	OFDM	-69	-74	HT20-MCS6	64-QAM	-65	-72
54	OFDM	-68	-73	HT20-MCS7	64-QAM	-64	-71
				HT40-MCS0	BPSK	-79	-87
				HT40-MCS1	QPSK	-76	-84
				HT40-MCS2	QPSK	-74	-82
				HT40-MCS3	16-QAM	-71	-79
				HT40-MCS4	16-QAM	-67	-75
				HT40-MCS5	64-QAM	-63	-71
				HT40-MCS6	64-QAM	-62	-70
				HT40-MCS7	64-QAM	-61	-68

2-5 Bluetooth RF Specification

Parameter	Condition	Min.	Typ.	Max.	Unit
Basic Data Rate - Transmit Performance					
RF Transmit Power (TRM01)		1	5	9	dBm
Power Density (TRM02)	Per 100kHz	≤20			dBm
Power Control (TRM03)		2 ≤ step size ≤ 8			dB
TX Output Spectrum - Freq. Range (TRM04)	F(low)- CH0	> 2400			MHz
	F(high)-CH78	< 2483.5			
TX Output Spectrum - 20dB BW (TRM05)		$ f_H - f_L < 1000$			MHz
TX Output Spectrum - Adjacent Channel Power (TRM06)	$ f - f_0 = 2\text{MHz}$	≤ -20			dBm
	$ f - f_0 ≥ 3\text{MHz}$	≤ -40			
TX Output Spectrum - Out of Band Spurious Emission	30MHz - 1GHz	≤ -36			dBm
	1GHz -12.75GHz	≤ -30			
	5.15GHz -5.35GHz	≤ -47			
	5.725GHz-5.825GHz	≤ -47			
Modulation Characteristic (TRM07)	Delta f1 avg	$140 ≤ \Delta f_{1\text{avg}} ≤ 175$			kHz
	Delta f2 max	≥ 115 at 99.9%			
	Delta f2 avg/Delta f1 avg	≥ 0.8			
Initial Carrier Frequency Tolerance (TRM08)		≤± 75			kHz
Carrier Frequency Drift (TRM09)	DH1	≤± 25			kHz
	DH3	≤± 40			
	DH5	≤± 40			
Maximum Drift Rate (TRM09)		20 kHz/50 us			

Enhanced Data Rate - Transmit Performance					
RF Transmit Power	$\pi/4$ DQPSK	6	7.5	9	dBm
	8DPSK	6	7.5	9	
Relative Transmit Power (TRM10)	All pairs	$(P_{\text{GFSK}}-4 \text{ dB}) < P_{\text{DPSK}} < (P_{\text{GFSK}}+1 \text{ dB})$			
Carrier Frequency Stability (TRM11)	All packets	$-75 \leq w_i \leq 75$			kHz
	All blocks	$-75 \leq (w_0+w_i) \leq 75$			
	All blocks	$-10 \leq w_0 \leq 10$			
Modulation Accuracy - RMS DEVM (TRM11)	$\pi/4$ DQPSK	≤ 20			%
	8DPSK	≤ 13			
Modulation Accuracy - Peak DEVM (TRM11)	$\pi/4$ DQPSK	≤ 35			
	8DPSK	≤ 25			
Modulation Accuracy - 99% DEVM (TRM11)	$\pi/4$ DQPSK	≤ 30			
	8DPSK	≤ 20			
EDR Differential Phase Emissions (TRM12)		≥ 99			%
In-band Spurious Emission (TRM13)	$ f-f_0 = 1\text{MHz}$	≤ -26			dB
	$ f-f_0 = 2\text{MHz}$	≤ -20			
	$ f-f_0 \geq 3\text{MHz}$	≤ -40			dBm
TX Output Spectrum - Out of Band Spurious Emission	30MHz - 1GHz	≤ -36			
	1GHz -12.75GHz	≤ -30			
	5.15GHz -5.35GHz	≤ -47			
	5.725GHz-5.825GHz	≤ -47			
Enhanced power control (TRM14)	Step Size	$2 \leq \text{Step Size} \leq 8$			dB
	Difference. Btw. GFSK, $\pi/4$ DQPSK,&8DPSK	≤ 10			

Basic Data Rate – Receiver Performance				
Sensitivity at 0.1% BER (RCV01-02)		≤ -81	dBm	
C/I Co-Channel interference (RCV03)		≤ 11	dB	
C/I Adjacent CH interference (RCV03)	$ f-f_0 = 1\text{MHz}$	≤ 0		
	$ f-f_0 = 2\text{MHz}$	≤ -30		
	$ f-f_0 \geq 3\text{MHz}$	≤ -40		
C/I Image CH interference (RCV03)	C/I_{image}	≤ -9		
	$C/I_{\text{image}\pm 1\text{MHz}}$	≤ -20		
Out of band Blocking (RCV04)	30MHz – 2000 MHz	-10	dBm	
	2003MHz – 2399MHz	-27		
	2484MHz – 2997MHz	-27		
	3000MHz – 12750MHz	-10		
Intermodulation Performance at $\leq 0.1\%$ BER (RCV05)		-64	dBm	
Maximum input power level		≥ -20	dBm	
Spurious Emission		30MHz – 12.75GHz	≤ -57	dBm
Enhanced Data Rate – Receiver Performance				
Sensitivity at 0.1% BER (RCV07)	$\pi/4$ DQPSK	≤ -85	dBm	
	8DPSK	≤ -77		
EDR BER Floor Performance at $\leq 0.0007\%$ BER (RCV08)		-60	dBm	
C/I Co-Channel interference (RCV09)	$\pi/4$ DQPSK	$\leq +13$	dB	
	8DPSK	$\leq +21$		
C/I Adjacent Channel C/I $ f-f_0 = 1\text{MHz}$ (RCV09)	$\pi/4$ DQPSK	≤ 0		
	8DPSK	$\leq +5$		
C/I Adjacent Channel C/I $ f-f_0 = 2\text{MHz}$ (RCV09)	$\pi/4$ DQPSK	≤ -30		
	8DPSK	≤ -25		
C/I Adjacent Channel C/I $ f-f_0 \geq 3\text{MHz}$ (RCV09)	$\pi/4$ DQPSK	≤ -40		
	8DPSK	≤ -33		
C/I Image Channel C/I_{image} (RCV09)	$\pi/4$ DQPSK	≤ -7		
	8DPSK	≤ 0		
C/I Image Channel $C/I_{\text{image}\pm 1\text{MHz}}$ (RCV09)	$\pi/4$ DQPSK	≤ -20		
	8DPSK	≤ -13		
Maximum input power level (RCV10)		≥ -20		dBm
Spurious Emission		30MHz – 12.75GHz	≤ -57	Pass

2-6 Bluetooth Low Energy RF Specification

Parameter	Condition	Min.	Typ.	Max.	Unit	
Transmit Performance						
RF Transmit Power (TRM-LE01,02)		1	5	9	dBm	
In-Band Emission (TRM-LE03,04)	$ f-f_0 =2\text{MHz}$	≤ -20			dBm	
	$ f-f_0 \geq 3\text{MHz}$	≤ -30				
TX Output Spectrum – Out of Band Spurious Emission	30MHz – 1GHz	≤ -36			dBm	
	1GHz -12.75GHz	≤ -30				
	5.15GHz -5.35GHz	≤ -47				
	5.725GHz-5.825GHz	≤ -47				
Modulation Characteristic (TRM-LE05)	Delta f1 avg	$225 \leq \Delta f_{1\text{avg}} \leq 275$			kHz	
	Delta f2 max	≥ 185 at 99.9%				
	Delta f2 avg/Delta f1 avg	≥ 0.8				
Carrier Frequency Drift (TRM-LE06,07)	Center frequency	$\leq \pm 150$			kHz	
	During any packet	$\leq \pm 50$				
Maximum Drift Rate (TRM-LE06,07)		20 Hz/50 us				
Receiver Performance						
Sensitivity at 30.8% PER(0.1%BER) (RCV-LE01,02)		≤ -81			dBm	
C/I Co-Channel interference (RCV-LE03)	Co-channel	≤ 21			dB	
	C/I Adjacent CH interference (RCV-LE03)	$ f-f_0 =1\text{MHz}$	≤ 15			
		$ f-f_0 =2\text{MHz}$	≤ -17			
		$ f-f_0 \geq 3\text{MHz}$	≤ -27			
C/I Image CH interference (RCV-LE03)	C/I_{image}	≤ -9			dB	
	$C/I_{\text{image}\pm 1\text{MHz}}$	≤ -15				
Out of band Blocking (RCV-LE04)	30MHz – 2000 MHz	-30			dBm	
	2003MHz – 2399MHz	-35				
	2484MHz – 2997MHz	-35				
	3000MHz – 12750MHz	-30				
Intermodulation Performance at $\leq 30.8\%$ ($\leq 0.1\%$ BER) (RCV-LE05)		-64			dBm	
Maximum input power level (RCV-LE06)		≥ -10			dBm	
PER Report Integrity $50\% \leq \text{PER} \leq 65.4\%$ (RCV-LE07)		-30			dBm	
Spurious Emission	30MHz – 12.75GHz	≤ -57			dBm	

2-7 Environment Specifications

Operating Conditions (preliminary)

Operation Temperature : 0 ~ 60°C

Storage Conditions (preliminary)

Non-Operation Temperature : -10 ~ 60°C (Typ. 25°C)

CHAPTER 3. MECHANICAL SPECIFICATION

3-1 Module Assembly Dimension

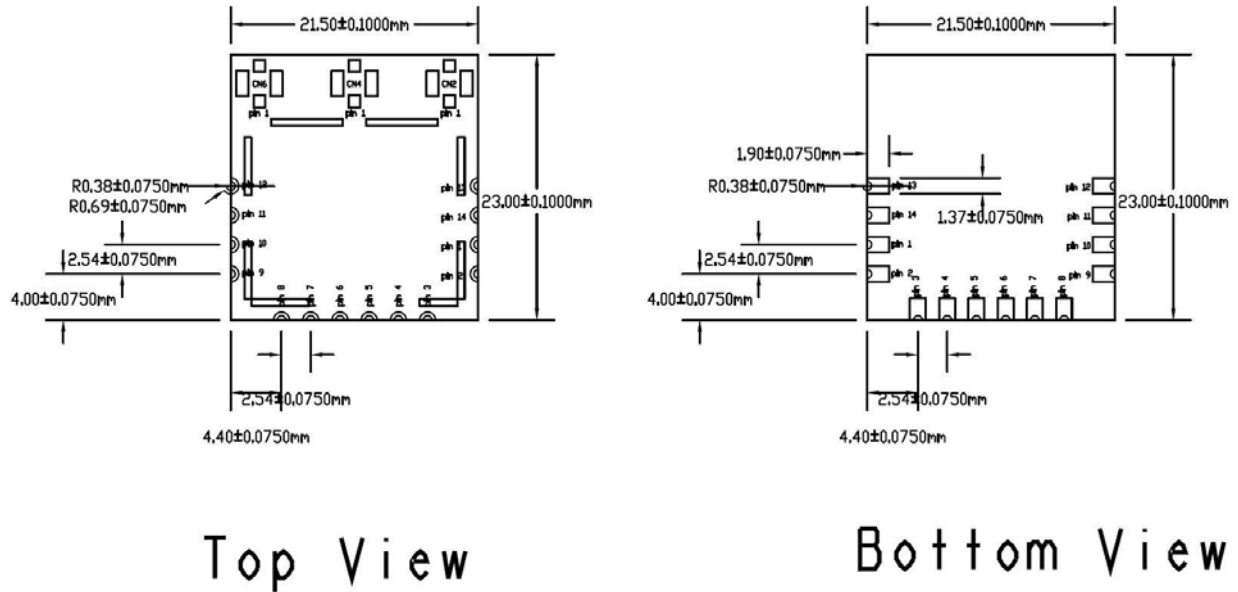

Figure 4 Mechanical Drawing

3-2 Label Specification

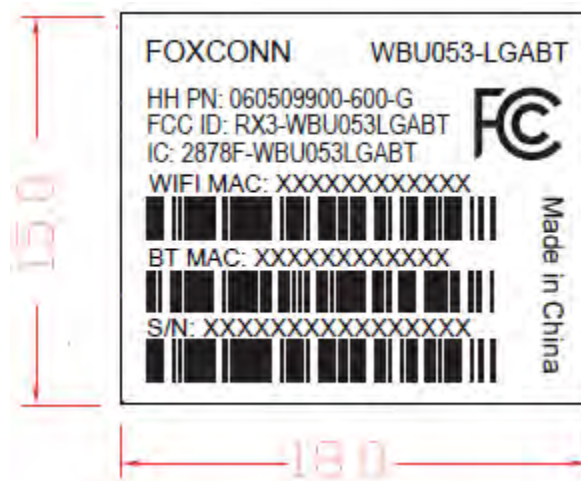

Figure 5 Label Drawing

3-3 Module Photo



Figure 6 Module Photo (top)

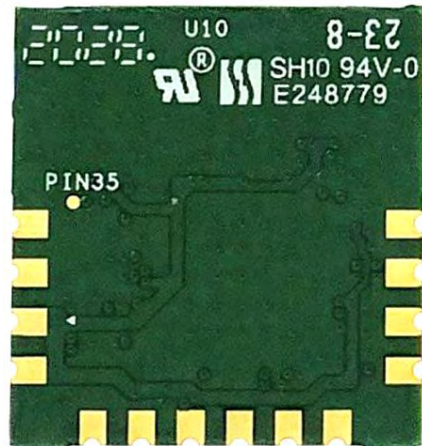

Figure 7 Module Photo (bottom)

CHAPTER 4. PACKAGE INFORMATION

無鉛制程

FOXCONN TECHNOLOGY GROUP 包裝作業規範 PACKING SPECIFICATION

投入原物料成分須
完全符合CPSGE08-008
標準之環保要求

規範編號	SPEC. NO.	EWH-PMO-019		● CONFIDENTIAL ○ TOP SECRET																																													
包裝作業圖示說明		PACKING OPERATON DIAGRAM & INSTRUCTION		PAGE	2/10																																												
				REV.	A																																												
				備註	REMARK																																												
		<table border="1"> <thead> <tr> <th colspan="4">Wifi WBU053-LGA 包裝作業規範</th> </tr> <tr> <th>NO.</th> <th>名稱</th> <th>料號</th> <th>用量</th> </tr> </thead> <tbody> <tr> <td>A</td> <td>PCA FOXCONN箱</td> <td>085-0274-1813</td> <td>1PCS</td> </tr> <tr> <td>B</td> <td>防靜電泡棉墊板</td> <td>1513004-0100390</td> <td>1PCS</td> </tr> <tr> <td>C</td> <td>防護袋</td> <td>086-0102-3005</td> <td>1PCS</td> </tr> <tr> <td>D</td> <td>WBU053-LGA料帶</td> <td>類別料號</td> <td>5卷</td> </tr> <tr> <td>D</td> <td>WBU053-LGA料膜</td> <td>類別料號 (37.5mm*200M)</td> <td></td> </tr> <tr> <td>E</td> <td>PCBA WBU053-LGA DB</td> <td>1A-WBU053L-HDP0</td> <td>3000PCS</td> </tr> <tr> <td>F</td> <td>乾燥劑</td> <td>S-WL96-051-3Y(125*85mm)</td> <td>10</td> </tr> <tr> <td>G</td> <td>防潮卡片</td> <td>083-0000-2540</td> <td>5</td> </tr> <tr> <td>H</td> <td>靜電袋封裝OK整包組件</td> <td></td> <td></td> </tr> </tbody> </table>		Wifi WBU053-LGA 包裝作業規範				NO.	名稱	料號	用量	A	PCA FOXCONN箱	085-0274-1813	1PCS	B	防靜電泡棉墊板	1513004-0100390	1PCS	C	防護袋	086-0102-3005	1PCS	D	WBU053-LGA料帶	類別料號	5卷	D	WBU053-LGA料膜	類別料號 (37.5mm*200M)		E	PCBA WBU053-LGA DB	1A-WBU053L-HDP0	3000PCS	F	乾燥劑	S-WL96-051-3Y(125*85mm)	10	G	防潮卡片	083-0000-2540	5	H	靜電袋封裝OK整包組件			<p>※作業說明:</p> <ol style="list-style-type: none"> 1.把DB板依順序裝入專用靜電料帶中,使用專用料膜封裝。在料帶盤上貼上相應流程條碼。 2.把裝有主板的料帶/乾燥劑/防潮卡片放入防靜電袋內,然後進行真空封裝,在靜電袋外貼上相應流程條碼(與料盤上條碼相同)。 3.將1PCS防護袋放入PCA FOXCONN箱中,並放入1PCS防靜電泡棉墊板。 4.將封裝OK的整盤料件,平放疊在箱內。 5.裝滿一箱后,蓋上1PCS防靜電泡棉墊板(不滿一箱時,需要用靜電泡棉墊板填滿一箱)。 6.外箱用膠帶封合後,貼上出貨標籤和包裝條碼。 <p>※注意:</p> <ol style="list-style-type: none"> 1.作業者拿取產品時要輕拿輕放,注意防止損壞。 2.作業者操作前須佩戴乾淨完整的防靜電手套和有效接地的有線防靜電手環。 3.防止運輸過程激烈震動。 4.檢驗包裝箱是否有裝滿,若已裝滿則轉入下一箱的作業,如果有未裝滿一箱的就需要修改包裝條碼上的數量(與實際相符),並用防靜電泡棉墊板塞滿空餘的空間,以保證產品在箱子里完全固定。 	
Wifi WBU053-LGA 包裝作業規範																																																	
NO.	名稱	料號	用量																																														
A	PCA FOXCONN箱	085-0274-1813	1PCS																																														
B	防靜電泡棉墊板	1513004-0100390	1PCS																																														
C	防護袋	086-0102-3005	1PCS																																														
D	WBU053-LGA料帶	類別料號	5卷																																														
D	WBU053-LGA料膜	類別料號 (37.5mm*200M)																																															
E	PCBA WBU053-LGA DB	1A-WBU053L-HDP0	3000PCS																																														
F	乾燥劑	S-WL96-051-3Y(125*85mm)	10																																														
G	防潮卡片	083-0000-2540	5																																														
H	靜電袋封裝OK整包組件																																																
事業單位	MIDI 產品事業處	核定	王松飛	審核	劉高																																												
DIVISION		APP.		CHK.																																													
		製表	李叢叢	PRE.																																													

F SSSQ07-006-07A

**** 本文件之著作權及營業秘密屬於富士康科技集團CCPBG,非經公司允許不得翻印 ****

無鉛制程

FOXCONN TECHNOLOGY GROUP 包裝作業規範 PACKING SPECIFICATION

投入原物料成分須
完全符合CPSGE08-008
標準之環保要求

規範編號	SPEC. NO.	EWH-PMO-019		● CONFIDENTIAL ○ TOP SECRET	
包裝作業圖示說明		PACKING OPERATON DIAGRAM & INSTRUCTION		PAGE	3/10
				REV.	A
				備註	REMARK
<p>Wifi WBU053-LGA 包裝作業規範</p> <p>1.包裝人員,先掃描流程卡(要與靜電袋上貼附的流程卡要保持一致)。</p>		<p>2.取一卷專用料帶(WBU053-LGA)。將產品按相同方向放入料帶凹槽中(P SIDE面朝上)。</p>		<p>3.放入料膜封裝機上進行封裝(具體步驟參照《WBU053-LGA MP WIFI MODULE DB ROA 產品作業指導書》)。</p>	
<p>4.掃描WBU053-LGA P SIDE面條碼。對此工站每盤進行員數管理,掃描1盤后核對掃描儀上的數據是否為600/600,如果不是將會是漏裝或多裝,請及時核對數量。</p>		<p>裝滿PBA的料帶引出方向</p> <p>5.裝滿PBA的料帶引出方向:兩個連接器朝向料帶引出方向的左邊(如圖所示)。</p>		<p>6.注意:封裝前必須檢查兩個連接器留出的方向是否與流程卡的方向一致。料帶兩個通孔注意目檢,不允許有破損、褶皺、氣泡等不良現象(如圖所示)。</p>	
事業單位	MIDI 產品事業處	核定	王松飛	審核	劉高
DIVISION		APP.		CHK.	
		製表	李叢叢	PRE.	

FSSQ07-006-07A

**** 本文件之著作權及營業秘密屬於富士康科技集團CCPBG,非經公司允許不得翻印 ****

FOXCONN TECHNOLOGY GROUP

包裝作業規範 PACKING SPECIFICATION

無鉛制程

投入原物料成分須
完全符合CPSGE08-008
標準之環保要求

規範編號	SPEC. NO.	EWB-PMO-019	CONFIDENTIAL	TOP SECRET
包裝作業圖示說明			PAGE	4/10
PACKING OPERATON DIAGRAM & INSTRUCTION			REV.	A
備註			REMARK	
Wifi WBU053-LGA 包裝作業規範				
備註: 圖片/數據僅供參考以實際為準				
<p>裝滿PBA的料帶引出方向</p>  <p>7. 在料盤上貼上流程卡 (流程卡貼在料帶引出的左側面)。在料帶最後一圈纏上保護帶 (每卷料帶來料外層會有二圈片材的保護帶)</p>  <p>8. 將裝滿600PCS的料盤流程籤朝上放入料盤專用靜電袋內, 在袋中同時放入1PCS 防潮卡片和兩包0.033kg的乾燥劑。將裝好的靜電袋進行真空封裝, 按兩邊的缺角位置對稱, 以此線作為密封線 (距離為50mm)。并在靜電袋上貼上與料盤上相同的流程卡。</p>      <p>9. 調整封裝機參數: 參照下排圖片。(注意真空封裝時: 不能將料盤擠壓變形, 料盤不能在裏面晃動為宜, 真空封裝時間為: 15 秒)</p> 				
<p>9.1 壓力表: 最高壓時黑色針指向 "0.075"</p> <p>9.2 抽氣時間: 紅針指向 "第3-4格之間"</p> <p>9.3 加熱時間: 紅針指向 "1.5~1.6"</p> <p>9.4 加熱溫度: 黑色箭頭指向 "中"</p> <p>9.5 電源開關: 綠色箭頭指向 "開"</p>				
事業單位	MDI 產品事業處	核定	審核	製表
DIVISION		APP.	CHK.	PRE.
		王松臣	孫高	李叢叢

**** 本文件之著作權及營業秘密屬於富士康科技集團CCPBG, 非經公司允許不得翻印 ****



FSSQ07-006-07A

FOXCONN TECHNOLOGY GROUP

包裝作業規範 PACKING SPECIFICATION

無鉛制程

投入原物料成分須
完全符合CPSGE08-008
標準之環保要求

規範編號	SPEC. NO.	EWB-PMO-019	CONFIDENTIAL	TOP SECRET
包裝作業圖示說明			PAGE	7/10
PACKING OPERATON DIAGRAM & INSTRUCTION			REV.	A
備註			REMARK	
Wifi WBU053-LGA 包裝作業規範				
<p>※作業說明:</p> <ol style="list-style-type: none"> 1. 揀出外箱流程卡 (如圖一所示) 將流程卡貼到外箱對應位置 (如圖七) 2. 將1PCS防靜袋放入 PCA FOXCONN箱中, 並放入1PCS防靜電池棉墊板 (如圖二所示)。 3. 將裝好整盤物料的靜電袋進行真空封裝, 貼上黃色流程條碼卡 (圖三圖九所示) 4. 將封裝OK的靜電袋周邊按料帶形狀向一個面折疊 (圖四所示) 揀出靜電袋上流程卡后放入箱內, 疊放5盤, 貼有標籤面朝上 (如圖四所示) 5. 裝滿一箱后, 選上1PCS防靜電池棉墊板 (不滿意時, 需要用靜電棉條板填滿一箱), 檢查OK后将防靜袋袋口折疊整理, 進行封箱 (如圖五圖六所示) 6. 品保需對每箱包裝確認流程卡貼附是否一致, 並確認出貨檢驗數量, 逐盤進行數目清點, 若發現漏裝或者多裝時, 及時通知品保處理 7. 外箱用封箱膠帶封合後, ("工" 字形封合) 貼上出貨標籤和包裝條碼 (如圖七) 8. 所使用的封箱膠帶料號為CACF34850 (如圖八)。 9. 在外箱頂部膠帶中間位置貼一個防撕標籤 (60*20mm)。 (如圖十) <p>※注意事項:</p> <ol style="list-style-type: none"> 1. 作業者操作前須佩戴好手套或防靜電手套和有效接地的有線防靜電手環。 2. 作業者拿取主板時注意輕拿輕放。 3. 防止運輸過程激烈震動。 4. 檢驗包裝箱是否有裝滿, 若已裝滿則轉入下一箱的作業, 如果有未裝滿一箱子的數需修改包裝條碼上的數量 (與實際相符), 並用防靜電池棉蓋蓋空餘的空間, 以保證产品在箱子呈完全固定。 5. 要求所有包材必須新制。 6. 特殊注意確認數量, 料盤防靜電袋以及外箱上貼的流程卡內容要與持一致。 <p>※備註:</p> <p>圖九 廠內料號</p> <ol style="list-style-type: none"> 1. 料號及數量 (對應DB的數量, 不是整箱所有DB的數量) 2. Lot code 號: "0"年,"4"月,"01"日, "00010"流水碼, "R9"生產線別。 3. Module P/N: 客戶料號 數量。 				
<p>每箱裝數: WBU053-LGA DB</p> <p>料盤及靜電袋貼附標籤樣板</p>  <p>廠內條碼</p>  <p>防撕標籤</p>  <p>外箱頂部防角標籤貼電</p> 				
事業單位	MDI 產品事業處	核定	審核	製表
DIVISION		APP.	CHK.	PRE.
		王松臣	孫高	李叢叢

**** 本文件之著作權及營業秘密屬於富士康科技集團CCPBG, 非經公司允許不得翻印 ****

FSSQ07-006-07A

無鉛制程

FOXCONN TECHNOLOGY GROUP 包裝作業規範 PACKING SPECIFICATION

投入原物料成分須
完全符合CPSGE08-008
標準之環保要求

規範編號	SPEC. NO.	EWB-PMO-019
包裝作業圖示說明 PACKING OPERATON DIAGRAM & INSTRUCTION		
Wifi WBU053-LGA 包裝作業規範		出貨條碼 (舉例說明)
		<p>圖一</p> <p>1. 出貨工令 2. 產品料號 3. 生產日期 4. 出貨數量</p> <p>圖二</p> <p>在此處寫上實際日期 (依此條碼舉例說)</p>
<p>圖三</p> <p>此條碼上內容須全部打印, 不允許手寫 (顏色: 黃色, 材質: 格拉新, 尺寸: 60mm*80mm)</p> <p>1. 客戶料號 2. 產品描述 3. 每箱總數量 4. P/O # (企劃提供) 5. 產品淨重 (對應料號的淨重) 及毛重 (整箱重量) 6. 工廠ROA出貨料號 (由生管通知條碼中心列印料號)</p> <p>圖四: 出貨地條碼</p> <p>1. 產品料號 2. 出貨地</p> <p>圖五: 檢驗條碼說明</p> <p>第一項檢驗者姓名 第二項產品料號 第三項箱號 (一般寫工單號)</p> <p>※注意: 1. 標籤尺寸: 50mm*45mm(長*寬) 2. 材質為銅板紙。 3. 標籤貼對外箱貼標籤處的中心位置。</p>		
事業單位	MDI 產品事業處	核定
DIVISION		APP. 王松臣
		審核
		CHK. 劉高
		製表
		PRE. 李叢叢

**** 本文件之著作權及營業秘密屬於富士康科技集團CCPBG, 非經公司允許不得翻印 ****

FSSQ07-006-07A

無鉛制程

FOXCONN TECHNOLOGY GROUP 包裝作業規範 PACKING SPECIFICATION

投入原物料成分須
完全符合CPSGE08-008
標準之環保要求

規範編號	SPEC. NO.	EWB-PMO-019
包裝作業圖示說明 PACKING OPERATON DIAGRAM & INSTRUCTION		
Wifi WBU053-LGA 包裝作業規範		出貨標簽
		<p>※包裝外箱堆放作業說明:</p> <p>1. 在地上放一檢驗OK的棧板, 棧板上平鋪一棧板防護袋, 然後將包裝好的外箱依圖一所示整齊放置棧板上, 每層放4箱, 棧板防護袋由下向上套裝棧板上每層紙箱。</p> <p>2. 出貨包裝時, 堆疊好之後, 箱子上面再平鋪一棧板防護袋, 由上向下套裝棧板上每層紙箱, 箱子四周加角紙固定, 再用打包膜包裹2層後, 用包裝帶包裝, 並在包裝後用打包膜包裹1層, 確保儲運安全。(PE膜最少3層)</p> <p>3. 角紙A*與角紙B*固定邊上, 用包裝帶包裝6圈, 打包膜包裹2層, 確保儲運安全。</p> <p>4. 貨物堆放為3層(如圖二所示)。</p> <p>5. 推進貨櫃時, 不准用叉車, 須人工用油壓車推入。</p> <p>6. 每4箱以上使用棧板打包。(含4箱)</p> <p>注意:</p> <p>1. 外箱放置方式如圖一所示。</p> <p>2. 外箱標籤要朝外。</p> <p>3. 棧板必須先檢驗合格才能使用。</p> <p>4. 角紙尺寸: 角紙A: 1000*50*5mm, 角紙B: 650*50*5mm</p> <p>5. 打包前應確認貨物擺放整齊, 薄膜張力設置在可以允</p> <p>※棧板堆放作業說明:</p> <p>1. 用手推車將包裝好之棧板及貨物放入貨櫃, 並蓋上帆布。</p> <p>注: 聯合棧板尺寸: 800*800*140mm</p> <p>注意:</p> <p>1. 棧板放置時前後必須相互靠住。</p> <p>2. 棧板之長邊與關閉時的貨櫃門平行。</p> <p>3. 用油壓車推入棧板時, 叉子不能露出棧板另一頭, 以防推車叉子撞傷產品。</p>
事業單位	MDI 產品事業處	核定
DIVISION		APP. 王松臣
		審核
		CHK. 劉高
		製表
		PRE. 李叢叢

**** 本文件之著作權及營業秘密屬於富士康科技集團CCPBG, 非經公司允許不得翻印 ****

FSSQ07-006-07A

Federal Communication Commission Interference Statement

This device complies with Part 15 of the FCC Rules. Operation is subject to the following two conditions: (1) This device may not cause harmful interference, and (2) this device must accept any interference received, including interference that may cause undesired operation.

This equipment has been tested and found to comply with the limits for a Class B digital device, pursuant to Part 15 of the FCC Rules. These limits are designed to provide reasonable protection against harmful interference in a residential installation. This equipment generates, uses and can radiate radio frequency energy and, if not installed and used in accordance with the instructions, may cause harmful interference to radio communications. However, there is no guarantee that interference will not occur in a particular installation. If this equipment does cause harmful interference to radio or television reception, which can be determined by turning the equipment off and on, the user is encouraged to try to correct the interference by one of the following measures:

- Reorient or relocate the receiving antenna.
- Increase the separation between the equipment and receiver.
- Connect the equipment into an outlet on a circuit different from that to which the receiver is connected.
- Consult the dealer or an experienced radio/TV technician for help.

FCC Caution: Any changes or modifications not expressly approved by the party responsible for compliance could void the user's authority to operate this equipment. This transmitter must not be co-located or operating in conjunction with any other antenna or transmitter.

Operations in the 5.15-5.25GHz band are restricted to indoor usage only.

This device meets all the other requirements specified in Part 15E, Section 15.407 of the FCC Rules.

Radiation Exposure Statement:

This equipment complies with FCC radiation exposure limits set forth for an uncontrolled environment. This equipment should be installed and operated with minimum distance 20cm between the radiator & your body.

This device is intended only for OEM integrators under the following conditions:

- 1) The antenna must be installed such that 20 cm is maintained between the antenna and users, and
 - 2) The transmitter module may not be co-located with any other transmitter or antenna.
- As long as 2 conditions above are met, further transmitter test will not be required. However, the OEM integrator is still responsible for testing their end-product for any additional compliance requirements required with this module installed

IMPORTANT NOTE: In the event that these conditions can not be met (for example certain laptop configurations or co-location with another transmitter), then the FCC authorization is no longer considered valid and the FCC ID can not be used on the final product. In these circumstances, the OEM integrator will be responsible for reevaluating the end product (including the transmitter) and obtaining a separate FCC authorization.

The module is tested for standalone mobile RF exposure use condition. Any other usage conditions such as co-location with other transmitter(s) or being used in a portable condition will need a separate reassessment through a class II permissive change application or new certification.

End Product Labeling

This transmitter module is authorized only for use in device where the antenna may be installed such that 20 cm may be maintained between the antenna and users. The final end product must be labeled in a visible area with the following: “Contains FCC ID: RX3-WBU053LGABT”. The grantee's FCC ID can be used only when all FCC compliance requirements are met.

Antennas

The following antennas have been certified for use with this module; antennas of the same type with equal or lower gain may also be used with this module. The antenna must be installed such that 20 cm can be maintained between the antenna and users.

WLAN Type : PIFA, External

BT Type : PIFA, External

Functionality	Manufacturer	Model #	Cable Length	Frequencies				
				2400~2483.5MHz	5180~5240MHz	5260~5320MHz	5500~5720MHz	5745~5825MHz
WLAN 0	Foxconn	790128B00-600-G	600mm	-0.58	-1.3	-1.3	0.07	-0.78
		790128C00-600-G	295mm	3.16	1.11	1.11	2.56	1.56
		79012CE00-600-G	450mm	0.74	0.03	0.03	1.73	-1.09
WLAN 1	Foxconn	79012AL00-600-G	700mm	1.97	2.56	2.56	-0.37	-0.11
		790128C00-600-G	295mm	3.16	1.11	1.11	2.56	1.56
		79012CE00-600-G	450mm	0.74	0.03	0.03	1.73	-1.09
BT	Foxconn	79012CH00-600-G	200mm	2.42				

Part 15 Subpart B disclaimer

This transmitter module is tested as a subsystem and its certification does not cover the FCC Part 15 Subpart B rule requirement applicable to the final host. The final host will still need to be reassessed for compliance to this portion of rule requirements if applicable.

As long as all conditions above are met, further transmitter test will not be required. However, the OEM integrator is still responsible for testing their end-product for any additional compliance requirements required with this module installed.

Manual Information To the End User

The OEM integrator has to be aware not to provide information to the end user regarding how to install or remove this RF module in the user’s manual of the end product which integrates this module. The end user manual shall include all required regulatory information/warning as show in this manual.

OEM/Host manufacturer responsibilities

OEM/Host manufacturers are ultimately responsible for the compliance of the Host and Module. The final product must be reassessed against all the essential requirements of the FCC rule such as FCC Part 15 Subpart B before it can be placed on the US market. This includes reassessing the transmitter module for compliance with the Radio and EMF essential requirements of the FCC rules. This module must not be incorporated into any other device or system without retesting for compliance as multi-radio and combined equipment

Canada, Industry Canada (IC) Statement

This Class B digital apparatus complies with Canadian ICES-003.

This device complies with Industry Canada licence-exempt RSS standard(s). Operation is subject to the following two conditions:

- (1) this device may not cause interference, and
- (2) this device must accept any interference, including interference that may cause undesired operation of the device.

RF Radiation Exposure Statement:

This equipment complies with IC radiation exposure limits set forth for an uncontrolled environment. This equipment should be installed and operated with a minimum distance of 20 centimeters between the radiator and your body.

Operation in the band 5150-5250 MHz is only for indoor use to reduce the potential for harmful interference to co-channel mobile satellite systems.

This device is intended only for OEM integrators under the following conditions:

The transmitter module may not be co-located with any other transmitter or antenna. As long as above conditions is met, further transmitter test will not be required. However, the OEM integrator is still responsible for testing their end-product for any additional compliance requirements required with this module installed.

IMPORTANT NOTE:

In the event that these conditions can not be met (for example certain laptop configurations or co-location with another transmitter), then the Canada authorization is no longer considered valid and the IC ID can not be used on the final product. In these circumstances, the OEM integrator will be responsible for re-evaluating the end product (including the transmitter) and obtaining a separate Canada authorization.

Required end product labeling:

This transmitter module is authorized only for use in device where the antenna may be installed and operated with greater than 20cm between the antenna and users. The final end product must be labeled in a visible area with the following: "Contains IC: 2878F-WBU053LGABT".

Manual Information To the End User

The OEM integrator has to be aware not to provide information to the end user regarding how to install or remove this RF module in the user's manual of the end product which integrates this module.

The end user manual shall include all required regulatory information/warning as show in this manual.

Antennas

The following antennas have been certified for use with this module; antennas of the same type with equal or lower gain may also be used with this module. The antenna must be installed such that 20 cm can be maintained between the antenna and users.

This radio transmitter [2878F-WBU053LGABT] has been approved by Innovation, Science and Economic Development Canada to operate with the antenna types listed below, with the maximum permissible gain indicated. Antenna types not included in this list that have a gain greater than the maximum gain indicated for any type listed are strictly prohibited for use with this device.

WLAN Type : PIFA, External

BT Type : PIFA, External

Functionality	Manufacturer	Model #	Cable Length	Frequencies				
				2400~2483.5MHz	5180~5240MHz	5260~5320MHz	5500~5720MHz	5745~5825MHz
WLAN 0	Foxconn	790128B00-600-G	600mm	-0.58	-1.3	-1.3	0.07	-0.78
		790128C00-600-G	295mm	3.16	1.11	1.11	2.56	1.56
		79012CE00-600-G	450mm	0.74	0.03	0.03	1.73	-1.09
WLAN 1	Foxconn	79012AL00-600-G	700mm	1.97	2.56	2.56	-0.37	-0.11
		790128C00-600-G	295mm	3.16	1.11	1.11	2.56	1.56
		79012CE00-600-G	450mm	0.74	0.03	0.03	1.73	-1.09
BT	Foxconn	79012CH00-600-G	200mm	2.42				

Canada, Industrie Canada (IC) Déclaration

Cet appareil numérique de classe B est conforme à la norme canadienne ICES-003.

Le présent appareil est conforme aux CNR d'Industrie Canada applicables aux appareils radio exempts de licence. L'exploitation est autorisée aux deux conditions suivantes:

- (1) l'appareil ne doit pas produire de brouillage, et
- (2) l'utilisateur de l'appareil doit accepter tout brouillage radioélectrique subi, même si le brouillage est susceptible d'en compromettre le fonctionnement.

Déclaration d'exposition aux radiations:

Cet appareil est conforme aux limites d'exposition aux rayonnements définies pour un environnement non contrôlé. Cet équipement doit être installé et utilisé à une distance minimale de 20 centimètres entre le radiateur et votre corps.

Le fonctionnement dans la bande 5150-5250 MHz est uniquement destiné à une utilisation en intérieur afin de réduire le potentiel d'interférences nuisibles aux systèmes mobiles par satellite dans le même canal..

Cet appareil est conçu uniquement pour les intégrateurs OEM dans les conditions suivantes:

Le module émetteur peut ne pas être coïmplanté avec un autre émetteur ou antenne. Tant que les 1 conditions ci-dessus sont remplies, des essais supplémentaires sur l'émetteur ne seront pas nécessaires. Toutefois, l'intégrateur OEM est toujours responsable des essais sur son produit final pour toutes exigences de conformité supplémentaires requis pour ce module installé.

NOTE IMPORTANTE:

Dans le cas où ces conditions ne peuvent être satisfaites (par exemple pour certaines configurations d'ordinateur portable ou de certaines co-localisation avec un autre émetteur), l'autorisation du Canada n'est plus considéré comme valide et l'ID IC ne peut pas être utilisé sur le produit final. Dans ces circonstances, l'intégrateur OEM sera chargé de réévaluer le produit final (y compris l'émetteur) et l'obtention d'une autorisation distincte au Canada.

Plaque signalétique du produit final

Ce module émetteur est autorisé uniquement pour une utilisation dans un appareil où l'antenne peut être installée et utilisée à plus de 20 cm entre l'antenne et les utilisateurs. Le produit final doit être étiqueté dans un endroit visible avec l'inscription suivante: "Contient des IC: 2878F-WBU053LGABT".

Manuel d'information à l'utilisateur final

L'intégrateur OEM doit être conscient de ne pas fournir des informations à l'utilisateur final quant à la façon d'installer ou de supprimer ce module RF dans le manuel de l'utilisateur du produit final qui intègre ce module.

Le manuel de l'utilisateur final doit inclure toutes les informations réglementaires requises et avertissements comme indiqué dans ce manuel.

ANTENNE

Les antennes suivantes ont été certifiées pour une utilisation avec ce module; des antennes du même type à gain égal ou inférieur peuvent également être utilisées avec ce module. L'antenne doit être installée de telle sorte que 20 cm puissent être maintenus entre l'antenne et les utilisateurs. Cet émetteur radio [2878F-WBU053LGABT] a été approuvé par Innovation, Sciences et Développement économique Canada pour fonctionner avec les types d'antenne énumérés ci-dessous, avec le gain maximal autorisé indiqué. Les types d'antenne non inclus dans cette liste qui ont un gain supérieur au gain maximum indiqué pour tout type répertorié sont strictement interdits pour l'utilisation avec cet appareil.

Type de WLAN: PIFA, externe

Type de BT: PIFA, externe

Fonctionnalité	Le fabricant	Numéro de modèle	Longueur de câble	Les fréquences				
				2400~2483.5MHz	5180~5240MHz	5260~5320MHz	5500~5720MHz	5745~5825MHz
WLAN 0	Foxconn	790128B00-600-G	600mm	-0.58	-1.3	-1.3	0.07	-0.78
		790128C00-600-G	295mm	3.16	1.11	1.11	2.56	1.56
		79012CE00-600-G	450mm	0.74	0.03	0.03	1.73	-1.09
WLAN 1	Foxconn	79012AL00-600-G	700mm	1.97	2.56	2.56	-0.37	-0.11
		790128C00-600-G	295mm	3.16	1.11	1.11	2.56	1.56
		79012CE00-600-G	450mm	0.74	0.03	0.03	1.73	-1.09
BT	Foxconn	79012CH00-600-G	200mm	2.42				