

Prüfbericht-Nr.: <i>Test Report No.:</i>	50241447 001	Auftrags-Nr.: <i>Order No.:</i>	238100183	Seite 1 von 64 <i>Page 1 of 64</i>
Kunden-Referenz-Nr.: <i>Client Reference No.:</i>	N/A	Auftragsdatum: <i>Order date:</i>	14-Jan-2019	
Auftraggeber: <i>Client:</i>	Hon Hai Precision Industry Co., Ltd. No. 151, Sec. 1, Nankan Rd., Lujhu Dist., Taoyuan City 33859, Taiwan (R.O.C)			
Prüfgegenstand: <i>Test item:</i>	IEEE 802.11 a/b/g/n/ac 2x2 + BT combo module			
Bezeichnung / Typ-Nr.: <i>Identification / Type No.:</i>	WBU042-IG5V, WBU042-IG			
Auftrags-Inhalt: <i>Order content:</i>	FCC Part 15C, FCC Part 2, IC RSS-247 Issue 2, IC RSS-102 Issue 5			
Prüfgrundlage: <i>Test specification:</i>	FCC 47CFR Part 15: Subpart C Section 15.247(DTS) FCC 47CFR Part 2: Subpart J Section 2.1091 RSS-247 Issue 2 Feb 2017 RSS-102 Issue 5 Mar 2015			
Wareneingangsdatum: <i>Date of receipt:</i>	14-Feb-2019			
Prüfmuster-Nr.: <i>Test sample No.:</i>	A000877050-008, 009			
Prüfzeitraum: <i>Testing period:</i>	14-Feb-2019 ~ 15-Mar-2019			
Ort der Prüfung: <i>Place of testing:</i>	EMC/RF Laboratory Taipei			
Prüflaboratorium: <i>Testing laboratory:</i>	TUV Rheinland Taiwan Ltd.			
Prüfergebnis*: <i>Test result*:</i>	Pass			
geprüft von / tested by:		kontrolliert von / reviewed by:		
2019-05-24	Mars Y.J. Lin / Project Engineer	2019-05-24	Arvin Ho / Vice General Manager	
Datum <i>Date(Report Date)</i>	Name / Stellung <i>Name / Position</i>	Unterschrift <i>Signature</i>	Datum <i>Date</i>	Name / Stellung <i>Name / Position</i>
				Unterschrift <i>Signature</i>
Sonstiges / Other: WBU042-IG and WBU042-IG5V use the same RF chip and the same PCB layout, the difference between WBU042-IG5V and WBU042-IG is: WBU042-IG5V more WBU042-IG one Regulator.				
Zustand des Prüfgegenstandes bei Anlieferung: <i>Condition of the test item at delivery:</i>		Prüfmuster vollständig und unbeschädigt <i>Test item complete and undamaged</i>		
* Legende:	1 = sehr gut P(ass) = entspricht o.g. Prüfgrundlage(n)	2 = gut F(ail) = entspricht nicht o.g. Prüfgrundlage(n)	3 = befriedigend N/A = nicht anwendbar	4 = ausreichend N/T = nicht getestet
Legend:	1 = very good P(ass) = passed a.m. test specification(s)	2 = good F(ail) = failed a.m. test specification(s)	3 = satisfactory N/A = not applicable	4 = sufficient N/T = not tested
Dieser Prüfbericht bezieht sich nur auf das o.g. Prüfmuster und darf ohne Genehmigung der Prüfstelle nicht auszugsweise vervielfältigt werden. Dieser Bericht berechtigt nicht zur Verwendung eines Prüfzeichens. <i>This test report only relates to the a. m. test sample. Without permission of the test center this test report is not permitted to be duplicated in extracts. This test report does not entitle to carry any test mark.</i>				

TEST SUMMARY

5.1.1 ANTENNA REQUIREMENT

RESULT: *Passed*

5.1.2 DUTY CYCLE

RESULT: *Passed*

5.1.3 AVERAGE OUTPUT POWER

RESULT: *Passed*

5.1.4 6dB & 99% BANDWIDTH

RESULT: *Passed*

5.1.5 POWER DENSITY

RESULT: *Passed*

5.1.6 CONDUCTED SPURIOUS EMISSIONS AND FREQUENCY BAND EDGE MEASURED IN 100KHZ BANDWIDTH

RESULT: *Passed*

5.1.7 SPURIOUS EMISSION

RESULT: *Passed*

5.2.1 MAINS CONDUCTED EMISSIONS

RESULT: *Passed*

6.1.1 ELECTROMAGNETIC FIELDS

RESULT: *Passed*

Contents

1.	GENERAL REMARKS	5
1.1	COMPLEMENTARY MATERIALS.....	5
1.2	COMPLEMENTARY MATERIALS.....	5
2.	TEST SITES	6
2.1	TEST LABORATORY	6
2.2	TEST FACILITY.....	6
2.3	LIST OF TEST AND MEASUREMENT INSTRUMENTS.....	7
2.4	TRACEABILITY	8
2.5	CALIBRATION	8
2.6	MEASUREMENT UNCERTAINTY	8
3.	GENERAL PRODUCT INFORMATION.....	9
3.1	PRODUCT FUNCTION AND INTENDED USE	9
3.2	SYSTEM DETAILS AND RATINGS.....	9
3.3	INDEPENDENT OPERATION MODES.....	10
3.4	NOISE GENERATING AND NOISE SUPPRESSING PARTS	10
3.5	SUBMITTED DOCUMENTS.....	10
4.	TEST SET-UP AND OPERATION MODES.....	11
4.1	PRINCIPLE OF CONFIGURATION SELECTION	11
4.2	TEST OPERATION AND TEST SOFTWARE.....	11
4.3	SPECIAL ACCESSORIES AND AUXILIARY EQUIPMENT	12
4.4	COUNTERMEASURES TO ACHIEVE EMC COMPLIANCE.....	12
4.5	TEST SETUP DIAGRAM	13
5.	TEST RESULTS	15
5.1	TRANSMITTER REQUIREMENT & TEST SUITES.....	15
5.1.1	<i>Antenna Requirement</i>	<i>15</i>
5.1.2	<i>Duty Cycle.....</i>	<i>16</i>
5.1.3	<i>Average Output Power.....</i>	<i>20</i>
5.1.4	<i>6dB & 99% Bandwidth</i>	<i>21</i>
5.1.5	<i>Power Density</i>	<i>35</i>
5.1.6	<i>Conducted spurious emissions and Frequency Band Edge measured in 100kHz Bandwidth.....</i>	<i>48</i>
5.1.7	<i>Spurious Emission</i>	<i>58</i>
5.2	MAINS EMISSIONS.....	59
5.2.1	<i>Mains Conducted Emissions.....</i>	<i>59</i>

6.	SAFETY HUMAN EXPOSURE	60
6.1	RADIO FREQUENCY EXPOSURE COMPLIANCE	60
6.1.1	<i>Electromagnetic Fields.....</i>	<i>60</i>
7.	PHOTOGRAPHS OF THE TEST SET-UP.....	61
8.	LIST OF TABLES	64
9.	LIST OF PHOTOGRAPHS.....	64

1. General Remarks

1.1 Complementary Materials

These attachments are integral parts of this test report:

Appendix P: Photo Documentation internal view
(File Name: 50241447 001APPENDIXP)

Appendix D: Test Result of Radiated Emissions
(File Name: 50241447 001APPENDIXD)

Test Specifications

The following standards were applied.

Table 1: Applied Standard and Test Levels

Radio
FCC CFR47 Part 15: Subpart C Section 15.247 FCC 47CFR Part 2: Subpart J Section 2.1091 ANSI C63.10:2013 KDB558074 D01 DTS Meas Guidance v05 KDB662911 D01 Multiple Transmitter Output v02r01 KDB662911 D02 MIMO with Cross Polarized Antenna v01 RSS-247 Issue 2 Feb 2017 RSS-102 Issue 5 Mar 2015 RSS-Gen Issue 5 Apr 2018

1.2 Complementary Materials

The decision rule of conformity of this test report is following the requirements of the requested standard in the quotation, and agreed among testing laboratory and manufacturer (applicant) to exclude the consideration of Measurement Uncertainty, unless it is required by the specific standard.

2. Test Sites

2.1 Test Laboratory

TUV Rheinland Taiwan Ltd.
Taichung Branch Office

No.9, Lane 36, Minsheng Rd., Sec. 3, Daya District,
Taichung City 428
Taiwan (R.O.C.)

2.2 Test Facility

TUV Rheinland Taiwan Ltd.
Taipei Office

11F. No.758, Sec. 4, Bade Rd., Songshan Dist.
Taipei City 105
Taiwan (R.O.C.)

FCC RegistrationNo.: 340738
IC Canada Registration No.: 9465A-1
TAF Accredited NCC Test Lab. No.:0759
TAF ISO17025 Certification effective periods: 2016-Jul-1st to 2019-Jun-30th



Testing Laboratory
0759

2.3 List of Test and Measurement Instruments

Table 2: List of Test and Measurement Equipment

Kind of Equipment	Manu-facturer	Type	S/N	Last Calibration	Next Calibration
Test Software	Farad	EZ_EMC	Ver. TUV3A1	N/A	N/A
Spectrum Analyzer	R&S	FSV 40	100921	2018/05/02	2019/05/02
EXA Signal Analyzer	KEYSIGHT	N9010A	MY52221334	2019/02/05	2020/02/04
Preamplifier (30MHz -1GHz)	HP	8447F	2805A03335	2018/08/14	2019/08/14
Preamplifier (18 GHz -40 GHz)	COM-POWER	PAM-840	461257	2019/01/18	2020/01/18
Pre-Amplifier (1GHz~18GHz)	EM Electronics	EM01G18G	60558	2018/11/21	2019/11/21
Bilog Antenna	TESEQ	CBL6111D	29804	2018/08/18	2019/08/18
Horn Antenna	ETS-Lindgren	3117	201918	2018/08/18	2019/08/18
Horn Antenna (18GHz~40GHz)	COM-POWER	AH-840	101029	2018/11/28	2019/11/28
Loop Antenna	Schwarzbeck	FMZB 1513	1513-076	2018/06/14	2019/06/14
EMI Test Receiver	R&S	ESR 7	101549	2018/11/10	2019/11/10
LISN (1 phase)	R&S	ENV216	101243	2018/06/18	2019/06/17
LISN	R&S	ENV216	101262	2018/06/22	2019/06/21
Spectrum Analyzer	R&S	FSL3	101943	2018/09/07	2019/09/07
Temp. & Humid. Chamber	Giant Force	GCT-099-40-S	MAF0103-007	2019/03/09	2021/03/09

2.4 Traceability

All measurement equipment calibrations are traceable to NML(Taiwan)/NIST(USA) or where calibration is performed outside Taiwan, to equivalent nationally recognized standards organizations.

2.5 Calibration

Equipment requiring calibration is calibrated periodically in a suitably accredited Calibration Lab. Additionally all equipment is verified for proper performance on a regular schedule using in house standards or comparisons.

2.6 Measurement Uncertainty

The estimated combined standard uncertainty for radiated emissions and conducted emissions measurements .

Table 3: Emission Measurement Uncertainty

Parameter	Uncertainty
Radio Frequency	± 0.1 ppm
RF power, conducted	± 1.5 dB
RF power density, conducted	± 3 dB
spurious emissions, conducted	± 3 dB
all emissions, radiated	± 6 dB
Temperature	± 1 °C
Humidity	± 5 %
DC and low frequency voltages	±3 %

3. General Product Information

3.1 Product Function and Intended Use

The EUT is a WiFi 802.11 a/b/g/n/ac + Bluetooth 5.0 Combo module. It contains a WiFi 2.4G compatible module enabling the user to communicate data through a Wireless interface. For details refer to the User Guide, Data Sheet and Block Diagram.

3.2 System Details and Ratings

Table 4: Basic Information of EUT

Item	EUT information
Kind of Equipment/Test Item	IEEE 802.11 a/b/g/n/ac 2x2 + BT combo module
Type Identification	WBU042-IG5V, WBU042-IG
FCC ID	RX3-WBU042IG
IC ID	2878F-WBU042IG
HVIN	WBU042-IG

Table 5: Technical Specification of EUT

Technical Specification	Value
Operating Frequencies	802.11b/g/n20 : 2412MHz ~ 2462MHz
Channel Spacing	5 MHz
Channel number	802.11b/g/n20 : 11
Operation Voltage	5Vdc for WBU042-IG5V 3.3Vdc for WBU042-IG
Modulation	802.11b : DSSS(BPSK, QPSK, CCK) 802.11g/n : OFDM(BPSK, QPSK, 16QAM, 64QAM)
Antenna gain	Ant 1: 1.42dBi Ant 2: 1.11dBi

3.3 Independent Operation Modes

Basic operation modes are:

- A. Transmitting
 - 1. Low channel
 - 2. Middle channel
 - 3. High channel
- B. Receiving

3.4 Noise Generating and Noise Suppressing Parts

Refer to the Block Diagram.

3.5 Submitted Documents

- Block Diagram
- Instruction Manual
- Rating Label
- Technical Description

4. Test Set-up and Operation Modes

4.1 Principle of Configuration Selection

The test modes were adapted accordingly in reference to the instructions for use.

During testing, Channel and Power Controlling Software provided by the customer was used to control the operating channel as well as the output power level. The RF output power selection is for the setting of RF output power expected by the customer and is going to be fixed on the firmware of the final end product.

Table 6: Table for Parameters of Test Software Setting

Mode	Channel Frequency					
	NCB: 20MHz			NCB: 40MHz		
	2412 MHz	2437 MHz	2462 MHz	2422 MHz	2437 MHz	2452 MHz
802.11b DSSS 1M	1C	1D	1C	x	x	x
802.11g OFDM 6M	1C	1C	1C	x	x	x
802.11n MCS0 HT20 MCS0	23	24	23	x	x	x
802.11n MCS0 HT40 MCS0	x	x	x	x	x	x

4.2 Test Operation and Test Software

Setup for testing: Test samples are provided with USB interface which makes it possible to control them through a test software installed on a notebook computer.

This software "MT7668 QATool" was running on the laptop computer connected to the EUT. It was used to enable the operation modes listed in section 3.3 as appropriate.

The samples were used as follows:
A000877050-008 for Conducted test
A000877050-009 for Radiated test

Full test was applied on all test modes, but only worst case was shown

IEEE 802.11b mode:

Channel Low (2412MHz), Channel Mid (2437MHz) and Channel High (2462MHz) with 1Mbps data rate were chosen for full testing.

IEEE 802.11g mode:

Channel Low (2412MHz), Channel Mid (2437MHz) and Channel High (2462MHz) with 6Mbps data rate were chosen for full testing.

IEEE 802.11n HT 20 mode:

Channel Low (2412MHz), Channel Mid (2437MHz) and Channel High (2462MHz) with 13Mbps data rate were chosen for full testing.

4.3 Special Accessories and Auxiliary Equipment

The product has been tested together with the following additional accessories:

Kind of Equipment	Manufacturer	Model Name	S/N
Notebook(EMC-05)	Lenovo	TP00048A	PB-0F8B2

4.4 Countermeasures to achieve EMC Compliance

The test sample which has been tested contained the noise suppression parts as described in the Constructional Data Form or the Technical Construction File. No additional measures were employed to achieve compliance.

4.5 Test Setup Diagram

Diagram of Measurement Configuration for Radiation Test

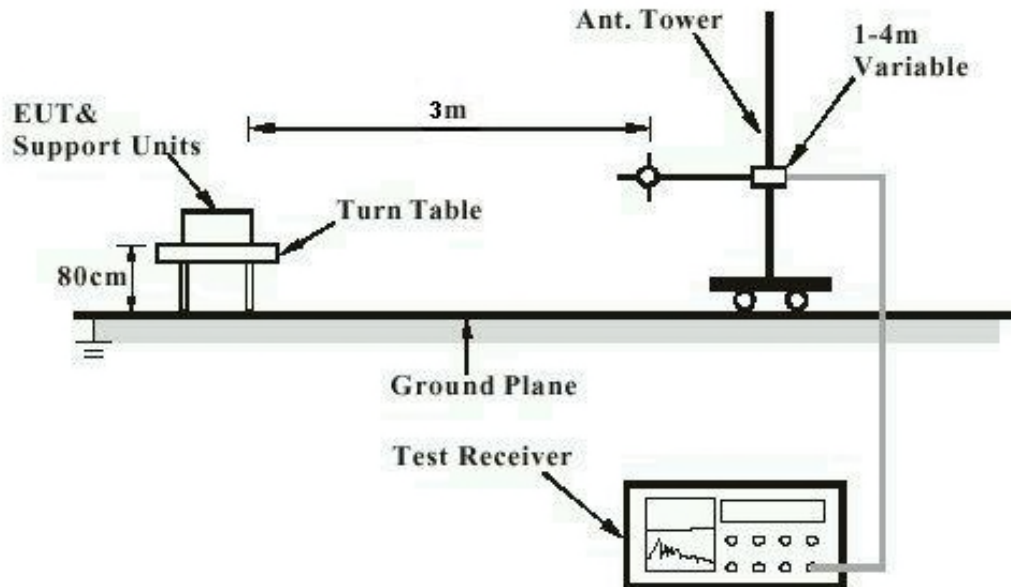

Note: Measurements above 1 GHz are done with a table height of 1.5m

Diagram of Measurement Equipment Configuration for Mains Conduction Measurement (if applicable)

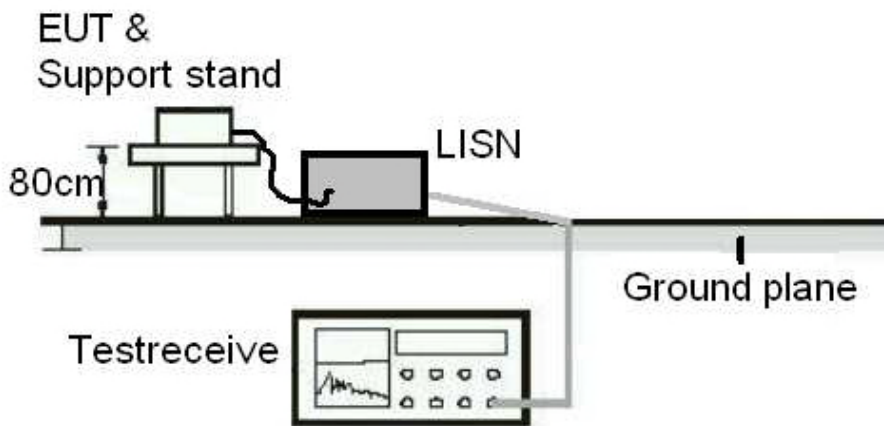
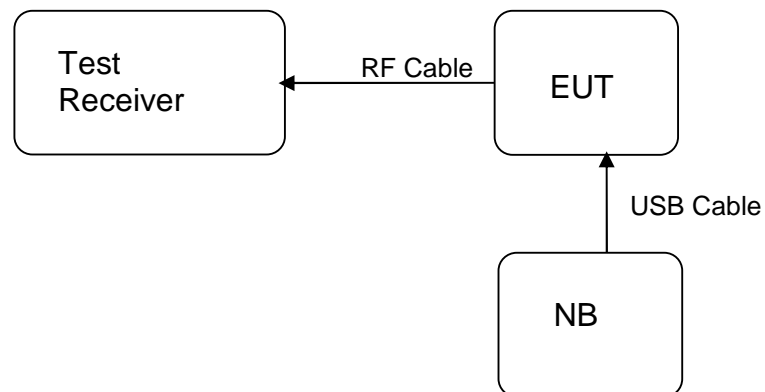

Diagram of Measurement Equipment Configuration for Conducted Transmitter Measurement



5. Test Results

5.1 Transmitter Requirement & Test Suites

5.1.1 Antenna Requirement

RESULT: **Passed**

Test standard : FCC Part 15.247(b)(4), Part 15.203 and
RSS-Gen 6.8

Requirement : use of approved antennas only with directional gains that
do not exceed 6 dBi

According to the manufacturer declaration, the EUT has an antenna with a directional gain of 4.28 dBi. The antenna is a Pifa Antenna with no possibility of replacement with a non-approved antenna by the end-user. Therefore, the EUT is considered to comply with this provision.

Refer to EUT photo for details.

5.1.2 Duty Cycle

RESULT:
Passed

Test standard : KDB 558074 Zero-Span Spectrum Analyzer Method
 Limit : None; for reporting purposes only
 Kind of test site : Shielded room / Conducted room

Test setup

Operation Mode : A

Table 7: Test result of Duty Cycle

Mode	On Time(ms)	On+Off Time(ms)	Duty Cycle (%)	Duty Factor (dB)
802.11b DSSS 1M	8.390	8.410	99.76%	0.01
802.11g OFDM 6M	1.395	1.420	98.24%	0.08
802.11n HT20 MCS0	1.305	1.330	98.12%	0.08

Test Plot of Duty Cycle

802.11b
On Time

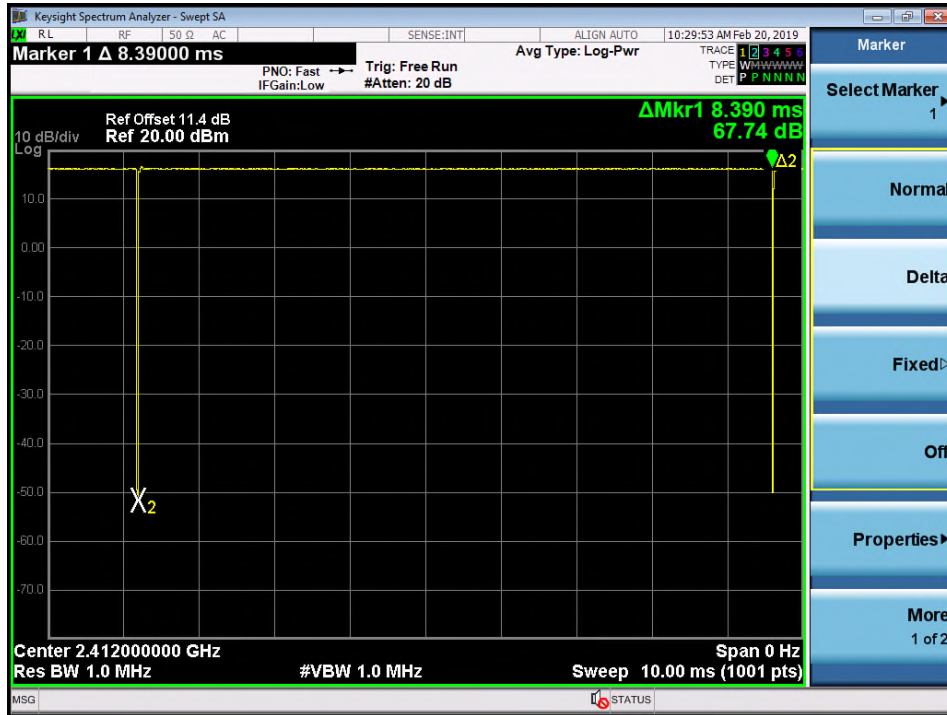

On+Off Time

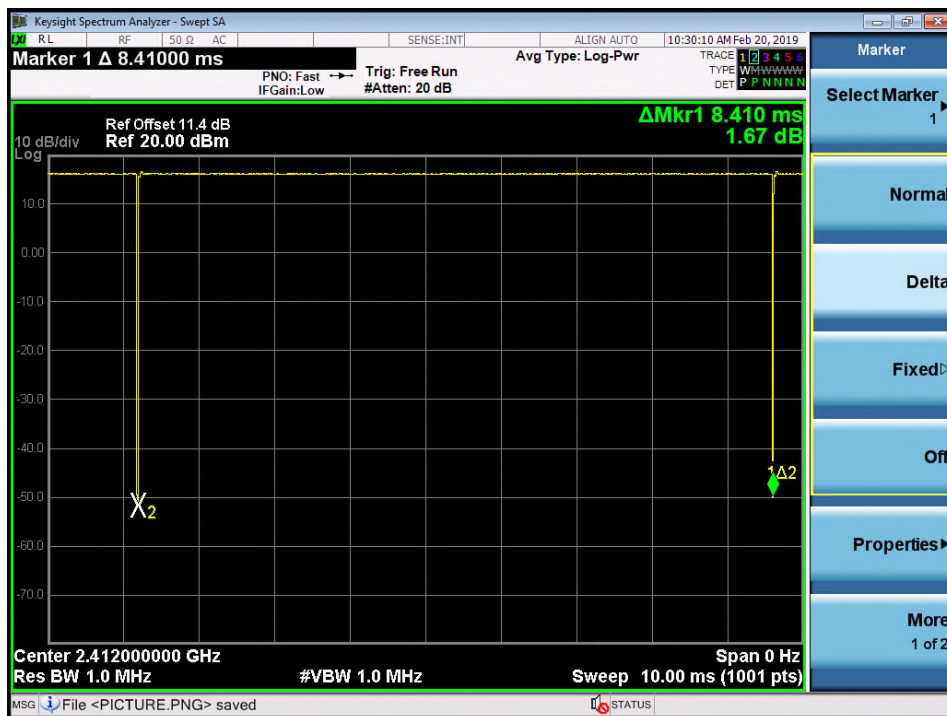

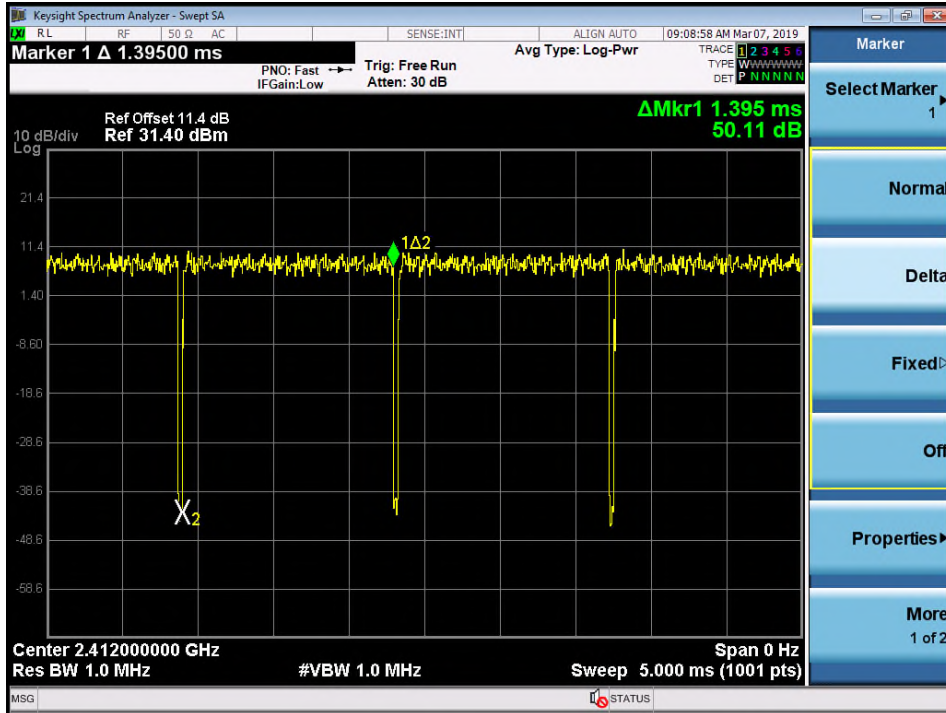
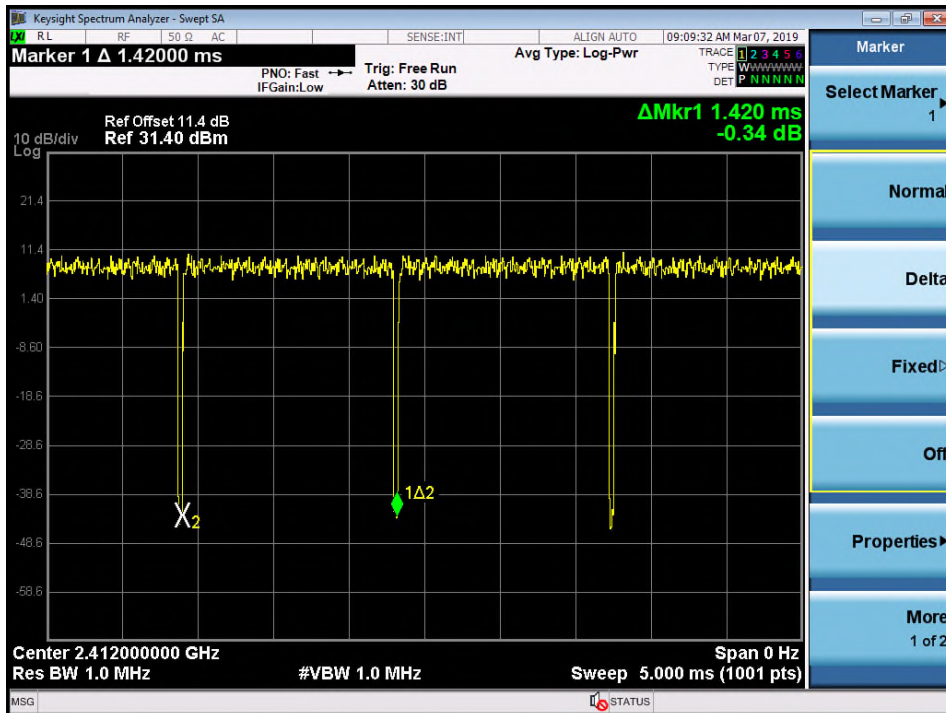
802.11g
On Time

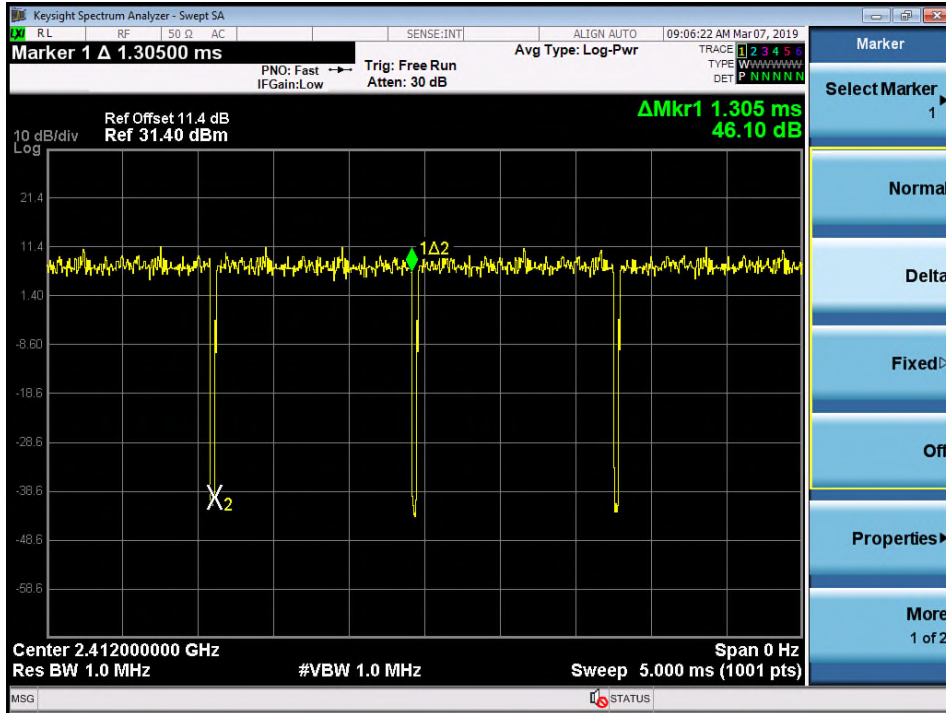
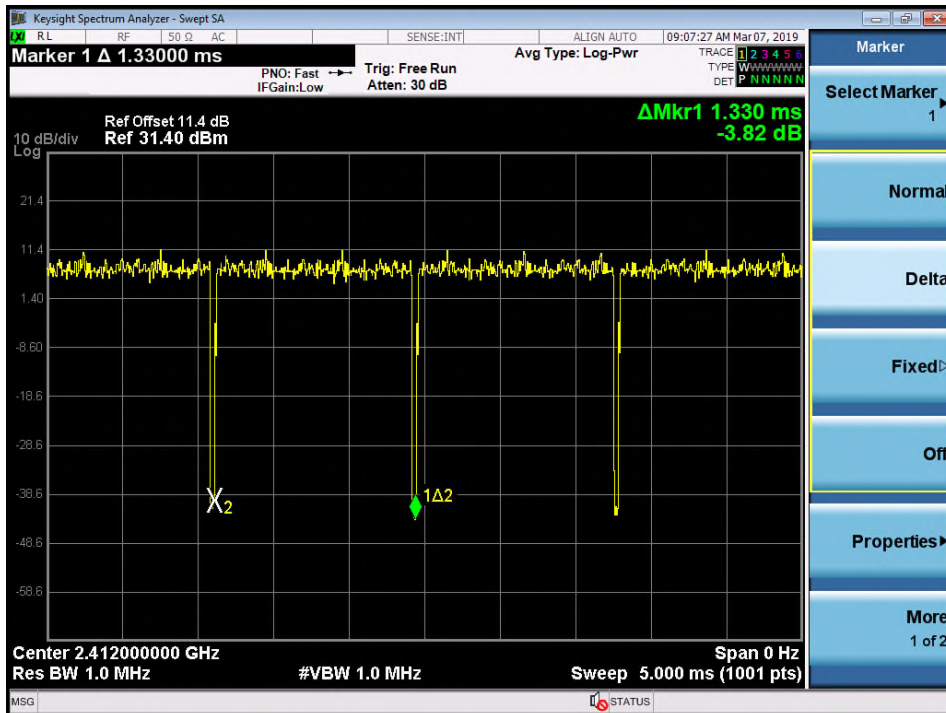
On+Off Time

802.11n HT20
On Time

On+Off Time

5.1.3 Average Output Power

RESULT:
Passed

Test standard : FCC Part 15.247(b)(3), RSS-247 5.4(d)
 Basic standard : ANSI C63.10:2013, KDB558074
 Limit : 1 Watt
 Kind of test site : Shielded room

Test setup

Test Channel : Low/ Middle/ High
 Operation Mode : A

 Ambient temperature : 20-24 °C
 Relative humidity : 50-65 %
 Atmospheric pressure : 100-103 kPa

Table 8: Test result of Average Output Power

Mode	Channel Frequency (MHz)	Average Output Power			Limit (W)
		Ant 1 (dBm)	Ant 2 (dBm)	Total (dBm)	
802.11b DSSS 1M	2412	14.99	14.86	17.94	1
	2437	14.98	14.91	17.96	1
	2462	14.97	14.82	17.91	1
802.11g OFDM 6M	2412	14.98	14.72	17.86	1
	2437	14.81	14.64	17.74	1
	2462	14.99	14.93	17.97	1
802.11n HT20 MCS0	2412	14.96	14.81	17.90	1
	2437	14.96	14.75	17.87	1
	2462	14.98	14.87	17.93	1

5.1.4 6dB & 99% Bandwidth

RESULT:
Passed

Test standard : FCC Part 15.247(a)(2), RSS-247 5.2(a)
 Basic standard : ANSI C63.10:2013, KDB558074
 Kind of test site : Shielded room

Test setup

Test Channel : Low/ Middle/ High
 Operation Mode : A
 Ambient temperature : 20-24°C
 Relative humidity : 50-65%
 Atmospheric pressure : 100-103 kPa

Table 9: Test result of 6dB Bandwidth

Mode	Channel Frequency (MHz)	6dB Bandwidth (MHz)	Limit (kHz)	Result
802.11b DSSS 1M	2412	7.11	>500	Pass
	2437	6.63	>500	Pass
	2462	7.60	>500	Pass
802.11g OFDM 6M	2412	15.17	>500	Pass
	2437	15.15	>500	Pass
	2462	13.89	>500	Pass
802.11n HT20 MCS0	2412	12.70	>500	Pass
	2437	12.69	>500	Pass
	2462	15.74	>500	Pass

Table 10: Test result of 99% Bandwidth

Mode	Channel Frequency (MHz)	99% Bandwidth (MHz)	Result
802.11b DSSS 1M	2412	15.56	Pass
	2437	11.20	Pass
	2462	14.64	Pass
802.11g OFDM 6M	2412	16.91	Pass
	2437	15.72	Pass
	2462	16.46	Pass
802.11n HT20 MCS0	2412	16.82	Pass
	2437	17.80	Pass
	2462	17.63	Pass

Test Plot of 6dB Bandwidth

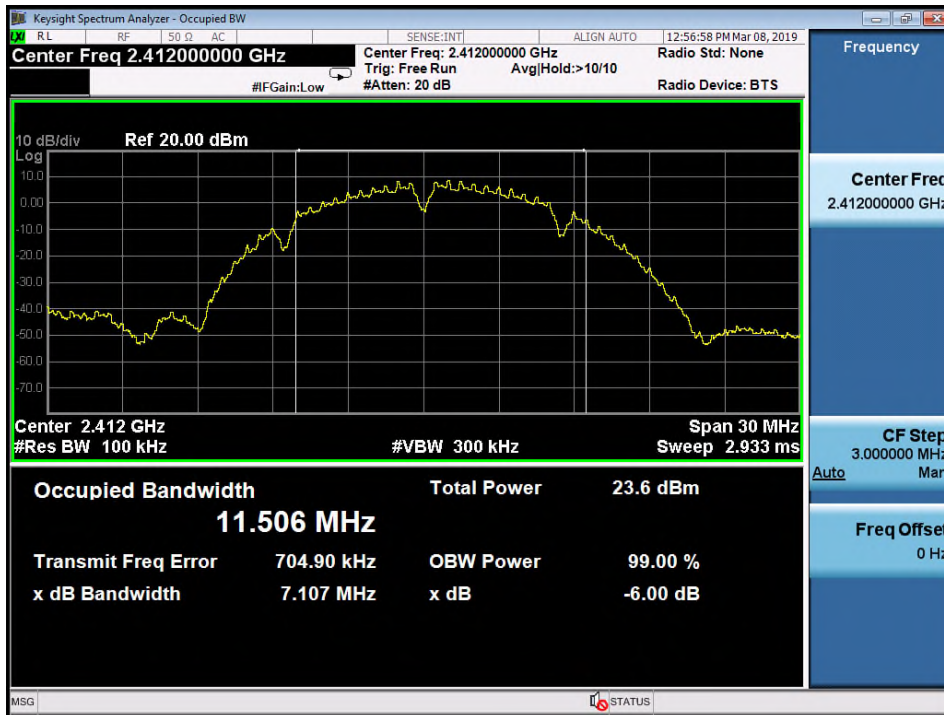
802.11b
Low Channel

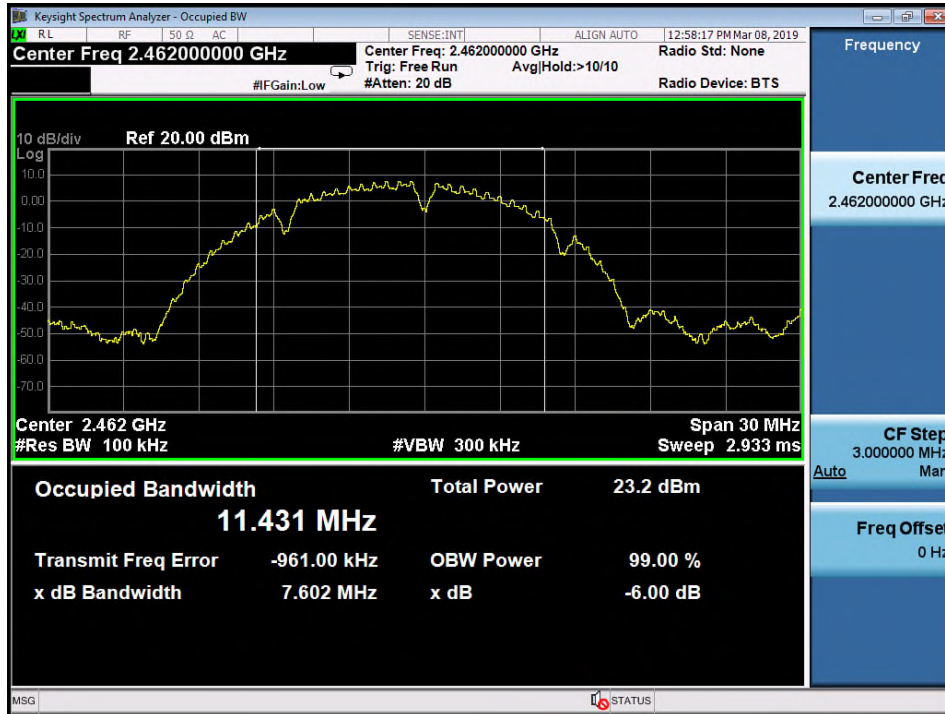
Middle Channel

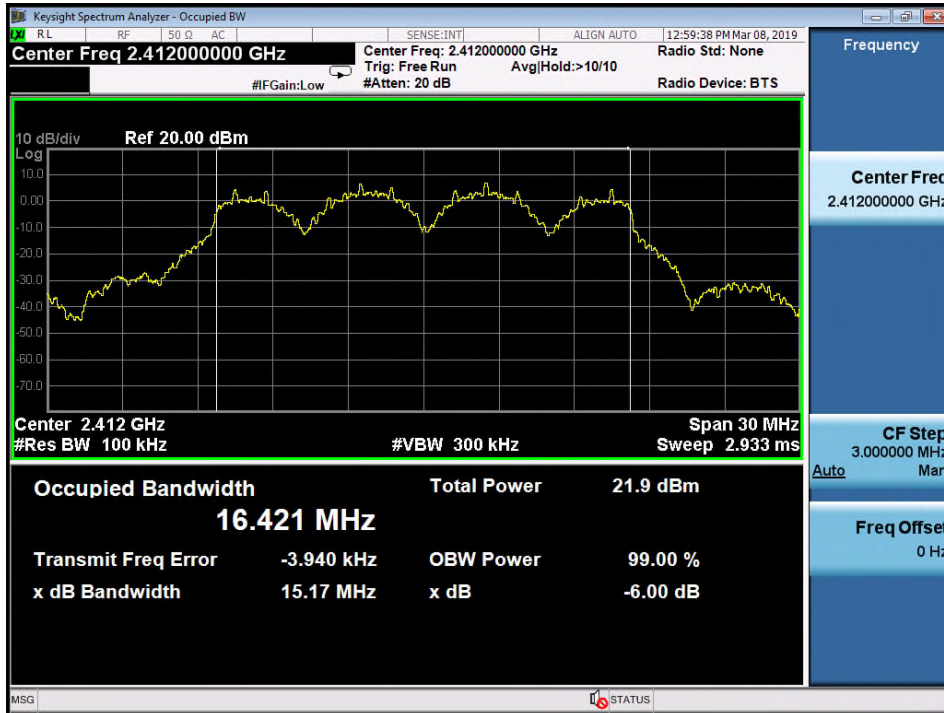
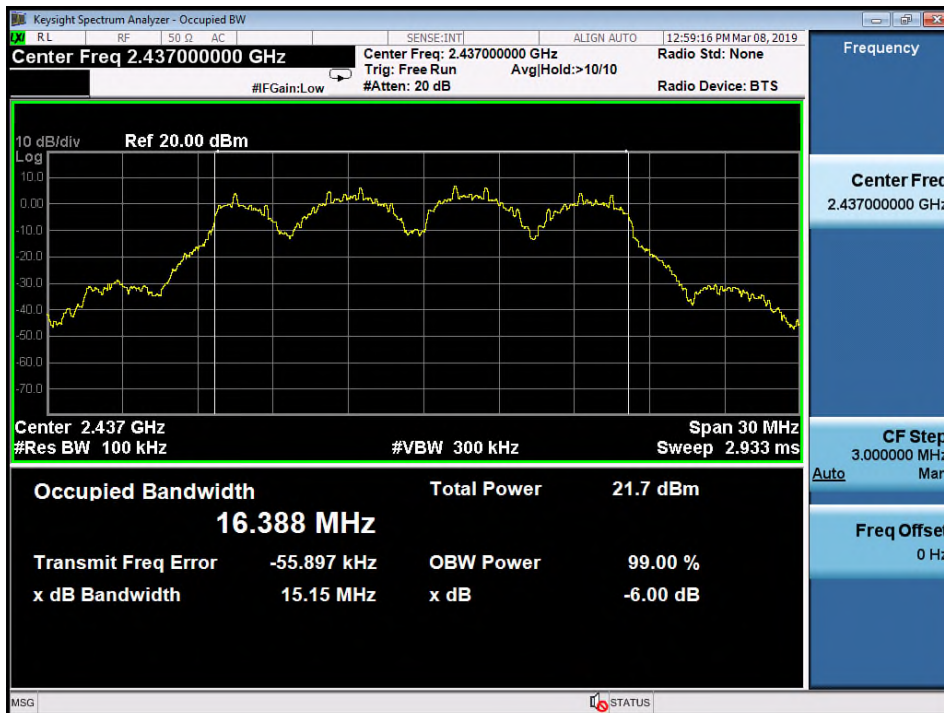
High Channel

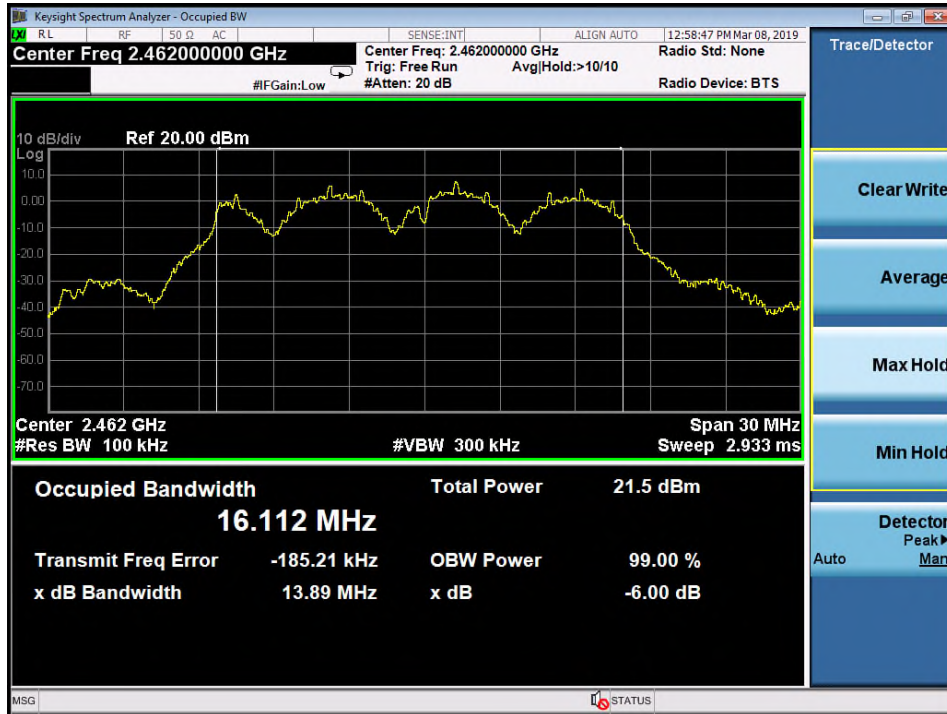
802.11g
Low Channel

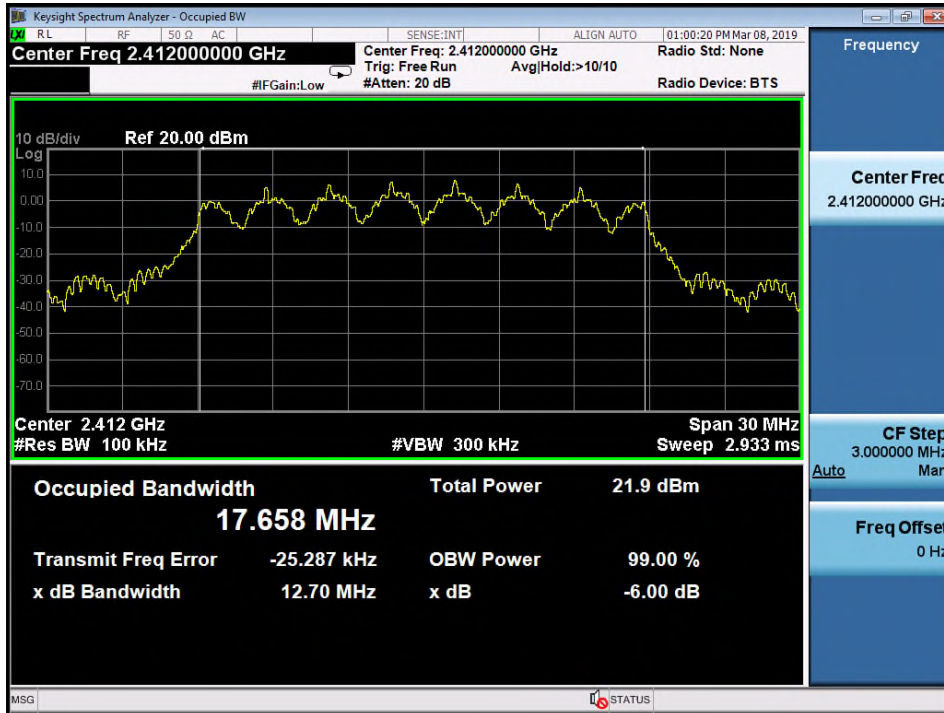
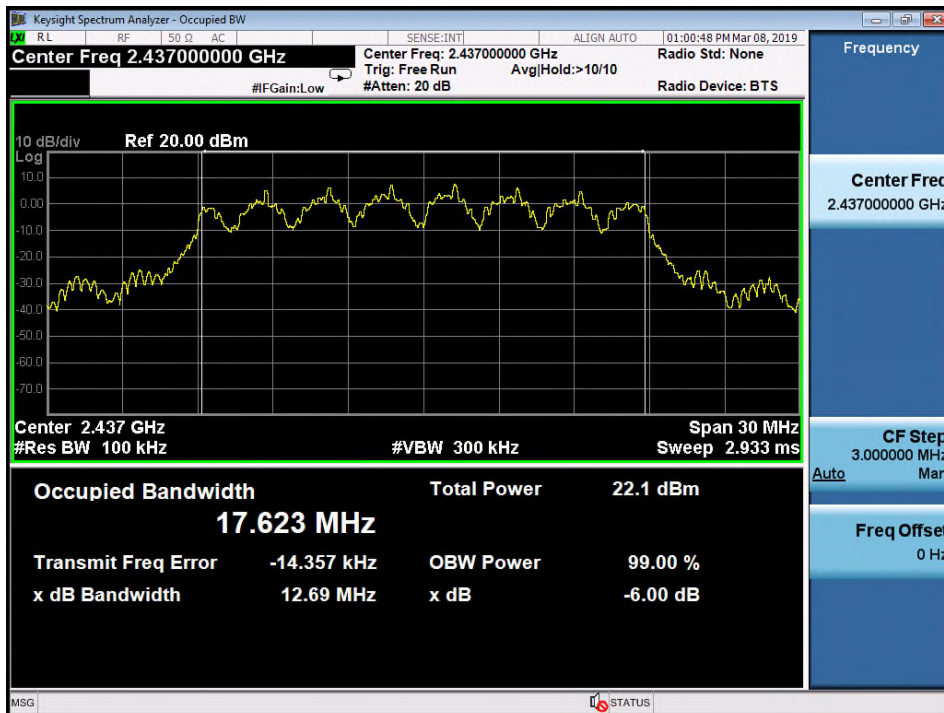
Middle Channel

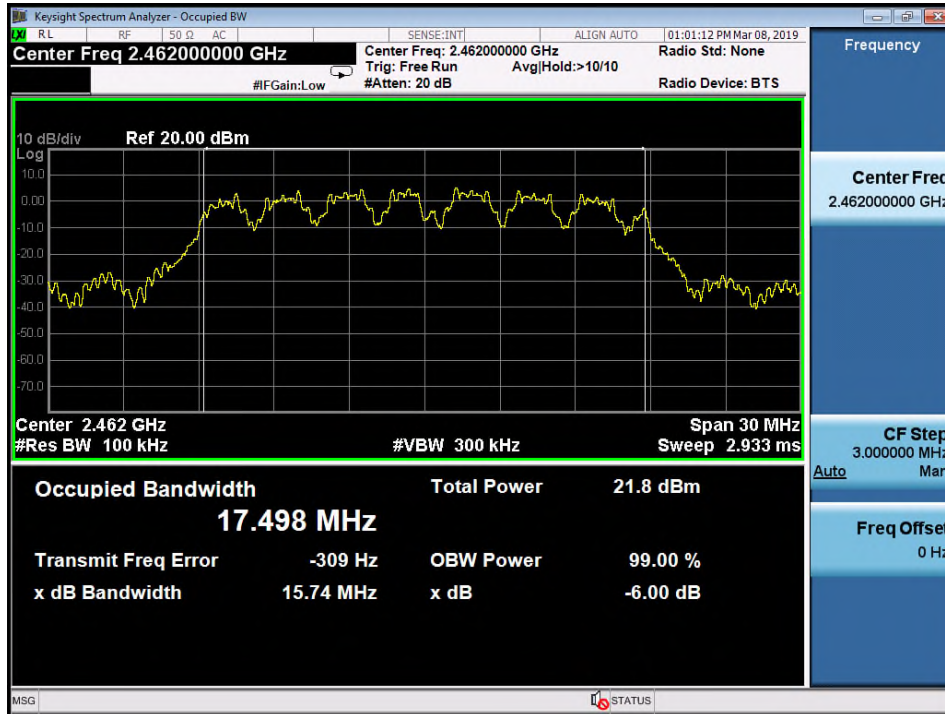
High Channel

802.11n HT20
Low Channel

Middle Channel

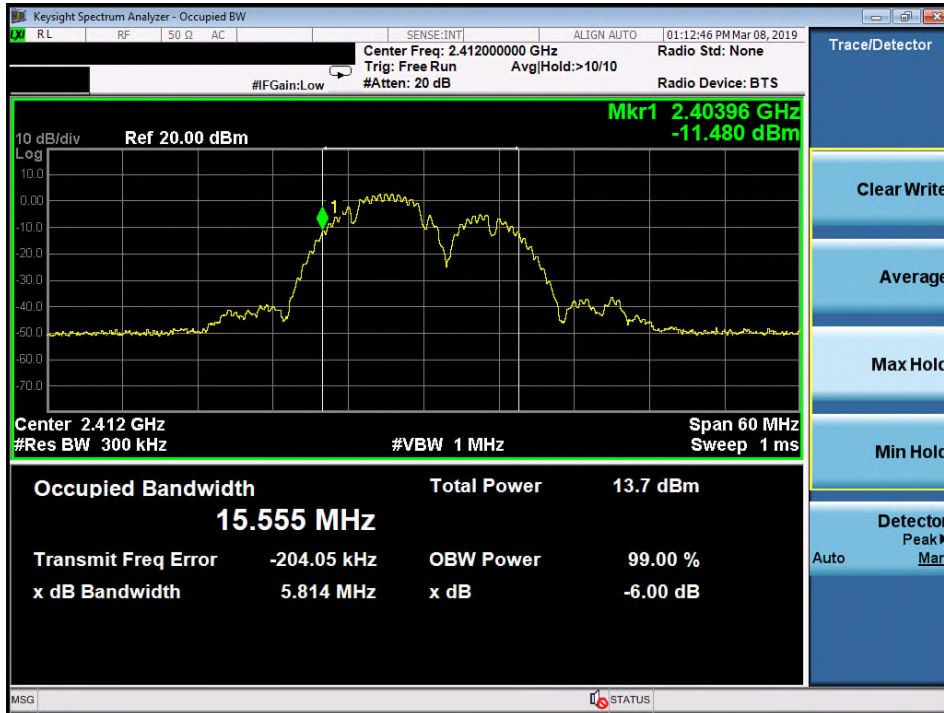
High Channel

Test Plot of 99% Bandwidth

802.11b
Low Channel

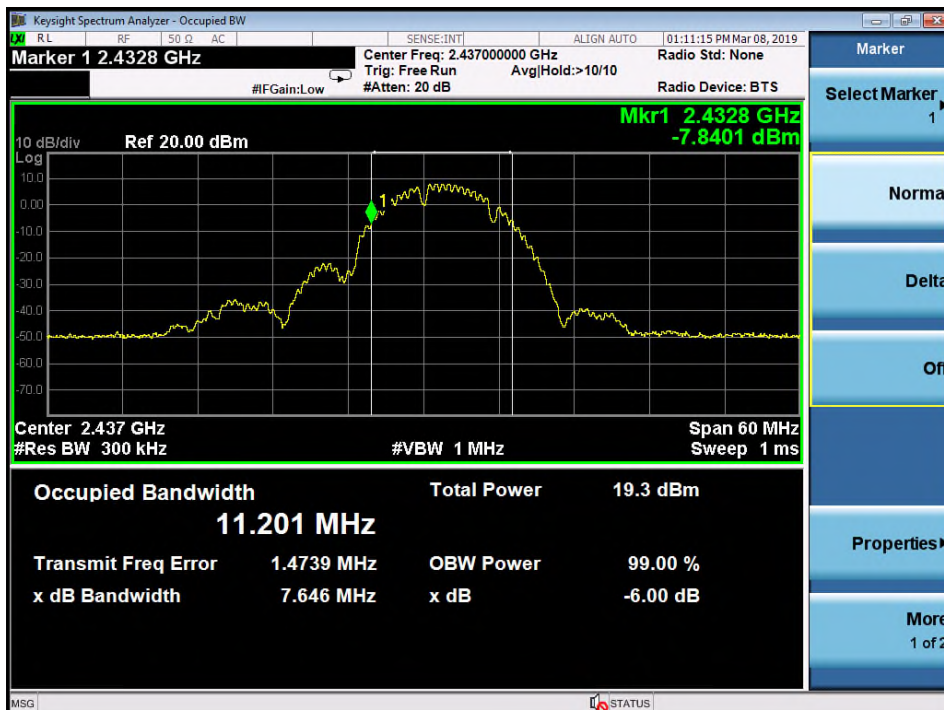
Middle Channel

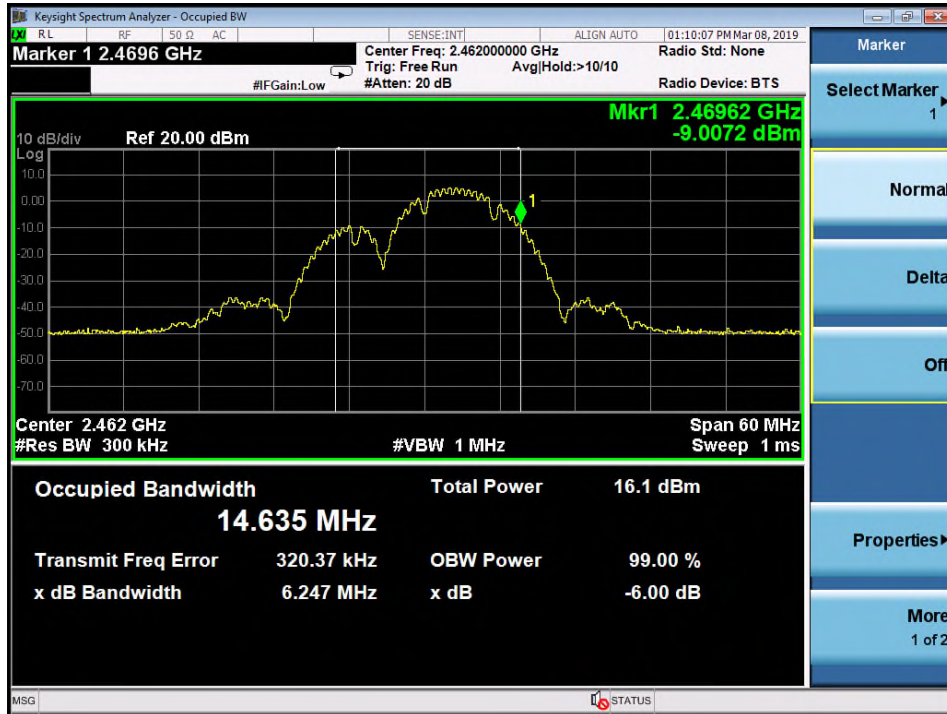

High Channel

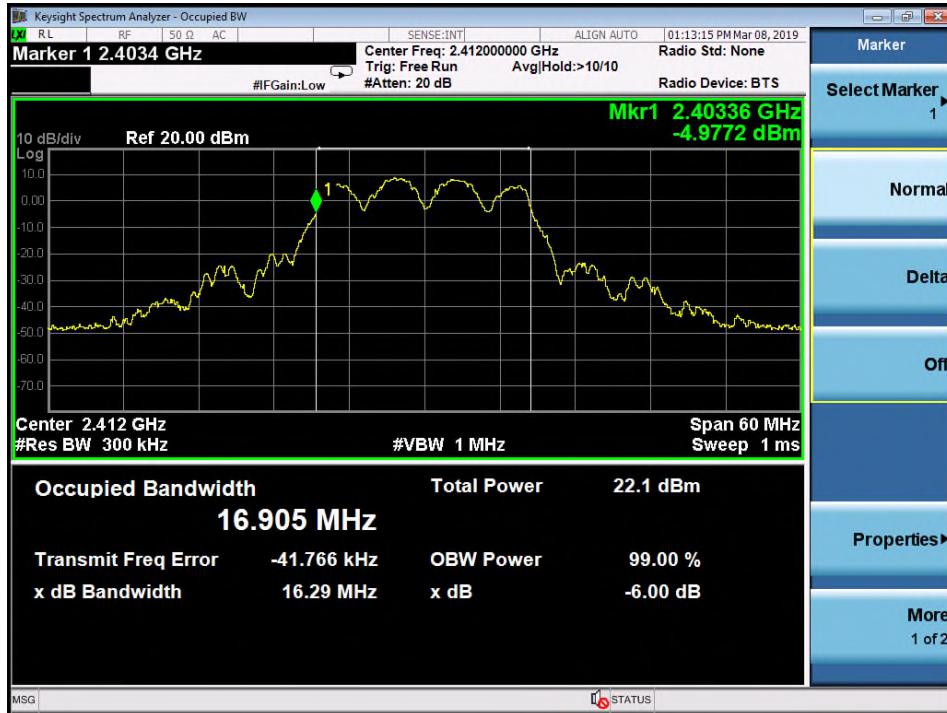
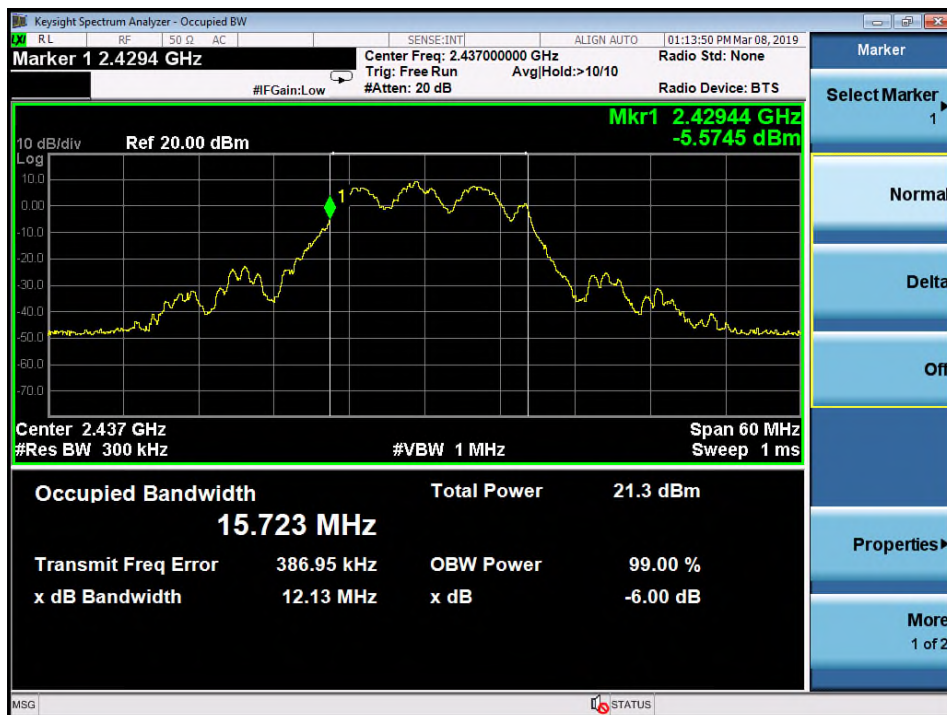
802.11g
Low Channel

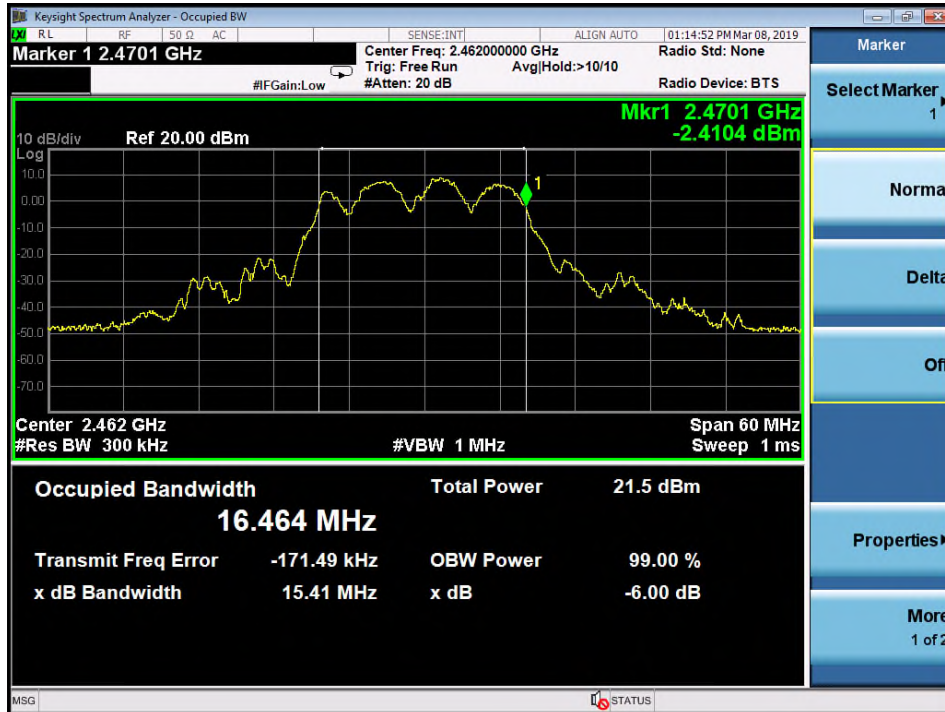
Middle Channel

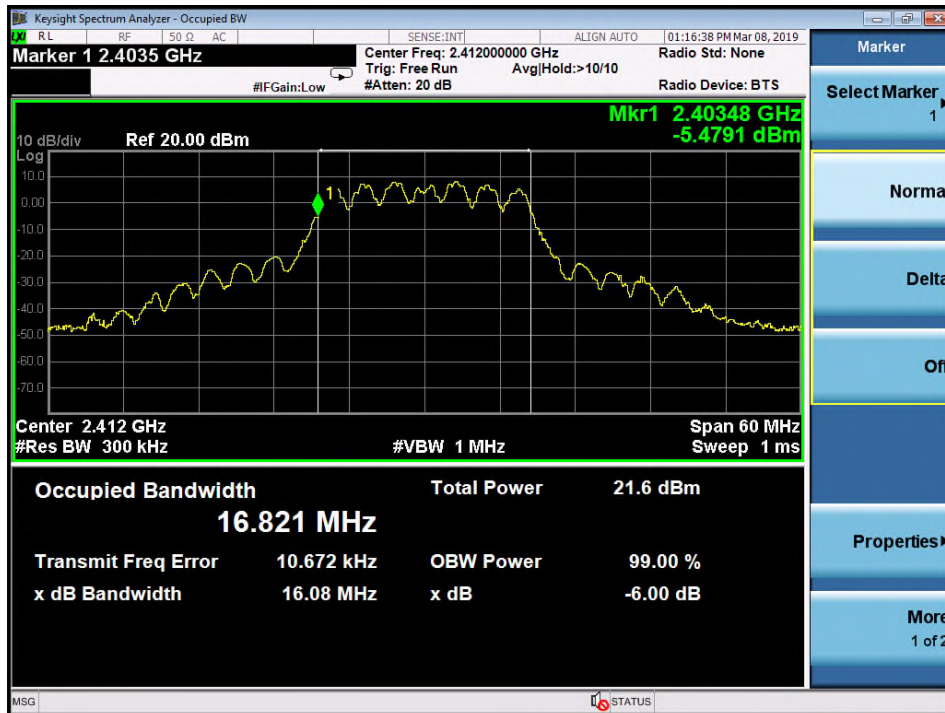
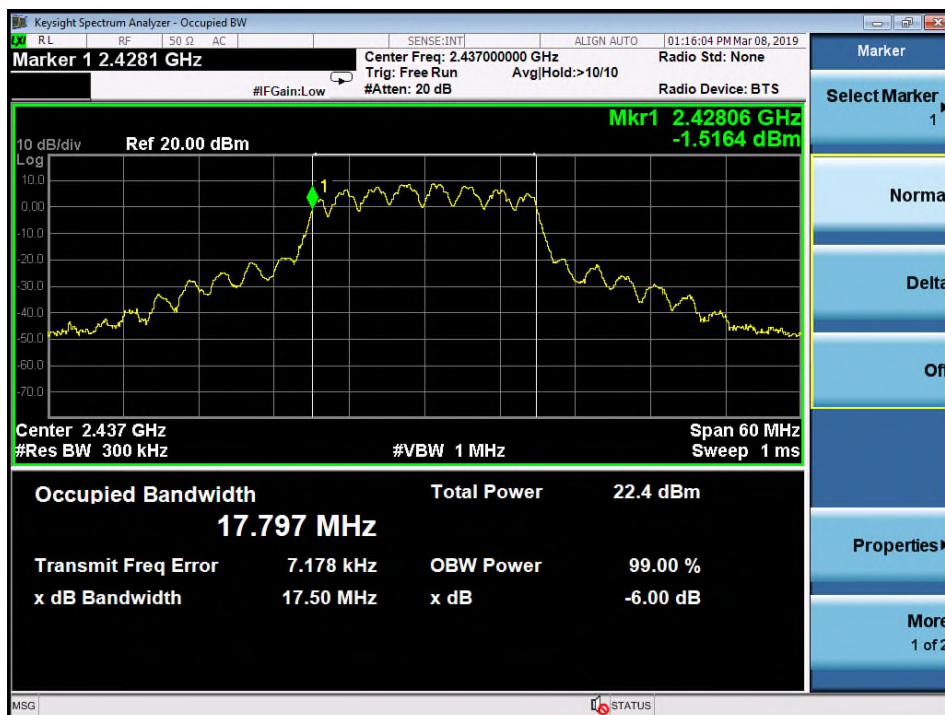
High Channel

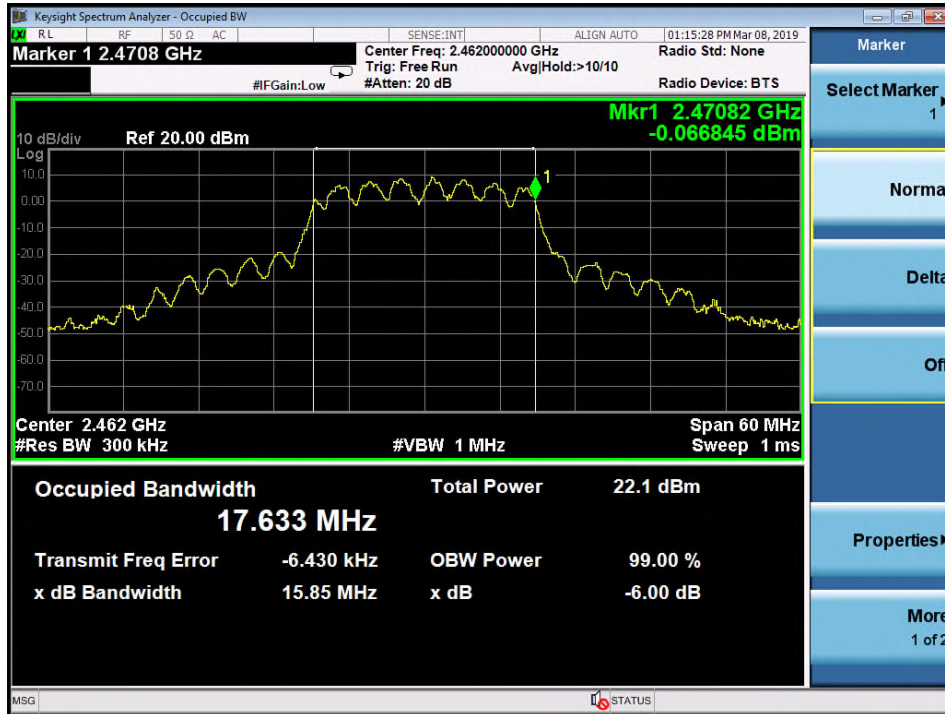
802.11n HT20
Low Channel

Middle Channel

High Channel

5.1.5 Power Density

RESULT:
Passed

Test standard : FCC Part 15.247(e) , RSS-247 5.2(b)
 Basic standard : ANSI C63.10:2013, KDB558074
 Kind of test site : Shielded room

Test setup

Test Channel : Low/ Middle/ High
 Operation Mode : A
 Ambient temperature : 20-24°C
 Relative humidity : 50-65%
 Atmospheric pressure : 100-103 kPa

Table 11: Test result of Power Density

Mode	Channel Frequency (MHz)	Peak Power Density			Limit (dBm/3kHz)
		Ant 1 (dBm)	Ant 2 (dBm)	Total (dBm)	
802.11b DSSS 1M	2412	-9.53	-10.65	-7.05	8
	2437	-9.98	-10.31	-7.13	8
	2462	-9.04	-11.28	-7.01	8
802.11g OFDM 6M	2412	-10.36	-11.78	-8.00	8
	2437	-11.28	-11.52	-8.39	8
	2462	-11.49	-11.93	-8.69	8
802.11n HT20 MCS0	2412	-11.38	-11.56	-8.46	8
	2437	-11.63	-10.85	-8.21	8
	2462	-10.67	-11.04	-7.84	8

Test Plot of Peak Power Density

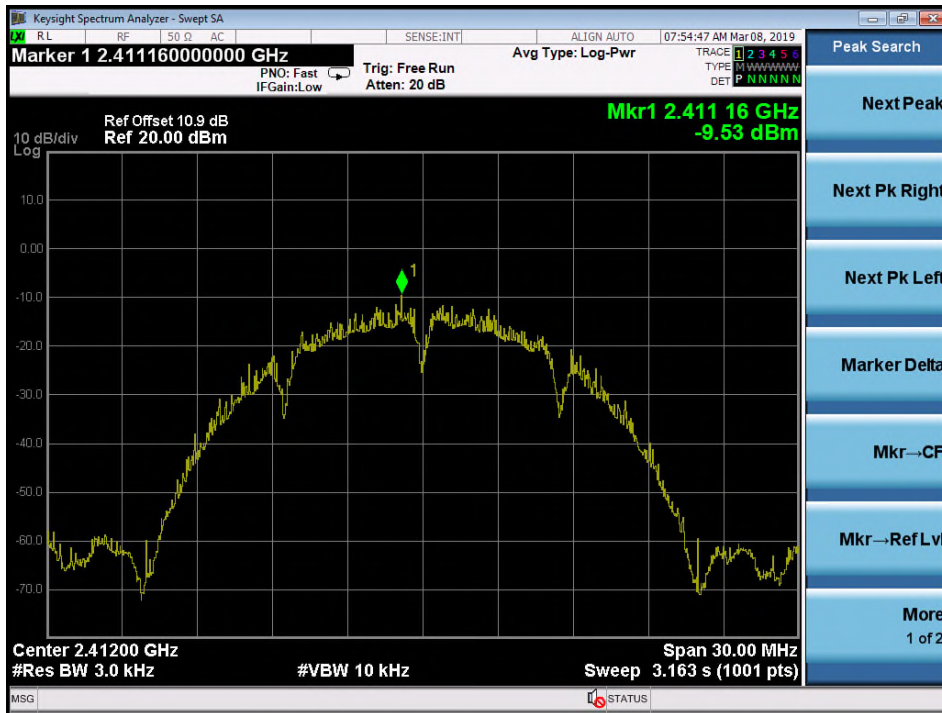
802.11b Antenna 1
Low Channel

Middle Channel

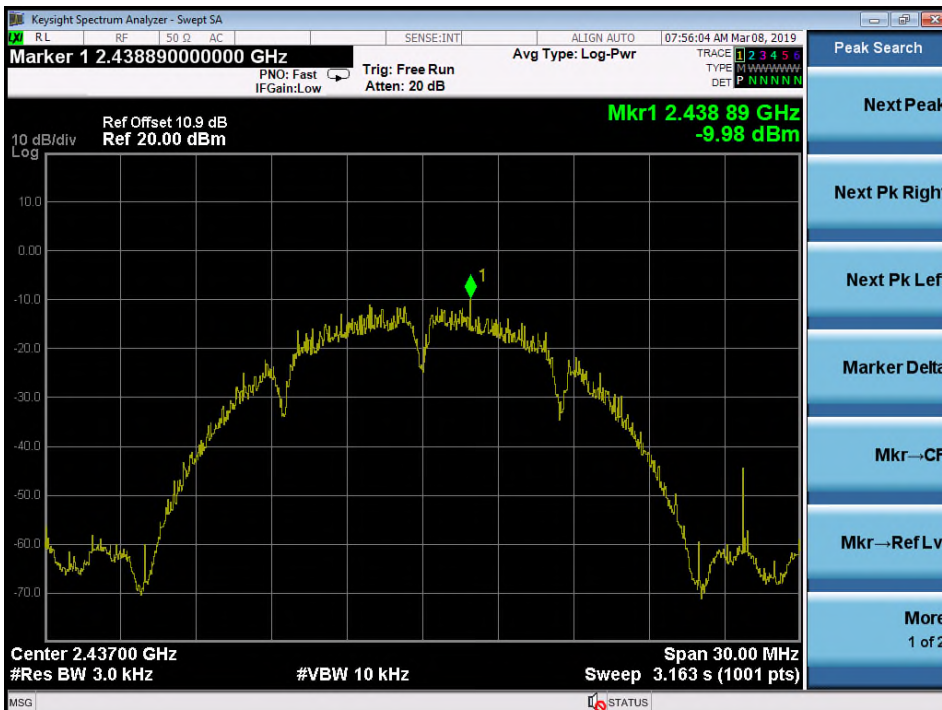

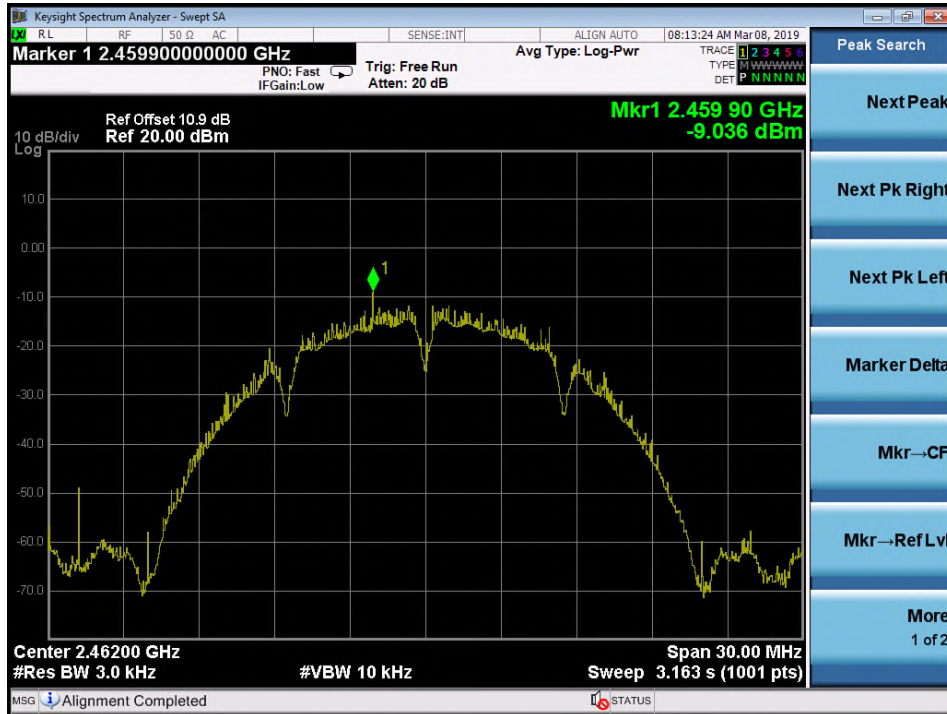
High Channel

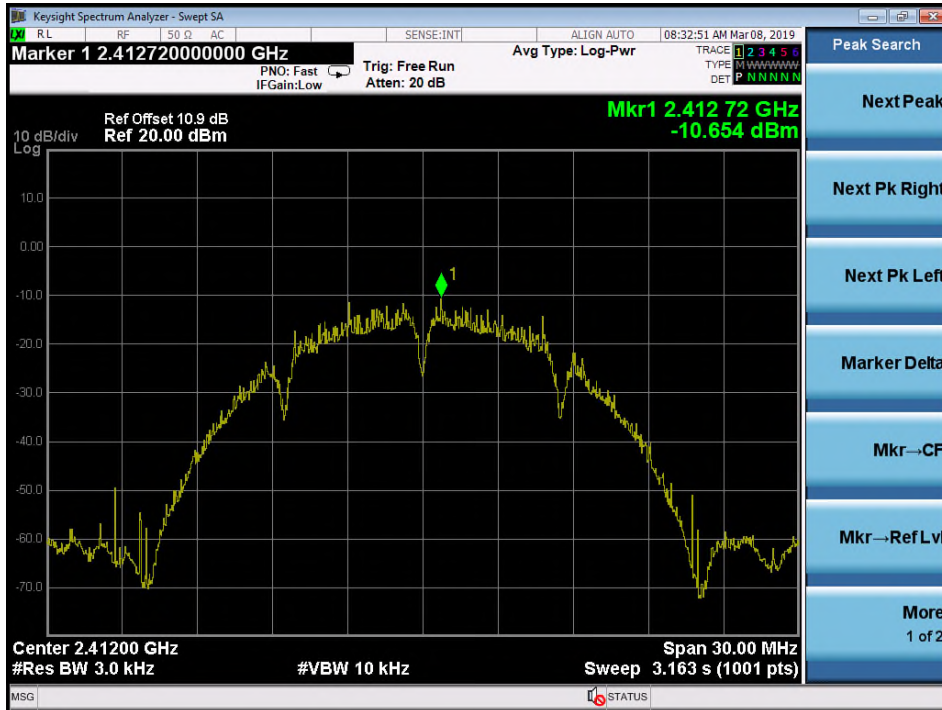
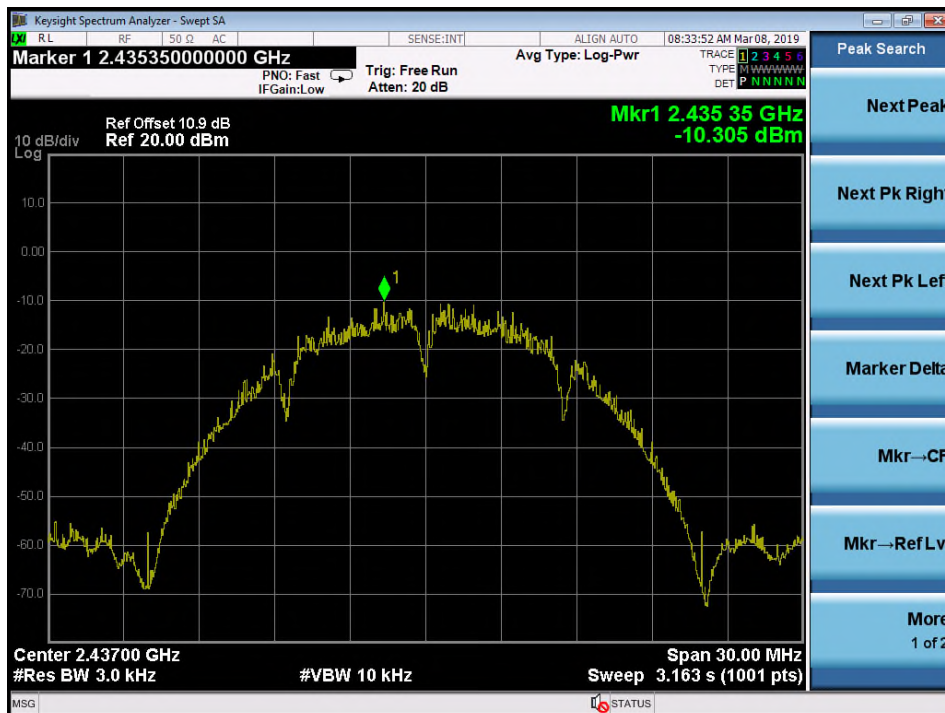
802.11b Antenna 2
Low Channel

Middle Channel

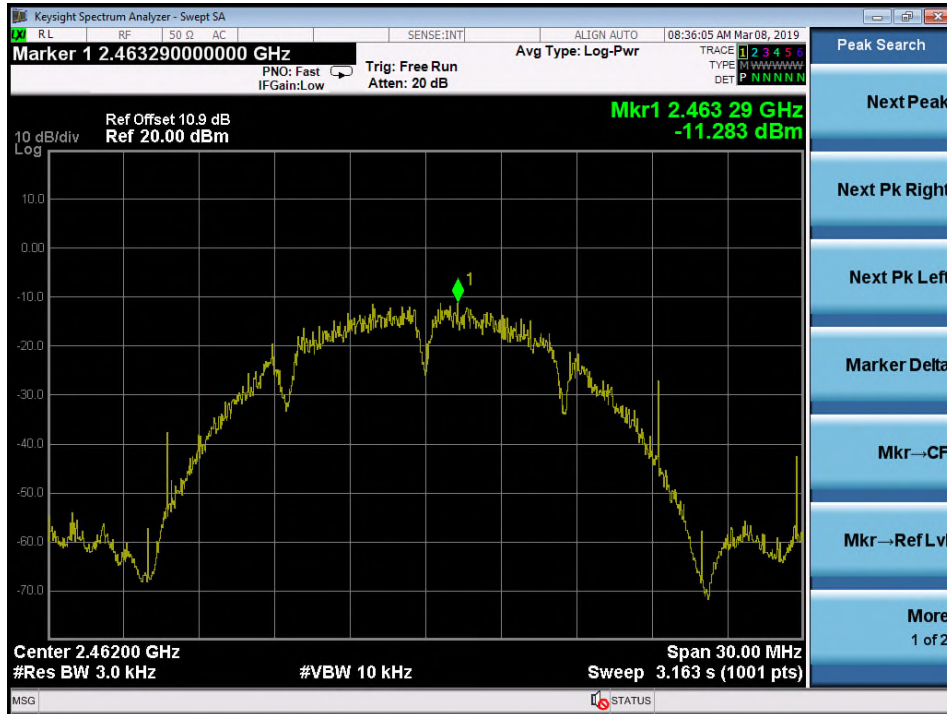
High Channel

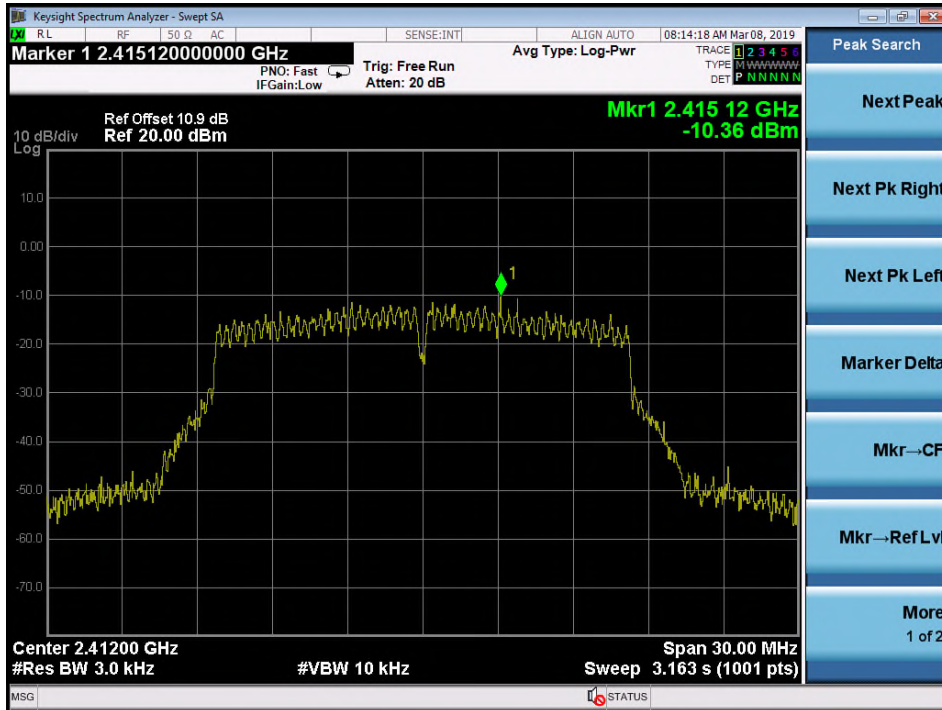
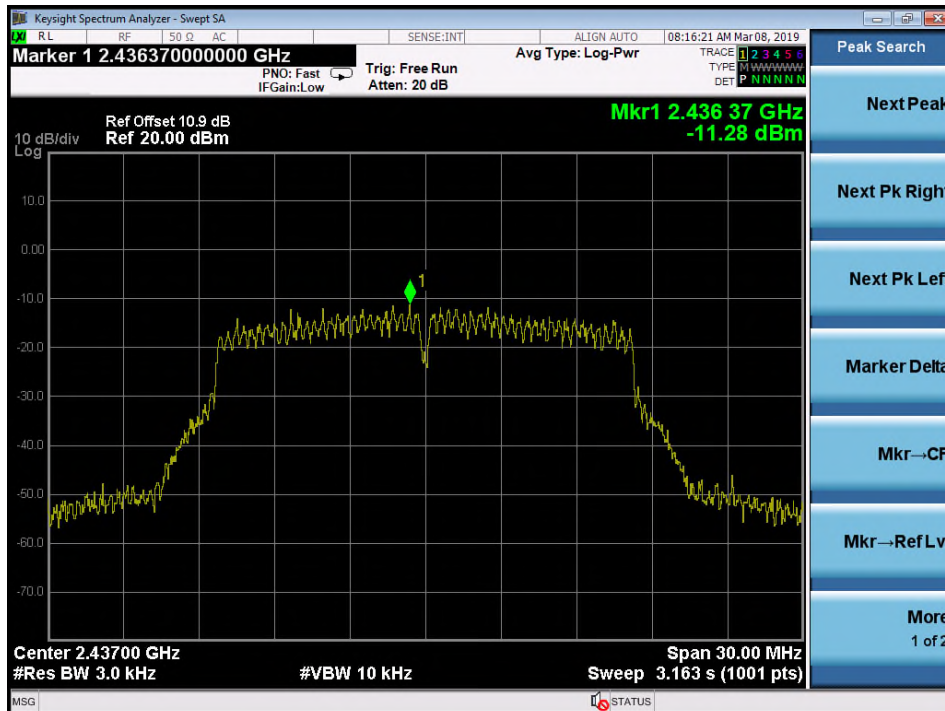

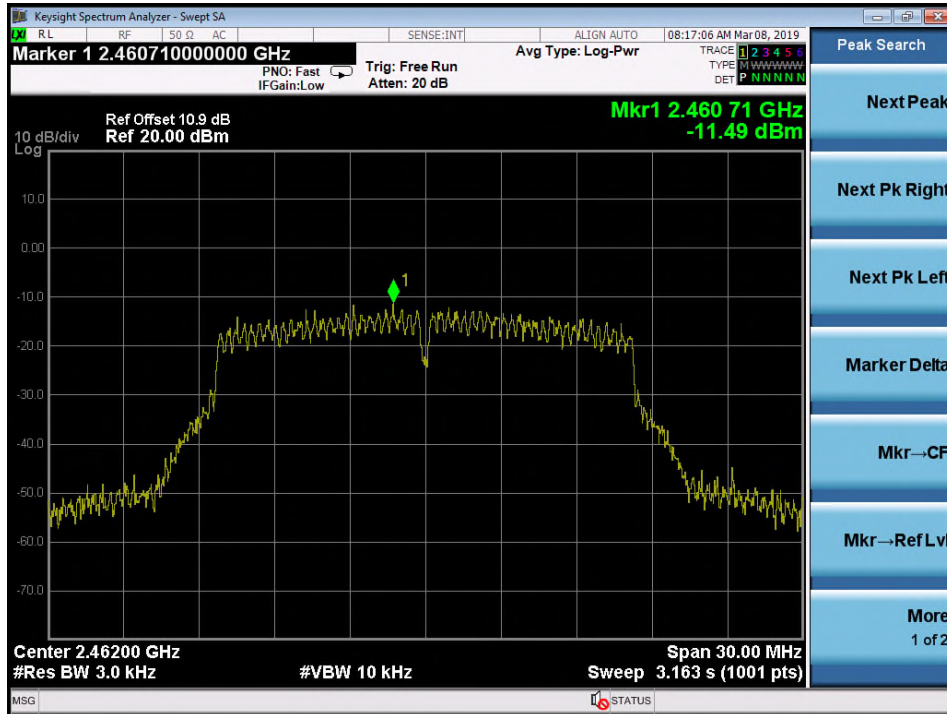
802.11g Antenna 1
Low Channel

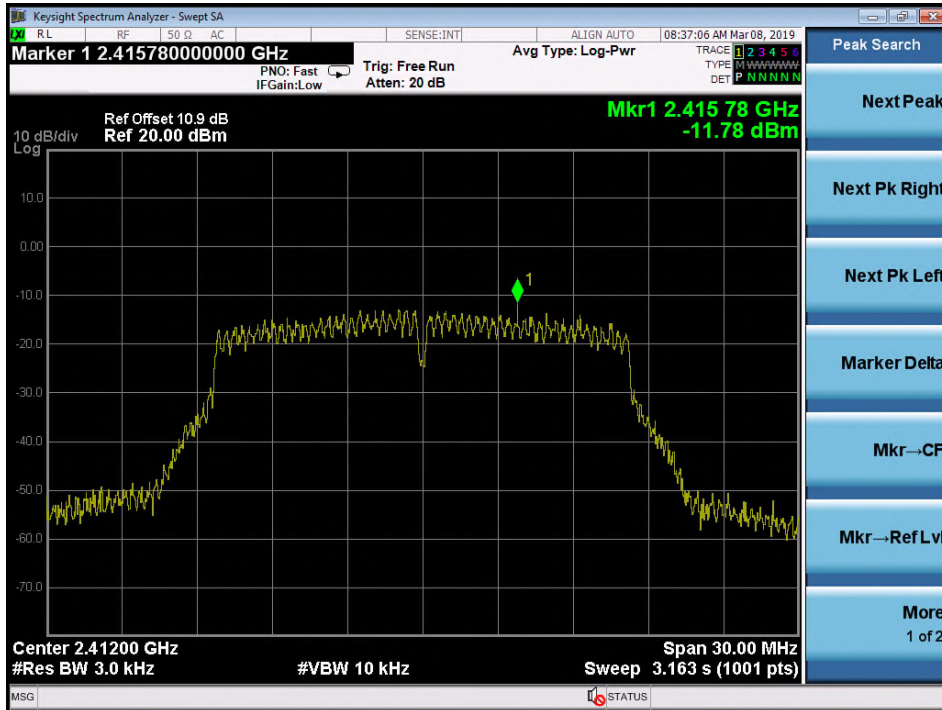
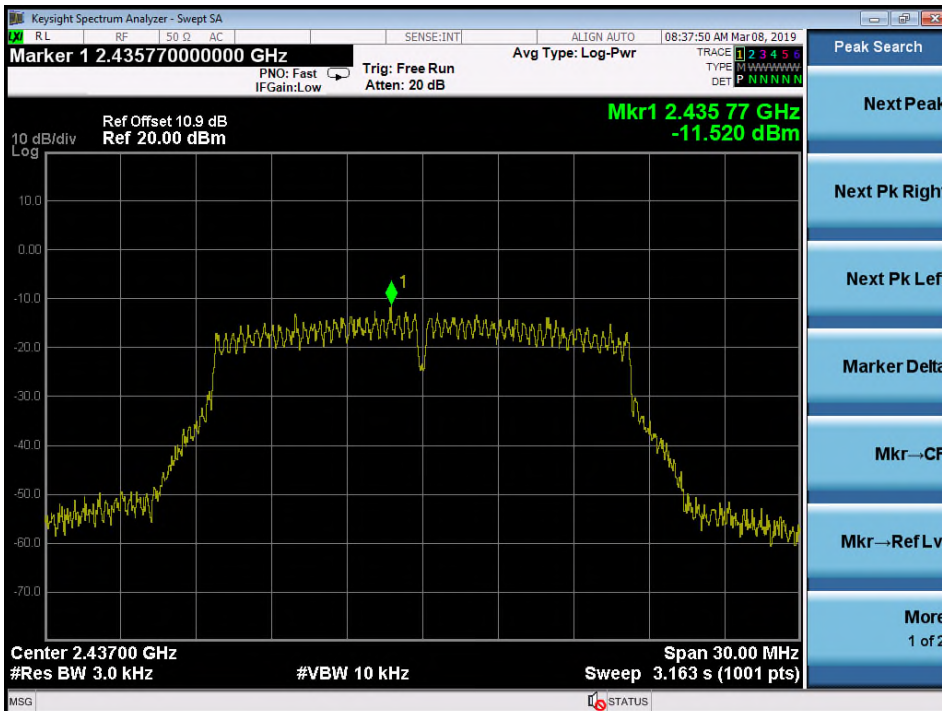
Middle Channel

High Channel

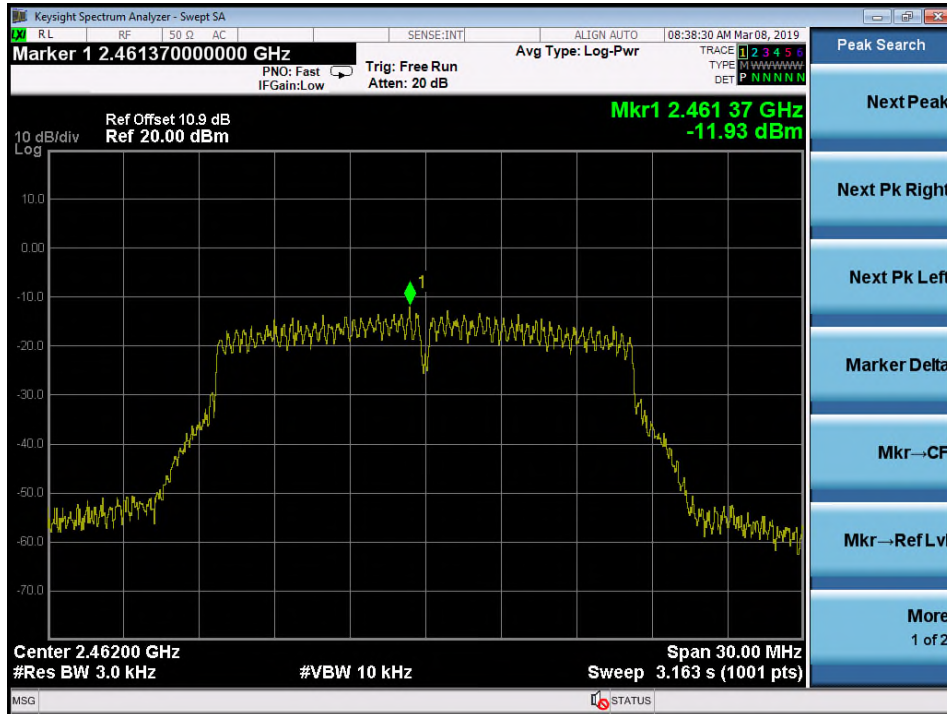
802.11g Antenna 2
Low Channel

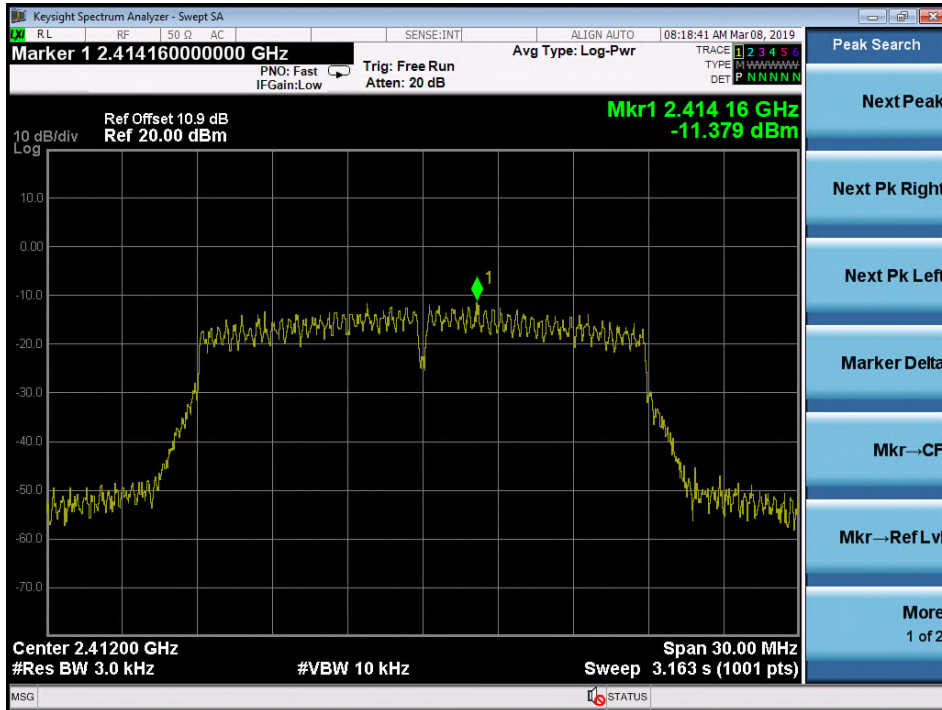
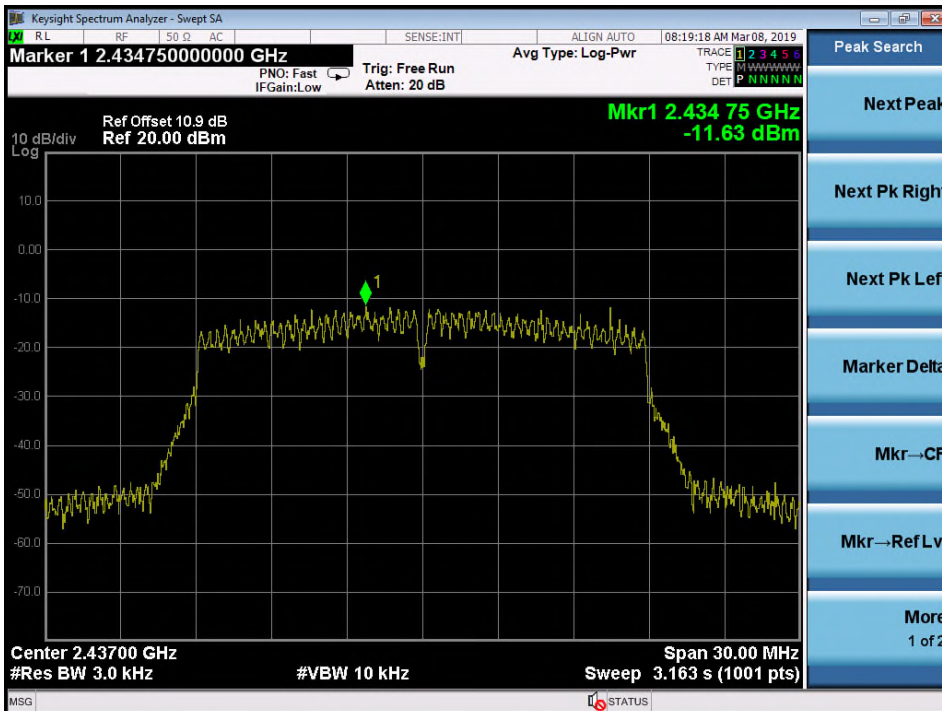
Middle Channel

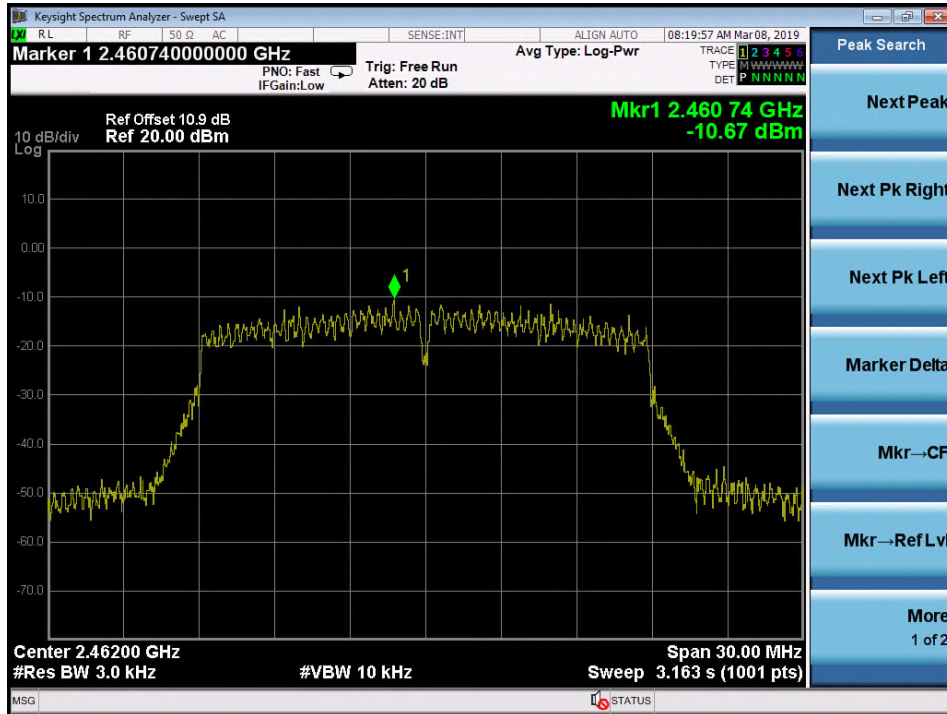
High Channel

802.11n HT20 Antenna 1
Low Channel

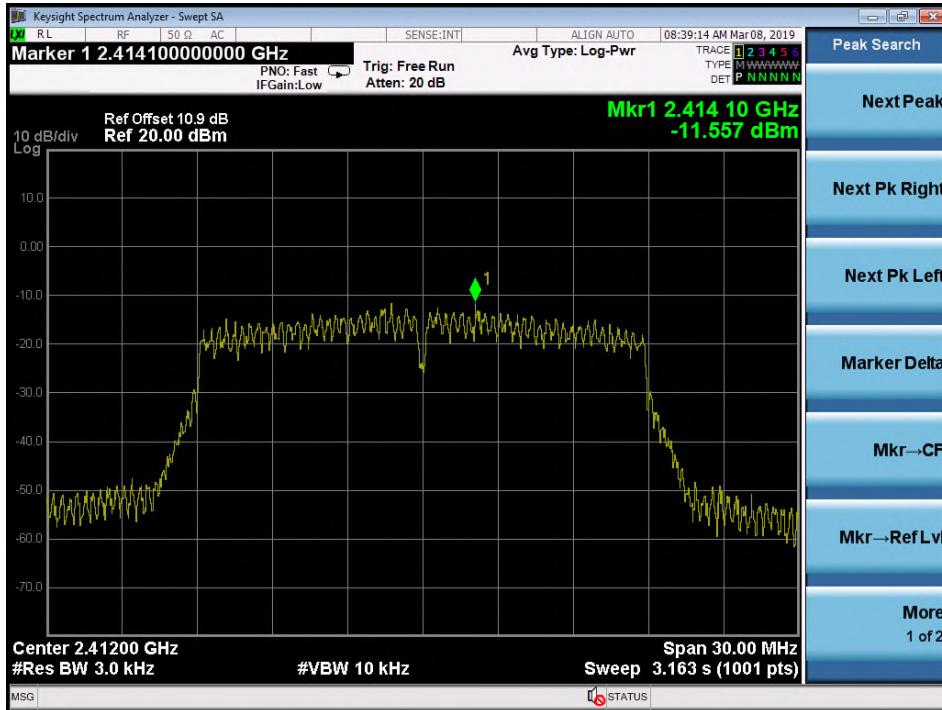
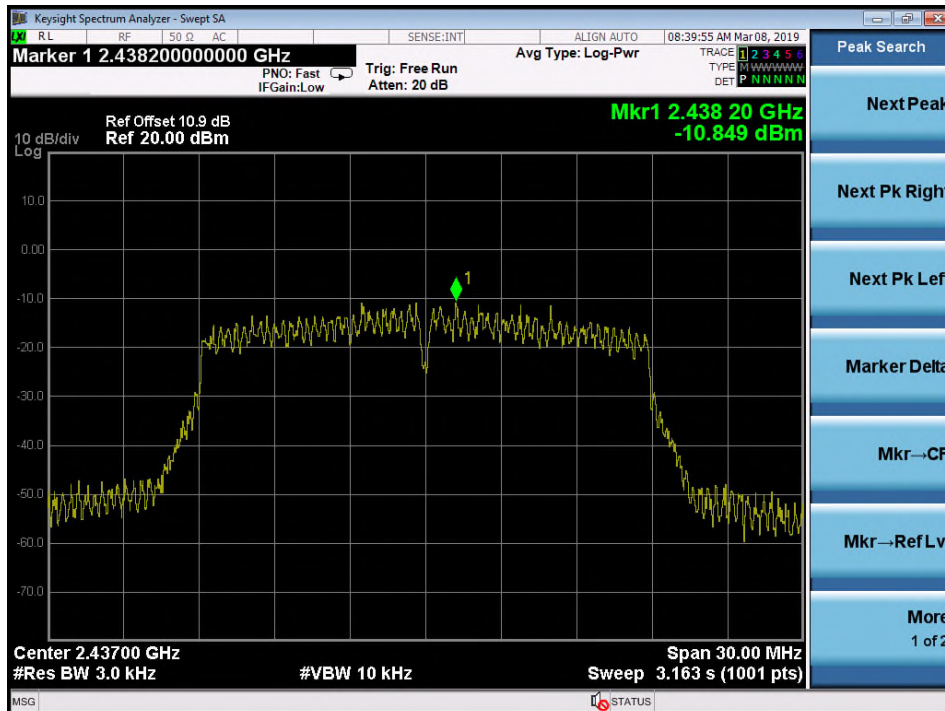
Middle Channel

High Channel

802.11n HT20 Antenna 2
Low Channel

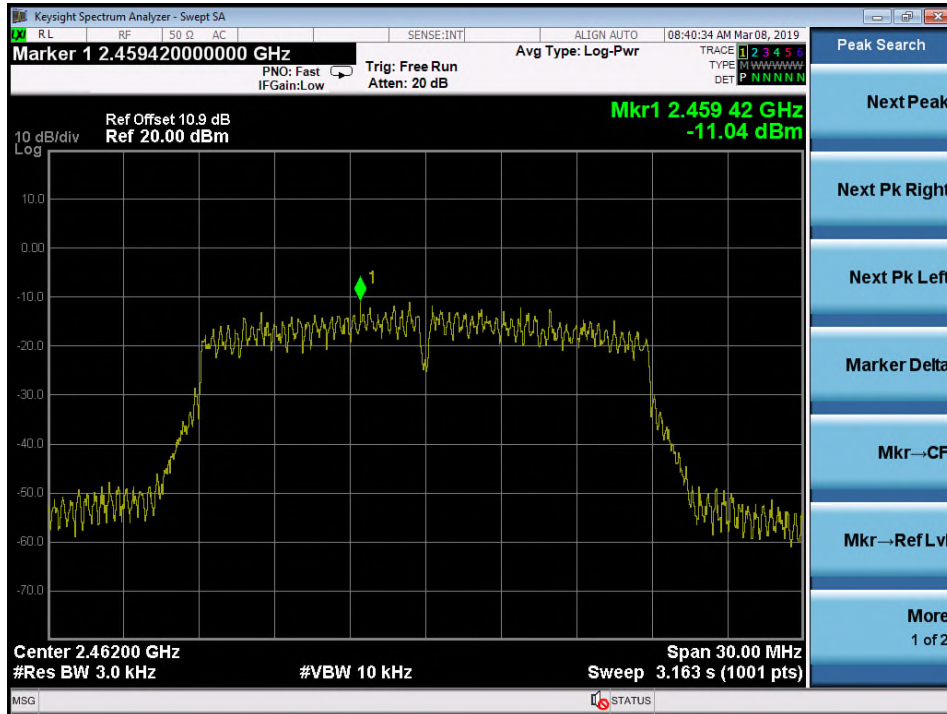
Middle Channel

High Channel



5.1.6 Conducted spurious emissions and Frequency Band Edge measured in 100kHz Bandwidth

RESULT:**Passed**

Test standard	:	FCC part 15.247(d), RSS-247 5.5
Basic standard	:	ANSI C63.10:2013, KDB558074
Limit	:	20dB (below that in the 100kHz bandwidth within the band that contains the highest level of the desired power)
Kind of test site	:	Shielded room

Test setup

Test Channel	:	Low/ Middle/ High for Conducted Spurious Emissions Low/ High for Frequency Band Edge
Operation Mode	:	A
Ambient temperature	:	20-24°C
Relative humidity	:	50-65%

All emissions are more than 30dB below fundamental, details refer to following test plot, and compliance is achieved as well.

Due to the small size of the product and that there are no inductive components of significant size, 9kHz to 30MHz frequency range is not tested based on technical judgment.

Test Plot 100kHz RBW of Band Edge

802.11b
Low Channel

High Channel

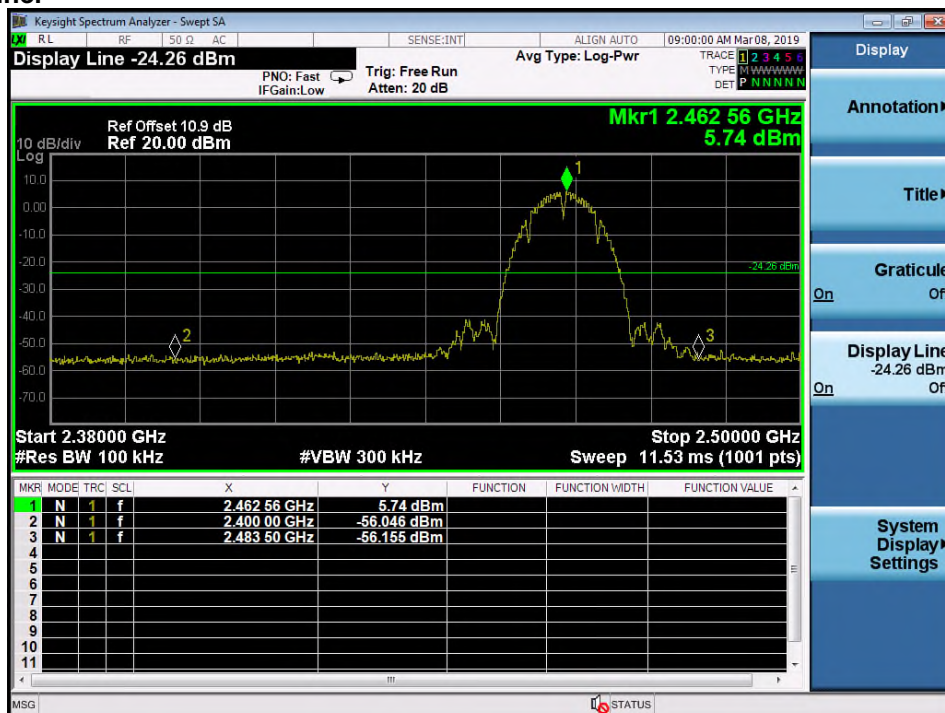

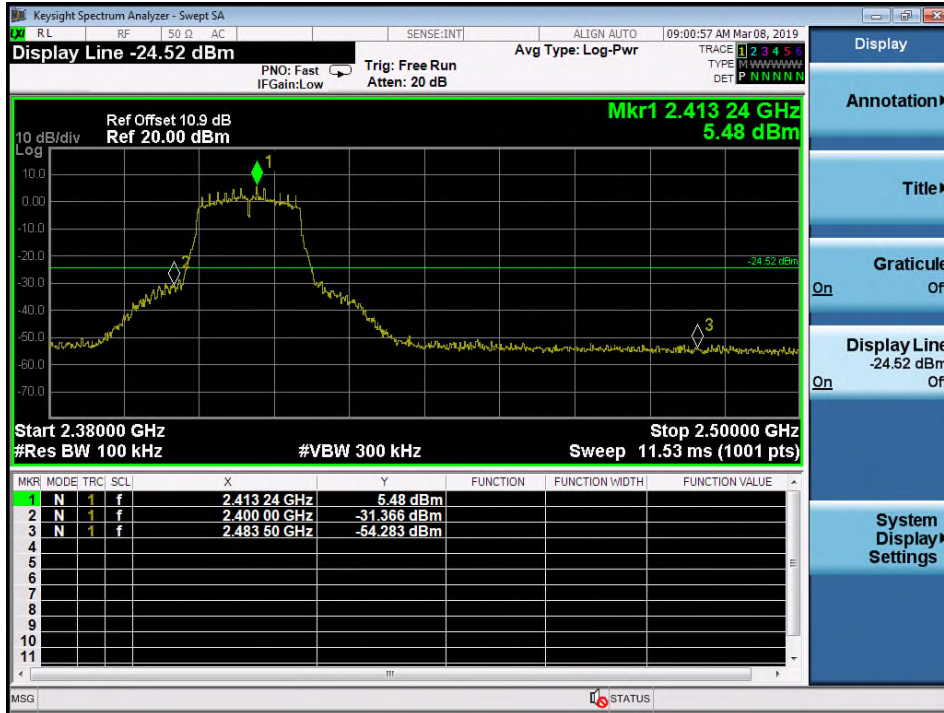
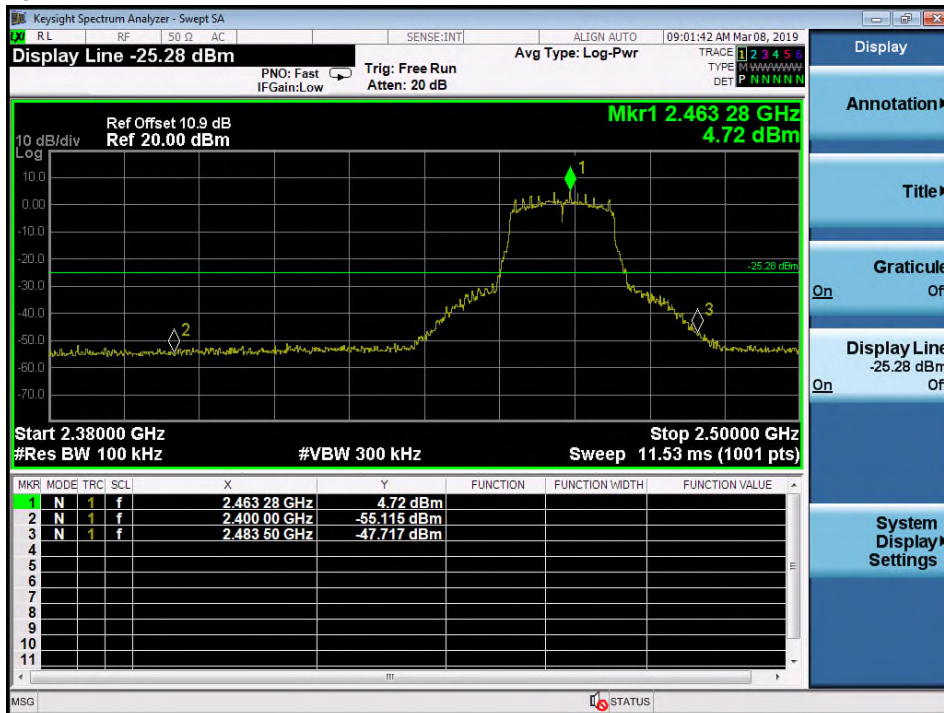
802.11g
Low Channel

High Channel

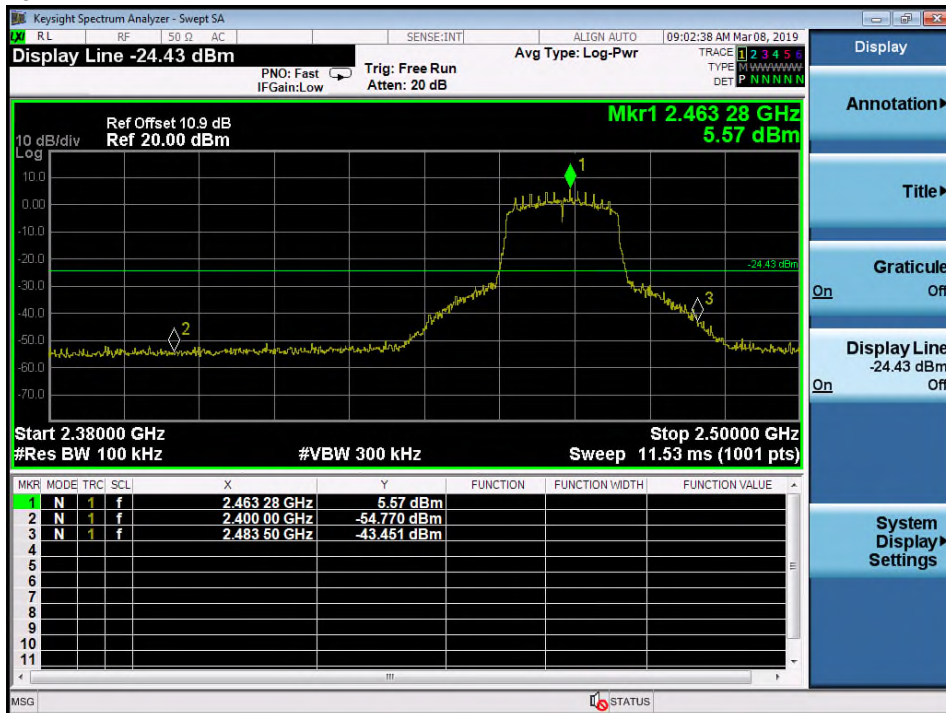
802.11n HT20
Low Channel

High Channel

5.1.7 Spurious Emission

RESULT:**Passed**

Test standard : FCC part 15.247(d), FCC 15.205, FCC 15.209, RSS-Gen 8.9 and RSS-Gen 8.10

Basic standard : ANSI C63.10: 2013
Limits : Radiated emissions which fall in the restricted bands, as defined in FCC 15.205(a) and RSS-Gen i5, 8.10 (Table 7), must comply with the radiated emission limits specified in FCC 15.209(a) and RSS-Gen 5, 8.9 (Table 5 and 6).

Emission radiated outside the restricted and authorized frequency bands must either comply with the radiated emission limits specified for the restricted bands or in FCC15.247(d) and RSS-247 i2, 5.5

Kind of test site : 3m Semi-Anechoic Chamber

Test setup

Test Channel : Low/ Middle/ High
Operation mode : A,B

Factor (dB/m)=Antenna Factor(dB/m)+Cable loss (dB)

Level(dBuV/m)=Reading(dBuV)+ Factor(dB/m)

Testing was carried out within frequency range 9kHz to the tenth harmonic. For details refer to Appendix D. The Radiated Emissions testing was performed in the X, Y and Z axis orientation. The worst-case Axis orientation is recorded in this test report.

5.2 Mains Emissions

5.2.1 Mains Conducted Emissions

RESULT:**Passed**

Test standard : FCC Part 15.207
FCC Part 15.107
RSS-Gen 8.8

Limits : Mains Conducted emissions as defined in
above test standards must comply with the
mains conducted emission limits specified

Kind of test site : Shielded Room

Test setup

Test Channel : Middle
Operation mode : A

Ambient temperature : 20-24°C
Relative humidity : 50-65%
Atmospheric pressure : 100-103 kPa

Factor (dB/m)=Antenna Factor(dB/m)+Cable loss (dB)

Level(dBuV/m)=Reading(dBuV)+ Factor(dB/m)

Remark: For details refer to Appendix D.

6. Safety Human exposure

6.1 Radio Frequency Exposure Compliance

6.1.1 Electromagnetic Fields

RESULT:
Passed

Test standard : FCC CFR 47 Part 2 Subpart J Section 2.1091
 RSS-102 Issue 5, Table 4

Separation distance is more than 20 cm, thus mobile device exposure limits can be applied.

FCC Maximum Exposure:

Mode	Frequency (MHz)	Antenna Gain (dBi)	Antenna Gain (numeric)	Maximum Output Power (dBm)	Output Power (mW)	Power Density (S)(mW/cm ²)	Test Result
802.11b	2437	1.42	1.3868	17.96	62.45	0.017238	Pass

Limit FCC: 1500-100,000 MHz 1.0 mW/cm²

IC Maximum Exposure:

Mode	Frequency (MHz)	Antenna Gain (dBi)	Antenna Gain (numeric)	Maximum Output Power (dBm)	Output Power (mW)	Power Density (S)(mW/cm ²)	Test Result
802.11b	2412	1.42	1.3868	17.94	62.17	0.017160	Pass

Limit Canada: 0.537 mW/cm²

Table 4: RF Field Strength Limits for Devices Used by the General Public (Uncontrolled Environment)

Frequency Range (MHz)	Electric Field (V/m rms)	Magnetic Field (A/m rms)	Power Density (W/m ²)	Reference Period (minutes)
0.003-10 ²¹	83	90	-	Instantaneous*
0.1-10	-	0.73/ f	-	6**
1.1-10	87/ f ^{0.5}	-	-	6**
10-20	27.46	0.0728	2	6
20-48	58.07/ f ^{0.25}	0.1540/ f ^{0.25}	8.944/ f ^{0.5}	6
48-300	22.06	0.05852	1.291	6
300-6000	3.142 f ^{0.3417}	0.008335 f ^{0.3417}	0.02619f ^{0.6834}	6
6000-15000	61.4	0.163	10	6
15000-150000	61.4	0.163	10	616000/ f ^{1.2}
150000-300000	0.158 f ^{0.5}	4.21 x 10 ⁻⁴ f ^{0.5}	6.67 x 10 ⁻⁵ f	616000/ f ^{1.2}

Note: f is frequency in MHz.

*Based on nerve stimulation (NS).

** Based on specific absorption rate (SAR).

$$f = 2412, 0.02619f^{0.6834} = 0.537$$

7. Photographs of the Test Set-Up

Photograph 1: Set-up for Spurious Emissions (Front View)

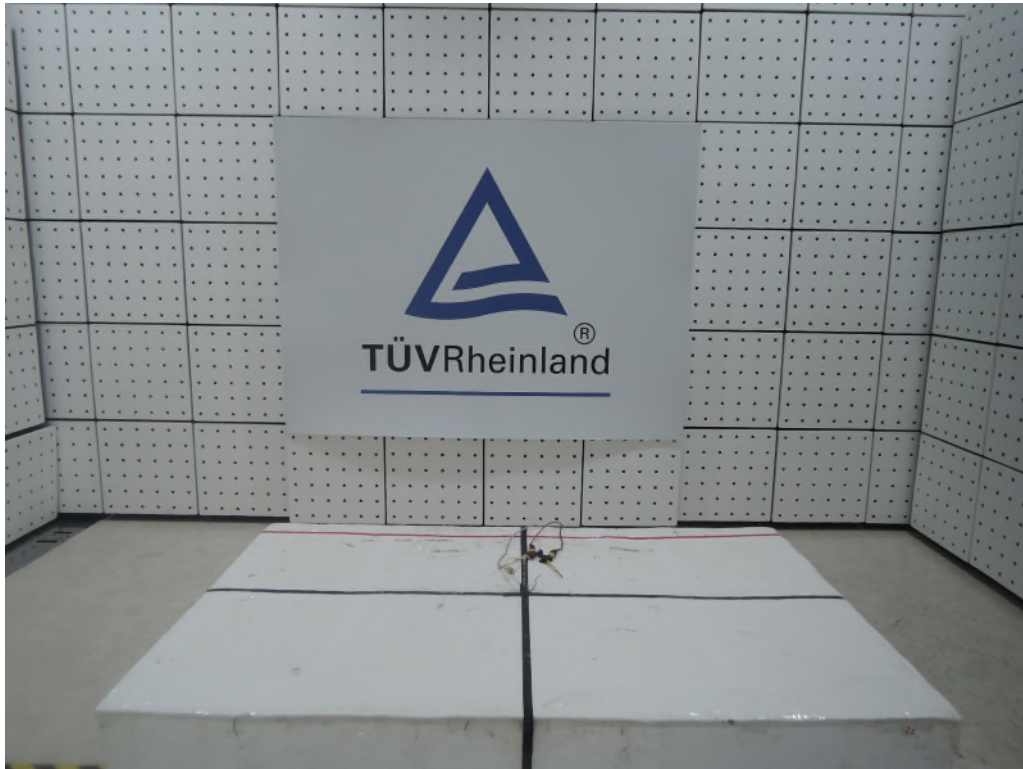

Photograph 2: Set-up for Spurious Emissions (Back View 1)

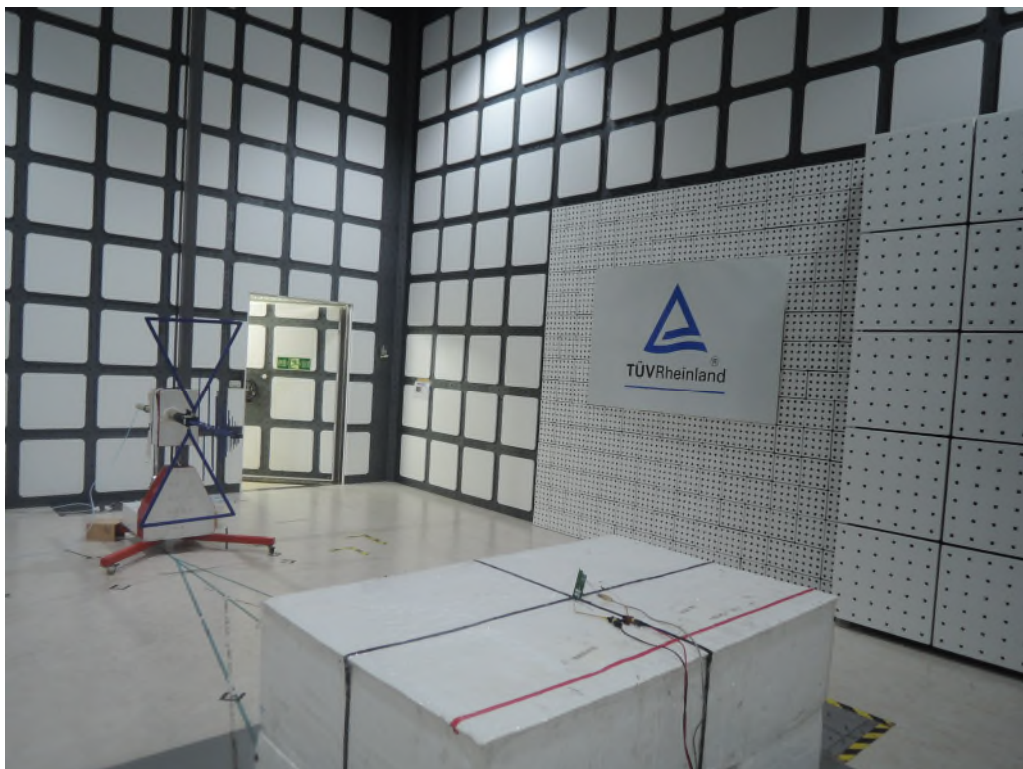

Photograph 3: Set-up for Spurious Emissions (Back View 2)

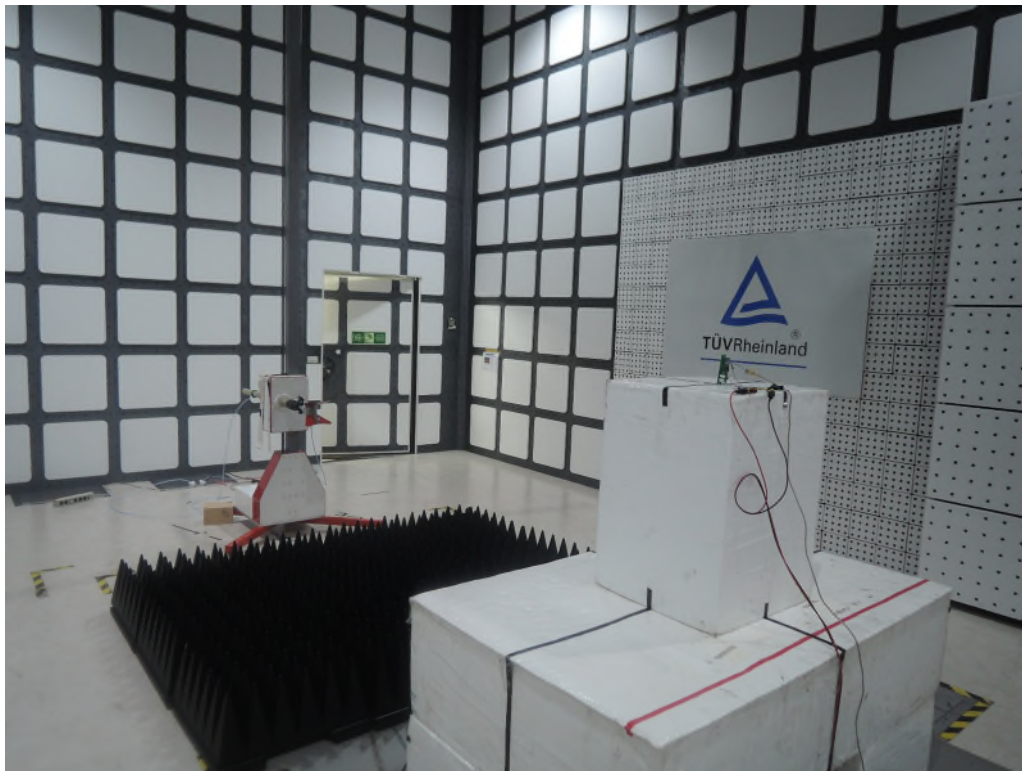

Photograph 4: Set-up for Conducted testing

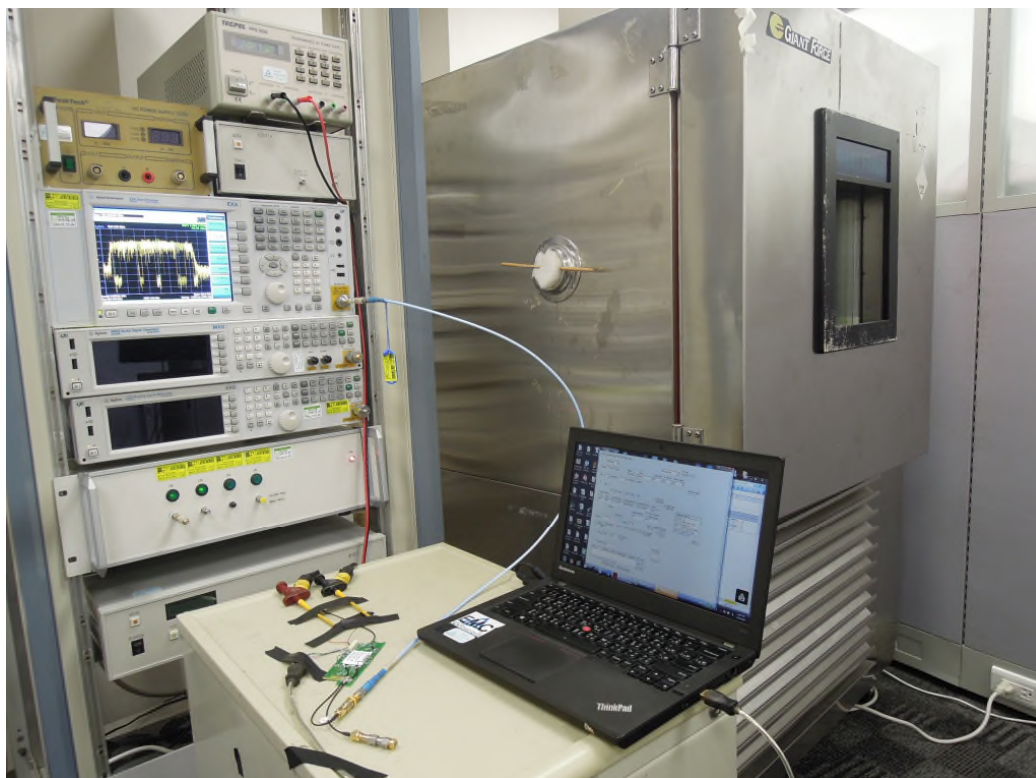

Photograph 5: Set-up for AC Mains (Front)



Photograph 6: Set-up for AC Mains (Back)

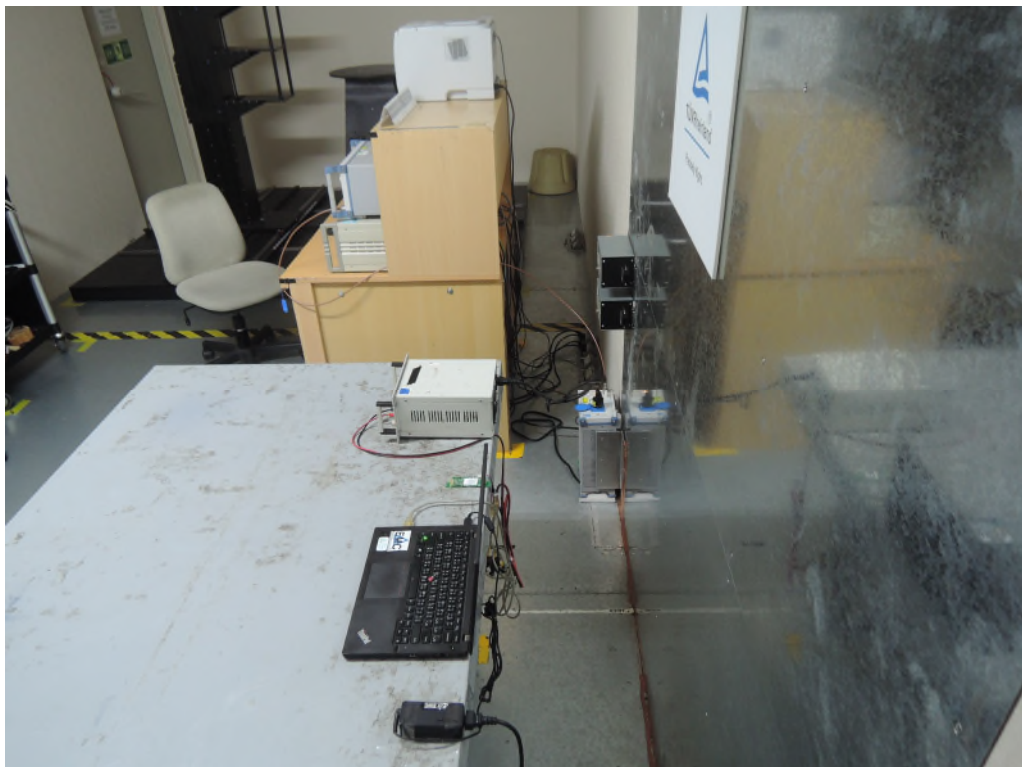

8. List of Tables

Table 1: Applied Standard and Test Levels	5
Table 2: List of Test and Measurement Equipment	7
Table 3: Emission Measurement Uncertainty.....	8
Table 4: Basic Information of EUT	9
Table 5: Technical Specification of EUT	9
Table 6: Table for Parameters of Test Software Setting	11
Table 7: Test result of Duty Cycle	16
Table 8: Test result of Average Output Power	20
Table 9: Test result of 6dB Bandwidth	21
Table 10: Test result of 99% Bandwidth.....	22
Table 11: Test result of Power Density	35

9. List of Photographs

Photograph 1: Set-up for Spurious Emissions (Front View).....	61
Photograph 2: Set-up for Spurious Emissions (Back View 1)	61
Photograph 3: Set-up for Spurious Emissions (Back View 2)	62
Photograph 4: Set-up for Conducted testing	62
Photograph 5: Set-up for AC Mains (Front).....	63
Photograph 6: Set-up for AC Mains (Back)	63