



BTUC49-SP

BTUC49-TX

BT4.2 Wireless Module

Product Specification 1.0

| Approved: | Approved: | Prepared by: |
|--------------------|------------------------|-------------------------|
| <hr/> | <hr/> | <hr/> |
| Zeke Wu Manager | Matt Lin Supervisor | Wayne Chang Engineer |

Revision History:

| Date | Number | Approver | Comments |
|-------------|--------|-------------|---------------|
| Nov 13 2018 | 1.0 | Wayne Chang | Initial Draft |
| | | | |
| | | | • |

RESTRICTED AND CONFIDENTIAL INFORMATION STATEMENT

All information contained in this document is the exclusive property of Foxconn Technology Inc. and its development partners. Any reproduction or disclosure of all or part of this document without the expressed written consent of Foxconn Technology Inc. is strictly prohibited.

CHAPTER 1. MODULE OVERVIEW

The Foxconn BTUC49-SP/ BTUC49-TX consumer audio platform for wired and wireless applications integrates an ultra-low-power DSP and application processor with embedded flash memory , a high-performance stereo codec, a power management subsystem, LED and LCD drivers in a SoC IC. The dual-core architecture with flash memory enables manufacturers to easily differentiate their products with new features without extending development cycles.The enhanced Kalimba DSP coprocessor with 80MIPS supports enhanced audio and DSP applications.

The BTUC49-SP/ BTUC49-TX Bluetooth module complies with Bluetooth specification ver 4.2(BT4.0 Compatible).

It supports HSP,HFP,A2DP,AVRCP, etc. Also integrates RF,baseband controller, etc. BTUC49-SP/ BTUC49-TX provides USB & SPI interface, programmable I/O, stereo speaker output(Analog-differential, Digital-PCM&I2S), microphone input, etc.

1-1 Key Characteristic

- Small size 22*8*2.5mm(Max,Including shielding case)
- BT Class 2(Max 4dBm)
- Bluetooth specification v4.2(BT4.0 Compatible)
- Dual-mode Bluetooth low energy radio
- Radio includes integrated balun
- 80MHz RISC MCU and 80MIPS Kalimba DSP
- 16Mb internal flash memory ;optional support for 64Mb of external SPI flash
- Stereo codec with 2 channels of ADC and up to 6 microphone inputs
- Support for CSR's latest CVC technology voice connections including wind noise reduction
- Audio interface : I2S, PCM and SPDIF
- Serial interface : USB2.0 (full-speed),SPI & I2C
- Integrated dual switch-mode regulators, linear regulators and battery charger

1-2 Hardware Characteristic

| | |
|----------------|------------------------|
| Form factor | 22 mm x 8 mm LGA Stamp |
| Host Interface | SPI & USB |
| PCB | 6-layers HDI design |

CHAPTER 2. ELECTRICAL AND RF SPECIFICATION

2-1 Recommended Operation Rating

| Parameter | Condition | Min | Typ. | Max. | Unit |
|--------------|-----------|------|------|------|------|
| VCHG | 5 | 4.75 | 5 | 5.75 | V |
| SMPS_3V3 | 3.3 | 3.10 | 3.3 | 3.60 | V |
| VDD_USB | 3.3 | 3.10 | 3.3 | 3.60 | V |
| RF Interface | Zo | | 50 | | Ohm |

2-2 Power Consumption

Table Power Consumption

| Description | Typical | Unit |
|-------------|---------|------|
| IDLE | 3.6 | mA |
| 2G/1T- 1DH5 | 13.8 | mA |
| 2G/1T- 2DH5 | 13.6 | mA |
| 2G/1T- 3DH5 | 13.5 | mA |
| 2G/1T- 1LE | 22 | mA |
| 2G/1R- 1DH5 | 22.2 | mA |
| 2G/1R- 2DH5 | 22.3 | mA |
| 2G/1R- 3DH5 | 22.2 | mA |
| 2G/1R- 1LE | 25 | mA |

2-3 Electrical Specifications

| Model Number | BTUC49-SP,BTUC-TX |
|--|---|
| Product Type | Bluetooth Module |
| Main Chip(s) | Qualcomm CSR8670 |
| Package | 66-pin LGA Stamp Pins |
| Bluetooth Standard(s) | BT 4.2 (BT4.0 Compatible) |
| Bluetooth Operating Frequency | 2402-2480MHz |
| BT Interface(s) | SPI 、 USB |
| Bluetooth Data Rates | Up to 3Mbps |
| Bluetooth Tx Power BR,EDR (Typical) | 0dBm (Class 2) |
| Bluetooth GFSK Rx Sensitivity (Typical) | -82dBm at 2402MHz -84dBm at 2441MHz -84dBm at 2480MHz |
| Bluetooth DQPSK Rx Sensitivity (Typical) | -83dBm at 2402MHz -85dBm at 2441MHz -85dBm at 2480MHz |
| Bluetooth 8DPSK Rx Sensitivity (Typical) | -77dBm at 2402MHz -79dBm at 2441MHz -79dBm at 2480MHz |
| Bluetooth Low Energy Tx Power (Max) | 6dBm(Max) |
| Bluetooth Low Energy Rx Sensitivity (Typical) | -85dBm at 2402MHz -87dBm at 2440MHz -87dBm at 2480MHz |
| Power Requirements | 3.6mA@5V_VCHG (IDLE) |

2-4 Bluetooth RF Specification

| Parameter | Condition | Min. | Typ. | Max. | Unit |
|--|---------------------------|---|------|------|------|
| Basic Data Rate – Transmit Performance | | | | | |
| RF Transmit Power (TRM01) | | -6 | 0 | 4 | dBm |
| Power Density (TRM02) | Per 100kHz | ≤20 | | | dBm |
| Power Control (TRM03) | | 2 ≤ step size ≤ 8 | | | dB |
| TX Output Spectrum – Freq. Range (TRM04) | F(low)- CH0 | > 2400 | | | MHz |
| | F(high)-CH78 | < 2483.5 | | | |
| TX Output Spectrum – 20dB BW (TRM05) | | f _H -f _L < 1000 | | | MHz |
| TX Output Spectrum – Adjacent Channel Power (TRM06) | f-f ₀ = 2MHz | ≤ -20 | | | dBm |
| | f-f ₀ ≥ 3MHz | ≤ -40 | | | |
| TX Output Spectrum – Out of Band Spurious Emission | 30MHz – 1GHz | ≤ -36 | | | dBm |
| | 1GHz -12.75GHz | ≤ -30 | | | |
| | 5.15GHz -5.35GHz | ≤ -47 | | | |
| | 5.725GHz-5.825GHz | ≤ -47 | | | |
| Modulation Characteristic (TRM07) | Delta f1 avg | 140 ≤ Δf _{1-avg} ≤ 175 | | | kHz |
| | Delta f2 max | ≥ 115 at 99.9% | | | |
| | Delta f2 avg/Delta f1 avg | ≥ 0.8 | | | |
| Initial Carrier Frequency Tolerance (TRM08) | | ≤ ± 75 | | | kHz |
| Carrier Frequency Drift (TRM09) | DH1 | ≤ ± 25 | | | kHz |
| | DH3 | ≤ ± 40 | | | |
| | DH5 | ≤ ± 40 | | | |
| Maximum Drift Rate (TRM09) | | 20 kHz/50 us | | | |
| Enhanced Data Rate – Transmit Performance | | | | | |
| RF Transmit Power | π/4 DQPSK | -7 | -4 | -1 | dBm |
| | 8DPSK | -7 | -4 | -1 | |
| Relative Transmit Power (TRM10) | All pairs | (P _{GFSK} -4 dB) < P _{DPSK} < (P _{GFSK} +1 dB) | | | |
| Carrier Frequency Stability (TRM11) | All packets | -75 ≤ w _i ≤ 75 | | | kHz |
| | All blocks | -75 ≤ (w ₀ +w _i) ≤ 75 | | | |
| | All blocks | -10 ≤ w ₀ ≤ 10 | | | |
| Modulation Accuracy – RMS DEVM (TRM11) | π/4 DQPSK | ≤ 20 | | | % |
| | 8DPSK | ≤ 13 | | | |
| Modulation Accuracy – Peak DEVM (TRM11) | π/4 DQPSK | ≤ 35 | | | |
| | 8DPSK | ≤ 25 | | | |
| Modulation Accuracy – 99% DEVM (TRM11) | π/4 DQPSK | ≤ 30 | | | |
| | 8DPSK | ≤ 20 | | | |
| EDR Differential Phase Emissions (TRM12) | | ≥ 99 | | | % |
| In-band Spurious Emission (TRM13) | f-f ₀ = 1MHz | ≤ -26 | | | dB |
| | f-f ₀ = 2MHz | ≤ -20 | | | dBm |
| | f-f ₀ ≥ 3MHz | ≤ -40 | | | |
| TX Output Spectrum – Out of Band Spurious Emission | 30MHz – 1GHz | ≤ -36 | | | dBm |
| | 1GHz -12.75GHz | ≤ -30 | | | |
| | 5.15GHz -5.35GHz | ≤ -47 | | | |

| | | | | |
|---|--|----------------------------------|------------|------------|
| | 5.725GHz-5.825GHz | ≤ -47 | | |
| Enhanced power control (TRM14) | Step Size | $2 \leq \text{Step Size} \leq 8$ | dB | |
| | Difference. Btw. GFSK, $\pi/4$ DQPSK,&8DPSK | ≤ 10 | | |
| Basic Data Rate – Receiver Performance | | | | |
| Sensitivity at 0.1% BER (RCV01-02) | | ≤ -70 | dBm | |
| C/I Co-Channel interference (RCV03) | | ≤ 11 | dB | |
| C/I Adjacent CH interference (RCV03) | $ f-f_0 = 1\text{MHz}$ | ≤ 0 | | |
| | $ f-f_0 = 2\text{MHz}$ | ≤ -30 | | |
| | $ f-f_0 \geq 3\text{MHz}$ | ≤ -40 | | |
| C/I Image CH interference (RCV03) | C/I_{image} | ≤ -9 | | |
| | $C/I_{\text{image}\pm 1\text{MHz}}$ | ≤ -20 | | |
| Out of band Blocking (RCV04) | 30MHz – 2000 MHz | -10 | dBm | |
| | 2003MHz – 2399MHz | -27 | | |
| | 2484MHz – 2997MHz | -27 | | |
| | 3000MHz – 12750MHz | -10 | | |
| Intermodulation Performance at $\leq 0.1\%$ BER (RCV05) | | -64 | dBm | |
| Maximum input power level | | ≥ -20 | dBm | |
| Spurious Emission | | 30MHz – 12.75GHz | ≤ -57 | dBm |
| Enhanced Data Rate – Receiver Performance | | | | |
| Sensitivity at 0.007% BER (RCV07) | $\pi/4$ DQPSK | ≤ -70 | dBm | |
| | 8DPSK | ≤ -70 | | |
| EDR BER Floor Performance at $\leq 0.0007\%$ BER (RCV08) | | ≤ -60 | dBm | |
| C/I Co-Channel interference (RCV09) | $\pi/4$ DQPSK | $\leq +13$ | dB | |
| | 8DPSK | $\leq +21$ | | |
| C/I Adjacent Channel C/I $ f-f_0 = 1\text{MHz}$ (RCV09) | $\pi/4$ DQPSK | ≤ 0 | | |
| | 8DPSK | $\leq +5$ | | |
| C/I Adjacent Channel C/I $ f-f_0 = 2\text{MHz}$ (RCV09) | $\pi/4$ DQPSK | ≤ -30 | | |
| | 8DPSK | ≤ -25 | | |
| C/I Adjacent Channel C/I $ f-f_0 \geq 3\text{MHz}$ (RCV09) | $\pi/4$ DQPSK | ≤ -40 | | |
| | 8DPSK | ≤ -33 | | |
| C/I Image Channel C/I_{image} (RCV09) | $\pi/4$ DQPSK | ≤ -7 | | |
| | 8DPSK | ≤ 0 | | |
| C/I Image Channel $C/I_{\text{image}\pm 1\text{MHz}}$ (RCV09) | $\pi/4$ DQPSK | ≤ -20 | | |
| | 8DPSK | ≤ -13 | | |
| Maximum input power level (RCV10) | | ≥ -20 | | dBm |
| Spurious Emission | | 30MHz – 12.75GHz | | ≤ -57 |

2-5 Bluetooth Low Energy RF Specification

| Parameter | Condition | Min. | Typ. | Max. | Unit |
|---|---------------------------|--------------------------------|------|------|------|
| Transmit Performance | | | | | |
| RF Transmit Power (TRM-LE01,02) | | 0 | 3 | 6 | dBm |
| In-Band Emission (TRM-LE03,04) | f-f ₀ = 2MHz | ≤ -20 | | | dBm |
| | f-f ₀ ≥ 3MHz | ≤ -30 | | | |
| TX Output Spectrum – Out of Band Spurious Emission | 30MHz – 1GHz | ≤ -36 | | | dBm |
| | 1GHz -12.75GHz | ≤ -30 | | | |
| | 5.15GHz -5.35GHz | ≤ -47 | | | |
| | 5.725GHz-5.825GHz | ≤ -47 | | | |
| Modulation Characteristic (TRM-LE05) | Delta f1 avg | 225 ≤ Δf _{1avg} ≤ 275 | | | kHz |
| | Delta f2 max | ≥ 185 at 99.9% | | | |
| | Delta f2 avg/Delta f1 avg | ≥ 0.8 | | | |
| Carrier Frequency Drift (TRM-LE06,07) | Center frequency | ≤ ± 150 | | | kHz |
| | During any packet | ≤ ± 50 | | | |
| Maximum Drift Rate (TRM-LE06,07) | | 20 Hz/50 us | | | |
| Receiver Performance | | | | | |
| Sensitivity at 30.8% PER (RCV-LE01,02) | | ≤ -70 | | | dBm |
| C/I Co-Channel interference (RCV-LE03) | Co-channel | ≤ 21 | | | dB |
| C/I Adjacent CH interference (RCV-LE03) | f-f ₀ = 1MHz | ≤ 15 | | | |
| | f-f ₀ = 2MHz | ≤ -17 | | | |
| | f-f ₀ ≥ 3MHz | ≤ -27 | | | |
| C/I Image CH interference (RCV-LE03) | C/I _{image} | ≤ -9 | | | |
| | C/I _{image±1MHz} | ≤ -15 | | | |
| Out of band Blocking (RCV-LE04) | 30MHz – 2000 MHz | -30 | | | dBm |
| | 2003MHz – 2399MHz | -35 | | | |
| | 2484MHz – 2997MHz | -35 | | | |
| | 3000MHz – 12750MHz | -30 | | | |
| Intermodulation Performance at ≤30.8% (≤ 0.1% BER) (RCV-LE05) | | -64 | | | dBm |
| Maximum input power level (RCV-LE06) | | ≥ -10 | | | dBm |
| PER Report Integrity 50% ≤ PER ≤ 65.4% (RCV-LE07) | | -30 | | | dBm |
| Spurious Emission | 30MHz – 12.75GHz | ≤ -57 | | | dBm |

CHAPTER 3. MECHANICAL SPECIFICATION

3-1 Module Assembly Dimension:

Dimension (W x L x H): 22.0 x 8.0 x 2.5 (Max) unit:mm

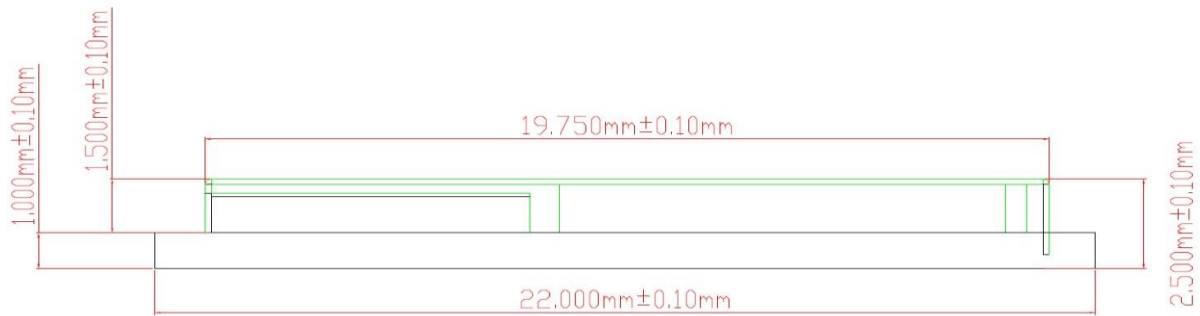

Side View with shielding case

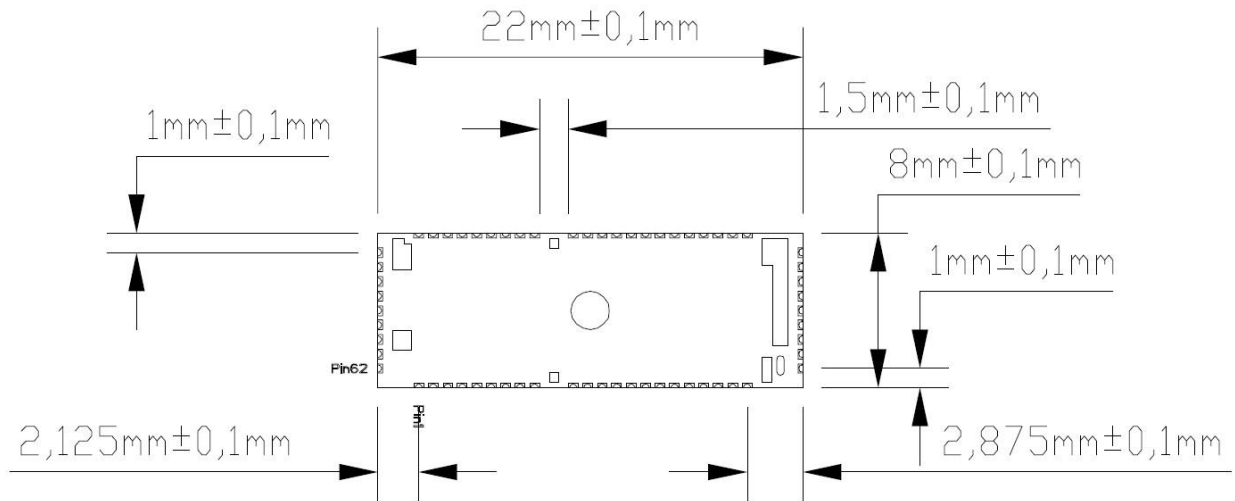

Top View

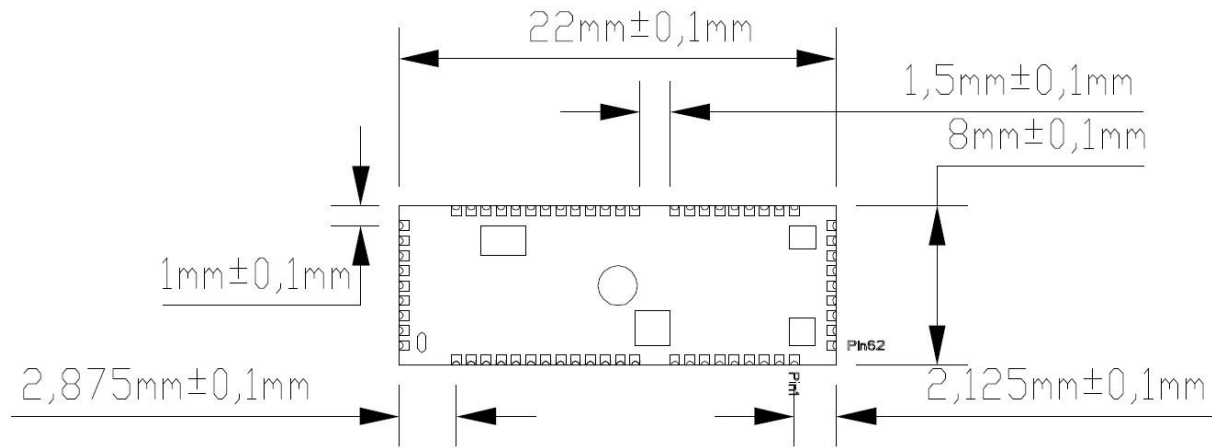

Bottom View

3-3 Labels Specification

BTUC49-SP

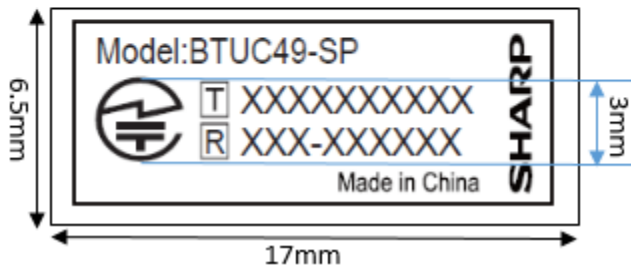
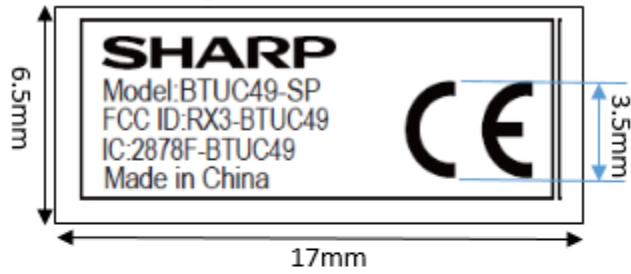

BTUC49-TX

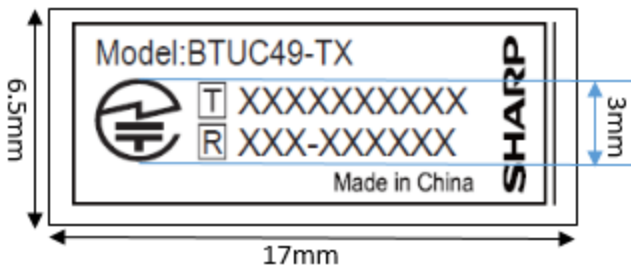
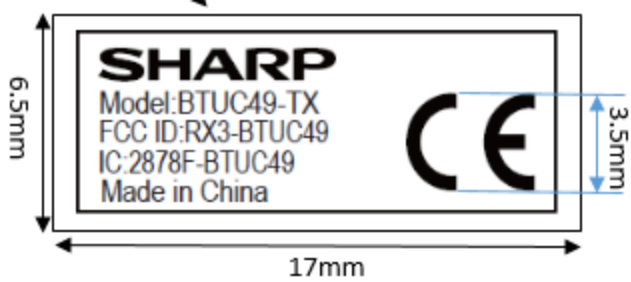

CHAPTER 4. ADDITIONAL INFORMATION

4-1 Module Photo

Top Side Photo

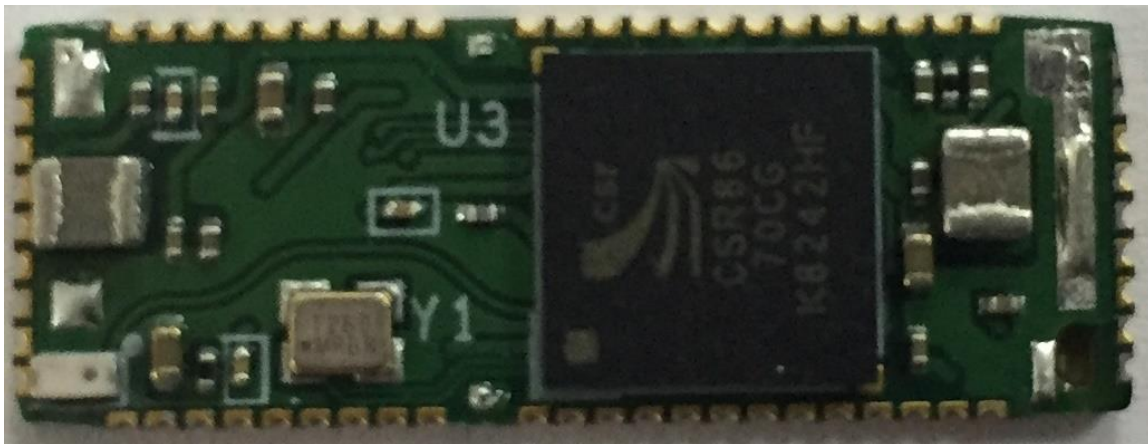

Bottom Side Photo

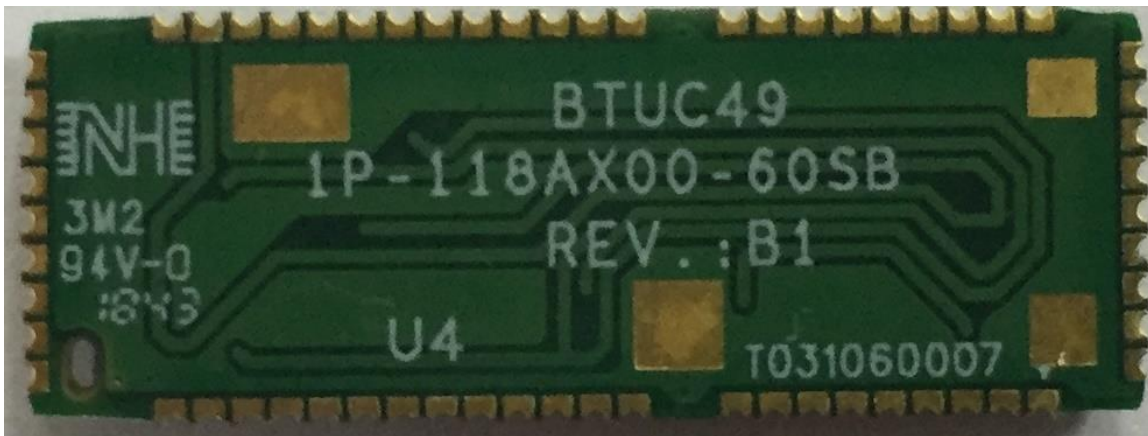

4-2 Environment Specifications

Operating Conditions

Operation Temperature : $-20^{\circ}\text{C} \sim 65^{\circ}\text{C}$

Relevant Humidity: 10 ~ 90% (non-condensing)

Storage Conditions

Non-Operation Temperature : $-20 \sim 85^{\circ}\text{C}$ (Typ. 25°C)

Relevant Humidity: 10 ~ 90% (non-condensing)

Federal Communication Commission Interference Statement

This device complies with Part 15 of the FCC Rules. Operation is subject to the following two conditions: (1) This device may not cause harmful interference, and (2) this device must accept any interference received, including interference that may cause undesired operation.

This equipment has been tested and found to comply with the limits for a Class B digital device, pursuant to Part 15 of the FCC Rules. These limits are designed to provide reasonable protection against harmful interference in a residential installation. This equipment generates, uses and can radiate radio frequency energy and, if not installed and used in accordance with the instructions, may cause harmful interference to radio communications. However, there is no guarantee that interference will not occur in a particular installation. If this equipment does cause harmful interference to radio or television reception, which can be determined by turning the equipment off and on, the user is encouraged to try to correct the interference by one of the following measures:

- Reorient or relocate the receiving antenna.
- Increase the separation between the equipment and receiver.
- Connect the equipment into an outlet on a circuit different from that to which the receiver is connected.
- Consult the dealer or an experienced radio/TV technician for help. FCC Caution: Any changes or modifications not expressly approved by the party responsible for compliance could void the user's authority to operate this equipment. This transmitter must not be co-located or operating in conjunction with any other antenna or transmitter.

Radiation Exposure Statement:

This equipment complies with FCC radiation exposure limits set forth for an uncontrolled environment. This equipment should be installed and operated with minimum distance 20cm between the radiator & your body.

This device is intended only for OEM integrators under the following conditions:

- 1) The antenna must be installed such that 20 cm is maintained between the antenna and users,
- and 2) The transmitter module may not be co-located with any other transmitter or antenna.

As long as 2 conditions above are met, further transmitter test will not be required. However, the OEM integrator is still responsible for testing their end-product for any additional compliance requirements required with this module installed

IMPORTANT NOTE: In the event that these conditions can not be met (for example certain laptop configurations or co-location with another transmitter), then the FCC authorization is no longer considered valid and the FCC ID can not be used on the final product. In these circumstances, the OEM integrator will be responsible for reevaluating the end product (including the transmitter) and obtaining a separate FCC authorization.

End Product Labeling

This transmitter module is authorized only for use in device where the antenna may be installed such that 20 cm may be maintained between the antenna and users. The final end product must be labeled in a visible area with the following: "Contains FCC ID: RX3-BTUC49". The grantee's FCC ID can be used only when all FCC compliance requirements are met.

Manual Information To the End User

The OEM integrator has to be aware not to provide information to the end user regarding how to install or remove this RF module in the user's manual of the end product which integrates this module. The end user manual shall include all required regulatory information/warning as show in this manual.

Canada, Industry Canada (IC) Statement

This Class B digital apparatus complies with Canadian ICES-003.

This device complies with Industry Canada licence-exempt RSS standard(s). Operation is subject to the following two conditions:

- (1) this device may not cause interference, and
- (2) this device must accept any interference, including interference that may cause undesired operation of the device.

RF Radiation Exposure Statement:

This equipment complies with IC radiation exposure limits set forth for an uncontrolled environment. This equipment should be installed and operated with a minimum distance of 20 centimeters between the radiator and your body.

Required end product labeling:

Any device incorporating this module must include an external, visible, permanent marking or label which states: "Contains IC: 2878F-BTUC49"

This radio transmitter (identify the device by certification number or model number if Category II) has been approved by Industry Canada to operate with the antenna types listed below with the maximum permissible gain indicated. Antenna types not included in this list, having a gain greater than the maximum gain indicated for that type, are strictly prohibited for use with this device.

Antenna Type: PIFA Peak Gain: 2,49 dBi

Canada, Industrie Canada (IC) Déclaration

Cet appareil numérique de classe B est conforme à la norme NMB-003.

Le présent appareil est conforme aux CNR d'Industrie Canada applicables aux appareils radio exempts de licence. L'exploitation est autorisée aux deux conditions suivantes:

- (1) l'appareil ne doit pas produire de brouillage, et
- (2) l'utilisateur de l'appareil doit accepter tout brouillage radioélectrique subi, même si le brouillage est susceptible d'en compromettre le fonctionnement.

Déclaration d'exposition aux radiations:

Cet appareil est conforme aux limites d'exposition aux rayonnements définies pour un environnement non contrôlé. Cet équipement doit être installé et utilisé à une distance minimale de 20 centimètres entre le radiateur et votre corps.

Obligation d'étiquetage du produit final:

Tout dispositif intégrant ce module doit comporter un externe, visible, marquage permanent ou une étiquette qui dit: "Contient IC : 2878F-BTUC49".

Cet émetteur radio (identifier le dispositif par numéro de certification ou le numéro de modèle , si la catégorie II) a été approuvé par Industrie Canada pour fonctionner avec les types d'antenne énumérés ci-dessous avec le gain maximal admissible indiqué . types d'antennes non inclus dans cette liste , ayant un gain supérieur au gain maximum indiqué pour ce type , sont strictement interdits pour une utilisation avec cet appareil.

Type d'antenne: PIFA Pic Gain: 2,49 dBi

National Communications Commission

根據 NCC 低功率電波輻射性電機管理辦法規定：

第十二條 經型式認證合格之低功率射頻電機，非經許可，公司、商號或使用者均不得擅自變更頻率、加大功率或變更原設計之特性及功能。

第十四條 低功率射頻電機之使用不得影響飛航安全及干擾合法通信；經發現有干擾現象時，應立即停用，並改善至無干擾時方得繼續使用。前項合法通信，指依電信法規定作業之無線電通信。低功率射頻電機須忍受合法通信或工業、科學及醫療用電波輻射性電機設備之干擾。

End Product Labeling

此模組於取得認證後將依規定於模組本體標示審驗合格標籤，並要求平台廠商於平台上標示「本產品內含射頻模組：」字樣。