

SYMBOLS

Some components of the car have coloured labels whose symbols indicate precautions to be observed when using this component. Under the bonnet there is also a label that summarises all the symbols.

**GETTING
TO KNOW
YOUR CAR**

SAFETY

STARTING
AND DRIVING

IN AN
EMERGENCY

SERVICING AND
MAINTENANCE

TECHNICAL
SPECIFICATIONS

CONTENTS

ALFA ROMEO CODE SYSTEM

This is an electronic engine locking system which increases protection against attempted thefts of the car. It is automatically activated when the ignition key is extracted.

Each key contains an electronic device which modulates the signal emitted during ignition by an antenna built into the ignition device. This signal is the 'password' which changes at each ignition and which the control unit uses to recognise the key and enable ignition.

OPERATION

The Alfa Romeo CODE system control unit sends an acknowledgement code to the engine management control unit to deactivate the inhibitor each time the car is started by turning the ignition key to MAR.

The code is sent only if the Alfa Romeo CODE system control unit has recognised the code transmitted from the key.

Each time the ignition key is turned to STOP, the Alfa Romeo CODE system deactivates the functions of the engine management control unit. Warning light  lights up on the instrument panel if the code is not correctly recognised during ignition.

In this case, turn the key to STOP and then to MAR; if it is still locked, try again with the other keys that come with the car. If you are still unable to start the engine contact Alfa Romeo Authorized Services.

Warning light comes on when driving

- If the warning light  turns on, this means that the system is running a self-test (due for example to a voltage drop).
- Contact Alfa Romeo Authorized Services if the  warning light stays on.



The Electronic components inside the key may be damaged if the key is subjected to shocks.

KEYS

CODE CARD (for versions/markets, where provided)

A CODE card fig. 14 is provided together with the keys. On the card you will find a mechanical code A and an electronic code B. Keep the codes in a safe place, not in the car.

GETTING TO KNOW YOUR CAR
SAFETY
STARTING AND DRIVING
IN AN EMERGENCY
SERVICING AND MAINTENANCE
TECHNICAL SPECIFICATIONS
CONTENTS

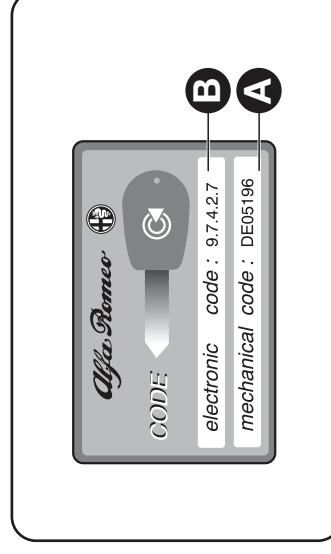

fig. 14

ALFK0006m

MECHANICAL KEY

The metal insert A-fig. 15 operates:

- the ignition switch;
- the door lock.

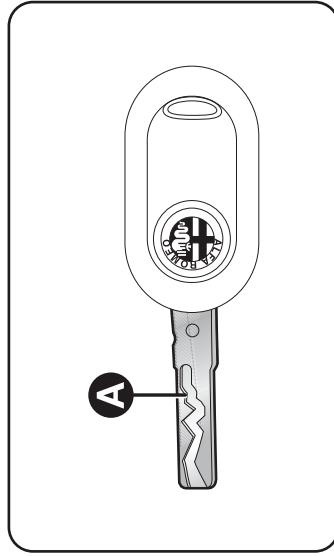

fig. 15

A0K0047m

KEY WITH REMOTE CONTROL

(for versions/markets, where provided)

The metal insert A-fig. 16 operates:

- the ignition switch;
- the door lock.

Press B button to open/close the metal insert.



Press B button fig. 16 only with the key away from your body, especially your eyes and from objects which could get damaged (e.g. your clothes). Do not leave the key unattended to avoid the button being accidentally pressed while it is being handled, e.g. by a child.

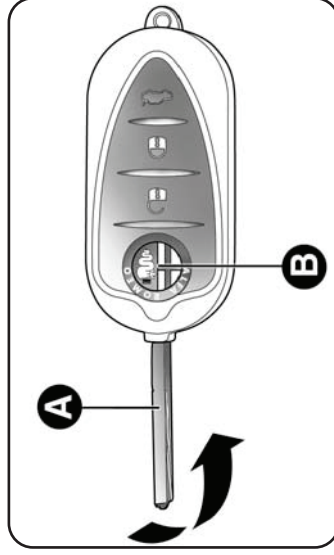

fig. 16

A0K0046m

Unlocking the doors and the boot

Briefly press **A** button: unlock of doors and boot, timed operation of ceiling lights, double flash of the direction indicators (for versions/markets, where provided).

Door lock is automatically released if the fuel cut-off system trips. Once the doors are locked, if one or more doors or the boot are not closed correctly, the LED and direction indicators start flashing quickly.

Locking the doors and the boot

Briefly press **A** button: lock of doors and boot with ceiling lights off and single flash of direction indicators (for versions/markets, where provided).

If one or more door are open, the doors will not be locked. This is indicated by a rapid flashing of the direction indicators (for versions/markets, where provided). The doors will be locked even if the boot is open.

When a speed of over 20 km/h is reached, the doors are automatically locked if this specific function has been set (only on versions with multi-function reconfigurable display).

When the doors are locked from outside the car (using the remote control), A LED fig. 17 will light up for a few seconds and then start flashing (deterrent function).

When the doors are locked from inside the car (by pressing **A**) the LED will remain on constantly.

Opening the boot

Press **A** button to open the boot using the remote control. The direction indicators will flash twice to indicate that the boot has been opened.

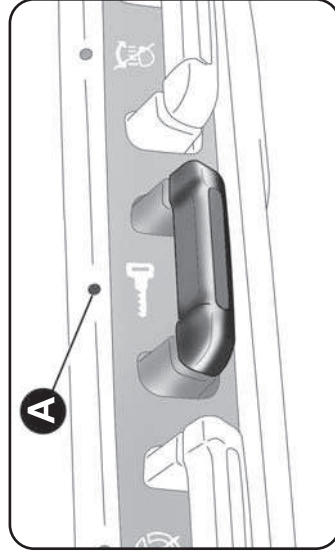

fig. 17

GETTING TO KNOW YOUR CAR
SAFETY
STARTING AND DRIVING
IN AN EMERGENCY
SERVICING AND MAINTENANCE
TECHNICAL SPECIFICATIONS
CONTENTS

REQUESTING ADDITIONAL REMOTE CONTROLS

The system can acknowledge up to 8 remote controls. If you need to request a new remote control, contact Alfa Romeo Authorized Services, taking the CODE card (for versions/markets, where provided), an identity document and documents proving your ownership of the car with you.

REPLACING THE BATTERY KEY WITH REMOTE CONTROL

Proceed as follows:

- press A button fig. 18 and open out the B metal insert; turn C screw to **↻** using a small point screwdriver;
- remove the D battery holder case and replace E battery respecting the polarity; reinsert D case into the key and secure it by turning C screw to **↻**.



Used batteries are harmful to the environment. They should be disposed of as specified by law in special containers or taken to an Alfa Romeo Authorised Service Provider, which will take care of their disposal.

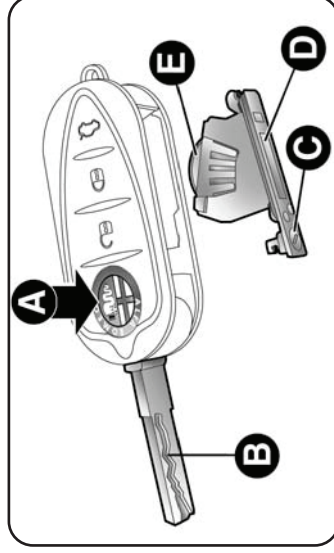

A0K0051.m

fig. 18

SAFE LOCK DEVICE

(for versions/markets where provided)

This safety device prevents operation of the inside door handles and of the door locking/unlocking button. We recommend that you activate this device whenever you park your car.

Switching the device on

The device is enabled on all the doors by quickly double-pressing the **A** button on the key.

The engagement of the device is indicated by three flashes of the direction indicators and the flashing of A LED fig. 19. The device will not switch on if one or more doors are not closed correctly.

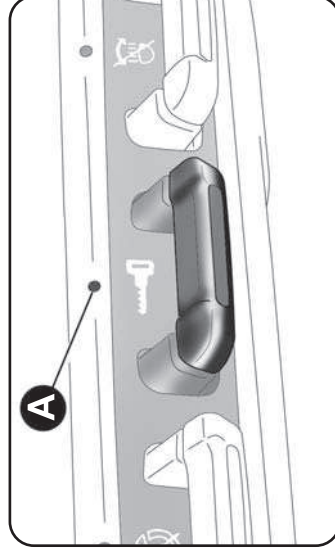

fig. 19

Switching the device off

The device disengages automatically by:







- opening the driver's door using the metal insert;
- pressing the **A** button on the remote control;
- turning the ignition key to the MAR position



Once the safe lock device is engaged it is impossible to open the doors from inside the car. Before engaging the device, check that there is no one left on board. If the remote control battery is flat, the device can only be disengaged by using the metal insert in either of the door locks.

GETTING TO KNOW YOUR CAR
SAFETY
STARTING AND DRIVING
IN AN EMERGENCY
SERVICING AND MAINTENANCE
TECHNICAL SPECIFICATIONS
CONTENTS

The main functions that can be activated with the keys (with or without remote control) are the following:

Type of key	Doors unlocking	Locking the doors from the outside	Safe Lock engagement (for versions/markets, where provided)	Unlocking the tailgate boot	Windows down (for versions/markets, where provided)	Windows up (for versions/markets, where provided)
Mechanical key	Turn key anticlockwise (driver's side)	Turn key clockwise (driver's side)	—	—	—	—
Key with remote control	Turn key anticlockwise (driver's side) Briefly press  button	Turn key clockwise (driver's side) Briefly press  button	—	—	—	—
Direction indicators flashing (only for key with remote control)	double flashing	flashes once	Double pressing  button flashes three times	Briefly press  button flashes twice	Hold pressed  button (for longer than 2 seconds) flashes twice	Hold pressed  button (for longer than 2 seconds) flashes once
Deterrence LED	Switching off	Switching on constantly for about 3 seconds, followed by deterrence LED flashing	Double flash, followed by deterrence flashing	Deterrence LED	Switching off	Deterrence LED

IMPORTANT Windows will lower down when the doors are unlocked; they will be wound up when the doors are locked.

IGNITION SWITCH

The key can be turned to three different positions fig. 21:

- STOP: engine off, key can be extracted, steering locked. Some electric devices (e.g. car radio, central door locking system, alarm, etc.) can work;
- MAR: driving position. All electric devices can work;
- ON: starting the engine.

The ignition switch is fitted with an electronic safety system that requires the ignition key to be turned back to STOP if the engine will not start, before the starting operation can be repeated.



If the ignition switch is tampered with (e.g.: attempted theft), have it checked over by an Alfa Romeo Authorised Service Provider as soon as possible.

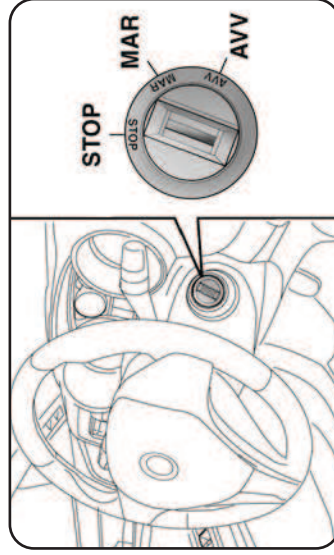

fig. 21

ADK0063m



Always remove the key when you leave your car to prevent someone from accidentally operating the controls. Remember to engage the handbrake. Engage 1st gear if the car is parked uphill or reverse if the car is parked downhill. Never leave children unattended in the car.

STEERING LOCK

Engagement

When the key is at STOP, remove the key and turn the steering wheel until it locks.

Disengagement

Move the steering wheel slightly and turn the ignition key to MAR.



It is absolutely forbidden to carry out any aftermarket operation involving steering system or steering column modifications (e.g.: installation of anti-theft device). This could badly affect performance and safety, invalidate the warranty and also result in the non-compliance of the car with approval requirements.



Never remove the key while the car is moving. The steering wheel should lock automatically as soon as it is turned. This also applies to when the car is towed.

GETTING TO KNOW YOUR CAR

SAFETY

STARTING AND DRIVING

IN AN EMERGENCY

SERVICING AND MAINTENANCE

TECHNICAL SPECIFICATIONS

CONTENTS

FCC Statement

Trade: MAGNETI MARELLI
Model: BCML9

FCC ID: RX2BCML7

IC: 4893A-BCML9

These device complies with Part 15 of the FCC rules subject to the following two conditions:

This device may not cause harmful interference.

This device must accept all interference received, including interference that may cause undesired operation.
Changes or modifications not expressly approved by the party responsible for compliance could void the user's authority to operate the equipment

Dear customer, to ensure a healthy RF exposure please keep a distance of at least 20 cm from the device.

For any other request regarding RF exposure compliance in Canada, please refer to our local representative:

Renaissance Consulting
11 Parsons Ridge Road, Kanata, Ottawa
Canada