

LS1700V

TFT-LCD MONITOR



INSTRUCTION MANUAL

Please read this manual thoroughly before use, and keep it handy for future reference.

CONTENTS

<i>SAFETY INSTRUCTION</i>	2 - 3
<i>CAUTIONS</i>	4
<i>FCC RF INTERFERENCE STATEMENT</i>	5
<i>CONNECTING WITH EXTERNAL EQUIPMENT</i>	6
<i>REMOTE FUNCTIONS</i>	7
<i>CONTROLS AND FUNCTIONS</i>	8 - 14
<i>MOUNTING GUIDE</i>	15
<i>D-SUB CONNECTOR PIN ASSIGNMENTS</i>	16
<i>POWER MANAGEMENT</i>	17
<i>SPECIFICATIONS</i>	18
<i>TROUBLESHOOTING GUIDE</i>	19

This Monitor was
Manufactured by ISO 9001
Certified Factory

SAFETY INSTRUCTION

1. Read all of these instructions.
2. Save these instructions for later use.
3. Follow all warnings and instructions marked on the product.
4. Unplug this product from the wall outlet before cleaning.
Do not use liquid cleaners or aerosol cleaners. Use a damp cloth for cleaning.
5. Do not use this product near water.
6. Do not place this product on an unstable cart, stand or table.
The product may fall, causing serious damage to the product.
7. Slots and openings in the cabinet and the back are provided for ventilation: to ensure reliable operation of the product, these openings must not be blocked by placing the product on a bed, sofa, rug or other similar surface.
This product should never be placed near or over a heat register.
This product should not be placed in a built-in installation unless proper ventilation is provided.
8. This product should be operated from the type of power source indicated on the marking label. If you are not sure of the type of power available, consult your dealer or local power company.
9. This product is equipped with a 3 wire grounding type plug having a third(grounding) pin. This is a safety feature. If you are unable to insert the plug into the outlet, contact your electrician to replace your obsolete outlet. Do not defeat the purpose of the grounding-type plug.
10. Do not allow anything to rest on the power cord.
Do not locate this product where persons will walk on the cord.
11. If an extension cord is used with this product, make sure that the total of the ampere ratings on the products plugged into the extension cord do not exceed the extension cord ampere rating. Also, make sure that the total of all products plugged into the wall outlet does not exceed 10 amperes.
12. Never push objects of any kind into this product through cabinet slots as they may touch dangerous voltage points or short out parts that could result in a risk of fire or electric shock.
Never spill any kind of liquid on the product.
13. Do not attempt to service this product yourself, as opening or removing covers may expose you to dangerous voltage points or other risks.

SAFETY INSTRUCTION

Refer all servicing to service personnel.

14. Unplug this product from the wall outlet and refer servicing to qualified service personnel under the following conditions.

- A. When the power cord or plug is damaged or frayed.
- B. If liquid has been spilled into the product.
- C. If the product has been exposed to rain or water.
- D. If the Product does not operate normally when the operating instructions are followed. Adjust only those controls that are covered by the operating instructions since improper adjustment of other controls may result in damage and will often require extensive work by a qualified technician to restore normal operation.
- E. If the product has been dropped or the cabinet has been damaged.
- F. If the product exhibits a distinct change in performance, indicating a need for service.

CAUTION

The power supply cord is used as the main disconnect device, ensure that the socket-outlet is located/installed near the equipment and is easily accessible.

ATTENTION

Le cordon d'alimentation est utilisé comme interrupteur général. La prise de courant doit être située ou installée à proximité du matériel et être facile d'accès

CAUTION TO SERVICE PERSONNEL

POWER SUPPLY CORD IS USED AS MAIN POWER DISCONNECT DEVICE IN THIS PRODUCT. UNPLUG THIS PRODUCT FROM THE WALL OUTLET BEFORE REMOVING THE BACK COVER AND SERVICING

EMISSION CHARACTERISTICS TESTED BY SEMKO

THIS PRODUCT HAS BEEN TESTED AND HAS SHOWN COMPLIANCE WITH THE NATIONAL SPECIFICATIONS SUCH AS SWEDISH MPR 1990.10.(MPR II)

CAUTIONS

▶ **NEVER REMOVE THE BACK COVER**

Removal of the back cover should be carried out only by qualified personnel.

▶ **DO NOT USE IN HOSTILE ENVIRONMENTS**

To prevent shock or fire hazard, do not expose the unit to rain or moisture.

This unit is designed to be used in the office or home. Do not subject the unit to vibrations, dust or corrosive gases.

▶ **KEEP IN A WELL VENTILATED PLACE**

Ventilation holes are provided on the cabinet to prevent the temperature from rising.

Do not cover the unit or place anything on the top of unit.

▶ **AVOID HEAT**

Avoid placing the unit in direct sunshine or near a heating appliance.

▶ **TO ELIMINATE EYE FATIGUE**

Do not use the unit against a bright background and where sunlight or other light sources will shine directly on the monitor.

▶ **BE CAREFUL OF HEAVY OBJECT**

Neither the monitor itself nor any other heavy object should rest on the power cord.

Damage to a power cord can cause fire or electrical shock.

FCC RF INTERFERENCE STATEMENT

NOTE

This equipment has been tested and found to comply with the limits for a Class B digital device, pursuant to Part 15 of the FCC Rules. These limits are designed to provide reasonable protection against harmful interference in a residential installation.

This equipment generates, uses and can radiate radio frequency energy and, if not installed and used in accordance with the instructions, may cause harmful interference to radio communications. However, there is no guarantee that interference will not occur in a particular installation.

If this equipment does cause harmful interference to radio or television reception which can be determined by turning the equipment off and on, the user is encouraged to try to correct the interference by one or more of the following measures.

- Reorient or relocate the receiving antenna.*
- Increase the separation between the equipment and receiver.*
- Connect the equipment into an outlet on a circuit different from that to which the receiver is connected.*
- Consult the dealer or an experienced radio, TV technician for help.*
- Only shielded interface cable should be used.*

Finally, any changes or modifications to the equipment by the user not expressly approved by the grantee or manufacturer could void the users authority to operate such equipment.

► DOC COMPLIANCE NOTICE

This digital apparatus does not exceed the Class B limits for radio noise emissions from digital apparatus set out in the radio interference regulation of Canadian Department of communications.

CONNECTING WITH EXTERNAL EQUIPMENT

A. BOTTOM PANEL CONTROL

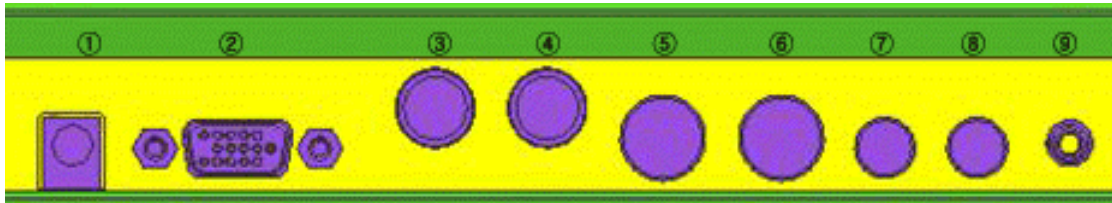

1. DC 12V IN

2. D-SUB IN

PC Signal Input

3. VIDEO IN

Composite signal Input for VIDEO

4. VIDEO OUT

Video looping output for VIDEO

5. Y/C IN (SVHS)

Y/C separated signal input

6. Y/C OUT (SVHS)

Y/C separated signal looping output

7. AUDIO LIN

Stereo Audio LEFT Input, This input is for AV, Y/C

8. AUDIO RIN

Stereo Audio RIGHT Input, This Output is for AV, Y/C

9. PC STEREO IN

REMOTE FUNCTIONS

F. REMOTE CONTROLLER

1. POWER()

Turns the power ON or OFF. There will be a few seconds delay before the display appears.

2. SOURCE

Select pc or video(PC / AV1 / S-Video) sources.

3. MUTE

Mute the sound.

4. MENU

Activates and exits the On Screen Display.

5. VOL()

Increases or decreases the level of audio volume.

6. UP/DOWN()

Move to OSD menu.

7. AUTO

Auto geometry adjustment in PC Source.

8. EXIT

Exit the On Screen Display.

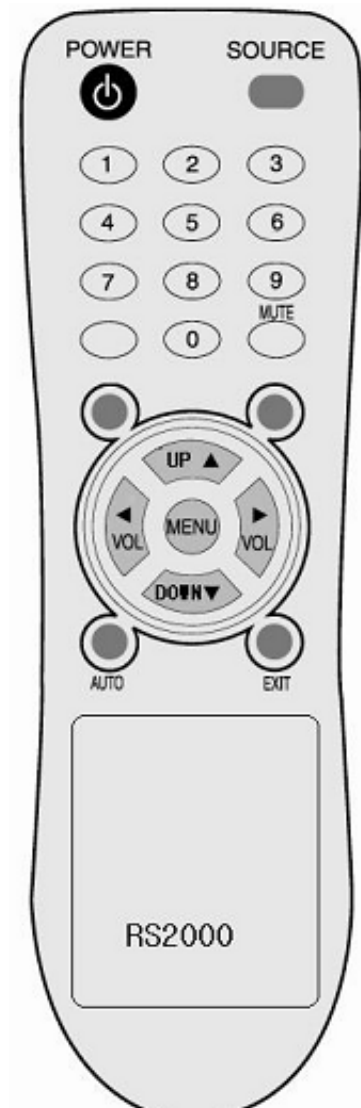

CONTROLS AND FUNCTIONS



1. MENU ()

Activates and exits the On Screen Display.

This button can also be used to move previous menu or status.

OSD MENU(MAIN) : Input Source, Screen, Audio, OSD, Color, Utility, Exit.

2/3. DOWN / UP ()

This button allows user to enter the sub-menu of the activated function when down key is pressed on the main menu.

4/5. VOLUME ()

Adjust the volume / Adjust menu settings.

6. POWER ON/OFF()

Turns the power ON or OFF. There will be a few seconds delay before the display appears.

The power LED(next to the power switch) lights with green when the power is turned ON.

The power is turned off by pressing the power switch again and the power LED goes Red.

7. IR Sensor

Remote controller sensor.

CONTROLS AND FUNCTIONS

1. SELF-TEST DISPLAY

When there is no connection at PC, the On Screen Display will show for 3 seconds.

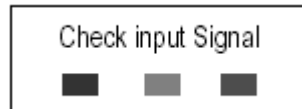

2. OSD MENU DESCRIPTION



AV : Input Source

Select PC or AV1, SVIDEO.

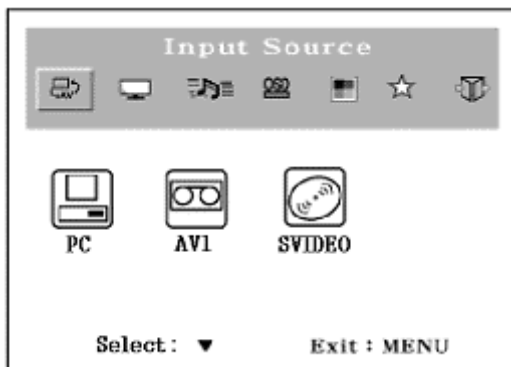

CONTROLS AND FUNCTIONS

 : Screen

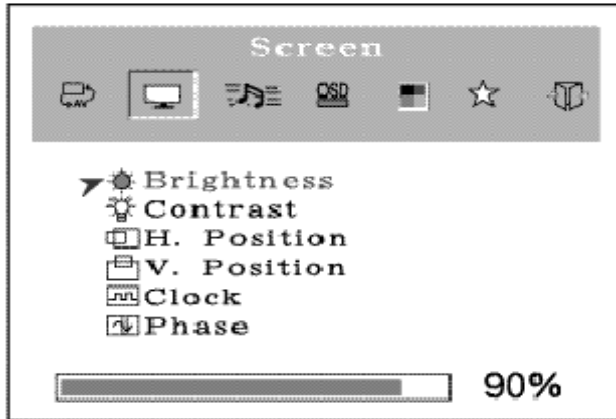

 : **Brightness**

Increase or decrease the intensity of the image.

 : **Contrast**

Increase or decrease the intensity (lightness or dimness) of the image.

 : **H. position (PC Mode Only)**

Move image horizontally on screen right or left.

 : **V. position (PC Mode Only)**

Move image vertically on screen up or down.

 : **Clock (PC Mode Only)**

Adjust the vertical noise of screen image.

 : **Phase (PC Mode Only)**

Adjust the number of horizontal picture elements.

CONTROLS AND FUNCTIONS

: Audio

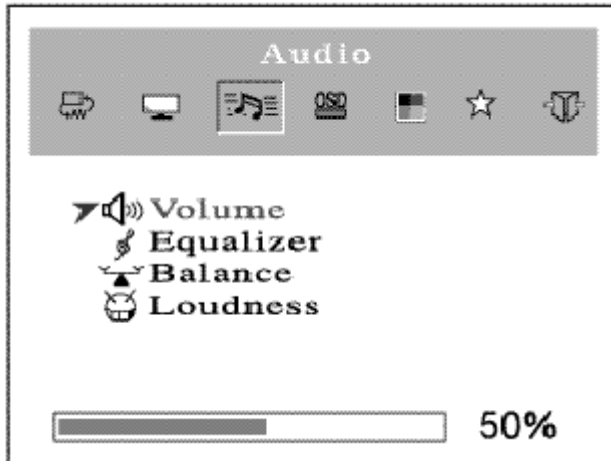

: Volume

Adjust audio volume.

: Equalizer (Loudspeaker Only)

Boost / Cut specific frequency or compensate for frequency distortion of the sound.

Select preferred Sound setting: flat, music, movie, speech and Adjust the level of the Sound frequency in user mode.

: Balance (Loudspeaker Only)

Adjust the balance of left and right speaker sound.

: Loudness (Loudspeaker Only)

Compensate the sound to consider the frequency sensitivity of human ear.

CONTROLS AND FUNCTIONS

OSD
: OSD

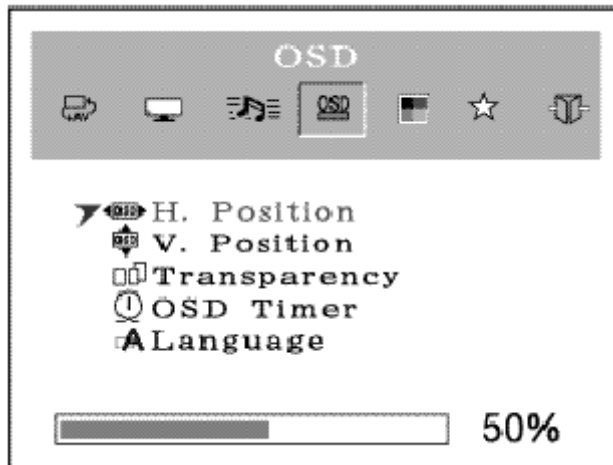

↔ : **H. Position**

Move the OSD position to right(▶) or left(◀).

↕ : **V. Position**

Move the OSD position to up(▶) or down(◀).

□□ : **Transparency**

Select the OSD background.

🕒 : **OSD Timer**

Select the OSD display timing.

A : **Language**

Select a language among English, Français, Deutsch, Español, Danish, Italiano.

CONTROLS AND FUNCTIONS

 : Color (PC Mode)

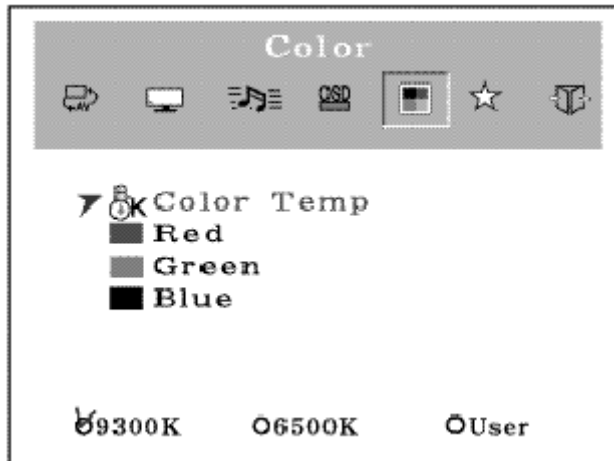

 : Color Temp

Adjust color temperature to 9300, 6500, user.
(note : 9300 is factory default)

 : Red
Adjust red color for user.

 : Green
Adjust green color for user.

 : Blue
Adjust blue color for user.

CONTROLS AND FUNCTIONS

☆ : **Utility**

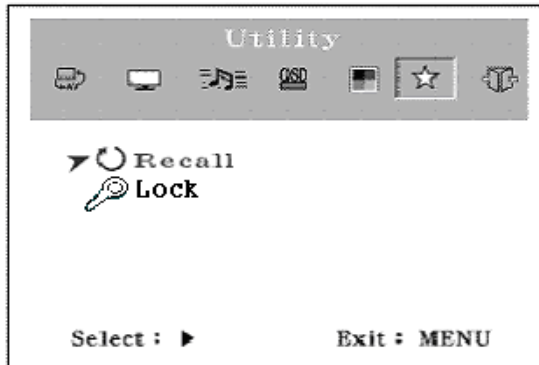

↻ : **Recall**

Select to reset all setting to the factory default values.

🔑 : **Lock**

Select ON or OFF (ON : Control key lock. OFF : Control key unlock)

📦 : **Exit**

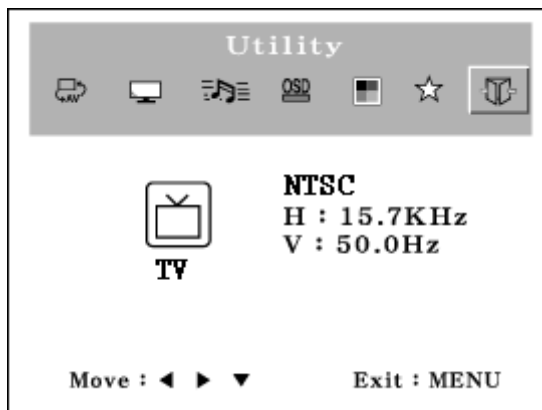

📦 : **Exit**

Turn off OSD Menu.

MOUNTING GUIDE

Wall mountable using two methods:

- 1) Using the 200 mm pre-cut holes
- 2) Using the VESA standard wall mount design and the 100mm hole pattern on the back panel to install the LCD monitor to the wall.

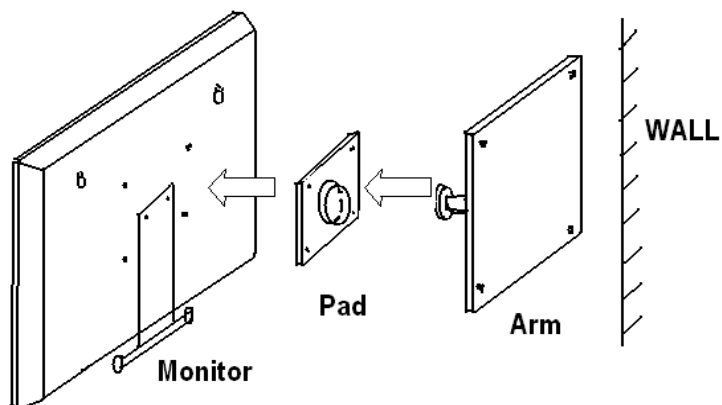
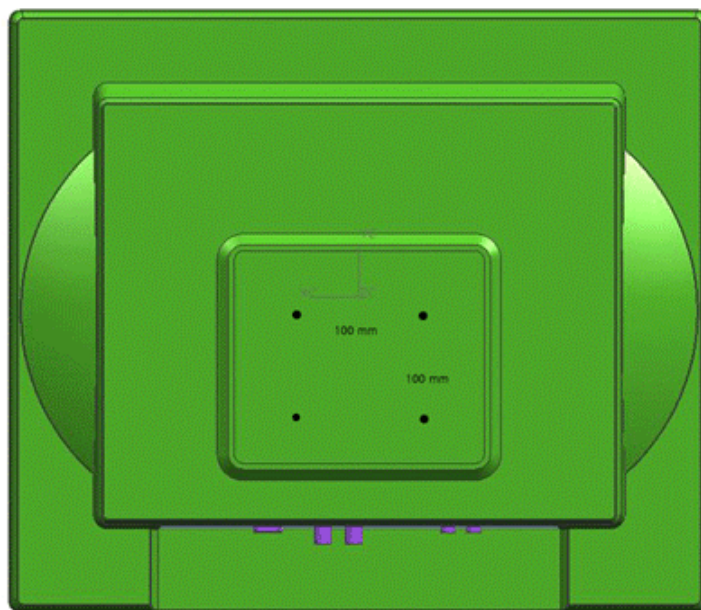

D-SUB CONNECTOR PIN ASSIGNMENTS

► PIN ASSIGNMENTS

Pin 1	RED VIDEO	9	
2	GREEN VIDEO	10	SIGNAL CABLE DETECT
3	BLUE VIDEO	11	GROUND
4	GROUND	12	SDA(for DDC)
5	GROUND	13	H-SYNC.(or H+V SYNC.)
6	RED GROUND	14	V-SYNC.
7	GREEN GROUND	15	SCL(for DDC)
8	BLUE GROUND		

D-SUB

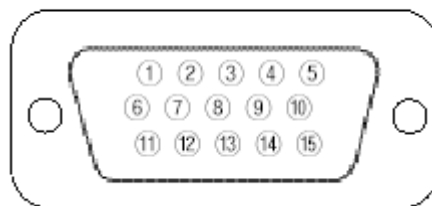

► ACCESSORY

1. POWER CORD, Audio Cable
2. USER'S MANUAL
3. Warranty Card
4. S-VHS Cable
5. PC cable
6. Audio cable
7. Remote Control (Option)
8. Batteries (Option)
9. Wall mount (Option)
10. Rack mount (Option)

POWER MANAGEMENT

This monitor features a power management system to “power down” upon receipt of the VESA DPMS(The display power management signaling) from a VESA DPMS video card.

The VESA DPMS-compliant video card performs this signaling system through not sending horizontal, vertical, or sync signal.

This monitor enters an appropriate mode through identifying each of the three modes of the signaling system.

POWER CONSUMPTION

MODE	POWER CONSUMPTION
ON	< 50W
STANDBY	< 5W
SUSPEND	< 5W
ACTIVE OFF	< 5W

LED INDICATOR

The power management feature of the monitor is comprised of four stages : On(Green), Standby, Suspend, Active off(Amber) and Unsupported mode(Green).

MODE	LED COLOR	MONITOR OPERATION
ON	GREEN	Normal Operation
STANDBY	OFF	Screen blanks after preset idle time and some electronic circuits or all circuitry in the monitor shut down.
SUSPEND		
ACTIVE OFF		
UNSUPPORTED MODE	GREEN	Normal operation but the on screen display will show error message.
POWER OFF	OFF	Not operation

SPECIFICATIONS

▶ LCD Type

17" Diagonal AM-TFT(Active-Matrix)

Pixel pitch(mm) : 0.264(H) 0.264(V)

BRIGHTNESS: 300cd/m²(Typical)

CONTRAST RATIO: 500:1(Typical)

RESPONSE TIME: 13msec(Typical)

▶ RESOLUTION(H x V)

1280X1024 @75Hz

▶ FREQUENCY

HORIZONTAL: 30-75KHz

VERTICAL: 50-75Hz

▶ INPUT SIGNAL

VIDEO(Analog 0.7Vp-p / 75Ω)

SYNC(Separate TTL Level)

S-VIDEO, AV(Composite, Sound L/R)

PC Stereo Sound

▶ ACTIVE DISPLAY AREA (W x H)

337.9mm X 270.3mm

▶ PACKING DIMENSIONS (W x D x H)

18.5 X 16.9 X 7.5 Inch

▶ WEIGHT

Net Weight : 6.2Kg

Gross Weight : 7.8Kg

▶ ELECTRICAL RATINGS

12V dc / 4A

▶▶ NOTE :

Technical specifications are subject to change without notice.

TROUBLESHOOTING GUIDE

TROUBLE	TROUBLESHOOTING TIP
No image on display screen	<ol style="list-style-type: none"> 1. Check that power cord of the Monitor have been connected securely into wall outlet or grounded extension cable or strip. 2. Power switch should be in the ON position and LED is lit. 3. Check that the Brightness and/or the Contrast adjustments of the Display have not been turned down to minimum levels.
"Check Input Signal" message on screen	<ol style="list-style-type: none"> 1. The signal cable should be completely connected to the video card/computer. 2. The video card should be completely seated in its slot and the computer is switched ON.
Display image is not centered, too small or too large in PC mode	Push the down key in front side or Auto key in remote.
Vertical or Horizontal noise is present in the picture	Adjust Clock and Phase in the OSD.