



SAR TEST REPORT

No. I221Z60808-SEM12

For

Razer Inc.

Gaming Tablet

Model Name: RZ45-0460VWQ

With

Hardware Version: V4

Software Version: Razer Edge 5G-12-user

FCC ID: RWO-RZ450460

Issued Date: 2022-9-28

Note:

The test results in this test report relate only to the devices specified in this report. This report shall not be reproduced except in full without the written approval of CTTL.

The report must not be used by the client to claim product certification, approval, or endorsement by NVLAP, NIST, or any agency of the U.S. Government.

Test Laboratory:

CTTL, Telecommunication Technology Labs, CAICT

No. 51, Xueyuan Road, Haidian District, Beijing, P. R. China 100191.

Tel:+86(0)10-62304633-2512, Fax:+86(0)10-62304633-2504

Email: ctl_terminals@caict.ac.cn, website: www.caict.ac.cn



REPORT HISTORY

Report Number	Revision	Issue Date	Description
I22Z60808-SEM12	Rev.0	2022-8-15	Initial creation of test report
I22Z60808-SEM12	Rev.1	2022-8-23	Update the information on section 4.1
I22Z60808-SEM12	Rev.2	2022-8-25	Update the test distance information on Page 6. Update the information on section 5.2. Update the information on section 12.2. Update the information on section 13.1.
I22Z60808-SEM12	Rev.3	2022-8-27	Update the information for UNII band 4.
I22Z60808-SEM12	Rev.4	2022-9-01	Update the information for Chapter II on Page 6
I22Z60808-SEM12	Rev.5	2022-9-28	Update the information for n77.

TABLE OF CONTENT

1 TEST LABORATORY	5
1.1 TESTING LOCATION	5
1.2 TESTING ENVIRONMENT.....	5
1.3 PROJECT DATA	5
1.4 SIGNATURE.....	5
2 STATEMENT OF COMPLIANCE	6
3 CLIENT INFORMATION	8
3.1 APPLICANT INFORMATION	8
3.2 MANUFACTURER INFORMATION	8
4 EQUIPMENT UNDER TEST (EUT) AND ANCILLARY EQUIPMENT (AE).....	9
4.1 ABOUT EUT	9
4.2 INTERNAL IDENTIFICATION OF EUT USED DURING THE TEST	10
4.3 INTERNAL IDENTIFICATION OF AE USED DURING THE TEST	10
5 TEST METHODOLOGY	11
5.1 APPLICABLE LIMIT REGULATIONS	11
5.2 APPLICABLE MEASUREMENT STANDARDS.....	11
6 SMART TRANSMIT FEATURE FOR RF EXPOSURE COMPLIANCE	12
7 SPECIFIC ABSORPTION RATE (SAR).....	14
7.1 INTRODUCTION.....	14
7.2 SAR DEFINITION.....	14
8 TISSUE SIMULATING LIQUIDS	15
8.1 TARGETS FOR TISSUE SIMULATING LIQUID	15
8.2 DIELECTRIC PERFORMANCE	15
9 SYSTEM VERIFICATION	21
9.1 SYSTEM SETUP.....	21
9.2 SYSTEM VERIFICATION.....	22
9.3 PD SYSTEM PERFORMANCE CHECK RESULTS	23
10 MEASUREMENT PROCEDURES	24
10.1 TESTS TO BE PERFORMED	24
10.2 GENERAL MEASUREMENT PROCEDURE.....	26
10.4 SAR MEASUREMENT FOR LTE.....	27
10.5 BLUETOOTH & WI-FI MEASUREMENT PROCEDURES FOR SAR	29
10.6 POWER DRIFT.....	29
11 AREA SCAN BASED 1-G SAR.....	30
11.1 REQUIREMENT OF KDB.....	30
11.2 FAST SAR ALGORITHMS.....	30
12 CONDUCTED OUTPUT POWER.....	31
12.2 WCDMA MEASUREMENT RESULT	31
12.1 LTE MEASUREMENT RESULT	33

12.2 WI-FI AND BT MEASUREMENT RESULT	69
12.3 NR 5G MEASUREMENT RESULT.....	78
13 SIMULTANEOUS TX SAR CONSIDERATIONS.....	83
13.1 TRANSMIT ANTENNA SEPARATION DISTANCES	83
13.2 SAR MEASUREMENT POSITIONS	83
14 EVALUATION OF SIMULTANEOUS.....	84
15 SAR TEST RESULT	85
15.1 SAR RESULTS FOR 4G	88
15.2 SAR RESULTS FOR WLAN	90
15.3 PD RESULTS	91
15.4 SAR RESULTS FOR BT	91
15.5 SAR RESULTS FOR 5G NR	92
16 SAR MEASUREMENT VARIABILITY.....	93
17 MEASUREMENT UNCERTAINTY	94
17.1 MEASUREMENT UNCERTAINTY FOR NORMAL SAR TESTS (300MHZ~3GHZ)	94
17.2 MEASUREMENT UNCERTAINTY FOR NORMAL SAR TESTS (3~6GHZ)	95
17.3 MEASUREMENT UNCERTAINTY FOR FAST SAR TESTS (300MHZ~3GHZ)	96
17.4 MEASUREMENT UNCERTAINTY FOR FAST SAR TESTS (3~6GHZ).....	97
18 MAIN TEST INSTRUMENTS.....	99
ANNEX A GRAPH RESULTS.....	100
ANNEX B SYSTEM VERIFICATION RESULTS	120
ANNEX C SAR MEASUREMENT SETUP	134
ANNEX D POSITION OF THE WIRELESS DEVICE IN RELATION TO THE PHANTOM	140
ANNEX E EQUIVALENT MEDIA RECIPES	142
ANNEX F SYSTEM VALIDATION	143
ANNEX G PROBE CALIBRATION CERTIFICATE.....	145
ANNEX H DIPOLE CALIBRATION CERTIFICATE	196
ANNEX I SENSOR TRIGGERING DATA SUMMARY.....	282
ANNEX J ACCREDITATION CERTIFICATE.....	297

1 Test Laboratory

1.1 Testing Location

Company Name:	CTTL(Shouxiang)
Address:	No. 51 Shouxiang Science Building, Xueyuan Road, Haidian District, Beijing, P. R. China100191

1.2 Testing Environment

Temperature:	18°C~25°C,
Relative humidity:	30%~ 70%
Ground system resistance:	< 0.5 Ω
Ambient noise & Reflection:	< 0.012 W/kg

1.3 Project Data

Project Leader:	Qi Dianyuan
Test Engineer:	Lin Xiaojun
Testing Start Date:	June 8, 2022
Testing End Date:	August 26, 2022

1.4 Signature



Lin Xiaojun

(Prepared this test report)

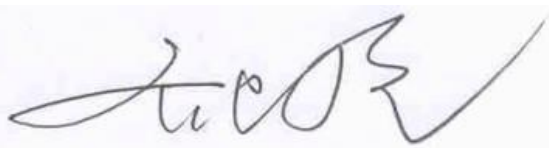

Qi Dianyuan

(Reviewed this test report)

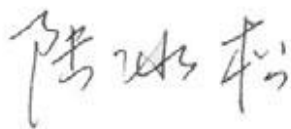

Lu Bingsong

Deputy Director of the laboratory

(Approved this test report)

2 Statement of Compliance

The maximum results of SAR found during testing for Razer Inc. Gaming Tablet RZ45-0460VWQ are as follows:

Table 2.1: Highest Reported SAR (1g)

Mode		Antenna	Highest Reported SAR (1g)
WCDMA	WCDMA 850	ANT1	0.40
	WCDMA 1900	ANT0	0.60
LTE	LTE Band 2	ANT0	0.47
	LTE Band 4	ANT0	0.71
	LTE Band 5	ANT1	0.35
	LTE Band 12	ANT1	0.28
	LTE Band 13	ANT1	0.24
	LTE Band 48	ANT2	0.67
	LTE Band 66	ANT0	0.39
NR	N2	ANT0	0.52
	N5	ANT1	0.40
	N66	ANT0	0.44
	n77-H	ANT2	0.96
WLAN 2.4 GHz		ANT4	0.14
WLAN 5 GHz			0.35
WLAN 6 GHz			<0.01
WLAN 2.4 GHz		ANT5	0.34
WLAN 5 GHz			0.28
WLAN 6 GHz			<0.01
BT		ANT5	0.05

The SAR values found for the Mobile Phone are below the maximum recommended levels of 1.6 W/Kg as averaged over any 1g tissue according to the ANSI C95.1-1992.

For body operation, this device has been tested and meets FCC RF exposure guidelines when used with any accessory that contains no metal and which provides a minimum separation distance of 5/10/14/15/17/19/20/24/25mm between this device and the body of the user. Use of other accessories may not ensure compliance with FCC RF exposure guidelines.

Note: The maximum duty cycle of N77-PC3 and N77-PC2 is the same. The tune up of N77-PC2 was higher, so only N77-PC2 was tested.

The EUT battery must be fully charged and checked periodically during the test to ascertain uniform power output.

The measurement together with the test system set-up is described in annex C of this test report. A detailed description of the equipment under test can be found in chapter 4 of this test report. The highest reported SAR value is obtained at the case of **(Table 2.1)**, and the values are: **0.96 W/kg (1g)**.

Table 2.2: The sum of reported SAR values for main antenna and WiFi+BT

	Position	Main antenna	WLAN2.4G antenna		WLAN5G antenna		BT	Sum
Maximum reported SAR value for Body	Front 25mm	0.71 (N77-H)	0.14 (WLAN2.4G ANT4)	0.29 (WLAN2.4G ANT5)	0.26 (WLAN5G ANT4)	0.05 (WLAN5G ANT5)	0.04	1.49

According to the above tables, the highest sum of reported SAR values is **1.49 W/kg (1g)**. The detail for simultaneous transmission consideration is described in chapter 13.



3 Client Information

3.1 Applicant Information

Company Name:	Razer Inc.
Address/Post:	9 Pasteur, Suite 100, Irvine, CA 92618, USA.
Contact Person:	Johnsen Tia
E-mail:	Johnsen.tia@razer.com
Telephone:	/
Fax:	+65 6571 6828

3.2 Manufacturer Information

Company Name:	Razer Inc.
Address/Post:	9 Pasteur, Suite 100, Irvine, CA 92618, USA.
Contact Person:	Johnsen Tia
E-mail:	Johnsen.tia@razer.com
Telephone:	/
Fax:	+65 6571 6828

4 Equipment Under Test (EUT) and Ancillary Equipment (AE)

4.1 About EUT

Description:	Gaming Tablet	
Model name:	RZ45-0460VWQ	
Operating mode(s):	WCDMA B2/B5 LTE Band2/4/5/12/13/46/48/66 5G NR n2/5/48/66/77/n260/261/257 BT, Wi-Fi(2.4G), Wi-Fi(5G), Wi-Fi(6G)	
Tested Tx Frequency:	824–849 MHz (WCDMA 850 Band V)	
	1850–1910 MHz (WCDMA1900 Band II)	
	850.7 – 1909.3 MHz (LTE Band 2)	
	824.7 – 848.3 MHz (LTE Band 5)	
	699.7 – 715.3 MHz (LTE Band 12)	
	779.5 – 784.5 MHz (LTE Band 13)	
	1710.7 –1779.3 MHz (LTE Band 66)	
	2412 – 2462 MHz (WLAN 2.4G)	
	2400 – 2483.5 MHz (Bluetooth)	
	5180 – 5240 MHz	WLAN 5G
	5260 – 5320 MHz	
	5500 – 5720 MHz	
	5745 – 5825 MHz	
	5845 – 5885 MHz	WLAN 6E
	5925 – 6425 MHz	
	6425 – 6525 MHz	
	6525 – 6875 MHz	
	6875 – 7125 MHz	
	1850 – 1910 MHz(n2)	
	824 – 849 MHz(n5)	
1710 – 1780 MHz (n66)		
3700 – 3980 MHz (n77H)		
37000– 40000 MHz (n260)		
27500– 28350 MHz (n257/261)		
Test device Production information:	Production unit	
Device type:	Portable device	
Antenna type:	Integrated antenna	

4.2 Internal Identification of EUT used during the test

EUT ID*	IMEI	HW	SW Version
EUT1	867034040041809	V4	Razer Edge 5G-12-user
EUT2	867034040035264	V4	Razer Edge 5G-12-user
EUT3	867034040037518	V4	Razer Edge 5G-12-user
EUT4	867034040035850	V4	Razer Edge 5G-12-user
EUT5	867034040041334	V4	Razer Edge 5G-12-user
EUT6	867034040036106	V4	Razer Edge 5G-12-user
EUT7	867034040034663	V4	Razer Edge 5G-12-user
EUT8	867034040035280	V4	Razer Edge 5G-12-user
EUT9	867034040041882	V4	Razer Edge 5G-12-user
EUT10	867034040041421	V4	Razer Edge 5G-12-user
EUT11	867034040041489	V4	Razer Edge 5G-12-user
EUT12	867034040039316	V4	Razer Edge 5G-12-user

*EUT ID: is used to identify the test sample in the lab internally.

Note: It is performed to test SAR with the EUT1-6 and conducted power with the EUT7-10.

4.3 Internal Identification of AE used during the test

AE ID*	Description	Model	SN	Manufacturer
AE1	Battery	RC30-046001	/	ATL

*AE ID: is used to identify the test sample in the lab internally.

5 TEST METHODOLOGY

5.1 Applicable Limit Regulations

ANSI C95.1–1992: IEEE Standard for Safety Levels with Respect to Human Exposure to Radio Frequency Electromagnetic Fields, 3 kHz to 300 GHz.

It specifies the maximum exposure limit of **1.6 W/kg** as averaged over any 1 gram of tissue for portable devices being used within 20 cm of the user in the uncontrolled environment.

5.2 Applicable Measurement Standards

IEEE 1528–2013: Recommended Practice for Determining the Peak Spatial-Average Specific Absorption Rate (SAR) in the Human Head from Wireless Communications Devices: Measurement Techniques.

KDB447498 D01: General RF Exposure Guidance v06: Mobile and Portable Devices RF Exposure Procedures and Equipment Authorization Policies.

KDB648474 D04 Handset SAR v01r03: SAR Evaluation Considerations for Wireless Handsets.

KDB941225 D05 SAR for LTE Devices v02r05: SAR Evaluation Considerations for LTE Devices

KDB941225 D06 Hotspot Mode SAR v02r01: SAR Evaluation Procedures for Portable Devices with Wireless Router Capabilities

KDB248227 D01 802.11 Wi-Fi SAR v02r02: SAR GUIDANCE FOR IEEE 802.11 (Wi-Fi) TRANSMITTERS

KDB865664 D01 SAR measurement 100 MHz to 6 GHz v01r04: SAR Measurement Requirements for 100 MHz to 6 GHz.

KDB865664 D02 RF Exposure Reporting v01r02: RF Exposure Compliance Reporting and Documentation Considerations

April 27, 2022 TCBC Workshop: RF Exposure Procedures

6 Smart Transmit feature for RF Exposure compliance

The FCC RF exposure limit is defined based on time-averaged RF exposure. The product implements Qualcomm Smart Transmit feature which controls the instantaneous transmitting power for WWAN transmitter to ensure the product in compliance with FCC RF exposure limit over a defined time window for SAR (transmit frequency \leq 6GHz). To control and manage transmitting power in real time and to ensure at all times the time-averaged RF exposure is compliant to the regulation requirement.

The purpose of the Part 1 test in this report is to demonstrate that the device meets the FCC SAR limits when transmitting in static transmission scenario at maximum allowable time-averaged power levels. The parameters obtained from SAR characterization (referred to as SAR char, respectively) will be used as input for Smart Transmit. SAR char will be entered via the Embedded File System (EFS) to enable the Smart Transmit Feature.

WLAN/BT operations are not enabled with Smart Transmit.

Term	Description
P_{limit}	The time-averaged RF power which corresponds to SAR_design_target.
P_{max}	Maximum target power level
SAR_design_target:	The design target for SAR compliance. It should be less than regulatory power density limit to account for all device design related uncertainties.
SAR Char	P_{limit} for all the technologies/bands for all applicable DSI

Smart Transmit allows the device to transmit at higher power instantaneously, as high as P_{max} , when needed, but enforces power limiting to maintain time-averaged transmit power to P_{limit} . Below table shows P_{limit} and maximum tune up output power P_{max} configured for this EUT for various transmit conditions (Device State Index DSI).

<Plimit for supported technologies and bands>

Band	Antenna	Sensor active	Sensor deactive	Pmax*
		DSI0	DSI1	
WCDMA1900	0	15	23	23
WCDMA850	1	18.5	23	23
LTE B2	0	13.5	24	24
LTE B4	0	18.5	24	24
LTE B5	1	15	24	24
LTE B12	1	20	23	23
LTE B13	1	15.5	24	24
LTE B48	2	15.5	24	24
LTE B66	0	14.5	24	24
n2	0	12	24	24
n5	1	15.3	24	24
n66	0	15	24	24
n77**	2	11.9	25.5	25.5

*Pmax is used for RF tune up procedure. The maximum allowed output power is equal to Pmax + 1dB uncertainty.

**All Plimit power levels entered in the Table correspond to average power levels after accounting for duty cycle in the case TDD modulation schemes (for e.g., GSM & LTE TDD & NR TDD).

The max allowed output power is the Plimit + 1dB device uncertainty, and if Plimit is higher than Pmax, the device output power will be Pmax instead.

7 Specific Absorption Rate (SAR)

7.1 Introduction

SAR is related to the rate at which energy is absorbed per unit mass in an object exposed to a radio field. The SAR distribution in a biological body is complicated and is usually carried out by experimental techniques or numerical modeling. The standard recommends limits for two tiers of groups, occupational/controlled and general population/uncontrolled, based on a person's awareness and ability to exercise control over his or her exposure. In general, occupational/controlled exposure limits are higher than the limits for general population/uncontrolled.

7.2 SAR Definition

The SAR definition is the time derivative (rate) of the incremental energy (dW) absorbed by (dissipated in) an incremental mass (dm) contained in a volume element (dv) of a given density (ρ). The equation description is as below:

$$SAR = \frac{d}{dt} \left(\frac{dW}{dm} \right) = \frac{d}{dt} \left(\frac{dW}{\rho dv} \right)$$

SAR is expressed in units of Watts per kilogram (W/kg)

SAR measurement can be either related to the temperature elevation in tissue by

$$SAR = c \left(\frac{\delta T}{\delta t} \right)$$

Where: C is the specific heat capacity, δT is the temperature rise and δt is the exposure duration, or related to the electrical field in the tissue by

$$SAR = \frac{\sigma |E|^2}{\rho}$$

Where: σ is the conductivity of the tissue, ρ is the mass density of tissue and E is the RMS electrical field strength.

However for evaluating SAR of low power transmitter, electrical field measurement is typically applied.

8 Tissue Simulating Liquids

8.1 Targets for tissue simulating liquid

Table 8.1: Targets for tissue simulating liquid

Frequency(MHz)	Liquid Type	Conductivity(σ)	$\pm 5\%$ Range	Permittivity(ϵ)	$\pm 5\%$ Range
835	Head	0.90	0.86~0.95	41.5	39.4~43.6
1750	Head	1.37	1.30~1.44	40.08	38.1~42.1
1900	Head	1.40	1.33~1.47	40.0	38.0~42.0
2450	Head	1.80	1.71~1.89	39.2	37.2~41.2
2600	Head	1.96	1.86~2.06	39.01	37.1~41.0
3500	Head	2.91	2.76~3.06	37.93	36.03~ 39.83
3700	Head	3.12	2.96~3.28	37.70	35.82~ 39.59
3900	Head	3.32	3.15~3.49	37.47	35.6~39.34
5250	Head	4.71	4.47~4.95	35.93	34.13~ 37.73
5600	Head	5.07	4.82~5.32	35.53	33.8~37.3
5750	Head	5.22	4.96~5.48	35.36	33.59~ 37.13
6500	Head	6.07	5.77~6.37	34.50	32.78~ 36.23

8.2 Dielectric Performance

Table 8.2: Dielectric Performance of Tissue Simulating Liquid

Measurement Date (yyyy-mm-dd)	Type	Frequency	Permittivity ϵ	Drift (%)	Conductivity σ (S/m)	Drift (%)
2022-6-8	Head	750 MHz	43.88	4.63	0.848	-4.72
2022-6-10	Head	835 MHz	43.49	4.80	0.861	-4.33
2022-6-9	Head	1750 MHz	41.45	3.42	1.331	-2.85
2022-6-11	Head	1900 MHz	41.27	3.18	1.421	1.50
2022-8-9	Head	2450 MHz	40.49	3.29	1.83	1.67
2022-6-17	Head	3500 MHz	38.23	0.79	2.774	-4.67
2022-6-18	Head	3700 MHz	37.82	0.32	2.979	-4.52
2022-6-19	Head	3900 MHz	37.46	-0.03	3.163	-4.73
2022-6-21	Head	5250 MHz	34.96	-2.70	4.582	-2.72
2022-6-22	Head	5600 MHz	34.32	-3.41	4.956	-2.25
2022-6-23	Head	5750 MHz	34.04	-3.73	5.121	-1.90
2022-6-24	Head	6500 MHz	32.9	-4.64	6.22	2.47
2022-8-26	Head	5800 MHz	35.38	0.23	5.33	1.14

Note: The liquid temperature is 22.0°C



Picture 8-1 Liquid depth in the Head Phantom (750MHz)

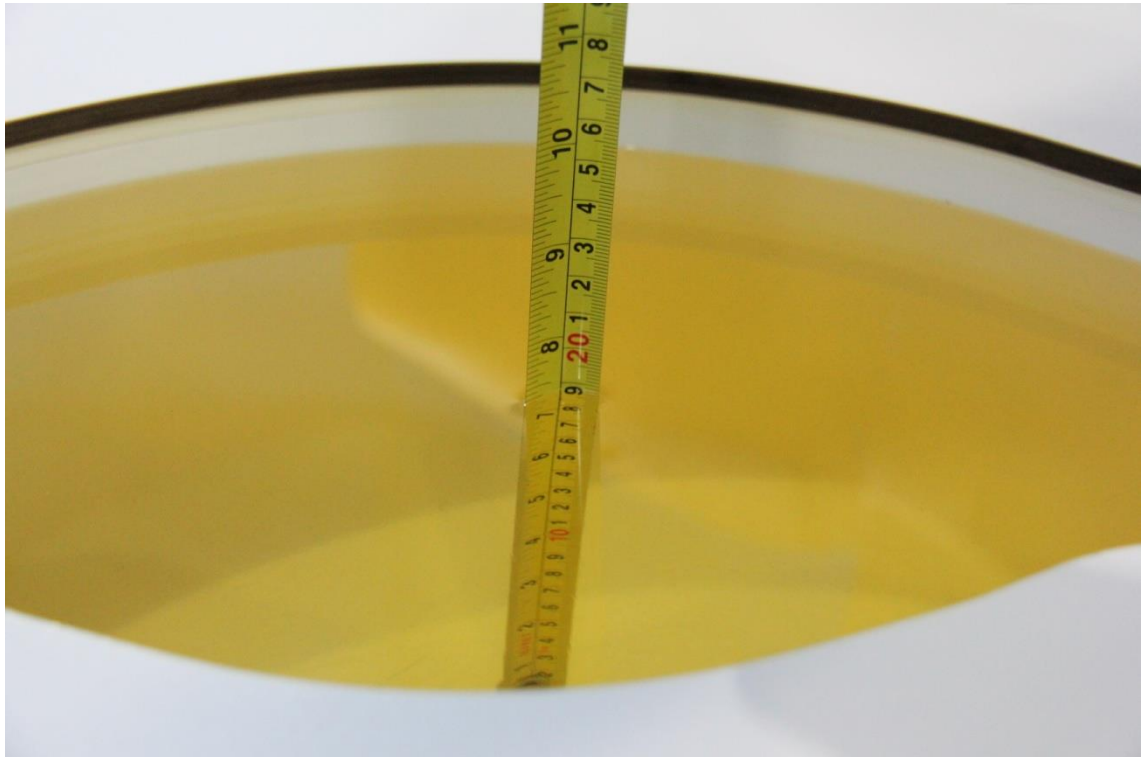

Picture 8-2 Liquid depth in the Head Phantom (835 MHz)

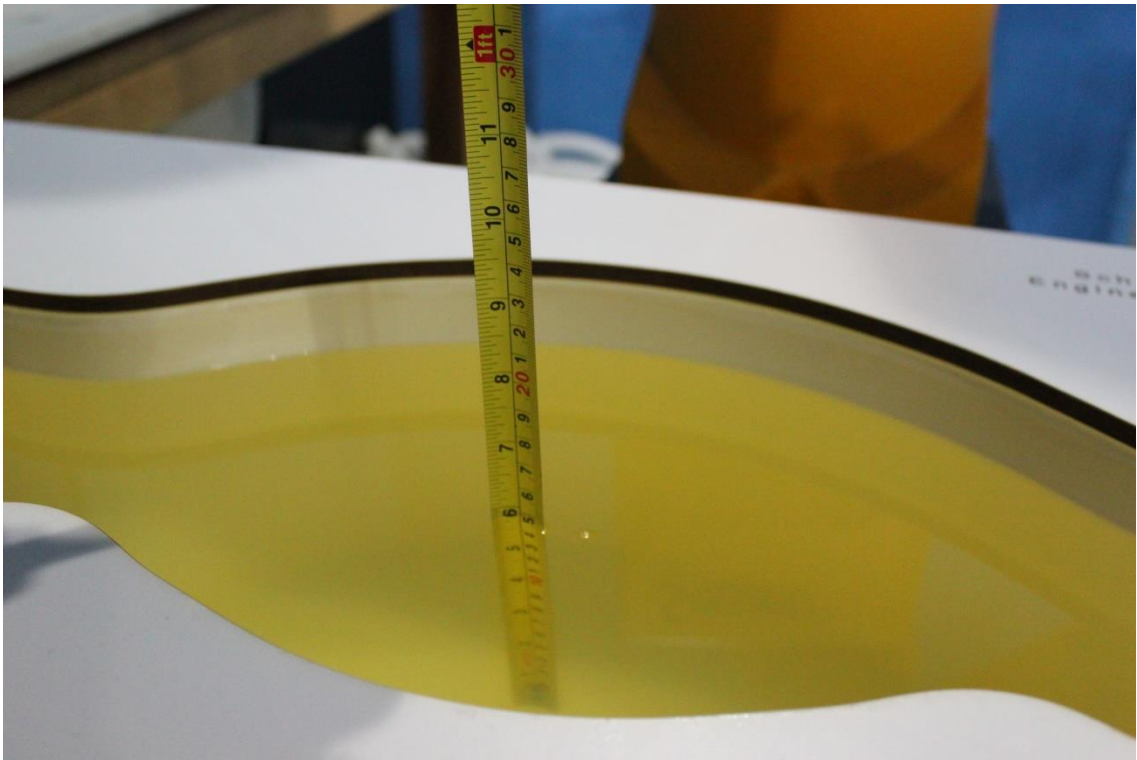

Picture 8-3 Liquid depth in the Head Phantom (1750 MHz)

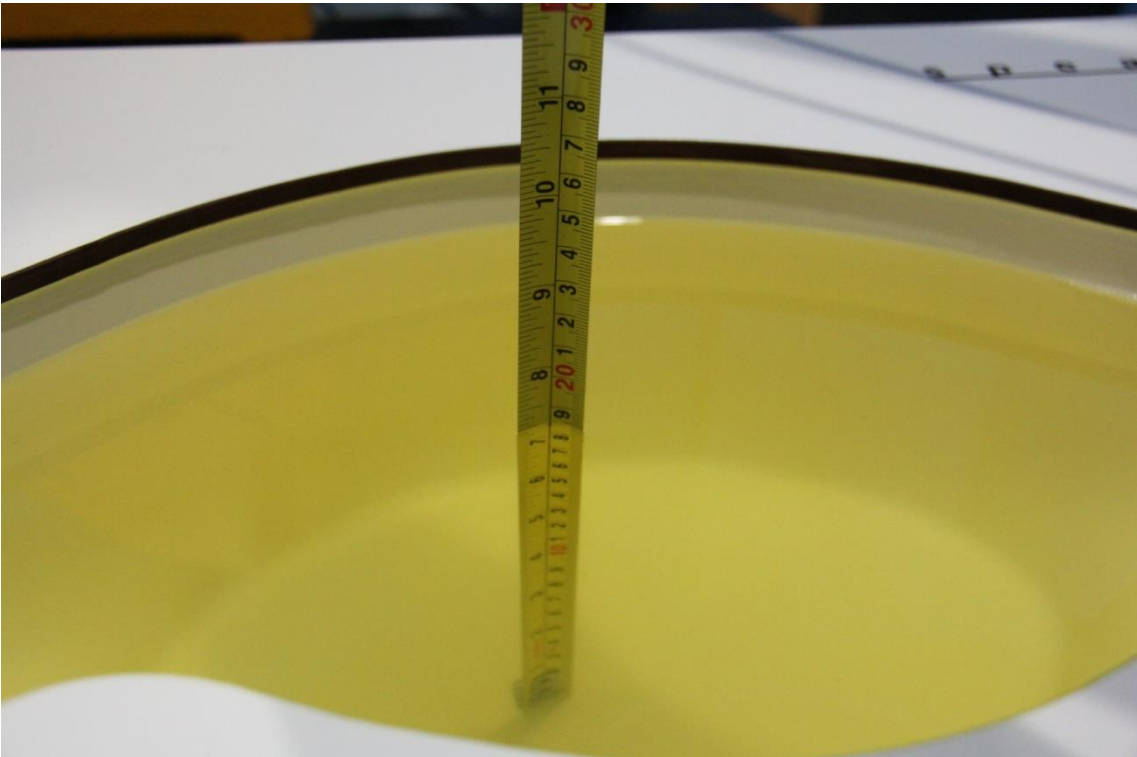

Picture 8-4 Liquid depth in the Head Phantom (1900 MHz)

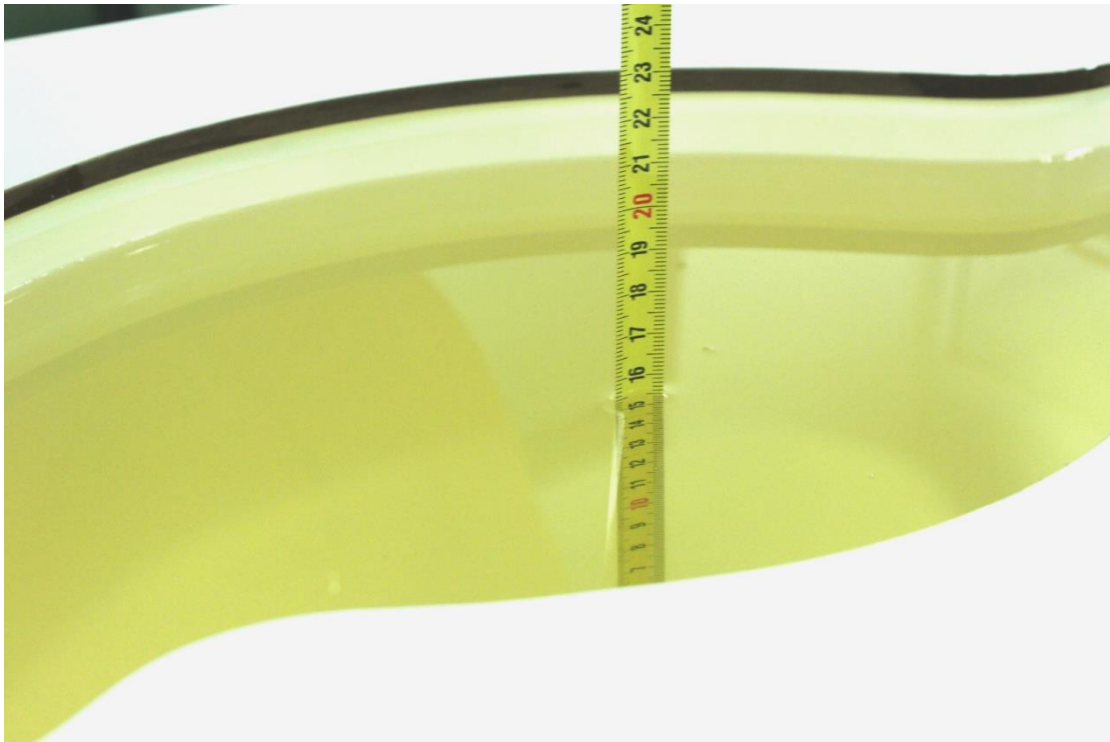

Picture 8-5 Liquid depth in the Head Phantom (2450MHz)

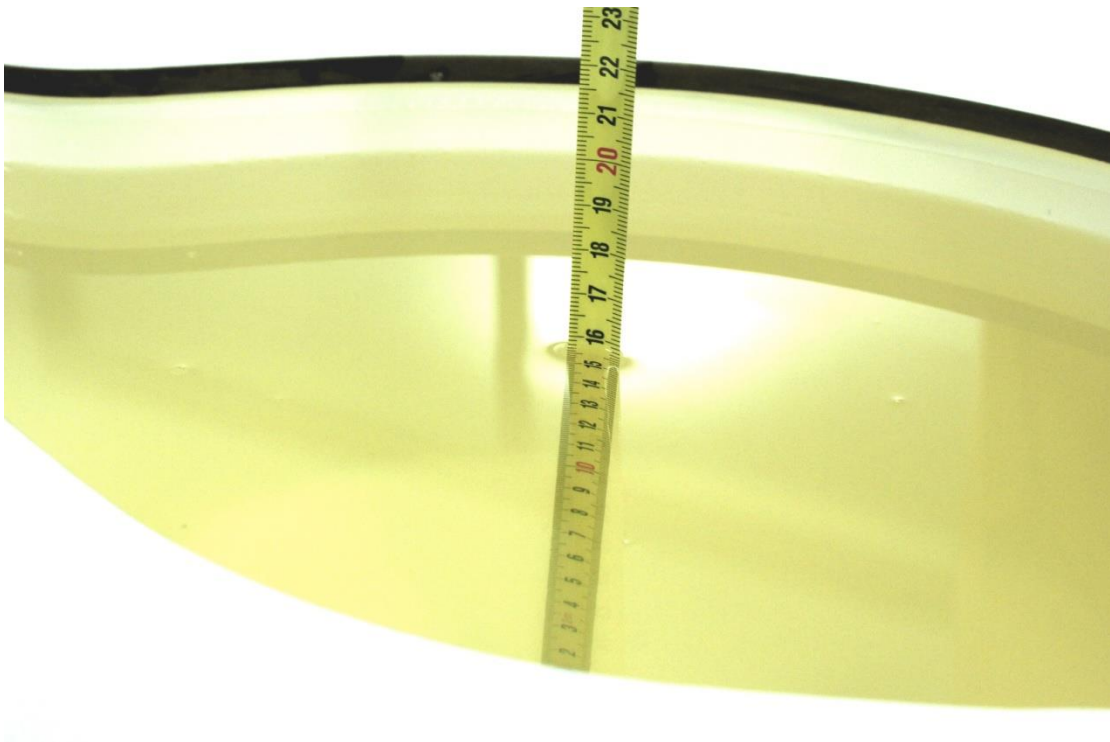

Picture 8-6 Liquid depth in the Head Phantom (2600 MHz)

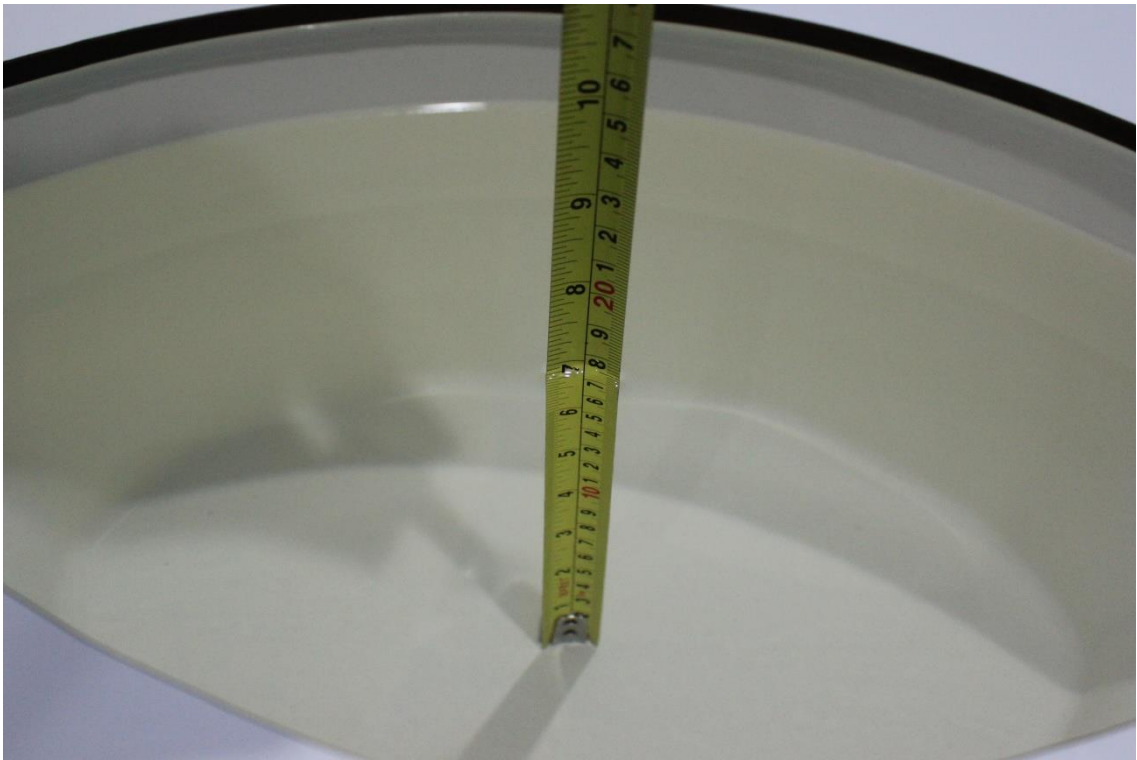

Picture 8-7 Liquid depth in the Head Phantom (3GHz)

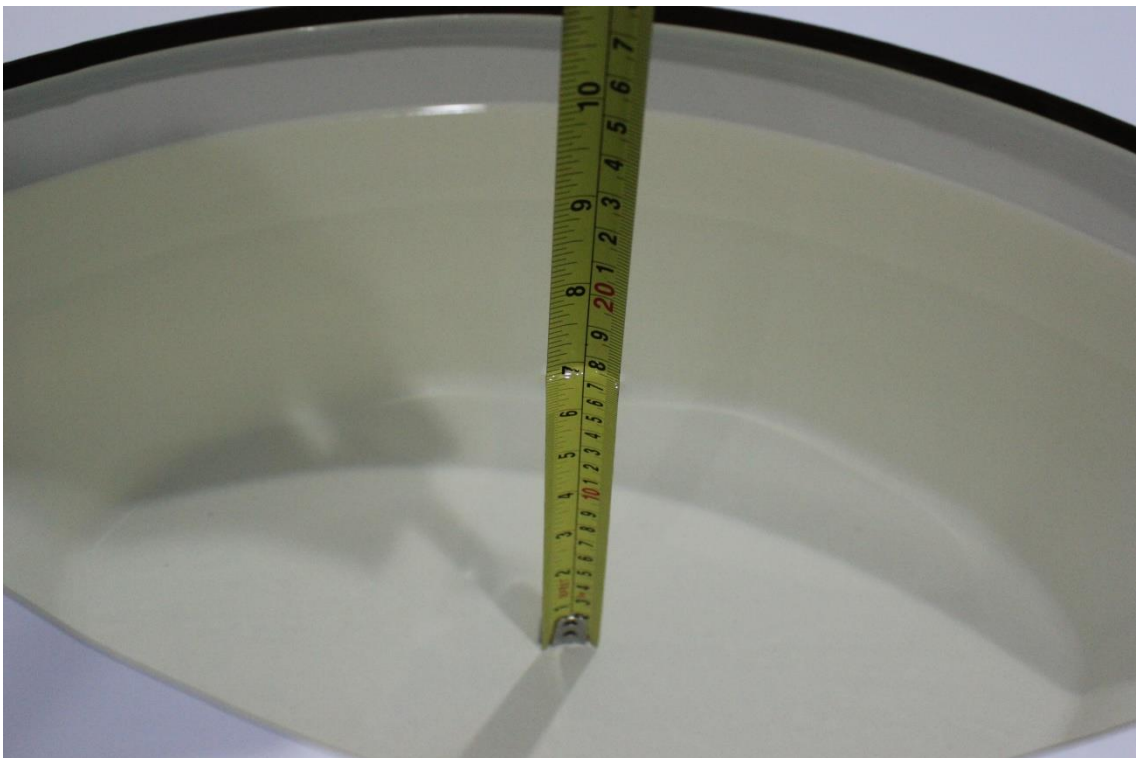

Picture 8-9 Liquid depth in the Head Phantom (5GHz)



Picture 8-9 Liquid depth in the Head Phantom (6GHz)

9 System verification

9.1 System Setup

In the simplified setup for system evaluation, the DUT is replaced by a calibrated dipole and the power source is replaced by a continuous wave that comes from a signal generator. The calibrated dipole must be placed beneath the flat phantom section of the SAM twin phantom with the correct distance holder. The distance holder should touch the phantom surface with a light pressure at the reference marking and be oriented parallel to the long side of the phantom. The equipment setup is shown below:

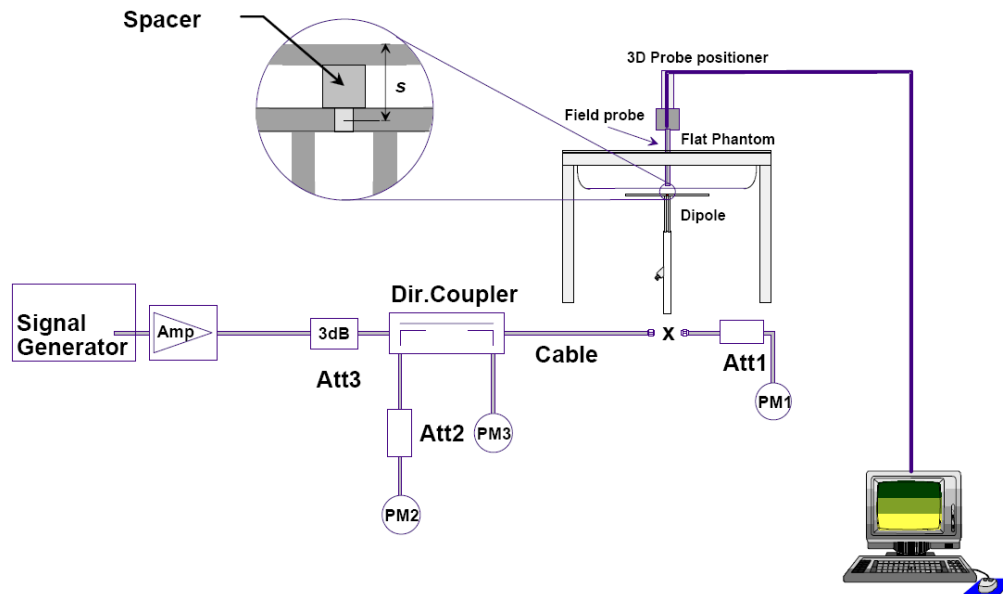

Picture 9.1 System Setup for System Evaluation

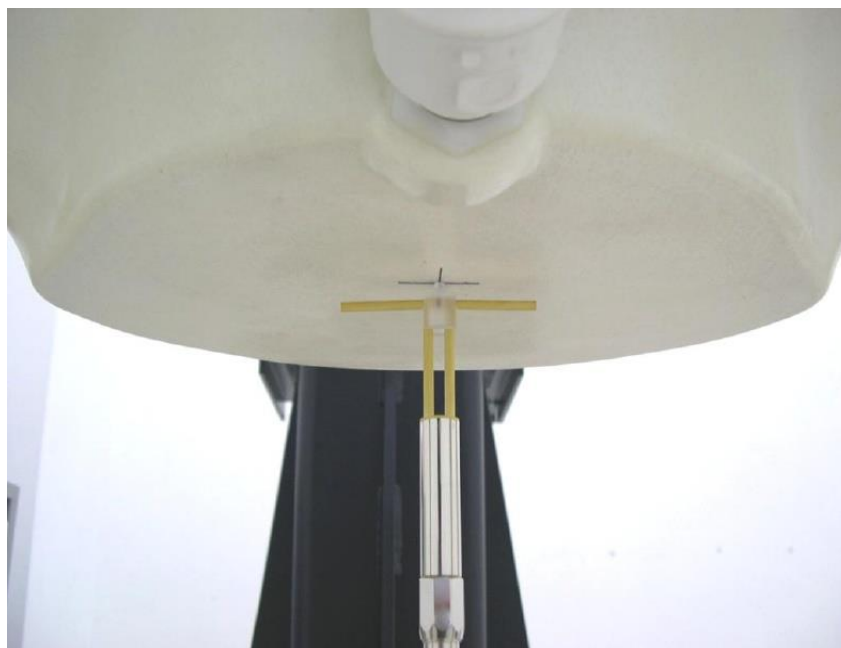

Picture 9.2 Photo of Dipole Setup

9.2 System Verification

SAR system verification is required to confirm measurement accuracy, according to the tissue dielectric media, probe calibration points and other system operating parameters required for measuring the SAR of a test device. The system verification must be performed for each frequency band and within the valid range of each probe calibration point required for testing the device.

The system verification results are required that the area scan estimated 1-g SAR is within 3% of the zoom scan 1-g SAR. The details are presented in annex B.

Table 9.1: System Verification of Head

Measurement Date (yyyy-mm-dd)	Frequency	Target value (W/kg)		Measured value(W/kg)		Deviation	
		10 g Average	1 g Average	10 g Average	1 g Average	10 g Average	1 g Average
2022-6-8	750 MHz	5.65	8.68	5.48	8.08	-3.01%	-6.91%
2022-6-10	835 MHz	6.24	9.63	6.12	9.24	-1.92%	-4.05%
2022-6-9	1750 MHz	19.4	36.9	19.5	36.8	0.41%	-0.27%
2022-6-11	1900 MHz	20.9	40.1	20.7	40.0	-1.05%	-0.25%
2022-8-9	2450 MHz	24.9	53.3	24.3	52.8	-2.33%	-0.94%
2022-6-17	3500 MHz	25.2	67.3	25.4	66.8	0.79%	-0.74%
2022-6-18	3700 MHz	24.3	67.1	24.6	67.3	1.23%	0.30%
2022-6-19	3900 MHz	24.1	69.3	24.5	68.5	1.66%	-1.15%
2022-6-21	5250 MHz	22.7	79.5	22.1	76.7	-2.64%	-3.52%
2022-6-22	5600 MHz	23.1	80.9	22.1	76.7	-4.33%	-5.19%
2022-6-23	5750 MHz	23.9	84.4	23.2	80.5	-2.93%	-4.62%
2022-6-24	6500 MHz	22.8	81.2	22.4	78.3	-1.75%	-3.57%
2022-8-26	5800 MHz	23.1	82.0	21.3	76.9	-7.79%	-6.22%

9.3 PD System Performance Check Results

The system was verified to be within ± 0.66 dB of the power density targets on the calibration certificate according to the test system specification in the user's manual and calibration facility recommendation. The 0.66 dB deviation threshold represents the expanded uncertainty for system performance checks using SPEAG's mmWave verification sources. The same spatial resolution and measurement region used in the source calibration was applied during the system check. The measured power density distribution of verification source was also confirmed through visual inspection to have no noticeable differences, both spatially (shape) and numerically (level) from the distribution provided by the manufacturer, per November 2017 TCBC Workshop Notes.

Date	Frequency (GHz)	5G Verification Source	Probe S/N	Distance (mm)	Measured 4cm ² (W/m ²)	Targeted 4cm ² (W/m ²)	Deviation (db)
2022/6/30	10G	10GHz_1005	9448	10	51.2	49.4	0.035

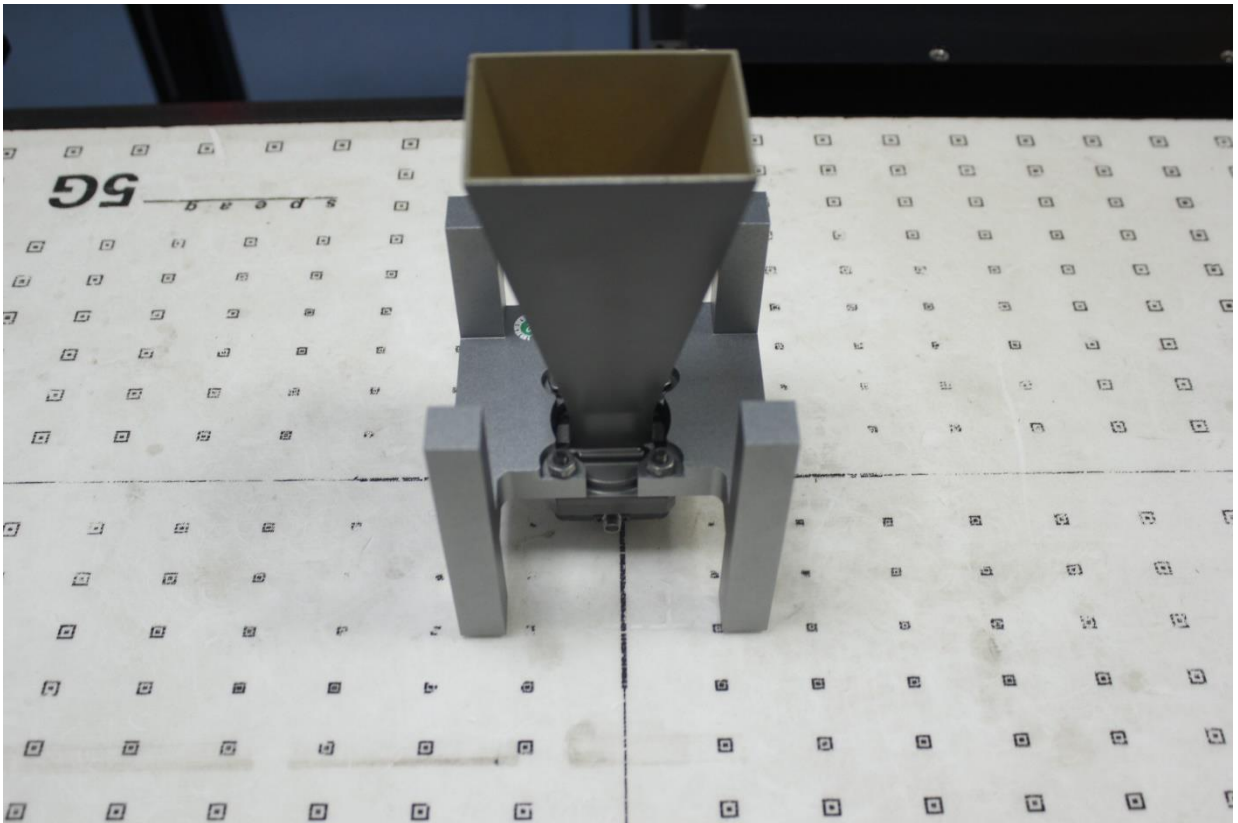

Picture 9.3 System Setup for System Evaluation

10 Measurement Procedures

10.1 Tests to be performed

In order to determine the highest value of the peak spatial-average SAR of a handset, all device positions, configurations and operational modes shall be tested for each frequency band according to steps 1 to 3 below. A flowchart of the test process is shown in picture 9.1.

Step 1: The tests described in 9.2 shall be performed at the channel that is closest to the centre of the transmit frequency band (f_c) for:

- a) all device positions (cheek and tilt, for both left and right sides of the SAM phantom, as described in annex D),
- b) all configurations for each device position in a), e.g., antenna extended and retracted, and
- c) all operational modes, e.g., analogue and digital, for each device position in a) and configuration in b) in each frequency band.

If more than three frequencies need to be tested according to 11.1 (i.e., $N_c > 3$), then all frequencies, configurations and modes shall be tested for all of the above test conditions.

Step 2: For the condition providing highest peak spatial-average SAR determined in Step 1, perform all tests described in 9.2 at all other test frequencies, i.e., lowest and highest frequencies. In addition, for all other conditions (device position, configuration and operational mode) where the peak spatial-average SAR value determined in Step 1 is within 3 dB of the applicable SAR limit, it is recommended that all other test frequencies shall be tested as well.

Step 3: Examine all data to determine the highest value of the peak spatial-average SAR found in Steps 1 to 2.

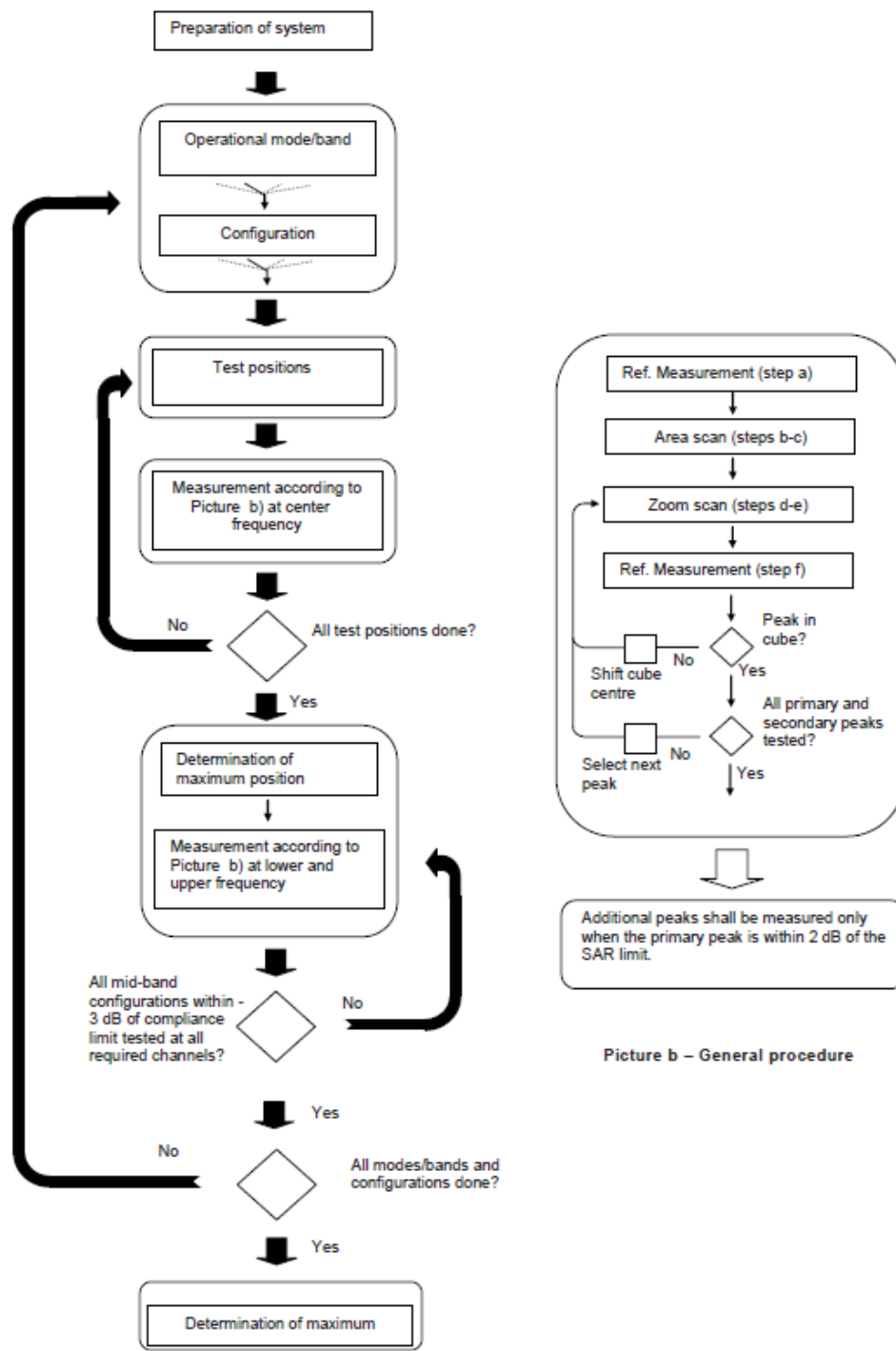

Picture 10.1 Block diagram of the tests to be performed

10.2 General Measurement Procedure

The area and zoom scan resolutions specified in the table below must be applied to the SAR measurements and fully documented in SAR reports to qualify for TCB approval. Probe boundary effect error compensation is required for measurements with the probe tip closer than half a probe tip diameter to the phantom surface. Both the probe tip diameter and sensor offset distance must satisfy measurement protocols; to ensure probe boundary effect errors are minimized and the higher fields closest to the phantom surface can be correctly measured and extrapolated to the phantom surface for computing 1-g SAR. Tolerances of the post-processing algorithms must be verified by the test laboratory for the scan resolutions used in the SAR measurements, according to the reference distribution functions specified in IEEE Std 1528-2013. The results should be documented as part of the system validation records and may be requested to support test results when all the measurement parameters in the following table are not satisfied.

		≤ 3 GHz	> 3 GHz
Maximum distance from closest measurement point (geometric center of probe sensors) to phantom surface		5 ± 1 mm	$\frac{1}{2} \cdot \delta \cdot \ln(2) \pm 0.5$ mm
Maximum probe angle from probe axis to phantom surface normal at the measurement location		$30^\circ \pm 1^\circ$	$20^\circ \pm 1^\circ$
Maximum area scan spatial resolution: $\Delta x_{Area}, \Delta y_{Area}$		≤ 2 GHz: ≤ 15 mm 2 – 3 GHz: ≤ 12 mm	3 – 4 GHz: ≤ 12 mm 4 – 6 GHz: ≤ 10 mm
		When the x or y dimension of the test device, in the measurement plane orientation, is smaller than the above, the measurement resolution must be \leq the corresponding x or y dimension of the test device with at least one measurement point on the test device.	
Maximum zoom scan spatial resolution: $\Delta x_{Zoom}, \Delta y_{Zoom}$		≤ 2 GHz: ≤ 8 mm 2 – 3 GHz: ≤ 5 mm*	3 – 4 GHz: ≤ 5 mm* 4 – 6 GHz: ≤ 4 mm*
Maximum zoom scan spatial resolution, normal to phantom surface	uniform grid: $\Delta z_{Zoom}(n)$	≤ 5 mm	3 – 4 GHz: ≤ 4 mm 4 – 5 GHz: ≤ 3 mm 5 – 6 GHz: ≤ 2 mm
	graded grid	$\Delta z_{Zoom}(1)$: between 1 st two points closest to phantom surface	≤ 4 mm
		$\Delta z_{Zoom}(n>1)$: between subsequent points	$\leq 1.5 \cdot \Delta z_{Zoom}(n-1)$
Minimum zoom scan volume	x, y, z	≥ 30 mm	3 – 4 GHz: ≥ 28 mm 4 – 5 GHz: ≥ 25 mm 5 – 6 GHz: ≥ 22 mm
Note: δ is the penetration depth of a plane-wave at normal incidence to the tissue medium; see draft standard IEEE P1528-2011 for details. * When zoom scan is required and the <i>reported</i> SAR from the area scan based 1-g SAR estimation procedures of KDB 447498 is ≤ 1.4 W/kg, ≤ 8 mm, ≤ 7 mm and ≤ 5 mm zoom scan resolution may be applied, respectively, for 2 GHz to 3 GHz, 3 GHz to 4 GHz and 4 GHz to 6 GHz.			

10.4 SAR Measurement for LTE

SAR tests for LTE are performed with a base station simulator, Rohde & Schwarz CMW500. Closed loop power control was used so the UE transmits with maximum output power during SAR testing. All powers were measured with the CMW 500.

It is performed for conducted power and SAR based on the KDB941225 D05.

SAR is evaluated separately according to the following procedures for the different test positions in each exposure condition – head, body, body-worn accessories and other use conditions. The procedures in the following subsections are applied separately to test each LTE frequency band.

1) QPSK with 1 RB allocation

Start with the largest channel bandwidth and measure SAR for QPSK with 1 RB allocation, using the RB offset and required test channel combination with the highest maximum output power among RB offsets at the upper edge, middle and lower edge of each required test channel. When the reported SAR is ≤ 0.8 W/kg, testing of the remaining RB offset configurations and required test channels is not required for 1 RB allocation; otherwise, SAR is required for the remaining required test channels and only for the RB offset configuration with the highest output power for that channel. When the reported SAR of a required test channel is > 1.45 W/kg, SAR is required for all three RB offset configurations for that required test channel.

2) QPSK with 50% RB allocation

The procedures required for 1 RB allocation in 1) are applied to measure the SAR for QPSK with 50% RB allocation.

3) QPSK with 100% RB allocation

For QPSK with 100% RB allocation, SAR is not required when the highest maximum output power for 100 % RB allocation is less than the highest maximum output power in 50% and 1 RB allocations and the highest reported SAR for 1 RB and 50% RB allocation in 1) and 2) are ≤ 0.8 W/kg. Otherwise, SAR is measured for the highest output power channel; and if the reported SAR is > 1.45 W/kg, the remaining required test channels must also be tested.

TDD test:

TDD testing is performed using guidance from FCC KDB 941225 D05 v02r05 and the SAR test guidance provided in April 2013 TCB works hop notes. TDD is tested at the highest duty factor using UL-DL configuration 0 with special subframe configuration 6 and applying the FDD LTE procedures in KDB 941225 D05 v02r05. SAR testing is performed using the extended cyclic prefix listed in 3GPP TS 36.211.

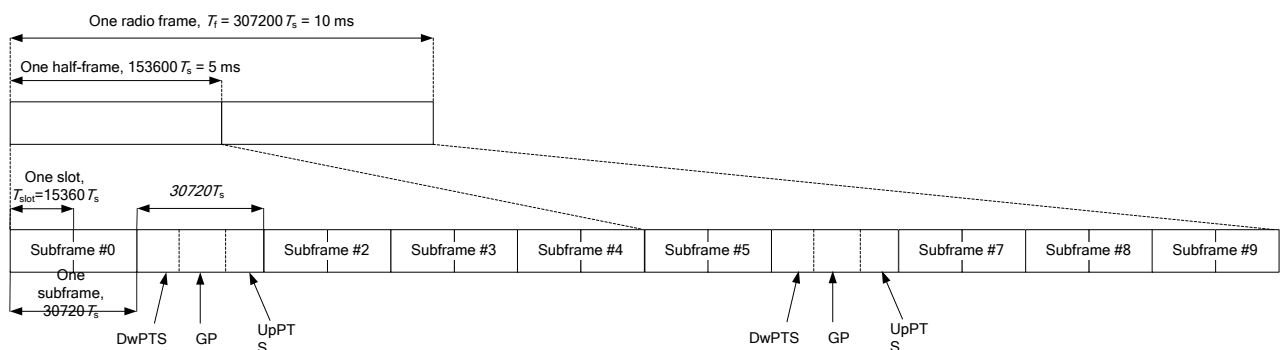

Figure 10.2: Frame structure type 2 (for 5 ms switch-point periodicity)

Table 10.1: Configuration of special subframe (lengths of DwPTS/GP/UpPTS)

Special subframe configuration	Normal cyclic prefix in downlink			Extended cyclic prefix in downlink		
	DwPTS	UpPTS		DwPTS	UpPTS	
		Normal cyclic prefix in uplink	Extended cyclic prefix in uplink		Normal cyclic prefix in uplink	Extended cyclic prefix in uplink
0	$6592 \cdot T_s$	$2192 \cdot T_s$	$2560 \cdot T_s$	$7680 \cdot T_s$	$2192 \cdot T_s$	$2560 \cdot T_s$
1	$19760 \cdot T_s$			$20480 \cdot T_s$		
2	$21952 \cdot T_s$			$23040 \cdot T_s$		
3	$24144 \cdot T_s$			$25600 \cdot T_s$		
4	$26336 \cdot T_s$	$4384 \cdot T_s$	$5120 \cdot T_s$	$7680 \cdot T_s$	$4384 \cdot T_s$	$5120 \cdot T_s$
5	$6592 \cdot T_s$			$20480 \cdot T_s$		
6	$19760 \cdot T_s$			$23040 \cdot T_s$		
7	$21952 \cdot T_s$			$12800 \cdot T_s$		
8	$24144 \cdot T_s$			-	-	-
9	$13168 \cdot T_s$			-	-	-

Table 10.2: Uplink-downlink configurations

Uplink-downlink configuration	Downlink-to-Uplink Switch-point periodicity	Subframe number									
		0	1	2	3	4	5	6	7	8	9
0	5 ms	D	S	U	U	U	D	S	U	U	U
1	5 ms	D	S	U	U	D	D	S	U	U	D
2	5 ms	D	S	U	D	D	D	S	U	D	D
3	10 ms	D	S	U	U	U	D	D	D	D	D
4	10 ms	D	S	U	U	D	D	D	D	D	D
5	10 ms	D	S	U	D	D	D	D	D	D	D
6	5 ms	D	S	U	U	U	D	S	U	U	D

Duty factor is calculated by:

$$\begin{aligned}
 \text{Duty factor} &= \text{uplink frame} \cdot 6 + \text{UpPTS} \cdot 2 / \text{one frame length} \\
 &= (30720 \cdot T_s \cdot 6 + 5120 \cdot T_s \cdot 2) / 307200 \cdot T_s \\
 &= 0.633
 \end{aligned}$$

According to the KDB 447498 D01, SAR should be evaluated at more than 3 frequencies for devices supporting transmit bands wider than 100MHz. Oct.2014 FCC-TCB conference notes (Dec. 2014 rev.) specifies the 5 test channels to use for 3GPP band 41 SAR evaluation.

10.5 Bluetooth & Wi-Fi Measurement Procedures for SAR

Normal network operating configurations are not suitable for measuring the SAR of 802.11 transmitters in general. Unpredictable fluctuations in network traffic and antenna diversity conditions can introduce undesirable variations in SAR results. The SAR for these devices should be measured using chipset based test mode software to ensure that the results are consistent and reliable.

Chipset based test mode software is hardware dependent and generally varies among manufacturers. The device operating parameters established in a test mode for SAR measurements must be identical to those programmed in production units, including output power levels, amplifier gain settings and other RF performance tuning parameters. The test frequencies should correspond to actual channel frequencies defined for domestic use. SAR for devices with switched diversity should be measured with only one antenna transmitting at a time during each SAR measurement, according to a fixed modulation and data rate. The same data pattern should be used for all measurements.

10.6 Power Drift

To control the output power stability during the SAR test, DASY4 system calculates the power drift by measuring the E-field at the same location at the beginning and at the end of the measurement for each test position. These drift values can be found in section 14 labeled as: (Power Drift [dB]). This ensures that the power drift during one measurement is within 5%.

11 Area Scan Based 1-g SAR

11.1 Requirement of KDB

According to the KDB447498 D01 v06, when the implementation is based the specific polynomial fit

algorithm as presented at the 29th Bioelectromagnetics Society meeting (2007) and the estimated 1-gSAR is ≤ 1.2 W/kg, a zoom scan measurement is not required provided it is also not needed for any other purpose; for example, if the peak SAR location required for simultaneous transmission SAR test exclusion can be determined accurately by the SAR system or manually to discriminate between distinctive peaks and scattered noisy SAR distributions from area scans.

There must not be any warning or alert messages due to various measurement concerns identified by the SAR system; for example, noise in measurements, peaks too close to scan boundary, peaks are too sharp, spatial resolution and uncertainty issues etc. The SAR system verification must also demonstrate that the area scan estimated 1-g SAR is within 3% of the zoom scan 1-g SAR (See Annex B). When all the SAR results for each exposure condition in a frequency band and wireless mode are based on estimated 1-g SAR, the 1-g SAR for the highest SAR configuration must be determined by a zoom scan.

11.2 Fast SAR Algorithms

The approach is based on the area scan measurement applying a frequency dependent attenuation parameter. This attenuation parameter was empirically determined by analyzing a large number of phones. The MOTOROLA FAST SAR was developed and validated by the MOTOROLA Research Group in Ft. Lauderdale.

In the initial study, an approximation algorithm based on Linear fit was developed. The accuracy of the algorithm has been demonstrated across a broad frequency range (136-2450 MHz) and for both 1- and 10-g averaged SAR using a sample of 264 SAR measurements from 55 wireless handsets. For the sample size studied, the root-mean-squared errors of the algorithm are 1.2% and 5.8% for 1- and 10-g averaged SAR, respectively. The paper describing the algorithm in detail is expected to be published in August 2004 within the Special Issue of Transactions on MTT.

In the second step, the same research group optimized the fitting algorithm to an Polynomial fit whereby the frequency validity was extended to cover the range 30-6000MHz. Details of this study can be found in the BEMS 2007 Proceedings.

Both algorithms are implemented in DASYS software.

12 Conducted Output Power

All conducted power measurements for 3G/4G WWAN technologies and bands in this section were performed by setting Reserve_power_margin (Qualcomm® Smart Transmit EFS entry) to 0dB, so that the EUT transmits continuously at minimum (Plimit, maximum tune up output power Pmax).The details of test scenarios categorization in the table below

Sensor deactive (Body scenario)	Sensor active (Body scenario)
DSI1	DSI0

12.1 WCDMA Measurement result

WCDMA1900(DSI 1)

Item	band	FDDII result			
	ARFCN	9538 (1907.6MHz)	9400 (1880MHz)	9262 (1852.4MHz)	Tune up
WCDMA	\	22.19	22.42	22.35	24.00
HSUPA	1	20.98	21.19	20.90	22.00
	2	18.21	18.35	18.02	20.00
	3	20.29	20.46	20.41	21.00
	4	18.19	18.38	18.09	20.00
	5	20.21	20.40	20.30	22.00
HSPA+	/	19.78	19.94	19.91	20.50
DC-HSDPA	1	19.39	19.47	19.21	20.50
	2	19.32	19.57	19.27	20.50
	3	18.87	19.08	18.76	20.00
	4	19.17	19.56	19.55	20.50

WCDMA1900(DSI 0)

Item	band	FDDII result			
	ARFCN	9538 (1907.6MHz)	9400 (1880MHz)	9262 (1852.4MHz)	Tune up
WCDMA	\	14.12	14.06	14.08	16.00
HSUPA	1	13.35	13.48	13.30	14.00
	2	11.59	11.68	11.47	13.00
	3	12.91	13.02	12.99	14.00
	4	11.57	11.70	11.51	12.00
	5	12.86	12.98	12.92	14.00
HSPA+	/	12.59	12.69	12.67	14.00
DC-HSDPA	1	12.34	12.39	12.22	14.00
	2	12.29	12.45	12.26	14.00
	3	12.01	12.14	11.94	13.50
	4	12.2	12.45	12.44	13.50

WCDMA850(DSI 1)

Item	band	FDDV result			
	ARFCN	4233 (846.6MHz)	4183 (836.6MHz)	4132 (826.4MHz)	Tune up
WCDMA	\	22.47	22.55	22.50	24.00
HSUPA	1	21.47	21.45	21.46	22.50
	2	19.41	19.50	19.45	20.50
	3	20.42	20.49	20.39	21.50
	4	19.36	19.37	19.44	20.50
	5	21.34	21.37	21.44	22.50
HSPA+	/	20.87	20.90	21.05	22.00
DC-HSDPA	1	21.36	21.41	21.39	22.50
	2	21.37	21.38	21.40	22.50
	3	20.87	20.89	20.88	22.00
	4	20.89	20.91	20.87	22.00

WCDMA850(DSI 0)

Item	band	FDDV result			
	ARFCN	4233 (846.6MHz)	4183 (836.6MHz)	4132 (826.4MHz)	Tune up
WCDMA	\	18.17	18.19	18.10	19.50
HSUPA	1	17.36	17.35	17.35	18.50
	2	15.7	15.77	15.73	17.00
	3	16.51	16.57	16.49	18.00
	4	15.66	15.66	15.72	17.00
	5	17.26	17.28	17.34	18.50
HSPA+	/	16.88	16.90	17.02	18.00
DC-HSDPA	1	17.27	17.31	17.30	18.50
	2	17.28	17.29	17.30	18.50
	3	16.88	16.89	16.88	18.00
	4	16.89	16.91	16.88	18.00

12.2 LTE Measurement result

The tune up for LTE–DS11

Band	Tune up
LTE Band 2	25
LTE Band 4	25
LTE Band 5	25
LTE Band 12	24
LTE Band 13	25
LTE Band 48	25
LTE Band 66	25

The tune up for LTE–DS10

Band	Tune up
LTE Band 2	14.5
LTE Band 4	19.5
LTE Band 5	16
LTE Band 12	21
LTE Band 13	16.5
LTE Band 48	16.5
LTE Band 66	15.5

Maximum Power Reduction (MPR) for LTE—DS11

Modulation	Channel bandwidth / Transmission bandwidth configuration [RB]						MPR (dB)
	1.4	3	5	10	15	20	
	MHz	MHz	MHz	MHz	MHz	MHz	
QPSK	> 5	> 4	> 8	> 12	> 16	> 18	1
16 QAM	≤ 5	≤ 4	≤ 8	≤ 12	≤ 16	≤ 18	1
16 QAM	> 5	> 4	> 8	> 12	> 16	> 18	2
64 QAM	≤ 5	≤ 4	≤ 8	≤ 12	≤ 16	≤ 18	2
64 QAM	> 5	> 4	> 8	> 12	> 16	> 18	3
256 QAM	≤ 5	≤ 4	≤ 8	≤ 12	≤ 16	≤ 18	4
256 QAM	> 5	> 4	> 8	> 12	> 16	> 18	5

Maximum Power Reduction (MPR) for LTE—DS10

Modulation	Channel bandwidth / Transmission bandwidth configuration [RB]						MPR (dB)
	1.4	3	5	10	15	20	
	MHz	MHz	MHz	MHz	MHz	MHz	
QPSK	> 5	> 4	> 8	> 12	> 16	> 18	0
16 QAM	≤ 5	≤ 4	≤ 8	≤ 12	≤ 16	≤ 18	0
16 QAM	> 5	> 4	> 8	> 12	> 16	> 18	0
64 QAM	≤ 5	≤ 4	≤ 8	≤ 12	≤ 16	≤ 18	0
64 QAM	> 5	> 4	> 8	> 12	> 16	> 18	0
256 QAM	≤ 5	≤ 4	≤ 8	≤ 12	≤ 16	≤ 18	0
256 QAM	> 5	> 4	> 8	> 12	> 16	> 18	0

LTE Band2 DS11

BANDWIDTH	Number of RBs	Frequency	QPSK	16QAM	64QAM	256QAM
1.4MHz	1RB-High (5)	1909.3 (19193)	23.09	22.26	22.23	19.92
		1880 (18900)	23.19	22.57	21.50	19.27
		1850.7 (18607)	23.13	22.46	21.51	19.28
	1RB-Middle (3)	1909.3 (19193)	23.10	22.33	22.27	19.96
		1880 (18900)	23.22	22.53	21.56	19.32
		1850.7 (18607)	23.27	22.52	21.50	19.27
	1RB-Low (0)	1909.3 (19193)	23.01	22.44	22.22	19.91
		1880 (18900)	23.09	22.39	21.64	19.39
		1850.7 (18607)	23.15	22.53	21.40	19.18
	3RB-High (3)	1909.3 (19193)	23.08	22.17	22.19	19.89
		1880 (18900)	23.17	22.31	21.41	19.19
		1850.7 (18607)	23.26	22.26	21.35	19.13
	3RB-Middle (1)	1909.3 (19193)	23.09	22.22	22.29	19.98
		1880 (18900)	23.25	22.33	21.42	19.20
		1850.7 (18607)	23.26	22.29	21.41	19.19
	3RB-Low (0)	1909.3 (19193)	23.07	22.11	22.25	19.94
		1880 (18900)	23.22	22.38	21.35	19.13
		1850.7 (18607)	23.21	22.33	21.37	19.15
	6RB (0)	1909.3 (19193)	22.13	21.19	20.50	18.37
		1880 (18900)	22.22	21.37	20.30	18.19
		1850.7 (18607)	22.30	21.35	20.22	18.12
3MHz	1RB-High (14)	1908.5 (19185)	23.22	22.54	21.25	19.04
		1880 (18900)	23.24	22.57	21.40	19.18
		1851.5 (18615)	23.30	22.56	21.50	19.27
	1RB-Middle (7)	1908.5 (19185)	23.19	22.39	21.40	19.18
		1880 (18900)	23.25	22.63	21.54	19.30
		1851.5 (18615)	23.23	22.63	21.51	19.28
	1RB-Low (0)	1908.5 (19185)	23.13	22.46	21.39	19.17
		1880 (18900)	23.12	22.48	21.43	19.20
		1851.5 (18615)	23.22	22.49	21.56	19.32
	8RB-High (7)	1908.5 (19185)	22.20	21.31	20.28	18.17
		1880 (18900)	22.33	21.38	20.42	18.30
		1851.5 (18615)	22.32	21.45	20.39	18.27
	8RB-Middle (4)	1908.5 (19185)	22.24	21.31	20.34	18.23
		1880 (18900)	22.35	21.44	20.44	18.32
		1851.5 (18615)	22.36	21.50	20.41	18.29
	8RB-Low (0)	1908.5 (19185)	22.22	21.32	20.31	18.20
		1880 (18900)	22.25	21.32	20.36	18.25
		1851.5 (18615)	22.33	21.47	20.38	18.26
	15RB (0)	1908.5 (19185)	22.21	21.28	20.26	18.16
		1880 (18900)	22.29	21.34	20.30	18.19
		1851.5 (18615)	22.36	21.38	20.42	18.30

5MHz	1RB-High (24)	1907.5 (19175)	23.15	22.42	22.35	19.72	
		1880 (18900)	23.29	22.64	22.52	19.87	
		1852.5 (18625)	23.27	22.53	22.58	19.93	
	1RB-Middle (12)	1907.5 (19175)	23.15	22.50	22.31	19.68	
		1880 (18900)	23.20	22.63	22.49	19.84	
		1852.5 (18625)	23.21	22.52	22.45	19.81	
	1RB-Low (0)	1907.5 (19175)	23.09	22.36	22.39	19.76	
		1880 (18900)	23.17	22.43	22.43	19.79	
		1852.5 (18625)	23.24	22.56	22.44	19.80	
	12RB-High (13)	1907.5 (19175)	22.23	21.26	21.26	19.05	
		1880 (18900)	22.36	21.36	21.32	19.11	
		1852.5 (18625)	22.37	21.40	21.36	19.14	
	12RB-Middle (6)	1907.5 (19175)	22.23	21.31	21.26	19.05	
		1880 (18900)	22.23	21.35	21.25	19.04	
		1852.5 (18625)	22.40	21.46	21.38	19.16	
	12RB-Low (0)	1907.5 (19175)	22.18	21.27	21.20	19.00	
		1880 (18900)	22.21	21.35	21.21	19.01	
		1852.5 (18625)	22.32	21.29	21.35	19.13	
	25RB (0)	1907.5 (19175)	22.22	21.24	21.20	19.00	
		1880 (18900)	22.23	21.34	21.26	19.05	
		1852.5 (18625)	22.31	21.39	21.33	19.12	
	10MHz	1RB-High (49)	1905 (19150)	23.11	22.53	22.40	19.76
			1880 (18900)	23.23	22.56	21.43	19.20
			1855 (18650)	23.21	22.61	21.38	19.16
1RB-Middle (24)		1905 (19150)	23.21	22.37	22.37	19.74	
		1880 (18900)	23.21	22.67	21.49	19.26	
		1855 (18650)	23.17	22.58	21.37	19.15	
1RB-Low (0)		1905 (19150)	23.04	22.53	22.70	19.83	
		1880 (18900)	23.07	22.70	21.38	19.16	
		1855 (18650)	23.20	22.63	21.58	19.34	
25RB-High (25)		1905 (19150)	22.33	21.37	21.25	19.04	
		1880 (18900)	22.37	21.42	20.42	18.30	
		1855 (18650)	22.36	21.36	20.33	18.22	
25RB-Middle (12)		1905 (19150)	22.22	21.18	21.26	19.05	
		1880 (18900)	22.25	21.23	20.32	18.21	
		1855 (18650)	22.37	21.42	20.41	18.29	
25RB-Low (0)		1905 (19150)	22.17	21.22	21.17	18.97	
		1880 (18900)	22.28	21.32	20.19	18.09	
		1855 (18650)	22.33	21.37	20.42	18.30	
50RB (0)		1905 (19150)	22.14	21.24	20.01	18.03	
		1880 (18900)	22.21	21.33	20.24	18.14	
		1855 (18650)	22.40	21.44	20.47	18.34	

15MHz	1RB-High (74)	1902.5 (19125)	23.10	22.43	22.35	19.72
		1880 (18900)	23.25	22.55	22.30	19.67
		1857.5 (18675)	23.23	22.49	22.33	19.70
	1RB-Middle (37)	1902.5 (19125)	23.14	22.53	22.40	19.76
		1880 (18900)	23.24	22.46	22.45	19.81
		1857.5 (18675)	23.26	22.41	22.44	19.80
	1RB-Low (0)	1902.5 (19125)	23.12	22.52	22.43	19.79
		1880 (18900)	23.19	22.54	22.28	19.97
		1857.5 (18675)	23.26	22.58	22.26	19.95
	36RB-High (38)	1902.5 (19125)	22.26	21.28	21.38	19.16
		1880 (18900)	22.43	21.40	21.41	19.19
		1857.5 (18675)	22.36	21.41	21.32	19.11
	36RB-Middle (19)	1902.5 (19125)	22.30	21.31	21.37	19.15
		1880 (18900)	22.30	21.33	21.38	19.16
		1857.5 (18675)	22.38	21.37	21.33	19.12
	36RB-Low (0)	1902.5 (19125)	22.18	21.21	21.19	18.99
		1880 (18900)	22.35	21.31	21.20	19.00
		1857.5 (18675)	22.22	21.35	21.36	19.14
	75RB (0)	1902.5 (19125)	22.20	21.28	21.27	19.06
		1880 (18900)	22.30	21.37	21.34	19.12
		1857.5 (18675)	22.32	21.37	21.41	19.19
20MHz	1RB-High (99)	1900 (19100)	23.33	22.65	21.66	19.41
		1880 (18900)	23.46	22.71	21.57	19.33
		1860 (18700)	23.40	22.83	21.80	19.54
	1RB-Middle (50)	1900 (19100)	23.32	22.61	21.66	19.41
		1880 (18900)	23.39	22.56	21.55	19.31
		1860 (18700)	23.38	22.79	21.64	19.39
	1RB-Low (0)	1900 (19100)	23.44	22.73	21.63	19.38
		1880 (18900)	23.51	22.72	21.67	19.42
		1860 (18700)	23.41	22.80	21.66	19.41
	50RB-High (50)	1900 (19100)	22.50	21.60	20.58	18.44
		1880 (18900)	22.58	21.62	20.63	18.49
		1860 (18700)	22.54	21.59	20.65	18.51
	50RB-Middle (25)	1900 (19100)	22.53	21.59	20.60	18.46
		1880 (18900)	22.54	21.47	20.52	18.39
		1860 (18700)	22.55	21.66	20.68	18.53
	50RB-Low (0)	1900 (19100)	22.46	21.50	20.50	18.37
		1880 (18900)	22.48	21.55	20.50	18.37
		1860 (18700)	22.49	21.55	20.47	18.34
	100RB (0)	1900 (19100)	22.47	21.49	20.45	18.33
		1880 (18900)	22.50	21.42	20.49	18.36
		1860 (18700)	22.55	21.56	20.59	18.45

LTE Band2 DS10

BANDWIDTH	Number of RBs	Frequency	QPSK	16QAM	64QAM	256QAM
1.4MHz	1RB-High (5)	1909.3 (19193)	13.37	13.64	13.60	13.64
		1880 (18900)	13.37	13.74	13.69	13.73
		1850.7 (18607)	13.41	13.76	13.63	13.67
	1RB-Middle (3)	1909.3 (19193)	13.41	13.77	13.43	13.47
		1880 (18900)	13.52	13.81	13.82	13.86
		1850.7 (18607)	13.47	13.76	13.66	13.70
	1RB-Low (0)	1909.3 (19193)	13.29	13.65	12.58	12.62
		1880 (18900)	13.43	13.83	13.60	13.64
		1850.7 (18607)	13.32	13.77	13.56	13.60
	3RB-High (3)	1909.3 (19193)	13.37	13.29	13.45	13.49
		1880 (18900)	13.49	13.55	13.24	13.28
		1850.7 (18607)	13.53	13.56	13.65	13.69
	3RB-Middle (1)	1909.3 (19193)	13.39	13.52	13.51	13.55
		1880 (18900)	13.61	13.68	13.59	13.63
		1850.7 (18607)	13.54	13.62	13.65	13.69
	3RB-Low (0)	1909.3 (19193)	13.34	13.49	13.43	13.47
		1880 (18900)	13.51	13.57	13.58	13.62
		1850.7 (18607)	13.39	13.64	13.68	13.72
	6RB (0)	1909.3 (19193)	13.45	13.48	13.39	13.43
		1880 (18900)	13.54	13.62	13.41	13.45
		1850.7 (18607)	13.51	13.55	13.41	13.45
3MHz	1RB-High (14)	1908.5 (19185)	13.44	13.80	13.67	13.71
		1880 (18900)	13.63	13.88	13.14	13.18
		1851.5 (18615)	13.46	13.85	13.71	13.75
	1RB-Middle (7)	1908.5 (19185)	13.35	13.73	13.60	13.64
		1880 (18900)	13.51	13.74	13.81	13.85
		1851.5 (18615)	13.47	13.81	13.73	13.77
	1RB-Low (0)	1908.5 (19185)	13.40	13.77	13.53	13.57
		1880 (18900)	13.47	13.72	13.72	13.76
		1851.5 (18615)	13.51	13.85	13.68	13.72
	8RB-High (7)	1908.5 (19185)	13.52	13.49	13.74	13.78
		1880 (18900)	13.61	13.72	13.70	13.74
		1851.5 (18615)	13.62	13.65	13.63	13.67
	8RB-Middle (4)	1908.5 (19185)	13.52	13.58	13.56	13.60
		1880 (18900)	13.61	13.61	13.62	13.66
		1851.5 (18615)	13.67	13.64	13.65	13.69
	8RB-Low (0)	1908.5 (19185)	13.52	13.57	13.43	13.47
		1880 (18900)	13.52	13.56	13.53	13.57
		1851.5 (18615)	13.57	13.66	13.55	13.59
	15RB (0)	1908.5 (19185)	13.47	13.49	13.46	13.50
		1880 (18900)	13.55	13.53	13.48	13.52
		1851.5 (18615)	13.60	13.63	13.55	13.59

5MHz	1RB-High (24)	1907.5 (19175)	13.43	13.72	13.52	13.56
		1880 (18900)	13.53	13.78	13.82	13.86
		1852.5 (18625)	13.57	13.76	13.71	13.75
	1RB-Middle (12)	1907.5 (19175)	13.46	13.80	13.56	13.60
		1880 (18900)	13.58	13.88	13.83	13.87
		1852.5 (18625)	13.58	13.79	13.75	13.79
	1RB-Low (0)	1907.5 (19175)	13.37	13.76	13.59	13.63
		1880 (18900)	13.47	13.79	13.73	13.77
		1852.5 (18625)	13.52	13.86	13.70	13.74
	12RB-High (13)	1907.5 (19175)	13.48	13.56	13.52	13.56
		1880 (18900)	13.58	13.62	13.57	13.61
		1852.5 (18625)	13.63	13.52	13.58	13.62
	12RB-Middle (6)	1907.5 (19175)	13.57	13.57	13.53	13.57
		1880 (18900)	13.59	13.53	13.58	13.62
		1852.5 (18625)	13.61	13.63	13.63	13.67
	12RB-Low (0)	1907.5 (19175)	13.50	13.51	13.44	13.48
		1880 (18900)	13.52	13.63	13.53	13.57
		1852.5 (18625)	13.60	13.61	13.47	13.51
	25RB (0)	1907.5 (19175)	13.48	13.48	13.54	13.58
		1880 (18900)	13.58	13.53	13.59	13.63
		1852.5 (18625)	13.61	13.60	13.61	13.65
10MHz	1RB-High (49)	1905 (19150)	13.33	13.70	13.58	13.62
		1880 (18900)	13.54	13.57	13.74	13.78
		1855 (18650)	13.48	13.85	13.61	13.65
	1RB-Middle (24)	1905 (19150)	13.41	13.74	13.51	13.55
		1880 (18900)	13.43	13.87	13.67	13.71
		1855 (18650)	13.46	13.76	13.68	13.72
	1RB-Low (0)	1905 (19150)	13.47	13.73	13.52	13.56
		1880 (18900)	13.47	13.74	13.50	13.54
		1855 (18650)	13.45	13.81	13.71	13.75
	25RB-High (25)	1905 (19150)	13.54	13.54	13.46	13.50
		1880 (18900)	13.64	13.62	13.50	13.54
		1855 (18650)	13.70	13.69	13.55	13.59
	25RB-Middle (12)	1905 (19150)	13.53	13.46	13.39	13.43
		1880 (18900)	13.62	13.62	13.41	13.45
		1855 (18650)	13.66	13.64	13.56	13.60
	25RB-Low (0)	1905 (19150)	13.38	13.41	13.49	13.53
		1880 (18900)	13.56	13.41	13.56	13.60
		1855 (18650)	13.53	13.50	13.46	13.50
	50RB (0)	1905 (19150)	13.45	13.48	13.05	13.09
		1880 (18900)	13.45	13.59	13.50	13.54
		1855 (18650)	13.60	13.53	13.42	13.46

15MHz	1RB-High (74)	1902.5 (19125)	13.36	13.54	13.29	13.33
		1880 (18900)	13.52	13.74	13.59	13.63
		1857.5 (18675)	13.41	13.69	13.58	13.62
	1RB-Middle (37)	1902.5 (19125)	13.40	13.85	13.52	13.56
		1880 (18900)	13.56	13.81	13.82	13.86
		1857.5 (18675)	13.46	13.79	13.71	13.75
	1RB-Low (0)	1902.5 (19125)	13.53	13.75	13.61	13.65
		1880 (18900)	13.43	13.78	13.70	13.74
		1857.5 (18675)	13.54	13.65	13.61	13.65
	36RB-High (38)	1902.5 (19125)	13.55	13.56	13.36	13.40
		1880 (18900)	13.68	13.68	13.61	13.65
		1857.5 (18675)	13.68	13.61	13.52	13.56
	36RB-Middle (19)	1902.5 (19125)	13.61	13.52	13.58	13.62
		1880 (18900)	13.60	13.63	13.49	13.53
		1857.5 (18675)	13.59	13.60	13.55	13.59
	36RB-Low (0)	1902.5 (19125)	13.50	13.43	13.45	13.49
		1880 (18900)	13.46	13.46	13.51	13.55
		1857.5 (18675)	13.49	13.54	13.50	13.54
	75RB (0)	1902.5 (19125)	13.46	13.52	13.61	13.65
		1880 (18900)	13.54	13.56	13.69	13.73
		1857.5 (18675)	13.56	13.59	13.46	13.50
20MHz	1RB-High (99)	1900 (19100)	13.47	13.46	13.21	13.25
		1880 (18900)	13.36	13.50	13.28	13.32
		1860 (18700)	13.30	13.48	13.32	13.36
	1RB-Middle (50)	1900 (19100)	13.33	13.43	13.26	13.30
		1880 (18900)	13.38	13.54	13.34	13.38
		1860 (18700)	13.24	13.31	13.30	13.34
	1RB-Low (0)	1900 (19100)	13.41	13.45	13.26	13.30
		1880 (18900)	13.32	13.35	13.27	13.31
		1860 (18700)	13.28	13.53	13.37	13.41
	50RB-High (50)	1900 (19100)	13.50	13.21	13.18	13.22
		1880 (18900)	13.48	13.29	13.28	13.32
		1860 (18700)	13.42	13.24	13.23	13.27
	50RB-Middle (25)	1900 (19100)	13.39	13.22	13.22	13.26
		1880 (18900)	13.39	13.27	13.22	13.26
		1860 (18700)	13.47	13.24	13.22	13.26
	50RB-Low (0)	1900 (19100)	13.38	13.15	13.18	13.22
		1880 (18900)	13.42	13.23	13.21	13.25
		1860 (18700)	13.34	13.15	13.16	13.20
	100RB (0)	1900 (19100)	13.44	13.26	13.18	13.22
		1880 (18900)	13.45	13.15	13.17	13.21
		1860 (18700)	13.46	13.32	13.16	13.20

LTE Band4 DS11

BANDWIDTH	Number of RBs	Frequency	QPSK	16QAM	64QAM	256QAM
1.4MHz	1RB-High (5)	1754.3 (20393)	23.11	22.51	22.36	20.02
		1732.5 (20175)	23.13	22.53	22.40	20.05
		1710.7 (19957)	23.21	22.51	21.43	19.18
	1RB-Middle (3)	1754.3 (20393)	23.23	22.54	22.48	20.12
		1732.5 (20175)	23.22	22.58	22.37	20.03
		1710.7 (19957)	23.20	22.67	21.75	19.47
	1RB-Low (0)	1754.3 (20393)	23.14	22.52	22.28	19.95
		1732.5 (20175)	23.09	22.49	22.39	20.04
		1710.7 (19957)	23.19	22.46	21.61	19.35
	3RB-High (3)	1754.3 (20393)	23.21	22.34	21.86	19.57
		1732.5 (20175)	23.16	22.22	21.58	19.32
		1710.7 (19957)	23.20	22.38	21.37	19.13
	3RB-Middle (1)	1754.3 (20393)	23.20	22.29	22.34	20.00
		1732.5 (20175)	23.23	22.33	21.37	19.13
		1710.7 (19957)	23.28	22.41	21.48	19.23
	3RB-Low (0)	1754.3 (20393)	23.18	22.21	22.32	19.98
		1732.5 (20175)	23.22	22.28	21.36	19.12
		1710.7 (19957)	23.15	22.31	21.59	19.33
	6RB (0)	1754.3 (20393)	22.27	21.32	21.29	19.06
		1732.5 (20175)	22.28	21.36	20.27	18.15
		1710.7 (19957)	22.33	21.40	20.27	18.15
3MHz	1RB-High (14)	1753.5 (20385)	23.22	22.63	22.47	20.12
		1732.5 (20175)	23.23	22.54	21.42	19.18
		1711.5 (19965)	23.26	22.66	21.27	19.04
	1RB-Middle (7)	1753.5 (20385)	23.21	22.51	22.38	20.03
		1732.5 (20175)	23.25	22.58	21.59	19.33
		1711.5 (19965)	23.25	22.57	21.52	19.26
	1RB-Low (0)	1753.5 (20385)	23.21	22.57	22.39	20.04
		1732.5 (20175)	23.17	22.49	21.42	19.18
		1711.5 (19965)	23.24	22.59	21.19	19.06
	8RB-High (7)	1753.5 (20385)	22.34	21.44	21.41	19.17
		1732.5 (20175)	22.29	21.40	20.35	18.22
		1711.5 (19965)	22.41	21.42	21.14	18.92
	8RB-Middle (4)	1753.5 (20385)	22.34	21.45	21.45	19.20
		1732.5 (20175)	22.35	21.49	20.41	18.27
		1711.5 (19965)	22.37	21.50	20.47	18.32
	8RB-Low (0)	1753.5 (20385)	22.28	21.38	21.39	19.15
		1732.5 (20175)	22.29	21.35	20.25	18.13
		1711.5 (19965)	22.35	21.37	20.43	18.29
	15RB (0)	1753.5 (20385)	22.38	21.40	21.36	19.12
		1732.5 (20175)	22.33	21.45	21.38	19.14
		1711.5 (19965)	22.42	21.38	20.35	18.22

5MHz	1RB-High (24)	1752.5 (20375)	23.27	22.50	22.56	20.20	
		1732.5 (20175)	23.33	22.66	21.33	19.09	
		1712.5 (19975)	23.35	22.61	21.63	19.36	
	1RB-Middle (12)	1752.5 (20375)	23.27	22.57	22.52	20.16	
		1732.5 (20175)	23.26	22.47	21.63	19.36	
		1712.5 (19975)	23.31	22.54	21.62	19.35	
	1RB-Low (0)	1752.5 (20375)	23.25	22.50	22.51	20.15	
		1732.5 (20175)	23.24	22.46	21.52	19.26	
		1712.5 (19975)	23.30	22.62	21.55	19.29	
	12RB-High (13)	1752.5 (20375)	22.42	21.45	21.40	19.16	
		1732.5 (20175)	22.35	21.39	20.43	18.29	
		1712.5 (19975)	22.42	21.41	20.42	18.28	
	12RB-Middle (6)	1752.5 (20375)	22.42	21.38	21.39	19.15	
		1732.5 (20175)	22.37	21.42	20.38	18.24	
		1712.5 (19975)	22.41	21.39	20.50	18.35	
	12RB-Low (0)	1752.5 (20375)	22.39	21.36	21.36	19.12	
		1732.5 (20175)	22.27	21.25	20.32	18.19	
		1712.5 (19975)	22.34	21.32	20.44	18.30	
	25RB (0)	1752.5 (20375)	22.35	21.39	21.38	19.14	
		1732.5 (20175)	22.38	21.40	20.38	18.24	
		1712.5 (19975)	22.44	21.36	20.37	18.24	
	10MHz	1RB-High (49)	1750 (20350)	23.31	22.68	21.36	19.12
			1732.5 (20175)	23.31	22.78	22.45	20.10
			1715 (20000)	23.28	22.63	21.37	19.13
		1RB-Middle (24)	1750 (20350)	23.23	22.54	22.35	20.01
			1732.5 (20175)	23.17	22.57	22.56	20.20
			1715 (20000)	23.24	22.77	22.47	20.12
1RB-Low (0)		1750 (20350)	23.14	22.76	22.78	20.39	
		1732.5 (20175)	23.16	22.60	22.43	20.08	
		1715 (20000)	23.17	22.78	22.71	20.33	
25RB-High (25)		1750 (20350)	22.42	21.50	21.56	19.30	
		1732.5 (20175)	22.47	21.48	21.37	19.13	
		1715 (20000)	22.44	21.38	21.40	19.16	
25RB-Middle (12)		1750 (20350)	22.43	21.43	21.36	19.12	
		1732.5 (20175)	22.38	21.44	21.41	19.17	
		1715 (20000)	22.42	21.44	21.45	19.20	
25RB-Low (0)		1750 (20350)	22.35	21.40	21.25	19.02	
		1732.5 (20175)	22.39	21.32	21.34	19.10	
		1715 (20000)	22.40	21.31	21.39	19.15	
50RB (0)		1750 (20350)	22.39	21.32	21.42	19.18	
		1732.5 (20175)	22.44	21.35	21.44	19.19	
		1715 (20000)	22.48	21.42	21.41	19.17	

15MHz	1RB-High (74)	1747.5 (20325)	23.35	22.39	22.45	20.10
		1732.5 (20175)	23.37	22.66	21.67	19.40
		1717.5 (20025)	23.33	22.71	21.13	19.04
	1RB-Middle (37)	1747.5 (20325)	23.43	22.75	22.46	20.11
		1732.5 (20175)	23.40	22.57	21.67	19.40
		1717.5 (20025)	23.38	22.60	21.39	19.15
	1RB-Low (0)	1747.5 (20325)	23.53	22.83	22.57	20.20
		1732.5 (20175)	23.53	22.85	21.73	19.45
		1717.5 (20025)	23.39	22.76	21.27	19.04
	36RB-High (38)	1747.5 (20325)	22.57	21.51	21.44	19.19
		1732.5 (20175)	22.47	21.38	20.51	18.36
		1717.5 (20025)	22.55	21.46	20.43	18.29
	36RB-Middle (19)	1747.5 (20325)	22.44	21.39	21.39	19.15
		1732.5 (20175)	22.56	21.48	20.52	18.37
		1717.5 (20025)	22.50	21.51	20.46	18.32
	36RB-Low (0)	1747.5 (20325)	22.49	21.39	21.41	19.17
		1732.5 (20175)	22.48	21.50	20.50	18.35
		1717.5 (20025)	22.53	21.52	20.46	18.32
	75RB (0)	1747.5 (20325)	22.43	21.37	21.40	19.16
		1732.5 (20175)	22.45	21.51	20.51	18.36
		1717.5 (20025)	22.46	21.50	20.48	18.33
20MHz	1RB-High (99)	1745 (20300)	23.30	22.63	21.55	19.29
		1732.5 (20175)	23.28	22.45	21.77	19.49
		1720 (20050)	23.40	22.67	21.55	19.29
	1RB-Middle (50)	1745 (20300)	23.23	22.56	21.53	19.27
		1732.5 (20175)	23.27	22.57	21.41	19.17
		1720 (20050)	23.27	22.53	21.67	19.40
	1RB-Low (0)	1745 (20300)	23.47	22.73	21.48	19.23
		1732.5 (20175)	23.39	22.79	21.66	19.39
		1720 (20050)	23.44	22.81	21.23	19.01
	50RB-High (50)	1745 (20300)	22.41	21.48	20.47	18.32
		1732.5 (20175)	22.42	21.49	20.46	18.32
		1720 (20050)	22.48	21.49	20.50	18.35
	50RB-Middle (25)	1745 (20300)	22.39	21.38	20.45	18.31
		1732.5 (20175)	22.45	21.44	20.56	18.41
		1720 (20050)	22.59	21.45	20.50	18.35
	50RB-Low (0)	1745 (20300)	22.47	21.42	20.45	18.31
		1732.5 (20175)	22.51	21.52	20.54	18.39
		1720 (20050)	22.48	21.50	20.49	18.34
	100RB (0)	1745 (20300)	22.44	21.35	20.40	18.26
		1732.5 (20175)	22.48	21.50	20.48	18.33
		1720 (20050)	22.51	21.51	20.50	18.35

LTE Band4 DS10

BANDWIDTH	Number of RBs	Frequency	QPSK	16QAM	64QAM	256QAM	
1.4MHz	1RB-High (5)	1754.3 (20393)	18.27	18.66	18.61	18.51	
		1732.5 (20175)	18.34	18.69	18.61	18.51	
		1710.7 (19957)	18.43	18.68	18.70	18.60	
	1RB-Middle (3)	1754.3 (20393)	18.42	18.55	18.73	18.63	
		1732.5 (20175)	18.42	18.79	18.58	18.48	
		1710.7 (19957)	18.42	18.88	18.67	18.57	
	1RB-Low (0)	1754.3 (20393)	18.31	18.59	18.12	18.02	
		1732.5 (20175)	18.30	18.80	18.52	18.42	
		1710.7 (19957)	18.42	18.64	18.42	18.32	
	3RB-High (3)	1754.3 (20393)	18.38	18.36	18.54	18.44	
		1732.5 (20175)	18.32	18.39	18.60	18.50	
		1710.7 (19957)	18.43	18.40	18.66	18.56	
	3RB-Middle (1)	1754.3 (20393)	18.47	18.42	18.58	18.48	
		1732.5 (20175)	18.40	18.53	18.56	18.46	
		1710.7 (19957)	18.47	18.57	18.72	18.62	
	3RB-Low (0)	1754.3 (20393)	18.38	18.45	18.51	18.41	
		1732.5 (20175)	18.35	18.46	18.61	18.51	
		1710.7 (19957)	18.44	18.55	18.55	18.45	
	6RB (0)	1754.3 (20393)	18.37	18.53	18.49	18.39	
		1732.5 (20175)	18.37	18.56	18.41	18.31	
		1710.7 (19957)	18.52	18.50	18.44	18.34	
	3MHz	1RB-High (14)	1753.5 (20385)	18.40	18.73	18.70	18.60
			1732.5 (20175)	18.42	18.76	18.43	18.33
			1711.5 (19965)	18.54	18.84	18.09	17.99
		1RB-Middle (7)	1753.5 (20385)	18.32	18.72	18.57	18.47
			1732.5 (20175)	18.34	18.80	18.90	18.80
			1711.5 (19965)	18.44	18.72	18.83	18.73
1RB-Low (0)		1753.5 (20385)	18.38	18.82	18.55	18.45	
		1732.5 (20175)	18.38	18.64	18.67	18.57	
		1711.5 (19965)	18.47	18.85	18.28	18.18	
8RB-High (7)		1753.5 (20385)	18.51	18.55	18.61	18.51	
		1732.5 (20175)	18.57	18.58	18.55	18.45	
		1711.5 (19965)	18.56	18.65	18.56	18.46	
8RB-Middle (4)		1753.5 (20385)	18.49	18.59	18.57	18.47	
		1732.5 (20175)	18.49	18.59	18.62	18.52	
		1711.5 (19965)	18.58	18.63	18.63	18.53	
8RB-Low (0)		1753.5 (20385)	18.47	18.58	18.52	18.42	
		1732.5 (20175)	18.46	18.48	18.56	18.46	
		1711.5 (19965)	18.51	18.60	18.63	18.53	
15RB (0)		1753.5 (20385)	18.51	18.51	18.05	17.95	
		1732.5 (20175)	18.52	18.55	18.54	18.44	
		1711.5 (19965)	18.61	18.54	18.11	18.01	

5MHz	1RB-High (24)	1752.5 (20375)	18.52	18.75	18.78	18.68	
		1732.5 (20175)	18.47	18.81	18.58	18.48	
		1712.5 (19975)	18.52	18.90	18.67	18.57	
	1RB-Middle (12)	1752.5 (20375)	18.35	18.79	18.71	18.61	
		1732.5 (20175)	18.41	18.70	18.75	18.65	
		1712.5 (19975)	18.42	18.82	18.95	18.85	
	1RB-Low (0)	1752.5 (20375)	18.45	18.91	18.76	18.66	
		1732.5 (20175)	18.35	18.75	18.75	18.65	
		1712.5 (19975)	18.42	18.81	19.11	19.01	
	12RB-High (13)	1752.5 (20375)	18.55	18.57	18.61	18.51	
		1732.5 (20175)	18.58	18.57	18.62	18.52	
		1712.5 (19975)	18.54	18.64	18.62	18.52	
	12RB-Middle (6)	1752.5 (20375)	18.55	18.58	18.62	18.52	
		1732.5 (20175)	18.49	18.57	18.61	18.51	
		1712.5 (19975)	18.60	18.59	18.66	18.56	
	12RB-Low (0)	1752.5 (20375)	18.48	18.53	18.63	18.53	
		1732.5 (20175)	18.51	18.45	18.50	18.40	
		1712.5 (19975)	18.52	18.60	18.63	18.53	
	25RB (0)	1752.5 (20375)	18.53	18.55	18.60	18.50	
		1732.5 (20175)	18.48	18.61	18.56	18.46	
		1712.5 (19975)	18.59	18.58	18.64	18.54	
	10MHz	1RB-High (49)	1750 (20350)	18.28	18.84	18.58	18.48
			1732.5 (20175)	18.49	18.78	18.87	18.77
			1715 (20000)	18.47	18.78	18.81	18.71
1RB-Middle (24)		1750 (20350)	18.42	18.74	18.58	18.48	
		1732.5 (20175)	18.39	18.72	18.76	18.66	
		1715 (20000)	18.51	18.91	18.70	18.60	
1RB-Low (0)		1750 (20350)	18.20	18.90	18.95	18.85	
		1732.5 (20175)	18.41	18.77	18.56	18.46	
		1715 (20000)	18.39	18.93	18.85	18.75	
25RB-High (25)		1750 (20350)	18.58	18.54	18.53	18.43	
		1732.5 (20175)	18.53	18.53	18.62	18.52	
		1715 (20000)	18.53	18.48	18.61	18.51	
25RB-Middle (12)		1750 (20350)	18.50	18.42	18.52	18.42	
		1732.5 (20175)	18.57	18.46	18.58	18.48	
		1715 (20000)	18.61	18.65	18.65	18.55	
25RB-Low (0)		1750 (20350)	18.40	18.52	18.50	18.40	
		1732.5 (20175)	18.41	18.39	18.45	18.35	
		1715 (20000)	18.56	18.57	18.47	18.37	
50RB (0)		1750 (20350)	18.47	18.60	18.49	18.39	
		1732.5 (20175)	18.56	18.60	18.64	18.54	
		1715 (20000)	18.63	18.55	18.60	18.50	

15MHz	1RB-High (74)	1747.5 (20325)	18.42	18.75	18.60	18.50
		1732.5 (20175)	18.32	18.63	18.13	18.03
		1717.5 (20025)	18.32	18.74	18.66	18.56
	1RB-Middle (37)	1747.5 (20325)	18.33	18.78	18.65	18.55
		1732.5 (20175)	18.47	18.73	18.56	18.46
		1717.5 (20025)	18.36	18.69	18.59	18.49
	1RB-Low (0)	1747.5 (20325)	18.44	18.87	18.81	18.71
		1732.5 (20175)	18.49	18.77	18.74	18.64
		1717.5 (20025)	18.55	18.90	18.35	18.25
	36RB-High (38)	1747.5 (20325)	18.58	18.49	18.66	18.56
		1732.5 (20175)	18.58	18.51	18.53	18.43
		1717.5 (20025)	18.59	18.58	18.56	18.46
	36RB-Middle (19)	1747.5 (20325)	18.46	18.44	18.49	18.39
		1732.5 (20175)	18.58	18.59	18.62	18.52
		1717.5 (20025)	18.58	18.58	18.57	18.47
	36RB-Low (0)	1747.5 (20325)	18.54	18.55	18.49	18.39
		1732.5 (20175)	18.54	18.54	18.55	18.45
		1717.5 (20025)	18.48	18.57	18.58	18.48
	75RB (0)	1747.5 (20325)	18.54	18.49	18.63	18.53
		1732.5 (20175)	18.56	18.60	18.55	18.45
		1717.5 (20025)	18.63	18.62	18.61	18.51
20MHz	1RB-High (99)	1745 (20300)	18.53	18.81	18.64	18.54
		1732.5 (20175)	18.46	18.90	18.29	18.19
		1720 (20050)	18.47	18.71	18.65	18.55
	1RB-Middle (50)	1745 (20300)	18.36	18.77	18.62	18.52
		1732.5 (20175)	18.45	18.71	18.58	18.48
		1720 (20050)	18.39	18.71	18.50	18.40
	1RB-Low (0)	1745 (20300)	18.38	18.79	18.86	18.76
		1732.5 (20175)	18.68	18.87	18.77	18.67
		1720 (20050)	18.54	18.88	18.68	18.58
	50RB-High (50)	1745 (20300)	18.51	18.56	18.60	18.50
		1732.5 (20175)	18.50	18.47	18.55	18.45
		1720 (20050)	18.54	18.56	18.58	18.48
	50RB-Middle (25)	1745 (20300)	18.57	18.48	18.56	18.46
		1732.5 (20175)	18.63	18.55	18.61	18.51
		1720 (20050)	18.64	18.64	18.59	18.49
	50RB-Low (0)	1745 (20300)	18.67	18.61	18.63	18.53
		1732.5 (20175)	18.61	18.57	18.56	18.46
		1720 (20050)	18.70	18.57	18.66	18.56
	100RB (0)	1745 (20300)	18.61	18.52	18.53	18.43
		1732.5 (20175)	18.61	18.65	18.69	18.59
		1720 (20050)	18.69	18.59	18.70	18.60

LTE Band5 DS11

1.4MHz	1RB-High (5)	848.3 (20643)	23.00	22.29	21.60	19.54
		836.5 (20525)	23.06	22.33	21.27	19.24
		824.7 (20407)	23.01	22.30	21.12	19.11
	1RB-Middle (3)	848.3 (20643)	23.04	22.49	21.74	19.67
		836.5 (20525)	23.01	22.45	21.42	19.38
		824.7 (20407)	23.06	22.35	21.27	19.24
	1RB-Low (0)	848.3 (20643)	23.04	22.26	21.67	19.60
		836.5 (20525)	23.03	22.36	21.24	19.22
		824.7 (20407)	23.06	22.36	21.04	19.03
	3RB-High (3)	848.3 (20643)	23.03	22.01	21.12	19.11
		836.5 (20525)	23.00	22.10	21.18	19.16
		824.7 (20407)	23.06	22.03	21.21	19.19
	3RB-Middle (1)	848.3 (20643)	23.08	22.04	21.22	19.20
		836.5 (20525)	23.02	22.18	21.21	19.19
		824.7 (20407)	23.08	22.19	21.26	19.23
	3RB-Low (0)	848.3 (20643)	23.09	22.08	21.20	19.18
		836.5 (20525)	23.07	22.07	21.25	19.22
		824.7 (20407)	23.01	22.18	21.24	19.22
	6RB (0)	848.3 (20643)	22.08	21.20	20.07	18.16
		836.5 (20525)	22.09	21.18	20.13	18.21
		824.7 (20407)	22.09	21.15	20.16	18.24
3MHz	1RB-High (14)	847.5 (20635)	23.03	22.26	22.24	20.12
		836.5 (20525)	23.07	22.49	21.28	19.25
		825.5 (20415)	23.08	22.31	21.20	19.18
	1RB-Middle (7)	847.5 (20635)	23.10	22.45	21.78	19.70
		836.5 (20525)	23.03	22.36	21.31	19.28
		825.5 (20415)	23.03	22.33	21.25	19.22
	1RB-Low (0)	847.5 (20635)	23.12	22.45	21.39	19.35
		836.5 (20525)	23.09	22.48	21.32	19.29
		825.5 (20415)	23.18	22.60	21.39	19.35
	8RB-High (7)	847.5 (20635)	22.09	21.13	20.20	18.27
		836.5 (20525)	22.18	21.16	20.21	18.28
		825.5 (20415)	22.15	21.23	20.20	18.27
	8RB-Middle (4)	847.5 (20635)	22.17	21.21	20.25	18.32
		836.5 (20525)	22.28	21.34	20.25	18.32
		825.5 (20415)	22.17	21.26	20.21	18.28
	8RB-Low (0)	847.5 (20635)	22.23	21.24	20.31	18.37
		836.5 (20525)	22.19	21.25	20.27	18.34
		825.5 (20415)	22.18	21.23	20.25	18.32
	15RB (0)	847.5 (20635)	22.20	21.21	20.17	18.25
		836.5 (20525)	22.14	21.16	20.17	18.25
		825.5 (20415)	22.13	21.22	20.23	18.30

5MHz	1RB-High (24)	846.5 (20625)	23.03	22.32	21.62	19.56	
		836.5 (20525)	23.11	22.39	21.53	19.48	
		826.5 (20425)	23.01	22.48	21.37	19.33	
	1RB-Middle (12)	846.5 (20625)	23.03	22.32	21.06	19.05	
		836.5 (20525)	23.12	22.50	21.37	19.33	
		826.5 (20425)	23.00	22.38	21.25	19.22	
	1RB-Low (0)	846.5 (20625)	23.10	22.56	21.25	19.22	
		836.5 (20525)	23.13	22.40	21.26	19.23	
		826.5 (20425)	23.19	22.59	21.38	19.34	
	12RB-High (13)	846.5 (20625)	22.15	21.13	20.19	18.27	
		836.5 (20525)	22.17	21.19	20.30	18.36	
		826.5 (20425)	22.11	21.10	20.15	18.23	
	12RB-Middle (6)	846.5 (20625)	22.16	21.16	20.24	18.31	
		836.5 (20525)	22.20	21.19	20.21	18.28	
		826.5 (20425)	22.13	21.14	20.26	18.33	
	12RB-Low (0)	846.5 (20625)	22.23	21.20	20.23	18.30	
		836.5 (20525)	22.22	21.21	20.27	18.34	
		826.5 (20425)	22.20	21.28	20.26	18.33	
	25RB (0)	846.5 (20625)	22.10	21.14	20.17	18.25	
		836.5 (20525)	22.19	21.18	20.16	18.24	
		826.5 (20425)	22.16	21.23	20.14	18.22	
	10MHz	1RB-High (49)	844 (20600)	23.16	22.51	21.29	19.26
			836.5 (20525)	23.17	22.57	21.47	19.42
			829 (20450)	23.12	22.50	21.39	19.35
1RB-Middle (24)		844 (20600)	23.07	22.44	21.33	19.30	
		836.5 (20525)	23.09	22.58	21.38	19.34	
		829 (20450)	23.09	22.52	21.32	19.29	
1RB-Low (0)		844 (20600)	23.19	22.67	21.34	19.31	
		836.5 (20525)	23.15	22.47	21.40	19.36	
		829 (20450)	23.19	22.64	21.21	19.19	
25RB-High (25)		844 (20600)	22.26	21.31	20.34	18.40	
		836.5 (20525)	22.25	21.25	20.31	18.37	
		829 (20450)	22.20	21.25	20.26	18.33	
25RB-Middle (12)		844 (20600)	22.22	21.22	20.18	18.26	
		836.5 (20525)	22.27	21.19	20.20	18.27	
		829 (20450)	22.34	21.22	20.26	18.33	
25RB-Low (0)		844 (20600)	22.24	21.25	20.26	18.33	
		836.5 (20525)	22.27	21.13	20.23	18.30	
		829 (20450)	22.27	21.15	20.12	18.20	
50RB (0)		844 (20600)	22.25	21.20	20.29	18.36	
		836.5 (20525)	22.24	21.10	20.22	18.29	
		829 (20450)	22.24	21.24	20.19	18.27	

LTE Band5 DS10

BANDWIDTH	Number of RBs	Frequency	QPSK	16QAM	64QAM	256QAM
1.4MHz	1RB-High (5)	848.3 (20643)	15.17	15.18	15.20	15.23
		836.5 (20525)	15.21	15.34	15.19	15.22
		824.7 (20407)	15.27	15.21	15.18	15.21
	1RB-Middle (3)	848.3 (20643)	14.83	15.31	15.24	15.27
		836.5 (20525)	15.34	15.24	15.37	15.40
		824.7 (20407)	15.27	15.40	14.84	14.87
	1RB-Low (0)	848.3 (20643)	15.17	15.28	15.14	15.17
		836.5 (20525)	15.22	15.41	14.25	14.28
		824.7 (20407)	15.27	15.39	15.21	15.24
	3RB-High (3)	848.3 (20643)	15.19	15.02	15.08	15.11
		836.5 (20525)	15.05	15.07	15.22	15.25
		824.7 (20407)	15.22	15.00	15.32	15.35
	3RB-Middle (1)	848.3 (20643)	15.25	15.13	15.27	15.30
		836.5 (20525)	15.13	15.15	15.23	15.26
		824.7 (20407)	15.35	15.15	15.27	15.30
	3RB-Low (0)	848.3 (20643)	15.21	15.06	15.12	15.15
		836.5 (20525)	15.08	15.05	15.20	15.23
		824.7 (20407)	15.31	15.08	15.35	15.38
	6RB (0)	848.3 (20643)	15.32	15.13	15.01	15.04
		836.5 (20525)	15.39	15.13	15.21	15.24
		824.7 (20407)	15.34	15.15	15.14	15.17
3MHz	1RB-High (14)	847.5 (20635)	15.23	15.32	15.16	15.19
		836.5 (20525)	15.23	15.53	15.32	15.35
		825.5 (20415)	15.21	15.38	15.36	15.39
	1RB-Middle (7)	847.5 (20635)	15.28	15.40	15.23	15.26
		836.5 (20525)	15.29	15.46	15.24	15.27
		825.5 (20415)	15.29	15.24	15.22	15.25
	1RB-Low (0)	847.5 (20635)	15.34	15.55	15.32	15.35
		836.5 (20525)	15.31	15.45	15.31	15.34
		825.5 (20415)	15.34	15.48	15.36	15.39
	8RB-High (7)	847.5 (20635)	15.34	15.17	15.09	15.12
		836.5 (20525)	15.44	15.26	15.18	15.21
		825.5 (20415)	15.28	15.17	15.17	15.20
	8RB-Middle (4)	847.5 (20635)	15.40	15.21	15.20	15.23
		836.5 (20525)	15.41	15.28	15.27	15.30
		825.5 (20415)	15.42	15.26	15.22	15.25
	8RB-Low (0)	847.5 (20635)	15.42	15.24	15.18	15.21
		836.5 (20525)	15.45	15.22	15.21	15.24
		825.5 (20415)	15.44	15.26	15.25	15.28
	15RB (0)	847.5 (20635)	15.35	15.19	15.14	15.17
		836.5 (20525)	15.32	15.18	15.13	15.16
		825.5 (20415)	15.36	15.14	15.21	15.24

5MHz	1RB-High (24)	846.5 (20625)	15.25	15.43	15.17	15.20	
		836.5 (20525)	15.30	15.48	15.27	15.30	
		826.5 (20425)	15.32	15.45	15.03	15.06	
	1RB-Middle (12)	846.5 (20625)	15.24	15.45	15.30	15.33	
		836.5 (20525)	15.35	15.45	15.29	15.32	
		826.5 (20425)	15.29	15.27	15.25	15.28	
	1RB-Low (0)	846.5 (20625)	15.44	15.51	15.40	15.43	
		836.5 (20525)	15.38	15.60	15.40	15.43	
		826.5 (20425)	15.44	15.62	15.48	15.51	
	12RB-High (13)	846.5 (20625)	15.35	15.10	15.13	15.16	
		836.5 (20525)	15.38	15.11	15.24	15.27	
		826.5 (20425)	15.32	15.14	15.17	15.20	
	12RB-Middle (6)	846.5 (20625)	15.36	15.22	15.21	15.24	
		836.5 (20525)	15.43	15.19	15.27	15.30	
		826.5 (20425)	15.42	15.24	15.24	15.27	
	12RB-Low (0)	846.5 (20625)	15.40	15.20	15.24	15.27	
		836.5 (20525)	15.39	15.16	15.22	15.25	
		826.5 (20425)	15.44	15.21	15.32	15.35	
	25RB (0)	846.5 (20625)	15.38	15.16	15.15	15.18	
		836.5 (20525)	15.44	15.24	15.18	15.21	
		826.5 (20425)	15.41	15.19	15.22	15.25	
	10MHz	1RB-High (49)	844 (20600)	15.03	15.13	15.12	15.15
			836.5 (20525)	15.17	15.18	15.24	15.27
			829 (20450)	15.16	15.29	15.31	15.34
1RB-Middle (24)		844 (20600)	14.91	15.25	15.35	15.38	
		836.5 (20525)	15.06	15.23	15.10	15.13	
		829 (20450)	15.04	15.22	15.09	15.12	
1RB-Low (0)		844 (20600)	15.20	15.44	15.60	15.63	
		836.5 (20525)	15.15	15.16	15.17	15.20	
		829 (20450)	15.08	15.23	15.14	15.17	
25RB-High (25)		844 (20600)	15.22	15.02	15.02	15.05	
		836.5 (20525)	15.27	15.11	15.05	15.08	
		829 (20450)	15.20	15.11	15.04	15.07	
25RB-Middle (12)		844 (20600)	15.24	15.06	15.05	15.08	
		836.5 (20525)	15.26	15.08	15.03	15.06	
		829 (20450)	15.23	15.09	15.08	15.11	
25RB-Low (0)		844 (20600)	15.29	15.10	15.07	15.10	
		836.5 (20525)	15.26	15.05	15.03	15.06	
		829 (20450)	15.19	15.01	15.03	15.06	
50RB (0)		844 (20600)	15.23	15.04	15.06	15.09	
		836.5 (20525)	15.22	14.99	14.93	14.96	
		829 (20450)	15.20	15.04	15.05	15.08	

LTE Band12 DSI1

BANDWIDTH	Number of RBs	Frequency	QPSK	16QAM	64QAM	256QAM
1.4MHz	1RB-High (5)	715.3 (23173)	22.75	22.17	21.05	18.94
		707.5 (23095)	22.85	22.14	21.08	18.97
		699.7 (23017)	23.00	22.38	21.20	19.07
	1RB-Middle (3)	715.3 (23173)	22.88	22.21	21.09	18.98
		707.5 (23095)	22.93	22.18	21.33	19.19
		699.7 (23017)	23.04	22.42	21.65	19.48
	1RB-Low (0)	715.3 (23173)	22.84	22.10	20.13	18.11
		707.5 (23095)	22.95	22.28	21.21	19.08
		699.7 (23017)	23.02	22.34	20.35	18.31
	3RB-High (3)	715.3 (23173)	22.75	21.89	21.01	18.90
		707.5 (23095)	22.86	21.93	21.05	18.94
		699.7 (23017)	23.06	22.11	21.21	19.08
	3RB-Middle (1)	715.3 (23173)	22.89	22.02	21.09	18.98
		707.5 (23095)	22.95	22.12	21.15	19.03
		699.7 (23017)	23.16	22.25	21.32	19.18
	3RB-Low (0)	715.3 (23173)	22.77	21.84	21.06	18.95
		707.5 (23095)	22.91	22.00	21.17	19.05
		699.7 (23017)	23.12	22.19	21.24	19.11
	6RB (0)	715.3 (23173)	21.90	20.91	19.92	17.92
		707.5 (23095)	21.95	21.02	19.93	17.93
		699.7 (23017)	22.15	21.13	20.09	18.08
3MHz	1RB-High (14)	714.5 (23165)	22.88	22.09	21.36	19.22
		707.5 (23095)	22.93	22.33	21.32	19.18
		700.5 (23025)	23.06	22.48	21.36	19.22
	1RB-Middle (7)	714.5 (23165)	22.91	22.14	22.00	19.79
		707.5 (23095)	22.92	22.24	21.26	19.13
		700.5 (23025)	23.06	22.37	21.34	19.20
	1RB-Low (0)	714.5 (23165)	22.87	22.41	21.39	19.25
		707.5 (23095)	23.05	22.43	21.25	19.12
		700.5 (23025)	23.19	22.50	21.43	19.28
	8RB-High (7)	714.5 (23165)	21.90	21.02	20.97	18.87
		707.5 (23095)	21.98	21.01	20.11	18.09
		700.5 (23025)	22.09	21.21	20.23	18.20
	8RB-Middle (4)	714.5 (23165)	21.95	21.08	20.36	18.32
		707.5 (23095)	22.04	21.15	20.20	18.18
		700.5 (23025)	22.16	21.22	20.28	18.25
	8RB-Low (0)	714.5 (23165)	22.00	21.01	20.97	18.87
		707.5 (23095)	22.04	21.13	20.10	18.09
		700.5 (23025)	22.19	21.26	20.28	18.25
	15RB (0)	714.5 (23165)	21.90	20.94	20.25	18.22
		707.5 (23095)	22.09	21.04	20.36	18.32
		700.5 (23025)	22.20	21.20	20.18	18.16

5MHz	1RB-High (24)	713.5 (23155)	22.38	22.02	21.12	19.00	
		707.5 (23095)	22.95	22.20	21.27	19.14	
		701.5 (23035)	23.01	22.31	21.29	19.16	
	1RB-Middle (12)	713.5 (23155)	22.90	22.23	21.23	19.10	
		707.5 (23095)	22.95	22.21	21.25	19.12	
		701.5 (23035)	23.03	22.42	21.26	19.13	
	1RB-Low (0)	713.5 (23155)	22.93	22.24	21.30	19.16	
		707.5 (23095)	22.99	22.39	21.35	19.21	
		701.5 (23035)	23.19	22.49	21.55	19.39	
	12RB-High (13)	713.5 (23155)	21.92	20.97	19.98	17.98	
		707.5 (23095)	22.01	21.04	20.10	18.09	
		701.5 (23035)	22.13	21.18	20.15	18.13	
	12RB-Middle (6)	713.5 (23155)	22.04	21.09	20.15	18.13	
		707.5 (23095)	22.07	21.09	20.07	18.06	
		701.5 (23035)	22.14	21.29	20.25	18.22	
	12RB-Low (0)	713.5 (23155)	22.01	20.98	20.06	18.05	
		707.5 (23095)	22.10	21.06	20.09	18.08	
		701.5 (23035)	22.20	21.24	20.24	18.21	
	25RB (0)	713.5 (23155)	21.88	20.93	19.99	17.99	
		707.5 (23095)	22.02	21.08	20.09	18.08	
		701.5 (23035)	22.13	21.24	20.16	18.14	
	10MHz	1RB-High (49)	711 (23130)	22.92	22.26	21.03	18.92
			707.5 (23095)	22.87	22.26	21.18	19.06
			704 (23060)	22.98	22.39	21.21	19.08
		1RB-Middle (24)	711 (23130)	22.94	22.41	21.29	19.16
			707.5 (23095)	22.99	22.59	21.13	19.01
			704 (23060)	22.89	22.27	21.06	18.95
1RB-Low (0)		711 (23130)	23.02	22.46	21.31	19.17	
		707.5 (23095)	23.08	22.53	21.35	19.21	
		704 (23060)	23.07	22.58	21.29	19.16	
25RB-High (25)		711 (23130)	21.95	21.07	20.10	18.09	
		707.5 (23095)	22.11	21.07	20.07	18.06	
		704 (23060)	22.17	21.13	20.18	18.16	
25RB-Middle (12)		711 (23130)	22.09	21.05	20.12	18.10	
		707.5 (23095)	22.12	21.17	20.16	18.14	
		704 (23060)	22.23	21.28	20.23	18.20	
25RB-Low (0)		711 (23130)	22.11	21.02	20.14	18.12	
		707.5 (23095)	22.26	21.09	20.18	18.16	
		704 (23060)	22.26	21.19	20.15	18.13	
50RB (0)		711 (23130)	22.06	20.97	20.08	18.07	
		707.5 (23095)	22.10	21.10	20.12	18.10	
		704 (23060)	22.24	21.24	20.26	18.23	

LTE Band12 DSI0

BANDWIDTH	Number of RBs	Frequency	QPSK	16QAM	64QAM	256QAM
1.4MHz	1RB-High (5)	715.3 (23173)	19.72	20.06	19.91	18.83
		707.5 (23095)	19.84	20.24	20.02	18.86
		699.7 (23017)	20.00	20.31	20.25	18.96
	1RB-Middle (3)	715.3 (23173)	19.84	20.20	20.15	18.87
		707.5 (23095)	19.98	20.32	20.11	19.08
		699.7 (23017)	20.12	20.41	20.32	19.37
	1RB-Low (0)	715.3 (23173)	19.78	20.20	20.05	18.00
		707.5 (23095)	19.92	20.16	20.15	18.97
		699.7 (23017)	20.02	20.33	19.63	18.20
	3RB-High (3)	715.3 (23173)	19.83	19.98	19.53	18.79
		707.5 (23095)	19.88	19.97	20.07	18.83
		699.7 (23017)	20.04	20.06	20.18	18.97
	3RB-Middle (1)	715.3 (23173)	19.84	19.97	20.08	18.87
		707.5 (23095)	19.99	20.09	20.12	18.92
		699.7 (23017)	20.04	20.14	20.20	19.07
	3RB-Low (0)	715.3 (23173)	19.84	20.00	20.04	18.84
		707.5 (23095)	19.98	20.10	20.14	18.94
		699.7 (23017)	20.12	20.18	20.25	19.00
	6RB (0)	715.3 (23173)	19.88	20.00	19.90	17.81
		707.5 (23095)	19.93	20.10	20.01	17.82
		699.7 (23017)	20.16	20.26	20.14	17.97
3MHz	1RB-High (14)	714.5 (23165)	19.83	20.07	20.10	19.11
		707.5 (23095)	19.92	20.26	19.62	19.07
		700.5 (23025)	19.97	20.37	20.20	19.11
	1RB-Middle (7)	714.5 (23165)	19.77	20.18	20.10	19.68
		707.5 (23095)	19.88	20.29	20.16	19.02
		700.5 (23025)	20.05	20.28	20.29	19.09
	1RB-Low (0)	714.5 (23165)	19.88	20.19	20.20	19.14
		707.5 (23095)	19.99	20.31	20.16	19.01
		700.5 (23025)	20.23	20.39	20.38	19.17
	8RB-High (7)	714.5 (23165)	19.93	19.99	20.01	18.76
		707.5 (23095)	19.98	20.08	20.12	17.98
		700.5 (23025)	20.15	20.17	20.22	18.09
	8RB-Middle (4)	714.5 (23165)	19.95	20.03	20.05	18.21
		707.5 (23095)	20.02	20.13	20.14	18.07
		700.5 (23025)	20.20	20.31	20.23	18.14
	8RB-Low (0)	714.5 (23165)	19.96	20.02	20.02	18.76
		707.5 (23095)	20.04	20.16	20.07	17.98
		700.5 (23025)	20.20	20.25	20.33	18.14
	15RB (0)	714.5 (23165)	19.96	19.99	19.95	18.11
		707.5 (23095)	20.05	20.06	19.88	18.21
		700.5 (23025)	20.22	20.18	19.62	18.05

5MHz	1RB-High (24)	713.5 (23155)	19.97	20.17	20.02	18.89	
		707.5 (23095)	19.91	20.22	20.21	19.03	
		701.5 (23035)	20.04	20.30	20.38	19.05	
	1RB-Middle (12)	713.5 (23155)	19.92	20.20	20.03	18.99	
		707.5 (23095)	19.86	20.29	20.25	19.01	
		701.5 (23035)	19.95	20.38	20.29	19.02	
	1RB-Low (0)	713.5 (23155)	19.88	20.30	20.20	19.05	
		707.5 (23095)	20.07	20.45	20.39	19.10	
		701.5 (23035)	20.14	20.35	20.36	19.28	
	12RB-High (13)	713.5 (23155)	19.96	20.00	20.07	17.87	
		707.5 (23095)	20.05	20.05	20.08	17.98	
		701.5 (23035)	20.11	20.12	20.14	18.02	
	12RB-Middle (6)	713.5 (23155)	20.08	20.02	20.10	18.02	
		707.5 (23095)	20.07	20.03	20.06	17.95	
		701.5 (23035)	20.19	20.19	20.20	18.11	
	12RB-Low (0)	713.5 (23155)	20.05	20.04	20.09	17.94	
		707.5 (23095)	20.06	20.17	20.18	17.97	
		701.5 (23035)	20.20	20.19	20.24	18.10	
	25RB (0)	713.5 (23155)	19.92	19.99	20.03	17.88	
		707.5 (23095)	20.08	20.08	20.13	17.97	
		701.5 (23035)	20.13	20.15	20.21	18.03	
	10MHz	1RB-High (49)	711 (23130)	19.67	20.13	20.15	18.81
			707.5 (23095)	19.56	20.07	19.93	18.95
			704 (23060)	19.78	20.10	19.84	18.97
		1RB-Middle (24)	711 (23130)	19.75	20.03	20.08	19.05
			707.5 (23095)	19.82	20.15	20.03	18.90
			704 (23060)	19.89	20.27	19.97	18.84
1RB-Low (0)		711 (23130)	19.88	20.14	20.02	19.06	
		707.5 (23095)	19.96	20.19	20.14	19.10	
		704 (23060)	20.01	20.41	20.20	19.05	
25RB-High (25)		711 (23130)	19.83	19.86	19.96	17.98	
		707.5 (23095)	19.89	19.86	19.95	17.95	
		704 (23060)	19.88	20.00	20.00	18.05	
25RB-Middle (12)		711 (23130)	19.97	20.00	19.91	17.99	
		707.5 (23095)	19.96	19.87	20.01	18.03	
		704 (23060)	20.05	20.11	20.11	18.09	
25RB-Low (0)		711 (23130)	19.96	19.83	19.83	18.01	
		707.5 (23095)	19.96	20.00	19.96	18.05	
		704 (23060)	19.98	20.03	20.01	18.02	
50RB (0)		711 (23130)	19.98	20.00	20.01	17.96	
		707.5 (23095)	19.96	20.03	20.00	17.99	
		704 (23060)	20.03	20.07	20.09	18.12	

LTE Band13 DSI1

BANDWIDTH	Number of RBs	Frequency	QPSK	16QAM	64QAM	256QAM
5MHz	1RB-High (24)	784.5 (23255)	23.23	22.56	21.14	19.28
		782 (23230)	23.21	22.45	21.27	19.40
		779.5 (23205)	23.15	22.58	21.30	19.43
	1RB-Middle (12)	784.5 (23255)	23.11	22.35	21.53	19.64
		782 (23230)	23.20	22.48	21.50	19.61
		779.5 (23205)	23.12	22.40	21.60	19.70
	1RB-Low (0)	784.5 (23255)	23.24	22.61	21.50	19.61
		782 (23230)	23.23	22.57	21.46	19.57
		779.5 (23205)	23.13	22.53	21.48	19.59
	12RB-High (13)	784.5 (23255)	22.26	21.26	20.18	18.40
		782 (23230)	22.31	21.33	20.36	18.57
		779.5 (23205)	22.28	21.29	20.35	18.56
	12RB-Middle (6)	784.5 (23255)	22.28	21.29	20.29	18.50
		782 (23230)	22.26	21.24	20.28	18.50
		779.5 (23205)	22.26	21.26	20.29	18.50
	12RB-Low (0)	784.5 (23255)	22.23	21.27	20.44	18.64
		782 (23230)	22.24	21.33	20.28	18.50
		779.5 (23205)	22.21	21.38	20.28	18.50
	25RB (0)	784.5 (23255)	22.30	21.38	20.32	18.53
		782 (23230)	22.23	21.28	20.18	18.40
		779.5 (23205)	22.31	21.26	20.21	18.43
10MHz	1RB-High (49)	782 (23230)	23.15	22.54	21.22	19.35
	1RB-Middle (24)	782 (23230)	23.16	22.46	21.28	19.41
	1RB-Low (0)	782 (23230)	23.10	22.57	21.25	19.38
	25RB-High (25)	782 (23230)	22.31	21.21	20.41	18.61
	25RB-Middle (12)	782 (23230)	22.27	21.29	20.29	18.50
	25RB-Low (0)	782 (23230)	22.32	21.24	20.33	18.54
	50RB (0)	782 (23230)	22.35	21.25	20.17	18.40

LTE Band13 DSI0

BANDWIDTH	Number of RBs	Frequency	QPSK	16QAM	64QAM	256QAM
5MHz	1RB-High (24)	784.5 (23255)	15.65	15.89	15.57	15.73
		782 (23230)	15.66	15.84	15.96	16.12
		779.5 (23205)	15.54	15.83	15.85	16.01
	1RB-Middle (12)	784.5 (23255)	15.55	15.76	15.78	15.94
		782 (23230)	15.50	15.92	15.74	15.90
		779.5 (23205)	15.47	15.77	15.84	16.00
	1RB-Low (0)	784.5 (23255)	15.59	15.93	15.75	15.91
		782 (23230)	15.62	15.89	15.85	16.01
		779.5 (23205)	15.51	15.78	15.80	15.96
	12RB-High (13)	784.5 (23255)	15.72	15.68	15.73	15.89
		782 (23230)	15.67	15.72	15.70	15.86
		779.5 (23205)	15.65	15.62	15.72	15.88
	12RB-Middle (6)	784.5 (23255)	15.66	15.66	15.67	15.83
		782 (23230)	15.66	15.68	15.64	15.80
		779.5 (23205)	15.78	15.73	15.77	15.93
	12RB-Low (0)	784.5 (23255)	15.69	15.72	15.73	15.89
		782 (23230)	15.73	15.72	15.77	15.93
		779.5 (23205)	15.66	15.78	15.71	15.87
	25RB (0)	784.5 (23255)	15.71	15.79	15.79	15.95
		782 (23230)	15.62	15.62	15.64	15.80
		779.5 (23205)	15.70	15.74	15.67	15.83
10MHz	1RB-High (49)	782 (23230)	15.48	15.86	15.67	15.83
	1RB-Middle (24)	782 (23230)	15.57	15.89	15.69	15.85
	1RB-Low (0)	782 (23230)	15.52	15.90	15.54	15.70
	25RB-High (25)	782 (23230)	15.60	15.64	15.67	15.83
	25RB-Middle (12)	782 (23230)	15.62	15.62	15.69	15.85
	25RB-Low (0)	782 (23230)	15.61	15.66	15.67	15.83
	50RB (0)	782 (23230)	15.58	15.65	15.71	15.87

LTE Band48 DS11

BANDWIDTH	Number of RBs	Frequency	QPSK	16QAM	64QAM	256QAM	
5MHz	1RB-High (24)	56715	23.79	22.90	22.66	19.67	
		55990	23.76	22.87	22.61	19.63	
		55265	23.74	22.86	22.60	19.63	
	1RB-Middle (12)	56715	23.72	22.89	22.54	19.58	
		55990	23.73	22.90	22.61	19.63	
		55265	23.65	22.86	22.43	19.49	
	1RB-Low (0)	56715	23.77	22.84	22.62	19.64	
		55990	23.80	22.87	22.63	19.65	
		55265	23.70	22.79	22.51	19.56	
	12RB-High (13)	56715	22.78	21.83	21.84	19.03	
		55990	22.76	21.69	21.71	18.93	
		55265	22.74	21.74	21.68	18.91	
	12RB-Middle (6)	56715	22.77	21.79	21.78	18.99	
		55990	22.74	21.70	21.74	18.96	
		55265	22.73	21.65	21.69	18.92	
	12RB-Low (0)	56715	22.84	21.82	21.83	19.03	
		55990	22.80	21.71	21.80	19.00	
		55265	22.75	21.71	21.73	18.95	
	25RB (0)	56715	22.81	21.86	21.79	18.99	
		55990	22.72	21.76	21.73	18.95	
		55265	22.70	21.73	21.65	18.88	
	10MHz	1RB-High (49)	56690	23.77	22.85	22.72	19.72
			55990	23.73	22.85	22.67	19.68
			55290	23.76	22.76	22.60	19.63
1RB-Middle (24)		56690	23.66	22.78	22.62	19.64	
		55990	23.74	22.80	22.62	19.64	
		55290	23.64	22.76	22.60	19.63	
1RB-Low (0)		56690	23.69	22.84	22.67	19.68	
		55990	23.74	22.84	22.67	19.68	
		55290	23.67	22.80	22.65	19.66	
25RB-High (25)		56690	22.82	21.85	21.77	18.98	
		55990	22.75	21.70	21.70	18.92	
		55290	22.68	21.64	21.64	18.88	
25RB-Middle (12)		56690	22.81	21.85	21.80	19.00	
		55990	22.77	21.70	21.73	18.95	
		55290	22.71	21.72	21.64	18.88	
25RB-Low (0)		56690	22.77	21.81	21.75	18.96	
		55990	22.78	21.77	21.76	18.97	
		55290	22.73	21.73	21.71	18.93	
50RB (0)		56690	22.81	21.82	21.81	19.01	
		55990	22.72	21.74	21.70	18.92	
		55290	22.68	21.71	21.66	18.89	

15MHz	1RB-High (74)	56665	23.73	22.89	22.64	19.66
		55990	23.74	22.87	22.63	19.65
		55315	23.72	22.85	22.59	19.62
	1RB-Middle (37)	56665	23.66	22.78	22.47	19.52
		55990	23.67	22.74	22.49	19.54
		55315	23.62	22.74	22.44	19.50
	1RB-Low (0)	56665	23.74	22.83	22.57	19.60
		55990	23.67	22.79	22.56	19.59
		55315	23.63	22.77	22.56	19.59
	36RB-High (38)	56665	22.72	21.70	21.75	18.96
		55990	22.75	21.69	21.70	18.92
		55315	22.69	21.63	21.66	18.89
	36RB-Middle (19)	56665	22.82	21.80	21.80	19.00
		55990	22.68	21.70	21.71	18.93
		55315	22.67	21.65	21.64	18.88
	36RB-Low (0)	56665	22.82	21.77	21.80	19.00
		55990	22.78	21.79	21.79	18.99
		55315	22.73	21.72	21.78	18.99
	75RB (0)	56665	22.84	21.85	21.87	19.06
		55990	22.73	21.78	21.75	18.96
		55315	22.68	21.70	21.70	18.92
20MHz	1RB-High (99)	56640	23.47	22.78	21.91	19.09
		55990	23.50	22.78	21.81	19.01
		55340	23.40	22.72	21.76	19.07
	1RB-Middle (50)	56640	23.39	22.68	21.72	19.04
		55990	23.48	22.72	21.80	19.00
		55340	23.24	22.58	21.65	19.02
	1RB-Low (0)	56640	23.50	22.83	21.86	19.05
		55990	23.63	22.91	21.99	19.15
		55340	23.37	22.66	21.78	19.04
	50RB-High (50)	56640	22.51	21.58	20.73	18.17
		55990	22.53	21.60	20.77	18.20
		55340	22.42	21.48	20.65	18.10
	50RB-Middle (25)	56640	22.57	21.65	20.81	18.23
		55990	22.59	21.63	20.80	18.22
		55340	22.43	21.48	20.63	18.09
	50RB-Low (0)	56640	22.61	21.69	20.78	18.21
		55990	22.68	21.78	20.90	18.30
		55340	22.49	21.54	20.70	18.14
	100RB (0)	56640	22.60	21.66	20.90	18.30
		55990	22.62	21.67	20.89	18.29
		55340	22.41	21.49	20.70	18.14

LTE Band48 DSI0

BANDWIDTH	Number of RBs	Frequency	QPSK	16QAM	64QAM	256QAM	
5MHz	1RB-High (24)	56715	15.38	15.54	15.25	15.42	
		55990	15.39	15.47	15.21	15.38	
		55265	15.33	15.42	15.20	15.37	
	1RB-Middle (12)	56715	15.35	15.60	15.16	15.33	
		55990	15.35	15.58	15.16	15.33	
		55265	15.24	15.37	15.06	15.23	
	1RB-Low (0)	56715	15.38	15.47	15.23	15.40	
		55990	15.41	15.48	15.24	15.41	
		55265	15.29	15.42	15.12	15.29	
	12RB-High (13)	56715	15.44	15.36	15.40	15.57	
		55990	15.37	15.32	15.35	15.52	
		55265	15.35	15.29	15.30	15.47	
	12RB-Middle (6)	56715	15.41	15.35	15.41	15.58	
		55990	15.36	15.28	15.33	15.50	
		55265	15.35	15.27	15.28	15.45	
	12RB-Low (0)	56715	15.45	15.38	15.39	15.56	
		55990	15.40	15.35	15.36	15.53	
		55265	15.29	15.29	15.32	15.49	
	25RB (0)	56715	15.40	15.44	15.37	15.54	
		55990	15.34	15.38	15.27	15.44	
		55265	15.33	15.31	15.25	15.42	
	10MHz	1RB-High (49)	56690	15.42	15.49	15.27	15.44
			55990	15.44	15.62	15.36	15.53
			55290	15.31	15.38	15.18	15.35
1RB-Middle (24)		56690	15.32	15.44	15.13	15.30	
		55990	15.35	15.30	15.15	15.32	
		55290	15.26	15.34	15.12	15.29	
1RB-Low (0)		56690	15.37	15.46	15.27	15.44	
		55990	15.38	15.40	15.36	15.53	
		55290	15.34	15.40	15.20	15.37	
25RB-High (25)		56690	15.46	15.41	15.40	15.57	
		55990	15.40	15.38	15.29	15.46	
		55290	15.33	15.27	15.24	15.41	
25RB-Middle (12)		56690	15.49	15.49	15.43	15.60	
		55990	15.37	15.42	15.37	15.54	
		55290	15.37	15.26	15.27	15.44	
25RB-Low (0)		56690	15.46	15.41	15.37	15.54	
		55990	15.46	15.44	15.37	15.54	
		55290	15.34	15.36	15.31	15.48	
50RB (0)		56690	15.42	15.48	15.39	15.56	
		55990	15.40	15.43	15.32	15.49	
		55290	15.28	15.35	15.31	15.48	

15MHz	1RB-High (74)	56665	15.22	15.53	15.13	15.30
		55990	15.49	15.51	15.18	15.35
		55315	15.39	15.50	15.10	15.27
	1RB-Middle (37)	56665	15.15	15.45	15.04	15.21
		55990	15.37	15.45	15.02	15.19
		55315	15.32	15.39	15.00	15.17
	1RB-Low (0)	56665	15.23	15.49	15.10	15.27
		55990	15.41	15.46	15.10	15.27
		55315	15.32	15.42	15.04	15.21
	36RB-High (38)	56665	15.17	15.34	15.34	15.51
		55990	15.42	15.37	15.36	15.53
		55315	15.34	15.31	15.29	15.46
	36RB-Middle (19)	56665	15.28	15.41	15.41	15.58
		55990	15.41	15.32	15.37	15.54
		55315	15.33	15.30	15.24	15.41
	36RB-Low (0)	56665	15.29	15.42	15.49	15.66
		55990	15.46	15.41	15.44	15.61
		55315	15.39	15.35	15.38	15.55
	75RB (0)	56665	15.30	15.49	15.47	15.64
		55990	15.43	15.42	15.42	15.59
		55315	15.36	15.36	15.32	15.49
20MHz	1RB-High (99)	56640	15.36	15.46	15.05	15.22
		55990	15.38	15.46	15.11	15.28
		55340	15.29	15.42	15.04	15.21
	1RB-Middle (50)	56640	15.24	15.31	14.96	15.13
		55990	15.26	15.36	14.95	15.12
		55340	15.24	15.29	14.92	15.09
	1RB-Low (0)	56640	15.37	15.54	15.07	15.24
		55990	15.36	15.45	15.07	15.24
		55340	15.32	15.41	15.06	15.23
	50RB-High (50)	56640	15.34	15.37	15.31	15.48
		55990	15.34	15.38	15.30	15.47
		55340	15.30	15.31	15.23	15.40
	50RB-Middle (25)	56640	15.38	15.45	15.41	15.58
		55990	15.35	15.33	15.35	15.52
		55340	15.31	15.34	15.28	15.45
	50RB-Low (0)	56640	15.40	15.46	15.39	15.56
		55990	15.41	15.45	15.36	15.53
		55340	15.35	15.40	15.35	15.52
	100RB (0)	56640	15.39	15.42	15.47	15.64
		55990	15.32	15.40	15.41	15.58
		55340	15.27	15.35	15.37	15.54

LTE Band66 DSI1

BANDWIDTH	Number of RBs	Frequency	QPSK	16QAM	64QAM	256QAM
1.4MHz	1RB-High (5)	1779.3 (132665)	23.11	22.42	21.32	19.18
		1745 (132322)	23.21	22.55	21.59	19.41
		1710.7 (131979)	23.13	22.68	21.51	19.34
	1RB-Middle (3)	1779.3 (132665)	23.20	22.43	21.48	19.32
		1745 (132322)	23.21	22.60	21.51	19.34
		1710.7 (131979)	23.25	22.62	21.63	19.45
	1RB-Low (0)	1779.3 (132665)	23.11	22.48	21.49	19.33
		1745 (132322)	23.20	22.58	21.56	19.39
		1710.7 (131979)	23.21	22.51	21.31	19.17
	3RB-High (3)	1779.3 (132665)	23.14	22.21	21.32	19.18
		1745 (132322)	23.31	22.02	21.36	19.21
		1710.7 (131979)	23.24	22.36	21.41	19.26
	3RB-Middle (1)	1779.3 (132665)	23.17	22.29	21.36	19.21
		1745 (132322)	23.31	22.42	21.55	19.38
		1710.7 (131979)	23.25	22.37	21.45	19.29
	3RB-Low (0)	1779.3 (132665)	23.19	22.26	21.37	19.22
		1745 (132322)	23.24	22.42	21.44	19.28
		1710.7 (131979)	23.28	22.41	21.45	19.29
	6RB (0)	1779.3 (132665)	22.24	21.32	20.23	18.24
		1745 (132322)	22.34	21.40	20.28	18.28
		1710.7 (131979)	22.29	21.34	20.29	18.29
3MHz	1RB-High (14)	1778.5 (132657)	23.14	22.47	22.42	19.42
		1745 (132322)	23.32	22.69	22.46	19.46
		1711.5 (131987)	23.25	22.69	22.49	19.48
	1RB-Middle (7)	1778.5 (132657)	23.22	22.58	22.54	19.53
		1745 (132322)	23.33	22.61	22.58	19.56
		1711.5 (131987)	23.25	22.55	21.60	19.42
	1RB-Low (0)	1778.5 (132657)	23.22	22.66	22.43	19.43
		1745 (132322)	23.30	22.61	22.55	19.54
		1711.5 (131987)	23.31	22.67	21.62	19.44
	8RB-High (7)	1778.5 (132657)	22.25	21.38	21.26	18.42
		1745 (132322)	22.37	21.42	21.37	18.51
		1711.5 (131987)	22.40	21.43	21.10	18.28
	8RB-Middle (4)	1778.5 (132657)	22.28	21.43	21.39	18.53
		1745 (132322)	22.35	21.44	21.48	18.61
		1711.5 (131987)	22.37	21.50	20.41	18.37
	8RB-Low (0)	1778.5 (132657)	22.26	21.38	21.28	18.44
		1745 (132322)	22.34	21.36	21.34	18.49
		1711.5 (131987)	22.35	21.50	20.43	18.42
	15RB (0)	1778.5 (132657)	22.32	21.34	21.34	18.49
		1745 (132322)	22.31	21.28	21.27	18.43
		1711.5 (131987)	22.36	21.42	20.45	18.43

5MHz	1RB-High (24)	1777.5 (132647)	23.23	22.45	22.24	19.98	
		1745 (132322)	23.27	22.66	21.69	19.50	
		1712.5 (131997)	23.26	22.58	21.72	19.53	
	1RB-Middle (12)	1777.5 (132647)	23.30	22.57	22.62	20.31	
		1745 (132322)	23.31	22.71	21.64	19.46	
		1712.5 (131997)	23.28	22.51	21.60	19.42	
	1RB-Low (0)	1777.5 (132647)	23.25	22.44	22.62	20.31	
		1745 (132322)	23.23	22.53	21.29	19.15	
		1712.5 (131997)	23.32	22.63	21.38	19.23	
	12RB-High (13)	1777.5 (132647)	22.29	21.33	21.25	19.12	
		1745 (132322)	22.35	21.37	20.41	18.39	
		1712.5 (131997)	22.32	21.42	20.18	18.19	
	12RB-Middle (6)	1777.5 (132647)	22.37	21.40	21.34	19.20	
		1745 (132322)	22.34	21.40	20.40	18.38	
		1712.5 (131997)	22.37	21.39	20.44	18.42	
	12RB-Low (0)	1777.5 (132647)	22.33	21.38	21.29	19.15	
		1745 (132322)	22.30	21.39	20.41	18.39	
		1712.5 (131997)	22.40	21.41	20.45	18.43	
	25RB (0)	1777.5 (132647)	22.25	21.35	20.52	18.49	
		1745 (132322)	22.36	21.38	20.34	18.33	
		1712.5 (131997)	22.32	21.35	20.41	18.39	
	10MHz	1RB-High (49)	1775 (132622)	23.32	22.51	22.35	19.36
			1745 (132322)	23.27	22.73	22.76	19.72
			1715 (132022)	23.18	22.45	22.78	19.74
1RB-Middle (24)		1775 (132622)	23.13	22.50	22.99	19.92	
		1745 (132322)	23.26	22.76	22.87	19.81	
		1715 (132022)	23.17	22.55	22.59	19.57	
1RB-Low (0)		1775 (132622)	23.07	22.71	22.85	19.80	
		1745 (132322)	23.42	22.69	22.45	19.45	
		1715 (132022)	23.13	22.65	22.50	19.49	
25RB-High (25)		1775 (132622)	22.22	21.21	21.32	18.47	
		1745 (132322)	22.35	21.28	21.46	18.59	
		1715 (132022)	22.38	21.35	21.39	18.53	
25RB-Middle (12)		1775 (132622)	22.27	21.29	21.31	18.46	
		1745 (132322)	22.30	21.33	21.41	18.55	
		1715 (132022)	22.45	21.43	21.44	18.57	
25RB-Low (0)		1775 (132622)	22.30	21.28	21.32	18.47	
		1745 (132322)	22.34	21.34	21.37	18.51	
		1715 (132022)	22.42	21.36	21.37	18.51	
50RB (0)		1775 (132622)	22.23	21.26	21.28	18.44	
		1745 (132322)	22.31	21.35	21.34	18.49	
		1715 (132022)	22.41	21.39	21.34	18.49	

15MHz	1RB-High (74)	1772.5 (132597)	23.17	22.45	22.36	19.37
		1745 (132322)	23.33	22.56	22.45	19.45
		1717.5 (132047)	23.28	22.67	22.36	19.37
	1RB-Middle (37)	1772.5 (132597)	23.10	22.50	22.38	19.39
		1745 (132322)	23.24	22.65	22.49	19.48
		1717.5 (132047)	23.28	22.73	22.50	19.49
	1RB-Low (0)	1772.5 (132597)	23.08	22.64	22.34	19.35
		1745 (132322)	23.27	22.50	22.12	19.16
		1717.5 (132047)	23.29	22.60	22.38	19.39
	36RB-High (38)	1772.5 (132597)	22.28	21.34	21.30	18.45
		1745 (132322)	22.37	21.42	21.33	18.48
		1717.5 (132047)	22.38	21.34	21.37	18.51
	36RB-Middle (19)	1772.5 (132597)	22.31	21.29	21.26	18.42
		1745 (132322)	22.32	21.36	21.43	18.57
		1717.5 (132047)	22.40	21.40	21.40	18.54
	36RB-Low (0)	1772.5 (132597)	22.25	21.25	21.26	18.42
		1745 (132322)	22.34	21.32	21.32	18.47
		1717.5 (132047)	22.37	21.31	21.30	18.45
	75RB (0)	1772.5 (132597)	22.19	21.23	21.25	18.41
		1745 (132322)	22.35	21.27	21.37	18.51
		1717.5 (132047)	22.33	21.43	21.38	18.52
20MHz	1RB-High (99)	1770 (132572)	23.33	22.74	22.49	19.48
		1745 (132322)	23.39	22.70	22.45	19.45
		1720 (132072)	23.36	22.57	21.83	19.32
	1RB-Middle (50)	1770 (132572)	23.37	22.62	22.44	19.44
		1745 (132322)	23.43	22.56	22.37	19.38
		1720 (132072)	23.43	22.62	21.69	19.12
	1RB-Low (0)	1770 (132572)	23.36	22.67	22.65	19.62
		1745 (132322)	23.52	22.78	22.37	19.38
		1720 (132072)	23.51	22.84	21.66	19.16
	50RB-High (50)	1770 (132572)	22.44	21.45	21.45	18.58
		1745 (132322)	22.50	21.50	21.42	18.56
		1720 (132072)	22.52	21.52	20.50	18.04
	50RB-Middle (25)	1770 (132572)	22.33	21.42	21.44	18.57
		1745 (132322)	22.53	21.39	21.35	18.50
		1720 (132072)	22.52	21.57	20.54	18.09
	50RB-Low (0)	1770 (132572)	22.39	21.51	21.41	18.55
		1745 (132322)	22.50	21.43	21.38	18.52
		1720 (132072)	22.40	21.48	20.47	18.07
	100RB (0)	1770 (132572)	22.40	21.47	21.50	18.63
		1745 (132322)	22.46	21.47	21.52	18.64
		1720 (132072)	22.55	21.53	20.52	18.05

LTE Band66 DS10

BANDWIDTH	Number of RBs	Frequency	QPSK	16QAM	64QAM	256QAM
1.4MHz	1RB-High (5)	1779.3 (132665)	14.45	14.94	14.91	14.87
		1745 (132322)	14.64	14.93	15.05	15.01
		1710.7 (131979)	14.58	15.00	14.86	14.82
	1RB-Middle (3)	1779.3 (132665)	14.61	14.86	14.90	14.86
		1745 (132322)	14.70	15.24	15.00	14.96
		1710.7 (131979)	14.70	15.11	15.09	15.05
	1RB-Low (0)	1779.3 (132665)	14.51	15.03	14.81	14.77
		1745 (132322)	14.65	15.08	14.99	14.95
		1710.7 (131979)	14.69	14.96	13.87	13.83
	3RB-High (3)	1779.3 (132665)	14.56	14.68	14.77	14.73
		1745 (132322)	14.67	14.77	14.88	14.84
		1710.7 (131979)	14.75	14.81	14.88	14.84
	3RB-Middle (1)	1779.3 (132665)	14.68	14.85	14.81	14.77
		1745 (132322)	14.76	14.69	14.73	14.69
		1710.7 (131979)	14.78	14.84	14.99	14.95
	3RB-Low (0)	1779.3 (132665)	14.56	14.77	14.78	14.74
		1745 (132322)	14.67	14.87	14.84	14.80
		1710.7 (131979)	14.72	14.73	14.91	14.87
	6RB (0)	1779.3 (132665)	14.67	14.81	14.69	14.65
		1745 (132322)	14.81	14.82	14.75	14.71
		1710.7 (131979)	14.70	14.88	14.79	14.75
3MHz	1RB-High (14)	1778.5 (132657)	14.69	14.95	14.80	14.76
		1745 (132322)	14.73	15.16	13.93	13.89
		1711.5 (131987)	14.77	15.07	14.84	14.80
	1RB-Middle (7)	1778.5 (132657)	14.58	14.96	14.92	14.88
		1745 (132322)	14.75	15.13	14.01	13.97
		1711.5 (131987)	14.75	15.10	14.98	14.94
	1RB-Low (0)	1778.5 (132657)	14.66	15.04	14.90	14.86
		1745 (132322)	14.69	15.09	14.00	13.96
		1711.5 (131987)	14.80	15.17	15.13	15.09
	8RB-High (7)	1778.5 (132657)	14.74	14.83	14.80	14.76
		1745 (132322)	14.76	14.88	14.83	14.79
		1711.5 (131987)	14.77	14.92	14.87	14.83
	8RB-Middle (4)	1778.5 (132657)	14.71	14.81	14.81	14.77
		1745 (132322)	14.84	14.97	14.93	14.89
		1711.5 (131987)	14.83	14.95	14.91	14.87
	8RB-Low (0)	1778.5 (132657)	14.75	14.80	14.87	14.83
		1745 (132322)	14.79	14.89	14.85	14.81
		1711.5 (131987)	14.76	14.94	14.89	14.85
	15RB (0)	1778.5 (132657)	14.72	14.82	14.37	14.33
		1745 (132322)	14.76	14.84	14.78	14.74
		1711.5 (131987)	14.77	14.88	14.16	14.12

5MHz	1RB-High (24)	1777.5 (132647)	14.50	14.98	14.93	14.89
		1745 (132322)	14.66	15.19	14.87	14.83
		1712.5 (131997)	14.63	15.08	14.88	14.84
	1RB-Middle (12)	1777.5 (132647)	14.69	15.06	14.96	14.92
		1745 (132322)	14.73	15.15	14.96	14.92
		1712.5 (131997)	14.71	15.12	15.01	14.97
	1RB-Low (0)	1777.5 (132647)	14.56	15.01	15.03	14.99
		1745 (132322)	14.63	14.93	14.99	14.95
		1712.5 (131997)	14.74	15.08	15.08	15.04
	12RB-High (13)	1777.5 (132647)	14.73	14.78	14.55	14.51
		1745 (132322)	14.81	14.81	14.85	14.81
		1712.5 (131997)	14.81	14.80	14.89	14.85
	12RB-Middle (6)	1777.5 (132647)	14.82	14.87	14.80	14.76
		1745 (132322)	14.72	14.81	14.82	14.78
		1712.5 (131997)	14.79	14.88	14.94	14.90
	12RB-Low (0)	1777.5 (132647)	14.73	14.77	14.82	14.78
		1745 (132322)	14.79	14.77	14.79	14.75
		1712.5 (131997)	14.84	14.87	14.85	14.81
	25RB (0)	1777.5 (132647)	14.71	14.79	14.78	14.74
		1745 (132322)	14.77	14.79	14.79	14.75
		1712.5 (131997)	14.81	14.83	14.84	14.80
10MHz	1RB-High (49)	1775 (132622)	14.41	15.03	14.78	14.74
		1745 (132322)	14.63	15.03	14.93	14.89
		1715 (132022)	14.64	14.99	14.86	14.82
	1RB-Middle (24)	1775 (132622)	14.56	15.13	14.92	14.88
		1745 (132322)	14.73	15.11	15.06	15.02
		1715 (132022)	14.58	15.06	14.86	14.82
	1RB-Low (0)	1775 (132622)	14.66	15.31	14.78	14.74
		1745 (132322)	14.64	15.26	14.98	14.94
		1715 (132022)	14.75	15.18	15.00	14.96
	25RB-High (25)	1775 (132622)	14.81	14.78	14.78	14.74
		1745 (132322)	14.69	14.71	14.88	14.84
		1715 (132022)	14.79	14.80	14.83	14.79
	25RB-Middle (12)	1775 (132622)	14.70	14.71	14.72	14.68
		1745 (132322)	14.71	14.79	14.68	14.64
		1715 (132022)	14.85	14.88	14.74	14.70
	25RB-Low (0)	1775 (132622)	14.69	14.76	14.74	14.70
		1745 (132322)	14.73	14.86	14.77	14.73
		1715 (132022)	14.84	14.82	14.88	14.84
	50RB (0)	1775 (132622)	14.68	14.76	15.12	15.08
		1745 (132322)	14.78	14.69	14.83	14.79
		1715 (132022)	14.73	14.76	14.80	14.76

15MHz	1RB-High (74)	1772.5 (132597)	14.69	15.06	14.84	14.80
		1745 (132322)	14.61	14.91	15.06	15.02
		1717.5 (132047)	14.63	15.05	14.79	14.75
	1RB-Middle (37)	1772.5 (132597)	14.69	14.98	14.79	14.75
		1745 (132322)	14.67	15.09	15.01	14.97
		1717.5 (132047)	14.71	15.12	15.02	14.98
	1RB-Low (0)	1772.5 (132597)	14.69	15.19	15.15	15.11
		1745 (132322)	14.64	15.05	15.21	15.17
		1717.5 (132047)	14.63	15.10	15.18	15.14
	36RB-High (38)	1772.5 (132597)	14.83	14.81	14.49	14.45
		1745 (132322)	14.81	14.84	14.86	14.82
		1717.5 (132047)	14.78	14.86	14.85	14.81
	36RB-Middle (19)	1772.5 (132597)	14.80	14.70	14.74	14.70
		1745 (132322)	14.74	14.83	14.84	14.80
		1717.5 (132047)	14.83	14.82	14.85	14.81
	36RB-Low (0)	1772.5 (132597)	14.70	14.68	14.80	14.76
		1745 (132322)	14.81	14.78	14.85	14.81
		1717.5 (132047)	14.72	14.75	14.81	14.77
	75RB (0)	1772.5 (132597)	14.70	14.68	14.66	14.62
		1745 (132322)	14.76	14.78	14.84	14.80
		1717.5 (132047)	14.76	14.86	14.90	14.86
20MHz	1RB-High (99)	1770 (132572)	14.41	14.69	14.61	14.57
		1745 (132322)	14.50	14.87	14.54	14.50
		1720 (132072)	14.39	14.76	14.92	14.88
	1RB-Middle (50)	1770 (132572)	14.30	14.82	14.68	14.64
		1745 (132322)	14.45	14.78	14.56	14.52
		1720 (132072)	14.42	14.80	14.59	14.55
	1RB-Low (0)	1770 (132572)	14.52	14.83	14.71	14.67
		1745 (132322)	14.40	15.00	14.67	14.63
		1720 (132072)	14.48	14.86	14.64	14.60
	50RB-High (50)	1770 (132572)	14.57	14.54	14.53	14.49
		1745 (132322)	14.56	14.55	14.61	14.57
		1720 (132072)	14.55	14.61	14.69	14.65
	50RB-Middle (25)	1770 (132572)	14.47	14.59	14.60	14.56
		1745 (132322)	14.50	14.59	14.61	14.57
		1720 (132072)	14.53	14.58	14.60	14.56
	50RB-Low (0)	1770 (132572)	14.49	14.56	14.56	14.52
		1745 (132322)	14.53	14.55	14.56	14.52
		1720 (132072)	14.47	14.60	14.60	14.56
	100RB (0)	1770 (132572)	14.60	14.58	14.57	14.53
		1745 (132322)	14.44	14.50	14.62	14.58
		1720 (132072)	14.62	14.64	14.66	14.62



LTE Carrier Aggregation Conducted Power (Downlink)

DS11

Table with columns: DL LTE CA Class, PCC, SCC1, SCC2, SCC3, SCC4, Power. Rows include various carrier aggregation configurations like 2A-2A-5A-6A-6A, 2A-2A-5A-6A, etc.

DS10

Table with columns: DL LTE CA Class, PCC, SCC1, SCC2, SCC3, SCC4, Power. Rows include various carrier aggregation configurations like 2A-2A-5A-6A-6A, 2A-2A-5A-6A, etc.

LTE Carrier Aggregation Conducted Power (Uplink)
DS11

UL LTE CA Class	PCC					SCC				Power
	PCC Bandwidth	UL channel	DL channel	UL RB	UL RB OFFSET	SCC Bandwidth	DL channel	UL RB	UL RB OFFSET	conducted power (dBm)
CA 5B	5M	20425	2425	1	24	3M	2464	1	0	22.96
CA 5B	10M	20450	2450	1	49	10M	2549	1	0	22.95
CA 5B	10M	20600	2600	1	49	5M	2528	1	0	22.81
CA 5B	10M	20600	2600	1	49	10M	2501	1	0	22.83
CA 5B	5M	20425	2425	1	0	3M	2464	1	14	22.93
CA 5B	10M	20450	2450	1	0	10M	2549	1	49	23.03
CA 5B	10M	20600	2600	1	0	5M	2528	1	24	23.07
CA 5B	10M	20600	2600	1	0	10M	2501	1	49	23.05

UL LTE CA Class	PCC					SCC				Power
	PCC Bandwidth	UL channel	DL channel	UL RB	UL RB OFFSET	SCC Bandwidth	DL channel	UL RB	UL RB OFFSET	conducted power (dBm)
CA 66B	15M	132047	66511	1	74	5M	66604	1	0	23.29
CA 66B	10M	132622	67086	1	49	5M	67158	1	0	23.36
CA 66B	15M	132597	67061	1	74	5M	67154	1	0	23.26
CA 66B	10M	132622	67086	1	49	5M	67014	1	0	23.38
CA 66B	15M	132597	67061	1	74	5M	66968	1	0	23.3
CA 66B	10M	132622	67086	1	49	10M	66987	1	0	23.35
CA 66B	15M	132047	66511	1	0	5M	66604	1	24	23.21
CA 66B	10M	132622	67086	1	0	5M	67158	1	24	23.42
CA 66B	15M	132597	67061	1	0	5M	67154	1	24	23.43
CA 66B	10M	132622	67086	1	0	5M	67014	1	24	23.31
CA 66B	15M	132597	67061	1	0	5M	66968	1	24	23.31
CA 66B	10M	132622	67086	1	0	10M	66987	1	49	23.38

UL LTE CA Class	PCC					SCC				Power
	PCC Bandwidth	UL channel	DL channel	UL RB	UL RB OFFSET	SCC Bandwidth	DL channel	UL RB	UL RB OFFSET	conducted power (dBm)
CA 66C	15M	132047	66511	1	74	10M	66631	1	0	23.31
CA 66C	20M	132072	66536	1	99	10M	66680	1	0	23.39
CA 66C	15M	132072	66511	1	74	15M	66661	1	0	23.25
CA 66C	20M	132072	66536	1	99	5M	66653	1	0	23.29
CA 66C	20M	132072	66536	1	99	20M	66734	1	0	23.26
CA 66C	10M	132622	67086	1	49	15M	67206	1	0	23.25
CA 66C	20M	132572	67036	1	99	10M	67180	1	0	23.41
CA 66C	15M	132597	67061	1	74	15M	67211	1	0	23.38
CA 66C	15M	132597	67061	1	74	20M	67232	1	0	23.39
CA 66C	20M	132572	67036	1	99	15M	67207	1	0	23.41
CA 66C	20M	132572	67036	1	99	5M	67153	1	0	23.33
CA 66C	5M	132647	67111	1	24	20M	67228	1	0	23.36
CA 66C	20M	132572	67036	1	99	20M	67234	1	0	23.31
CA 66C	15M	132047	66511	1	0	10M	66631	1	49	23.35
CA 66C	20M	132072	66536	1	0	10M	66680	1	49	23.22
CA 66C	15M	132072	66511	1	0	15M	66661	1	74	23.3
CA 66C	20M	132072	66536	1	0	5M	66653	1	24	23.32
CA 66C	20M	132072	66536	1	0	20M	66734	1	99	23.37
CA 66C	10M	132622	67086	1	0	15M	67206	1	74	23.38
CA 66C	20M	132572	67036	1	0	10M	67180	1	49	23.43
CA 66C	15M	132597	67061	1	0	15M	67211	1	74	23.48
CA 66C	15M	132597	67061	1	0	20M	67232	1	99	23.44
CA 66C	20M	132572	67036	1	0	15M	67207	1	74	23.45
CA 66C	20M	132572	67036	1	0	5M	67153	1	24	23.43
CA 66C	5M	132647	67111	1	0	20M	67228	1	99	23.4
CA 66C	20M	132572	67036	1	0	20M	67234	1	99	23.49

DS10

UL LTE CA Class	PCC					SCC				Power
	PCC Bandwidth	UL_channel	DL_channel	UL_RB	UL_RB_OFFSET	SCC Bandwidth	DL_channel	UL_RB	UL_RB_OFFSET	conducted power (dBm)
CA 5B	5M	20425	2425	1	24	3M	2464	1	0	14.99
CA 5B	10M	20450	2450	1	49	5M	2522	1	0	14.98
CA 5B	10M	20450	2450	1	49	10M	2549	1	0	14.88
CA 5B	10M	20600	2600	1	49	5M	2528	1	0	14.97
CA 5B	10M	20600	2600	1	49	10M	2501	1	0	14.98
CA 5B	5M	20425	2425	1	0	3M	2464	1	14	15.13
CA 5B	10M	20450	2450	1	0	5M	2522	1	24	15.03
CA 5B	10M	20450	2450	1	0	10M	2549	1	49	15.04
CA 5B	10M	20600	2600	1	0	5M	2528	1	24	15.15
CA 5B	10M	20600	2600	1	0	10M	2501	1	49	15.05

UL LTE CA Class	PCC					SCC				Power
	PCC Bandwidth	UL_channel	DL_channel	UL_RB	UL_RB_OFFSET	SCC Bandwidth	DL_channel	UL_RB	UL_RB_OFFSET	conducted power (dBm)
CA 66B	15M	132047	66511	1	74	5M	66604	1	0	14.38
CA 66B	10M	132622	67086	1	49	5M	67158	1	0	14.36
CA 66B	15M	132597	67061	1	74	5M	67154	1	0	14.39
CA 66B	10M	132622	67086	1	49	5M	67014	1	0	14.34
CA 66B	15M	132597	67061	1	74	5M	66968	1	0	14.42
CA 66B	10M	132622	67086	1	49	10M	66987	1	0	14.4
CA 66B	15M	132047	66511	1	0	5M	66604	1	24	14.41
CA 66B	10M	132622	67086	1	0	5M	67158	1	24	14.45
CA 66B	15M	132597	67061	1	0	5M	67154	1	24	14.48
CA 66B	10M	132622	67086	1	0	5M	67014	1	24	14.37
CA 66B	15M	132597	67061	1	0	5M	66968	1	24	14.47
CA 66B	10M	132622	67086	1	0	10M	66987	1	49	14.37

UL LTE CA Class	PCC					SCC				Power
	PCC Bandwidth	UL_channel	DL_channel	UL_RB	UL_RB_OFFSET	SCC Bandwidth	DL_channel	UL_RB	UL_RB_OFFSET	conducted power (dBm)
CA 66C	15M	132047	66511	1	74	10M	66631	1	0	14.38
CA 66C	20M	132072	66536	1	99	10M	66680	1	0	14.31
CA 66C	15M	132072	66511	1	74	15M	66661	1	0	14.27
CA 66C	20M	132072	66536	1	99	5M	66653	1	0	14.24
CA 66C	20M	132072	66536	1	99	20M	66734	1	0	14.31
CA 66C	10M	132622	67086	1	49	15M	67206	1	0	14.38
CA 66C	20M	132572	67036	1	99	10M	67180	1	0	14.44
CA 66C	15M	132597	67061	1	74	15M	67211	1	0	14.29
CA 66C	15M	132597	67061	1	74	20M	67232	1	0	14.39
CA 66C	20M	132572	67036	1	99	15M	67207	1	0	14.42
CA 66C	20M	132572	67036	1	99	5M	67153	1	0	14.32
CA 66C	5M	132647	67111	1	24	20M	67228	1	0	14.39
CA 66C	20M	132572	67036	1	99	20M	67234	1	0	14.41
CA 66C	15M	132047	66511	1	0	10M	66631	1	49	14.41
CA 66C	20M	132072	66536	1	0	10M	66680	1	49	14.46
CA 66C	15M	132072	66511	1	0	15M	66661	1	74	14.39
CA 66C	20M	132072	66536	1	0	5M	66653	1	24	14.43
CA 66C	20M	132072	66536	1	0	20M	66734	1	99	14.41
CA 66C	10M	132622	67086	1	0	15M	67206	1	74	14.39
CA 66C	20M	132572	67036	1	0	10M	67180	1	49	14.52
CA 66C	15M	132597	67061	1	0	15M	67211	1	74	14.44
CA 66C	15M	132597	67061	1	0	20M	67232	1	99	14.41
CA 66C	20M	132572	67036	1	0	15M	67207	1	74	14.48
CA 66C	20M	132572	67036	1	0	5M	67153	1	24	14.42
CA 66C	5M	132647	67111	1	0	20M	67228	1	99	14.5
CA 66C	20M	132572	67036	1	0	20M	67234	1	99	14.48

12.3 Wi-Fi and BT Measurement result

The maximum output power of BT is 7.77dBm.

The maximum tune up of BT is 8dBm.

WIFI Tune up

		Channel\data rate		Sensor OFF Tune up	Sensor ON Tune up
WLAN2450	802.11b	11(2462MHz)	1Mbps	17	5.5
		6(2437(MHz)		17	5.5
		1(2412MHz)		17	5.5
	802.11g	11(2462MHz)	6Mbps	16	5.5
		6(2437(MHz)		16	5.5
		1(2412MHz)		16	5.5
	802.11n-20MHz	11(2462MHz)	MCS0	16	5.5
		6(2437(MHz)		16	5.5
		1(2412MHz)		16	5.5
	802.11n-40MHz	9(2452MHz)	MCS0	15	5.5
		6(2437MHz)		15	5.5
		3(2422MHz)		15	5.5
	802.11ac-20MHz	11(2462MHz)	MCS0	16	5.5
		6(2437(MHz)		16	5.5
		1(2412MHz)		16	5.5
	802.11ac-40MHz	9(2452MHz)	MCS0	15	5.5
		6(2437MHz)		15	5.5
		3(2422MHz)		15	5.5
	802.11ax-20MHz	11(2462MHz)	MCS0	16	5.5
		6(2437(MHz)		16	5.5
1(2412MHz)		16		5.5	
802.11ax-40MHz	9(2452MHz)	MCS0	15	5.5	
	6(2437MHz)		15	5.5	
	3(2422MHz)		15	5.5	

	Mode	Channel	Frequency	sensor off Tune up	sensor on Tune up
			(MHz)		
5GHz WLAN	802.11a 6Mbps	36-64	5180-5320	16	3
		100-144	5500-5720	16	3
		149-165	5745-5825	16	7
		169-177	5745-5885	12.7	3.5
	802.11a 9Mbps	36-64	5180-5320	15.5	2.5
		100-144	5500-5720	15.5	2.5
		149-165	5745-5825	15.5	6.5
		169-177	5745-5885	12.5	3
	802.11a 12Mbps	36-64	5180-5320	15.5	2.5
		100-144	5500-5720	15.5	2.5
		149-165	5745-5825	15.5	6.5
		169-177	5745-5885	12.5	3
	802.11a 18Mbps	36-64	5180-5320	15.5	2.5
		100-144	5500-5720	15.5	2.5
		149-165	5745-5825	15.5	6.5
		169-177	5745-5885	12.5	3
	802.11a 24Mbps	36-64	5180-5320	15.5	2.5
		100-144	5500-5720	15.5	2.5
		149-165	5745-5825	15.5	6.5
		169-177	5745-5885	12.5	3
	802.11a 36Mbps	36-64	5180-5320	15.5	2.5
		100-144	5500-5720	15.5	2.5
		149-165	5745-5825	15.5	6.5
		169-177	5745-5885	12.5	3
	802.11a 48Mbps	36-64	5180-5320	15.5	2.5
		100-144	5500-5720	15.5	2.5
		149-165	5745-5825	15.5	6.5
		169-177	5745-5885	12.5	3
	802.11a 54Mbps	36-64	5180-5320	15.5	2.5
		100-144	5500-5720	15.5	2.5
		149-165	5745-5825	15.5	6.5
		169-177	5745-5885	12.5	3
	802.11n-HT20 MCS0-7	36-64	5180-5320	15.5	2.5
		100-144	5500-5720	15.5	2.5
		149-165	5745-5825	15.5	6.5
		169-177	5745-5885	12	3
	802.11n-HT40 MCS0-7	36-64	5180-5320	15.5	2.5
		100-144	5500-5720	15.5	2.5
		149-165	5745-5825	15.5	6.5
		167-175	5835-5875	12	3
802.11AC-HT20 MCS0-9	36-64	5180-5320	15.5	2.5	
	100-144	5500-5720	15.5	2.5	
	149-165	5745-5825	15.5	6.5	
	169-177	5745-5885	12	3	
802.11AC-HT40 MCS0-9	36-64	5180-5320	15.5	2.5	
	100-144	5500-5720	15.5	2.5	
	149-165	5745-5825	15.5	6.5	
	167-175	5835-5875	12.5	3	
802.11AC-HT80 MCS0-9	36-64	5180-5320	15.5	2.5	
	100-144	5500-5720	15.5	2.5	
	149-165	5745-5825	15.5	6.5	
	171	5855	11	3	
802.11AC-HT160 MCS0-9	36-64	5180-5320	15.5	2.5	
	100-144	5500-5720	15.5	2.5	
	149-165	5745-5825	15.5	6.5	
	163	5815	12.5	3	

	Mode	Channel	Tune up
6GHz WLAN	802.11a 6Mbps-54Mbps	1-25	3.5
		29-93	4
		97-101	5
		105-113	4
		117-141	3
		145-185	4
		189-205	3.5
		209-233	3
	802.11AX-HT20	1-25	3
		29-93	3.5
		97-101	4.5
		105-113	3.5
		117-141	2.5
		145-185	3.5
		189-205	3
		209-233	2.5
	802.11AX-HT40	1-25	3
		29-93	3.5
		97-101	4.5
		105-113	3.5
		117-141	2.5
		145-185	3.5
		189-205	3
		209-233	2.5
	802.11AX-HT80	1-25	3
		29-93	3.5
		97-101	4.5
		105-113	3.5
		117-141	2.5
		145-185	3.5
		189-205	3
		209-233	2.5
	802.11AX-HT160	1-25	3
		29-93	3.5
		97-101	4.5
		105-113	3.5
117-141		2.5	
145-185		3.5	
189-205		3	
209-233		2.5	

The average conducted power for Wi-Fi is as following:

The conducted output power for WiFi 2.4G-ANT4 power is as following-sensor off

802.11b	
Channel rate	1Mbps
1	15.99
6	15.91
11	15.56
802.11g	
Channel rate	6Mbps
1	15.07
6	15.24
11	14.72
802.11n-20	
Channel rate	MCS0
1	14.89
6	15.03
11	14.82
802.11n-40	
Channel rate	MCS0
3	14.46
6	14.49
9	13.98
802.11ax-20	
Channel rate	MCS0
1	14.79
6	14.89
11	13.77
802.11ax-40	
Channel rate	MCS0
3	14.26
6	14.34
9	13.82

The conducted output power for WiFi 2.4G-ANT4 power is as following- sensor on

802.11b	Channel data	1Mbps
WLAN2450	11(2462MHz)	4.27
	6(2437(MHz)	4.26
	1(2412MHz)	5.09
802.11g	Channel data	6Mbps
WLAN2450	11(2462MHz)	4.47
	6(2437(MHz)	4.22
	1(2412MHz)	4.68
802.11n-20MHz	Channel data	MCS0
WLAN2450	11(2462MHz)	4.64
	6(2437(MHz)	4.42
	1(2412MHz)	4.82
802.11n-40MHz	Channel data	MCS0
WLAN2450	9(2452MHz)	4.70
	6(2437(MHz)	4.65
	3(2422MHz)	4.85
802.11ax-20MHz	Channel data	MCS0
WLAN2450	11(2462MHz)	4.74
	6(2437(MHz)	4.45
	1(2412MHz)	4.93
802.11ax-40MHz	Channel data	MCS0
WLAN2450	9(2452MHz)	4.63
	6(2437(MHz)	4.82
	3(2422MHz)	5.02



The conducted output power for WiFi 2.4G-ANT5 power is as following- sensor off

802.11b	
Channel\ rate	1Mbps
1	15.18
6	15
11	14.88
802.11g	
Channel\ rate	6Mbps
1	14.41
6	14.36
11	14.22
802.11n-20	
Channel\ rate	MCS0
1	14.28
6	14.12
11	14.03
802.11n-40	
Channel\ rate	MCS0
3	13.59
6	13.56
9	13.35
802.11ax-20	
Channel\ rate	MCS0
1	14.08
6	14.09
11	14.05
802.11ax-40	
Channel\ rate	MCS0
3	13.48
6	13.44
9	13.29

The conducted output power for WiFi 2.4G-ANT5 power is as following- sensor on

802.11b	Channel\data	1Mbps
WLAN2450	11(2462MHz)	4.53
	6(2437(MHz)	4.72
	1(2412MHz)	4.76
802.11g	Channel\data	6Mbps
WLAN2450	11(2462MHz)	4.01
	6(2437(MHz)	4.21
	1(2412MHz)	4.09
802.11n-20MHz	Channel\data	MCS0
WLAN2450	11(2462MHz)	4.14
	6(2437(MHz)	4.47
	1(2412MHz)	4.20
802.11n-40MHz	Channel\data	MCS0
WLAN2450	9(2452MHz)	4.47
	6(2437(MHz)	4.32
	3(2422MHz)	4.29
802.11ax-20MHz	Channel\data	MCS0
WLAN2450	11(2462MHz)	4.29
	6(2437(MHz)	4.62
	1(2412MHz)	4.29
802.11ax-40MHz	Channel\data	MCS0
WLAN2450	9(2452MHz)	4.34
	6(2437(MHz)	4.29
	3(2422MHz)	4.19



The conducted output power for WiFi 5G-ANT4 power is as following- sensor off

802.11a(dBm)	
Channel\data rate	6Mbps
36(5180 MHz)	15.12
40(5200 MHz)	15.45
44(5220 MHz)	15.51
48(5240 MHz)	15.26
52(5260 MHz)	15.18
56(5280 MHz)	14.96
60(5300 MHz)	14.68
64(5320 MHz)	14.61
100(5500 MHz)	14.41
104(5520 MHz)	14.42
108(5540 MHz)	14.62
112(5560 MHz)	15.07
116(5580 MHz)	15.52
120(5600 MHz)	15.59
124(5620 MHz)	15.39
128(5640 MHz)	15.13
132(5660 MHz)	14.86
136(5680 MHz)	14.91
140(5700 MHz)	15.26
144(5720 MHz)	15.33
149(5745 MHz)	15.47
153(5765 MHz)	15.48
157(5785 MHz)	15.46
161(5805 MHz)	15.42
165(5825 MHz)	15.14
5845MHz (Ch169)	11.77
5865MHz (Ch173)	11.6
5885MHz(Ch177)	11.52

The conducted output power for WiFi 5G-ANT4 power is as following- sensor on

802.11a(dBm)	
Channel\data rate	6Mbps
36(5180 MHz)	2.08
40(5200 MHz)	2.04
44(5220 MHz)	2.19
48(5240 MHz)	1.51
52(5260 MHz)	1.97
56(5280 MHz)	1.88
60(5300 MHz)	1.84
64(5320 MHz)	1.78
100(5500 MHz)	1.81
104(5520 MHz)	1.79
108(5540 MHz)	1.97
112(5560 MHz)	1.87
116(5580 MHz)	2.46
120(5600 MHz)	2.34
124(5620 MHz)	2.76
128(5640 MHz)	2.46
132(5660 MHz)	2.56
136(5680 MHz)	2.74
140(5700 MHz)	2.87
144(5720 MHz)	2.73
149(5745 MHz)	5.83
153(5765 MHz)	5.80
157(5785 MHz)	5.65
161(5805 MHz)	5.73
165(5825 MHz)	5.62
169(5845 MHz)	2.98
173(5865 MHz)	2.84
177(5885 MHz)	2.97

The conducted output power for WiFi 5G-ANT5 power is as following- sensor off

802.11a(dBm)	
Channel\data rate	6Mbps
36(5180 MHz)	15.62
40(5200 MHz)	15.78
44(5220 MHz)	15.62
48(5240 MHz)	15.36
52(5260 MHz)	15.20
56(5280 MHz)	15.38
60(5300 MHz)	15.41
64(5320 MHz)	15.56
100(5500 MHz)	15.19
104(5520 MHz)	15.26
108(5540 MHz)	15.40
112(5560 MHz)	15.56
116(5580 MHz)	15.04
120(5600 MHz)	14.66
124(5620 MHz)	14.91
128(5640 MHz)	15.19
132(5660 MHz)	14.92
136(5680 MHz)	15.02
140(5700 MHz)	15.33
144(5720 MHz)	15.47
149(5745 MHz)	15.58
153(5765 MHz)	15.79
157(5785 MHz)	15.73
161(5805 MHz)	15.24
165(5825 MHz)	15.88
5845MHz (Ch169)	11.15
5865MHz (Ch173)	11.18
5885MHz(Ch177)	11.22

The conducted output power for WiFi 5G-ANT5 power is as following- sensor on

802.11a(dBm)	
Channel\data rate	6Mbps
36(5180 MHz)	2.43
40(5200 MHz)	2.30
44(5220 MHz)	2.53
48(5240 MHz)	2.52
52(5260 MHz)	1.87
56(5280 MHz)	2.12
60(5300 MHz)	2.36
64(5320 MHz)	2.69
100(5500 MHz)	2.02
104(5520 MHz)	1.95
108(5540 MHz)	1.92
112(5560 MHz)	1.97
116(5580 MHz)	2.15
120(5600 MHz)	2.34
124(5620 MHz)	2.37
128(5640 MHz)	2.30
132(5660 MHz)	2.36
136(5680 MHz)	2.41
140(5700 MHz)	2.58
144(5720 MHz)	2.46
149(5745 MHz)	5.55
153(5765 MHz)	5.64
157(5785 MHz)	5.71
161(5805 MHz)	6.46
165(5825 MHz)	6.12
169(5845 MHz)	3.22
173(5865 MHz)	3.09
177(5885 MHz)	2.79

The conducted output power for WiFi 6G-ANT4 power is as following

802.11a(dBm)	
Channel	data rate 6Mbps
1(5955 MHz)	2.68
5(5975 MHz)	2.56
9(5995 MHz)	2.77
13(6015 MHz)	2.70
17(6035 MHz)	2.55
21(6055 MHz)	2.39
25(6075 MHz)	2.34
29(6095 MHz)	2.52
33(6115 MHz)	2.85
37(6135 MHz)	2.58
41(6155 MHz)	2.62
45(6175 MHz)	2.10
49(6195 MHz)	2.43
53(6215 MHz)	2.66
57(6235 MHz)	2.58
61(6255 MHz)	2.30
65(6275 MHz)	2.36
69(6295 MHz)	2.78
73(6315 MHz)	2.53
77(6335 MHz)	2.75
81(6355 MHz)	2.70
85(6375 MHz)	2.41
89(6395 MHz)	2.37
93(6415 MHz)	2.03
97(6435 MHz)	3.42
101(6455 MHz)	3.91
105(6475 MHz)	2.25
109(6495 MHz)	2.69
113(6515 MHz)	2.03
117(6535 MHz)	2.91
121(6555 MHz)	2.61
125(6575 MHz)	2.41
129(6595 MHz)	2.38
133(6615 MHz)	2.82
137(6635 MHz)	2.67
141(6655 MHz)	2.72
145(6675 MHz)	3.69
149(6695 MHz)	3.74
153(6715 MHz)	3.53
157(6735 MHz)	3.29
161(6755 MHz)	3.15
165(6775 MHz)	3.22
169(6795 MHz)	3.87
173(6815 MHz)	3.77
177(6835 MHz)	3.72
181(6855 MHz)	3.51
185(6875 MHz)	3.27
189(6895 MHz)	3.25
193(6915 MHz)	3.22
197(6935 MHz)	3.13
201(6955 MHz)	2.95
205(6975 MHz)	3.35
209(6995 MHz)	2.92
213(7015 MHz)	2.60
217(7035 MHz)	2.57
221(7055 MHz)	2.41
225(7075 MHz)	2.89
229(7095 MHz)	2.85
233(7115 MHz)	2.64

The conducted output power for WiFi 6G-ANT5 power is as following

802.11a(dBm)	
Channel\data rate	6Mbps
1(5955 MHz)	1.78
5(5975 MHz)	1.73
9(5995 MHz)	2.15
13(6015 MHz)	2.16
17(6035 MHz)	2.68
21(6055 MHz)	2.89
25(6075 MHz)	2.93
29(6095 MHz)	3.07
33(6115 MHz)	2.98
37(6135 MHz)	3.12
41(6155 MHz)	3.08
45(6175 MHz)	2.73
49(6195 MHz)	2.91
53(6215 MHz)	3.46
57(6235 MHz)	3.21
61(6255 MHz)	3.23
65(6275 MHz)	3.16
69(6295 MHz)	2.18
73(6315 MHz)	2.25
77(6335 MHz)	2.42
81(6355 MHz)	2.35
85(6375 MHz)	2.46
89(6395 MHz)	2.54
93(6415 MHz)	2.63
97(6435 MHz)	4.71
101(6455 MHz)	4.98
105(6475 MHz)	2.53
109(6495 MHz)	2.66
113(6515 MHz)	2.41
117(6535 MHz)	2.26
121(6555 MHz)	2.20
125(6575 MHz)	2.11
129(6595 MHz)	2.24
133(6615 MHz)	2.12
137(6635 MHz)	2.03
141(6655 MHz)	2.06
145(6675 MHz)	2.04
149(6695 MHz)	2.08
153(6715 MHz)	2.13
157(6735 MHz)	2.12
161(6755 MHz)	2.04
165(6775 MHz)	2.09
169(6795 MHz)	2.01
173(6815 MHz)	2.06
177(6835 MHz)	2.56
181(6855 MHz)	2.26
185(6875 MHz)	2.02
189(6895 MHz)	2.02
193(6915 MHz)	1.90
197(6935 MHz)	1.60
201(6955 MHz)	1.64
205(6975 MHz)	1.98
209(6995 MHz)	1.65
213(7015 MHz)	1.81
217(7035 MHz)	1.89
221(7055 MHz)	1.65
225(7075 MHz)	2.15
229(7095 MHz)	2.18
233(7115 MHz)	1.93

12.4 NR 5G Measurement result

N2 DS11

No.	Test Freq Description	5G-n2							Power Results (dBm)	
		SCS (kHz)	NR BW (MHz)	Modulation	RB allocation		NR Test Freq. (MHz)	NR Test CH.	Tune up	n8
1	High	15	5	DFT-s-OFDM QPSK	Inner_Full	12_6	1907.5	381500	25.00	23.87
2	Middle	15	5	DFT-s-OFDM QPSK	Inner_Full	12_6	1880	376000	25.00	23.90
3	Low	15	5	DFT-s-OFDM QPSK	Inner_Full	12_6	1852.5	370500	25.00	23.97
4	High	15	20	DFT-s-OFDM QPSK	Inner_Full	50_25	1900	380000	25.00	23.92
5	Middle	15	20	DFT-s-OFDM QPSK	Inner_Full	50_25	1880	376000	25.00	24.27
6	Low	15	20	DFT-s-OFDM QPSK	Inner_Full	50_25	1860	372000	25.00	24.05

According to the table above, the maximum power configuration is selected as the default test configuration

No.	Test Freq Description	5G-n2							Power Results (dBm)	
		SCS (kHz)	NR BW (MHz)	Modulation	RB allocation		NR Test Freq. (MHz)	NR Test CH.	Tune up	n8
1	Middle	15	20	DFT-s-OFDM PI/2 BPSK1	Inner_Full	50_25	1880	376000	25.00	24.20
2	Middle	15	20	DFT-s-OFDM 16QAM	Inner_Full	50_25	1880	376000	24.00	23.44
3	Middle	15	20	DFT-s-OFDM 64QAM	Inner_Full	50_25	1880	376000	22.50	21.98
4	Middle	15	20	DFT-s-OFDM 256QAM	Inner_Full	50_25	1880	376000	20.50	19.83
5	Middle	15	20	CP-OFDM QPSK	Inner_Full	50_25	1880	376000	23.50	22.80
6	Middle	15	20	CP-OFDM 16QAM	Inner_Full	50_25	1880	376000	23.00	22.27
7	Middle	15	20	CP-OFDM 64QAM	Inner_Full	50_25	1880	376000	21.50	20.70
8	Middle	15	20	CP-OFDM 256QAM	Inner_Full	50_25	1880	376000	18.50	17.87
9	Middle	15	20	DFT-s-OFDM QPSK	Edge_Full_Right	2@104	1880	376000	24.00	23.33
10	Middle	15	20	DFT-s-OFDM QPSK	Edge_Full_Left	2_0	1880	376000	24.00	23.21
11	Middle	15	20	DFT-s-OFDM QPSK	Edge_1RB_Right	1_105	1880	376000	24.00	23.32
12	Middle	15	20	DFT-s-OFDM QPSK	Edge_1RB_Left	1_0	1880	376000	24.00	23.18
13	Middle	15	20	DFT-s-OFDM QPSK	Inner_1RB_Right	1_104	1880	376000	25.00	24.21
14	Middle	15	20	DFT-s-OFDM QPSK	Inner_1RB_Left	1_1	1880	376000	25.00	24.26
15	Middle	15	20	DFT-s-OFDM QPSK	Outer_Full	100_0	1880	376000	24.00	23.32
15	Middle	15	10	DFT-s-OFDM QPSK	Inner_Full	25_12	1880	376000	25.00	24.20
18	Middle	15	15	DFT-s-OFDM QPSK	Inner_Full	36_18	1880	376000	25.00	24.17

N2 DS10

No.	Test Freq Description	5G-n2							Power Results (dBm)	
		SCS (kHz)	NR BW (MHz)	Modulation	RB allocation		NR Test Freq. (MHz)	NR Test CH.	Tune up	n8
1	High	15	5	DFT-s-OFDM QPSK	Inner_Full	12_6	1907.5	381500	13.00	12.13
2	Middle	15	5	DFT-s-OFDM QPSK	Inner_Full	12_6	1880	376000	13.00	12.36
3	Low	15	5	DFT-s-OFDM QPSK	Inner_Full	12_6	1852.5	370500	13.00	12.43
4	High	15	20	DFT-s-OFDM QPSK	Inner_Full	50_25	1900	380000	13.00	12.26
5	Middle	15	20	DFT-s-OFDM QPSK	Inner_Full	50_25	1880	376000	13.00	12.52
6	Low	15	20	DFT-s-OFDM QPSK	Inner_Full	50_25	1860	372000	13.00	12.39

According to the table above, the maximum power configuration is selected as the default test configuration

No.	Test Freq Description	5G-n2							Power Results (dBm)	
		SCS (kHz)	NR BW (MHz)	Modulation	RB allocation		NR Test Freq. (MHz)	NR Test CH.	Tune up	n8
1	Middle	15	20	DFT-s-OFDM PI/2 BPSK1	Inner_Full	50_25	1880	376000	13.00	12.37
2	Middle	15	20	DFT-s-OFDM 16QAM	Inner_Full	50_25	1880	376000	13.00	12.41
3	Middle	15	20	DFT-s-OFDM 64QAM	Inner_Full	50_25	1880	376000	13.00	12.40
4	Middle	15	20	DFT-s-OFDM 256QAM	Inner_Full	50_25	1880	376000	13.00	12.41
5	Middle	15	20	CP-OFDM QPSK	Inner_Full	50_25	1880	376000	13.00	12.42
6	Middle	15	20	CP-OFDM 16QAM	Inner_Full	50_25	1880	376000	13.00	12.43
7	Middle	15	20	CP-OFDM 64QAM	Inner_Full	50_25	1880	376000	13.00	12.45
8	Middle	15	20	CP-OFDM 256QAM	Inner_Full	50_25	1880	376000	13.00	12.44
9	Middle	15	20	DFT-s-OFDM QPSK	Edge_Full_Right	2@104	1880	376000	13.00	12.48
10	Middle	15	20	DFT-s-OFDM QPSK	Edge_Full_Left	2_0	1880	376000	13.00	12.47
11	Middle	15	20	DFT-s-OFDM QPSK	Edge_1RB_Right	1_105	1880	376000	13.00	12.40
12	Middle	15	20	DFT-s-OFDM QPSK	Edge_1RB_Left	1_0	1880	376000	13.00	12.45
13	Middle	15	20	DFT-s-OFDM QPSK	Inner_1RB_Right	1_104	1880	376000	13.00	12.50
14	Middle	15	20	DFT-s-OFDM QPSK	Inner_1RB_Left	1_1	1880	376000	13.00	12.51
15	Middle	15	20	DFT-s-OFDM QPSK	Outer_Full	100_0	1880	376000	13.00	12.48
15	Middle	15	10	DFT-s-OFDM QPSK	Inner_Full	25_12	1880	376000	13.00	12.45
18	Middle	15	15	DFT-s-OFDM QPSK	Inner_Full	36_18	1880	376000	13.00	12.48

N5 DS11

No.	Test Freq Description	5G-n5							Tune up	Power Results (dBm)
		SCS (kHz)	NR BW (MHz)	Modulation	RB allocation		NR Test Freq. (MHz)	NR Test CH.		n5
1	High	15	5	DFT-s-OFDM QPSK	Inner_Full	12_6	846.5	169300	25.00	23.90
2	Middle	15	5	DFT-s-OFDM QPSK	Inner_Full	12_6	836.5	167300	25.00	23.97
3	Low	15	5	DFT-s-OFDM QPSK	Inner_Full	12_6	826.5	165300	25.00	23.86
4	High	15	20	DFT-s-OFDM QPSK	Inner_Full	50_25	839	167800	25.00	23.95
5	Middle	15	20	DFT-s-OFDM QPSK	Inner_Full	50_25	836.5	167300	25.00	24.02
6	Low	15	20	DFT-s-OFDM QPSK	Inner_Full	50_25	834	166800	25.00	23.92

According to the table above, the maximum power configuration is selected as the default test configuration

No.	Test Freq Description	5G-n5							Tune up	Power Results (dBm)
		SCS (kHz)	NR BW (MHz)	Modulation	RB allocation		NR Test Freq. (MHz)	NR Test CH.		n5
1	Middle	15	20	DFT-s-OFDM P1/2 BPSK1	Inner_Full	50_25	836.5	167300	25.00	23.98
2	Middle	15	20	DFT-s-OFDM 16QAM	Inner_Full	50_25	836.5	167300	24.00	22.95
3	Middle	15	20	DFT-s-OFDM 64QAM	Inner_Full	50_25	836.5	167300	22.50	21.41
4	Middle	15	20	DFT-s-OFDM 256QAM	Inner_Full	50_25	836.5	167300	20.50	19.40
5	Middle	15	20	CP-OFDM QPSK	Inner_Full	50_25	836.5	167300	23.50	22.37
6	Middle	15	20	CP-OFDM 16QAM	Inner_Full	50_25	836.5	167300	23.00	21.87
7	Middle	15	20	CP-OFDM 64QAM	Inner_Full	50_25	836.5	167300	21.50	20.35
8	Middle	15	20	CP-OFDM 256QAM	Inner_Full	50_25	836.5	167300	18.50	17.44
9	Middle	15	20	DFT-s-OFDM QPSK	Edge_Full_Right	2@104	836.5	167300	24.00	22.73
10	Middle	15	20	DFT-s-OFDM QPSK	Edge_Full_Left	2_0	836.5	167300	24.00	22.94
11	Middle	15	20	DFT-s-OFDM QPSK	Edge_1RB_Right	1_105	836.5	167300	24.00	22.78
12	Middle	15	20	DFT-s-OFDM QPSK	Edge_1RB_Left	1_0	836.5	167300	24.00	23.00
13	Middle	15	20	DFT-s-OFDM QPSK	Inner_1RB_Right	1_104	836.5	167300	25.00	23.80
14	Middle	15	20	DFT-s-OFDM QPSK	Inner_1RB_Left	1_1	836.5	167300	25.00	24.00
15	Middle	15	20	DFT-s-OFDM QPSK	Outer_Full	100_0	836.5	167300	24.00	22.91
17	Middle	15	10	DFT-s-OFDM QPSK	Inner_Full	25_12	836.5	167300	25.00	23.86
20	Middle	15	15	DFT-s-OFDM QPSK	Inner_Full	36_18	836.5	167300	25.00	23.99

N5 DS10

No.	Test Freq Description	5G-n5							Tune up	Power Results (dBm)
		SCS (kHz)	NR BW (MHz)	Modulation	RB allocation		NR Test Freq. (MHz)	NR Test CH.		n5
1	High	15	5	DFT-s-OFDM QPSK	Inner_Full	12_6	846.5	169300	16.30	15.30
2	Middle	15	5	DFT-s-OFDM QPSK	Inner_Full	12_6	836.5	167300	16.30	15.46
3	Low	15	5	DFT-s-OFDM QPSK	Inner_Full	12_6	826.5	165300	16.30	15.57
4	High	15	20	DFT-s-OFDM QPSK	Inner_Full	50_25	839	167800	16.30	15.62
5	Middle	15	20	DFT-s-OFDM QPSK	Inner_Full	50_25	836.5	167300	16.30	15.65
6	Low	15	20	DFT-s-OFDM QPSK	Inner_Full	50_25	834	166800	16.30	15.60

According to the table above, the maximum power configuration is selected as the default test configuration

No.	Test Freq Description	5G-n5							Tune up	Power Results (dBm)
		SCS (kHz)	NR BW (MHz)	Modulation	RB allocation		NR Test Freq. (MHz)	NR Test CH.		n5
1	Middle	15	20	DFT-s-OFDM P1/2 BPSK1	Inner_Full	50_25	836.5	167300	16.30	15.60
2	Middle	15	20	DFT-s-OFDM 16QAM	Inner_Full	50_25	836.5	167300	16.30	15.63
3	Middle	15	20	DFT-s-OFDM 64QAM	Inner_Full	50_25	836.5	167300	16.30	15.62
4	Middle	15	20	DFT-s-OFDM 256QAM	Inner_Full	50_25	836.5	167300	16.30	15.57
5	Middle	15	20	CP-OFDM QPSK	Inner_Full	50_25	836.5	167300	16.30	15.62
6	Middle	15	20	CP-OFDM 16QAM	Inner_Full	50_25	836.5	167300	16.30	15.59
7	Middle	15	20	CP-OFDM 64QAM	Inner_Full	50_25	836.5	167300	16.30	15.58
8	Middle	15	20	CP-OFDM 256QAM	Inner_Full	50_25	836.5	167300	16.30	15.64
9	Middle	15	20	DFT-s-OFDM QPSK	Edge_Full_Right	2@104	836.5	167300	16.30	15.50
10	Middle	15	20	DFT-s-OFDM QPSK	Edge_Full_Left	2_0	836.5	167300	16.30	15.62
11	Middle	15	20	DFT-s-OFDM QPSK	Edge_1RB_Right	1_105	836.5	167300	16.30	15.62
12	Middle	15	20	DFT-s-OFDM QPSK	Edge_1RB_Left	1_0	836.5	167300	16.30	15.61
13	Middle	15	20	DFT-s-OFDM QPSK	Inner_1RB_Right	1_104	836.5	167300	16.30	15.61
14	Middle	15	20	DFT-s-OFDM QPSK	Inner_1RB_Left	1_1	836.5	167300	16.30	15.53
15	Middle	15	20	DFT-s-OFDM QPSK	Outer_Full	100_0	836.5	167300	16.30	15.63
17	Middle	15	10	DFT-s-OFDM QPSK	Inner_Full	25_12	836.5	167300	16.30	15.62
20	Middle	15	15	DFT-s-OFDM QPSK	Inner_Full	36_18	836.5	167300	16.30	15.62

N66 DSI1

No.	Test Freq Description	5G-n66							Tune up	Power Results (dBm)
		SCS (kHz)	NR BW (MHz)	Modulation	RB allocation		NR Test Freq. (MHz)	NR Test CH.		n66
1	High	15	5	DFT-s-OFDM QPSK	Inner_Full	12.6	1777.5	355500	25.00	24.23
2	Middle	15	5	DFT-s-OFDM QPSK	Inner_Full	12.6	1745	349000	25.00	24.13
3	Low	15	5	DFT-s-OFDM QPSK	Inner_Full	12.6	1712.5	342500	25.00	24.09
4	High	15	40	DFT-s-OFDM QPSK	Inner_Full	108.54	1760	352000	25.00	24.19
5	Middle	15	40	DFT-s-OFDM QPSK	Inner_Full	108.54	1745	349000	25.00	24.24
6	Low	15	40	DFT-s-OFDM QPSK	Inner_Full	108.54	1730	346000	25.00	24.12

According to the table above, the maximum power configuration is selected as the default test configuration

No.	Test Freq Description	5G-n66							Tune up	Power Results (dBm)
		SCS (kHz)	NR BW (MHz)	Modulation	RB allocation		NR Test Freq. (MHz)	NR Test CH.		n66
1	Middle	15	40	DFT-s-OFDM P1/2 BPSK1	Inner_Full	108.54	1745	349000	25.00	24.14
2	Middle	15	40	DFT-s-OFDM 16QAM	Inner_Full	108.54	1745	349000	24.00	23.20
3	Middle	15	40	DFT-s-OFDM 64QAM	Inner_Full	108.54	1745	349000	22.50	21.64
4	Middle	15	40	DFT-s-OFDM 256QAM	Inner_Full	108.54	1745	349000	20.50	19.63
5	Middle	15	40	CP-OFDM QPSK	Inner_Full	108.54	1745	349000	23.50	22.64
6	Middle	15	40	CP-OFDM 16QAM	Inner_Full	108.54	1745	349000	23.00	22.12
7	Middle	15	40	CP-OFDM 64QAM	Inner_Full	108.54	1745	349000	21.50	20.58
8	Middle	15	40	CP-OFDM 256QAM	Inner_Full	108.54	1745	349000	18.50	17.66
9	Middle	15	40	DFT-s-OFDM QPSK	Edge_Full_Right	2.214	1745	349000	24.00	23.20
10	Middle	15	40	DFT-s-OFDM QPSK	Edge_Full_Left	2.0	1745	349000	24.00	23.10
11	Middle	15	40	DFT-s-OFDM QPSK	Edge_1RB_Right	1.215	1745	349000	24.00	23.27
12	Middle	15	40	DFT-s-OFDM QPSK	Edge_1RB_Left	1.0	1745	349000	24.00	23.14
13	Middle	15	40	DFT-s-OFDM QPSK	Inner_1RB_Right	1.214	1745	349000	25.00	24.25
14	Middle	15	40	DFT-s-OFDM QPSK	Inner_1RB_Left	1.1	1745	349000	25.00	24.12
15	Middle	15	40	DFT-s-OFDM QPSK	Outer_Full	216.0	1745	349000	24.00	23.26
15	Middle	15	10	DFT-s-OFDM QPSK	Inner_Full	25.12	1745	349000	25.00	23.81
18	Middle	15	15	DFT-s-OFDM QPSK	Inner_Full	36.18	1745	349000	25.00	23.87
18	Middle	15	20	DFT-s-OFDM QPSK	Inner_Full	50.25	1745	349000	25.00	23.80
18	Middle	15	25	DFT-s-OFDM QPSK	Inner_Full	64.32	1745	349000	25.00	23.77
18	Middle	15	30	DFT-s-OFDM QPSK	Inner_Full	80.40	1745	349000	25.00	23.82

N66 DSI0

No.	Test Freq Description	5G-n66							Tune up	Power Results (dBm)
		SCS (kHz)	NR BW (MHz)	Modulation	RB allocation		NR Test Freq. (MHz)	NR Test CH.		n66
1	High	15	5	DFT-s-OFDM QPSK	Inner_Full	12.6	1777.5	355500	16.00	15.29
2	Middle	15	5	DFT-s-OFDM QPSK	Inner_Full	12.6	1745	349000	16.00	15.18
3	Low	15	5	DFT-s-OFDM QPSK	Inner_Full	12.6	1712.5	342500	16.00	15.27
4	High	15	40	DFT-s-OFDM QPSK	Inner_Full	108.54	1760	352000	16.00	15.61
5	Middle	15	40	DFT-s-OFDM QPSK	Inner_Full	108.54	1745	349000	16.00	15.75
6	Low	15	40	DFT-s-OFDM QPSK	Inner_Full	108.54	1730	346000	16.00	15.58

According to the table above, the maximum power configuration is selected as the default test configuration

No.	Test Freq Description	5G-n66							Tune up	Power Results (dBm)
		SCS (kHz)	NR BW (MHz)	Modulation	RB allocation		NR Test Freq. (MHz)	NR Test CH.		n66
1	Middle	15	40	DFT-s-OFDM P1/2 BPSK1	Inner_Full	108.54	1745	349000	16.00	15.58
2	Middle	15	40	DFT-s-OFDM 16QAM	Inner_Full	108.54	1745	349000	16.00	15.55
3	Middle	15	40	DFT-s-OFDM 64QAM	Inner_Full	108.54	1745	349000	16.00	15.59
4	Middle	15	40	DFT-s-OFDM 256QAM	Inner_Full	108.54	1745	349000	16.00	15.57
5	Middle	15	40	CP-OFDM QPSK	Inner_Full	108.54	1745	349000	16.00	15.59
6	Middle	15	40	CP-OFDM 16QAM	Inner_Full	108.54	1745	349000	16.00	15.58
7	Middle	15	40	CP-OFDM 64QAM	Inner_Full	108.54	1745	349000	16.00	15.55
8	Middle	15	40	CP-OFDM 256QAM	Inner_Full	108.54	1745	349000	16.00	15.57
9	Middle	15	40	DFT-s-OFDM QPSK	Edge_Full_Right	2.214	1745	349000	16.00	15.64
10	Middle	15	40	DFT-s-OFDM QPSK	Edge_Full_Left	2.0	1745	349000	16.00	15.69
11	Middle	15	40	DFT-s-OFDM QPSK	Edge_1RB_Right	1.215	1745	349000	16.00	15.64
12	Middle	15	40	DFT-s-OFDM QPSK	Edge_1RB_Left	1.0	1745	349000	16.00	15.63
13	Middle	15	40	DFT-s-OFDM QPSK	Inner_1RB_Right	1.214	1745	349000	16.00	15.82
14	Middle	15	40	DFT-s-OFDM QPSK	Inner_1RB_Left	1.1	1745	349000	16.00	15.67
15	Middle	15	40	DFT-s-OFDM QPSK	Outer_Full	216.0	1745	349000	16.00	15.69
15	Middle	15	10	DFT-s-OFDM QPSK	Inner_Full	25.12	1745	349000	16.00	15.17
18	Middle	15	15	DFT-s-OFDM QPSK	Inner_Full	36.18	1745	349000	16.00	15.49
18	Middle	15	20	DFT-s-OFDM QPSK	Inner_Full	50.25	1745	349000	16.00	15.40
18	Middle	15	25	DFT-s-OFDM QPSK	Inner_Full	64.32	1745	349000	16.00	15.47
18	Middle	15	30	DFT-s-OFDM QPSK	Inner_Full	80.40	1745	349000	16.00	15.60

N77-H DSI1

No.	Test Freq Description	5G-n77							Power Results (dBm)	
		SCS (kHz)	NR BW (MHz)	Modulation	RB allocation		NR Test Freq. (MHz)	NR Test CH.	Tune up	n77
1	High	30	20	DFT-s-OFDM QPSK	Inner_Full	25@12	3969.990	664666	26.50	24.51
2	Middle-1	30	20	DFT-s-OFDM QPSK	Inner_Full	25@12	3918.000	661200	26.50	24.65
3	Middle-2	30	20	DFT-s-OFDM QPSK	Inner_Full	25@12	3866.000	657733	26.50	24.74
4	Middle-3	30	20	DFT-s-OFDM QPSK	Inner_Full	25@12	3814.000	654267	26.50	25.05
5	Middle-5	30	20	DFT-s-OFDM QPSK	Inner_Full	25@12	3762.000	650800	26.50	24.64
6	Low	30	20	DFT-s-OFDM QPSK	Inner_Full	25@12	3710.010	647334	26.50	25.00
7	High	30	100	DFT-s-OFDM QPSK	Inner_Full	135@67	3930.000	662000	26.50	24.53
8	Middle-1	30	100	DFT-s-OFDM QPSK	Inner_Full	135@67	3894.000	659600	26.50	24.51
9	Middle-2	30	100	DFT-s-OFDM QPSK	Inner_Full	135@67	3858.000	657200	26.50	24.70
10	Middle-3	30	100	DFT-s-OFDM QPSK	Inner_Full	135@67	3822.000	654800	26.50	24.71
11	Middle-4	30	100	DFT-s-OFDM QPSK	Inner_Full	135@67	3786.000	652400	26.50	24.59
12	Low	30	100	DFT-s-OFDM QPSK	Inner_Full	135@67	3750.000	650000	26.50	24.89

According to the table above, the maximum power configuration is selected as the default test configuration

No.	Test Freq Description	5G-n77							Power Results (dBm)	
		SCS (kHz)	NR BW (MHz)	Modulation	RB allocation		NR Test Freq. (MHz)	NR Test CH.	Tune up	n77
1	Middle-3	30	20	DFT-s-OFDM P1/2 BPSK1	Inner_Full	25@12	3814.000	654267	26.50	24.55
2	Middle-3	30	20	DFT-s-OFDM 16QAM	Inner_Full	25@12	3814.000	654267	24.00	23.59
3	Middle-3	30	20	DFT-s-OFDM 64QAM	Inner_Full	25@12	3814.000	654267	22.00	21.96
4	Middle-3	30	20	DFT-s-OFDM 256QAM	Inner_Full	25@12	3814.000	654267	22.00	20.00
5	Middle-3	30	20	CP-OFDM QPSK	Inner_Full	25@12	3814.000	654267	25.00	23.08
6	Middle-3	30	20	CP-OFDM 16QAM	Inner_Full	25@12	3814.000	654267	24.50	22.53
7	Middle-3	30	20	CP-OFDM 64QAM	Inner_Full	25@12	3814.000	654267	23.00	21.10
8	Middle-3	30	20	CP-OFDM 256QAM	Inner_Full	25@12	3814.000	654267	20.00	18.01
9	Middle-3	30	20	DFT-s-OFDM QPSK	Edge_1RB_Right	2@49	3814.000	654267	23.00	21.46
10	Middle-3	30	20	DFT-s-OFDM QPSK	Edge_1RB_Left	2_0	3814.000	654267	23.00	21.34
11	Middle-3	30	20	DFT-s-OFDM QPSK	Edge_Full_Right	1_50	3814.000	654267	23.00	21.51
12	Middle-3	30	20	DFT-s-OFDM QPSK	Edge_Full_Left	1_0	3814.000	654267	23.00	21.40
13	Middle-3	30	20	DFT-s-OFDM QPSK	Inner_1RB_Right	1_49	3814.000	654267	26.50	24.86
14	Middle-3	30	20	DFT-s-OFDM QPSK	Inner_1RB_Left	1_1	3814.000	654267	26.50	24.68
15	Middle-3	30	20	DFT-s-OFDM QPSK	Outer_Full	50_0	3814.000	654267	24.50	23.57
16	Middle-1	30	40	DFT-s-OFDM QPSK	Inner_Full	50@25	3814.000	654267	26.50	24.54
17	Middle-1	30	50	DFT-s-OFDM QPSK	Inner_Full	64@32	3814.000	654267	26.50	24.51
18	Middle-1	30	60	DFT-s-OFDM QPSK	Inner_Full	81@40	3814.000	654267	26.50	24.51
19	Middle-1	30	80	DFT-s-OFDM QPSK	Inner_Full	108@54	3814.000	654267	26.50	24.69
20	Middle-1	30	90	DFT-s-OFDM QPSK	Inner_Full	120@60	3814.000	654267	26.50	24.53

N77-H DSI0

No.	Test Freq Description	5G-n77							Tune up	Power Results (dBm)
		SCS (kHz)	NR BW (MHz)	Modulation	RB allocation		NR Test Freq. (MHz)	NR Test CH.		
1	High	30	20	DFT-s-OFDM QPSK	Inner_Full	25@12	3969.990	664666	12.90	12.54
2	Middle-1	30	20	DFT-s-OFDM QPSK	Inner_Full	25@12	3918.000	661200	12.90	12.67
3	Middle-2	30	20	DFT-s-OFDM QPSK	Inner_Full	25@12	3866.000	657733	12.90	12.79
4	Middle-3	30	20	DFT-s-OFDM QPSK	Inner_Full	25@12	3814.000	654267	12.90	12.60
5	Middle-5	30	20	DFT-s-OFDM QPSK	Inner_Full	25@12	3762.000	650800	12.90	12.31
6	Low	30	20	DFT-s-OFDM QPSK	Inner_Full	25@12	3710.010	647334	12.90	12.36
7	High	30	100	DFT-s-OFDM QPSK	Inner_Full	135@67	3930.000	662000	12.90	12.39
8	Middle-1	30	100	DFT-s-OFDM QPSK	Inner_Full	135@67	3894.000	659600	12.90	12.39
9	Middle-2	30	100	DFT-s-OFDM QPSK	Inner_Full	135@67	3858.000	657200	12.90	12.35
10	Middle-3	30	100	DFT-s-OFDM QPSK	Inner_Full	135@67	3822.000	654800	12.90	12.25
11	Middle-4	30	100	DFT-s-OFDM QPSK	Inner_Full	135@67	3786.000	652400	12.90	12.19
12	Low	30	100	DFT-s-OFDM QPSK	Inner_Full	135@67	3750.000	650000	12.90	12.05

According to the table above, the maximum power configuration is selected as the default test configuration

No.	Test Freq Description	5G-n77							Tune up	Power Results (dBm)
		SCS (kHz)	NR BW (MHz)	Modulation	RB allocation		NR Test Freq. (MHz)	NR Test CH.		
1	Middle-3	30	20	DFT-s-OFDM P1/2 BPSK1	Inner_Full	25@12	3866.000	657733	12.90	12.71
2	Middle-3	30	20	DFT-s-OFDM 16QAM	Inner_Full	25@12	3866.000	657733	12.90	12.77
3	Middle-3	30	20	DFT-s-OFDM 64QAM	Inner_Full	25@12	3866.000	657733	12.90	12.73
4	Middle-3	30	20	DFT-s-OFDM 256QAM	Inner_Full	25@12	3866.000	657733	12.90	12.75
5	Middle-3	30	20	DFT-s-OFDM QPSK	Inner_Full	25@12	3866.000	657733	12.90	12.72
6	Middle-3	30	20	DFT-s-OFDM QPSK	Inner_Full	25@12	3866.000	657733	12.90	12.72
7	Middle-3	30	20	DFT-s-OFDM QPSK	Inner_Full	25@12	3866.000	657733	12.90	12.73
8	Middle-3	30	20	DFT-s-OFDM QPSK	Inner_Full	25@12	3866.000	657733	12.90	12.73
9	Middle-3	30	20	DFT-s-OFDM QPSK	Edge_1RB_Right	2@49	3866.000	657733	12.90	12.57
10	Middle-3	30	20	DFT-s-OFDM QPSK	Edge_1RB_Left	2_0	3866.000	657733	12.90	12.63
11	Middle-3	30	20	DFT-s-OFDM QPSK	Edge_Full_Right	1_50	3866.000	657733	12.90	12.58
12	Middle-3	30	20	DFT-s-OFDM QPSK	Edge_Full_Left	1_0	3866.000	657733	12.90	12.69
13	Middle-3	30	20	DFT-s-OFDM QPSK	Inner_1RB_Right	1_49	3866.000	657733	12.90	12.74
14	Middle-3	30	20	DFT-s-OFDM QPSK	Inner_1RB_Left	1_1	3866.000	657733	12.90	12.68
15	Middle-3	30	20	DFT-s-OFDM QPSK	Outer_Full	50_0	3866.000	657733	12.90	12.73
16	Middle-1	30	40	DFT-s-OFDM QPSK	Inner_1RB_Left	50@25	3866.000	657733	12.90	12.73
17	Middle-1	30	50	DFT-s-OFDM QPSK	Inner_1RB_Left	64@32	3866.000	657733	12.90	12.51
18	Middle-1	30	60	DFT-s-OFDM QPSK	Inner_1RB_Left	81@40	3866.000	657733	12.90	12.20
19	Middle-1	30	80	DFT-s-OFDM QPSK	Inner_1RB_Left	108@54	3866.000	657733	12.90	12.24
20	Middle-1	30	90	DFT-s-OFDM QPSK	Inner_1RB_Left	120@60	3866.000	657733	12.90	12.23

13 Simultaneous TX SAR Considerations

13.1 Transmit Antenna Separation Distances

The detail for transmit antenna separation distance is described in the additional document:

Appendix to test report No.I22Z60808-SEM12

The photos of SAR test

13.2 SAR Measurement Positions

According to the KDB941225 D06 Hot Spot SAR v01, the edges with less than 2.5 cm distance to the antennas need to be tested for SAR.

SAR measurement positions						
Mode	Front	Rear	Left edge	Right edge	Top edge	Bottom edge
ANT0	Yes	Yes	Yes	No	Yes	No
ANT1	Yes	Yes	Yes	No	No	Yes
ANT2	Yes	Yes	No	Yes	Yes	No
ANT4	Yes	Yes	No	Yes	Yes	No
ANT5	Yes	Yes	Yes	No	Yes	No

14 Evaluation of Simultaneous

Test Position	SAR 1g/10g(W/h)	ANT0	ANT1	ANT0	ANT0	ANT1	ANT1	ANT1	ANT2	ANT0	ANT1	ANT0	ANT2	ANT2	MAX. SAR 10g	
		WCDMA1900	WCDMA850	LTE 2	LTE 4	LTE 5	LTE 12	LTE 13	LTE 48	LTE 66	n2	n5	n66	n77-L		n77-H
Body	Front 5mm	0.60	0.40	0.47	0.71	0.14	0.28	0.13	0.67	0.39	0.20	0.28	0.18	0.20	0.14	0.71
	Rear 5mm	0.38	0.40	0.30	0.59	0.14	0.26	0.12	0.33	0.29	0.13	0.25	0.13	0.08	0.08	0.59
	Left 5mm	0.40	0.18	0.32	0.36	0.07	0.18	0.09	/	0.20	0.15	0.13	0.09	/	/	0.40
	Right 5mm	/	/	/	/	/	0.11	0.16	0.09	/	/	/	/	0.12	0.11	0.27
	Bottom 5mm	/	0.20	/	/	/	/	/	/	/	/	/	0.16	/	/	0.30
	Top 5mm	0.36	/	0.28	0.69	/	/	/	/	0.38	0.35	0.11	/	0.08	0.10	0.69
	Front 17mm	0.44	/	0.38	0.34	/	/	/	/	0.34	0.52	/	/	0.44	/	0.52
	Front 19mm	/	0.20	/	/	0.35	0.09	0.24	/	/	/	0.40	/	/	/	0.40
	Front 25mm	/	/	/	/	/	/	/	/	0.13	/	/	/	/	0.70	0.71
	Rear 15mm	0.29	/	0.28	0.30	/	/	/	/	0.28	0.43	/	/	0.37	/	0.43
	Rear 19mm	/	0.19	/	/	0.32	0.14	0.21	0.18	/	/	0.33	/	0.59	0.74	0.74
	Left 14mm	/	0.19	/	/	0.21	0.12	0.20	/	/	/	0.23	/	/	/	0.23
	Left 15mm	0.22	/	0.22	0.19	/	/	/	/	0.21	0.32	/	0.24	/	/	0.32
	Right 25mm	/	/	/	/	/	/	/	/	0.17	/	/	/	0.48	0.96	0.96
	Bottom 14mm	/	0.16	/	/	0.30	0.09	0.22	/	/	/	0.25	/	/	/	0.30
	Top 20mm	0.33	/	0.37	0.30	/	/	/	/	0.33	0.15	/	0.24	/	/	0.37
	Top 24mm	/	/	/	/	/	/	/	0.15	/	/	/	/	0.53	0.42	0.53

Test Position	SAR 1g/10g(W/h)	1	2	3	4	5	6	7	8
		WLAN	WIFI2.4G ANT4	WIFI2.4G ANTS	WIFI5G ANT4	WIFI5G ANTS	WIFI6E ANT4	WIFI6E ANTS	BT ANT5
Body	Front 5mm	0.71	0.40	0.150	0.260	0.03	<0.01	<0.01	0.040
	Rear 5mm	0.59	0.030	0.090	0.07	0.150	<0.01	<0.01	0.020
	Left 5mm	0.40	/	0.340	/	0.140	/	<0.01	0.050
	Right 5mm	0.27	0.050	/	0.070	/	<0.01	/	/
	Bottom 5mm	0.30	/	/	/	/	/	/	/
	Top 5mm	0.69	0.050	0.070	0.05	0.05	<0.01	<0.01	/
	Front 17mm	0.52	0.14	0.28	0.28	0.05	<0.01	<0.01	0.04
	Front 19mm	0.41	0.14	0.25	0.25	0.05	<0.01	<0.01	0.04
	Front 25mm	0.71	0.14	0.25	0.25	0.05	<0.01	<0.01	0.04
	Rear 15mm	0.43	0.10	0.20	0.00	0.29	<0.01	<0.01	0.02
	Rear 19mm	0.74	0.04	0.07	0.14	0.24	<0.01	<0.01	0.08
	Left 14mm	0.23	/	0.34	/	0.14	/	<0.01	0.05
	Left 15mm	0.32	/	0.34	/	0.15	/	<0.01	0.05
	Right 25mm	0.96	0.11	/	0.15	/	<0.01	<0.01	/
	Bottom 14mm	0.30	/	/	/	/	/	/	/
	Top 20mm	0.37	0.05	0.07	0.06	0.05	<0.01	<0.01	/
	Top 24mm	0.53	0.05	0.07	0.06	0.05	<0.01	<0.01	/

Test Position	SAR 1g/10g(W/h)	simultaneous transmission		MAX. SAR 10g
		1+2+3+4+5+8	1+2+3+6+7+8	
Body	Front 5mm	1.33	1.04	1.33
	Rear 5mm	0.95	0.73	0.95
	Left 5mm	0.93	0.79	0.93
	Right 5mm	0.39	0.32	0.39
	Bottom 5mm	0.39	0.30	0.39
	Top 5mm	0.92	0.81	0.92
	Front 17mm	1.30	0.99	1.30
	Front 19mm	1.18	0.87	1.18
	Front 25mm	1.49	1.18	1.49
	Rear 15mm	1.03	0.75	1.03
	Rear 19mm	1.26	0.87	1.26
	Left 14mm	0.75	0.82	0.75
	Left 15mm	0.85	0.71	0.85
	Right 25mm	1.42	1.07	1.42
	Bottom 14mm	0.30	0.30	0.30
	Top 20mm	0.80	0.49	0.80
	Top 24mm	0.76	0.65	0.76

Test Position	SAR 1g/10g(W/h)	1	6	7
		WLAN	WIFI6E ANT4	WIFI6E ANTS
Body	Front 5mm	0.71	/	/
	Rear 5mm	0.59	/	4.42
	Left 5mm	0.40	/	/
	Right 5mm	0.27	0.42	/
	Bottom 5mm	0.30	/	/
	Top 5mm	0.69	/	/
	Front 17mm	0.52	/	/
	Front 19mm	0.40	/	/
	Front 25mm	0.71	/	/
	Rear 15mm	0.43	/	4.42
	Rear 19mm	0.74	/	4.42
	Left 14mm	0.23	/	/
	Left 15mm	0.32	/	/
	Right 25mm	0.96	0.42	/
	Bottom 14mm	0.30	/	/
	Top 20mm	0.37	/	/
	Top 24mm	0.53	/	/

Test Position	SAR 1g/10g(W/h)	simultaneous transmission
		1+2+3
Body	Front 5mm	0.44
	Rear 5mm	0.81
	Left 5mm	0.25
	Right 5mm	0.21
	Bottom 5mm	0.19
	Top 5mm	0.43
	Front 17mm	0.33
	Front 19mm	0.25
	Front 25mm	0.44
	Rear 15mm	0.71
	Rear 19mm	0.90
	Left 14mm	0.14
	Left 15mm	0.20
	Right 25mm	0.64
	Bottom 14mm	0.19
	Top 20mm	0.23
	Top 24mm	0.33

Conclusion:

According to the above tables, the sum of reported SAR values is <1.6W/kg. So the simultaneous transmission SAR with volume scans is not required.

15 SAR Test Result

Note:

KDB 447498 D01 General RF Exposure Guidance:

For WWAN: Reported SAR(W/kg)= Measured SAR(W/kg)*Tune-up Scaling Factor

For BT/WLAN: Reported SAR(W/kg)= Measured SAR(W/kg)* Duty Cycle scaling factor * Tune-up scaling factor

Testing of other required channels within the operating mode of a frequency band is not required when the reported 1-g or 10-g SAR for the mid-band or highest output power channel is:

≤ 0.8 W/kg or 2.0 W/kg, for 1-g or 10-g respectively, when the transmission band is ≤ 100 MHz

≤ 0.6 W/kg or 1.5 W/kg, for 1-g or 10-g respectively, when the transmission band is between 100 MHz and 200 MHz

≤ 0.4 W/kg or 1.0 W/kg, for 1-g or 10-g respectively, when the transmission band is ≥ 200 MHz

KDB 941225 D05 SAR for LTE Devices:

SAR test reduction is applied using the following criteria:

Start with the largest channel bandwidth and measure SAR for QPSK with 1 RB, and 50% RB allocation, using the RB offset and required test channel combination with the highest maximum output power among RB offsets at the upper edge, middle and lower edge of each required test channel.

When the reported SAR is > 0.8 W/kg, testing for other Channels is performed at the highest output power level for 1RB, and 50% RB configuration for that channel.

Testing for 100% RB configuration is performed at the highest output power level for 100% RB configuration across the Low, Mid and High Channel when the highest reported SAR for 1 RB and 50% RB are > 0.8 W/kg. Testing for the remaining required channels is not needed because the reported SAR for 100% RB Allocation < 1.45 W/kg.

Testing for 16-QAM modulation is not required because the reported SAR for QPSK is < 1.45 W/Kg and its output power is not more than 0.5 dB higher than that of QPSK.

Testing for the other channel bandwidths is not required because the reported SAR for the highest channel bandwidth is <1.45 W/Kg and its output power is not more than 0.5 dB higher than that of the highest channel bandwidth.

For LTE bands that do not support at least three non-overlapping channels in certain channel bandwidths, test the available non-overlapping channels instead. When a device supports overlapping channel assignment in a channel bandwidth configuration, the middle channel of the group of overlapping channels should be selected for testing; therefore, the requirement for H, M and L channels may not fully apply.

KDB 248227 D01 SAR meas for 802.11:

SAR test reduction for 802.11 Wi-Fi transmission mode configurations are considered separately for DSSS and OFDM. An initial test position is determined to reduce the number of tests required for certain exposure configurations with multiple test positions. An initial test configuration is determined for each frequency band and aggregated band according to maximum output power, channel bandwidth, wireless mode configurations and other operating parameters to streamline the measurement requirements. For 2.4 GHz DSSS, either the initial test position or DSSS procedure is applied to reduce the number of SAR tests; these are mutually exclusive. For OFDM, an initial test position is only applicable to next to the ear, UMPC mini-tablet and hotspot mode

configurations, which is tested using the initial test configuration to facilitate test reduction. For other exposure conditions with a fixed test position, SAR test reduction is determined using only the initial test configuration.

To determine the initial test position, Area Scans were performed to determine the position with the Maximum Value of SAR (measured). The position that produced the highest Maximum Value of SAR is considered the worst case position; thus used as the initial test position.

The multiple test positions require SAR measurements in head, hotspot mode or UMPC mini-tablet configurations may be reduced according to the highest reported SAR determined using the initial test position(s) by applying the DSSS or OFDM SAR measurement procedures in the required wireless mode test configuration(s). The initial test position(s) is measured using the highest measured maximum output power channel in the required wireless mode test configuration(s).

When the reported SAR for the initial test position is:

≤ 0.4 W/kg, further SAR measurement is not required for the other test positions in that exposure configuration and wireless mode combination within the frequency band or aggregated band. DSSS and OFDM configurations are considered separately according to the required SAR procedures.

> 0.4 W/kg, SAR is repeated using the same wireless mode test configuration tested in the initial test position to measure the subsequent next closet/smallest test separation distance and maximum coupling test position, on the highest maximum output power channel, until the reported SAR is ≤ 0.8 W/kg or all required test positions are tested.

- For subsequent test positions with equivalent test separation distance or when exposure is dominated by coupling conditions, the position for maximum coupling condition should be tested.
- When it is unclear, all equivalent conditions must be tested.

For all positions/configurations tested using the initial test position and subsequent test positions, when the reported SAR is > 0.8 W/kg, measure the SAR for these positions/configurations on the subsequent next highest measured output power channel(s) until the reported SAR is ≤ 1.2 W/kg or all required test channels are considered.

- The additional power measurements required for this step should be limited to those necessary for identifying subsequent highest output power channels to apply the test reduction.

When the specified maximum output power is the same for both UNII 1 and UNII 2A, begin SAR measurements in UNII 2A with the channel with the highest measured output power. If the reported SAR for UNII 2A is ≤ 1.2 W/kg, SAR is not required for UNII 1; otherwise treat the remaining bands separately and test them independently for SAR.

When the specified maximum output power is different between UNII 1 and UNII 2A, begin SAR with the band that has the higher specified maximum output. If the highest reported SAR for the band with the highest specified power is ≤ 1.2 W/kg, testing for the band with the lower specified output power is not required; otherwise test the remaining bands independently for SAR.

- Absorbed power density (APD) using a 4cm² averaging area is reported based on SAR measurements.
- Per FCC guidance and equipment manufacturer guidance, power density results were scaled according to IEC 62479:2010 for the portion of the measurement uncertainty $> 30\%$. Total expanded uncertainty of 1.52 dB (41.9%) was used to determine the psPD measurement scaling factor.



Table 15.1: Duty Cycle

Mode	Duty Cycle
WCDMA<E FDD	1:1
LTE B48	1:1.58

15.1 SAR results for 4G

ANT	RF Exposure Conditions	Frequency Band	Channel Number	Frequency (MHz)	Mode/RB	Test setup	Distance	Figure No./Note	EUT Measured Power (dBm)	Tune up (dBm)	Measured SAR 1g (W/kg)	Calculated SAR 1g (W/kg)	Measured SAR 10g (W/kg)	Calculated SAR 10g (W/kg)	Power Drift
1	Body	WCDMA 850	4233	846.6	RMC	Front	5mm	\	18.17	19.50	0.288	0.39	0.167	0.23	0.01
1	Body	WCDMA 850	4183	836.6	RMC	Front	5mm	FIG A.1	18.19	19.50	0.299	0.40	0.184	0.25	0.08
1	Body	WCDMA 850	4132	826.4	RMC	Front	5mm	\	18.10	19.50	0.285	0.39	0.178	0.25	-0.15
1	Body	WCDMA 850	4183	836.6	RMC	Rear	5mm	\	18.19	19.50	0.294	0.40	0.179	0.24	-0.19
1	Body	WCDMA 850	4183	836.6	RMC	Left	5mm	\	18.19	19.50	0.132	0.18	0.067	0.09	0.18
1	Body	WCDMA 850	4183	836.6	RMC	Bottom	5mm	\	18.19	19.50	0.225	0.30	0.137	0.19	0.04
1	Body	WCDMA 850	4183	836.6	RMC	Front	19mm	\	22.55	24.00	0.146	0.20	0.092	0.13	-0.02
1	Body	WCDMA 850	4183	836.6	RMC	Rear	19mm	\	22.55	24.00	0.136	0.19	0.088	0.12	-0.16
1	Body	WCDMA 850	4183	836.6	RMC	Left	14mm	\	22.55	24.00	0.133	0.19	0.092	0.13	-0.01
1	Body	WCDMA 850	4183	836.6	RMC	Bottom	14mm	\	22.55	24.00	0.113	0.16	0.089	0.12	0.15
0	Body	WCDMA1900	9538	1907.6	RMC	Front	5mm	FIG A.2	14.12	16.00	0.391	0.60	0.184	0.28	0.12
0	Body	WCDMA1900	9400	1880	RMC	Front	5mm	\	14.06	16.00	0.367	0.57	0.173	0.27	0.03
0	Body	WCDMA1900	9262	1852.4	RMC	Front	5mm	\	14.08	16.00	0.340	0.53	0.165	0.26	0.04
0	Body	WCDMA1900	9400	1880	RMC	Rear	5mm	\	14.06	16.00	0.240	0.38	0.123	0.19	-0.01
0	Body	WCDMA1900	9400	1880	RMC	Left	5mm	\	14.06	16.00	0.259	0.40	0.106	0.17	0.01
0	Body	WCDMA1900	9400	1880	RMC	Top	5mm	\	14.06	16.00	0.233	0.36	0.104	0.16	-0.02
0	Body	WCDMA1900	9400	1880	RMC	Front	17mm	\	22.42	24.00	0.309	0.44	0.195	0.28	-0.11
0	Body	WCDMA1900	9400	1880	RMC	Rear	15mm	\	22.42	24.00	0.199	0.29	0.127	0.18	0.04
0	Body	WCDMA1900	9400	1880	RMC	Left	15mm	\	22.42	24.00	0.154	0.22	0.083	0.12	0.01
0	Body	WCDMA1900	9400	1880	RMC	Top	20mm	\	22.42	24.00	0.232	0.33	0.146	0.21	-0.17
0	Body	LTE Band2	19100	1900	1RB-High	Front	5mm	\	13.47	14.50	0.365	0.46	0.162	0.21	0.03
0	Body	LTE Band2	19100	1900	1RB-High	Rear	5mm	\	13.47	14.50	0.235	0.30	0.110	0.14	0.18
0	Body	LTE Band2	19100	1900	1RB-High	Left	5mm	\	13.47	14.50	0.255	0.32	0.099	0.13	0.15
0	Body	LTE Band2	19100	1900	1RB-High	Top	5mm	\	13.47	14.50	0.215	0.27	0.101	0.13	0.16
0	Body	LTE Band2	19100	1900	50RB-High	Front	5mm	FIG A.3	13.50	14.50	0.373	0.47	0.166	0.21	0.02
0	Body	LTE Band2	19100	1900	50RB-High	Rear	5mm	\	13.50	14.50	0.239	0.30	0.112	0.14	0.16
0	Body	LTE Band2	19100	1900	50RB-High	Left	5mm	\	13.50	14.50	0.258	0.32	0.099	0.12	-0.11
0	Body	LTE Band2	19100	1900	50RB-High	Top	5mm	\	13.50	14.50	0.219	0.28	0.104	0.13	-0.16
0	Body	LTE Band2	18900	1880	1RB-Low	Front	17mm	\	23.51	25.00	0.256	0.36	0.162	0.23	0.01
0	Body	LTE Band2	18900	1880	1RB-Low	Rear	15mm	\	23.51	25.00	0.199	0.28	0.126	0.18	-0.18
0	Body	LTE Band2	18900	1880	1RB-Low	Left	15mm	\	23.51	25.00	0.145	0.20	0.077	0.11	0.05
0	Body	LTE Band2	18900	1880	1RB-Low	Top	20mm	\	23.51	25.00	0.265	0.37	0.165	0.23	0.01
0	Body	LTE Band2	18900	1880	50RB-High	Front	17mm	\	22.58	24.00	0.275	0.38	0.173	0.24	0.02
0	Body	LTE Band2	18900	1880	50RB-High	Rear	15mm	\	22.58	24.00	0.192	0.27	0.122	0.17	-0.18
0	Body	LTE Band2	18900	1880	50RB-High	Left	15mm	\	22.58	24.00	0.162	0.22	0.086	0.12	0.06
0	Body	LTE Band2	18900	1880	50RB-High	Top	20mm	\	22.58	24.00	0.203	0.28	0.126	0.17	-0.05
0	Body	LTE Band4	20175	1732.5	1RB-Low	Front	5mm	\	18.68	19.50	0.530	0.64	0.300	0.36	0.18
0	Body	LTE Band4	20175	1732.5	1RB-Low	Rear	5mm	\	18.68	19.50	0.470	0.57	0.247	0.30	0.15
0	Body	LTE Band4	20175	1732.5	1RB-Low	Left	5mm	\	18.68	19.50	0.300	0.36	0.153	0.18	0.14
0	Body	LTE Band4	20175	1732.5	1RB-Low	Top	5mm	\	18.68	19.50	0.575	0.69	0.302	0.36	0.14
0	Body	LTE Band4	20050	1720	50RB-Low	Front	5mm	FIG A.4	18.70	19.50	0.589	0.71	0.316	0.38	0.01
0	Body	LTE Band4	20050	1720	50RB-Low	Rear	5mm	\	18.70	19.50	0.489	0.59	0.262	0.31	0.03
0	Body	LTE Band4	20050	1720	50RB-Low	Left	5mm	\	18.70	19.50	0.289	0.35	0.152	0.18	-0.11
0	Body	LTE Band4	20050	1720	50RB-Low	Top	5mm	\	18.70	19.50	0.578	0.69	0.302	0.36	-0.04
0	Body	LTE Band4	20300	1745	1RB-Low	Front	17mm	\	23.47	25.00	0.239	0.34	0.155	0.22	0.07
0	Body	LTE Band4	20300	1745	1RB-Low	Rear	15mm	\	23.47	25.00	0.208	0.30	0.136	0.19	-0.09
0	Body	LTE Band4	20300	1745	1RB-Low	Left	15mm	\	23.47	25.00	0.132	0.19	0.081	0.12	0.16
0	Body	LTE Band4	20300	1745	1RB-Low	Top	20mm	\	23.47	25.00	0.214	0.30	0.135	0.19	0.19
0	Body	LTE Band4	20050	1720	50RB-Middle	Front	17mm	\	22.59	24.00	0.189	0.26	0.125	0.17	0.09
0	Body	LTE Band4	20050	1720	50RB-Middle	Rear	15mm	\	22.59	24.00	0.185	0.26	0.120	0.17	0.02
0	Body	LTE Band4	20050	1720	50RB-Middle	Left	15mm	\	22.59	24.00	0.130	0.18	0.078	0.11	0.19
0	Body	LTE Band4	20050	1720	50RB-Middle	Top	20mm	\	22.59	24.00	0.161	0.22	0.102	0.14	-0.01
1	Body	LTE Band5	20600	844	1RB-Low	Front	5mm	\	15.20	16.00	0.116	0.14	0.071	0.09	-0.16
1	Body	LTE Band5	20600	844	1RB-Low	Rear	5mm	\	15.20	16.00	0.112	0.13	0.068	0.08	0.09
1	Body	LTE Band5	20600	844	1RB-Low	Left	5mm	\	15.20	16.00	0.059	0.07	0.029	0.03	-0.15
1	Body	LTE Band5	20600	844	1RB-Low	Bottom	5mm	\	15.20	16.00	0.085	0.10	0.048	0.06	-0.14
1	Body	LTE Band5	20600	844	25RB-Low	Front	5mm	\	15.29	16.00	0.118	0.14	0.072	0.08	0.09
1	Body	LTE Band5	20600	844	25RB-Low	Rear	5mm	\	15.29	16.00	0.115	0.14	0.069	0.08	-0.08
1	Body	LTE Band5	20600	844	25RB-Low	Left	5mm	\	15.29	16.00	0.057	0.07	0.029	0.03	-0.08
1	Body	LTE Band5	20600	844	25RB-Low	Bottom	5mm	\	15.29	16.00	0.092	0.11	0.052	0.06	0.07
1	Body	LTE Band5	20600	844	1RB-Low	Front	19mm	FIG A.5	23.19	25.00	0.230	0.35	0.152	0.23	0.08
1	Body	LTE Band5	20600	844	1RB-Low	Rear	19mm	\	23.19	25.00	0.210	0.32	0.139	0.21	0.06
1	Body	LTE Band5	20600	844	1RB-Low	Left	14mm	\	23.19	25.00	0.136	0.21	0.077	0.12	-0.09
1	Body	LTE Band5	20600	844	1RB-Low	Bottom	14mm	\	23.19	25.00	0.199	0.30	0.127	0.19	0.04
1	Body	LTE Band5	20450	829	25RB-Middle	Front	19mm	\	22.34	24.00	0.189	0.28	0.124	0.18	0.09
1	Body	LTE Band5	20450	829	25RB-Middle	Rear	19mm	\	22.34	24.00	0.170	0.25	0.111	0.16	-0.12
1	Body	LTE Band5	20450	829	25RB-Middle	Left	14mm	\	22.34	24.00	0.118	0.17	0.067	0.10	0.14
1	Body	LTE Band5	20450	829	25RB-Middle	Bottom	14mm	\	22.34	24.00	0.176	0.26	0.109	0.16	0.05
1	Body	LTE Band5	20600	844	1RB-Low	Front	19mm	ULCA	23.07	25.00	0.201	0.31	0.143	0.22	0.02



ANT	RF Exposure Conditions	Frequency Band	Channel Number	Frequency (MHz)	Mode/RB	Test setup	Distance	Figure No./Note	EUT Measured Power (dBm)	Tune up (dBm)	Measured SAR 1g (W/kg)	Calculated SAR 1g (W/kg)	Measured SAR 10g (W/kg)	Calculated SAR 10g (W/kg)	Power Drift
1	Body	LTE Band12	23060	704	1RB-Low	Front	5mm	\	20.01	21.00	0.221	0.28	0.140	0.18	-0.06
1	Body	LTE Band12	23060	704	1RB-Low	Rear	5mm	\	20.01	21.00	0.134	0.17	0.122	0.15	-0.07
1	Body	LTE Band12	23060	704	1RB-Low	Left	5mm	\	20.01	21.00	0.141	0.18	0.078	0.10	0.02
1	Body	LTE Band12	23060	704	1RB-Low	Bottom	5mm	\	20.01	21.00	0.125	0.16	0.074	0.09	-0.04
1	Body	LTE Band12	23060	704	25RB-Middle	Front	5mm	FIG A.6	20.05	21.00	0.229	0.28	0.145	0.18	0.07
1	Body	LTE Band12	23060	704	25RB-Middle	Rear	5mm	\	20.05	21.00	0.208	0.26	0.129	0.16	0.07
1	Body	LTE Band12	23060	704	25RB-Middle	Left	5mm	\	20.05	21.00	0.146	0.18	0.079	0.10	0.11
1	Body	LTE Band12	23060	704	25RB-Middle	Bottom	5mm	\	20.05	21.00	0.130	0.16	0.077	0.10	0.16
1	Body	LTE Band12	23095	707.5	1RB-Low	Front	19mm	\	23.08	24.00	0.073	0.09	0.049	0.06	0.07
1	Body	LTE Band12	23095	707.5	1RB-Low	Rear	19mm	\	23.08	24.00	0.100	0.12	0.071	0.09	-0.17
1	Body	LTE Band12	23095	707.5	1RB-Low	Left	14mm	\	23.08	24.00	0.029	0.04	0.020	0.02	0.01
1	Body	LTE Band12	23095	707.5	1RB-Low	Bottom	14mm	\	23.08	24.00	0.065	0.08	0.043	0.05	0.03
1	Body	LTE Band12	23095	707.5	25RB-Low	Front	19mm	\	22.26	23.00	0.079	0.09	0.054	0.06	0.06
1	Body	LTE Band12	23095	707.5	25RB-Low	Rear	19mm	\	22.26	23.00	0.118	0.14	0.089	0.11	0.08
1	Body	LTE Band12	23095	707.5	25RB-Low	Left	14mm	\	22.26	23.00	0.102	0.12	0.072	0.09	0.03
1	Body	LTE Band12	23095	707.5	25RB-Low	Bottom	14mm	\	22.26	23.00	0.074	0.09	0.048	0.06	0.09
1	Body	LTE Band13	23230	782	1RB-Middle	Front	5mm	\	15.57	16.50	0.099	0.12	0.061	0.08	-0.11
1	Body	LTE Band13	23230	782	1RB-Middle	Rear	5mm	\	15.57	16.50	0.092	0.11	0.057	0.07	-0.13
1	Body	LTE Band13	23230	782	1RB-Middle	Left	5mm	\	15.57	16.50	0.070	0.09	0.033	0.04	-0.15
1	Body	LTE Band13	23230	782	1RB-Middle	Bottom	5mm	\	15.57	16.50	0.071	0.09	0.041	0.05	-0.03
1	Body	LTE Band13	23230	782	25RB-Middle	Front	5mm	\	15.62	16.50	0.104	0.13	0.064	0.08	0.03
1	Body	LTE Band13	23230	782	25RB-Middle	Rear	5mm	\	15.62	16.50	0.096	0.12	0.059	0.07	-0.07
1	Body	LTE Band13	23230	782	25RB-Middle	Left	5mm	\	15.62	16.50	0.069	0.08	0.033	0.04	-0.14
1	Body	LTE Band13	23230	782	25RB-Middle	Bottom	5mm	\	15.62	16.50	0.076	0.09	0.044	0.05	-0.19
1	Body	LTE Band13	23230	782	1RB-Middle	Front	19mm	FIG A.7	23.16	25.00	0.160	0.24	0.107	0.16	0.08
1	Body	LTE Band13	23230	782	1RB-Middle	Rear	19mm	\	23.16	25.00	0.140	0.21	0.103	0.16	0.19
1	Body	LTE Band13	23230	782	1RB-Middle	Left	14mm	\	23.16	25.00	0.083	0.13	0.063	0.10	0.13
1	Body	LTE Band13	23230	782	1RB-Middle	Bottom	14mm	\	23.16	25.00	0.111	0.17	0.078	0.12	0.14
1	Body	LTE Band13	23230	782	25RB-Low	Front	19mm	\	22.32	24.00	0.153	0.23	0.112	0.16	0.06
1	Body	LTE Band13	23230	782	25RB-Low	Rear	19mm	\	22.32	24.00	0.117	0.17	0.085	0.13	-0.14
1	Body	LTE Band13	23230	782	25RB-Low	Left	14mm	\	22.32	24.00	0.137	0.20	0.105	0.15	-0.05
1	Body	LTE Band13	23230	782	25RB-Low	Bottom	14mm	\	22.32	24.00	0.150	0.22	0.107	0.16	-0.08
2	Body	LTE Band48	55990	3625	1RB-High	Front	5mm	FIG A.8	15.38	16.50	0.520	0.67	0.169	0.22	0.12
2	Body	LTE Band48	55990	3625	1RB-High	Rear	5mm	\	15.38	16.50	0.255	0.33	0.089	0.12	-0.09
2	Body	LTE Band48	55990	3625	1RB-High	Right	5mm	\	15.38	16.50	0.209	0.27	0.075	0.10	0.17
2	Body	LTE Band48	55990	3625	1RB-High	Top	5mm	\	15.38	16.50	0.295	0.38	0.088	0.11	-0.14
2	Body	LTE Band48	55990	3625	50RB-Low	Front	5mm	\	15.41	16.50	0.504	0.65	0.171	0.22	0.11
2	Body	LTE Band48	55990	3625	50RB-Low	Rear	5mm	\	15.41	16.50	0.255	0.33	0.089	0.11	0.15
2	Body	LTE Band48	55990	3625	50RB-Low	Right	5mm	\	15.41	16.50	0.198	0.25	0.071	0.09	-0.19
2	Body	LTE Band48	55990	3625	50RB-Low	Top	5mm	\	15.41	16.50	0.295	0.38	0.088	0.11	0.15
2	Body	LTE Band48	55990	3625	1RB-Low	Front	25mm	\	23.63	25.00	0.096	0.13	0.047	0.06	-0.1
2	Body	LTE Band48	55990	3625	1RB-Low	Rear	19mm	\	23.63	25.00	0.128	0.18	0.060	0.08	-0.07
2	Body	LTE Band48	55990	3625	1RB-Low	Right	25mm	\	23.63	25.00	0.125	0.17	0.065	0.09	0.07
2	Body	LTE Band48	55990	3625	1RB-Low	Top	24mm	\	23.63	25.00	0.107	0.15	0.052	0.07	0.09
2	Body	LTE Band48	55990	3625	50RB-Low	Front	25mm	\	22.68	24.00	0.075	0.10	0.037	0.05	-0.1
2	Body	LTE Band48	55990	3625	50RB-Low	Rear	19mm	\	22.68	24.00	0.103	0.14	0.048	0.07	-0.01
2	Body	LTE Band48	55990	3625	50RB-Low	Right	25mm	\	22.68	24.00	0.100	0.14	0.052	0.07	-0.01
2	Body	LTE Band48	55990	3625	50RB-Low	Top	24mm	\	22.68	24.00	0.085	0.12	0.041	0.06	-0.06
0	Body	LTE Band66	132572	1770	1RB-Low	Front	5mm	\	14.52	15.50	0.305	0.38	0.151	0.19	-0.18
0	Body	LTE Band66	132572	1770	1RB-Low	Rear	5mm	\	14.52	15.50	0.234	0.29	0.114	0.14	0.08
0	Body	LTE Band66	132572	1770	1RB-Low	Left	5mm	\	14.52	15.50	0.141	0.18	0.060	0.08	-0.10
0	Body	LTE Band66	132572	1770	1RB-Low	Top	5mm	\	14.52	15.50	0.276	0.35	0.133	0.17	-0.10
0	Body	LTE Band66	132572	1770	50RB-High	Front	5mm	FIG A.9	14.57	15.50	0.312	0.39	0.154	0.19	0.15
0	Body	LTE Band66	132572	1770	50RB-High	Rear	5mm	\	14.57	15.50	0.238	0.29	0.114	0.14	0.15
0	Body	LTE Band66	132572	1770	50RB-High	Left	5mm	\	14.57	15.50	0.160	0.20	0.066	0.08	-0.12
0	Body	LTE Band66	132572	1770	50RB-High	Top	5mm	\	14.57	15.50	0.283	0.35	0.135	0.17	0.16
0	Body	LTE Band66	132322	1745	1RB-Low	Front	17mm	\	23.52	25.00	0.241	0.34	0.157	0.22	0.12
0	Body	LTE Band66	132322	1745	1RB-Low	Rear	15mm	\	23.52	25.00	0.201	0.28	0.131	0.18	-0.06
0	Body	LTE Band66	132322	1745	1RB-Low	Left	15mm	\	23.52	25.00	0.146	0.21	0.089	0.13	-0.16
0	Body	LTE Band66	132322	1745	1RB-Low	Top	20mm	\	23.52	25.00	0.235	0.33	0.150	0.21	0.19
0	Body	LTE Band66	132322	1745	50RB-Middle	Front	17mm	\	22.53	24.00	0.193	0.27	0.122	0.17	0.03
0	Body	LTE Band66	132322	1745	50RB-Middle	Rear	15mm	\	22.53	24.00	0.184	0.26	0.115	0.16	-0.11
0	Body	LTE Band66	132322	1745	50RB-Middle	Left	15mm	\	22.53	24.00	0.121	0.17	0.073	0.10	0.03
0	Body	LTE Band66	132322	1745	50RB-Middle	Top	20mm	\	22.53	24.00	0.201	0.28	0.124	0.17	0.06
0	Body	LTE Band66	132597	1772.5	1RB-Low	Front	5mm	ULCA 66B	14.48	15.50	0.283	0.36	0.124	0.16	0.03
0	Body	LTE Band66	132572	1770	1RB-Low	Front	5mm	ULCA 66C	14.48	15.50	0.266	0.34	0.107	0.14	0.11

15.2 SAR results for WLAN

ANT	RF Exposure Conditions	Frequency Band	Channel Number	Frequency (MHz)	Mode/RB	Test setup	Distance	Figure No./Note	EUT Measured Power (dBm)	Tune up (dBm)	Measured SAR 1g (W/kg)	Calculated SAR 1g (W/kg)	Measured SAR 10g (W/kg)	Calculated SAR 10g (W/kg)	Power Drift
4	Body	WLAN2.4G	1	2412	11b	Front	5mm	FIG A.10	15.99	16.00	0.144	0.14	0.068	0.07	0.18
4	Body	WLAN2.4G	1	2412	11b	Rear	19mm	/	15.99	16.00	0.036	0.04	0.018	0.02	-0.09
4	Body	WLAN2.4G	1	2412	11b	Right	10mm	/	15.99	16.00	0.108	0.11	0.053	0.05	-0.08
4	Body	WLAN2.4G	1	2412	11b	Top	5mm	/	15.99	16.00	0.047	0.05	0.021	0.02	0.01
4	Body	WLAN2.4G	1	2412	11b	Rear	5mm	/	5.09	5.50	0.031	0.03	0.014	0.02	-0.15
4	Body	WLAN2.4G	1	2412	11b	Right	5mm	/	5.09	5.50	0.050	0.05	0.023	0.03	0.15
5	Body	WLAN2.4G	1	2412	11b	Front	17mm	/	15.18	16.00	0.242	0.29	0.128	0.15	0.02
5	Body	WLAN2.4G	1	2412	11b	Rear	19mm	/	15.18	16.00	0.054	0.07	0.028	0.03	-0.02
5	Body	WLAN2.4G	1	2412	11b	Left	25mm	/	15.18	16.00	0.229	0.28	0.133	0.16	0.13
5	Body	WLAN2.4G	1	2412	11b	Top	5mm	/	15.18	16.00	0.061	0.07	0.032	0.04	0.06
5	Body	WLAN2.4G	1	2412	11b	Front	5mm	/	4.76	5.50	0.128	0.15	0.066	0.08	0.09
5	Body	WLAN2.4G	1	2412	11b	Rear	5mm	/	4.76	5.50	0.075	0.09	0.039	0.05	0.12
5	Body	WLAN2.4G	1	2412	11b	Left	5mm	FIG A.11	4.76	5.50	0.289	0.34	0.112	0.13	0.16
4	Body	WLAN5G	52	5260	11a	Front	5mm	/	15.18	16.00	0.214	0.26	0.057	0.07	-0.07
4	Body	WLAN5G	52	5260	11a	Rear	19mm	/	15.18	16.00	0.125	0.15	0.047	0.06	0.13
4	Body	WLAN5G	52	5260	11a	Right	10mm	/	15.18	16.00	0.141	0.17	0.041	0.05	-0.12
4	Body	WLAN5G	52	5260	11a	Top	5mm	/	15.18	16.00	<0.01	<0.01	<0.01	<0.01	/
4	Body	WLAN5G	120	5600	11a	Front	5mm	/	15.59	16.00	0.205	0.23	0.071	0.08	0.14
4	Body	WLAN5G	120	5600	11a	Rear	19mm	/	15.59	16.00	0.059	0.07	0.019	0.02	0.10
4	Body	WLAN5G	120	5600	11a	Right	10mm	FIG A.12	15.59	16.00	0.313	0.35	0.104	0.11	-0.06
4	Body	WLAN5G	120	5600	11a	Top	5mm	/	15.59	16.00	<0.01	<0.01	<0.01	<0.01	/
4	Body	WLAN5G	153	5765	11a	Front	5mm	/	15.48	16.00	0.201	0.23	0.051	0.06	0.13
4	Body	WLAN5G	153	5765	11a	Rear	19mm	/	15.48	16.00	0.035	0.04	0.013	0.01	0.17
4	Body	WLAN5G	153	5765	11a	Right	10mm	/	15.48	16.00	0.235	0.27	0.080	0.09	0.01
4	Body	WLAN5G	153	5765	11a	Top	5mm	/	15.48	16.00	<0.01	<0.01	<0.01	<0.01	/
4	Body	WLAN5G	52	5260	11a	Rear	5mm	/	1.97	3.00	<0.01	<0.01	<0.01	<0.01	/
4	Body	WLAN5G	52	5260	11a	Right	5mm	/	1.97	3.00	<0.01	<0.01	<0.01	<0.01	/
4	Body	WLAN5G	140	5700	11a	Rear	5mm	/	2.87	3.00	<0.01	<0.01	<0.01	<0.01	/
4	Body	WLAN5G	140	5700	11a	Right	5mm	/	2.87	3.00	<0.01	<0.01	<0.01	<0.01	/
4	Body	WLAN5G	149	5745	11a	Rear	5mm	/	5.83	7.00	<0.01	<0.01	<0.01	<0.01	/
4	Body	WLAN5G	149	5745	11a	Right	5mm	/	5.83	7.00	<0.01	<0.01	<0.01	<0.01	/
4	Body	WLAN5G	169	5845	11a	Front	5mm	/	11.77	12.70	0.123	0.16	0.034	0.04	-0.16
4	Body	WLAN5G	169	5845	11a	Rear	19mm	/	11.77	12.70	0.113	0.14	0.037	0.05	-0.10
4	Body	WLAN5G	169	5845	11a	Right	10mm	/	11.77	12.70	0.130	0.16	0.043	0.05	0.00
4	Body	WLAN5G	169	5845	11a	Top	5mm	/	11.77	12.70	0.046	0.06	0.009	0.01	0.01
4	Body	WLAN5G	169	5845	11a	Rear	5mm	/	2.98	3.50	0.063	0.07	0.011	0.01	-0.14
4	Body	WLAN5G	169	5845	11a	Right	5mm	/	2.98	3.50	0.062	0.07	0.014	0.02	0.10
5	Body	WLAN5G	64	5320	11a	Front	17mm	/	15.56	16.00	<0.01	<0.01	<0.01	<0.01	/
5	Body	WLAN5G	64	5320	11a	Rear	19mm	/	15.56	16.00	0.045	0.05	0.015	0.02	0.13
5	Body	WLAN5G	64	5320	11a	Left	25mm	/	15.56	16.00	<0.01	<0.01	<0.01	<0.01	/
5	Body	WLAN5G	64	5320	11a	Top	5mm	/	15.56	16.00	<0.01	<0.01	<0.01	<0.01	/
5	Body	WLAN5G	112	5560	11a	Front	17mm	/	15.56	16.00	<0.01	<0.01	<0.01	<0.01	/
5	Body	WLAN5G	112	5560	11a	Rear	19mm	/	15.56	16.00	0.174	0.20	0.067	0.07	0.09
5	Body	WLAN5G	112	5560	11a	Left	25mm	/	15.56	16.00	<0.01	<0.01	<0.01	<0.01	/
5	Body	WLAN5G	112	5560	11a	Top	5mm	/	15.56	16.00	<0.01	<0.01	<0.01	<0.01	/
5	Body	WLAN5G	165	5825	11a	Front	17mm	/	15.88	16.00	<0.01	<0.01	<0.01	<0.01	/
5	Body	WLAN5G	165	5825	11a	Rear	19mm	/	15.88	16.00	0.228	0.24	0.085	0.09	0.16
5	Body	WLAN5G	165	5825	11a	Left	25mm	/	15.88	16.00	<0.01	<0.01	<0.01	<0.01	/
5	Body	WLAN5G	165	5825	11a	Top	5mm	/	15.88	16.00	<0.01	<0.01	<0.01	<0.01	/
5	Body	WLAN5G	64	5320	11a	Front	5mm	/	2.69	3.00	<0.01	<0.01	<0.01	<0.01	/
5	Body	WLAN5G	64	5320	11a	Rear	5mm	/	2.69	3.00	0.133	0.15	0.035	0.04	-0.19
5	Body	WLAN5G	64	5320	11a	Left	5mm	/	2.69	3.00	0.067	0.07	0.021	0.02	0.17
5	Body	WLAN5G	140	5700	11a	Front	5mm	/	2.58	3.00	<0.01	<0.01	<0.01	<0.01	/
5	Body	WLAN5G	140	5700	11a	Rear	5mm	/	2.58	3.00	0.067	0.08	0.020	0.02	0.06
5	Body	WLAN5G	140	5700	11a	Left	5mm	/	2.58	3.00	0.060	0.07	0.019	0.02	0.08
5	Body	WLAN5G	161	5805	11a	Front	5mm	/	6.46	7.00	<0.01	<0.01	<0.01	<0.01	/
5	Body	WLAN5G	161	5805	11a	Rear	5mm	/	6.46	7.00	0.131	0.15	0.041	0.05	0.09
5	Body	WLAN5G	161	5805	11a	Left	5mm	/	6.46	7.00	0.118	0.14	0.037	0.04	0.12
5	Body	WLAN5G	177	5885	11a	Front	17mm	/	11.22	12.70	0.034	0.05	0.014	0.02	0.19
5	Body	WLAN5G	177	5885	11a	Rear	19mm	FIG A.13	11.22	12.70	0.192	0.28	0.075	0.11	0.08
5	Body	WLAN5G	177	5885	11a	Left	25mm	/	11.22	12.70	0.115	0.16	0.044	0.06	0.06
5	Body	WLAN5G	177	5885	11a	Top	5mm	/	11.22	12.70	0.032	0.05	0.012	0.02	0.12
5	Body	WLAN5G	169	5845	11a	Front	5mm	/	3.22	3.50	0.030	0.03	0.010	0.01	0.18
5	Body	WLAN5G	169	5845	11a	Rear	5mm	/	3.22	3.50	0.128	0.14	0.037	0.04	0.19
5	Body	WLAN5G	169	5845	11a	Left	5mm	/	3.22	3.50	0.103	0.11	0.032	0.03	0.06

ANT	RF Exposure Conditions	Frequency Band	Channel Number	Frequency (MHz)	Mode/RB	Test setup	Distance	Figure No./Note	EUT Measured Power (dBm)	Tune up (dBm)	Duty Cycle	Measured SAR 1g (W/kg)	Calculated SAR 1g (W/kg)	Measured SAR 10g (W/kg)	Calculated SAR 10g (W/kg)	Power Drift	APD (W/m ²)
4	Body	WLAN6G	33	6115	11a	Front	5mm	/	2.85	3.5	99.00%	<0.01	<0.01	<0.01	<0.01	/	/
4	Body	WLAN6G	33	6115	11a	Rear	5mm	/	2.85	3.5	99.00%	<0.01	<0.01	<0.01	<0.01	/	/
4	Body	WLAN6G	33	6115	11a	Right	5mm	/	2.85	3.5	99.00%	<0.01	<0.01	<0.01	<0.01	/	/
4	Body	WLAN6G	33	6115	11a	Top	5mm	/	2.85	3.5	99.00%	<0.01	<0.01	<0.01	<0.01	/	/
4	Body	WLAN6G	69	6295	11a	Front	5mm	/	2.78	4	99.00%	<0.01	<0.01	<0.01	<0.01	/	/
4	Body	WLAN6G	69	6295	11a	Rear	5mm	/	2.78	4	99.00%	<0.01	<0.01	<0.01	<0.01	/	/
4	Body	WLAN6G	69	6295	11a	Right	5mm	/	2.78	4	99.00%	<0.01	<0.01	<0.01	<0.01	/	/
4	Body	WLAN6G	69	6295	11a	Top	5mm	/	2.78	4	99.00%	<0.01	<0.01	<0.01	<0.01	/	/
4	Body	WLAN6G	101	6455	11a	Front	5mm	/	3.91	5	99.00%	<0.01	<0.01	<0.01	<0.01	/	/
4	Body	WLAN6G	101	6455	11a	Rear	5mm	/	3.91	5	99.00%	<0.01	<0.01	<0.01	<0.01	/	/
4	Body	WLAN6G	101	6455	11a	Right	5mm	/	3.91	5	99.00%	<0.01	<0.01	<0.01	<0.01	/	/
4	Body	WLAN6G	101	6455	11a	Top	5mm	/	3.91	5	99.00%	<0.01	<0.01	<0.01	<0.01	/	/
4	Body	WLAN6G	169	6795	11a	Front	5mm	/	3.87	4	99.00%	<0.01	<0.01	<0.01	<0.01	/	/
4	Body	WLAN6G	169	6795	11a	Rear	5mm	/	3.87	4	99.00%	<0.01	<0.01	<0.01	<0.01	/	/
4	Body	WLAN6G	169	6795	11a	Right	5mm	/	3.87	4	99.00%	<0.01	<0.01	<0.01	<0.01	/	/
4	Body	WLAN6G	169	6795	11a	Top	5mm	/	3.87	4	99.00%	<0.01	<0.01	<0.01	<0.01	/	/
4	Body	WLAN6G	205	6975	11a	Front	5mm	/	3.35	3.5	99.00%	<0.01	<0.01	<0.01	<0.01	/	/
4	Body	WLAN6G	205	6975	11a	Rear	5mm	/	3.35	3.5	99.00%	<0.01	<0.01	<0.01	<0.01	/	/
4	Body	WLAN6G	205	6975	11a	Right	5mm	/	3.35	3.5	99.00%	<0.01	<0.01	<0.01	<0.01	/	/
4	Body	WLAN6G	205	6975	11a	Top	5mm	/	3.35	3.5	99.00%	<0.01	<0.01	<0.01	<0.01	/	/
5	Body	WLAN6G	53	6215	11a	Front	5mm	/	3.46	4	99.00%	<0.01	<0.01	<0.01	<0.01	/	/
5	Body	WLAN6G	53	6215	11a	Rear	5mm	/	3.46	4	99.00%	<0.01	<0.01	<0.01	<0.01	/	/
5	Body	WLAN6G	53	6215	11a	Left	5mm	/	3.46	4	99.00%	<0.01	<0.01	<0.01	<0.01	/	/
5	Body	WLAN6G	53	6215	11a	Top	5mm	/	3.46	4	99.00%	<0.01	<0.01	<0.01	<0.01	/	/
5	Body	WLAN6G	61	6255	11a	Front	5mm	/	3.23	4	99.00%	<0.01	<0.01	<0.01	<0.01	/	/
5	Body	WLAN6G	61	6255	11a	Rear	5mm	/	3.23	4	99.00%	<0.01	<0.01	<0.01	<0.01	/	/
5	Body	WLAN6G	61	6255	11a	Left	5mm	/	3.23	4	99.00%	<0.01	<0.01	<0.01	<0.01	/	/
5	Body	WLAN6G	61	6255	11a	Top	5mm	/	3.23	4	99.00%	<0.01	<0.01	<0.01	<0.01	/	/
5	Body	WLAN6G	101	6455	11a	Front	5mm	/	4.98	5	99.00%	<0.01	<0.01	<0.01	<0.01	/	/
5	Body	WLAN6G	101	6455	11a	Rear	5mm	/	4.98	5	99.00%	<0.01	<0.01	<0.01	<0.01	/	/
5	Body	WLAN6G	101	6455	11a	Left	5mm	/	4.98	5	99.00%	<0.01	<0.01	<0.01	<0.01	/	/
5	Body	WLAN6G	101	6455	11a	Top	5mm	/	4.98	5	99.00%	<0.01	<0.01	<0.01	<0.01	/	/
5	Body	WLAN6G	177	6835	11a	Front	5mm	/	2.56	4	99.00%	<0.01	<0.01	<0.01	<0.01	/	/
5	Body	WLAN6G	177	6835	11a	Rear	5mm	/	2.56	4	99.00%	<0.01	<0.01	<0.01	<0.01	/	/
5	Body	WLAN6G	177	6835	11a	Left	5mm	/	2.56	4	99.00%	<0.01	<0.01	<0.01	<0.01	/	/
5	Body	WLAN6G	177	6835	11a	Top	5mm	/	2.56	4	99.00%	<0.01	<0.01	<0.01	<0.01	/	/
5	Body	WLAN6G	229	7095	11a	Front	5mm	/	2.18	3	99.00%	<0.01	<0.01	<0.01	<0.01	/	/
5	Body	WLAN6G	229	7095	11a	Rear	5mm	/	2.18	3	99.00%	<0.01	<0.01	<0.01	<0.01	/	/
5	Body	WLAN6G	229	7095	11a	Left	5mm	/	2.18	3	99.00%	<0.01	<0.01	<0.01	<0.01	/	/
5	Body	WLAN6G	229	7095	11a	Top	5mm	/	2.18	3	99.00%	<0.01	<0.01	<0.01	<0.01	/	/

15.3 PD results

ANT	RF Exposure Conditions	Frequency Band	Channel Number	Frequency (MHz)	Mode/RB	Test setup	Distance	Figure No./Note	EUT Measured Power (dBm)	Tune up (dBm)	Duty Cycle	Measured SAR 1g (W/kg)	Calculated SAR 1g (W/kg)	Measured SAR 10g (W/kg)	Calculated SAR 10g (W/kg)	Power Drift
4	Body	WLAN6G	33	6115	11a	Right	2mm	FIG A.14	2.85	3.50	99.00%	0.323	0.42	0.381	0.50	-0.13
4	Body	WLAN6G	69	6295	11a	Right	2mm	\	2.78	4.00	99.00%	0.212	0.32	0.215	0.32	0.09
4	Body	WLAN6G	101	6455	11a	Right	2mm	\	3.91	5.00	99.00%	0.238	0.35	0.289	0.42	0.04
4	Body	WLAN6G	169	6795	11a	Right	2mm	\	3.87	4.00	99.00%	0.251	0.29	0.293	0.34	0.12
4	Body	WLAN6G	205	6975	11a	Right	2mm	\	3.35	3.50	99.00%	0.329	0.38	0.333	0.39	-0.11
5	Body	WLAN6G	53	6215	11a	Rear	2mm	\	3.46	4.00	99.00%	0.570	0.73	0.654	0.84	0.15
5	Body	WLAN6G	61	6255	11a	Rear	2mm	\	3.23	4.00	99.00%	0.543	0.73	0.723	0.98	-0.07
5	Body	WLAN6G	101	6455	11a	Rear	2mm	\	4.98	5.00	99.00%	0.591	0.67	0.805	0.91	0.17
5	Body	WLAN6G	177	6835	11a	Rear	2mm	\	2.56	4.00	99.00%	1.560	2.46	2.140	3.37	0.03
5	Body	WLAN6G	229	7095	11a	Rear	2mm	FIG A.15	2.18	3.00	99.00%	3.24	4.42	3.530	4.82	-0.14

15.4 SAR results for BT

ANT	RF Exposure Conditions	Frequency Band	Channel Number	Frequency (MHz)	Mode/RB	Test setup	Distance	Figure No./Note	EUT Measured Power (dBm)	Tune up (dBm)	Measured SAR 1g (W/kg)	Calculated SAR 1g (W/kg)	Measured SAR 10g (W/kg)	Calculated SAR 10g (W/kg)	Power Drift
5	Body	BT	39	2441	11b	Front	5mm	/	7.77	8.00	0.039	0.04	0.015	0.02	0.14
5	Body	BT	39	2441	11b	Rear	5mm	/	7.77	8.00	0.020	0.02	0.007	0.01	0.07
5	Body	BT	39	2441	11b	Left	5mm	FIG A.16	7.77	8.00	0.050	0.05	0.018	0.02	0.17



15.5 SAR results for 5G NR

ANT	RF Exposure Conditions	Frequency Band	Channel Number	Frequency (MHz)	Mode/RB	Test setup	Distance	Figure No.	EUT Measured Power (dBm)	Tune up (dBm)	Measured SAR 1g (W/kg)	Calculated SAR 1g (W/kg)	Measured SAR 10g (W/kg)	Calculated SAR 10g (W/kg)	Power Drift
0	Body	N2	380000	1900	DFT-QPSK 15K 20M 50_25	Front	17mm	/	23.92	25.00	0.402	0.52	0.257	0.33	-0.11
0	Body	N2	376000	1880	DFT-QPSK 15K 20M 50_25	Front	17mm	FIG A.17	24.27	25.00	0.443	0.52	0.282	0.33	0.13
0	Body	N2	372000	1860	DFT-QPSK 15K 20M 50_25	Front	17mm	/	24.05	25.00	0.412	0.51	0.266	0.33	0.18
0	Body	N2	376000	1880	DFT-QPSK 15K 20M 50_25	Rear	15mm	/	24.27	25.00	0.364	0.43	0.233	0.28	-0.06
0	Body	N2	376000	1880	DFT-QPSK 15K 20M 50_25	Left	15mm	/	24.27	25.00	0.272	0.32	0.144	0.17	-0.14
0	Body	N2	376000	1880	DFT-QPSK 15K 20M 50_25	Top	20mm	/	24.27	25.00	0.123	0.15	0.077	0.09	-0.06
0	Body	N2	376000	1880	DFT-QPSK 15K 20M 50_25	Front	5mm	/	12.52	13.00	0.176	0.20	0.085	0.09	0.01
0	Body	N2	376000	1880	DFT-QPSK 15K 20M 50_25	Rear	5mm	/	12.52	13.00	0.118	0.13	0.056	0.06	-0.12
0	Body	N2	376000	1880	DFT-QPSK 15K 20M 50_25	Left	5mm	/	12.52	13.00	0.138	0.15	0.057	0.06	0.15
0	Body	N2	376000	1880	DFT-QPSK 15K 20M 50_25	Top	5mm	/	12.52	13.00	0.096	0.11	0.034	0.04	0.09
0	Body	N2	376000	1880	CP-QPSK 15K 20M 50_25	Front	17mm	/	22.80	23.50	0.396	0.47	0.249	0.29	0.06
1	Body	N5	167800	839	DFT-QPSK 15K 20M 50_25	Front	19mm	/	23.95	25.00	0.294	0.37	0.198	0.25	-0.05
1	Body	N5	167300	836.5	DFT-QPSK 15K 20M 50_25	Front	19mm	FIG A.18	24.02	25.00	0.319	0.40	0.215	0.27	0.06
1	Body	N5	166800	834	DFT-QPSK 15K 20M 50_25	Front	19mm	/	23.92	25.00	0.293	0.38	0.198	0.25	-0.14
1	Body	N5	167300	836.5	DFT-QPSK 15K 20M 50_25	Rear	19mm	/	24.02	25.00	0.264	0.33	0.175	0.22	-0.10
1	Body	N5	167300	836.5	DFT-QPSK 15K 20M 50_25	Left	14mm	/	24.02	25.00	0.18	0.23	0.131	0.16	-0.16
1	Body	N5	167300	836.5	DFT-QPSK 15K 20M 50_25	Bottom	14mm	/	24.02	25.00	0.198	0.25	0.129	0.16	-0.13
1	Body	N5	167300	836.5	DFT-QPSK 15K 20M 50_25	Front	5mm	/	15.65	16.30	0.237	0.28	0.134	0.16	-0.07
1	Body	N5	167300	836.5	DFT-QPSK 15K 20M 50_25	Rear	5mm	/	15.65	16.30	0.219	0.25	0.125	0.15	-0.04
1	Body	N5	167300	836.5	DFT-QPSK 15K 20M 50_25	Left	5mm	/	15.65	16.30	0.109	0.13	0.048	0.06	-0.08
1	Body	N5	167300	836.5	DFT-QPSK 15K 20M 50_25	Bottom	5mm	/	15.65	16.30	0.142	0.16	0.078	0.09	0.16
1	Body	N5	167300	836.5	CP-QPSK 15K 20M 50_25	Front	19mm	/	22.37	23.50	0.278	0.36	0.181	0.23	0.07
0	Body	N66	352000	1760	DFT-QPSK 15K 40M 108_54	Front	17mm	/	24.19	25.00	0.335	0.40	0.218	0.26	-0.02
0	Body	N66	349000	1745	DFT-QPSK 15K 40M 108_54	Front	17mm	FIG A.19	24.24	25.00	0.373	0.44	0.242	0.29	0.12
0	Body	N66	346000	1730	DFT-QPSK 15K 40M 108_54	Front	17mm	/	24.12	25.00	0.306	0.37	0.2	0.24	-0.02
0	Body	N66	349000	1745	DFT-QPSK 15K 40M 108_54	Rear	15mm	/	24.24	25.00	0.309	0.37	0.197	0.23	-0.08
0	Body	N66	349000	1745	DFT-QPSK 15K 40M 108_54	Left	15mm	/	24.24	25.00	0.199	0.24	0.123	0.15	0.00
0	Body	N66	349000	1745	DFT-QPSK 15K 40M 108_54	Top	20mm	/	24.24	25.00	0.204	0.24	0.131	0.16	0.17
0	Body	N66	349000	1745	DFT-QPSK 15K 40M 108_54	Front	5mm	/	15.75	16.00	0.169	0.18	0.086	0.09	-0.10
0	Body	N66	349000	1745	DFT-QPSK 15K 40M 108_54	Rear	5mm	/	15.75	16.00	0.123	0.13	0.062	0.07	-0.13
0	Body	N66	349000	1745	DFT-QPSK 15K 40M 108_54	Left	5mm	/	15.75	16.00	0.081	0.09	0.034	0.04	0.10
0	Body	N66	349000	1745	DFT-QPSK 15K 40M 108_54	Top	5mm	/	15.75	16.00	0.073	0.08	0.032	0.03	0.06
0	Body	N66	349000	1745	CP-QPSK 15K 40M 108_54	Front	17mm	FIG A.21	22.64	23.50	0.311	0.38	0.216	0.26	-0.09
2	Body	N77-H	654267	3814	DFT-QPSK 30K 20M 25_12	Front	25mm	/	25.05	26.50	0.506	0.71	0.238	0.33	-0.13
2	Body	N77-H	654267	3814	DFT-QPSK 30K 20M 25_12	Rear	19mm	/	25.05	26.50	0.529	0.74	0.243	0.34	-0.12
2	Body	N77-H	664666	3969.99	DFT-QPSK 30K 20M 25_12	Right	25mm	/	24.51	26.50	0.605	0.96	0.301	0.48	0.12
2	Body	N77-H	661200	3918	DFT-QPSK 30K 20M 25_12	Right	25mm	/	24.65	26.50	0.599	0.92	0.294	0.45	-0.10
2	Body	N77-H	657733	3866	DFT-QPSK 30K 20M 25_12	Right	25mm	/	24.74	26.50	0.565	0.85	0.28	0.42	-0.12
2	Body	N77-H	654267	3814	DFT-QPSK 30K 20M 25_12	Right	25mm	/	25.05	26.50	0.653	0.91	0.315	0.44	-0.14
2	Body	N77-H	650800	3762	DFT-QPSK 30K 20M 25_12	Right	25mm	/	24.64	26.50	0.613	0.94	0.301	0.46	0.16
2	Body	N77-H	647334	3710.01	DFT-QPSK 30K 20M 25_12	Right	25mm	FIG A.20	25.00	26.50	0.682	0.96	0.33	0.47	0.01
2	Body	N77-H	654267	3814	DFT-QPSK 30K 20M 25_12	Top	24mm	/	25.05	26.50	0.301	0.42	0.132	0.18	0.12
2	Body	N77-H	657733	3866	DFT-QPSK 30K 20M 25_12	Front	5mm	/	12.79	12.90	0.141	0.14	0.045	0.05	0.18
2	Body	N77-H	657733	3866	DFT-QPSK 30K 20M 25_12	Rear	5mm	/	12.79	12.90	0.074	0.08	0.024	0.02	0.10
2	Body	N77-H	657733	3866	DFT-QPSK 30K 20M 25_12	Right	5mm	/	12.79	12.90	0.11	0.11	0.032	0.03	0.08
2	Body	N77-H	657733	3866	DFT-QPSK 30K 20M 25_12	Top	5mm	/	12.79	12.90	0.076	0.08	0.022	0.02	-0.08
2	Body	N77-H	654267	3814	CP-QPSK 30K 20M 25_12	Right	25mm	/	23.08	25.00	0.517	0.80	0.255	0.40	0.16

16 SAR Measurement Variability

SAR measurement variability must be assessed for each frequency band, which is determined by the SAR probe calibration point and tissue-equivalent medium used for the device measurements. When both head and body tissue-equivalent media are required for SAR measurements in a frequency band, the variability measurement procedures should be applied to the tissue medium with the highest measured SAR, using the highest measured SAR configuration for that tissue-equivalent medium.

The following procedures are applied to determine if repeated measurements are required.

- 1) Repeated measurement is not required when the original highest measured SAR is < 0.80 W/kg; steps 2) through 4) do not apply.
- 2) When the original highest measured SAR is ≥ 0.80 W/kg, repeat that measurement once.
- 3) Perform a second repeated measurement only if the ratio of largest to smallest SAR for the original and first repeated measurements is > 1.20 or when the original or repeated measurement is ≥ 1.45 W/kg ($\sim 10\%$ from the 1-g SAR limit).
- 4) Perform a third repeated measurement only if the original, first or second repeated measurement is ≥ 1.5 W/kg and the ratio of largest to smallest SAR for the original, first and second repeated measurements is > 1.20 .

17 Measurement Uncertainty

17.1 Measurement Uncertainty for Normal SAR Tests (300MHz~3GHz)

No.	Error Description	Type	Uncertainty value	Probably Distribution	Div.	(Ci) 1g	(Ci) 10g	Std. Unc. (1g)	Std. Unc. (10g)	Degree of freedom
Measurement system										
1	Probe calibration	B	6.0	N	1	1	1	6.0	6.0	∞
2	Isotropy	B	4.7	R	$\sqrt{3}$	0.7	0.7	1.9	1.9	∞
3	Boundary effect	B	1.0	R	$\sqrt{3}$	1	1	0.6	0.6	∞
4	Linearity	B	4.7	R	$\sqrt{3}$	1	1	2.7	2.7	∞
5	Detection limit	B	1.0	N	1	1	1	0.6	0.6	∞
6	Readout electronics	B	0.3	R	$\sqrt{3}$	1	1	0.3	0.3	∞
7	Response time	B	0.8	R	$\sqrt{3}$	1	1	0.5	0.5	∞
8	Integration time	B	2.6	R	$\sqrt{3}$	1	1	1.5	1.5	∞
9	RF ambient conditions-noise	B	0	R	$\sqrt{3}$	1	1	0	0	∞
10	RFambient conditions-reflection	B	0	R	$\sqrt{3}$	1	1	0	0	∞
11	Probe positioned mech. restrictions	B	0.4	R	$\sqrt{3}$	1	1	0.2	0.2	∞
12	Probe positioning with respect to phantom shell	B	2.9	R	$\sqrt{3}$	1	1	1.7	1.7	∞
13	Post-processing	B	1.0	R	$\sqrt{3}$	1	1	0.6	0.6	∞
Test sample related										
14	Test sample positioning	A	3.3	N	1	1	1	3.3	3.3	71
15	Device holder uncertainty	A	3.4	N	1	1	1	3.4	3.4	5
16	Drift of output power	B	5.0	R	$\sqrt{3}$	1	1	2.9	2.9	∞
Phantom and set-up										
17	Phantom uncertainty	B	4.0	R	$\sqrt{3}$	1	1	2.3	2.3	∞
18	Liquid conductivity (target)	B	5.0	R	$\sqrt{3}$	0.64	0.43	1.8	1.2	∞
19	Liquid conductivity (meas.)	A	2.06	N	1	0.64	0.43	1.32	0.89	43
20	Liquid permittivity (target)	B	5.0	R	$\sqrt{3}$	0.6	0.49	1.7	1.4	∞
21	Liquid permittivity (meas.)	A	1.6	N	1	0.6	0.49	1.0	0.8	521

Combined standard uncertainty	$u_c = \sqrt{\sum_{i=1}^{21} c_i^2 u_i^2}$						9.55	9.43	257
Expanded uncertainty (confidence interval of 95 %)	$u_e = 2u_c$						19.1	18.9	

17.2 Measurement Uncertainty for Normal SAR Tests (3~6GHz)

No.	Error Description	Type	Uncertainty value	Probably Distribution	Div.	(Ci) 1g	(Ci) 10g	Std. Unc. (1g)	Std. Unc. (10g)	Degree of freedom
Measurement system										
1	Probe calibration	B	6.55	N	1	1	1	6.55	6.55	∞
2	Isotropy	B	4.7	R	$\sqrt{3}$	0.7	0.7	1.9	1.9	∞
3	Boundary effect	B	2.0	R	$\sqrt{3}$	1	1	1.2	1.2	∞
4	Linearity	B	4.7	R	$\sqrt{3}$	1	1	2.7	2.7	∞
5	Detection limit	B	1.0	R	$\sqrt{3}$	1	1	0.6	0.6	∞
6	Readout electronics	B	0.3	R	$\sqrt{3}$	1	1	0.3	0.3	∞
7	Response time	B	0.8	R	$\sqrt{3}$	1	1	0.5	0.5	∞
8	Integration time	B	2.6	R	$\sqrt{3}$	1	1	1.5	1.5	∞
9	RF ambient conditions-noise	B	0	R	$\sqrt{3}$	1	1	0	0	∞
10	RF ambient conditions-reflection	B	0	R	$\sqrt{3}$	1	1	0	0	∞
11	Probe positioned mech. restrictions	B	0.8	R	$\sqrt{3}$	1	1	0.5	0.5	∞
12	Probe positioning with respect to phantom shell	B	6.7	R	$\sqrt{3}$	1	1	3.9	3.9	∞
13	Post-processing	B	4.0	R	$\sqrt{3}$	1	1	2.3	2.3	∞
Test sample related										
14	Test sample positioning	A	3.3	N	1	1	1	3.3	3.3	71
15	Device holder uncertainty	A	3.4	N	1	1	1	3.4	3.4	5
16	Drift of output power	B	5.0	R	$\sqrt{3}$	1	1	2.9	2.9	∞
Phantom and set-up										
17	Phantom uncertainty	B	4.0	R	$\sqrt{3}$	1	1	2.3	2.3	∞
18	Liquid conductivity (target)	B	5.0	R	$\sqrt{3}$	0.64	0.43	1.8	1.2	∞
19	Liquid conductivity (meas.)	A	2.06	N	1	0.64	0.43	1.32	0.89	43
20	Liquid permittivity (target)	B	5.0	R	$\sqrt{3}$	0.6	0.49	1.7	1.4	∞

21	Liquid permittivity (meas.)	A	1.6	N	1	0.6	0.49	1.0	0.8	521
Combined standard uncertainty		$u_c = \sqrt{\sum_{i=1}^{21} c_i^2 u_i^2}$						10.7	10.6	257
Expanded uncertainty (confidence interval of 95 %)		$u_e = 2u_c$						21.4	21.1	

17.3 Measurement Uncertainty for Fast SAR Tests (300MHz~3GHz)

No.	Error Description	Type	Uncertainty value	Probably Distribution	Div.	(Ci) 1g	(Ci) 10g	Std. Unc. (1g)	Std. Unc. (10g)	Degree of freedom
Measurement system										
1	Probe calibration	B	6.0	N	1	1	1	6.0	6.0	∞
2	Isotropy	B	4.7	R	$\sqrt{3}$	0.7	0.7	1.9	1.9	∞
3	Boundary effect	B	1.0	R	$\sqrt{3}$	1	1	0.6	0.6	∞
4	Linearity	B	4.7	R	$\sqrt{3}$	1	1	2.7	2.7	∞
5	Detection limit	B	1.0	R	$\sqrt{3}$	1	1	0.6	0.6	∞
6	Readout electronics	B	0.3	R	$\sqrt{3}$	1	1	0.3	0.3	∞
7	Response time	B	0.8	R	$\sqrt{3}$	1	1	0.5	0.5	∞
8	Integration time	B	2.6	R	$\sqrt{3}$	1	1	1.5	1.5	∞
9	RF ambient conditions-noise	B	0	R	$\sqrt{3}$	1	1	0	0	∞
10	RFambient conditions-reflection	B	0	R	$\sqrt{3}$	1	1	0	0	∞
11	Probe positioned mech. Restrictions	B	0.4	R	$\sqrt{3}$	1	1	0.2	0.2	∞
12	Probe positioning with respect to phantom shell	B	2.9	R	$\sqrt{3}$	1	1	1.7	1.7	∞
13	Post-processing	B	1.0	R	$\sqrt{3}$	1	1	0.6	0.6	∞
14	Fast SAR z-Approximation	B	7.0	R	$\sqrt{3}$	1	1	4.0	4.0	∞
Test sample related										
15	Test sample positioning	A	3.3	N	1	1	1	3.3	3.3	71
16	Device holder uncertainty	A	3.4	N	1	1	1	3.4	3.4	5
17	Drift of output power	B	5.0	R	$\sqrt{3}$	1	1	2.9	2.9	∞
Phantom and set-up										
18	Phantom uncertainty	B	4.0	R	$\sqrt{3}$	1	1	2.3	2.3	∞
19	Liquid conductivity (target)	B	5.0	R	$\sqrt{3}$	0.64	0.43	1.8	1.2	∞

20	Liquid conductivity (meas.)	A	2.06	N	1	0.64	0.43	1.32	0.89	43
21	Liquid permittivity (target)	B	5.0	R	$\sqrt{3}$	0.6	0.49	1.7	1.4	∞
22	Liquid permittivity (meas.)	A	1.6	N	1	0.6	0.49	1.0	0.8	521
Combined standard uncertainty		$u'_c = \sqrt{\sum_{i=1}^{22} c_i^2 u_i^2}$						10.4	10.3	257
Expanded uncertainty (confidence interval of 95 %)		$u_e = 2u_c$						20.8	20.6	

17.4 Measurement Uncertainty for Fast SAR Tests (3~6GHz)

No.	Error Description	Type	Uncertainty value	Probably Distribution	Div.	(Ci) 1g	(Ci) 10g	Std. Unc. (1g)	Std. Unc. (10g)	Degree of freedom
Measurement system										
1	Probe calibration	B	6.55	N	1	1	1	6.55	6.55	∞
2	Isotropy	B	4.7	R	$\sqrt{3}$	0.7	0.7	1.9	1.9	∞
3	Boundary effect	B	2.0	R	$\sqrt{3}$	1	1	1.2	1.2	∞
4	Linearity	B	4.7	R	$\sqrt{3}$	1	1	2.7	2.7	∞
5	Detection limit	B	1.0	R	$\sqrt{3}$	1	1	0.6	0.6	∞
6	Readout electronics	B	0.3	R	$\sqrt{3}$	1	1	0.3	0.3	∞
7	Response time	B	0.8	R	$\sqrt{3}$	1	1	0.5	0.5	∞
8	Integration time	B	2.6	R	$\sqrt{3}$	1	1	1.5	1.5	∞
9	RF ambient conditions-noise	B	0	R	$\sqrt{3}$	1	1	0	0	∞
10	RFambient conditions-reflection	B	0	R	$\sqrt{3}$	1	1	0	0	∞
11	Probe positioned mech. Restrictions	B	0.8	R	$\sqrt{3}$	1	1	0.5	0.5	∞
12	Probe positioning with respect to phantom shell	B	6.7	R	$\sqrt{3}$	1	1	3.9	3.9	∞
13	Post-processing	B	1.0	R	$\sqrt{3}$	1	1	0.6	0.6	∞
14	Fast SAR z-Approximation	B	14.0	R	$\sqrt{3}$	1	1	8.1	8.1	∞
Test sample related										
15	Test sample positioning	A	3.3	N	1	1	1	3.3	3.3	71
16	Device holder uncertainty	A	3.4	N	1	1	1	3.4	3.4	5

17	Drift of output power	B	5.0	R	$\sqrt{3}$	1	1	2.9	2.9	∞
Phantom and set-up										
18	Phantom uncertainty	B	4.0	R	$\sqrt{3}$	1	1	2.3	2.3	∞
19	Liquid conductivity (target)	B	5.0	R	$\sqrt{3}$	0.64	0.43	1.8	1.2	∞
20	Liquid conductivity (meas.)	A	2.06	N	1	0.64	0.43	1.32	0.89	43
21	Liquid permittivity (target)	B	5.0	R	$\sqrt{3}$	0.6	0.49	1.7	1.4	∞
22	Liquid permittivity (meas.)	A	1.6	N	1	0.6	0.49	1.0	0.8	521
Combined standard uncertainty		$u_c = \sqrt{\sum_{i=1}^{22} c_i^2 u_i^2}$						13.5	13.4	257
Expanded uncertainty (confidence interval of 95 %)		$u_e = 2u_c$						27.0	26.8	

18 MAIN TEST INSTRUMENTS

Table 18.1: List of Main Instruments

No.	Name	Type	Serial Number	Calibration Date	Valid Period
01	Network analyzer	E5071C	MY46110673	January 4, 2022	One year
02	Power sensor	NRP110T	101139	January 13, 2022	One year
03	Power sensor	NRP110T	101159		
04	Signal Generator	E4438C	MY49071430	January 13, 2022	One Year
05	Amplifier	60S1G4	0331848	No Calibration Requested	
06	BTS	CMW500	159890	January 24, 2022	One year
07	BTS	CMW500	129942	February 14 2022	One year
08	DAE	SPEAG DAE4	777	January 07, 2022	One year
09	E-field Probe	SPEAG EX3DV4	7600	December 29, 2021	One year
10	Dipole Validation Kit	SPEAG D750V3	1017	July 12,2021	One year
11	Dipole Validation Kit	SPEAG D835V2	4d069	July 12,,2021	One year
12	Dipole Validation Kit	SPEAG D1750V2	1003	July 12,,2021	One year
13	Dipole Validation Kit	SPEAG D1900V2	5d101	July 15,2021	One year
14	Dipole Validation Kit	SPEAG D2450V2	853	July 26,2021	One year
15	Dipole Validation Kit	SPEAG D3500V2	1016	June 21,2021	One year
16	Dipole Validation Kit	SPEAG D3700V2	1004	June 21,2021	One year
17	Dipole Validation Kit	SPEAG D3900V2	1024	June 21,2021	One year
18	Dipole Validation Kit	SPEAG D5GHzV2	1262	January 27, 2022	One year
19	Dipole Validation Kit	SPEAG D6.5GHzV2	10.59	December 01,2021	One year
20	5G Verification Source	10 GHz	1005	January 24,2022	One year
21	EummWV Probe	EummWV4	9448	January 26,2022	One year
22	E-field Probe	SPEAG EX3DV4	7464	January 26, 2022	One year
23	DAE	SPEAG DAE4	1331	September 01, 2021	One year
24	Dipole Validation Kit	SPEAG D5GHzV2	1060	July 05, 2022	One year

END OF REPORT BODY

ANNEX A Graph Results

WCDMA850 body PJB 48A 6.9

Date: 6/10/2022

Electronics: DAE4 Sn777

Medium: H835

Medium parameters used (interpolated): $f = 836.6$ MHz; $\sigma = 0.861$ S/m; $\epsilon_r = 43.49$; $\rho = 1000$ kg/m³

Ambient Temperature: 23.3°C Liquid Temperature: 22.5°C

Communication System: Frequency: 836.6 MHz Duty Cycle: 1:1

Probe: EX3DV4 - SN7600 ConvF(10.74, 10.74, 10.74)

Area Scan (101x161x1): Interpolated grid: dx=1.500 mm, dy=1.500 mm

Maximum value of SAR (interpolated) = 0.427 W/kg

Zoom Scan (5x5x7)/Cube 0: Measurement grid: dx=8mm, dy=8mm, dz=5mm

Reference Value = 6.978 V/m; Power Drift = 0.08 dB

Peak SAR (extrapolated) = 0.493 W/kg

SAR(1 g) = 0.299 W/kg; SAR(10 g) = 0.184 W/kg

Maximum value of SAR (measured) = 0.422 W/kg

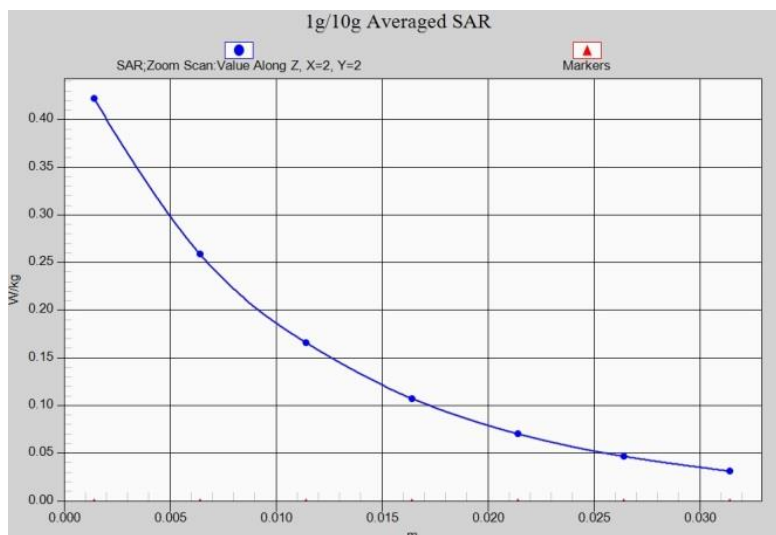
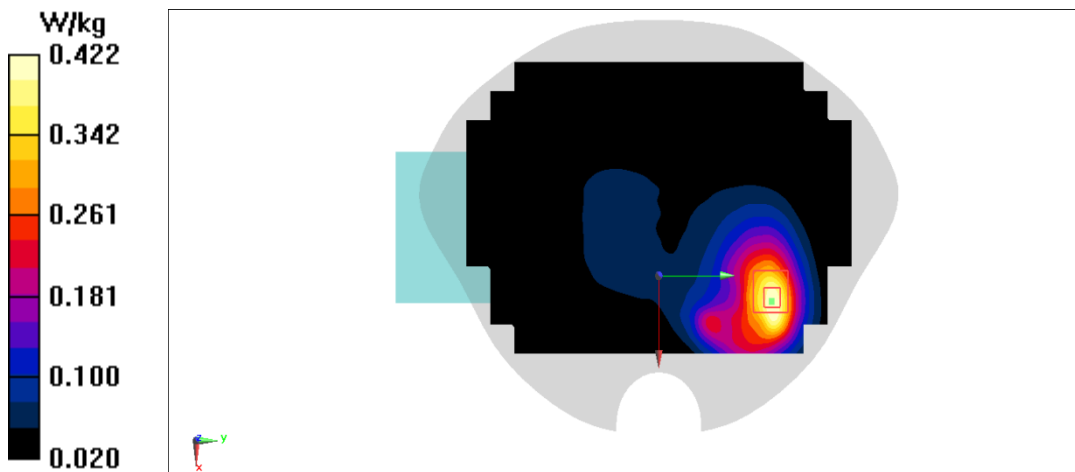

WCDMA1900 body

Date: 6/11/2022

Electronics: DAE4 Sn777

Medium: H1900

Medium parameters used (interpolated): $f = 1907.6$ MHz; $\sigma = 1.424$ S/m; $\epsilon_r = 41.27$; $\rho = 1000$ kg/m³

Ambient Temperature: 23.3°C Liquid Temperature: 22.5°C

Communication System: Frequency: 1907.6 MHz Duty Cycle: 1:1

Probe: EX3DV4 - SN7600 ConvF(8.54, 8.54, 8.54)

Area Scan (101x161x1): Interpolated grid: dx=1.500 mm, dy=1.500 mm

Maximum value of SAR (interpolated) = 0.617 W/kg

Zoom Scan (5x5x7)/Cube 0: Measurement grid: dx=8mm, dy=8mm, dz=5mm

Reference Value = 1.731 V/m; Power Drift = 0.12 dB

Peak SAR (extrapolated) = 0.880 W/kg

SAR(1 g) = 0.391 W/kg; SAR(10 g) = 0.184 W/kg

Maximum value of SAR (measured) = 0.700 W/kg

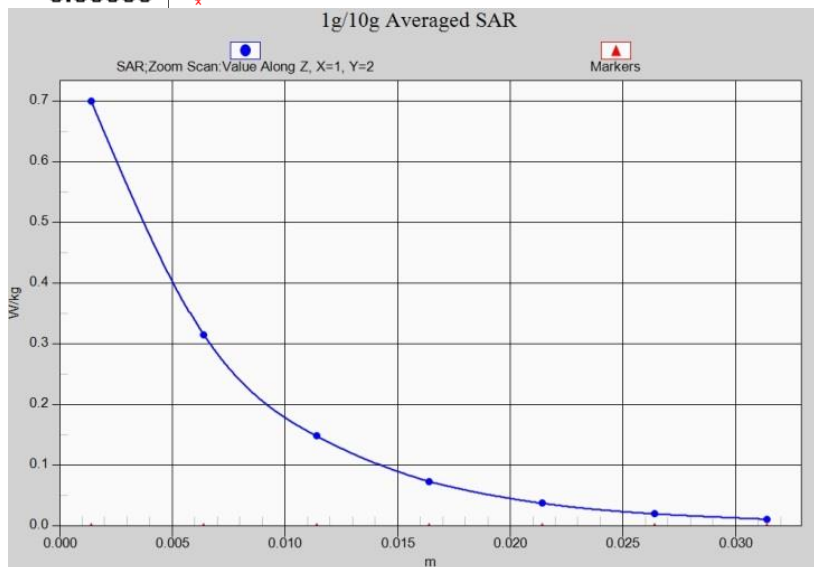
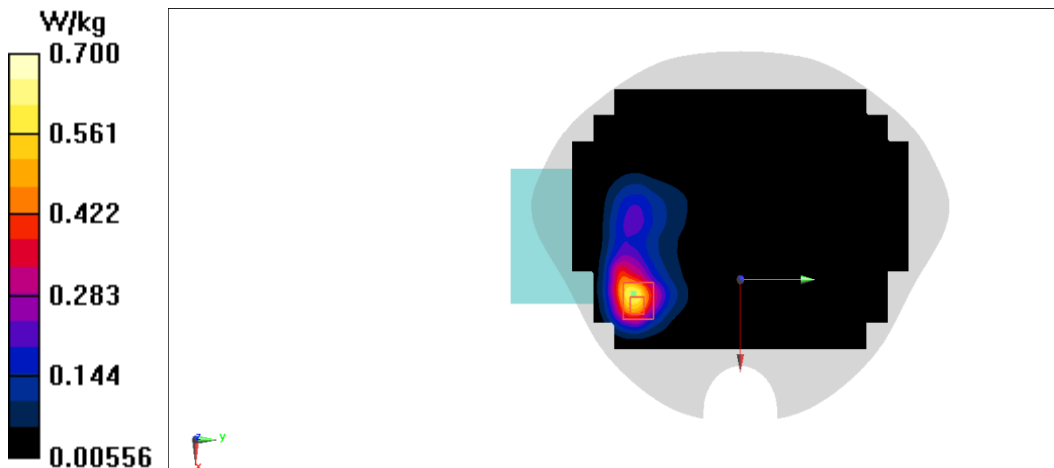

LTE B2 body

Date: 6/11/2022

Electronics: DAE4 Sn777

Medium: H1900

Medium parameters used: $f = 1900 \text{ MHz}$; $\sigma = 1.421 \text{ S/m}$; $\epsilon_r = 41.27$; $\rho = 1000 \text{ kg/m}^3$

Ambient Temperature: 23.3°C Liquid Temperature: 22.5°C

Communication System: Frequency: 1900 MHz Duty Cycle: 1:1

Probe: EX3DV4 - SN7600 ConvF(8.54, 8.54, 8.54)

Area Scan (101x161x1): Interpolated grid: $dx=1.500 \text{ mm}$, $dy=1.500 \text{ mm}$

Maximum value of SAR (interpolated) = 0.507 W/kg

Zoom Scan (5x5x7)/Cube 0: Measurement grid: $dx=8\text{mm}$, $dy=8\text{mm}$, $dz=5\text{mm}$

Reference Value = 0.4780 V/m ; Power Drift = 0.02 dB

Peak SAR (extrapolated) = 0.867 W/kg

SAR(1 g) = 0.373 W/kg ; SAR(10 g) = 0.166 W/kg

Maximum value of SAR (measured) = 0.688 W/kg

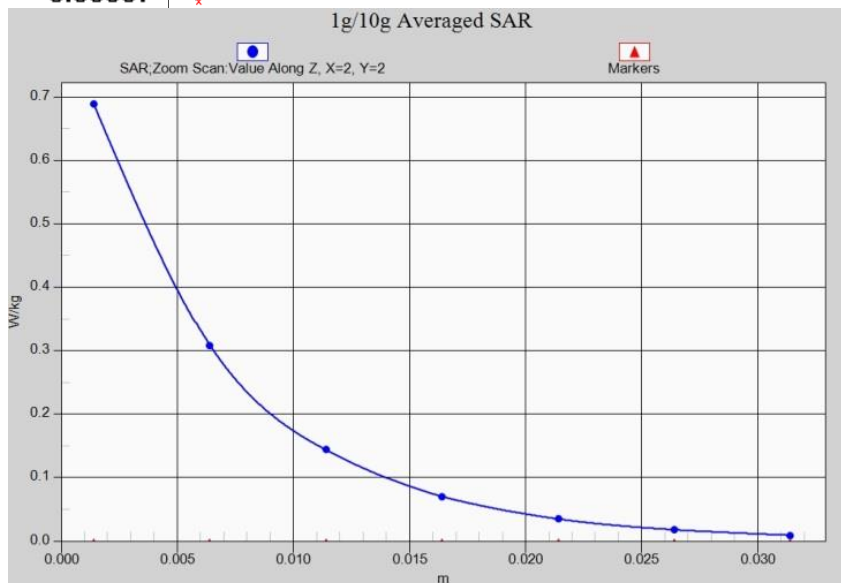
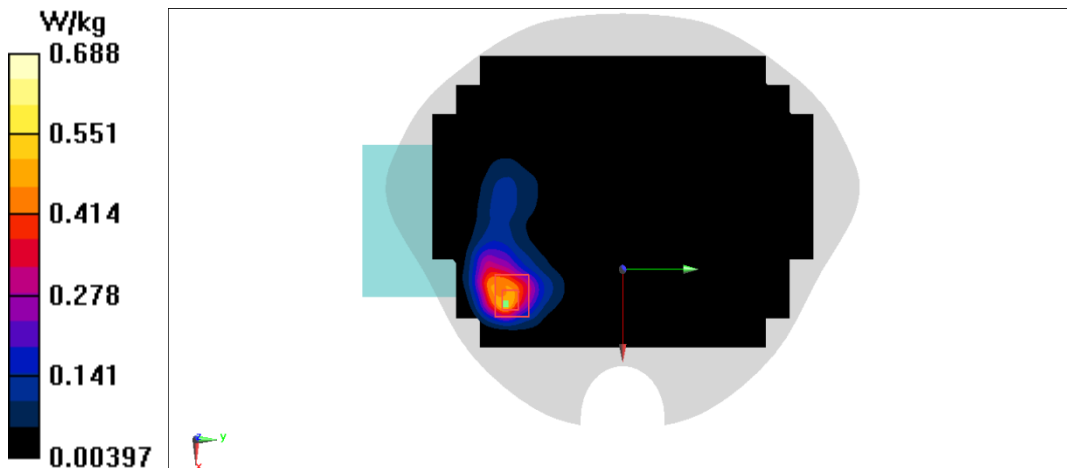

LTE B4 body

Date: 6/9/2022

Electronics: DAE4 Sn777

Medium: H1750

Medium parameters used: $f = 1720 \text{ MHz}$; $\sigma = 1.315 \text{ S/m}$; $\epsilon_r = 41.51$; $\rho = 1000 \text{ kg/m}^3$

Ambient Temperature: 23.3°C Liquid Temperature: 22.5°C

Communication System: Frequency: 1720 MHz Duty Cycle: 1:1

Probe: EX3DV4 - SN7600 ConvF(8.93, 8.93, 8.93)

Area Scan (101x161x1): Interpolated grid: $dx=1.500 \text{ mm}$, $dy=1.500 \text{ mm}$

Maximum value of SAR (interpolated) = 0.838 W/kg

Zoom Scan (5x5x7)/Cube 0: Measurement grid: $dx=8\text{mm}$, $dy=8\text{mm}$, $dz=5\text{mm}$

Reference Value = 3.212 V/m ; Power Drift = 0.01 dB

Peak SAR (extrapolated) = 1.07 W/kg

SAR(1 g) = 0.589 W/kg ; SAR(10 g) = 0.316 W/kg

Maximum value of SAR (measured) = 0.843 W/kg

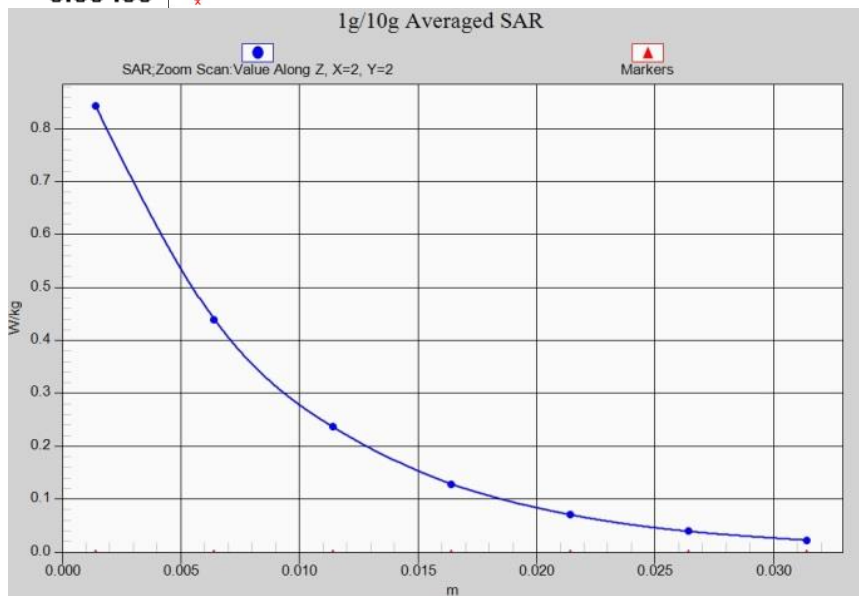
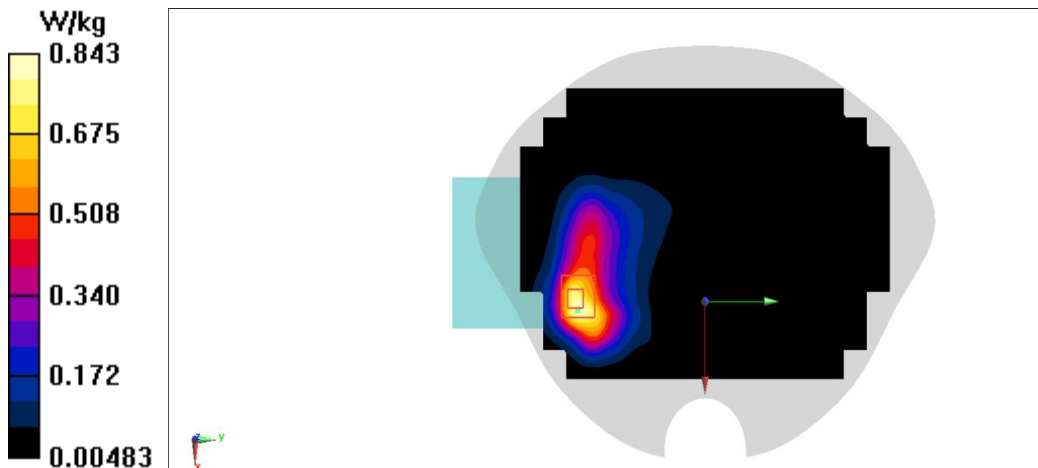

LTE B5 body

Date: 6/10/2022

Electronics: DAE4 Sn777

Medium: H835

Medium parameters used (interpolated): $f = 844 \text{ MHz}$; $\sigma = 0.866 \text{ S/m}$; $\epsilon_r = 43.46$; $\rho = 1000 \text{ kg/m}^3$

Ambient Temperature: 23.3°C Liquid Temperature: 22.5°C

Communication System: Frequency: 844 MHz Duty Cycle: 1:1

Probe: EX3DV4 - SN7600 ConvF(10.74, 10.74, 10.74)

Area Scan (81x141x1): Interpolated grid: $dx=1.500 \text{ mm}$, $dy=1.500 \text{ mm}$

Maximum value of SAR (interpolated) = 0.306 W/kg

Zoom Scan (5x5x7)/Cube 0: Measurement grid: $dx=8\text{mm}$, $dy=8\text{mm}$, $dz=5\text{mm}$

Reference Value = 9.872 V/m ; Power Drift = 0.08 dB

Peak SAR (extrapolated) = 0.347 W/kg

SAR(1 g) = 0.230 W/kg ; SAR(10 g) = 0.152 W/kg

Maximum value of SAR (measured) = 0.304 W/kg

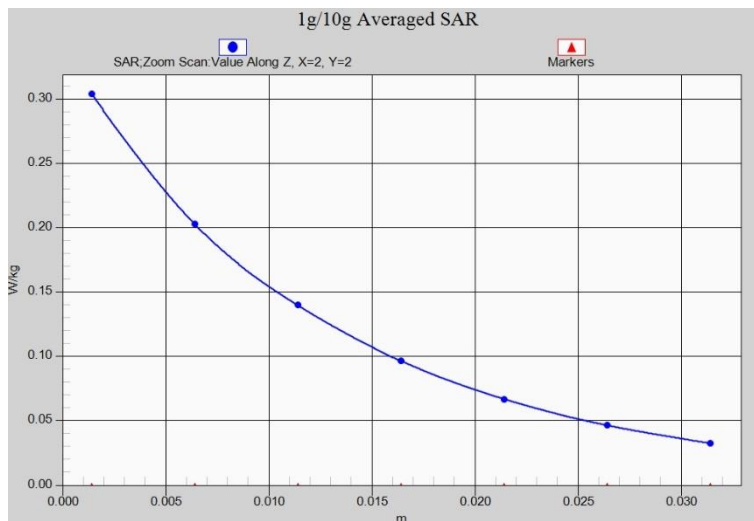
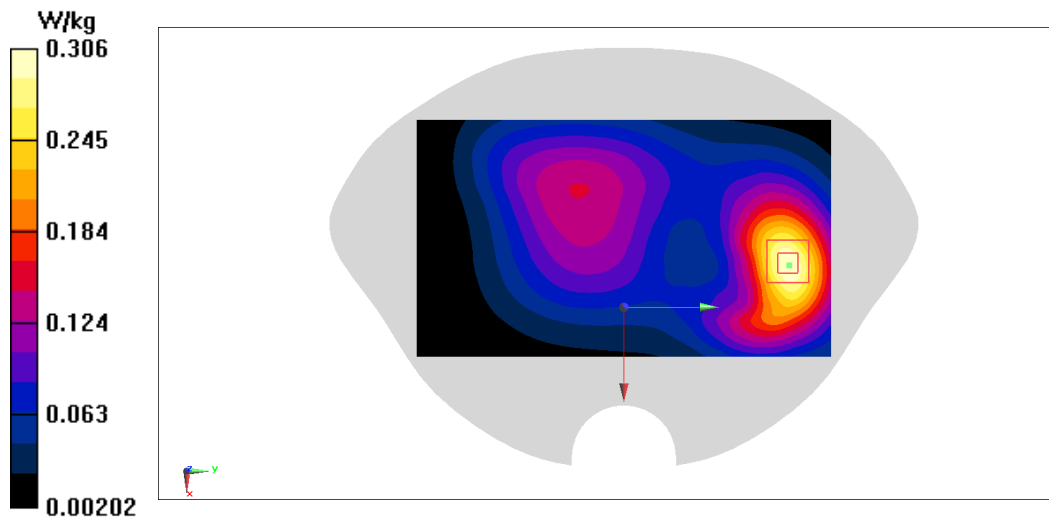

LTE B12 body

Date: 6/8/2022

Electronics: DAE4 Sn777

Medium: H750

Medium parameters used (interpolated): $f = 704 \text{ MHz}$; $\sigma = 0.829 \text{ S/m}$; $\epsilon_r = 44.04$; $\rho = 1000 \text{ kg/m}^3$

Ambient Temperature: 23.3°C Liquid Temperature: 22.5°C

Communication System: Frequency: 704 MHz Duty Cycle: 1:1

Probe: EX3DV4 - SN7600 ConvF(10.74, 10.74, 10.74)

Area Scan (101x161x1): Interpolated grid: $dx=1.500 \text{ mm}$, $dy=1.500 \text{ mm}$

Maximum value of SAR (interpolated) = 0.315 W/kg

Zoom Scan (5x5x7)/Cube 0: Measurement grid: $dx=8\text{mm}$, $dy=8\text{mm}$, $dz=5\text{mm}$

Reference Value = 8.865 V/m ; Power Drift = 0.07 dB

Peak SAR (extrapolated) = 0.367 W/kg

SAR(1 g) = 0.229 W/kg ; SAR(10 g) = 0.145 W/kg

Maximum value of SAR (measured) = 0.315 W/kg

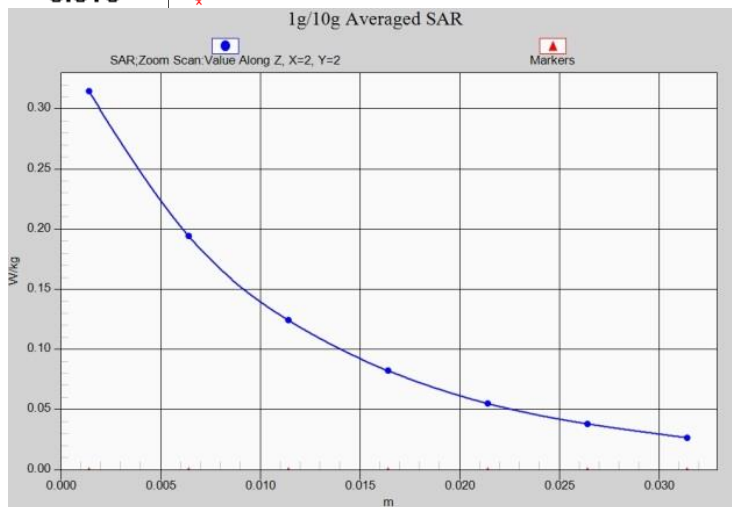
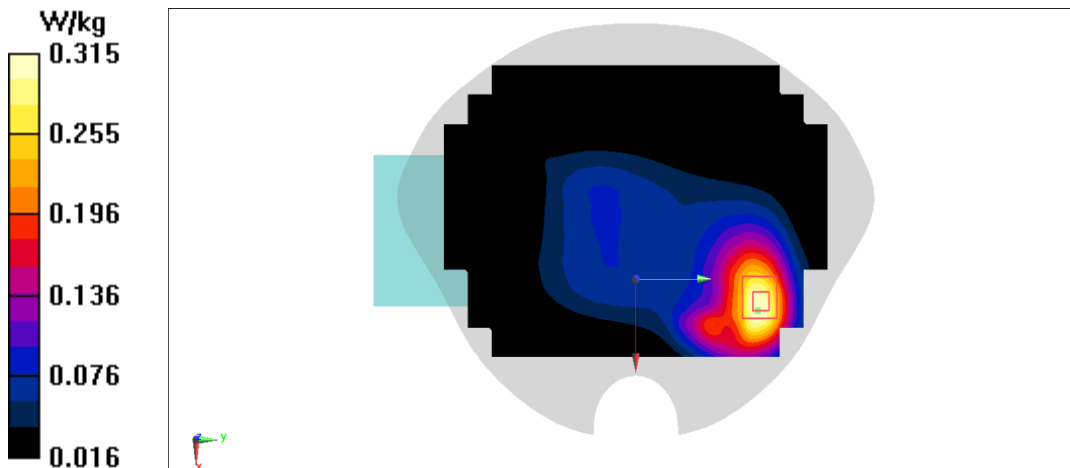

LTE B13 body

Date: 6/8/2022

Electronics: DAE4 Sn777

Medium: H750

Medium parameters used (interpolated): $f = 782 \text{ MHz}$; $\sigma = 0.859 \text{ S/m}$; $\epsilon_r = 43.78$; $\rho = 1000 \text{ kg/m}^3$

Ambient Temperature: 23.3°C Liquid Temperature: 22.5°C

Communication System: Frequency: 782 MHz Duty Cycle: 1:1

Probe: EX3DV4 - SN7600 ConvF(10.74, 10.74, 10.74)

Area Scan (81x141x1): Interpolated grid: $dx=1.500 \text{ mm}$, $dy=1.500 \text{ mm}$

Maximum value of SAR (interpolated) = 0.212 W/kg

Zoom Scan (5x5x7)/Cube 0: Measurement grid: $dx=8\text{mm}$, $dy=8\text{mm}$, $dz=5\text{mm}$

Reference Value = 13.36 V/m ; Power Drift = 0.08 dB

Peak SAR (extrapolated) = 0.241 W/kg

SAR(1 g) = 0.160 W/kg ; SAR(10 g) = 0.107 W/kg

Maximum value of SAR (measured) = 0.211 W/kg

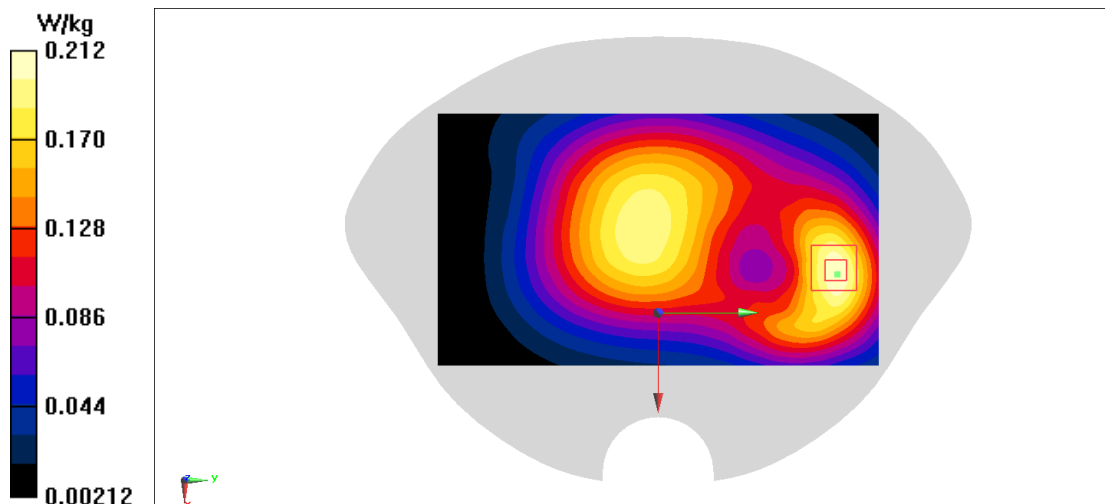

LTE B48 body

Date: 6/18/2022

Electronics: DAE4 Sn777

Medium: H3G

Medium parameters used: $f = 3625$ MHz; $\sigma = 2.911$ S/m; $\epsilon_r = 39.97$; $\rho = 1000$ kg/m³

Ambient Temperature: 23.30C Liquid Temperature: 22.50C

Communication System: LTE Band48 3625 MHz Duty Cycle: 1:1.5787

Probe: EX3DV4 - SN7600 ConvF(6.78, 6.78, 6.78)

Area Scan (131x201x1): Interpolated grid: dx=1.000 mm, dy=1.000 mm

Maximum value of SAR (interpolated) = 0.996 W/kg

Zoom Scan (7x7x7)/Cube 0: Measurement grid: dx=4mm, dy=4mm, dz=1.4mm

Reference Value = 0 V/m; Power Drift = 0.12 dB

Peak SAR (extrapolated) = 1.48 W/kg

SAR(1 g) = 0.520 W/kg; SAR(10 g) = 0.169 W/kg

Maximum value of SAR (measured) = 1.06 W/kg

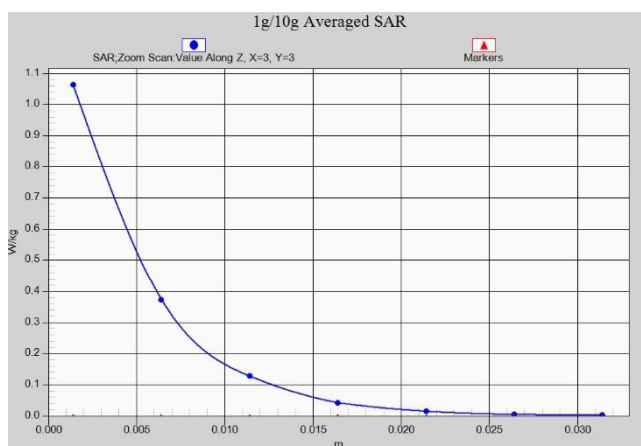
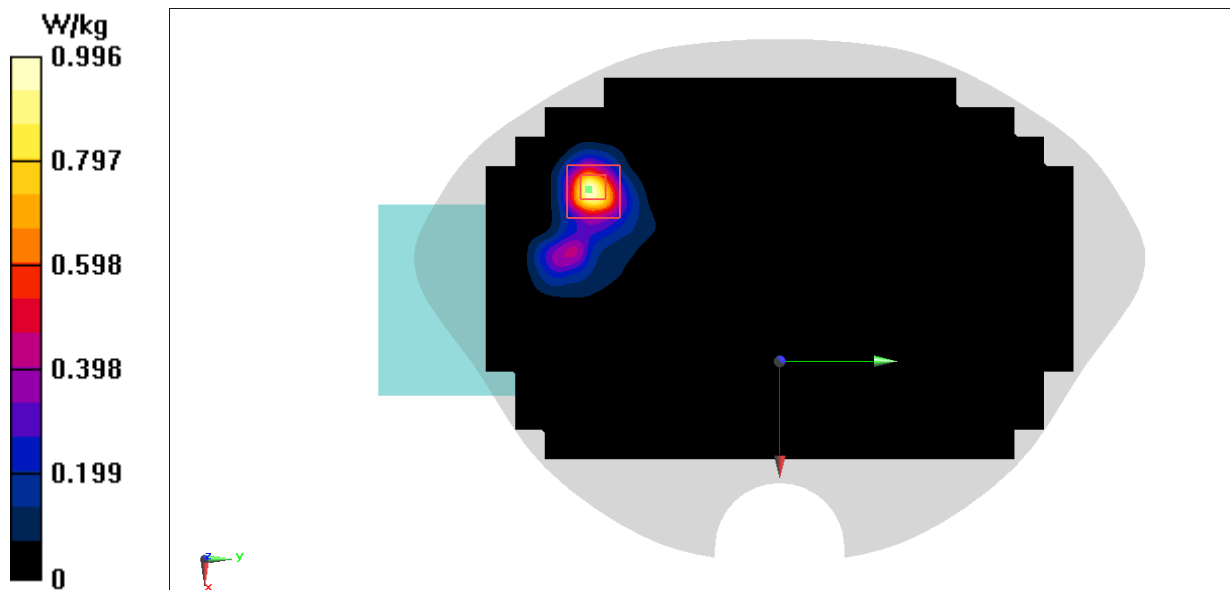

LTE B66 body

Date: 6/9/2022

Electronics: DAE4 Sn777

Medium: H1750

Medium parameters used: $f = 1770$ MHz; $\sigma = 1.34$ S/m; $\epsilon_r = 41.41$; $\rho = 1000$ kg/m³

Ambient Temperature: 23.3oC Liquid Temperature: 22.5oC

Communication System: Frequency: 1770 MHz Duty Cycle: 1:1

Probe: EX3DV4 - SN7600 ConvF(8.93, 8.93, 8.93)

Area Scan (101x161x1): Interpolated grid: dx=1.500 mm, dy=1.500 mm

Maximum value of SAR (interpolated) = 0.447 W/kg

Zoom Scan (5x5x7)/Cube 0: Measurement grid: dx=8mm, dy=8mm, dz=5mm

Reference Value = 2.629 V/m; Power Drift = 0.15 dB

Peak SAR (extrapolated) = 0.716 W/kg

SAR(1 g) = 0.312 W/kg; SAR(10 g) = 0.154 W/kg

Maximum value of SAR (measured) = 0.525 W/kg

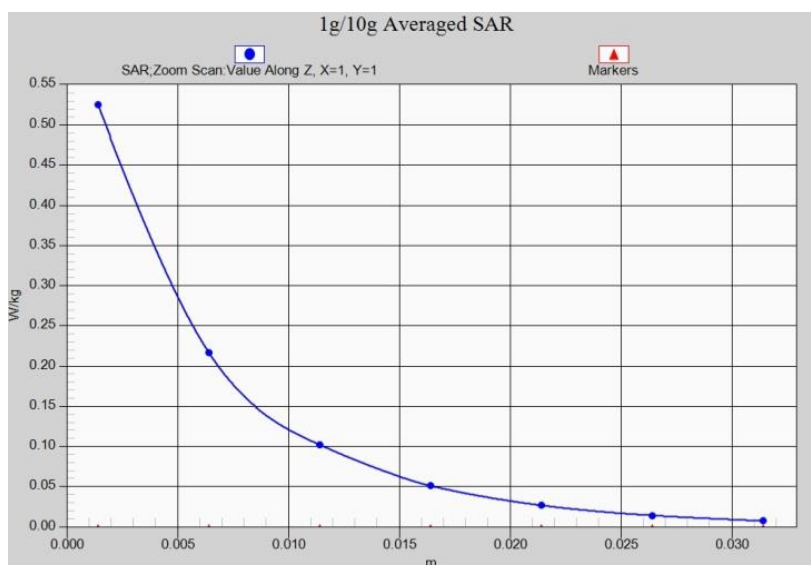
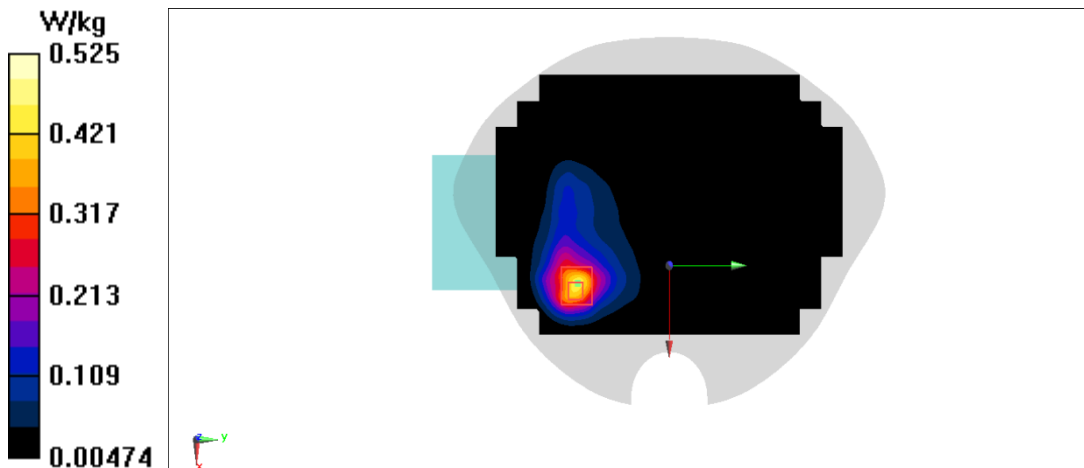

WiFi2.4G Body ANT4 SAR

Date: 8/9/2022

Electronics: DAE4 Sn777

Medium: H2450

Medium parameters used: $f = 2412$ MHz; $\sigma = 1.794$ S/m; $\epsilon_r = 40.56$; $\rho = 1000$ kg/m³

Ambient Temperature: 23.3°C Liquid Temperature: 22.5°C

Communication System: WiFi 2450 2412 MHz Duty Cycle: 1:1

Probe: EX3DV4 - SN7600 ConvF(7.82, 7.82, 7.82)

Area Scan (91x131x1): Interpolated grid: $dx=1.200$ mm, $dy=1.200$ mm

Maximum value of SAR (interpolated) = 0.200 W/kg

Zoom Scan (6x6x7)/Cube 0: Measurement grid: $dx=5$ mm, $dy=5$ mm, $dz=5$ mm

Reference Value = 1.409 V/m; Power Drift = 0.18 dB

Peak SAR (extrapolated) = 0.308 W/kg

SAR(1 g) = 0.144 W/kg; SAR(10 g) = 0.068 W/kg

Maximum value of SAR (measured) = 0.237 W/kg

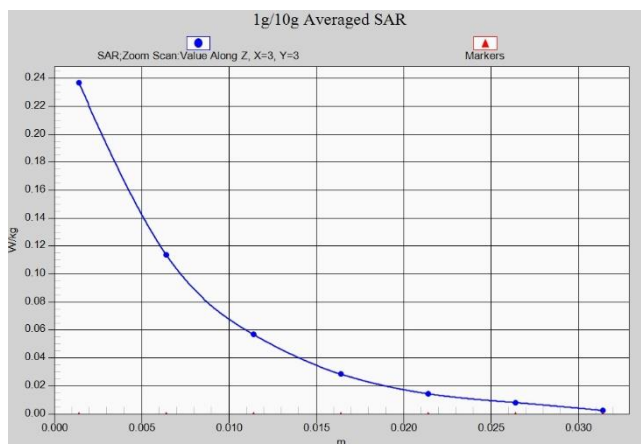
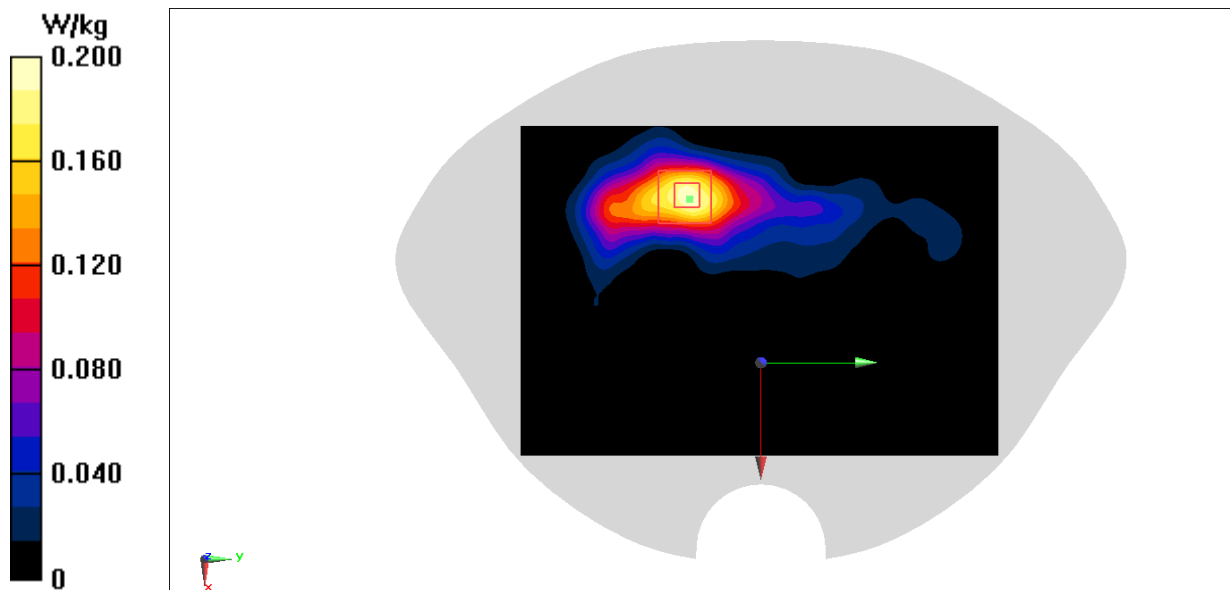

WiFi2.4G Body ANT5 SAR

Date: 8/9/2022

Electronics: DAE4 Sn777

Medium: H2450

Medium parameters used: $f = 2412 \text{ MHz}$; $\sigma = 1.794 \text{ S/m}$; $\epsilon_r = 40.56$; $\rho = 1000 \text{ kg/m}^3$

Ambient Temperature: 23.3°C Liquid Temperature: 22.5°C

Communication System: WiFi 2450 2412 MHz Duty Cycle: 1:1

Probe: EX3DV4 - SN7600 ConvF(7.82, 7.82, 7.82)

Area Scan (91x141x1): Interpolated grid: $dx=1.200 \text{ mm}$, $dy=1.200 \text{ mm}$

Maximum value of SAR (interpolated) = 0.449 W/kg

Zoom Scan (5x5x7)/Cube 0: Measurement grid: $dx=5\text{mm}$, $dy=5\text{mm}$, $dz=5\text{mm}$

Reference Value = 7.367 V/m ; Power Drift = 0.16 dB

Peak SAR (extrapolated) = 0.666 W/kg

SAR(1 g) = 0.289 W/kg ; SAR(10 g) = 0.112 W/kg

Maximum value of SAR (measured) = 0.520 W/kg

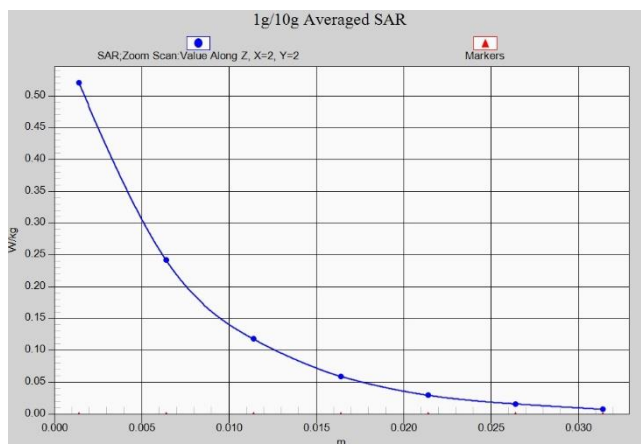
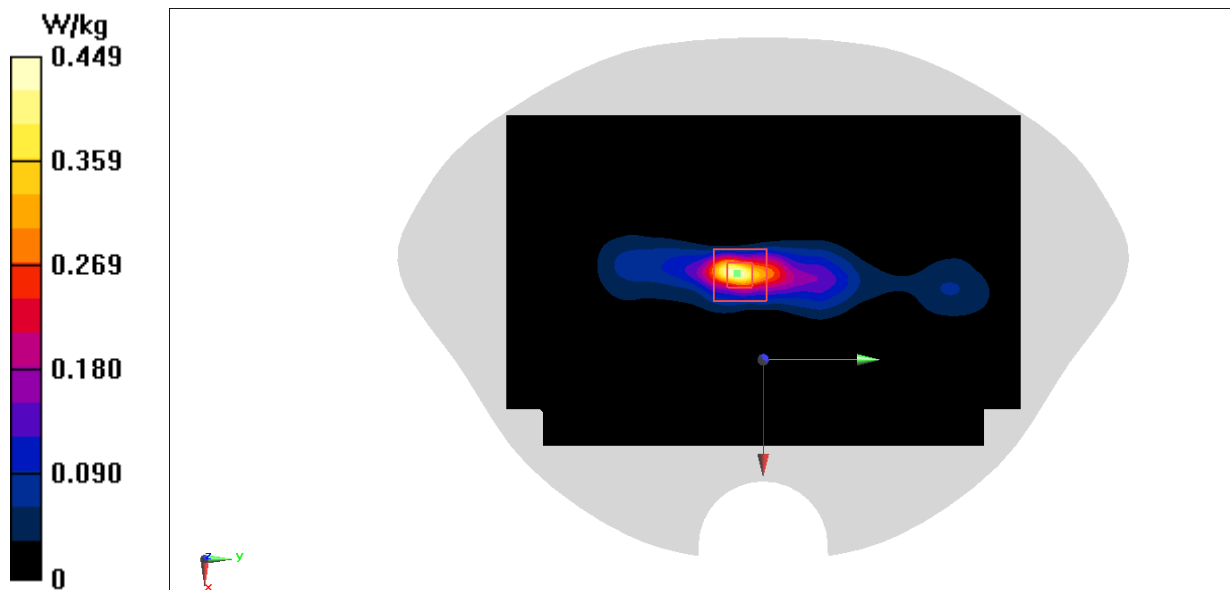

WiFi5G Body ANT4 SAR

Date: 6/22/2022

Electronics: DAE4 Sn777

Medium: H5G

Medium parameters used: $f = 5600$ MHz; $\sigma = 4.956$ S/m; $\epsilon_r = 34.32$; $\rho = 1000$ kg/m³

Ambient Temperature: 23.3°C Liquid Temperature: 22.5°C

Communication System: WLAN 11a 5600 MHz Duty Cycle: 1:1

Probe: EX3DV4 – SN7600 ConvF(5.13, 5.13, 5.13)

Area Scan (81x131x1): Interpolated grid: dx=1.000 mm, dy=1.000 mm

Maximum value of SAR (interpolated) = 0.523 W/kg

Zoom Scan (6x6x7)/Cube 0: Measurement grid: dx=4mm, dy=4mm, dz=1.4mm

Reference Value = 3.383 V/m; Power Drift = -0.06 dB

Peak SAR (extrapolated) = 1.22 W/kg

SAR(1 g) = 0.313 W/kg; SAR(10 g) = 0.104 W/kg

Maximum value of SAR (measured) = 0.716 W/kg

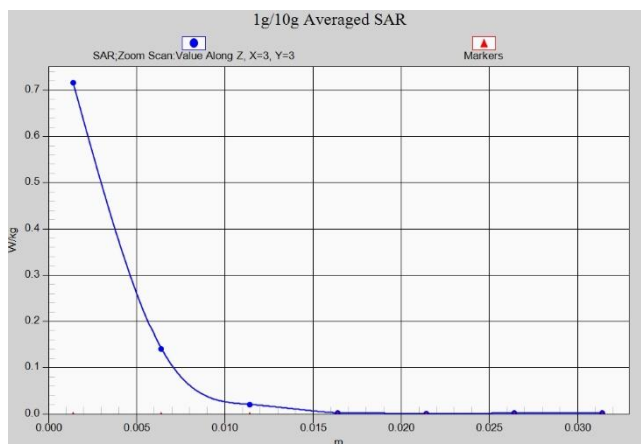
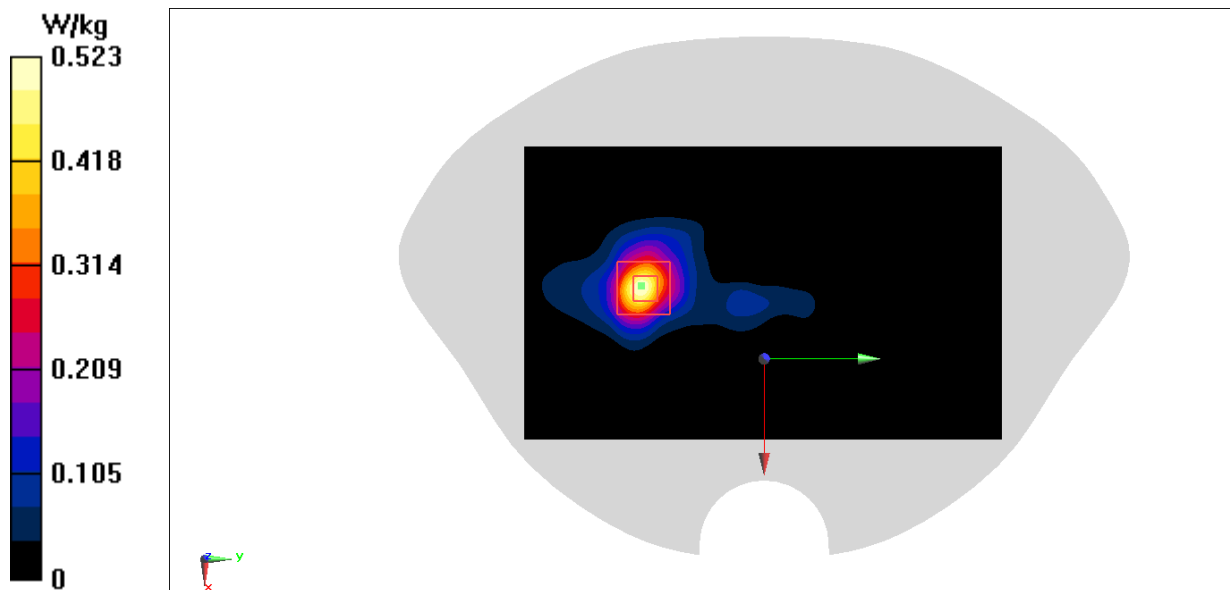

WiFi5G Body ANT5 SAR

Date: 8/26/2022

Electronics: DAE4 Sn777

Medium: H650-7000M

Medium parameters used: $f = 5885$ MHz; $\sigma = 5.429$ S/m; $\epsilon_r = 35.22$; $\rho = 1000$ kg/m³

Ambient Temperature: 23.3oC Liquid Temperature: 22.5oC

Communication System: UID 0, WLAN 11a (0) Frequency: 5885 MHz Duty Cycle: 1:1

Probe: EX3DV4 - SN7464 ConvF(5, 5, 5)

Area Scan (101x161x1): Interpolated grid: dx=1.000 mm, dy=1.000 mm

Maximum value of SAR (interpolated) = 0.562 W/kg

Zoom Scan (6x6x7)/Cube 0: Measurement grid: dx=4mm, dy=4mm, dz=5mm

Reference Value = 1.258 V/m; Power Drift = 0.08 dB

Peak SAR (extrapolated) = 0.686 W/kg

SAR(1 g) = 0.192 W/kg; SAR(10 g) = 0.075 W/kg

Maximum value of SAR (measured) = 0.441 W/kg

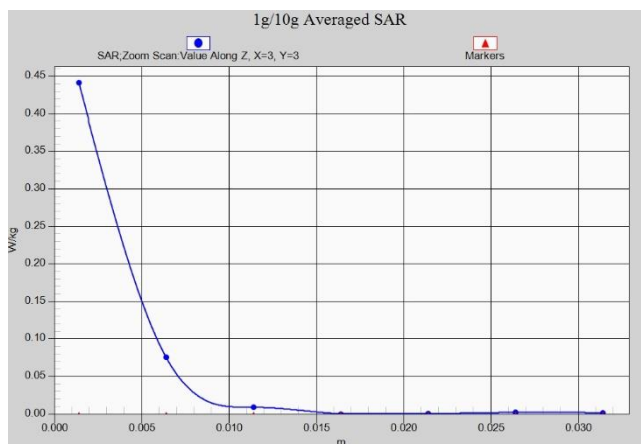
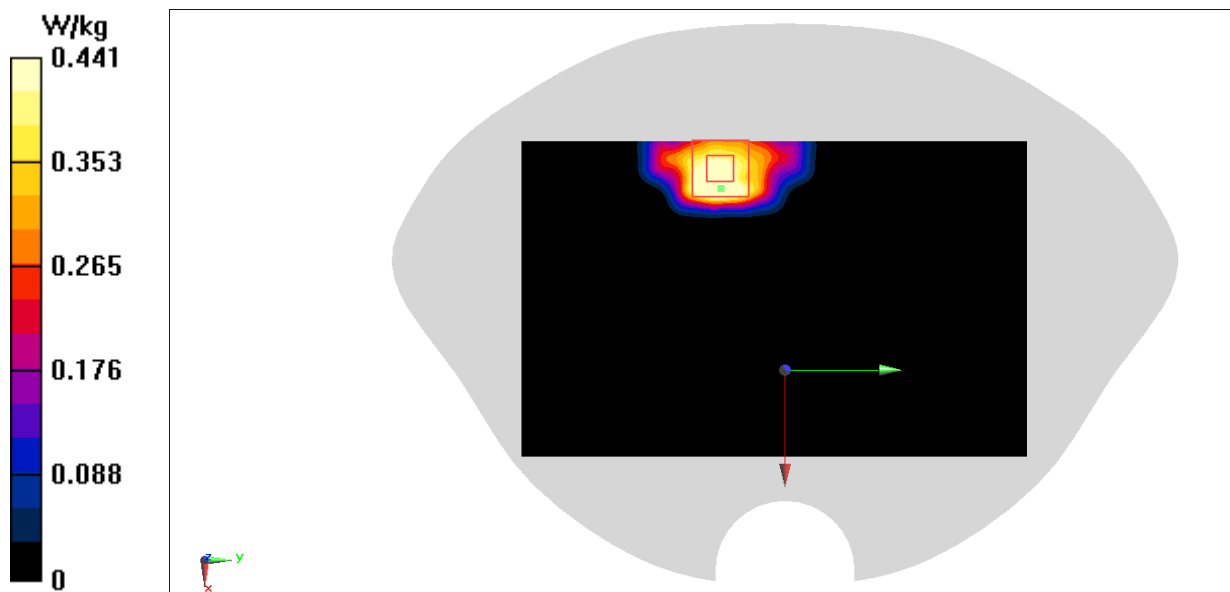

WiFi6G Body ANT4 PD

Measurement Report for Device, EDGE RIGHT, Custom Band, IEEE 802.11a WiFi 5 GHz (OFDM, 6 Mbps, 96pc duty cycle), Channel 6115000 (6115.0 MHz)

Device Under Test Properties

Model, Manufacturer	Dimensions [mm]	IMEI	DUT Type
Device,	160.0 x 90.0 x 15.0		Phone

Exposure Conditions

Phantom Section	Position, Test Distance [mm]	Band	Group, UID	Frequency [MHz], Channel Number	Conversion Factor
5G	EDGE RIGHT, 2.00	Custom Band	CW, 10317-AAD	6115.0, 6115000	1.0

Hardware Setup

Phantom	Medium	Probe, Calibration Date	DAE, Calibration Date
mmWave - xxxx	Air -	EUmmWV4 - SN9448_F1-55GHz, 2022-01-26	DAE4 Sn777, 2022-01-07

Scans Setup

Scan Type	5G Scan
Grid Extents [mm]	25.0 x 25.0
Grid Steps [lambda]	0.25 x 0.25
Sensor Surface [mm]	2.0
MAIA	N/A

Measurement Results

Scan Type	5G Scan
Date	2022-06-30, 11:38
Avg. Area [cm ²]	4.00
psPDn+ [W/m ²]	0.176
psPDtot+ [W/m ²]	0.323
psPDmod+ [W/m ²]	0.381
E _{max} [V/m]	15.2
Power Drift [dB]	-0.13

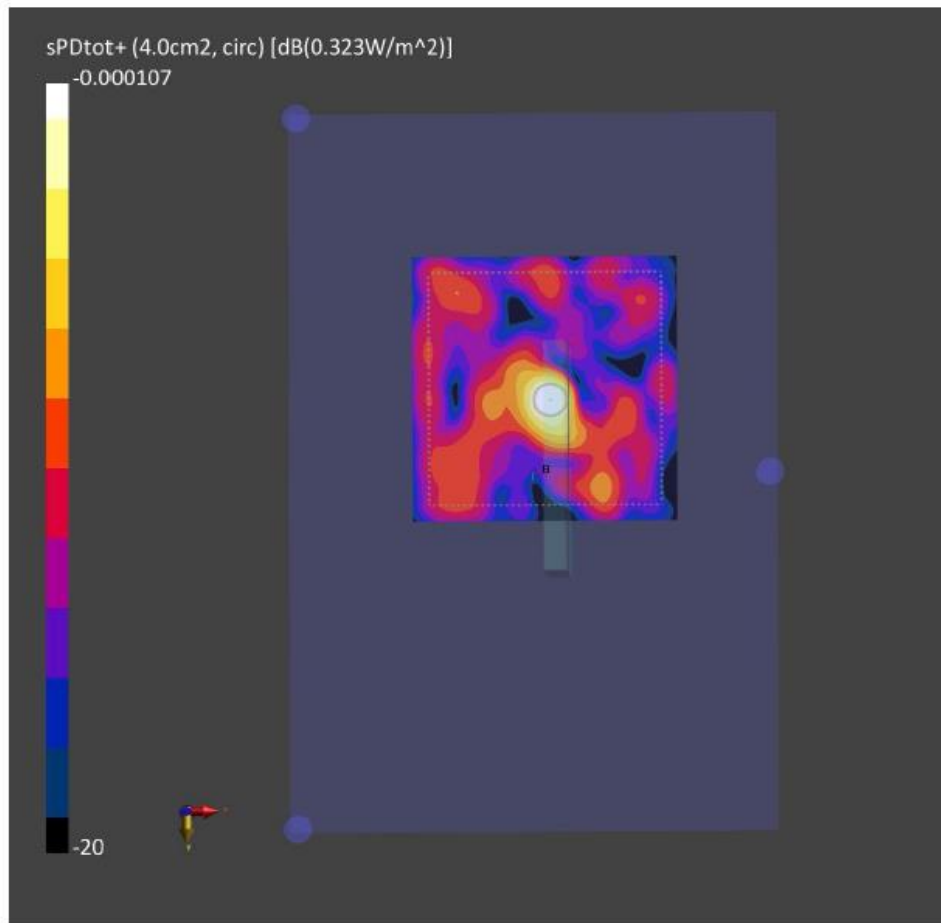

WiFi6G Body ANT5 PD

Measurement Report for Device, BACK, Custom Band, IEEE 802.11a WiFi 5 GHz (OFDM, 6 Mbps, 96pc duty cycle), Channel 7095000 (7095.0 MHz)

Device Under Test Properties

Model, Manufacturer	Dimensions [mm]	IMEI	DUT Type
Device,	160.0 x 90.0 x 15.0		Phone

Exposure Conditions

Phantom Section	Position, Test Distance [mm]	Band	Group, UID	Frequency [MHz], Channel Number	Conversion Factor
5G	BACK, 2.00	Custom Band	CW, 10317-AAD	7095.0, 7095000	1.0

Hardware Setup

Phantom	Medium	Probe, Calibration Date	DAE, Calibration Date
mmWave - xxxx	Air -	EUmmWV4 - SN9448_F1-55GHz, 2022-01-26	DAE4 Sn777, 2022-01-07

Scans Setup

Scan Type	5G Scan
Grid Extents [mm]	25.0 x 25.0
Grid Steps [lambda]	0.25 x 0.25
Sensor Surface [mm]	2.0
MAIA	N/A

Measurement Results

Scan Type	5G Scan
Date	2022-06-30, 18:17
Avg. Area [cm ²]	4.00
psPDn+ [W/m ²]	3.02
psPDtot+ [W/m ²]	3.24
psPDmod+ [W/m ²]	3.53
E _{max} [V/m]	67.0
Power Drift [dB]	-0.14

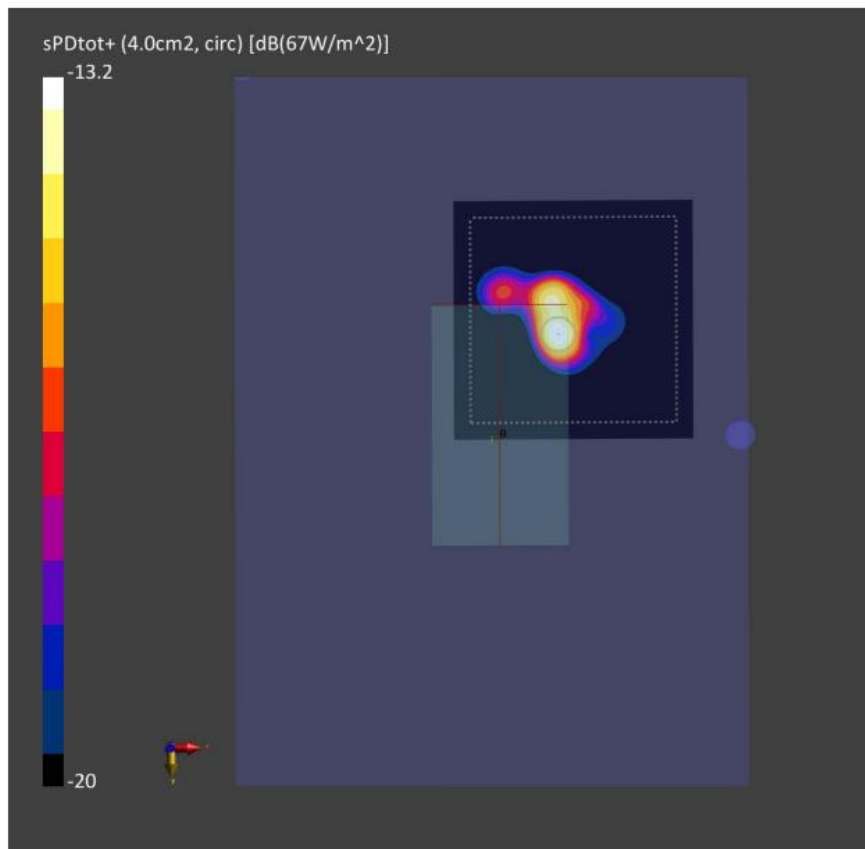

BT Body ANT5 SAR

Date: 8/9/2022

Electronics: DAE4 Sn777

Medium: H2450

Medium parameters used: $f = 2441$ MHz; $\sigma = 1.821$ S/m; $\epsilon_r = 40.51$; $\rho = 1000$ kg/m³

Ambient Temperature: 23.3°C Liquid Temperature: 22.5°C

Communication System: BT 2441 MHz Duty Cycle: 1:1

Probe: EX3DV4 - SN7600 ConvF(7.82, 7.82, 7.82)

Area Scan (91x141x1): Interpolated grid: dx=1.500 mm, dy=1.500 mm

Maximum value of SAR (interpolated) = 0.106 W/kg

Zoom Scan (6x6x7)/Cube 0: Measurement grid: dx=8mm, dy=8mm, dz=5mm

Reference Value = 1.248 V/m; Power Drift = 0.17 dB

Peak SAR (extrapolated) = 0.118 W/kg

SAR(1 g) = 0.050 W/kg; SAR(10 g) = 0.018 W/kg

Maximum value of SAR (measured) = 0.0866 W/kg

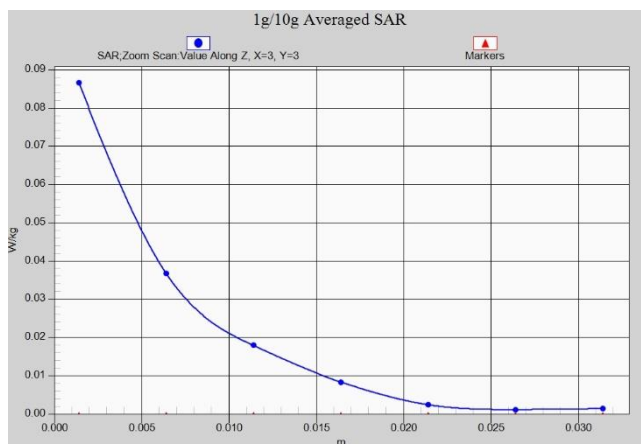
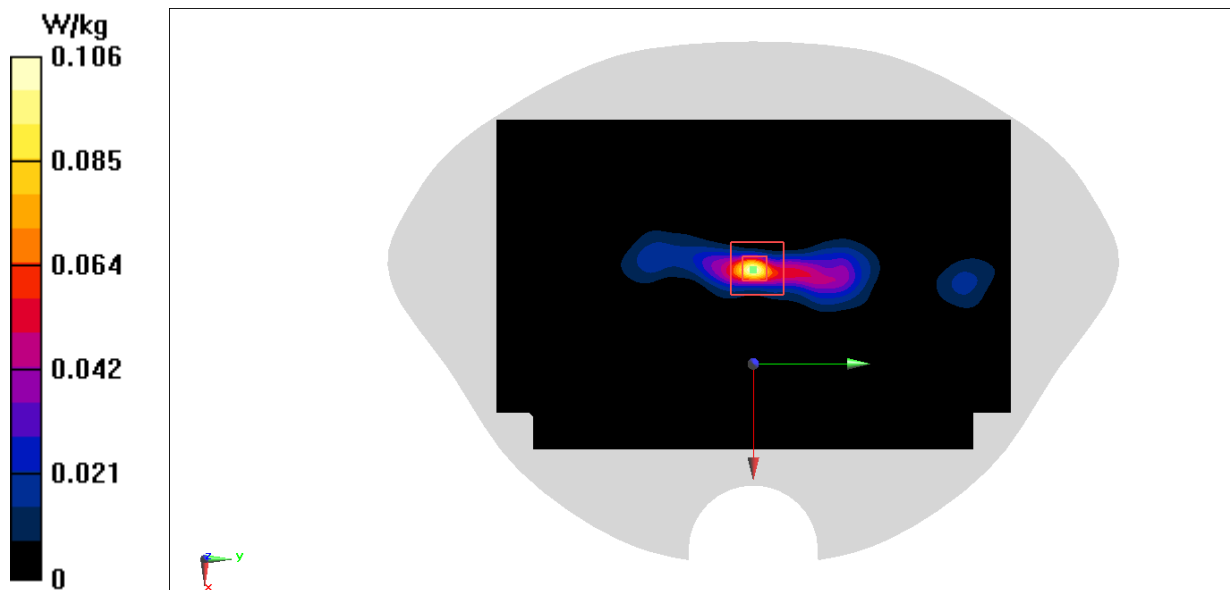

N2 body

Date: 6/11/2022

Electronics: DAE4 Sn777

Medium: H1900

Medium parameters used: $f = 1880 \text{ MHz}$; $\sigma = 1.407 \text{ S/m}$; $\epsilon_r = 41.3$; $\rho = 1000 \text{ kg/m}^3$

Ambient Temperature: 23.30C Liquid Temperature: 22.50C

Communication System: Frequency: 1880 MHz Duty Cycle: 1:1

Probe: EX3DV4 - SN7600 ConvF(8.54, 8.54, 8.54)

Area Scan (81x141x1): Interpolated grid: $dx=1.500 \text{ mm}$, $dy=1.500 \text{ mm}$

Maximum value of SAR (interpolated) = 0.612 W/kg

Zoom Scan (5x5x7)/Cube 0: Measurement grid: $dx=8\text{mm}$, $dy=8\text{mm}$, $dz=5\text{mm}$

Reference Value = 6.037 V/m; Power Drift = 0.13 dB

Peak SAR (extrapolated) = 0.694 W/kg

SAR(1 g) = 0.443 W/kg; SAR(10 g) = 0.282 W/kg

Maximum value of SAR (measured) = 0.606 W/kg

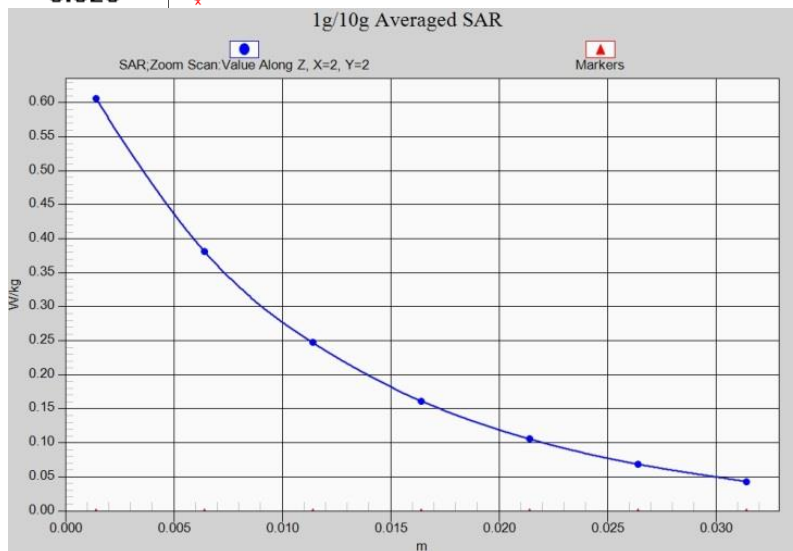
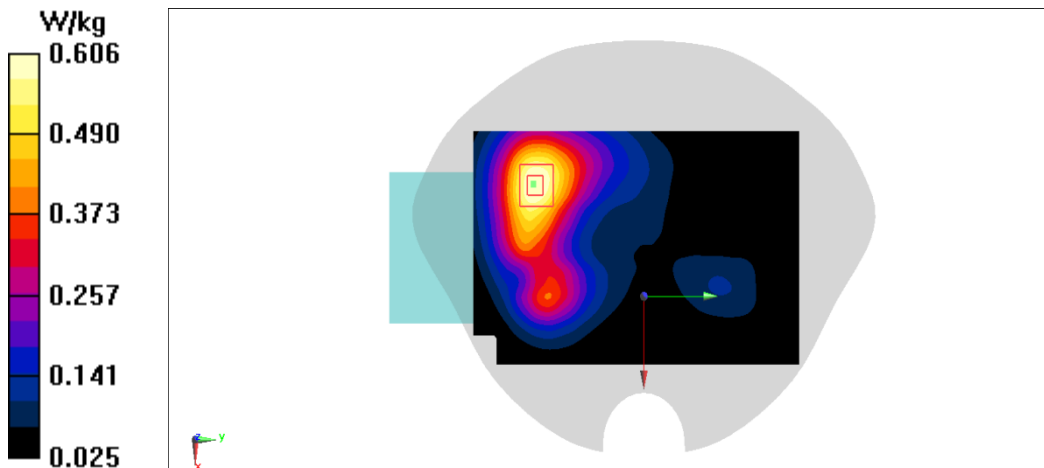

N5 body

Date: 6/10/2022

Electronics: DAE4 Sn777

Medium: H835

Medium parameters used (interpolated): $f = 836.6$ MHz; $\sigma = 0.861$ S/m; $\epsilon_r = 43.49$; $\rho = 1000$ kg/m³

Ambient Temperature: 23.30C Liquid Temperature: 22.50C

Communication System: Frequency: 836.5 MHz Duty Cycle: 1:1

Probe: EX3DV4 - SN7600 ConvF(10.74, 10.74, 10.74)

Area Scan (81x141x1): Interpolated grid: dx=1.500 mm, dy=1.500 mm

Maximum value of SAR (interpolated) = 0.419 W/kg

Zoom Scan (5x5x7)/Cube 0: Measurement grid: dx=8mm, dy=8mm, dz=5mm

Reference Value = 12.07 V/m; Power Drift = 0.06 dB

Peak SAR (extrapolated) = 0.472 W/kg

SAR(1 g) = 0.319 W/kg; SAR(10 g) = 0.215 W/kg

Maximum value of SAR (measured) = 0.416 W/kg

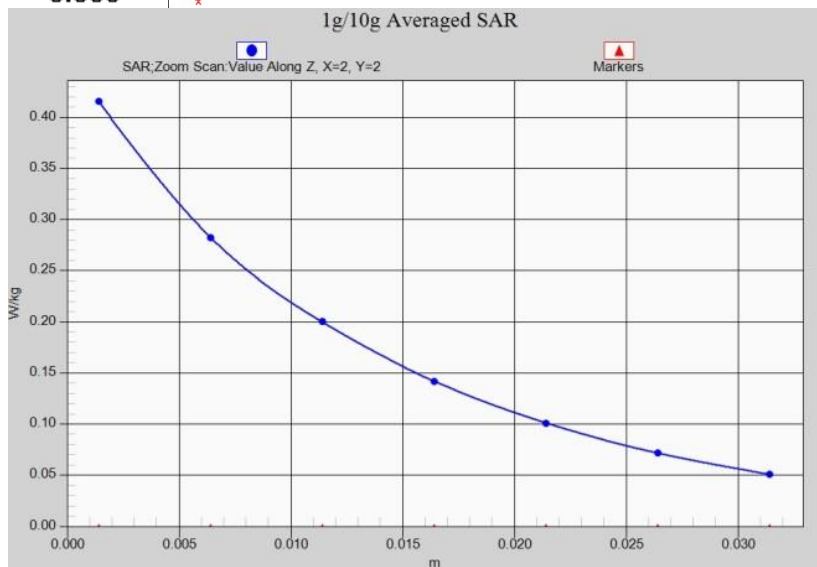
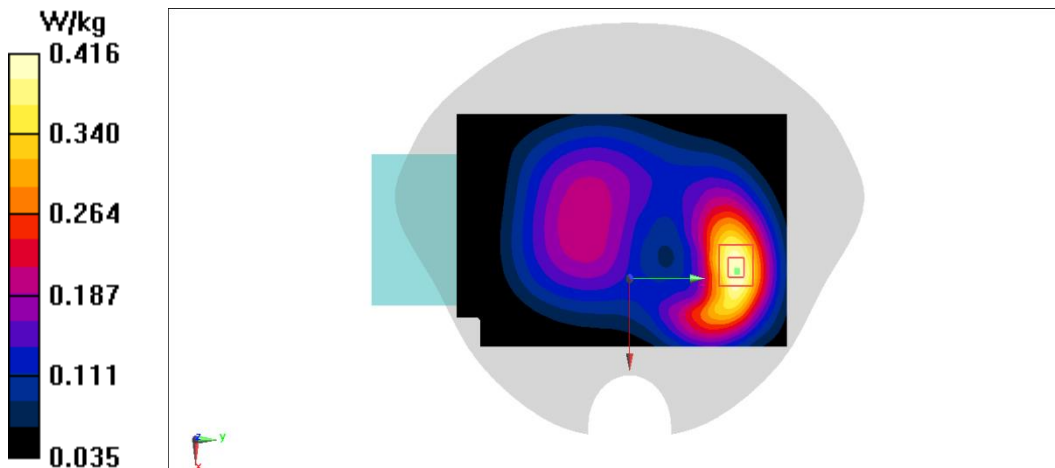

N66 body

Date: 6/9/2022

Electronics: DAE4 Sn777

Medium: H1750

Medium parameters used: $f = 1745 \text{ MHz}$; $\sigma = 1.328 \text{ S/m}$; $\epsilon_r = 41.45$; $\rho = 1000 \text{ kg/m}^3$

Ambient Temperature: 23.3oC Liquid Temperature: 22.5oC

Communication System: Frequency: 1745 MHz Duty Cycle: 1:1

Probe: EX3DV4 - SN7600 ConvF(8.93, 8.93, 8.93)

Area Scan (81x141x1): Interpolated grid: $dx=1.500 \text{ mm}$, $dy=1.500 \text{ mm}$

Maximum value of SAR (interpolated) = 0.515 W/kg

Zoom Scan (5x5x7)/Cube 0: Measurement grid: $dx=8\text{mm}$, $dy=8\text{mm}$, $dz=5\text{mm}$

Reference Value = 8.889 V/m; Power Drift = 0.12 dB

Peak SAR (extrapolated) = 0.582 W/kg

SAR(1 g) = 0.373 W/kg; SAR(10 g) = 0.242 W/kg

Maximum value of SAR (measured) = 0.504 W/kg

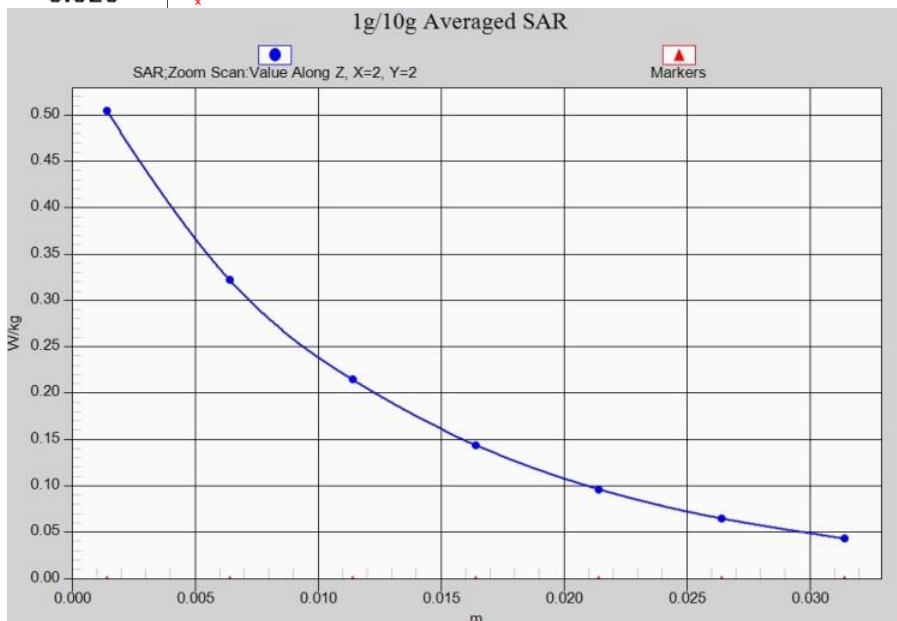
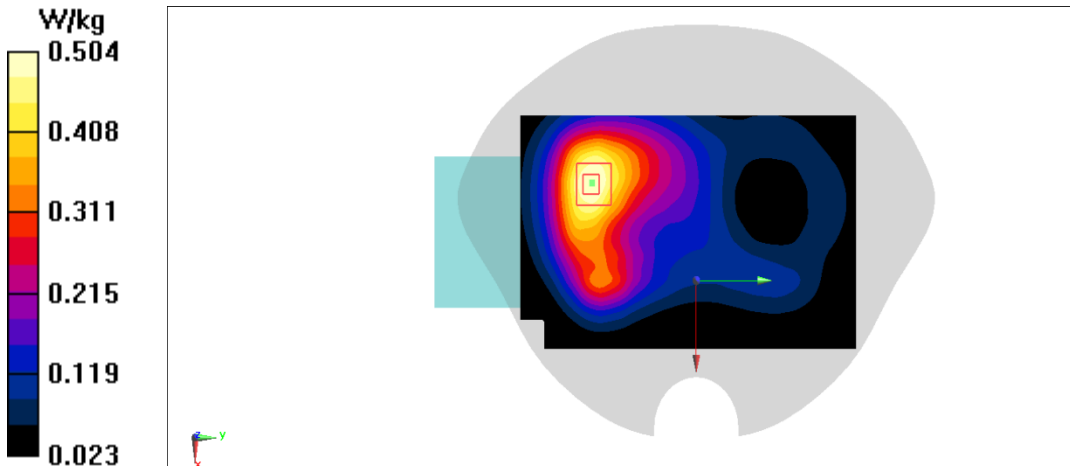

N77-H Body

Date: 6/18/2022

Electronics: DAE4 Sn777

Medium: H3G

Medium parameters used (interpolated): $f = 3710.01$ MHz; $\sigma = 2.968$ S/m; $\epsilon_r = 37.82$; $\rho = 1000$ kg/m³

Ambient Temperature: 23.30C Liquid Temperature: 22.50C

Communication System: Frequency: 3710.01 MHz Duty Cycle: 1:1

Probe: EX3DV4 - SN7600 ConvF(6.78, 6.78, 6.78)

Area Scan (81x141x1): Interpolated grid: dx=1.000 mm, dy=1.000 mm

Maximum value of SAR (interpolated) = 1.21 W/kg

Zoom Scan (5x5x7)/Cube 0: Measurement grid: dx=4mm, dy=4mm, dz=1.4mm

Reference Value = 5.300 V/m; Power Drift = 0.01 dB

Peak SAR (extrapolated) = 1.60 W/kg

SAR(1 g) = 0.682 W/kg; SAR(10 g) = 0.330 W/kg

Maximum value of SAR (measured) = 1.21 W/kg

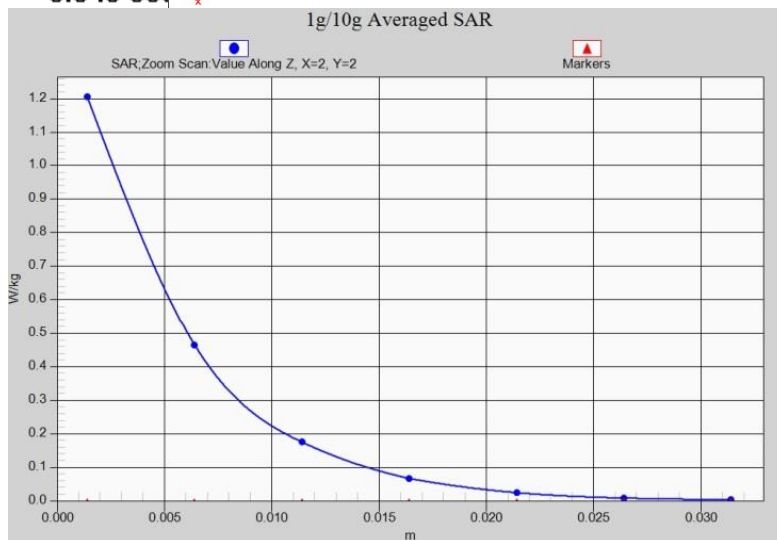
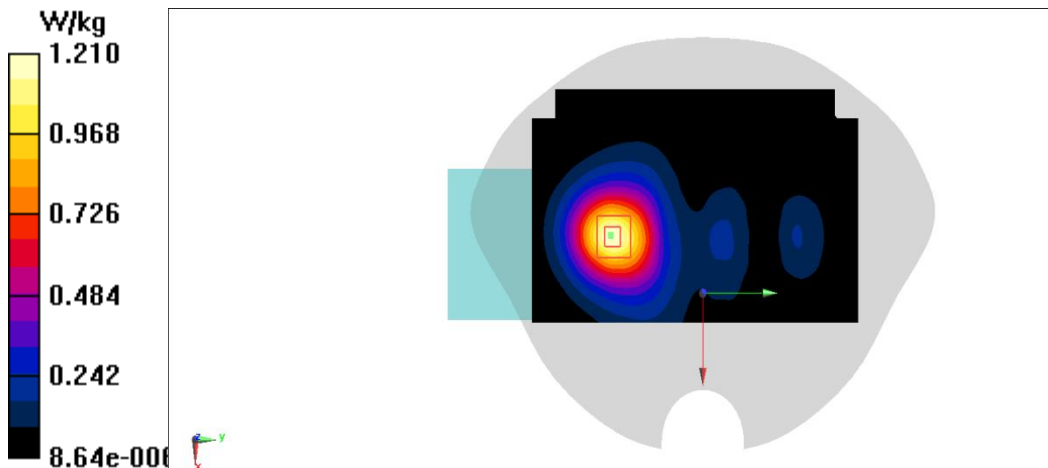

ANNEX B System Verification Results

750 MHz

Date: 6/8/2022

Electronics: DAE4 Sn777

Medium: 750 Head

Medium parameters used: $f = 750 \text{ MHz}$; $\sigma = 0.848 \text{ S/m}$; $\epsilon_r = 43.88$; $\rho = 1000 \text{ kg/m}^3$

Ambient Temperature: 23.3oC Liquid Temperature: 22.5oC

Communication System: CW (0) Frequency: 750 MHz Duty Cycle: 1:1

Probe: EX3DV4 - SN7600 ConvF(10.74, 10.74, 10.74)

Area Scan (131x61x1): Interpolated grid: $dx=1.500 \text{ mm}$, $dy=1.500 \text{ mm}$

Maximum value of SAR (interpolated) = 2.61 W/kg

Zoom Scan (7x7x7) (7x7x7)/Cube 0: Measurement grid: $dx=5\text{mm}$, $dy=5\text{mm}$, $dz=5\text{mm}$

Reference Value = 54.80 V/m; Power Drift = -0.04 dB

Peak SAR (extrapolated) = 2.90 W/kg

SAR(1 g) = 2.02 W/kg; SAR(10 g) = 1.37 W/kg

Maximum value of SAR (measured) = 2.62 W/kg

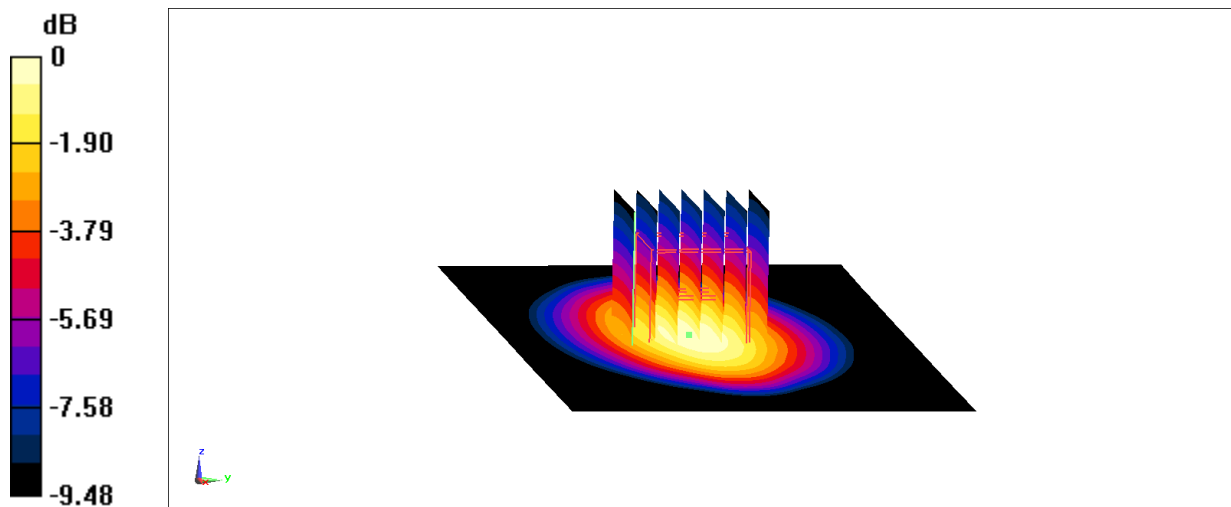

0 dB = 2.62 W/kg = 4.18 dBW/kg

Fig.B.1 validation 750 MHz 250mW

835 MHz

Date: 6/10/2022

Electronics: DAE4 Sn777

Medium: 835 Head

Medium parameters used: $f = 835 \text{ MHz}$; $\sigma = 0.861 \text{ S/m}$; $\epsilon_r = 43.49$; $\rho = 1000 \text{ kg/m}^3$

Ambient Temperature: 23.30C Liquid Temperature: 22.50C

Communication System: CW (0) Frequency: 835 MHz Duty Cycle: 1:1

Probe: EX3DV4 - SN7600 ConvF(10.74, 10.74, 10.74)

Area Scan (131x61x1): Interpolated grid: $dx=1.500 \text{ mm}$, $dy=1.500 \text{ mm}$

Maximum value of SAR (interpolated) = 3.04 W/kg

Zoom Scan (7x7x7) (7x7x7)/Cube 0: Measurement grid: $dx=5\text{mm}$, $dy=5\text{mm}$, $dz=5\text{mm}$

Reference Value = 57.18 V/m; Power Drift = -0.01 dB

Peak SAR (extrapolated) = 3.46 W/kg

SAR(1 g) = 2.31 W/kg; SAR(10 g) = 1.53 W/kg

Maximum value of SAR (measured) = 3.06 W/kg

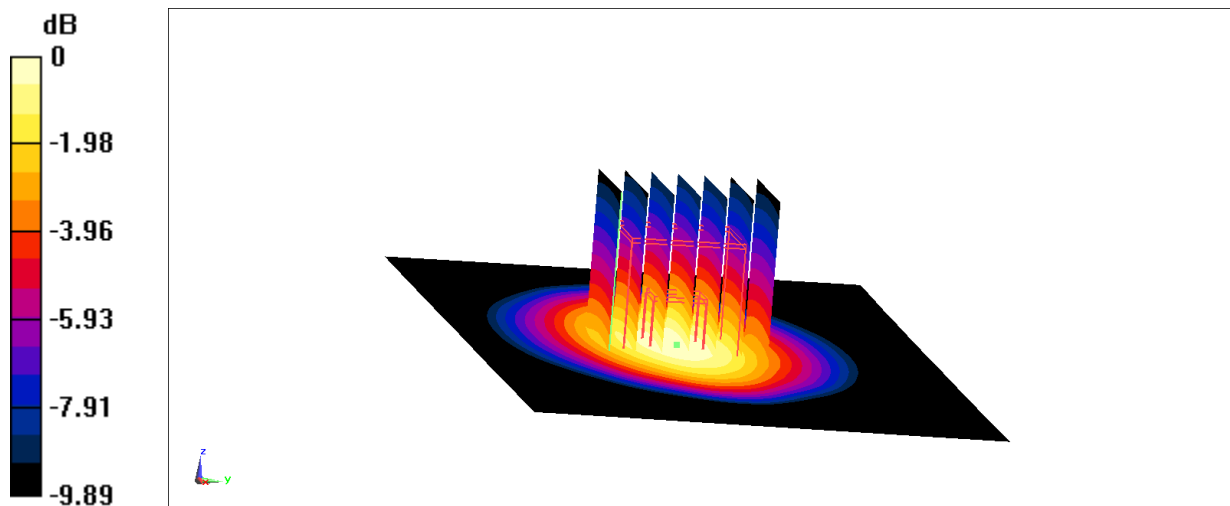

$$0 \text{ dB} = 3.06 \text{ W/kg} = 4.86 \text{ dBW/kg}$$

Fig.B.2 validation 835 MHz 250mW

1750 MHz

Date: 6/9/2022

Electronics: DAE4 Sn777

Medium: HSL1750

Medium parameters used: $f = 1750$ MHz; $\sigma = 1.331$ S/m; $\epsilon_r = 41.45$; $\rho = 1000$ kg/m³

Ambient Temperature: 23.30C Liquid Temperature: 22.50C

Communication System: CW (0) Frequency: 1750 MHz Duty Cycle: 1:1

Probe: EX3DV4 - SN7600 ConvF(8.93, 8.93, 8.93)

Area Scan (61x61x1): Interpolated grid: dx=1.500 mm, dy=1.500 mm

Maximum value of SAR (interpolated) = 14.6 W/kg

Zoom Scan (7x7x7) (7x7x7)/Cube 0: Measurement grid: dx=5mm, dy=5mm, dz=5mm

Reference Value = 93.87 V/m; Power Drift = 0.00 dB

Peak SAR (extrapolated) = 17.3 W/kg

SAR(1 g) = 9.2 W/kg; SAR(10 g) = 4.87 W/kg

Maximum value of SAR (measured) = 14.4 W/kg

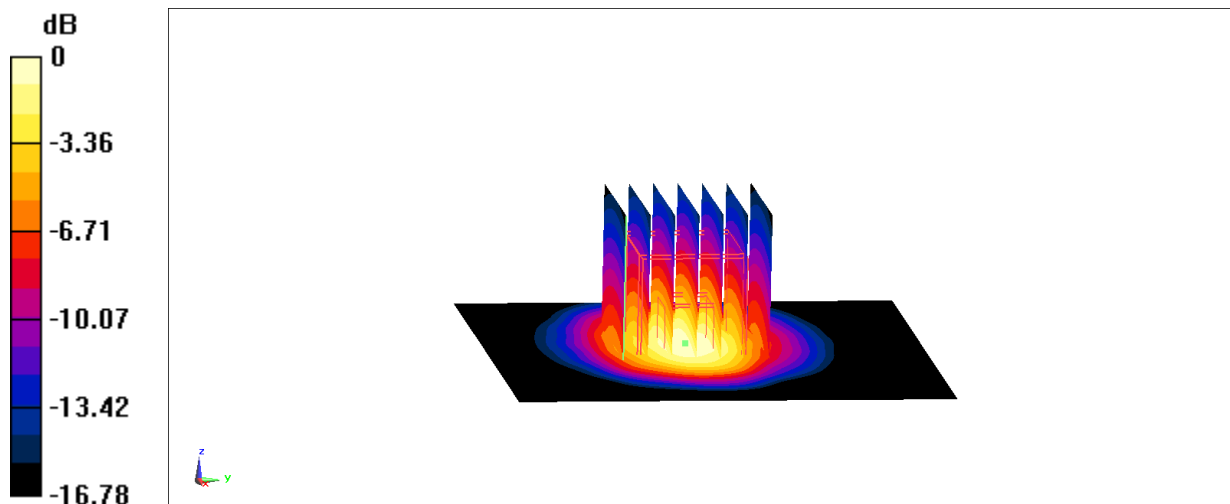

$$0 \text{ dB} = 14.4 \text{ W/kg} = 11.58 \text{ dBW/kg}$$

Fig.B.3 validation 1750 MHz 250mW

1900 MHz

Date: 6/11/2022

Electronics: DAE4 Sn777

Medium: HSL1900

Medium parameters used: $f = 1900$ MHz; $\sigma = 1.421$ S/m; $\epsilon_r = 41.27$; $\rho = 1000$ kg/m³

Ambient Temperature: 23.30C Liquid Temperature: 22.50C

Communication System: CW (0) Frequency: 1900 MHz Duty Cycle: 1:1

Probe: EX3DV4 - SN7600 ConvF(8.54, 8.54, 8.54)

Area Scan (61x61x1): Interpolated grid: $dx=1.500$ mm, $dy=1.500$ mm

Maximum value of SAR (interpolated) = 15.9 W/kg

Zoom Scan (7x7x7) (7x7x7)/Cube 0: Measurement grid: $dx=5$ mm, $dy=5$ mm, $dz=5$ mm

Reference Value = 96.22 V/m; Power Drift = -0.03 dB

Peak SAR (extrapolated) = 19.3 W/kg

SAR(1 g) = 10 W/kg; SAR(10 g) = 5.17 W/kg

Maximum value of SAR (measured) = 15.9 W/kg

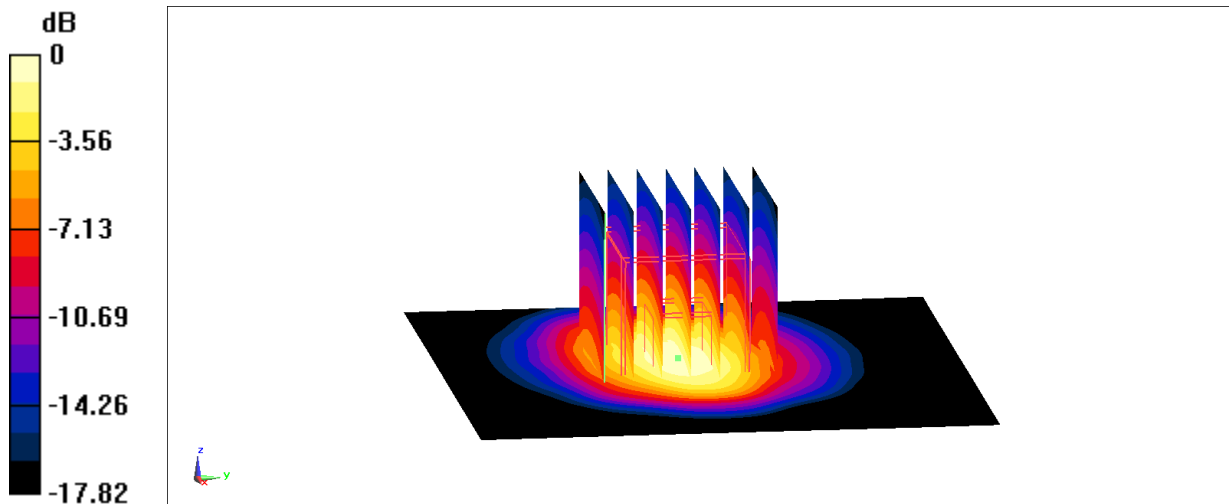

$$0 \text{ dB} = 15.9 \text{ W/kg} = 12.01 \text{ dBW/kg}$$

Fig.B.4 validation 1900 MHz 250mW

2450 MHz

Date: 8/9/2022

Electronics: DAE4 Sn777

Medium: 2450 Head

Medium parameters used: $f = 2450$ MHz; $\sigma = 1.83$ S/m; $\epsilon_r = 40.49$; $\rho = 1000$ kg/m³

Ambient Temperature: 23.30C Liquid Temperature: 22.50C

Communication System: CW (0) Frequency: 2450 MHz Duty Cycle: 1:1

Probe: EX3DV4 - SN7600 ConvF(7.82, 7.82, 7.82)

Area Scan (61x61x1): Interpolated grid: dx=1.200 mm, dy=1.200 mm

Maximum value of SAR (interpolated) = 22.5 W/kg

Zoom Scan (7x7x7) (7x7x7)/Cube 0: Measurement grid: dx=5mm, dy=5mm, dz=5mm

Reference Value = 100.8 V/m; Power Drift = 0.02 dB

Peak SAR (extrapolated) = 28.1 W/kg

SAR(1 g) = 13.2 W/kg; SAR(10 g) = 6.08 W/kg

Maximum value of SAR (measured) = 22.4 W/kg

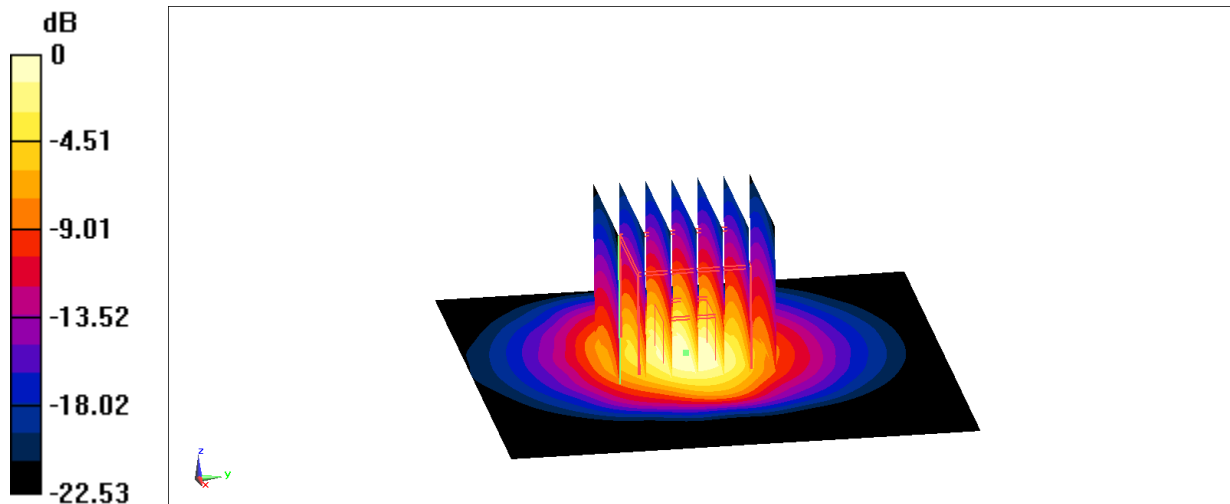

$$0 \text{ dB} = 22.4 \text{ W/kg} = 13.50 \text{ dBW/kg}$$

Fig.B.5 validation 2450 MHz 250mW

3500 MHz

Date: 6/17/2022

Electronics: DAE4 Sn777

Medium: HSL3500

Medium parameters used: $f = 3500$ MHz; $\sigma = 2.774$ S/m; $\epsilon_r = 38.23$; $\rho = 1000$ kg/m³

Ambient Temperature: 23.3oC Liquid Temperature: 22.5oC

Communication System: CW (0) Frequency: 3500 MHz Duty Cycle: 1:1

Probe: EX3DV4 – SN7600 ConvF(7.05, 7.05, 7.05)

Area Scan (91x91x1): Interpolated grid: dx=1.000 mm, dy=1.000 mm

Maximum value of SAR (interpolated) = 12.8 W/kg

Zoom Scan (4x4x1.4mm, graded), dist=1.4mm (8x8x7)/Cube 0: Measurement grid: dx=4mm, dy=4mm, dz=1.4mm

Reference Value = 70.19 V/m; Power Drift = 0.00 dB

Peak SAR (extrapolated) = 16.5 W/kg

SAR(1 g) = 6.68 W/kg; SAR(10 g) = 2.54 W/kg

Maximum value of SAR (measured) = 12.3 W/kg

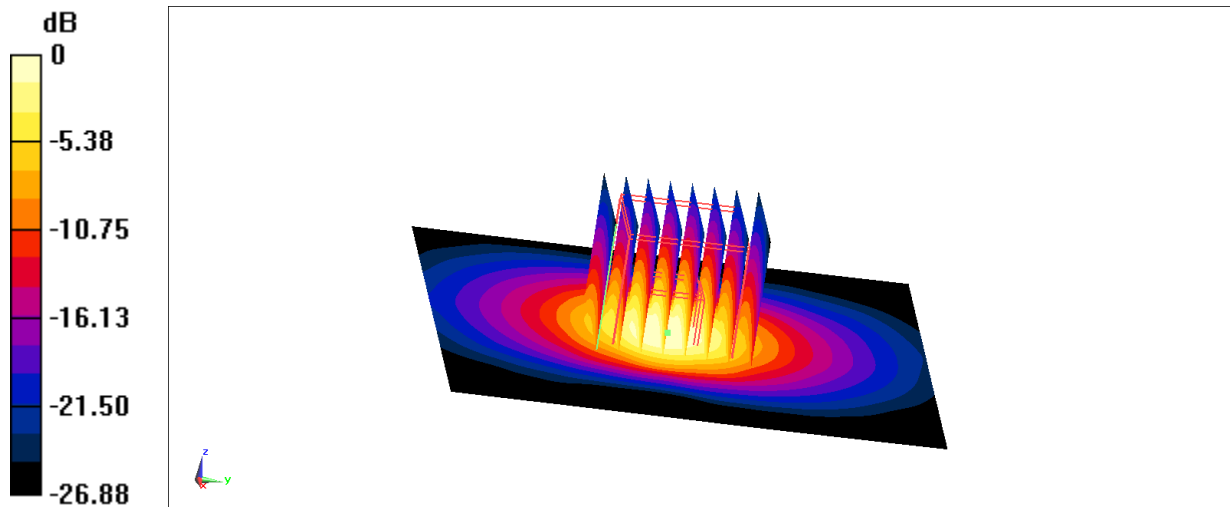

$$0 \text{ dB} = 12.3 \text{ W/kg} = 10.90 \text{ dBW/kg}$$

Fig.B.7 validation 3500 MHz 100mW

3700 MHz

Date: 6/18/2022

Electronics: DAE4 Sn777

Medium: HSL3700

Medium parameters used: $f = 3700$ MHz; $\sigma = 2.979$ S/m; $\epsilon_r = 37.82$; $\rho = 1000$ kg/m³

Ambient Temperature: 23.3oC Liquid Temperature: 22.5oC

Communication System: CW (0) Frequency: 3700 MHz Duty Cycle: 1:1

Probe: EX3DV4 – SN7600 ConvF(6.78, 6.78, 6.78)

Area Scan (91x91x1): Interpolated grid: dx=1.000 mm, dy=1.000 mm

Maximum value of SAR (interpolated) = 14.0 W/kg

Zoom Scan (4x4x1.4mm, graded), dist=1.4mm (8x8x7)/Cube 0: Measurement grid: dx=4mm, dy=4mm, dz=1.4mm

Reference Value = 56.90 V/m; Power Drift = 0.07 dB

Peak SAR (extrapolated) = 20.3 W/kg

SAR(1 g) = 6.73 W/kg; SAR(10 g) = 2.46 W/kg

Maximum value of SAR (measured) = 13.2 W/kg

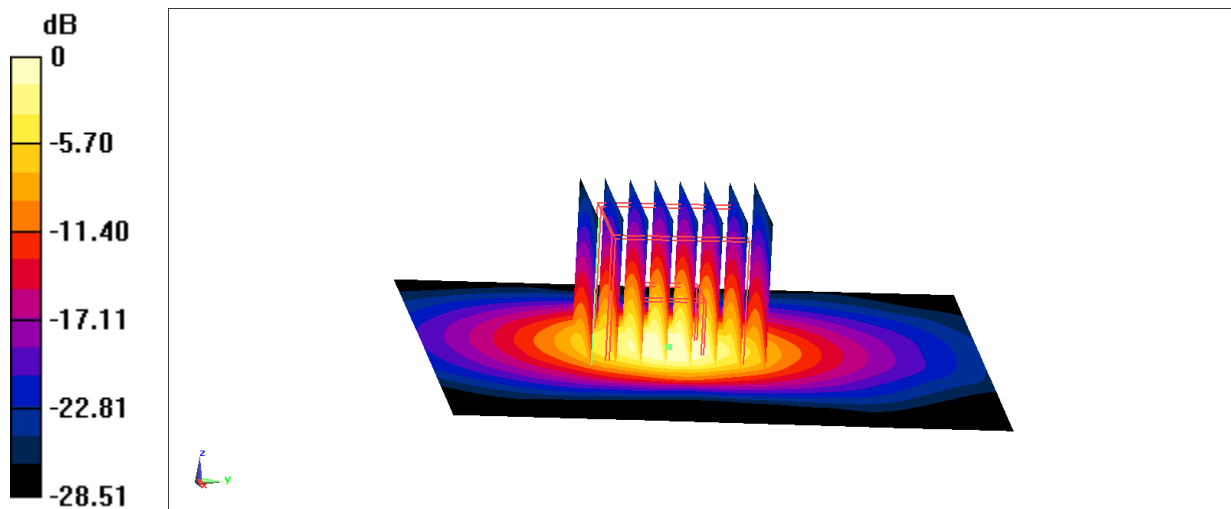

Fig.B.8 validation 3700 MHz 100mW

3900 MHz

Date: 6/19/2022

Electronics: DAE4 Sn777

Medium: HSL3900

Medium parameters used: $f = 3900$ MHz; $\sigma = 3.163$ S/m; $\epsilon_r = 37.46$; $\rho = 1000$ kg/m³

Ambient Temperature: 23.3oC Liquid Temperature: 22.5oC

Communication System: CW (0) Frequency: 3900 MHz Duty Cycle: 1:1

Probe: EX3DV4 – SN7600 ConvF(6.68, 6.68, 6.68)

Area Scan (91x91x1): Interpolated grid: dx=1.000 mm, dy=1.000 mm

Maximum value of SAR (interpolated) = 13.5 W/kg

Zoom Scan (4x4x1.4mm, graded), dist=1.4mm (8x8x8)/Cube 0: Measurement grid: dx=4mm, dy=4mm, dz=1.4mm

Reference Value = 64.02 V/m; Power Drift = -0.07 dB

Peak SAR (extrapolated) = 17.7 W/kg

SAR(1 g) = 6.85 W/kg; SAR(10 g) = 2.45 W/kg

Maximum value of SAR (measured) = 13.2 W/kg

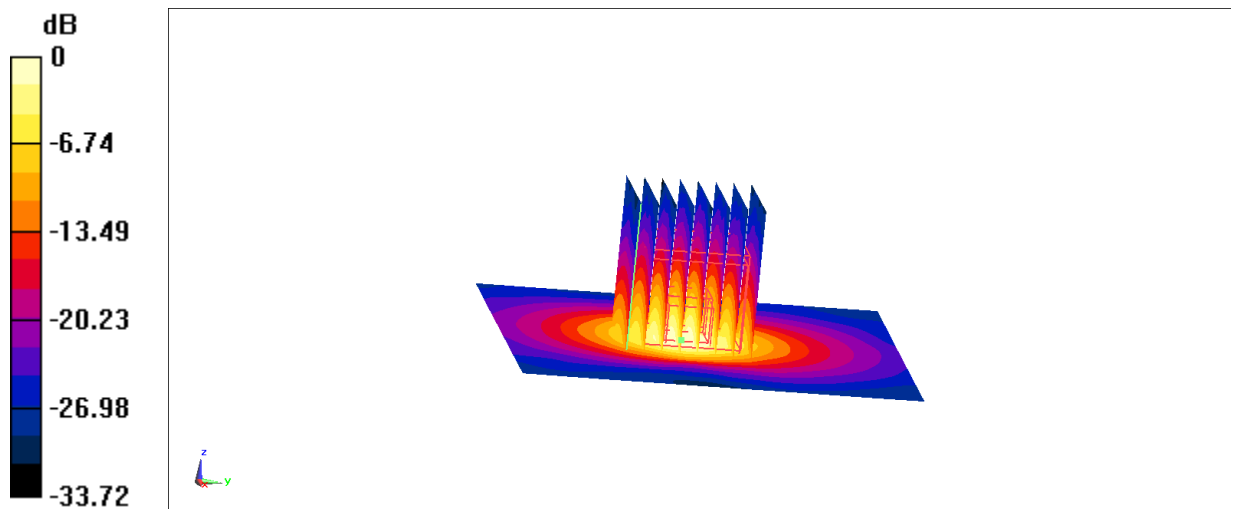

$$0 \text{ dB} = 13.2 \text{ W/kg} = 11.21 \text{ dBW/kg}$$

Fig.B.9 validation 3900 MHz 100mW

5250 MHz

Date: 6/21/2022

Electronics: DAE4 Sn777

Medium: HSL5G

Medium parameters used: $f = 5250$ MHz; $\sigma = 4.582$ S/m; $\epsilon_r = 34.96$; $\rho = 1000$ kg/m³

Ambient Temperature: 23.3oC Liquid Temperature: 22.5oC

Communication System: CW (0) Frequency: 5250 MHz Duty Cycle: 1:1

Probe: EX3DV4 – SN7600 ConvF(5.59, 5.59, 5.59)

Area Scan (91x91x1): Interpolated grid: dx=1.000 mm, dy=1.000 mm

Maximum value of SAR (interpolated) = 18.8 W/kg

Zoom Scan (4x4x1.4mm, graded), dist=1.4mm (8x8x7)/Cube 0: Measurement grid: dx=4mm, dy=4mm, dz=1.4mm

Reference Value = 65.88 V/m; Power Drift = 0.04 dB

Peak SAR (extrapolated) = 31.8 W/kg

SAR(1 g) = 7.67 W/kg; SAR(10 g) = 2.21 W/kg

Maximum value of SAR (measured) = 17.9 W/kg

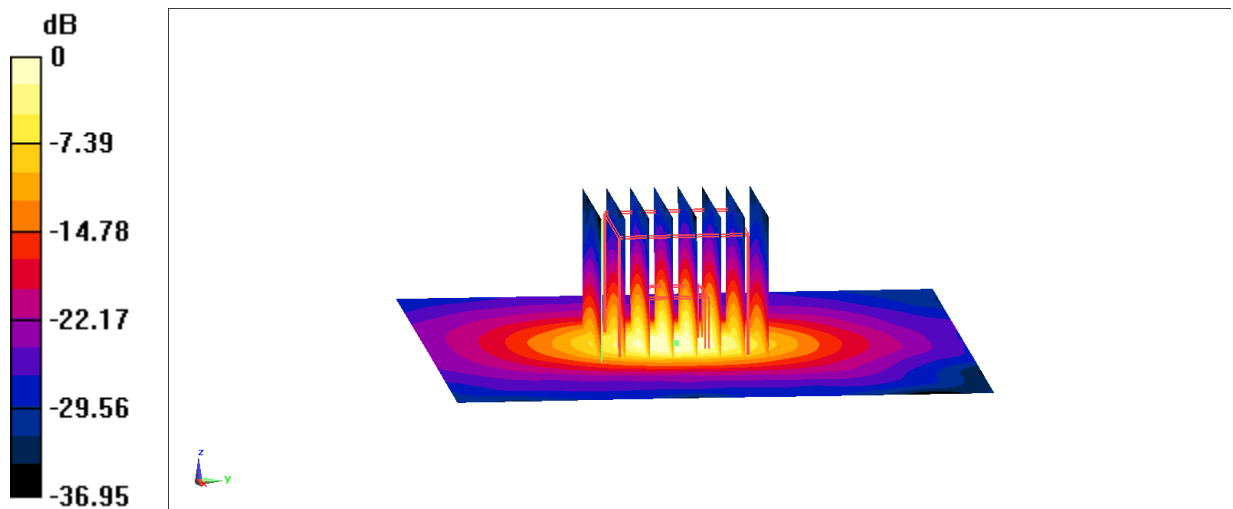

0 dB = 17.9 W/kg = 12.53 dBW/kg

Fig.B.10 validation 5250 MHz 100mW

5600 MHz

Date: 6/22/2022

Electronics: DAE4 Sn777

Medium: HSL5G

Medium parameters used: $f = 5600$ MHz; $\sigma = 4.956$ S/m; $\epsilon_r = 34.32$; $\rho = 1000$ kg/m³

Ambient Temperature: 23.3oC Liquid Temperature: 22.5oC

Communication System: CW (0) Frequency: 5600 MHz Duty Cycle: 1:1

Probe: EX3DV4 – SN7600 ConvF(5.13, 5.13, 5.13)

Area Scan (91x91x1): Interpolated grid: dx=1.000 mm, dy=1.000 mm

Maximum value of SAR (interpolated) = 20.4 W/kg

Zoom Scan (4x4x1.4mm, graded), dist=1.4mm (8x8x7)/Cube 0: Measurement grid: dx=4mm, dy=4mm, dz=1.4mm

Reference Value = 65.83 V/m; Power Drift = 0.00 dB

Peak SAR (extrapolated) = 36.7 W/kg

SAR(1 g) = 8.05 W/kg; SAR(10 g) = 2.32 W/kg

Maximum value of SAR (measured) = 19.9 W/kg

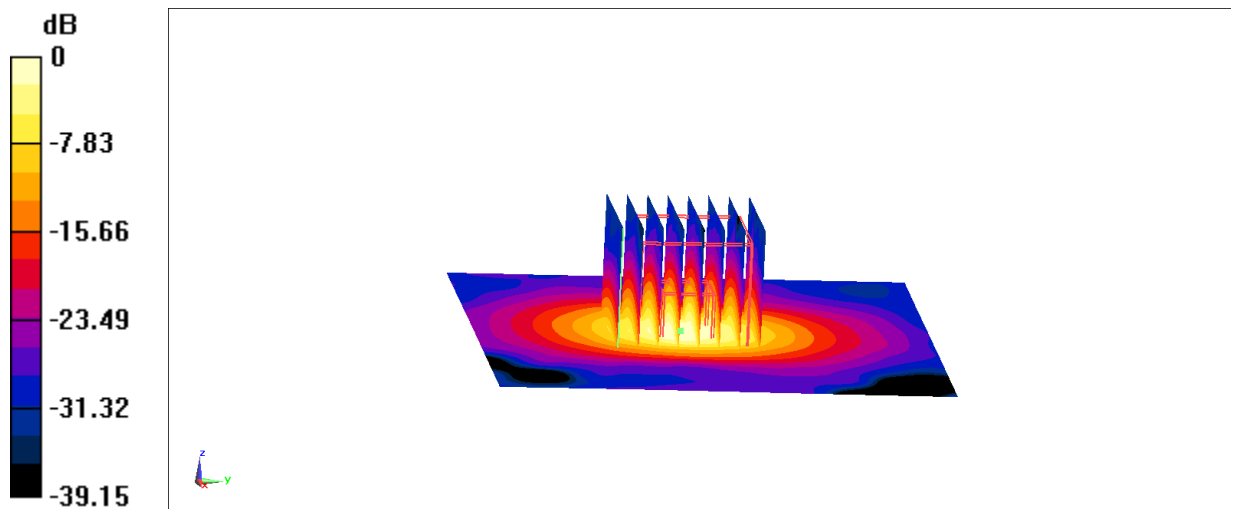

0 dB = 19.9 W/kg = 12.99 dBW/kg

Fig.B.11 validation 5600 MHz 100mW

5750 MHz

Date: 6/23/2022

Electronics: DAE4 Sn777

Medium: HSL5G

Medium parameters used: $f = 5750 \text{ MHz}$; $\sigma = 5.121 \text{ S/m}$; $\epsilon_r = 34.04$; $\rho = 1000 \text{ kg/m}^3$

Ambient Temperature: 23.3oC Liquid Temperature: 22.5oC

Communication System: CW (0) Frequency: 5750 MHz Duty Cycle: 1:1

Probe: EX3DV4 – SN7600 ConvF(5.16, 5.16, 5.16)

Area Scan (91x91x1): Interpolated grid: $dx=1.000 \text{ mm}$, $dy=1.000 \text{ mm}$

Maximum value of SAR (interpolated) = 20.1 W/kg

Zoom Scan (4x4x1.4mm, graded), $dist=1.4\text{mm}$ (8x8x7)/Cube 0: Measurement grid: $dx=4\text{mm}$, $dy=4\text{mm}$, $dz=1.4\text{mm}$

Reference Value = 64.01 V/m; Power Drift = -0.04 dB

Peak SAR (extrapolated) = 36.7 W/kg

SAR(1 g) = 7.83 W/kg; SAR(10 g) = 2.24 W/kg

Maximum value of SAR (measured) = 19.4 W/kg

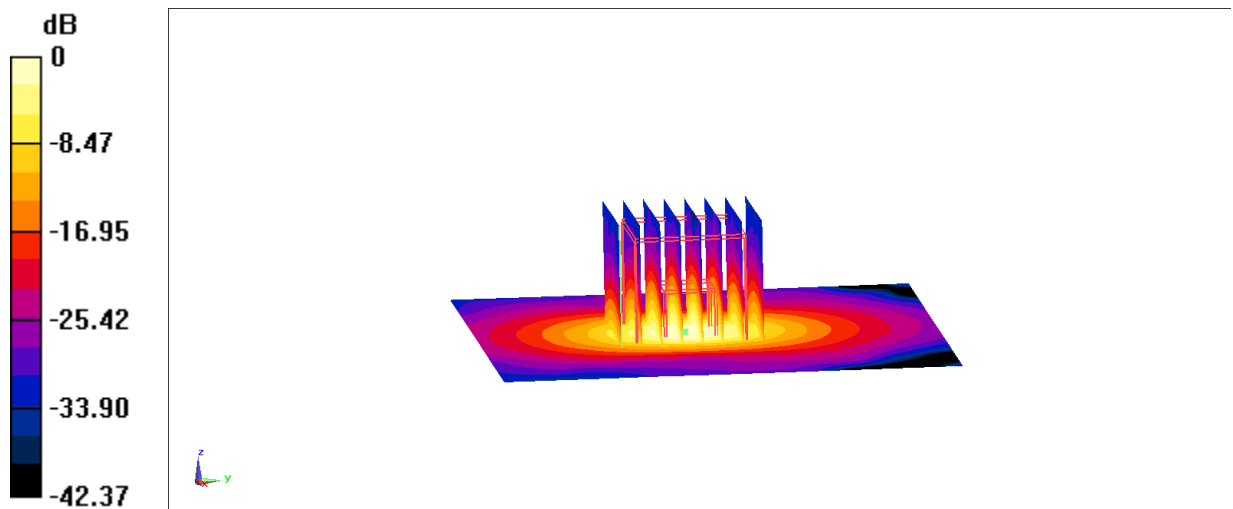

0 dB = 19.4 W/kg = 12.88 dBW/kg

Fig.B.12 validation 5750 MHz 100mW

5800 MHz

Date: 8/26/2022

Electronics: DAE4 Sn777

Medium: H650-7000M

Medium parameters used: $f = 5800$ MHz; $\sigma = 5.286$ S/m; $\epsilon_r = 35.27$; $\rho = 1000$ kg/m³

Ambient Temperature: 23.3oC Liquid Temperature: 22.5oC

Communication System: UID 0, CW (0) Frequency: 5800 MHz Duty Cycle: 1:1

Probe: EX3DV4 - SN7464 ConvF(5, 5, 5)

Area Scan (91x91x1): Interpolated grid: dx=1.000 mm, dy=1.000 mm

Maximum value of SAR (interpolated) = 19.2 W/kg

Zoom Scan (4x4x1.4mm, graded), dist=1.4mm (8x8x8)/Cube 0: Measurement grid: dx=4mm, dy=4mm, dz=1.4mm

Reference Value = 66.34 V/m; Power Drift = 0.04 dB

Peak SAR (extrapolated) = 38.5 W/kg

SAR(1 g) = 7.69 W/kg; SAR(10 g) = 2.13 W/kg

Maximum value of SAR (measured) = 19.5 W/kg

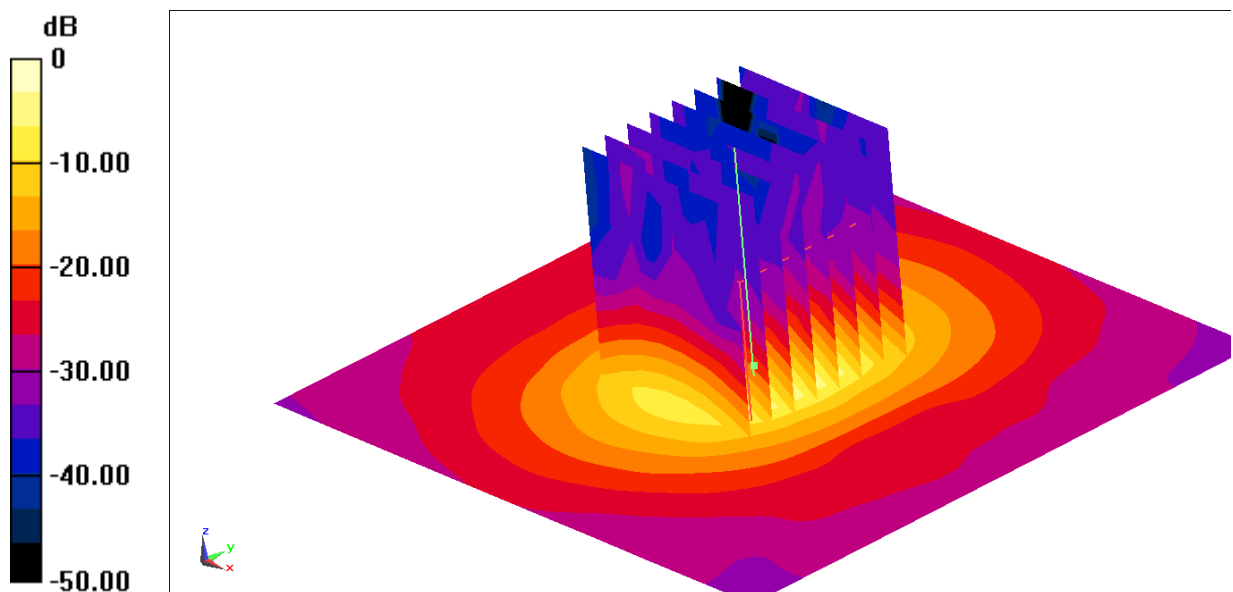

$$0 \text{ dB} = 19.5 \text{ W/kg} = 12.90 \text{ dBW/kg}$$

6500 MHz

Measurement Report for Device, EDGE TOP, Validation band, CW, Channel 6500 (6500.0 MHz)

Device Under Test Properties

Name, Manufacturer	Dimensions [mm]	IMEI	DUT Type
Device,	20.0 x 20.0 x 8.0		Phone

Exposure Conditions

Phantom Section, TSL	Position, Test Distance [mm]	Band	Group, UID	Frequency [MHz], Channel Number	Conversion Factor	TSL Conductivity [S/m]	TSL Permittivity
Flat, -	EDGE TOP, 5.00	Validation band	CW, 0--	6500.0, 6500	5.55	6.22	32.9

Hardware Setup

Phantom	TSL, Measured Date	Probe, Calibration Date	DAE, Calibration Date
Twin-SAM V5.0 (30deg probe tilt) - xxxx	H650-7000M(All1)	EX3DV4 - SN7464, 2022-01-26	DAE4 Sn1331, 2021-09-01

Scans Setup

	Area Scan	Zoom Scan
Grid Extents [mm]	51.0 x 51.0	22.0 x 22.0 x 22.0
Grid Steps [mm]	8.5 x 8.5	3.4 x 3.4 x 1.4
Sensor Surface [mm]	3.0	1.4
Graded Grid	No	Yes
Grading Ratio	n/a	1.4
MAIA	N/A	N/A
Surface Detection	Mother Scan	All points
Scan Method	Measured	Measured

Measurement Results

	Area Scan	Zoom Scan
Date	2022-06-24, 10:02	2022-06-24, 10:19
psSAR1g [W/Kg]	2.37	28.5
psSAR10g [W/Kg]	0.604	5.15
Power Drift [dB]	0.06	0.17
Power Scaling	Disabled	Disabled
Scaling Factor [dB]		
TSL Correction	No correction	No correction

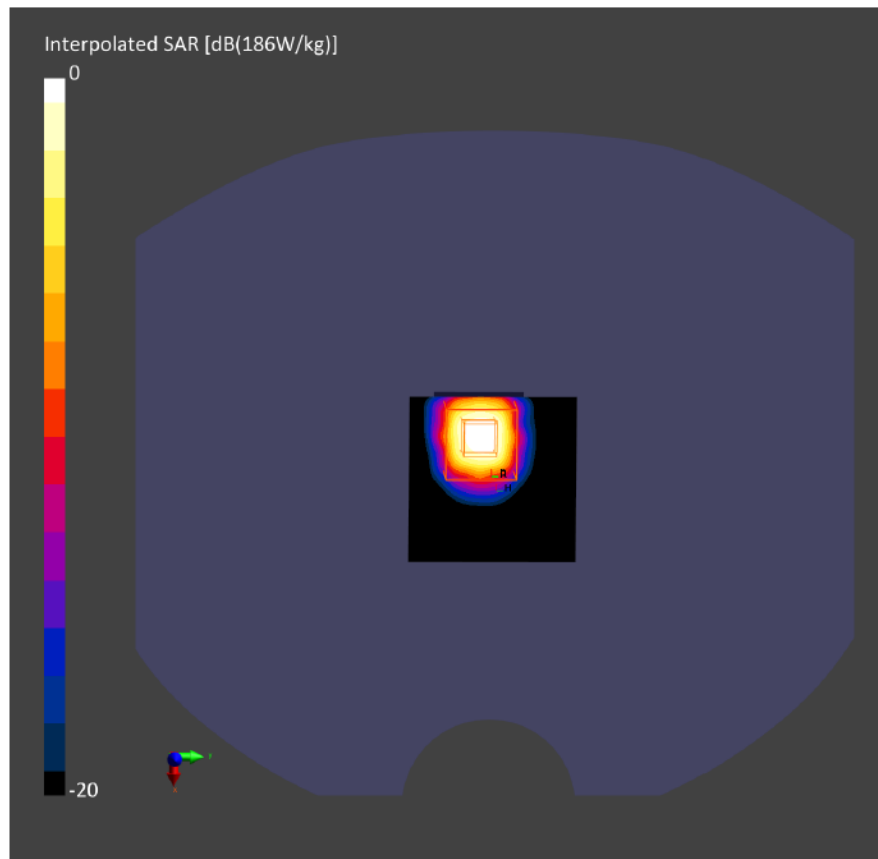

10 GHz

Measurement Report for Device, FRONT, Validation band, CW, Channel 10000 (10000.0 MHz)

Device Under Test Properties

Model, Manufacturer	Dimensions [mm]	IMEI	DUT Type
Device,	100.0 x 100.0 x 100.0		Phone

Exposure Conditions

Phantom Section	Position, Test Distance [mm]	Band	Group, UID	Frequency [MHz], Channel Number	Conversion Factor
5G	FRONT, 2.00	Validation band	CW, 0--	10000.0, 10000	1.0

Hardware Setup

Phantom	Medium	Probe, Calibration Date	DAE, Calibration Date
mmWave - xxxx	Air -	EUmmWV4 - SN9448_F1-55GHz, 2022-01-26	DAE4 Sn777, 2022-01-07

Scans Setup

Scan Type	5G Scan
Grid Extents [mm]	60.0 x 60.0
Grid Steps [lambda]	0.25 x 0.25
Sensor Surface [mm]	2.0
MAIA	N/A

Measurement Results

Scan Type	5G Scan
Date	2022-06-30, 10:18
Avg. Area [cm ²]	4.00
psPDn+ [W/m ²]	49.3
psPDtot+ [W/m ²]	49.4
psPDmod+ [W/m ²]	49.6
E _{max} [V/m]	148
Power Drift [dB]	0.01

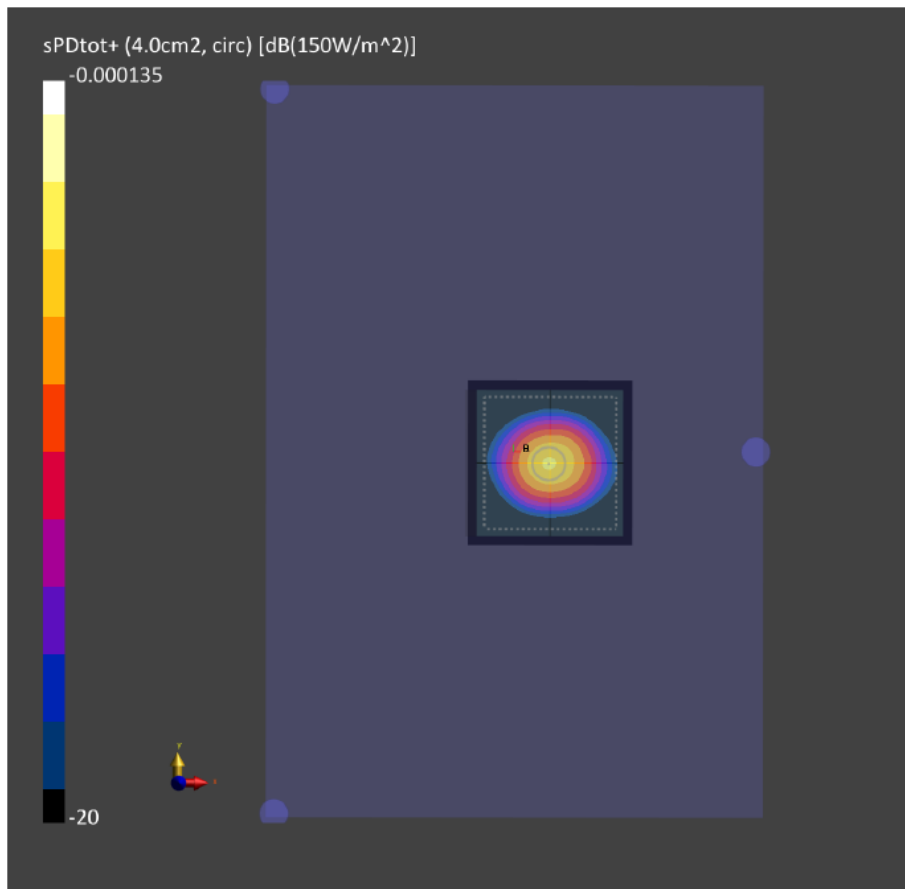

ANNEX C SAR Measurement Setup

C.1 Measurement Set-up

The Dasy5 or DASY6 system for performing compliance tests is illustrated above graphically. This system consists of the following items:

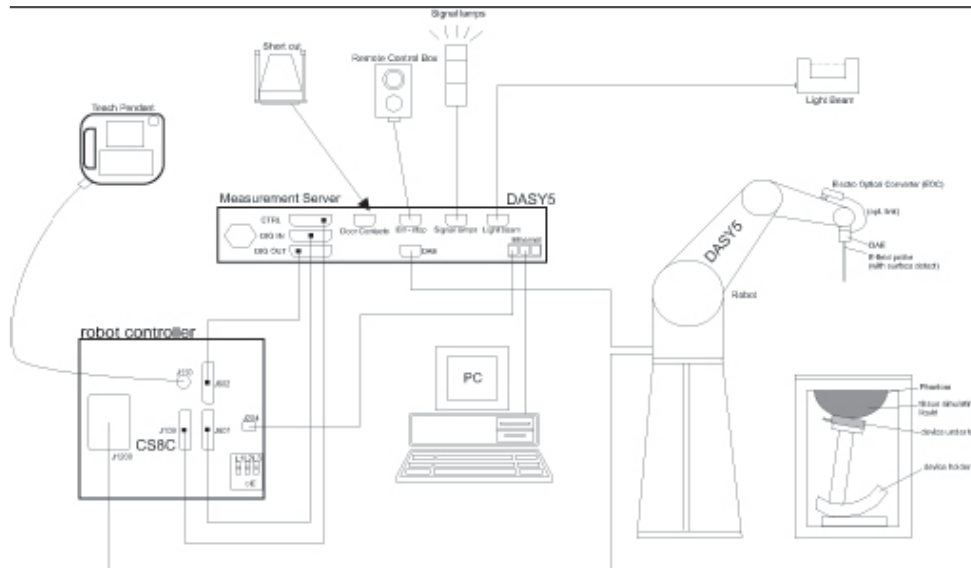

Picture C.1 SAR Lab Test Measurement Set-up

- A standard high precision 6-axis robot (Stäubli TX=RX family) with controller, teach pendant and software. An arm extension for accommodating the data acquisition electronics (DAE).
- An isotropic field probe optimized and calibrated for the targeted measurement.
- A data acquisition electronics (DAE) which performs the signal amplification, signal multiplexing, AD-conversion, offset measurements, mechanical surface detection, collision detection, etc. The unit is battery powered with standard or rechargeable batteries. The signal is optically transmitted to the EOC.
- The Electro-optical converter (EOC) performs the conversion from optical to electrical signals for the digital communication to the DAE. To use optical surface detection, a special version of the EOC is required. The EOC signal is transmitted to the measurement server.
- The function of the measurement server is to perform the time critical tasks such as signal filtering, control of the robot operation and fast movement interrupts.
- The Light Beam used is for probe alignment. This improves the (absolute) accuracy of the probe positioning.
- A computer running WinXP and the DASY5 or DASY6 software.
- Remote control and teach pendant as well as additional circuitry for robot safety such as warning lamps, etc.
- The phantom, the device holder and other accessories according to the targeted measurement.

C.2 Dasy5 E-field Probe System

The SAR measurements were conducted with the dosimetric probe designed in the classical triangular configuration and optimized for dosimetric evaluation. The probe is constructed using the thick film technique; with printed resistive lines on ceramic substrates. The probe is equipped with an optical multifiber line ending at the front of the probe tip. It is connected to the EOC box on the robot arm and provides an automatic detection of the phantom surface. Half of the fibers are connected to a pulsed infrared transmitter, the other half to a synchronized receiver. As the probe approaches the surface, the reflection from the surface produces a coupling from the transmitting to the receiving fibers. This reflection increases first during the approach, reaches maximum and then decreases. If the probe is flatly touching the surface, the coupling is zero. The distance of the coupling maximum to the surface is independent of the surface reflectivity and largely independent of the surface to probe angle. The DASY5 or DASY6 software reads the reflection during a software approach and looks for the maximum using 2nd order curve fitting. The approach is stopped at reaching the maximum.

Probe Specifications:

Model:	ES3DV3, EX3DV4
Frequency	10MHz — 6.0GHz(EX3DV4)
Range:	10MHz — 4GHz(ES3DV3)
Calibration:	In head and body simulating tissue at Frequencies from 835 up to 5800MHz
Linearity:	± 0.2 dB(30 MHz to 6 GHz) for EX3DV4 ± 0.2 dB(30 MHz to 4 GHz) for ES3DV3
DynamicRange:	10 mW/kg — 100W/kg
Probe Length:	330 mm
Probe Tip	
Length:	20 mm
Body Diameter:	12 mm
Tip Diameter:	2.5 mm (3.9 mm for ES3DV3)
Tip-Center:	1 mm (2.0mm for ES3DV3)
Application:	SAR Dosimetry Testing Compliance tests of mobile phones Dosimetry in strong gradient fields



Picture C.2 Near-field Probe



Picture C.3 E-field Probe

C.3 E-field Probe Calibration

Each E-Probe/Probe Amplifier combination has unique calibration parameters. A TEM cell calibration procedure is conducted to determine the proper amplifier settings to enter in the probe parameters. The amplifier settings are determined for a given frequency by subjecting the probe to a known E-field density (1 mW/cm²) using an RF Signal generator, TEM cell, and RF Power Meter.

The free space E-field from amplified probe outputs is determined in a test chamber. This calibration can be performed in a TEM cell if the frequency is below 1 GHz and in a waveguide or

other methodologies above 1 GHz for free space. For the free space calibration, the probe is placed in the volumetric center of the cavity and at the proper orientation with the field. The probe is then rotated 360 degrees until the three channels show the maximum reading. The power density readings equates to 1 mW/cm².

E-field temperature correlation calibration is performed in a flat phantom filled with the appropriate simulated brain tissue. The E-field in the medium correlates with the temperature rise in the dielectric medium. For temperature correlation calibration a RF transparent thermistor-based temperature probe is used in conjunction with the E-field probe.

$$SAR = C \frac{\Delta T}{\Delta t}$$

Where:

Δt = Exposure time (30 seconds),

C = Heat capacity of tissue (brain or muscle),

ΔT = Temperature increase due to RF exposure.

$$SAR = \frac{|E|^2 \cdot \sigma}{\rho}$$

Where:

σ = Simulated tissue conductivity,

ρ = Tissue density (kg/m³).

C.4 Other Test Equipment

C.4.1 Data Acquisition Electronics(DAE)

The data acquisition electronics consist of a highly sensitive electrometer-grade preamplifier with auto-zeroing, a channel and gain-switching multiplexer, a fast 16 bit AD-converter and a command decoder with a control logic unit. Transmission to the measurement server is accomplished through an optical downlink for data and status information, as well as an optical uplink for commands and the clock.

The mechanical probe mounting device includes two different sensor systems for frontal and sideways probe contacts. They are used for mechanical surface detection and probe collision detection.

The input impedance of the DAE is 200 MOhm; the inputs are symmetrical and floating. Common mode rejection is above 80 dB.



PictureC.4: DAE

C.4.2 Robot

The SPEAG DASY system uses the high precision robots (DASY5: RX160L) type from Stäubli SA (France). For the 6-axis controller system, the robot controller version from Stäubli is used. The Stäubli robot series have many features that are important for our application:

- High precision (repeatability 0.02mm)
- High reliability (industrial design)
- Low maintenance costs (virtually maintenance free due to direct drive gears; no belt drives)
- Jerk-free straight movements (brushless synchron motors; no stepper motors)
- Low ELF interference (motor control fields shielded via the closed metallic construction shields)



Picture C.5 DASY 5

C.4.3 Measurement Server

The Measurement server is based on a PC/104 CPU board with CPU (DASY5: 400 MHz, Intel Celeron), chipdisk (DASY5: 128MB), RAM DASY5: 128MB). The necessary circuits for communication with the DAE electronic box, as well as the 16 bit AD converter system for optical detection and digital I/O interface are contained on the DASY I/O board, which is directly connected to the PC/104 bus of the CPU board.

The measurement server performs all real-time data evaluation of field measurements and surface detection, controls robot movements and handles safety operation. The PC operating system cannot interfere with these time critical processes. All connections are supervised by a watchdog, and disconnection of any of the cables to the measurement server will automatically disarm the robot and disable all program-controlled robot movements. Furthermore, the measurement server is equipped with an expansion port which is reserved for future applications. Please note that this expansion port does not have a standardized pinout, and therefore only devices provided by SPEAG can be connected. Devices from any other supplier could seriously damage the measurement server.



Picture C.6 Server for DASY 5

C.4.4 Device Holder for Phantom

The SAR in the phantom is approximately inversely proportional to the square of the distance between the source and the liquid surface. For a source at 5mm distance, a positioning uncertainty of ± 0.5 mm would produce a SAR uncertainty of $\pm 20\%$. Accurate device positioning is therefore crucial for accurate and repeatable measurements. The positions in which the devices must be measured are defined by the standards.

The DASY device holder is designed to cope with the different positions given in the standard. It has two scales for device rotation (with respect to the body axis) and device inclination (with respect to the line between the ear reference points). The rotation centers for both scales are the ear reference point (ERP). Thus the device needs no repositioning when changing the angles. The DASY device holder is constructed of low-loss POM material having the following dielectric parameters: relative permittivity $\epsilon = 3$ and loss tangent $\delta = 0.02$. The amount of dielectric material has been reduced in the closest vicinity of the device, since measurements have suggested that the influence of the clamp on the test results could thus be lowered.

<Laptop Extension Kit>

The extension is lightweight and made of POM, acrylic glass and foam. It fits easily on the upper part of the Mounting Device in place of the phone positioner. The extension is fully compatible with the Twin-SAM and ELI phantoms.



Picture C7-1: Device Holder

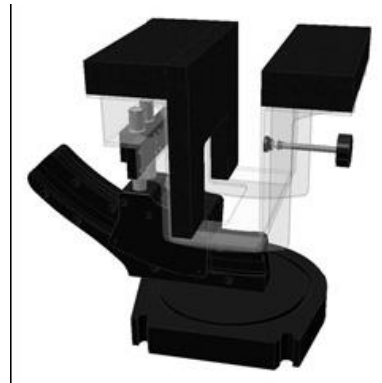

Picture C.7-2: Laptop Extension Kit

C.4.5 Phantom

The SAM Twin Phantom V4.0 is constructed of a fiberglass shell integrated in a table. The shape of the shell is based on data from an anatomical study designed to represent the 90th percentile of the population. The phantom enables the dissymmetric evaluation of SAR for both left and right handed handset usage, as well as body-worn usage using the flat phantom region. Reference markings on the Phantom allow the complete setup of all predefined phantom positions and measurement grids by manually teaching three points in the robot. The shell phantom has a 2mm shell thickness (except the ear region where shell thickness increases to 6 mm).

Shell Thickness: 2 ± 0.2 mm

Filling Volume: Approx. 25 liters

Dimensions: 810 x 1000 x 500 mm (H x L x W)

Available: Special



Picture C.8: SAM Twin Phantom

ANNEX D Position of the wireless device in relation to the phantom

D.1 Body-worn device

A typical example of a body-worn device is a mobile phone, wireless enabled PDA or other battery operated wireless device with the ability to transmit while mounted on a person's body using a carry accessory approved by the wireless device manufacturer.

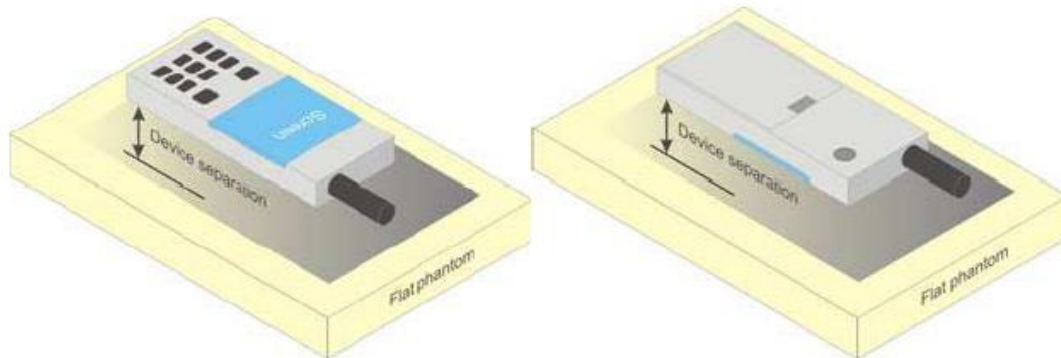

Picture D.1 Test positions for body-worn devices

D.2 Desktop device

A typical example of a desktop device is a wireless enabled desktop computer placed on a table or desk when used.

The DUT shall be positioned at the distance and in the orientation to the phantom that corresponds to the intended use as specified by the manufacturer in the user instructions. For devices that employ an external antenna with variable positions, tests shall be performed for all antenna positions specified. Picture 8.5 show positions for desktop device SAR tests. If the intended use is not specified, the device shall be tested directly against the flat phantom.

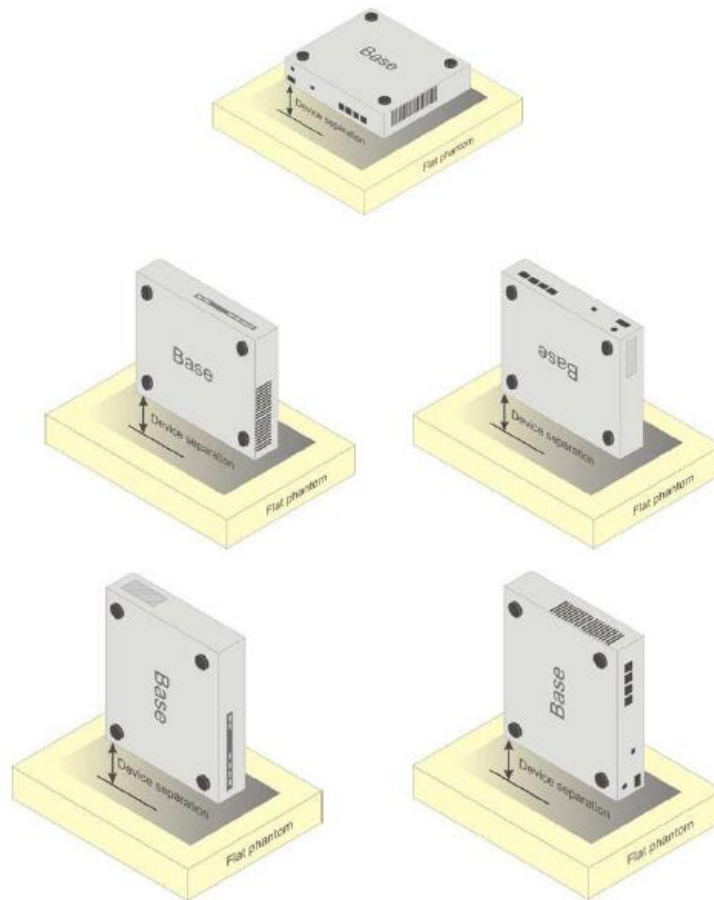

Picture D.2 Test positions for desktop devices

D.3 DUT Setup Photos

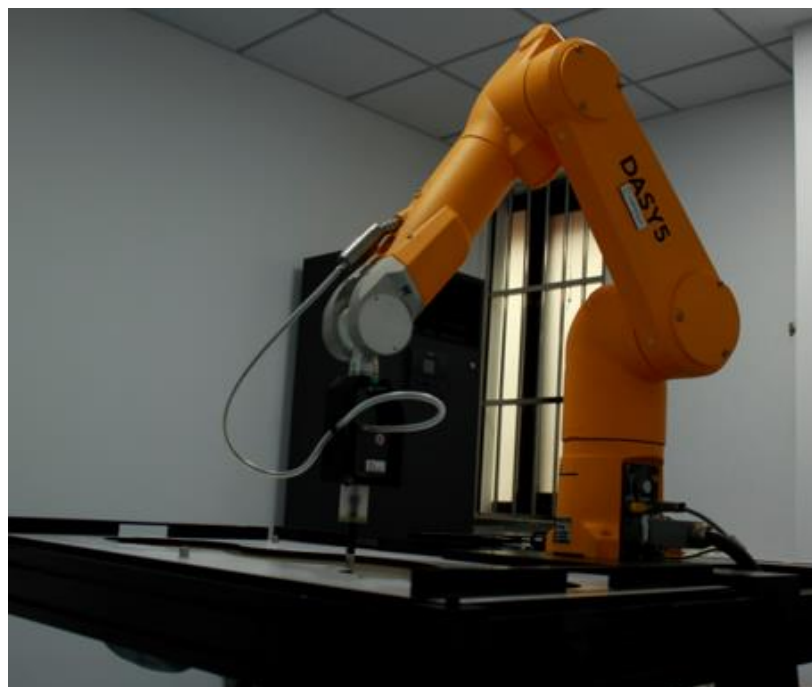

Picture D.5

ANNEX E Equivalent Media Recipes

The liquid used for the frequency range of 800-3000 MHz consisted of water, sugar, salt, preventol, glycol monobutyl and Cellulose. The liquid has been previously proven to be suited for worst-case. The Table E.1 shows the detail solution. It's satisfying the latest tissue dielectric parameters requirements proposed by the IEEE 1528 and IEC 62209.

TableE.1: Composition of the Tissue Equivalent Matter

Frequency (MHz)	835Head	835Body	1900 Head	1900 Body	2450 Head	2450 Body	5800 Head	5800 Body
Ingredients (% by weight)								
Water	41.45	52.5	55.242	69.91	58.79	72.60	65.53	65.53
Sugar	56.0	45.0	\	\	\	\	\	\
Salt	1.45	1.4	0.306	0.13	0.06	0.18	\	\
Preventol	0.1	0.1	\	\	\	\	\	\
Cellulose	1.0	1.0	\	\	\	\	\	\
Glycol Monobutyl	\	\	44.452	29.96	41.15	27.22	\	\
Diethylen glycol mono hexylether	\	\	\	\	\	\	17.24	17.24
Triton X-100	\	\	\	\	\	\	17.24	17.24
Dielectric Parameters Target Value	$\epsilon=41.5$ $\sigma=0.90$	$\epsilon=55.2$ $\sigma=0.97$	$\epsilon=40.0$ $\sigma=1.40$	$\epsilon=53.3$ $\sigma=1.52$	$\epsilon=39.2$ $\sigma=1.80$	$\epsilon=52.7$ $\sigma=1.95$	$\epsilon=35.3$ $\sigma=5.27$	$\epsilon=48.2$ $\sigma=6.00$

Note: There are a little adjustment respectively for 750, 1750, 2600, 5200, 5300 and 5600 based on the recipe of closest frequency in table E.1.

ANNEX F System Validation

The SAR system must be validated against its performance specifications before it is deployed. When SAR probes, system components or software are changed, upgraded or recalibrated, these must be validated with the SAR system(s) that operates with such components.

Table F.1: System Validation for 7600

Probe SN.	Liquid name	Validation date	Frequency point	Status (OK or Not)
7600	Head 750MHz	January 2, 2022	750 MHz	OK
7600	Head 900MHz	January 2, 2022	900 MHz	OK
7600	Head 1450MHz	January 3, 2022	1450 MHz	OK
7600	Head 1750MHz	January 3, 2022	1750 MHz	OK
7600	Head 1900MHz	January 4, 2022	1900 MHz	OK
7600	Head 2100MHz	January 4, 2022	2000 MHz	OK
7600	Head 2300MHz	January 4, 2022	2300 MHz	OK
7600	Head 2450MHz	January 5, 2022	2450 MHz	OK
7600	Head 2600MHz	January 5, 2022	2600 MHz	OK
7600	Head 3300MHz	January 6, 2022	3300 MHz	OK
7600	Head 3500MHz	January 6, 2022	3500 MHz	OK
7600	Head 3700MHz	January 6, 2022	3700 MHz	OK
7600	Head 3900MHz	January 7, 2022	3900 MHz	OK
7600	Head 4100MHz	January 7, 2022	4100MHz	OK
7600	Head 4200MHz	January 7, 2022	4200MHz	OK
7600	Head 4400MHz	January 8, 2022	4400MHz	OK
7600	Head 4600MHz	January 8, 2022	4600MHz	OK
7600	Head 4800MHz	January 8, 2022	4800MHz	OK
7600	Head 4950MHz	January 9, 2022	4950MHz	OK
7600	Head 5250MHz	January 9, 2022	5250MHz	OK
7600	Head 5600MHz	January 9, 2022	5600 MHz	OK
7600	Head 5750MHz	January 9, 2022	5750 MHz	OK

Table F.1: System Validation for 7464

Probe SN.	Liquid name	Validation date	Frequency point	Status (OK or Not)
7464	Head 64MHz	February 04,2022	64MHz	OK
7464	Head 150MHz	February 04,2022	150MHz	OK
7464	Head 300MHz	February 04,2022	300MHz	OK
7464	Head 450MHz	February 04,2022	450MHz	OK
7464	Head 750MHz	February 04,2022	750MHz	OK
7464	Head 835MHz	February 04,2022	835MHz	OK
7464	Head 900MHz	February 04,2022	900MHz	OK
7464	Head 1450MHz	February 04,2022	1450MHz	OK
7464	Head 1750MHz	February 05,2022	1750MHz	OK
7464	Head 1810MHz	February 05,2022	1810MHz	OK
7464	Head 1900MHz	February 05,2022	1900MHz	OK
7464	Head 2000MHz	February 05,2022	2000MHz	OK
7464	Head 2100MHz	February 05,2022	2100MHz	OK
7464	Head 2300MHz	February 05,2022	2300MHz	OK
7464	Head 2450MHz	February 05,2022	2450MHz	OK
7464	Head 2600MHz	February 05,2022	2600MHz	OK
7464	Head 3300MHz	February 06,2022	3300MHz	OK
7464	Head 3500MHz	February 06,2022	3500MHz	OK
7464	Head 3700MHz	February 06,2022	3700MHz	OK
7464	Head 3900MHz	February 06,2022	3900MHz	OK
7464	Head 4100MHz	February 06,2022	4100MHz	OK
7464	Head 4200MHz	February 06,2022	4200MHz	OK
7464	Head 4400MHz	February 06,2022	4400MHz	OK
7464	Head 4600MHz	February 06,2022	4600MHz	OK
7464	Head 4800MHz	February 06,2022	4800MHz	OK
7464	Head 4950MHz	February 06,2022	4950MHz	OK
7464	Head 5200MHz	February 07,2022	5200MHz	OK
7464	Head 5250MHz	February 07,2022	5250MHz	OK
7464	Head 5300MHz	February 07,2022	5300MHz	OK
7464	Head 5500MHz	February 07,2022	5500MHz	OK
7464	Head 5600MHz	February 07,2022	5600MHz	OK
7464	Head 5750MHz	February 07,2022	5750MHz	OK
7464	Head 5800MHz	February 07,2022	5800MHz	OK
7464	Head 6500MHz	February 07,2022	6500MHz	OK
7464	Head 7000MHz	February 07,2022	7000MHz	OK





ANNEX G Probe Calibration Certificate

Probe 7600 Calibration Certificate



In Collaboration with
s p e a g
CALIBRATION LABORATORY

Add: No.52 HuaYuanBei Road, Haidian District, Beijing, 100191, China
Tel: +86-10-62304633-2512 Fax: +86-10-62304633-2504
E-mail: cttl@chinattl.com [Http://www.chinattl.cn](http://www.chinattl.cn)

中国认可
国际互认
校准
CALIBRATION
CNAS L0570

Client **CTTL**
Certificate No: **Z21-60455**

CALIBRATION CERTIFICATE

Object: EX3DV4 - SN : 7600

Calibration Procedure(s): FF-Z11-004-02
Calibration Procedures for Dosimetric E-field Probes

Calibration date: December 29, 2021



This calibration Certificate documents the traceability to national standards, which realize the physical units of measurements(SI). The measurements and the uncertainties with confidence probability are given on the following pages and are part of the certificate.

All calibrations have been conducted in the closed laboratory facility: environment temperature(22±3)°C and humidity<70%.

Calibration Equipment used (M&TE critical for calibration)

Primary Standards	ID #	Cal Date(Calibrated by, Certificate No.)	Scheduled Calibration
Power Meter NRP2	101919	15-Jun-21(CTTL, No.J21X04466)	Jun-22
Power sensor NRP-Z91	101547	15-Jun-21(CTTL, No.J21X04466)	Jun-22
Power sensor NRP-Z91	101548	15-Jun-21(CTTL, No.J21X04466)	Jun-22
Reference 10dBAttenuator	18N50W-10dB	10-Feb-20(CTTL, No.J20X00525)	Feb-22
Reference 20dBAttenuator	18N50W-20dB	10-Feb-20(CTTL, No.J20X00526)	Feb-22
Reference Probe EX3DV4	SN 3617	27-Jan-21(SPEAG, No.EX3-3617_Jan21)	Jan-22
DAE4	SN 1555	20-Aug-21(SPEAG, No.DAE4-1555_Aug21/2)	Aug-22

Secondary Standards	ID #	Cal Date(Calibrated by, Certificate No.)	Scheduled Calibration
SignalGenerator MG3700A	6201052605	16-Jun-21(CTTL, No.J21X04467)	Jun-22
Network Analyzer E5071C	MY46110673	14-Jan-21 (CTTL, No.J21X00232)	Jan -22

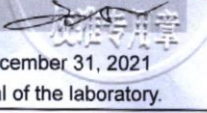
	Name	Function	Signature
Calibrated by:	Yu Zongying	SAR Test Engineer	
Reviewed by:	Lin Hao	SAR Test Engineer	
Approved by:	Qi Dianyuan	SAR Project Leader	

Issued: December 31, 2021

This calibration certificate shall not be reproduced except in full without written approval of the laboratory.

Certificate No: Z21-60455
Page 1 of 9



In Collaboration with
s p e a g
CALIBRATION LABORATORY

Add: No.52 HuaYuanBei Road, Haidian District, Beijing, 100191, China
Tel: +86-10-62304633-2512 Fax: +86-10-62304633-2504
E-mail: cttl@chinattl.com [Http://www.chinattl.cn](http://www.chinattl.cn)

Glossary:

TSL	tissue simulating liquid
NORM _{x,y,z}	sensitivity in free space
ConvF	sensitivity in TSL / NORM _{x,y,z}
DCP	diode compression point
CF	crest factor (1/duty_cycle) of the RF signal
A,B,C,D	modulation dependent linearization parameters
Polarization Φ	Φ rotation around probe axis
Polarization θ	θ rotation around an axis that is in the plane normal to probe axis (at measurement center), i $\theta=0$ is normal to probe axis

Connector Angle information used in DASY system to align probe sensor X to the robot coordinate system

Calibration is Performed According to the Following Standards:

- IEEE Std 1528-2013, "IEEE Recommended Practice for Determining the Peak Spatial-Averaged Specific Absorption Rate (SAR) in the Human Head from Wireless Communications Devices: Measurement Techniques", June 2013
- IEC 62209-1, "Measurement procedure for the assessment of Specific Absorption Rate (SAR) from hand-held and body-mounted devices used next to the ear (frequency range of 300 MHz to 6 GHz)", July 2016
- IEC 62209-2, "Procedure to determine the Specific Absorption Rate (SAR) for wireless communication devices used in close proximity to the human body (frequency range of 30 MHz to 6 GHz)", March 2010
- KDB 865664, "SAR Measurement Requirements for 100 MHz to 6 GHz"

Methods Applied and Interpretation of Parameters:

- NORM_{x,y,z}:** Assessed for E-field polarization $\theta=0$ ($f \leq 900\text{MHz}$ in TEM-cell; $f > 1800\text{MHz}$: waveguide). NORM_{x,y,z} are only intermediate values, i.e., the uncertainties of NORM_{x,y,z} does not effect the E^2 -field uncertainty inside TSL (see below ConvF).
- NORM(f)_{x,y,z} = NORM_{x,y,z}* frequency_response** (see Frequency Response Chart). This linearization is implemented in DASY4 software versions later than 4.2. The uncertainty of the frequency response is included in the stated uncertainty of ConvF.
- DCP_{x,y,z}:** DCP are numerical linearization parameters assessed based on the data of power sweep (no uncertainty required). DCP does not depend on frequency nor media.
- PAR:** PAR is the Peak to Average Ratio that is not calibrated but determined based on the signal characteristics.
- A_{x,y,z}; B_{x,y,z}; C_{x,y,z}; VR_{x,y,z}; A,B,C** are numerical linearization parameters assessed based on the data of power sweep for specific modulation signal. The parameters do not depend on frequency nor media. VR is the maximum calibration range expressed in RMS voltage across the diode.
- ConvF and Boundary Effect Parameters:** Assessed in flat phantom using E-field (or Temperature Transfer Standard for $f \leq 800\text{MHz}$) and inside waveguide using analytical field distributions based on power measurements for $f > 800\text{MHz}$. The same setups are used for assessment of the parameters applied for boundary compensation (alpha, depth) of which typical uncertainty valued are given. These parameters are used in DASY4 software to improve probe accuracy close to the boundary. The sensitivity in TSL corresponds to NORM_{x,y,z}* ConvF whereby the uncertainty corresponds to that given for ConvF. A frequency dependent ConvF is used in DASY version 4.4 and higher which allows extending the validity from $\pm 50\text{MHz}$ to $\pm 100\text{MHz}$.
- Spherical isotropy (3D deviation from isotropy):** in a field of low gradients realized using a flat phantom exposed by a patch antenna.
- Sensor Offset:** The sensor offset corresponds to the offset of virtual measurement center from the probe tip (on probe axis). No tolerance required.
- Connector Angle:** The angle is assessed using the information gained by determining the NORM_x (no uncertainty required).

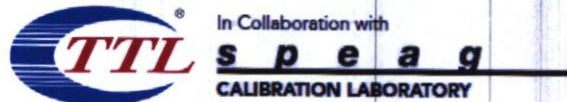

Add: No.52 HuaYuanBei Road, Haidian District, Beijing, 100191, China
 Tel: +86-10-62304633-2512 Fax: +86-10-62304633-2504
 E-mail: cttl@chinattl.com [Http://www.chinattl.cn](http://www.chinattl.cn)

DASY/EASY – Parameters of Probe: EX3DV4 – SN:7600

Basic Calibration Parameters

	Sensor X	Sensor Y	Sensor Z	Unc (k=2)
Norm($\mu\text{V}/(\text{V}/\text{m})^2$) ^A	0.69	0.66	0.68	$\pm 10.0\%$
DCP(mV) ^B	109.3	109.7	110.7	

Modulation Calibration Parameters

UID	Communication System Name		A dB	B dB $\cdot\mu\text{V}$	C	D dB	VR mV	Unc ^E (k=2)
0	CW	X	0.0	0.0	1.0	0.00	212.0	$\pm 2.1\%$
		Y	0.0	0.0	1.0		204.3	
		Z	0.0	0.0	1.0		208.9	

The reported uncertainty of measurement is stated as the standard uncertainty of Measurement multiplied by the coverage factor $k=2$, which for a normal distribution Corresponds to a coverage probability of approximately 95%.

^A The uncertainties of Norm X, Y, Z do not affect the E^2 -field uncertainty inside TSL (see Page 4).

^B Numerical linearization parameter: uncertainty not required.

^E Uncertainty is determined using the max. deviation from linear response applying rectangular distribution and is expressed for the square of the field value.