

CONTENTS

SPECIFICATION FOR APPROVAL

CUSTOMER :	比亚迪
PART NAME :	Paige
PART NO. :	
DZZ NO. :	N12-7024-R0A
REV. :	

	MANUFACTURERR SIGNATURE	CUSTOMER SIGNATURE
APPROVED BY:		
DATE:	2021.11.24. 	

Shenzhen be-comfortable technology.co.,LTD

深圳市得自在科技有限公司

Address: No.1606,Build C6,HengFeng industrial city,xixiang street,baoan district,Shenzhen

shanghai mengju technology co., LTD

上海市盟钜科技有限公司

103B, Build10, No.198 Zhang Heng Road , Pudong New Area,Shanghai

1. 试验设备和条件(Test Equipment & Conditions)

1.1. **Network Analyzers** : KEYSIGHT P5002A

1.2. **Communications Test Set**: R&S CMW 500

1.3. **3D Chamber Test System**: 64探头测试系统

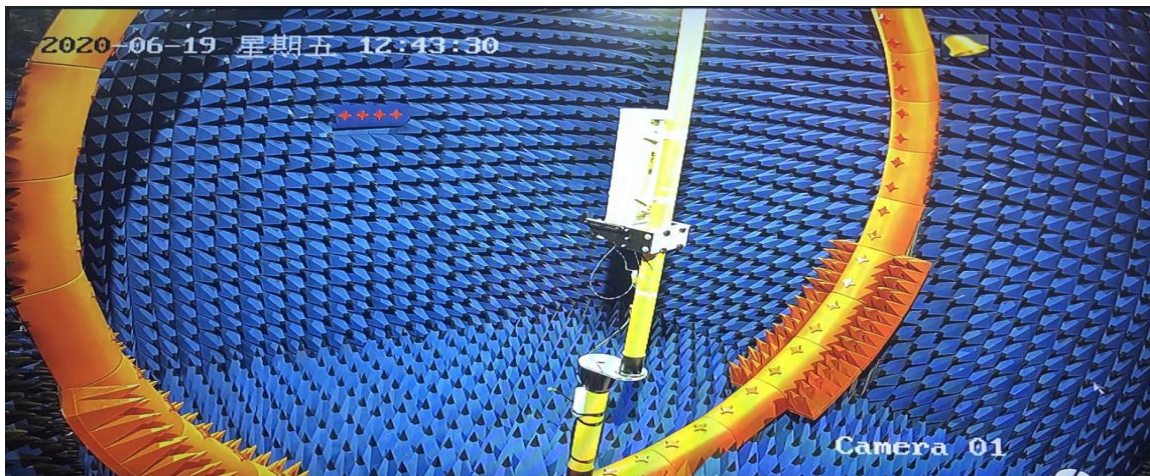

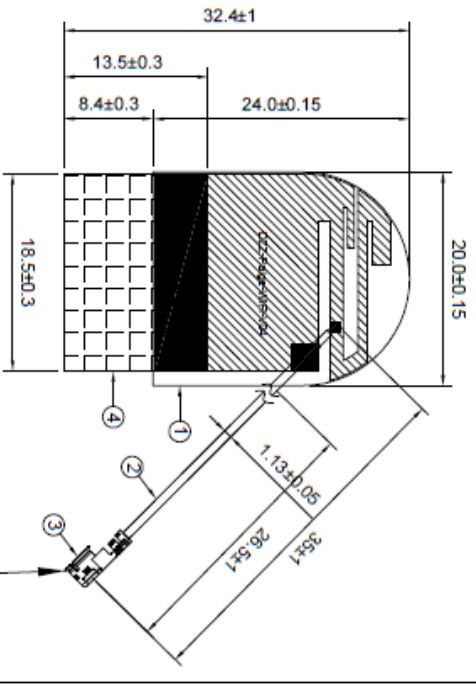
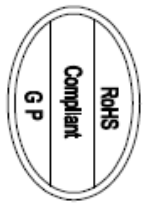

端子口侧立向下，如图所示
RF Plug side standing downwards

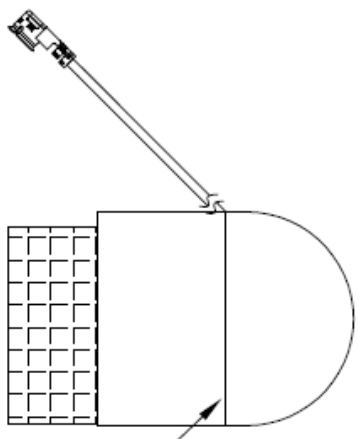

离型纸切断线
Release paper/Knife Edge

- 技术要求:
1. 标“*”尺寸为重点管控尺寸;
 2. 未标注尺寸依照图纸;
 3. 无虚焊、假焊、连锡、短路、断路等焊接不良现象;
 4. 所有部件需符合RoHS要求;
 5. 成品需全检性能。

Rev	Description	Date	Remark
A	New drawing		
1			

No.	Name	Material	Color	Treatment	Amount	Remark
4	导电布	18.5*13.5	银色		1	
3	端子头	一代端子	金色		1	
2	射频线	1.13同轴线	白色		1	
1	WiFi天线	FPC	白色		1	

Be-Comfortable
得自在

深圳得自在科技有限公司
SHEN ZHEN Be Comfortable CO., LTD

Project	Paige	Date	2021.11.23
Part Name	WiFi天线	Designed by	
Part No.	N12-7024-R0A	Checked by	MD 赵同廷
Material	N/A	RF	德功率
DWG No.	N12-7024-R0A	Approved by	

Unit: mm Scale: 1:1 Rev: A

天线产品成份表

供方名称： 深圳市得自在科技有限公司

NO	物料名称	型号规格	客户料号	材料名称	厂商	备注
1	WIFI天线	Paige		FPC	兴北海	符合ROHS2.0
				射频线	神宇	符合ROHS2.0
				端子	科信成	符合ROHS2.0
				导电布	鑫巨基	符合ROHS2.0

2. Analyzer Measurement

2.1 ant S11 test results

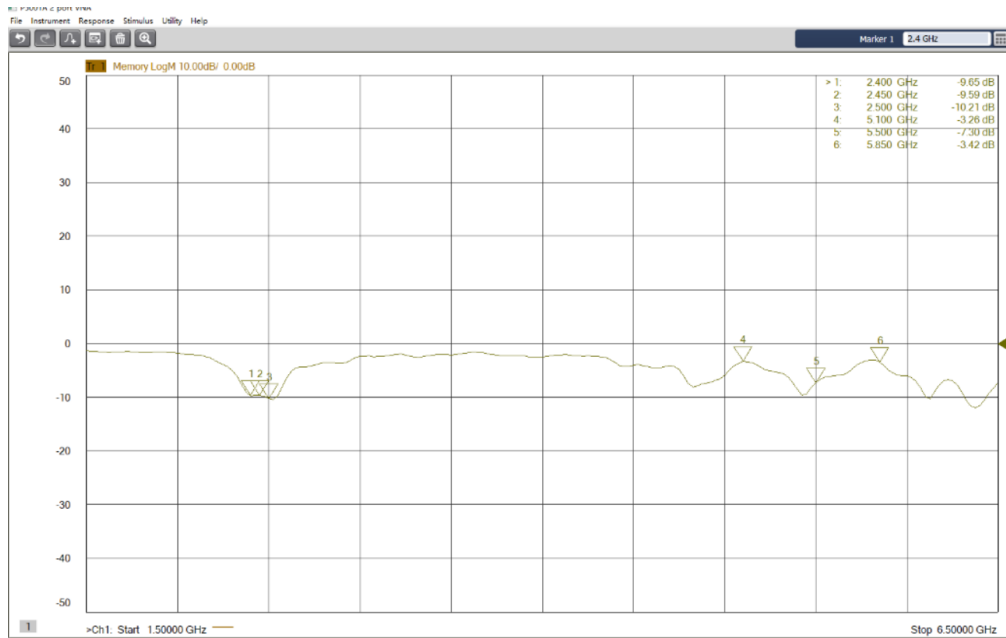

3. Passive Data

 <p style="font-size: 24px; font-weight: bold;">得自在</p>											
Frequency ID	1	2	3	4	5	6	7	8	9	10	11
Frequency (MHz)	2400.0	2410.0	2420.0	2430.0	2440.0	2450.0	2460.0	2470.0	2480.0	2490.0	2500.0
Gain (dBi)	0.02	0.30	0.83	1.08	0.89	0.68	0.56	0.35	0.14	0.29	0.43
Efficiency (%)	32.33	33.31	33.83	33.62	33.30	33.10	33.48	33.55	33.05	32.80	32.16

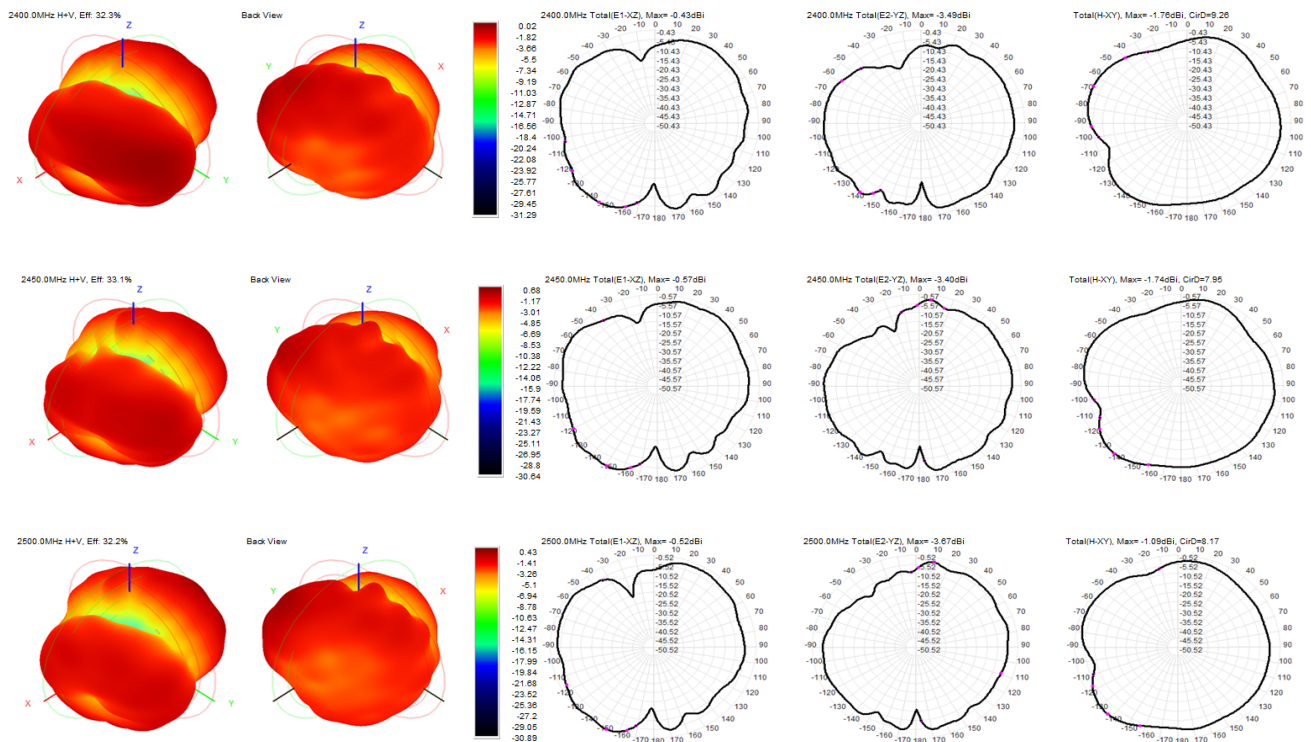

产品包装规范

Be-Comfortable
—— 得自在 ——

日期: 2021-11-23

page: 1 of 1

成品名称 :Paige天线	版本: A
	客户: 比亚迪

一: 成品天线

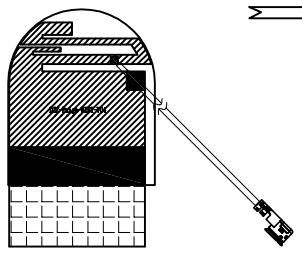

二: 每小袋装50PCS产品
(以实际包装为准)。

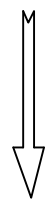

三: 每大袋装10个小袋,
(以实际包装为准)。

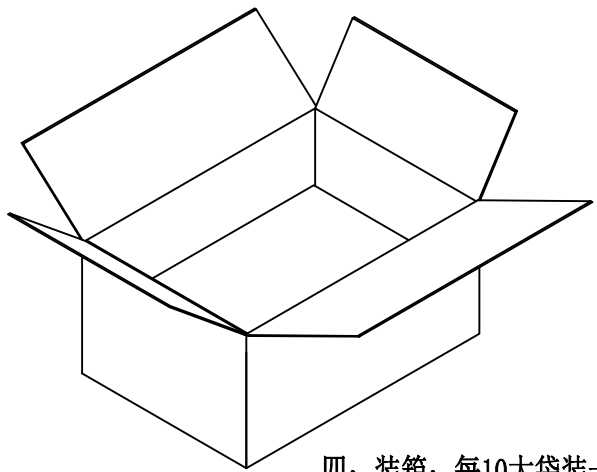
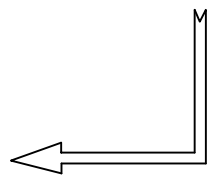

四: 装箱: 每10大袋装一箱,
一箱共5000PCS产品
(以实际包装为准)。

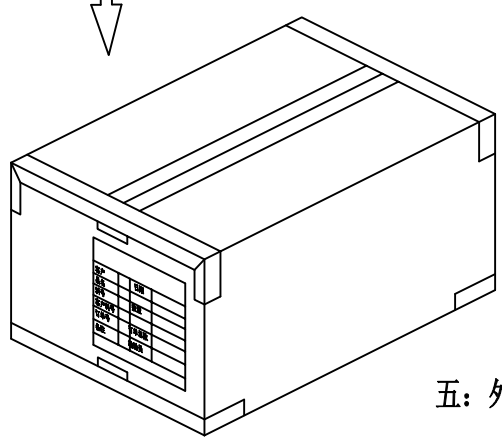
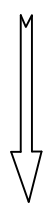

五: 外箱贴我司生产标签和ROHS标签。

批准: _____

确认: _____

拟制: 赵同廷

由 Autodesk 教育版产品制作

Autodesk 教育版产品制作