

规格承认书  
SPECIFICATION FOR APPROVAL

客户 Customer	比亚迪
项目名称 Project Name	Gillian T1
客户料号 Customer NO.	
规格 specification	2.4GHz WIFI天线
供方料号 Supplier NO.	N12-6920-R0A
规格书编号 Specification NO.	
编写人 Write by	饶功泽
版本 REV.	Ver.01
日期 Date	2021/11/04
备注 Note	Shenzhen be-comfortable technology.co.,LTD No.1606, Build C6, HengFeng industrial city, Xixiang street, Baoan district, Shenzhen, China

客户确认 CUSTOMER APPROVED BY		
批准 Approved by	审核 Checked by	制表 Prepared by
供方确认 SUPPLIER APPROVED BY		
批准 Approved by	审核 Checked by	制表 Prepared by
		



## 2. 试验设备和条件(Test Equipment & Conditions)

2.1. **Network Analyzers** : KEYSIGHT P5002A

2.2. **Communications Test Set**: R&S CMW 500

2.3. **3D Chamber Test System**: 64探头测试系统

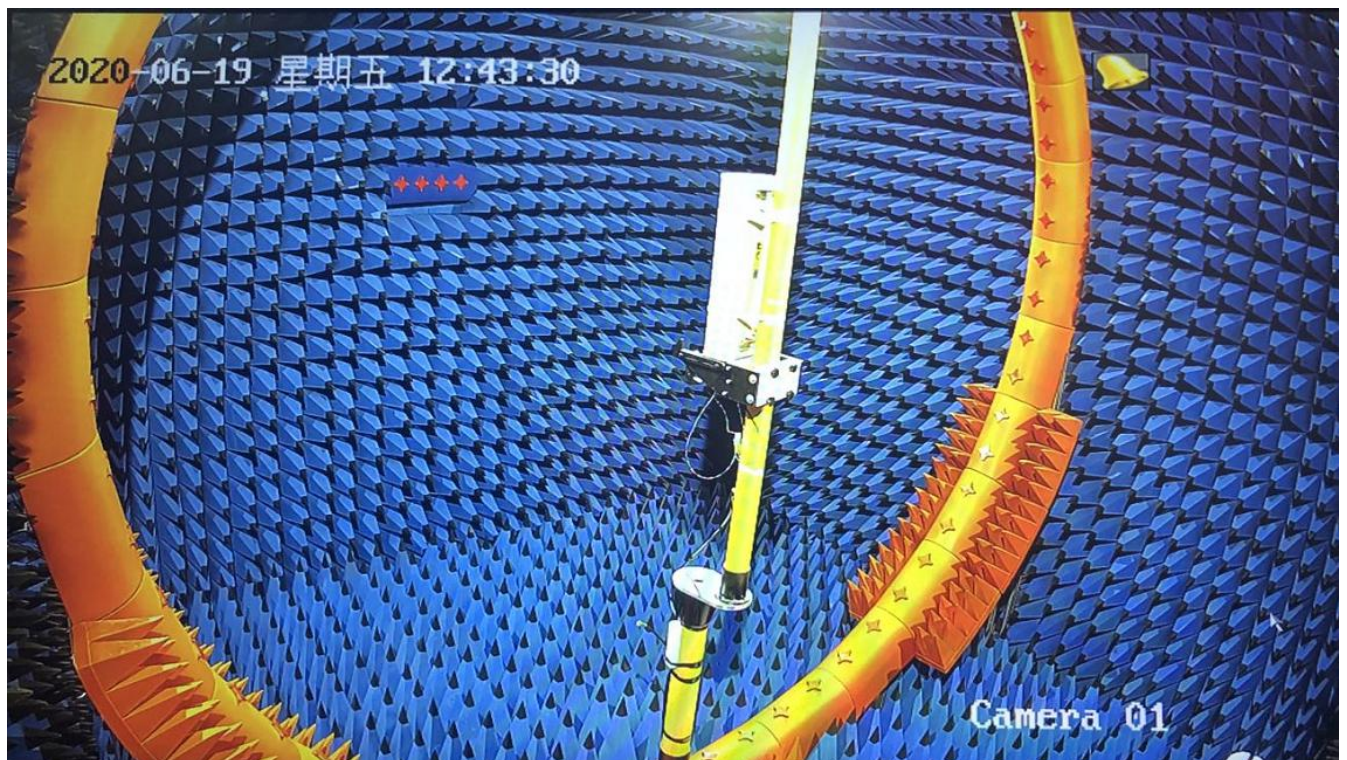

Rev	Description	Date	Remark
A	New drawing		

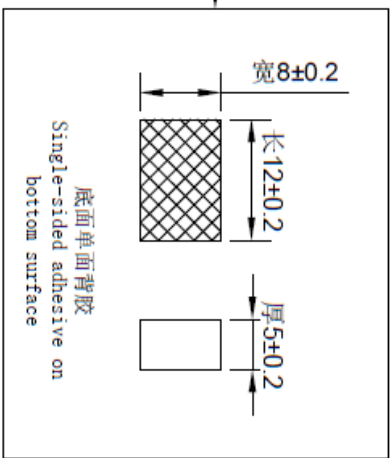
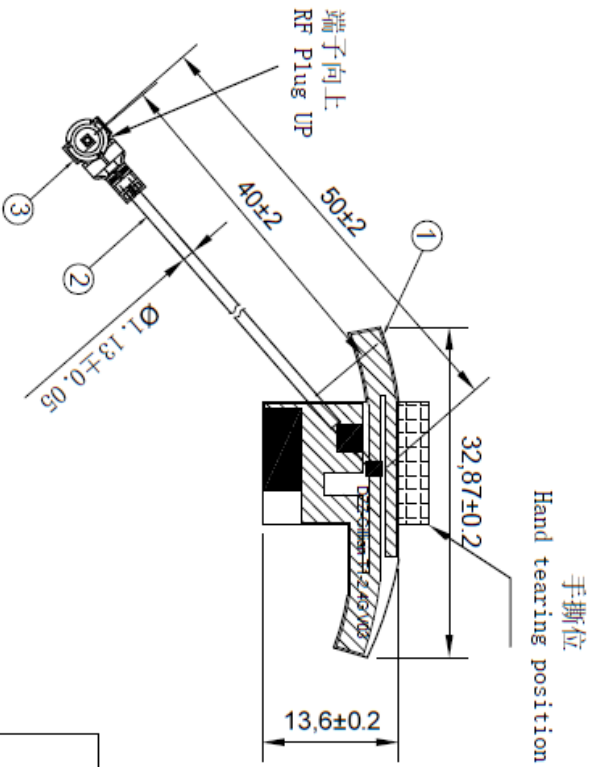

- 技术要求:
1. 标“\*”尺寸为重点管控尺寸;
  2. 未标注尺寸依照图纸;
  3. 无虚焊、假焊、连锡、短路、断路等焊接不良现象;
  4. 所有部件需符合RoHS要求;
  5. 成品需全检性能。

No.	Part No.	Name	Specification	Amount	Remark
1		导电泡棉	单面导电背胶	1	
2		端子	TPPX 1代	1	
3		同轴线	Ø1.13 单银线 黑色	1	
4		FPC	PI 单面板 黑色	1	

<b>Be-Comfortable</b> 得自在		深圳市得自在科技有限公司 SHEN ZHEN BE-COMFORTABLE CO., LTD	
第三角 Third Angle	项目 Project Gillian TI	日期 Date 2021-09-28	
0~10 ±0.05 10~18 ±0.10 18~30 ±0.12 30~40 ±0.15 40~ ±0.20	零件名称 Part Name 2.4G天线	设计者 Designed by 赵同廷	
±0.02 ±0.03 ±0.02 ±0.04 ±0.5°	零件编号 Part No. N12-6920-R0A	检查者 Checked by RP PE	
位置 Location	材料 Material /	批准者 Approved by	
	DWG No. N12-6920-R0A	单位 Unit mm	比例 Scale 1:1
		图号 Scale 1:1	版本 Rev A

天线产品成份表

供方名称： 深圳市得自在科技有限公司

NO	Name	Model	Type	材料名称	厂商	备注
1	2.4MHz WIFI Ant	Gillian T1	FPC	FPC	兴北海	符合ROHS2.0
				射频线	神宇	符合ROHS2.0
				端子	科信成	符合ROHS2.0
				泡棉	鑫巨基	符合ROHS2.0

S11驻波图:

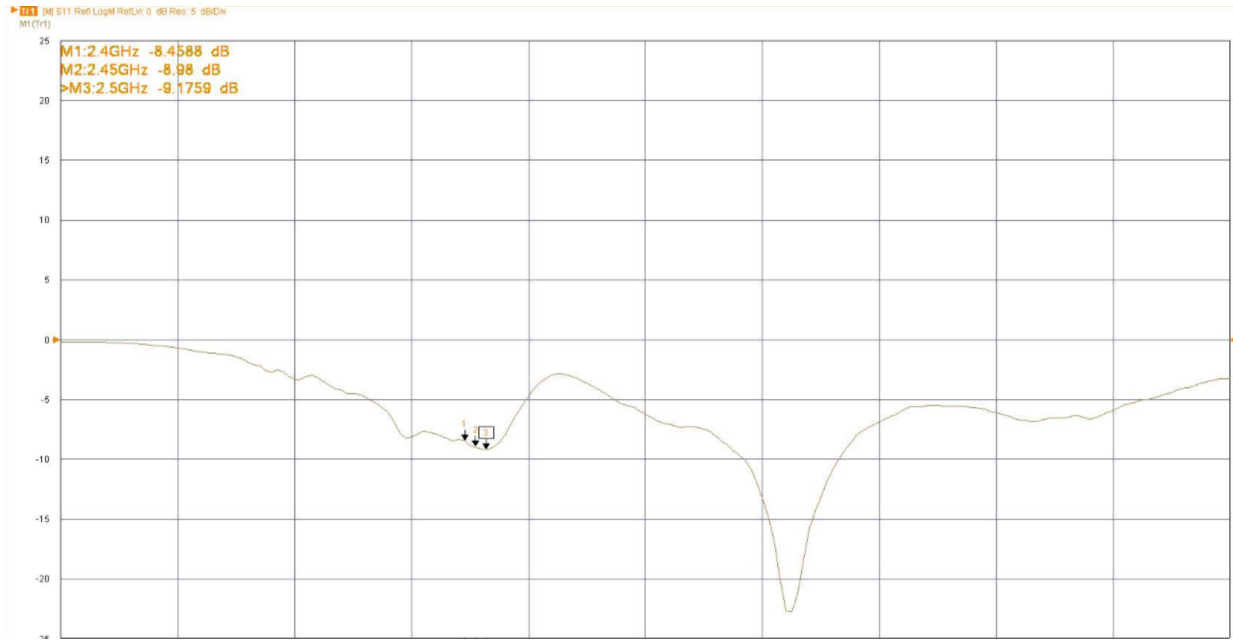

增益/效率/3D图

 <p style="font-size: 24px; font-weight: bold;">得自在</p>											
Frequency ID	1	2	3	4	5	6	7	8	9	10	11
Frequency (MHz)	2400.0	2410.0	2420.0	2430.0	2440.0	2450.0	2460.0	2470.0	2480.0	2490.0	2500.0
Gain (dBi)	2.04	2.11	2.21	2.13	2.12	2.08	2.20	2.08	2.13	2.13	2.02
Efficiency (%)	51.10	51.18	50.80	51.10	51.01	50.75	51.23	50.96	50.31	50.87	50.49

3D Pattern

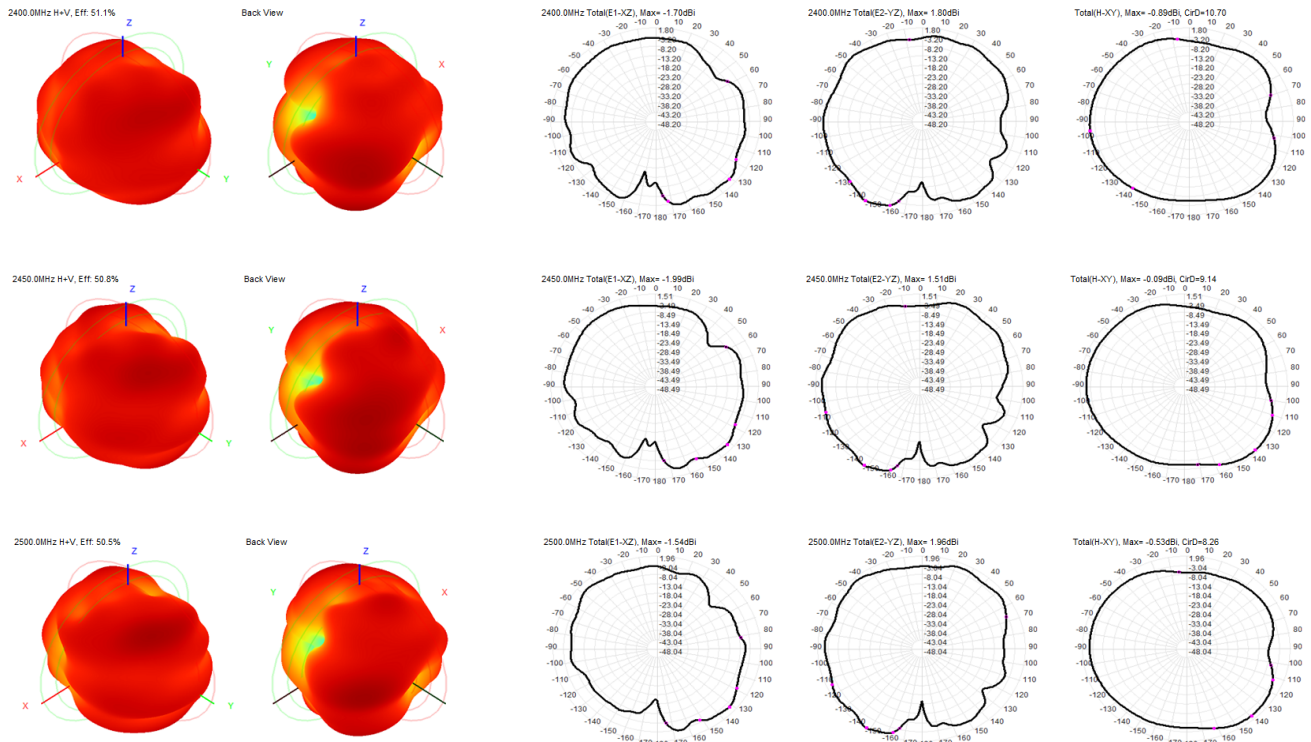

# 产品包装规范

日期: 2021-09-10

page: 1 of 1

成品名称 :Gillian T1天线	版本: A
	客户: 比亚迪

一: 成品天线

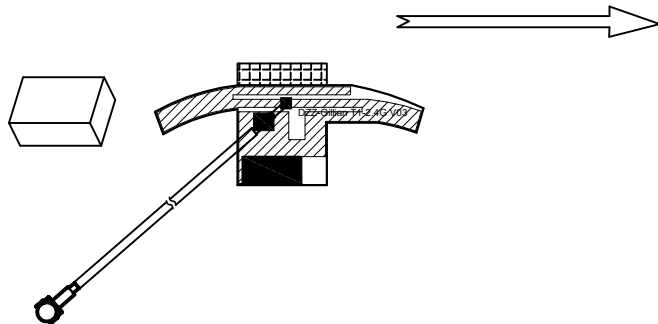

二: 每小袋装50PCS产品,  
(以实际包装为准)。



三: 每大袋装10个小袋,  
(以实际包装为准)。

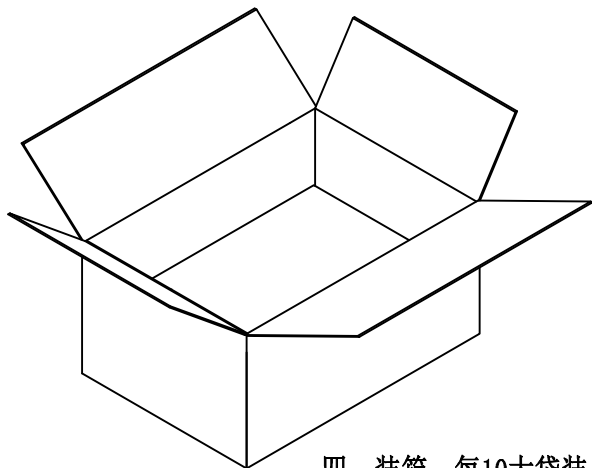
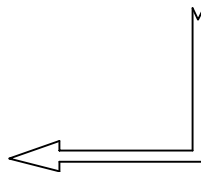

四: 装箱: 每10大袋装一箱, 一箱共5000PCS产品,  
导电泡棉整版装一袋, 在箱子内部的顶部。  
(以实际包装为准)。

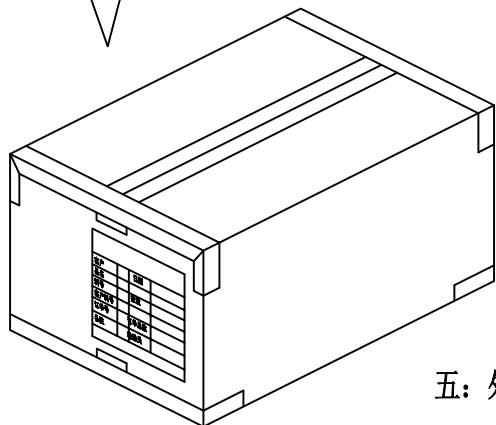
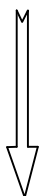

五: 外箱贴我司生产标签和ROHS标签。

批准: \_\_\_\_\_

确认: \_\_\_\_\_

拟制: 赵同廷

由 Autodesk 教育版产品制作

由 Autodesk 教育版产品制作