

规格承认书

SPECIFICATION FOR APPROVAL

客户 Customer	比亚迪
项目名称 Project Name	Gillian T2
客户料号 Customer NO.	
规格 specification	2.4GHz WIFI天线
供方料号 Supplier NO.	N12-6921-R0A
规格书编号 Specification NO.	
编写人 Write by	饶功泽
版本 REV.	Ver.01
日期 Date	2021/11/04
备注 Note	Shenzhen be-comfortable technology.co.,LTD No.1606, Build C6, HengFeng industrial city, Xixiang street, Baoan district, Shenzhen, China

客户确认 CUSTOMER APPROVED BY		
批准 Approved by	审核 Checked by	制表 Prepared by
供方确认 SUPPLIER APPROVED BY		
批准 Approved by	审核 Checked by	制表 Prepared by
		

2. 试验设备和条件(Test Equipment & Conditions)

2.1. **Network Analyzers** : KEYSIGHT P5002A

2.2. **Communications Test Set**: R&S CMW 500

2.3. **3D Chamber Test System**: 64探头测试系统

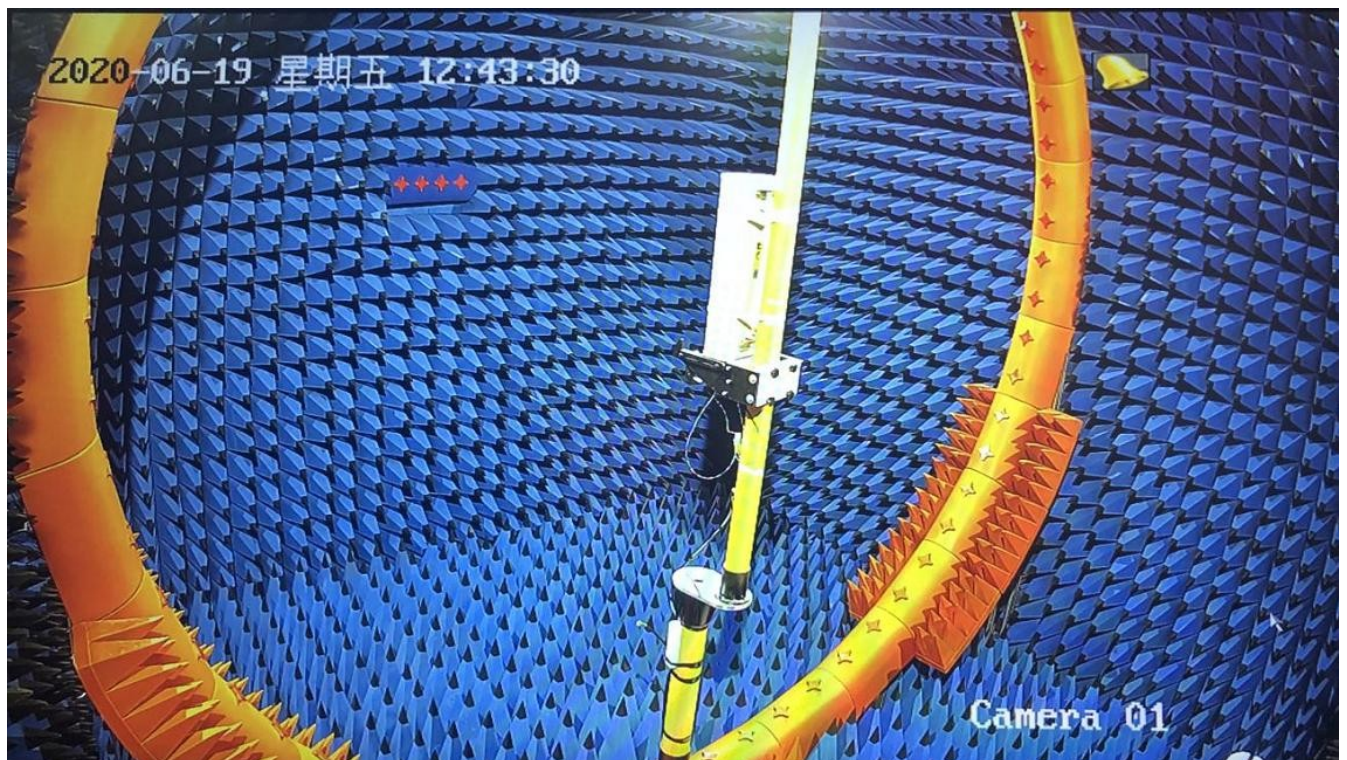

Rev	Description	Date	Remark
A	New drawing		

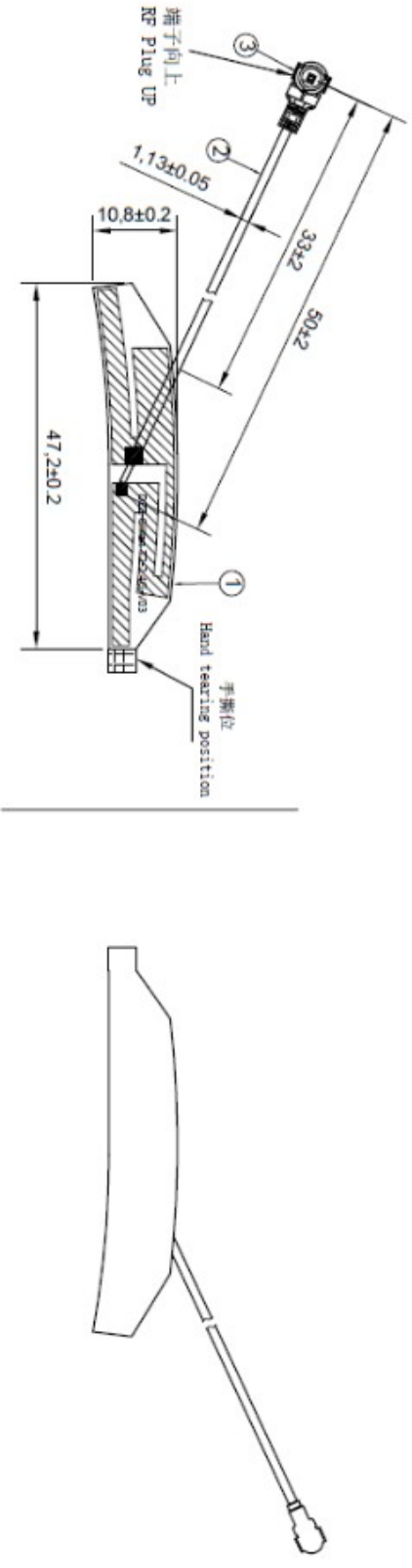

- 技术要求:
1. 标“*”尺寸为重点管控尺寸;
 2. 未标注尺寸依照图纸;
 3. 无虚焊、假焊、连锡、短路、断路等焊接不良现象;
 4. 所有部件需符合RoHS要求;
 5. 成品需全检性能。

No.	Part No.	Name	Specification	Amount	Remark
1		端子	IPEX 1代	1	
2		同轴线	φ1.13 单根线 黑色	1	
3		PI 单面板 黑色		1	

Be-Comfortable 得自在		深圳市得自在科技有限公司 SHEN ZHEN BE-COMFORTABLE CO., LTD	
第三角 0.05 0~10 ±0.05 10~18 ±0.10 18~30 ±0.12 30~40 ±0.15 40~ ±0.20	第三角 0.02 0.03 0.02 0.04 ±0.5°	Project G1111a T2	Date 2021-09-28
Part Name 2.4G天线	Part No. N12-6921-ROA	Designed by 赵同廷	Checked by 饶功泽
Material /	DWG No. N12-6921-ROA	Approved by PE	Unit mm
Scale 1:1	Rev A		

天线产品成份表
供方名称： 深圳市得自在科技有限公司

NO	Name	Model	Type	材料名称	厂商	备注
1	2.4MHz WIFI Ant	Gillian T2	FPC	FPC	兴北海	符合 ROHS2.0
				射频线	神宇	符合 ROHS2.0
				端子	科信成	符合 ROHS2.0
				泡棉	鑫巨基	符合 ROHS2.0

S11 驻波图:

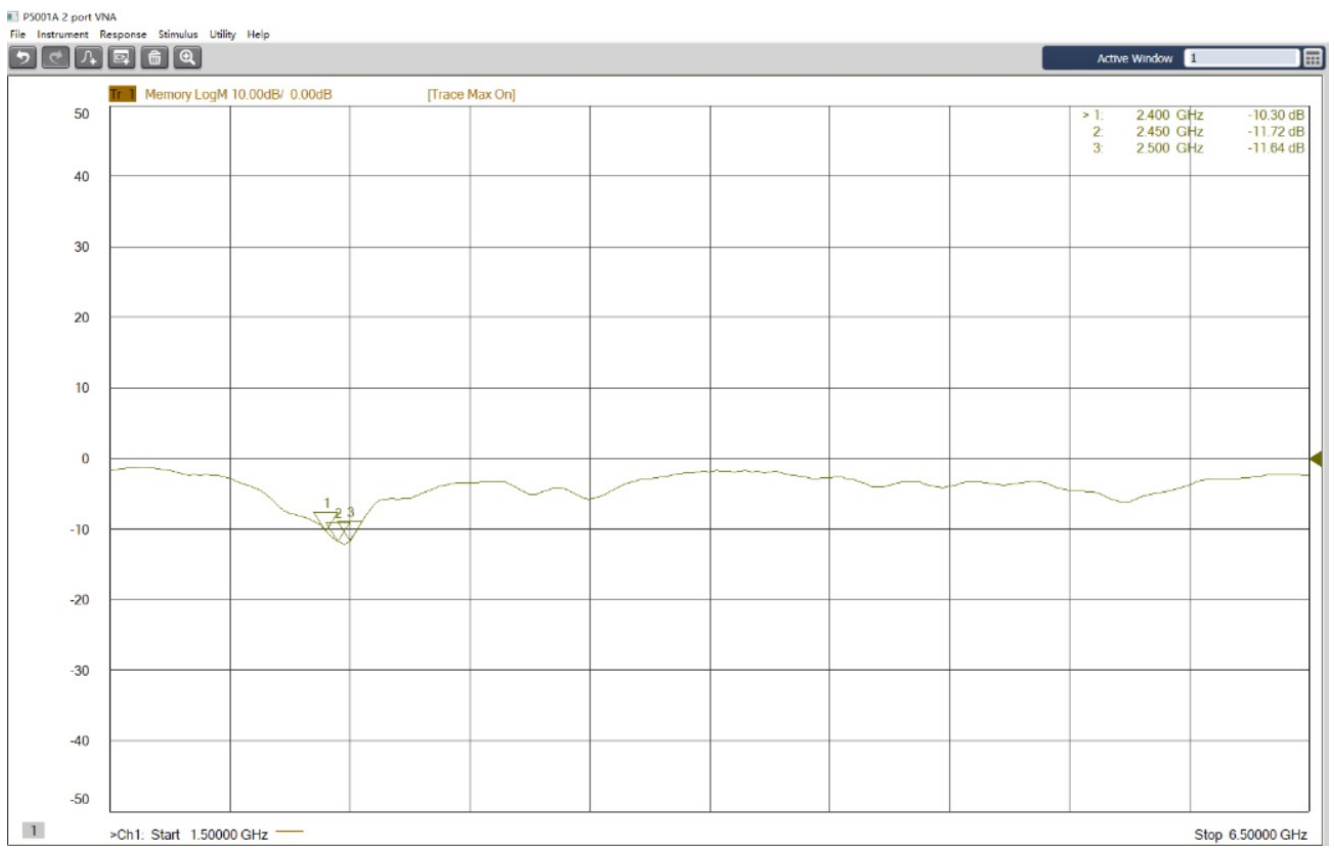

增益/效率

Frequency ID	1	2	3	4	5	6	7	8	9	10	11
Frequency (MHz)	2400.0	2410.0	2420.0	2430.0	2440.0	2450.0	2460.0	2470.0	2480.0	2490.0	2500.0
Gain (dBi)	2.11	2.17	2.23	2.14	2.07	2.14	2.01	2.24	2.15	2.20	2.15
Efficiency (%)	66.10	65.17	66.52	66.69	67.25	67.24	65.98	68.69	68.45	67.46	68.10

3D Pattern

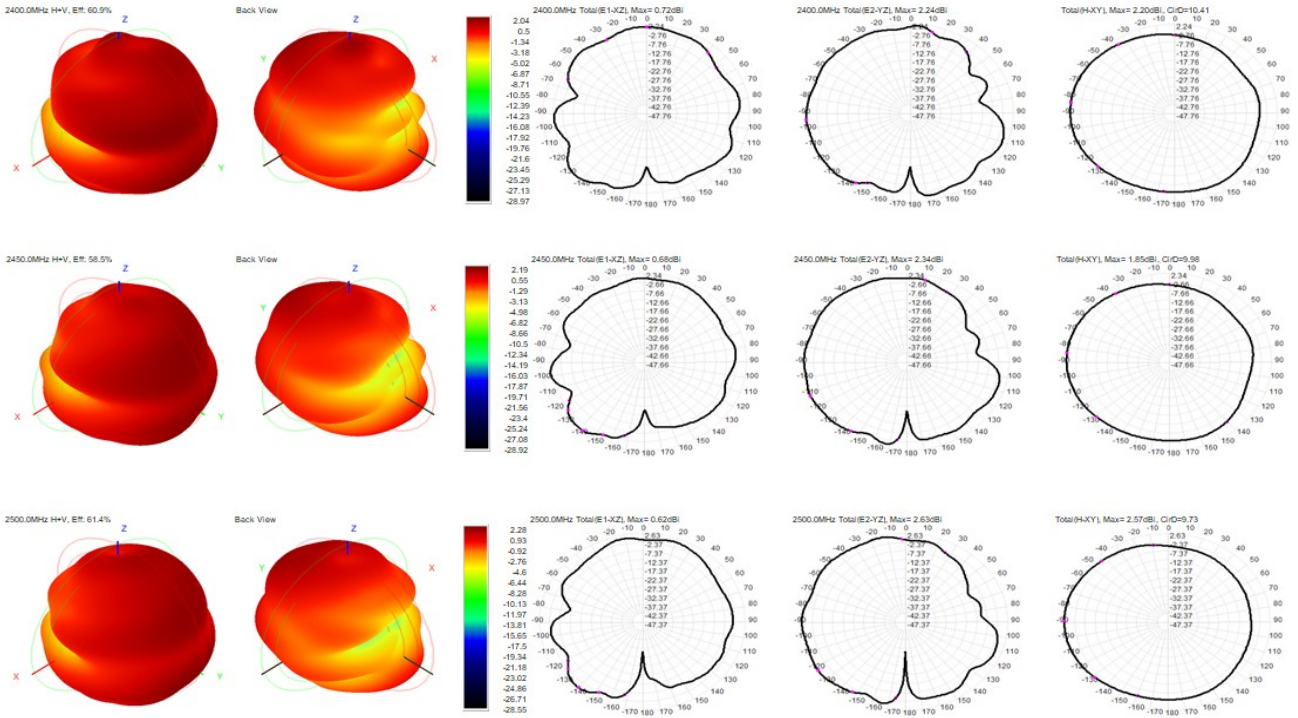

产品包装规范

Be-Comfortable
—— 得自在 ——

日期: 2021-09-10

page: 1 of 1

成品名称 :Gillian T2天线	版本: A
	客户: 比亚迪

一: 成品天线

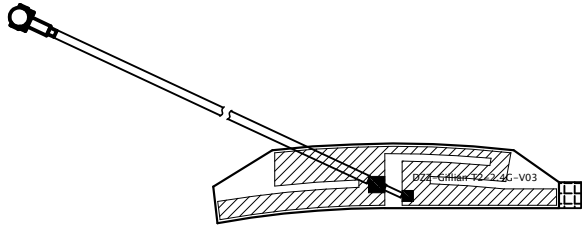

二: 每小袋装 50PCS 产品
(以实际包装为准)。

三: 每大袋装 10小袋,
(以实际包装为准)。

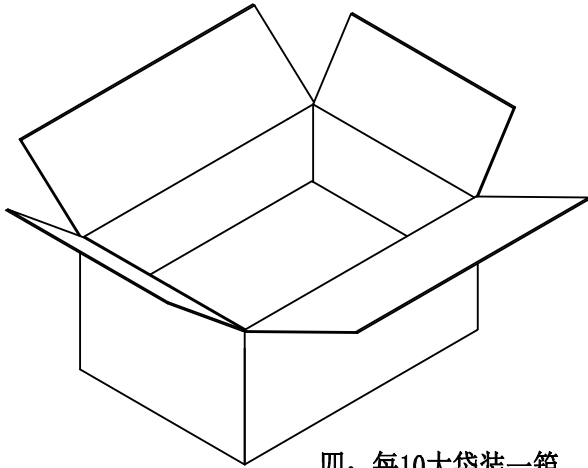

四: 每10大袋装一箱,
一箱共5000PCS产品
(以实际包装为准)。

五: 外箱贴我司生产标签和ROHS标签。

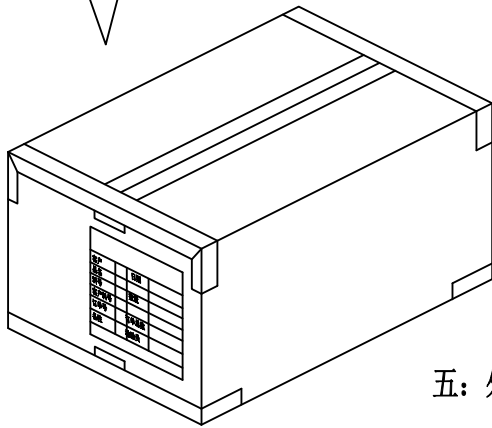

批准: _____

确认: _____

拟制: 赵同廷