

# FCC Radio Test Report

## FCC ID: RWO-RZ090508

**Report No.** : BTL-FCCP-1-2309C037A  
**Equipment** : Notebook PC  
**Model Name** : RZ09-0508  
**Brand Name** : RAZER  
**Applicant** : Razer Inc.  
**Address** : 9 Pasteur, Suite 100, Irvine, CA92618, USA.

**Equipment Class** : 6XD - 15E 6 GHz Low Power Indoor Client

**Radio Function** : U-NII 6 GHz (U-NII 5, U-NII 6, U-NII 7, U-NII 8)

**FCC Rule Part(s)** : FCC CFR Title 47, Part 15, Subpart E (15.407)  
**Measurement Procedure(s)** : ANSI C63.10-2013

**Date of Receipt** : 2023/9/22  
**Date of Test** : 2023/11/2 ~ 2023/12/15  
**Issued Date** : 2024/1/8

The above equipment has been tested and found in compliance with the requirement of the above standards by BTL Inc.

**Prepared by** :   
Jerry Chuang, Supervisor

**Approved by** :   
Peter Chen, Vice Manager

**BTL Inc.**

No.18, Ln. 171, Sec. 2, Jiuzong Rd., Neihu Dist., Taipei City 114, Taiwan

Tel: +886-2-2657-3299 Fax: +886-2-2657-3331 Web: www.newbtl.com Service mail: btl\_qa@newbtl.com

**Declaration**

**BTL** represents to the client that testing is done in accordance with standard procedures as applicable and that test instruments used has been calibrated with standards traceable to international standard(s) and/or national standard(s).

**BTL's** reports apply only to the specific samples tested under conditions. It is manufacture's responsibility to ensure that additional production units of this model are manufactured with the identical electrical and mechanical components. **BTL** shall have no liability for any declarations, inferences or generalizations drawn by the client or others from **BTL** issued reports.

This report is the confidential property of the client. As a mutual protection to the clients, the public and ourselves, the test report shall not be reproduced, except in full, without our written approval.

**BTL's** laboratory quality assurance procedures are in compliance with the **ISO/IEC 17025** requirements, and accredited by the conformity assessment authorities listed in this test report.

**BTL** is not responsible for the sampling stage, so the results only apply to the sample as received.

The information, data and test plan are provided by manufacturer which may affect the validity of results, so it is manufacturer's responsibility to ensure that the apparatus meets the essential requirements of applied standards and in all the possible configurations as representative of its intended use.

**Limitation**

For the use of the authority's logo is limited unless the Test Standard(s)/Scope(s)/Item(s) mentioned in this test report is (are) included in the conformity assessment authorities acceptance respective.

Please note that the measurement uncertainty is provided for informational purpose only and are not use in determining the Pass/Fail results.

**CONTENTS**

CONTENTS	3
REVISION HISTORY	4
1 SUMMARY OF TEST RESULTS	5
1.1 TEST FACILITY	6
1.2 MEASUREMENT UNCERTAINTY	6
1.3 TEST ENVIRONMENT CONDITIONS	6
2 GENERAL INFORMATION	7
2.1 EUT INFORMATION	7
2.2 TEST MODES	11
2.3 TESTED CONFIGURATION DIAGRAM	12
2.4 SUPPORT UNITS	13
3 UNDESIRABLE EMISSIONS TEST	14
3.1 LIMITS	14
3.2 TEST PROCEDURE	15
3.3 DEVIATION FROM TEST STANDARD	16
3.4 TEST SETUP	16
3.5 EUT OPERATING CONDITIONS	17
3.6 TEST RESULT – BELOW 30 MHZ	17
3.7 TEST RESULT – 30 MHZ TO 1 GHZ	17
3.8 TEST RESULT – ABOVE 1 GHZ	17
4 AC POWER LINE CONDUCTED EMISSIONS TEST	18
4.1 LIMITS	18
4.2 TEST PROCEDURE	18
4.3 DEVIATION FROM TEST STANDARD	19
4.4 TEST SETUP	19
4.5 EUT OPERATING CONDITIONS	19
4.6 TEST RESULT	19
5 CONTENTION BASED PROTOCOL	20
5.1 LIMIT	20
5.2 TEST PROCEDURE	20
5.3 DEVIATION FROM STANDARD	21
5.4 TEST SETUP	21
5.5 EUT OPERATION CONDITIONS	21
5.6 TEST RESULTS	21
6 LIST OF MEASURING EQUIPMENTS	22
7 EUT TEST PHOTOS	24
8 EUT PHOTOS	24
APPENDIX A UNDESIRABLE EMISSIONS - 30 MHZ TO 1 GHZ	25
APPENDIX B UNDESIRABLE EMISSIONS - ABOVE 1 GHZ	28
APPENDIX C AC POWER LINE CONDUCTED EMISSIONS	34
APPENDIX D CONTENTION BASED PROTOCOL	39

**REVISION HISTORY**

Report No.	Version	Description	Issued Date	Note
BTL-FCCP-1-2309C037A	R00	Original Report.	2023/12/20	Invalid
BTL-FCCP-1-2309C037A	R01	Revised report to address comments(Added CBP data and related descriptions).	2024/1/8	Valid

## 1 SUMMARY OF TEST RESULTS

Test procedures according to the technical standards.

Standard(s) Section	Description	Test Result	Judgement	Remark
15.407(a)	Maximum e.i.r.p.	-----	-----	-----
15.203 15.407(a)	Antenna requirement	-----	-----	-----
15.407(a)	Maximum transmitter channel bandwidth	-----	-----	-----
15.407(a)	Maximum power spectral density	-----	-----	-----
15.407(b) 15.209 15.407(b) 15.205	Undesirable emissions and Restricted bands of operation	APPENDIX A APPENDIX B	Pass	-----
15.407(b)	In-band emission (Mask)	-----	-----	-----
15.407(b)	AC power line conducted emissions	APPENDIX C	Pass	-----
15.407(d)	Contention-based protocol	APPENDIX D	Pass	-----

**NOTE:**

- (1) "N/A" denotes test is not applicable in this Test Report.
- (2) The report format version is TP.1.1.1.
- (3) The ac power lines conducted emissions and radiated emissions are tested to demonstrate full compliance of both modules integrated into the host and host itself.
- (4) The antenna gain of EUT is smaller than that of the module. So in this report the worst cases of radiated spurious emissions and AC Power Line Conducted Emissions were evaluated and recorded in the report. For the test results of all other test items please refer to module test reports.

### 1.1 TEST FACILITY

The test locations stated below are under the TAF Accreditation Number 0659.

The test location(s) used to collect the test data in this report are:

No. 68-1, Ln. 169, Sec. 2, Datong Rd., Xizhi Dist., New Taipei City 221, Taiwan  
(FCC DN: TW0659)

C05       CB08       CB11       SR10       SR11

No. 72, Ln. 169, Sec. 2, Datong Rd., Xizhi Dist., New Taipei City 221, Taiwan  
(FCC DN: TW0659)

C06       CB21       CB22

### 1.2 MEASUREMENT UNCERTAINTY

The reported uncertainty of measurement  $y \pm U$ , where expanded uncertainty  $U$  is based on a standard uncertainty multiplied by a coverage factor of  $k = 2$ , providing a level of confidence of approximately **95 %**.

The measurement instrumentation uncertainty considerations contained in CISPR 16-4-2. The BTL measurement uncertainty is less than the CISPR 16-4-2  $U_{\text{CISPR}}$  requirement.

#### A. Undesirable emissions test:

Test Site	Measurement Frequency Range	U (dB)
CB21	0.03 GHz ~ 0.2 GHz	4.17
	0.2 GHz ~ 1 GHz	4.72
	1 GHz ~ 6 GHz	5.21
	6 GHz ~ 18 GHz	5.51
	18 GHz ~ 26 GHz	3.69
	26 GHz ~ 40 GHz	4.23

#### B. AC power line conducted emissions test:

Test Site	Method	Measurement Frequency Range	U (dB)
C05	CISPR	150 kHz ~ 30MHz	3.44

#### C. Conducted test:

Test Item	$U_i$ (dB)
Contention-based protocol	-

#### NOTE:

Unless specifically mentioned, the uncertainty of measurement has not been taken into account to declare the compliance or non-compliance to the specification.

### 1.3 TEST ENVIRONMENT CONDITIONS

Test Item	Environment Condition	Test Voltage	Tested by
Undesirable emissions below 1 GHz	23 °C, 57 %	AC 120V	Kevin Zhen
Undesirable emissions above 1 GHz	23 °C, 57 %	AC 120V	Kevin Zhen
AC power line conducted emissions	21 °C, 49 %	AC 120V	Jerry Chuang
Contention-based protocol	24.1°C, 47%	AC 120 V	Jerry Chuang

## 2 GENERAL INFORMATION

### 2.1 EUT INFORMATION

Equipment	Notebook PC
Model Name	RZ09-0508
Brand Name	RAZER
Model Difference(s)	N/A
Hardware Version	APF23001_MB
Software Version	Windows 11 Home
Power Source	1# DC voltage supplied from AC adapter. Model: RC30-024801 2# Supplied from battery. Model: RC30-0482
Power Rating	1# I/P: 100-240V~ 3.6A 50/60Hz O/P: 19.5V===11.8A TOTAL 230W 2# DC 15.4V 4422mAh 68.1Wh
WiFi+BT Module	QCNCM865
Frequency Range	U-NII 5: 5925 MHz ~ 6425 MHz U-NII 6: 6425 MHz ~ 6525 MHz U-NII 7: 6525 MHz ~ 6875 MHz U-NII 8: 6875 MHz ~ 7125 MHz
Operation Frequency	UNII-5: 5955 MHz ~ 6435 MHz UNII-6: 6435 MHz ~ 6515 MHz UNII-7: 6525 MHz ~ 6875 MHz UNII-8: 6895 MHz ~ 7115 MHz
Resource Unit(RU)	Single RU: 26 tone, 52 tone, 106 tone, 242 tone, 484 tone, 996 tone Multi-RU(Small RU): 52 tone+26 tone, 106 tone+26 tone Multi-RU(Large RU): 484 tone+242 tone, 996 tone+484 one, 2*996 tone
Channel Puncturing (Large RU)	80MHz Punctured by 20MHz, 160MHz Punctured by 20MHz, 160MHz Punctured by 40MHz
Modulation Technology	IEEE 802.11a: OFDM IEEE 802.11ax/be: OFDMA
Transfer Rate	IEEE 802.11a: 54/48/36/24/18/12/9/6 Mbps IEEE 802.11ax: up to 2401.9 Mbps IEEE 802.11be: up to 5764.8 Mbps
Test Software Version	QRCT4
Test Model	RZ09-0508
Sample Status	Engineering Sample
EUT Modification(s)	N/A

**NOTE:**

- (1) The above EUT information is declared by manufacturer and for more detailed features description, please refers to the manufacturer's specifications or user's manual.

## (2) Channel List:

UNII-5							
IEEE 802.11a IEEE 802.11ax(HE20) IEEE 802.11be(EHT20)		IEEE 802.11ax(HE40) IEEE 802.11be(EHT40)		IEEE 802.11ax(HE80) IEEE 802.11be(EHT80)		IEEE 802.11ax(HE160) IEEE 802.11be(EHT160)	
Channel	Frequency (MHz)	Channel	Frequency (MHz)	Channel	Frequency (MHz)	Channel	Frequency (MHz)
1	5955	3	5965	7	5985	15	6025
5	5975	11	6005	23	6065	47	6185
9	5995	19	6045	39	6145	79	6345
13	6015	27	6085	55	6225		
17	6035	35	6125	71	6305		
21	6055	43	6165	87	6385		
25	6075	51	6205				
29	6095	59	6245				
33	6115	67	6285				
37	6135	75	6325				
41	6155	83	6365				
45	6175	91	6405				
49	6195						
53	6215						
57	6235						
61	6255						
65	6275						
69	6295						
73	6315						
77	6335						
81	6355						
85	6375						
89	6395						
93	6415						

UNII-5			
IEEE 802.11be(EHT320)		IEEE 802.11be(EHT320)	
Channel	Frequency (MHz)	Channel	Frequency (MHz)
31	6105	63	6265

UNII-6							
IEEE 802.11a IEEE 802.11ax(HE20) IEEE 802.11be(EHT20)		IEEE 802.11ax(HE40) IEEE 802.11be(EHT40)		IEEE 802.11ax(HE80) IEEE 802.11be(EHT80)		IEEE 802.11ax(HE160) IEEE 802.11be(EHT160)	
Channel	Frequency (MHz)	Channel	Frequency (MHz)	Channel	Frequency (MHz)	Channel	Frequency (MHz)
97	6435	99	6445	103	6465	111	6505
101	6455	107	6485				
105	6475						
109	6495						
113	6515						



UNII-7							
IEEE 802.11a IEEE 802.11ax(HE20) IEEE 802.11be(EHT20)		IEEE 802.11ax(HE40) IEEE 802.11be(EHT40)		IEEE 802.11ax(HE80) IEEE 802.11be(EHT80)		IEEE 802.11ax(HE160) IEEE 802.11be(EHT160)	
Channel	Frequency (MHz)	Channel	Frequency (MHz)	Channel	Frequency (MHz)	Channel	Frequency (MHz)
117	6535	115	6525	119	6545	143	6665
121	6555	123	6565	135	6625	175	6825
125	6575	131	6605	151	6705		
129	6595	139	6645	167	6785		
133	6615	147	6685	183	6865		
137	6635	155	6725				
141	6655	163	6765				
145	6675	171	6805				
149	6695	179	6845				
153	6715						
157	6735						
161	6755						
165	6775						
169	6795						
173	6815						
177	6835						
181	6855						

UNII-8							
IEEE 802.11a IEEE 802.11ax(HE20) IEEE 802.11be(EHT20)		IEEE 802.11ax(HE40) IEEE 802.11be(EHT40)		IEEE 802.11ax(HE80) IEEE 802.11be(EHT80)		IEEE 802.11ax(HE160) IEEE 802.11be(EHT160)	
Channel	Frequency (MHz)	Channel	Frequency (MHz)	Channel	Frequency (MHz)	Channel	Frequency (MHz)
185	6875	187	6885	199	6945	207	6985
189	6895	195	6925	215	7025		
193	6915	203	6965				
197	6935	211	7005				
201	6955	219	7045				
205	6975	227	7085				
209	6995						
213	7015						
217	7035						
221	7055						
225	7075						
229	7095						
233	7115						

IEEE 802.11ax (HEW320)					
Band	Channel	Frequency (MHz)	Band	Channel	Frequency (MHz)
5	31	6105	5	63	6265
5+6+7	95	6425	6+7	127	6585
7+8	159	6745	7+8	191	6905

## (3) Table for Filed Antenna:

Ant.	Manufacturer	P/N	Antenna Type	Connector	Gain (dBi)
1	Amphenol	BY507A-16-001-C	PIFA	IPEX	4.38
2	Amphenol	BY507A-16-002-C	PIFA	IPEX	3.39

Note:

- 1) This EUT supports MIMO 2X2, any transmit signals are correlated with each other, so Directional gain =  $10\log[(10^{G1/10} + 10^{G2/10} + \dots + 10^{GN/10})^2 / N]$  dBi, that is Directional gain =  $10\log[(10^{4.38/10} + 10^{3.39/10})^2 / 2]$  dBi = 6.91.
- 2) Ant.1 refers to Main Antenna; Ant.2 refers to Aux Antenna.
- 3) The above Antenna information are derived from the antenna data sheet provided by manufacturer and for more detailed features description, please refer to the manufacturer's specifications, the laboratory shall not be held responsible.

## (4) Operating Mode and Antenna Configuration

TX Mode \ Operating Mode	1 TX / 2 TX
IEEE 802.11a	V (Ant. 1 or Ant. 2)
IEEE 802.11ax(HE20)	V (Ant. 1+Ant. 2)
IEEE 802.11ax(HE40)	V (Ant. 1+Ant. 2)
IEEE 802.11ax(HE80)	V (Ant. 1+Ant. 2)
IEEE 802.11ax(HE160)	V (Ant. 1+Ant. 2)
IEEE 802.11be(EHT20)	V (Ant. 1+Ant. 2)
IEEE 802.11be(EHT40)	V (Ant. 1+Ant. 2)
IEEE 802.11be(EHT80)	V (Ant. 1+Ant. 2)
IEEE 802.11be(EHT160)	V (Ant. 1+Ant. 2)
IEEE 802.11be(EHT320)	V (Ant. 1+Ant. 2)

## 2.2 TEST MODES

Test Items	Test mode	Channel	Note
AC power line conducted emissions	Normal/Idle	-	-
Undesirable emissions (below 1GHz)	IEEE 802.11be (EHT320)	31	-
Undesirable emissions (above 1GHz)	IEEE 802.11be (EHT320)	31	Bandedge
	IEEE 802.11be (EHT320)	31	Harmonic
Contention Based Protocol	IEEE 802.11be (EHT320)	63/95/127/191	-

**NOTE:**

- (1) For radiated emission band edge test, both Vertical and Horizontal are evaluated, but only the worst case (Horizontal) is recorded.

### 2.3 TESTED CONFIGURATION DIAGRAM

Equipment letters and Cable numbers refer to item numbers described in the tables of clause 2.4.

Undesirable emissions

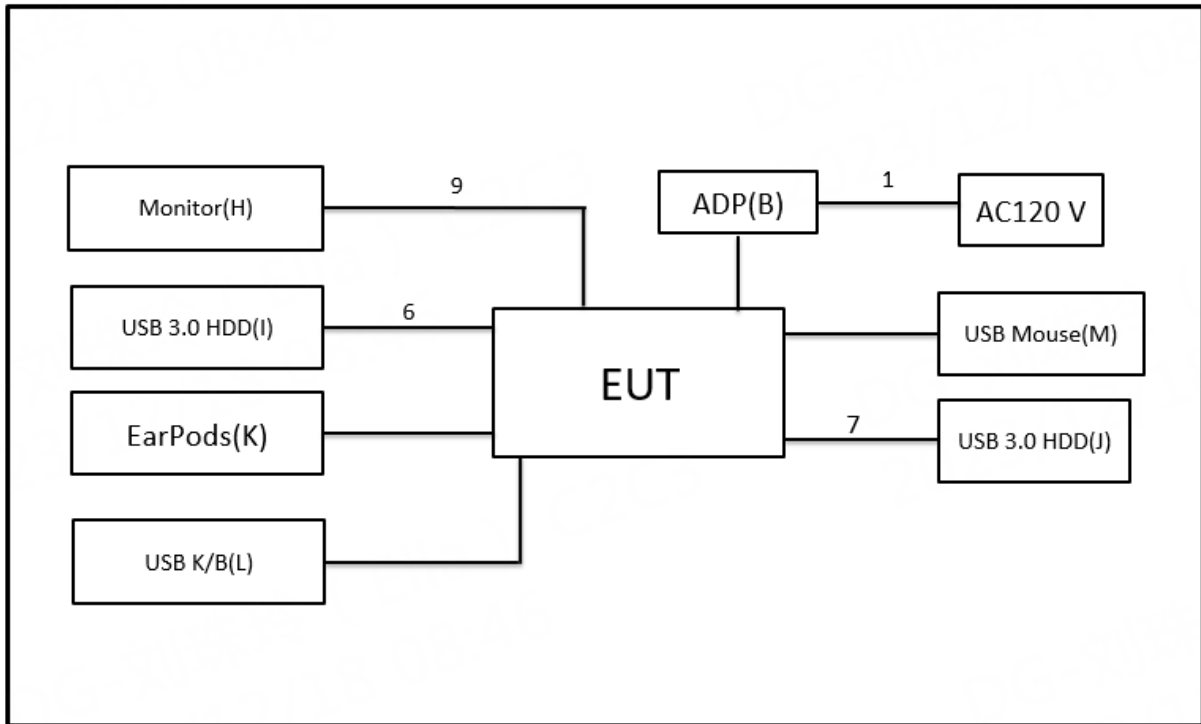

AC power line conducted emissions

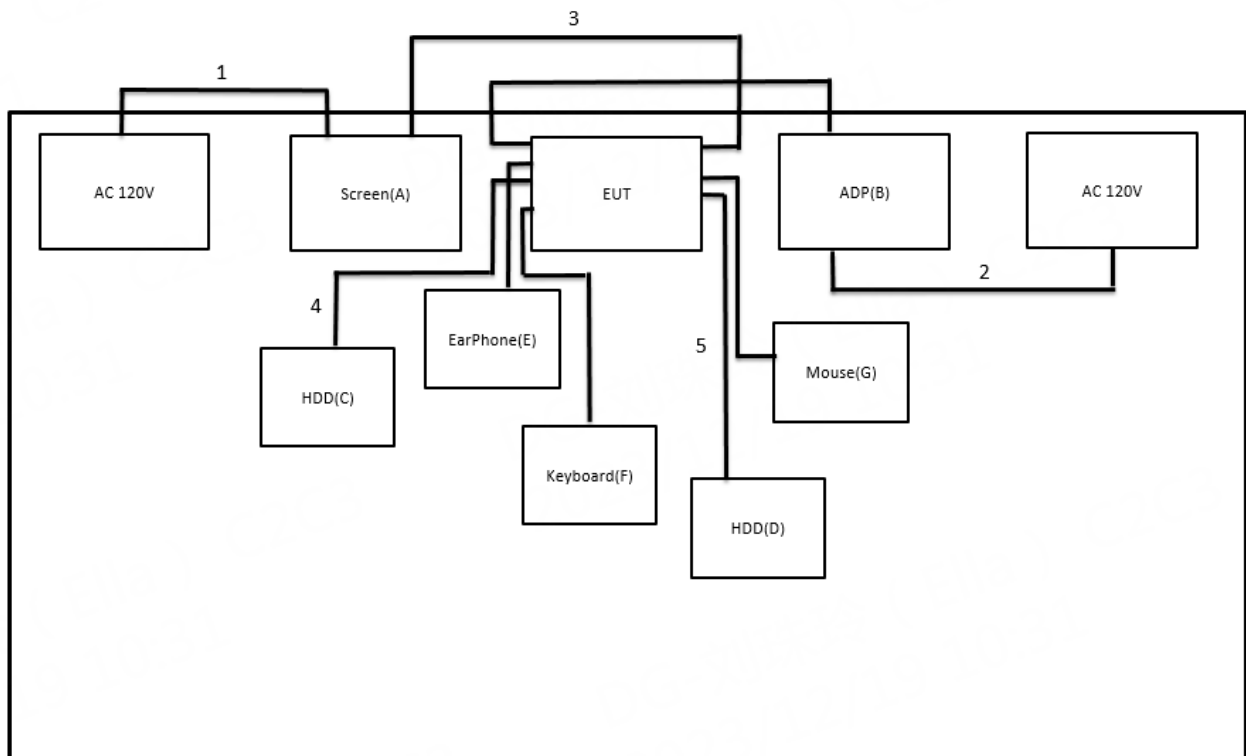

**2.4 SUPPORT UNITS**

Item	Equipment	Brand	Model No.	Series No.	Remarks
A	Screen	Dell	P2723QE	N/A	Furnished by test lab.
B	ADP	Razer Inc	RC30-024801	N/A	Supplied by test requester.
C	HDD	WD	WD My Passport Ultra	N/A	Furnished by test lab.
D	HDD	WD	WX42AA1EZ02A	N/A	Furnished by test lab.
E	Earphone	N/A	N/A	N/A	Furnished by test lab.
F	Keyboard	Dell	USB DELL K/B	N/A	Furnished by test lab.
G	Mouse	Lenovo	SM-8823	N/A	Furnished by test lab.
H	Monitor	Dell	U2720QM	N/A	Furnished by test lab.
I	HDD	TOSIBA	XS700	483B60D7KQSS	Furnished by test lab.
J	HDD	TOSIBA	XS700	483B60LYKQSS	Furnished by test lab.
K	Earphone	HTC	N/A	N/A	Furnished by test lab.
L	Keyboard	Bloody	KB-8	N/A	Furnished by test lab.
M	Mouse	Lenovo	SM-8823	N/A	Furnished by test lab.

Item	Shielded	Ferrite Core	Length	Cable Type	Remarks
1	N/A	N/A	1m	Power Cord	Furnished by test lab.
2	N/A	N/A	0.3m	Power Cord	Supplied by test requester.
3	N/A	N/A	1m	HDMI Cable	Furnished by test lab.
4	N/A	N/A	0.25m	USB-C to USB-C	Furnished by test lab.
5	N/A	N/A	0.5m	USB-C to USB-C	Furnished by test lab.
6	N/A	N/A	1.5m	Type C to Type C Cable	Furnished by test lab.
7	N/A	N/A	1.5m	Type C to Type C Cable	Furnished by test lab.
8	N/A	N/A	1m	Power Cord	Supplied by test requester.
9	N/A	N/A	1.8m	HDMI Cable	Furnished by test lab.

### 3 UNDESIRABLE EMISSIONS TEST

#### 3.1 LIMITS

According to 15.407(b)(6) the limits are as follows:

For transmitters operating within the 5.925-7.125 GHz band: Any emissions outside of the 5.925-7.125 GHz band must not exceed an e.i.r.p. of -27 dBm/MHz.

According to FCC KDB 987594 D02, clause G. Unwanted Emission Measurement:

Use guidance in KDB 789033 for measurements below 1000 MHz and above 1000 MHz. Unwanted emissions outside of restricted bands are measured with a RMS detector. In addition, 15.35(b) applies where the peak emissions must be limited to no more than 20 dB above the average limit

Item	Maximum e.i.r.p. Limit	Maximum field strength Limit @ 3m
Any emissions outside of the 5.925-7.125 GHz band	Peak: -7 dBm/MHz	88.2 dBuV/m
	Average: -27 dBm/MHz	68.2 dBuV/m

Unwanted emissions below 1 GHz must comply with the general field strength limits set forth in § 15.209.

Frequency (MHz)	Field Strength (microvolts/meter)	Measurement Distance (meters)
0.009~0.490	2400/F(kHz)	300
0.490~1.705	24000/F(kHz)	30
1.705~30.0	30	30
30~88	100	3
88~216	150	3
216~960	200	3
960~1000	500	3

According to 15.407(b)(9) the limits are as follows:

Unwanted emissions below 1 GHz must comply with the general field strength limits set forth in § 15.209.

Frequency (MHz)	Field Strength (microvolts/meter)	Measurement Distance (meters)
0.009~0.490	2400/F(kHz)	300
0.490~1.705	24000/F(kHz)	30
1.705~30.0	30	30
30~88	100	3
88~216	150	3
216~960	200	3
960~1000	500	3

**NOTE:**

(1) e.i.r.p. Limit (dBuV/m at 3m) = Power Limit(dBm) + 95.2. (Referring to FCC KDB 987594 D02, clause G.2.d)(iii))

(2) Emission level (dBuV/m) = 20log Emission level (uV/m).  
3 m Emission level = 10 m Emission level + 20log(10 m/3 m).

(3) The test result calculated as following:

Measurement Value = Reading Level + Correct Factor

Correct Factor = Antenna Factor + Cable Loss - Amplifier Gain (if use)

Margin Level = Measurement Value - Limit Value

Calculation example:

Reading Level (dBuV)		Correct Factor (dB)		Measurement Value (dBuV/m)
19.11	+	2.11	=	21.22

Measurement Value (dBuV/m)		Limit Value (dBuV/m)		Margin Level (dB)
21.22	-	68.2	=	-46.98

Spectrum Parameter	Setting
Attenuation	Auto
Start Frequency	1000 MHz
Stop Frequency	10th carrier harmonic
RBW / VBW (Emission in restricted band)	1MHz / 3MHz for Peak, 1MHz / 1/T for Average

Spectrum Parameter	Setting
Attenuation	Auto
Start ~ Stop Frequency	9KHz~90KHz for PK/AVG detector
Start ~ Stop Frequency	90KHz~110KHz for QP detector
Start ~ Stop Frequency	110KHz~490KHz for PK/AVG detector
Start ~ Stop Frequency	490KHz~30MHz for QP detector
Start ~ Stop Frequency	30MHz~1000MHz for QP detector

### 3.2 TEST PROCEDURE

Referring to FCC KDB 987594 D02, clause G. and FCC KDB 789033 D02, clause G. Unwanted Emission Measurement:

For measurements below 30 MHz:

- a. The EUT was placed on the top of a rotating table 0.8 meters above the ground at a 3 meter chamber room. The table was rotated 360 degrees to determine the position of the highest radiation.
- b. The EUT was set 3 meters away from the interference-receiving antenna, which was mounted on the top of a variable-height antenna tower.
- c. Parallel, perpendicular, and ground-parallel orientations of the antenna are set to make the measurement.
- d. For each suspected emission, the EUT was arranged to its worst case and the rotatable table was turned from 0 degrees to 360 degrees to find the maximum reading.
- e. The test-receiver system was set to Quasi-Peak Detect Function and Specified Bandwidth with Maximum Hold Mode.

For measurements 30 MHz to 40 GHz:

- a. The measuring distance of 3 m shall be used for measurements. The EUT was placed on the top of a rotating table 0.8 meter above the ground at a 3 meter semi-anechoic chamber. The table was rotated 360 degrees to determine the position of the highest radiation. (between 30 MHz to 1 GHz)
- b. The measuring distance of 3 m shall be used for measurements. The EUT was placed on the top of a rotating table 1.5 meter above the ground at a 3 meter semi-anechoic chamber. The table was rotated 360 degrees to determine the position of the highest radiation. (between 1 GHz to 40 GHz)
- c. The height of the equipment or of the substitution antenna shall be 0.8 m or 1.5 m, the height of the test antenna shall vary between 1 m to 4 m. Both horizontal and vertical polarizations of the antenna are set to make the measurement.
- d. For each suspected emission, the EUT was arranged to its worst case and then the antenna was tuned to heights find the maximum reading (used Bore sight function).
- e. The receiver system was set to peak and average detect function and specified bandwidth with maximum hold mode when the test frequency is above 1GHz.
- f. The initial step in collecting radiated emission data is a receiver peak detector mode pre-scanning the measurement frequency range. Significant peaks are then marked and then Quasi Peak detector mode re-measured.
- g. All readings are Peak unless otherwise stated QP in column of Note. Peak denotes that the Peak reading compliance with the QP Limits and then QP Mode measurement didn't perform. (between 30 MHz to 1 GHz)
- h. All readings are Peak Mode value unless otherwise stated AVG in column of Note. If the Peak Mode Measured value compliance with the Peak Limits and lower than AVG Limits, the EUT shall be deemed to meet both Peak & AVG Limits and then only Peak Mode was measured, but AVG Mode didn't perform. (between 30 MHz to 1 GHz)

### 3.3 DEVIATION FROM TEST STANDARD

No deviation.

### 3.4 TEST SETUP

9 kHz to 30 MHz

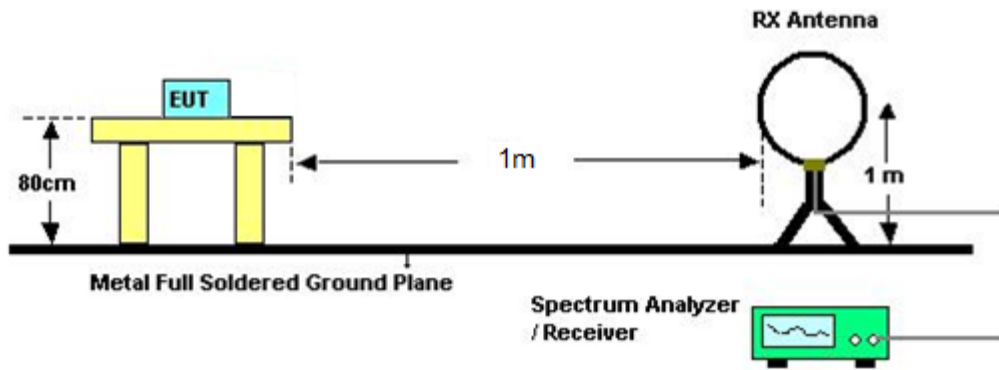

30 MHz to 1 GHz

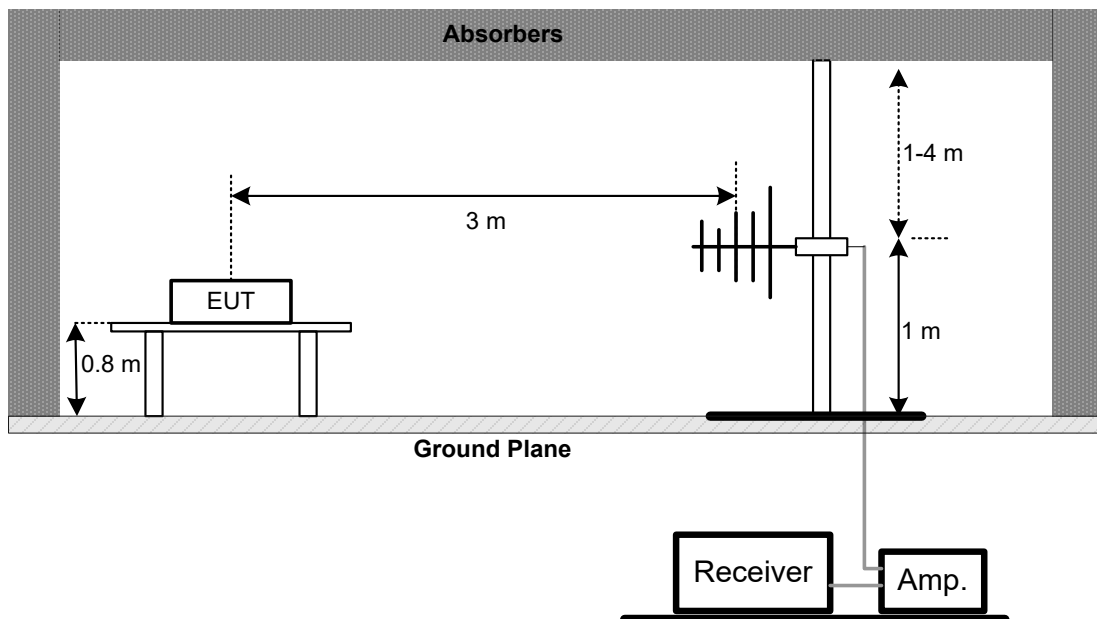



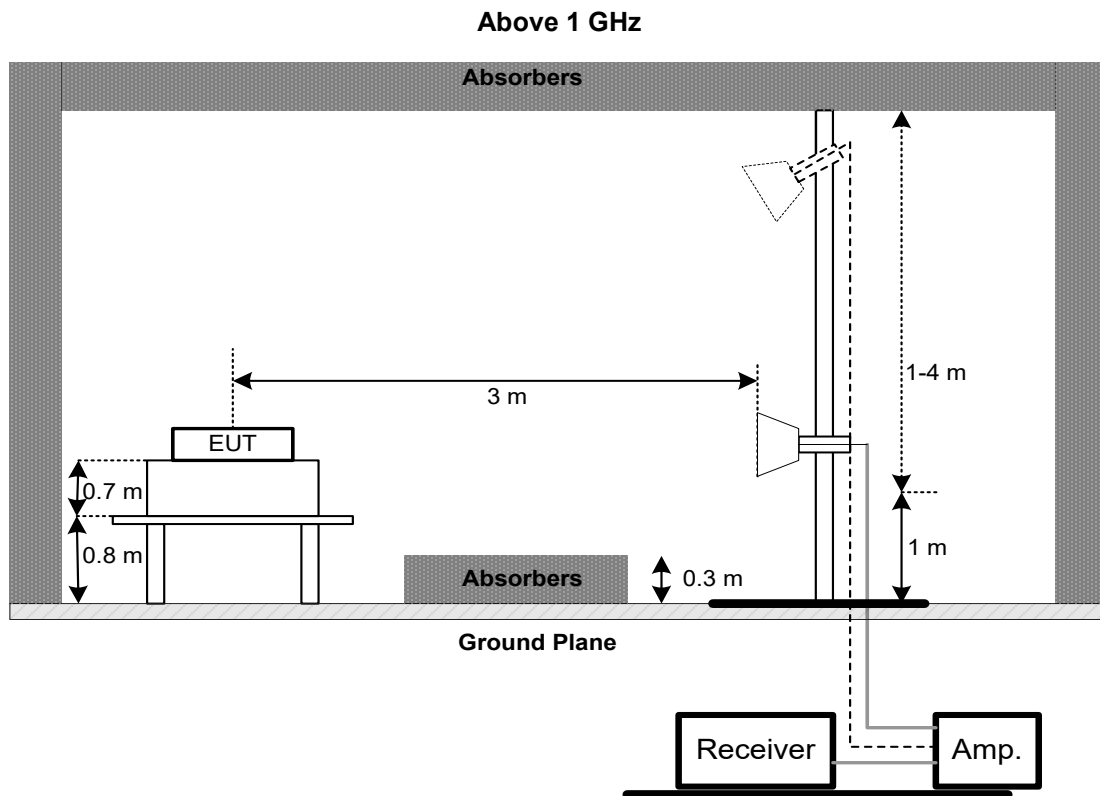

### 3.5 EUT OPERATING CONDITIONS

The EUT was programmed to be in continuously transmitting mode.

**NOTE:**

- (1) Distance extrapolation factor =  $40 \log (\text{specific distance} / \text{test distance})$  (dB).
- (2) Limit line = specific limits (dBuV) + distance extrapolation factor.

### 3.6 TEST RESULT – BELOW 30 MHZ

There were no emissions found below 30 MHz within 20 dB of the limit.

### 3.7 TEST RESULT – 30 MHZ TO 1 GHZ

Please refer to the APPENDIX A.

### 3.8 TEST RESULT – ABOVE 1 GHZ

Please refer to the APPENDIX B.

## 4 AC POWER LINE CONDUCTED EMISSIONS TEST

### 4.1 LIMITS

According to 15.407(b)(9) the limits are as follows:

Frequency (MHz)	Limit (dB $\mu$ V)	
	Quasi-peak	Average
0.15 - 0.5	66 - 56 *	56 - 46 *
0.50 - 5.0	56	46
5.0 - 30.0	60	50

NOTE:

- (1) The tighter limit applies at the band edges.
- (2) The limit of " \* " marked band means the limitation decreases linearly with the logarithm of the frequency in the range.
- (3) The test result calculated as following:

Measurement Value = Reading Level + Correct Factor

Correct Factor = Insertion Loss + Cable Loss + Attenuator Factor (if use)

Margin Level = Measurement Value – Limit Value

Calculation example:

Reading Level (dB $\mu$ V)		Correct Factor (dB)		Measurement Value (dB $\mu$ V)
38.22	+	3.45	=	41.67

Measurement Value (dB $\mu$ V)		Limit Value (dB $\mu$ V)		Margin Level (dB)
41.67	-	60	=	-18.33

The following table is the setting of the receiver.

Receiver Parameter	Setting
Attenuation	10 dB
Start Frequency	0.15 MHz
Stop Frequency	30 MHz
IF Bandwidth	9 KHz

### 4.2 TEST PROCEDURE

- a. The EUT was placed 0.8 m above the horizontal ground plane with the EUT being connected to the power mains through a line impedance stabilization network (LISN).  
All other support equipment were powered from an additional LISN(s).  
The LISN provides 50 Ohm/50 $\mu$ H of impedance for the measuring instrument.
- b. Interconnecting cables that hang closer than 40 cm to the ground plane shall be folded back and forth in the center forming a bundle to keep the cable above 40 cm.
- c. Excess I/O cables that are not connected to a peripheral shall be bundled in the center.  
The end of the cable will be terminated, using the correct terminating impedance.  
The overall length shall not exceed 1 m.
- d. The LISN is spaced at least 80 cm from the nearest part of the EUT chassis.
- e. For the actual test configuration, please refer to the related Item – EUT TEST PHOTOS.

NOTE:

- (1) In the results, each reading is marked as Peak, QP or AVG per the detector used.  
BW=9 kHz (6 dB Bandwidth)
- (2) All readings are Peak unless otherwise stated QP or AVG in column of Note. Both the QP and the AVG readings must be less than the limit for compliance.

#### 4.3 DEVIATION FROM TEST STANDARD

No deviation.

#### 4.4 TEST SETUP

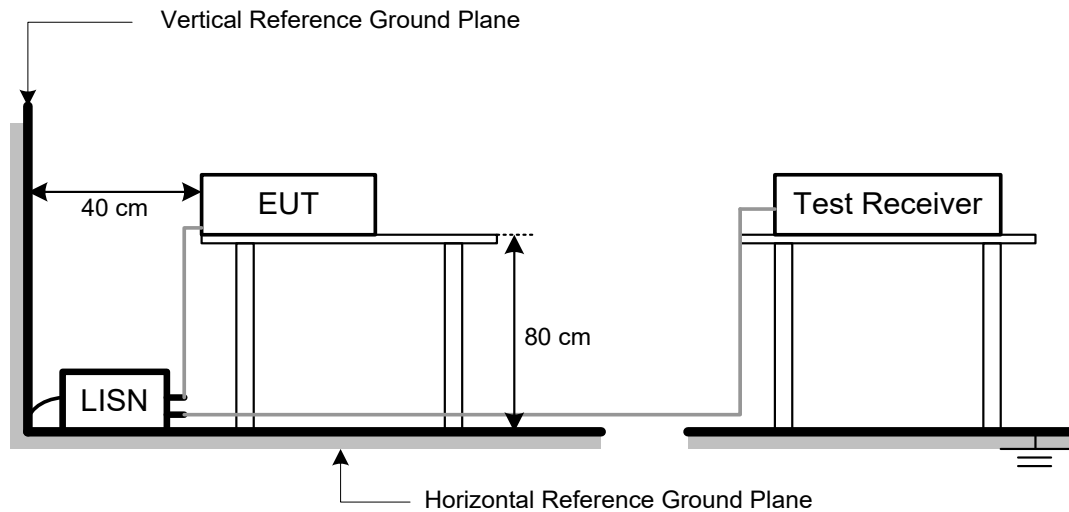

#### 4.5 EUT OPERATING CONDITIONS

The EUT was configured for testing in a typical fashion (as a customer would normally use it). The EUT has been programmed to continuously transmit during test. This operating condition was tested and used to collect the included data.

The EUT was programmed to be in continuously transmitting/TX mode.

#### 4.6 TEST RESULT

Please refer to the APPENDIX C.

## 5 CONTENTION BASED PROTOCOL

### 5.1 LIMIT

Indoor access points, subordinate devices and client devices operating in the 5.925-7.125 GHz band (herein referred to as unlicensed devices) are required to use technologies that include a contention-based protocol to avoid co-channel interference with incumbent devices sharing the band. To ensure incumbent co-channel operations are detected in a technology-agnostic manner, unlicensed devices are required to detect co-channel radio frequency energy (energy detect) and avoid simultaneous transmission.

Unlicensed low-power indoor devices must detect co-channel radio frequency power that is at least -62 dBm or lower. Upon detection of energy in the band, unlicensed low power indoor devices must vacate the channel and stay off the channel as long as detected radio frequency power is equal to or greater than the threshold (-62 dBm). The -62 dBm (or lower) threshold is referenced to a 0 dBi antenna gain. (See note) To ensure incumbent operations are reliably detected in the band, low power indoor devices must detect RF energy throughout their intended operating channel. For example, an 802.11 device that plans to transmit a 40 MHz- wide signal (on a primary 20 MHz channel and a secondary 20 MHz channel) must detect energy throughout the entire 40 MHz channel. Additionally, low-power indoor devices must detect co-channel energy with 90% or greater certainty.

Note: The EUT with a lowest gain is 3.39dBi. All power injected into EUT should be  $-62+3.39=-58.61$ dBm.

### 5.2 TEST PROCEDURE

- a. Number of times detection threshold:

If	Number of Tests	Placement of Incumbent Transmission
$BW_{EUT} \leq BW_{Inc}$	Once	Tune incumbent and EUT transmissions ( $f_{c1}=f_{c2}$ )
$BW_{Inc} < BW_{EUT} \leq 2BW_{Inc}$	Once	Incumbent transmission is contained within $BW_{EUT}$
$2BW_{Inc} < BW_{EUT} \leq 4BW_{Inc}$	Twice. Incumbent transmission is contained within $BW_{EUT}$	Incumbent transmission is located as closely as possible to the lower edge and upper edge, respectively, of the EUT channel
$BW_{EUT} > 4BW_{Inc}$	Three times	Incumbent transmission is located as closely as possible to the lower edge of the EUT channel, in the middle of EUT channel, and as closely as possible to the upper edge of the EUT channel

Where:

$BW_{EUT}$ : Transmission bandwidth of EUT signal.

$BW_{Inc}$ : Transmission bandwidth of the simulated incumbent signal (10 MHz wide AWGN signal).

$f_{c1}$ : Center frequency of EUT transmission.

$f_{c2}$ : Center frequency of simulated incumbent signal.

- Using an AWGN signal source, generate (but do not transmit, i.e., RF OFF) a 10 MHz-wide AWGN signal. Use step b table to determine the center frequency of the 10 MHz AWGN signal relative to the EUT's channel bandwidth and center frequency.
- Set the AWGN signal power to an extremely low level (more than 20 dB below the -62 dBm threshold). Connect the AWGN signal source, via a 3-dB splitter, to the signal analyzer and the EUT as show in the block diagram below.
- Transmit the AWGN signal (RF ON) and verify its characteristics on the signal analyzer.
- Monitor the signal analyzer to verify if the AWGN signal has been detected and the EUT has ceased transmission. If the EUT continues to transmit, then incrementally increase the AWGN signal power level until the EUT stops transmitting.

- f. (Including all losses in the RF paths) Determine and record the AWGN signal power level (at the EUT's antenna port) at which the EUT ceased transmission. Repeat the procedure at least 10 times to verify the EUT can detect an AWGN signal with 90% (or better) level of certainty.
- g. Refer to step b table to determine number of times the detection threshold testing needs to be repeated. If testing is required more than once, then go back to step c, choose a different center frequency for the AWGN signal and repeat the process.

### 5.3 DEVIATION FROM STANDARD

No deviation.

### 5.4 TEST SETUP

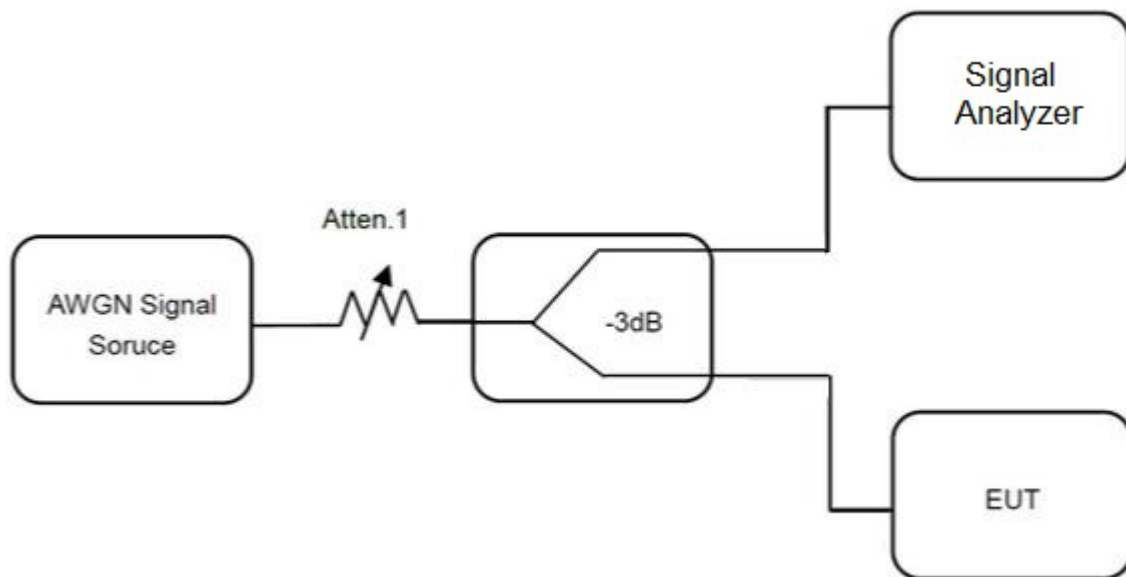

### 5.5 EUT OPERATION CONDITIONS

The EUT was Configured to be in normally transmitting mode with a constant duty cycle.

### 5.6 TEST RESULTS

Please refer to the APPENDIX D.

## 6 LIST OF MEASURING EQUIPMENTS

Undesirable Emissions						
Item	Kind of Equipment	Manufacturer	Type No.	Serial No.	Calibrated Date	Calibrated Until
1	Preamplifier	EMCI	EMC330N	980850	2023/11/23	2024/9/5
2	Preamplifier	EMCI	EMC118A45SE	980819	2023/3/7	2024/3/6
3	Pre-Amplifier	EMCI	EMC184045SE	980907	2023/9/21	2024/9/20
4	Preamplifier	EMCI	EMC001340	980579	2023/11/23	2024/9/5
5	Test Cable	EMCI	EMC104-SM-1000	180809	2023/7/10	2024/7/9
6	Test Cable	EMCI	EMC104-SM-SM-3000	220322	2023/3/14	2024/3/13
7	Test Cable	EMCI	EMC104-SM-SM-7000	220324	2023/3/14	2024/3/13
8	EXA Signal Analyzer	keysight	N9020B	MY57120120	2023/2/24	2024/2/23
9	Loop Ant	Electro-Metrics	EMCI-LPA600	291	2023/11/232	2024/9/11
10	Horn Antenna	RFSPIN	DRH18-E	211202A18EN	2023/5/12	2024/5/11
11	Horn Ant	Schwarzbeck	BBHA 9170D	1136	2023/5/12	2024/5/11
12	Log-bicon Antenna	Schwarzbeck	VULB9168	1369	2023/5/9	2024/5/8
13	6dB Attenuator	EMCI	EMCI-N-6-06	AT-06001	2023/5/9	2024/5/8
14	Test Cable	EMCI	EMC101G-KM-KM-3000	220329	2023/3/14	2024/3/13
15	Test Cable	EMCI	EMC102-KM-KM-1000	220327	2023/3/14	2024/3/13
16	Measurement Software	EZ	EZ EMC (Version NB-03A1-01)	N/A	N/A	N/A

AC Power Line Conducted Emissions						
Item	Kind of Equipment	Manufacturer	Type No.	Serial No.	Calibrated Date	Calibrated Until
1	TWO-LINE V-NETWORK	R&S	ENV216	101521	2023/11/233	2024/9/12
2	Test Cable	EMCI	EMCCFD300-BM-BMR-5000	220331	2023/3/30	2024/3/29
3	EMI Test Receiver	R&S	ESCI	100080	2023/6/26	2024/6/25
4	Measurement Software	EZ	EZ EMC (Version NB-03A1-01)	N/A	N/A	N/A

<b>Contention Based Protocol</b>						
Item	Kind of Equipment	Manufacturer	Type No.	Serial No.	Calibrated Date	Calibrated Until
1	Spectrum Analyzer	Keysight	N9010A	MY54200240	2023/6/26	2024/6/25
2	MXG Vector Signal Generator	Agilent	N5182B	MY51350711	2023/2/21	2024/2/20
3	Frequency Extender	Keysight	N5182BX07	MY59360246	2023/2/21	2024/2/20
4	Peak Power Analyzer	Keysight	8990B	MY51000517	2023/3/15	2024/3/14
5	Power Sensor	Keysight	N1923A	MY58310005	2023/3/15	2024/3/14
6	Spectrum Analyzer	R&S	FSP 40	101139	2023/3/9	2024/3/8

Remark: "N/A" denotes no model name, no serial no. or no calibration specified.  
All calibration period of equipment list is one year.

**7 EUT TEST PHOTOS**

Please refer to document Appendix No.: TP-2309C037A-FCCP-1 (APPENDIX-TEST PHOTOS).

**8 EUT PHOTOS**

Please refer to document Appendix No.: EP-2309C037A-1 (APPENDIX-EUT PHOTOS).



## **APPENDIX A UNDESIRABLE EMISSIONS - 30 MHZ TO 1 GHZ**

Test Mode	IEEE 802.11be (EHT320)	Test Date	2023/11/23
Test Frequency	6105MHz	Polarization	Vertical

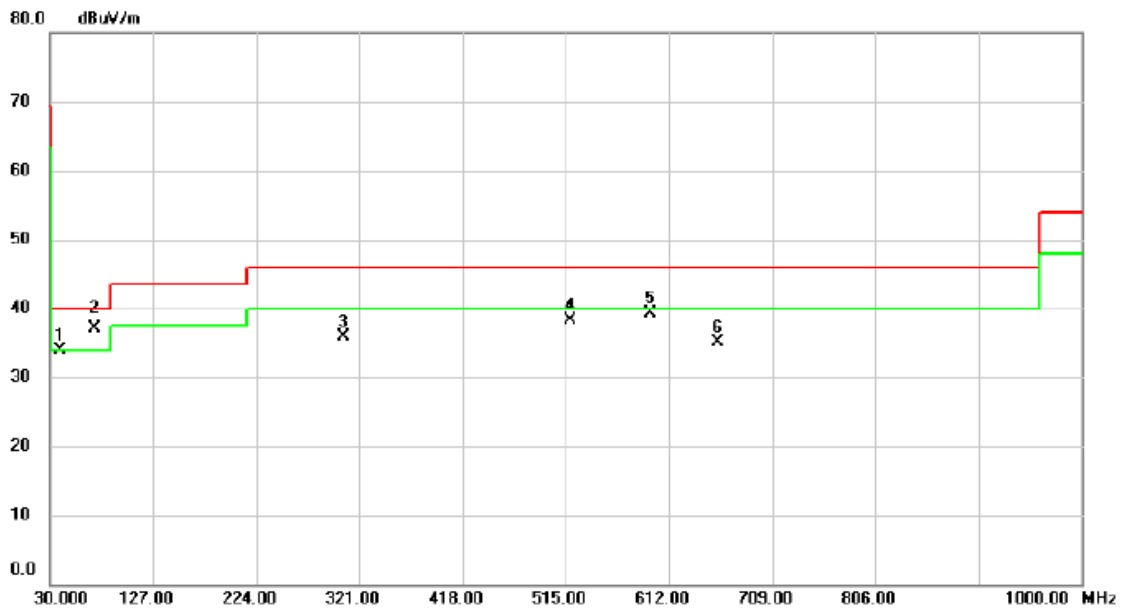

No.	Mk.	Freq. MHz	Reading Level dBuV	Correct Factor dB	Measure- ment dBuV/m	Limit dBuV/m	Over dB	Detector	Comment
1		39.5060	45.52	-11.71	33.81	40.00	-6.19	peak	
2	*	71.6776	51.46	-14.43	37.03	40.00	-2.97	QP	
3		306.0620	47.14	-11.15	35.99	46.00	-10.01	peak	
4		520.1733	44.25	-5.95	38.30	46.00	-7.70	peak	
5		593.9903	43.42	-4.13	39.29	46.00	-6.71	peak	
6		657.9780	38.15	-3.11	35.04	46.00	-10.96	peak	

**REMARKS:**

- (1) Measurement Value = Reading Level + Correct Factor.
- (2) Margin Level = Measurement Value - Limit Value.

Test Mode	IEEE 802.11be (EHT320)	Test Date	2023/11/23
Test Frequency	6105MHz	Polarization	Horizontal

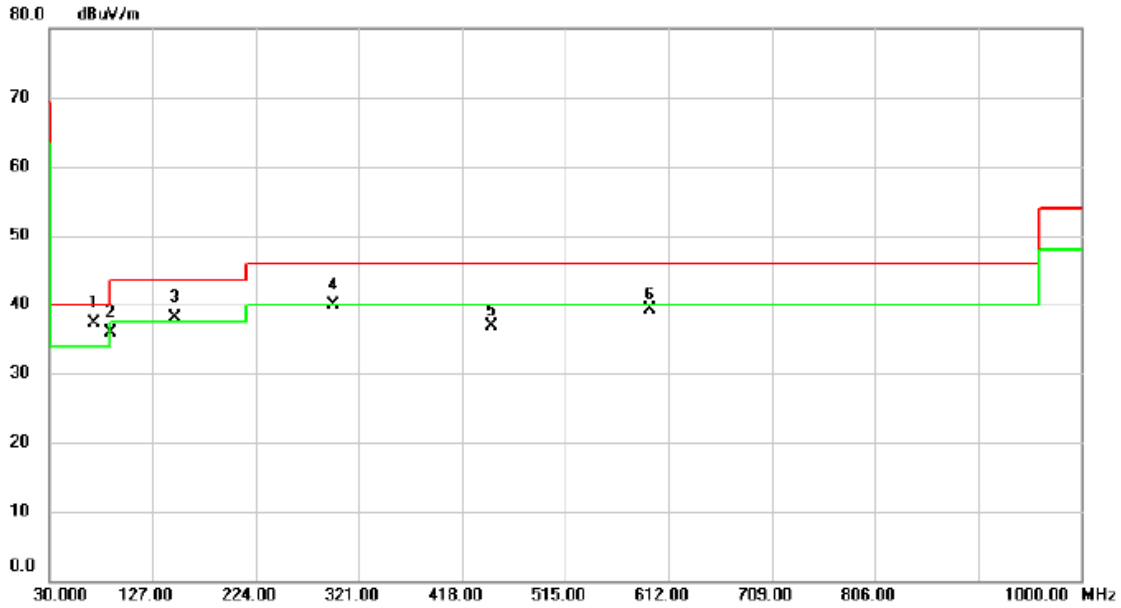

No.	Mk.	Freq. MHz	Reading Level dBuV	Correct Factor dB	Measure- ment dBuV/m	Limit dBuV/m	Over dB	Detector	Comment
1	*	71.8393	51.87	-14.47	37.40	40.00	-2.60	QP	
2	!	87.5210	53.24	-17.43	35.81	40.00	-4.19	QP	
3	!	148.5016	49.89	-11.88	38.01	43.50	-5.49	QP	
4		297.0087	51.24	-11.33	39.91	46.00	-6.09	QP	
5		445.5157	44.26	-7.29	36.97	46.00	-9.03	peak	
6		593.9903	43.36	-4.13	39.23	46.00	-6.77	peak	

**REMARKS:**

- (1) Measurement Value = Reading Level + Correct Factor.
- (2) Margin Level = Measurement Value - Limit Value.

## **APPENDIX B UNDESIRABLE EMISSIONS - ABOVE 1 GHZ**

Test Mode	IEEE 802.11be (EHT320)	Test Date	2023/11/23
Test Frequency	6105MHz	Polarization	Horizontal

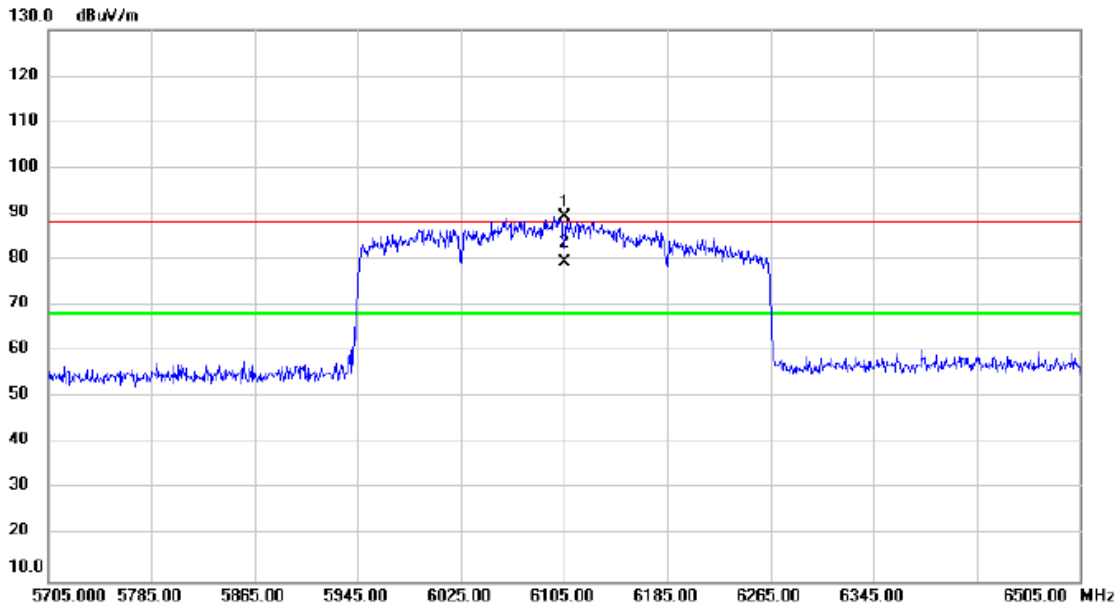

No.	Mk.	Freq.	Reading Level	Correct Factor	Measurement	Limit	Over	Detector	Comment
		MHz	dBuV	dB	dBuV/m	dBuV/m	dB		
1	X	6105.000	86.57	2.84	89.41	88.20	1.21	peak	No Limit
2	*	6105.000	76.70	2.84	79.54	68.20	11.34	AVG	No Limit

**REMARKS:**

- (1) Measurement Value = Reading Level + Correct Factor.
- (2) Margin Level = Measurement Value - Limit Value.

Test Mode	IEEE 802.11be (EHT320)	Test Date	2023/11/23
Test Frequency	6105MHz	Polarization	Vertical

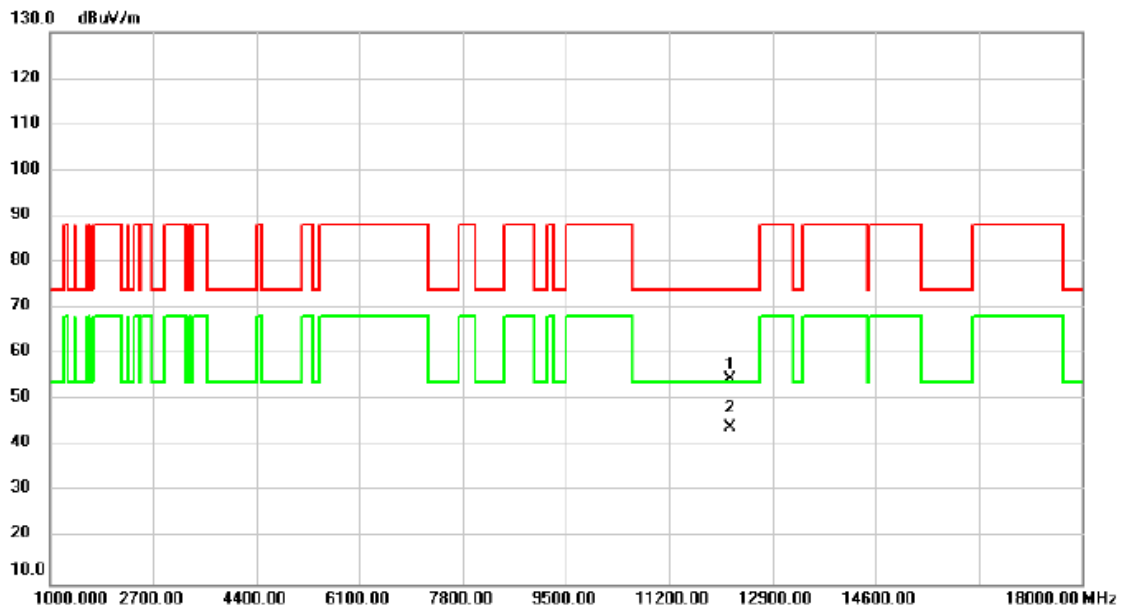

No.	Mk.	Freq. MHz	Reading Level dBuV	Correct Factor dB	Measure- ment dBuV/m	Limit dBuV/m	Over dB	Detector	Comment
1		12210.00	47.74	6.73	54.47	74.00	-19.53	peak	
2	*	12210.00	37.32	6.73	44.05	54.00	-9.95	AVG	

**REMARKS:**

- (1) Measurement Value = Reading Level + Correct Factor.
- (2) Margin Level = Measurement Value - Limit Value.

Test Mode	IEEE 802.11be (EHT320)	Test Date	2023/11/23
Test Frequency	6105MHz	Polarization	Horizontal

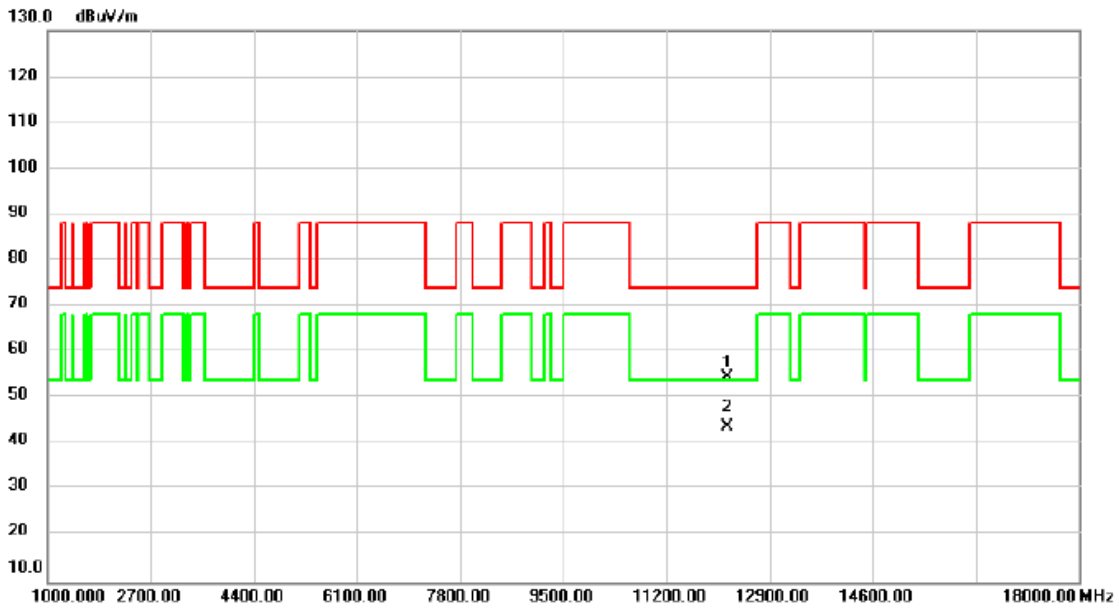

No.	Mk.	Freq.	Reading Level	Correct Factor	Measurement	Limit	Over	Detector	Comment
		MHz	dBuV	dB	dBuV/m	dBuV/m	dB		
1		12210.00	47.94	6.73	54.67	74.00	-19.33	peak	
2	*	12210.00	37.16	6.73	43.89	54.00	-10.11	AVG	

**REMARKS:**

- (1) Measurement Value = Reading Level + Correct Factor.
- (2) Margin Level = Measurement Value - Limit Value.

Test Mode	IEEE 802.11be (EHT320)	Test Date	2023/11/23
Test Frequency	6105MHz	Polarization	Vertical

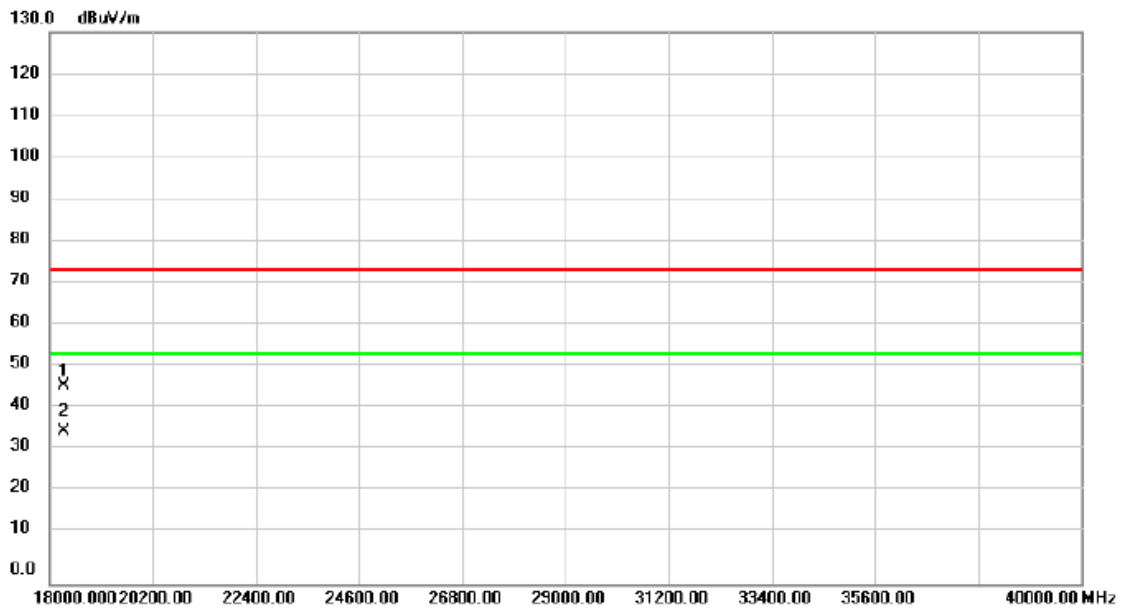

No.	Mk.	Freq.	Reading Level	Correct Factor	Measurement	Limit	Over	Detector	Comment
		MHz	dBuV	dB	dBuV/m	dBuV/m	dB		
1		18315.00	53.60	-7.07	46.53	74.00	-27.47	peak	
2	*	18315.00	42.86	-7.07	35.79	54.00	-18.21	AVG	

**REMARKS:**

- (1) Measurement Value = Reading Level + Correct Factor.
- (2) Margin Level = Measurement Value - Limit Value.



Test Mode	IEEE 802.11be (EHT320)	Test Date	2023/11/23
Test Frequency	6105MHz	Polarization	Horizontal

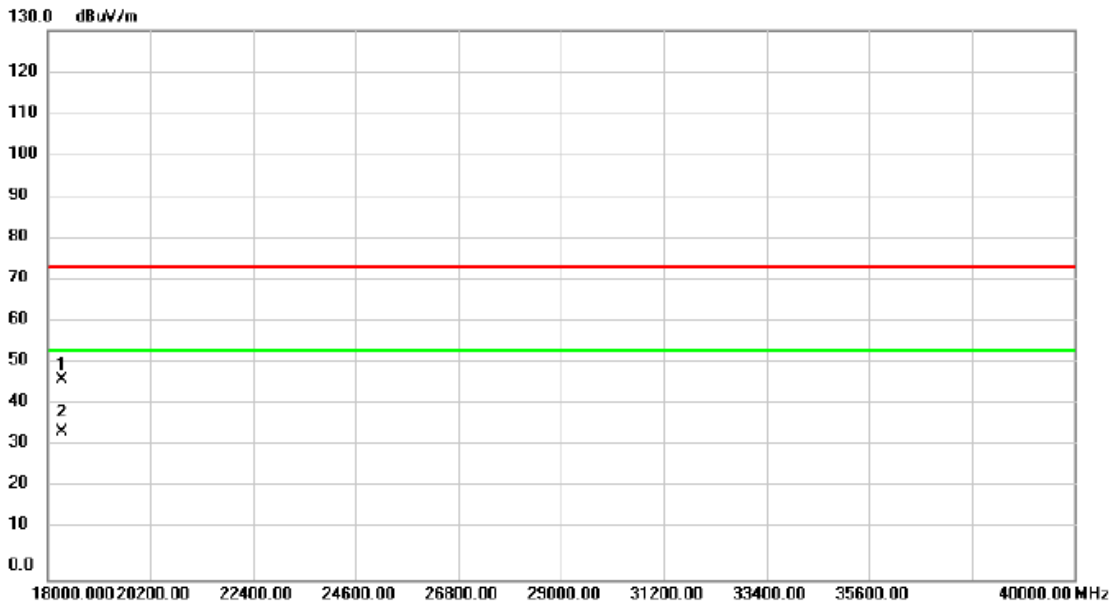

No.	Mk.	Freq.	Reading Level	Correct Factor	Measurement	Limit	Over	Detector	Comment
		MHz	dBuV	dB	dBuV/m	dBuV/m	dB		
1		18315.00	54.28	-7.07	47.21	74.00	-26.79	peak	
2	*	18315.00	42.13	-7.07	35.06	54.00	-18.94	AVG	

**REMARKS:**

- (1) Measurement Value = Reading Level + Correct Factor.
- (2) Margin Level = Measurement Value - Limit Value.

## APPENDIX C AC POWER LINE CONDUCTED EMISSIONS

Test Mode	Normal	Tested Date	2023/11/8
Test Frequency	-	Phase	Line

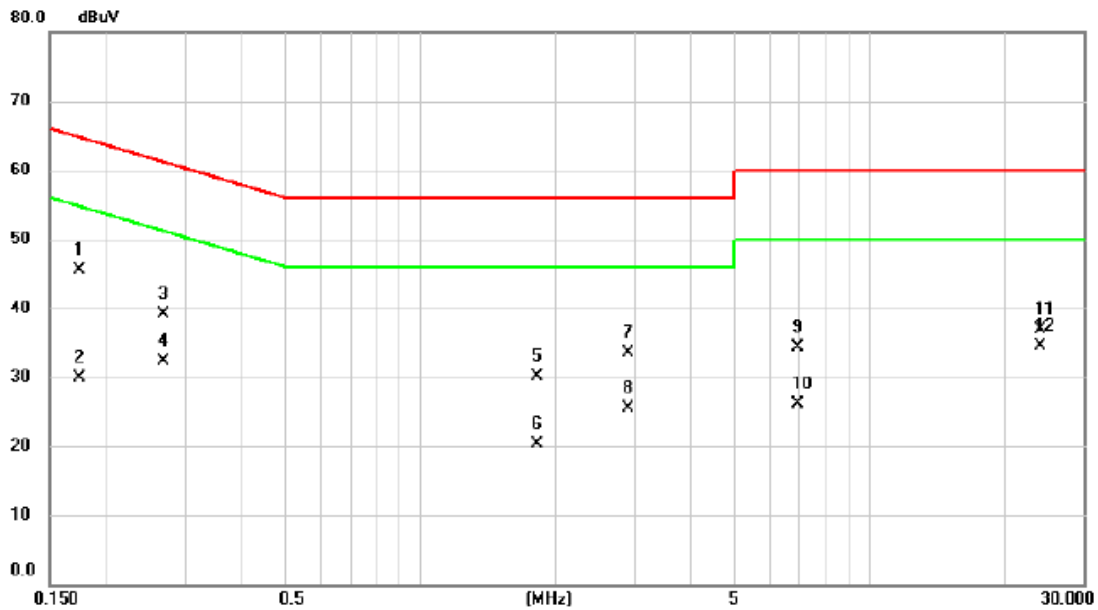

No.	Mk.	Freq. MHz	Reading Level dBuV	Correct Factor dB	Measure- ment dBuV	Limit dBuV	Margin dB	Detector	Comment
1		0.1740	35.83	9.60	45.43	64.77	-19.34	QP	
2		0.1740	20.35	9.60	29.95	54.77	-24.82	AVG	
3		0.2696	29.60	9.59	39.19	61.13	-21.94	QP	
4		0.2696	22.73	9.59	32.32	51.13	-18.81	AVG	
5		1.8160	20.55	9.64	30.19	56.00	-25.81	QP	
6		1.8160	10.57	9.64	20.21	46.00	-25.79	AVG	
7		2.8947	23.83	9.63	33.46	56.00	-22.54	QP	
8		2.8947	15.89	9.63	25.52	46.00	-20.48	AVG	
9		6.9508	24.57	9.68	34.25	60.00	-25.75	QP	
10		6.9508	16.36	9.68	26.04	50.00	-23.96	AVG	
11		24.0997	27.26	9.69	36.95	60.00	-23.05	QP	
12	*	24.0997	24.85	9.69	34.54	50.00	-15.46	AVG	

**REMARKS:**

- (1) Measurement Value = Reading Level + Correct Factor.
- (2) Margin Level = Measurement Value - Limit Value.

Test Mode	Normal	Tested Date	2023/11/8
Test Frequency	-	Phase	Neutral

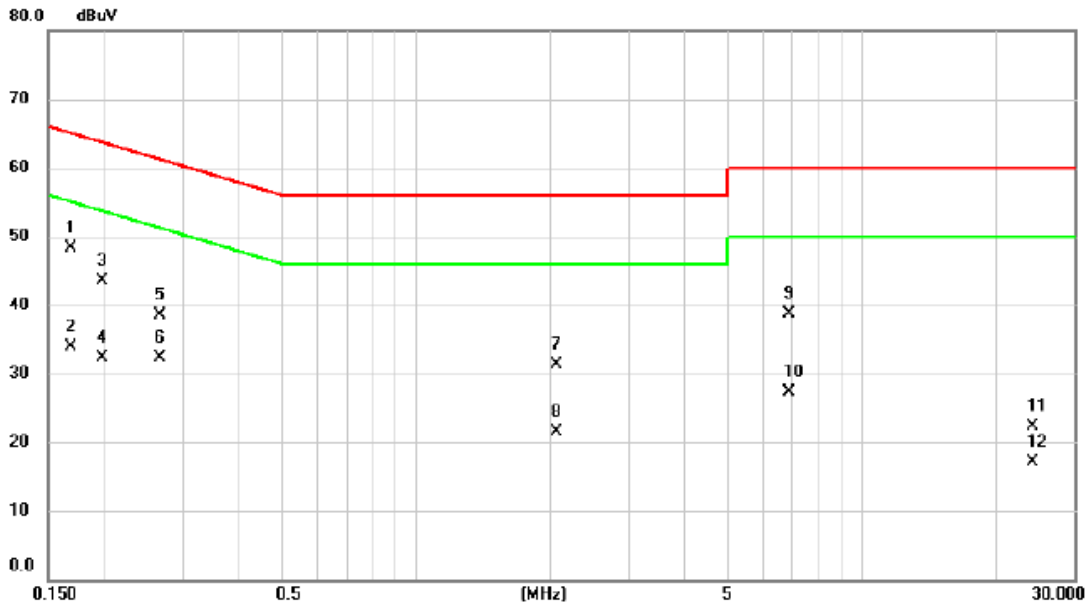

No.	Mk.	Freq.	Reading Level	Correct Factor	Measurement	Limit	Margin	Detector	Comment
		MHz	dBuV	dB	dBuV	dBuV	dB		
1	*	0.1680	38.65	9.59	48.24	65.06	-16.82	QP	
2		0.1680	24.37	9.59	33.96	55.06	-21.10	AVG	
3		0.1986	33.86	9.59	43.45	63.67	-20.22	QP	
4		0.1986	22.73	9.59	32.32	53.67	-21.35	AVG	
5		0.2672	28.97	9.58	38.55	61.20	-22.65	QP	
6		0.2672	22.74	9.58	32.32	51.20	-18.88	AVG	
7		2.0768	21.76	9.64	31.40	56.00	-24.60	QP	
8		2.0768	11.82	9.64	21.46	46.00	-24.54	AVG	
9		6.8776	28.95	9.68	38.63	60.00	-21.37	QP	
10		6.8776	17.63	9.68	27.31	50.00	-22.69	AVG	
11		24.1423	12.48	9.85	22.33	60.00	-37.67	QP	
12		24.1423	7.23	9.85	17.08	50.00	-32.92	AVG	

REMARKS:

- (1) Measurement Value = Reading Level + Correct Factor.
- (2) Margin Level = Measurement Value - Limit Value.

Test Mode	Idle	Tested Date	2023/11/8
Test Frequency	-	Phase	Line

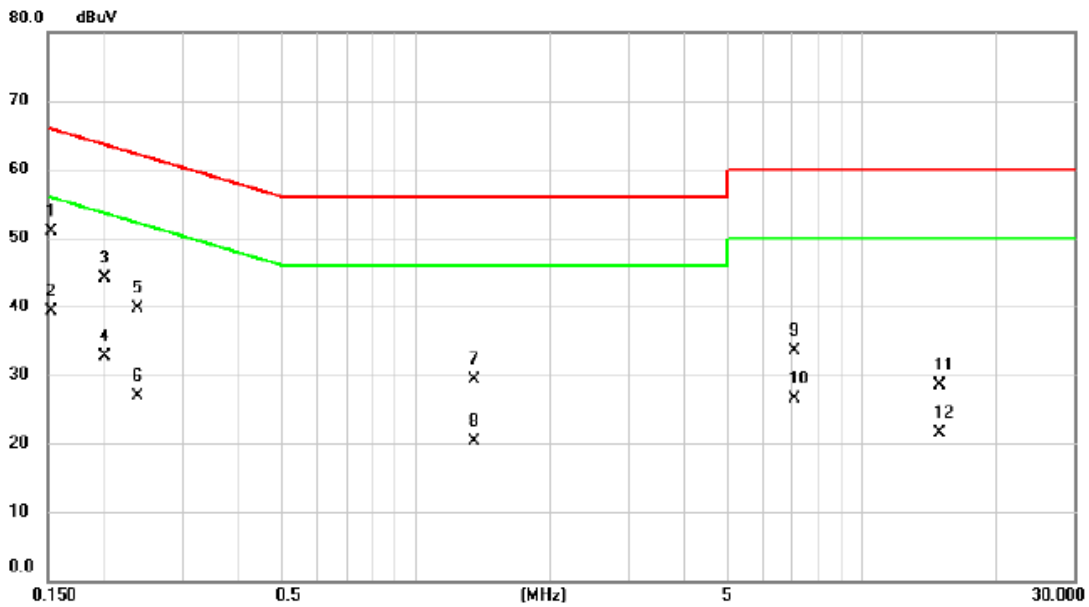

No. Mk.	Freq. MHz	Reading Level dBuV	Correct Factor dB	Measurement dBuV	Limit dBuV	Margin dB	Detector	Comment
1 *	0.1524	41.23	9.60	50.83	65.87	-15.04	QP	
2	0.1524	29.76	9.60	39.36	55.87	-16.51	AVG	
3	0.2017	34.55	9.60	44.15	63.54	-19.39	QP	
4	0.2017	23.06	9.60	32.66	53.54	-20.88	AVG	
5	0.2378	30.18	9.59	39.77	62.17	-22.40	QP	
6	0.2378	17.36	9.59	26.95	52.17	-25.22	AVG	
7	1.3593	19.65	9.60	29.25	56.00	-26.75	QP	
8	1.3593	10.63	9.60	20.23	46.00	-25.77	AVG	
9	7.0997	23.89	9.68	33.57	60.00	-26.43	QP	
10	7.0997	16.74	9.68	26.42	50.00	-23.58	AVG	
11	14.9860	18.79	9.72	28.51	60.00	-31.49	QP	
12	14.9860	11.86	9.72	21.58	50.00	-28.42	AVG	

**REMARKS:**

- (1) Measurement Value = Reading Level + Correct Factor.
- (2) Margin Level = Measurement Value - Limit Value.

Test Mode	Idle	Tested Date	2023/11/8
Test Frequency	-	Phase	Neutral

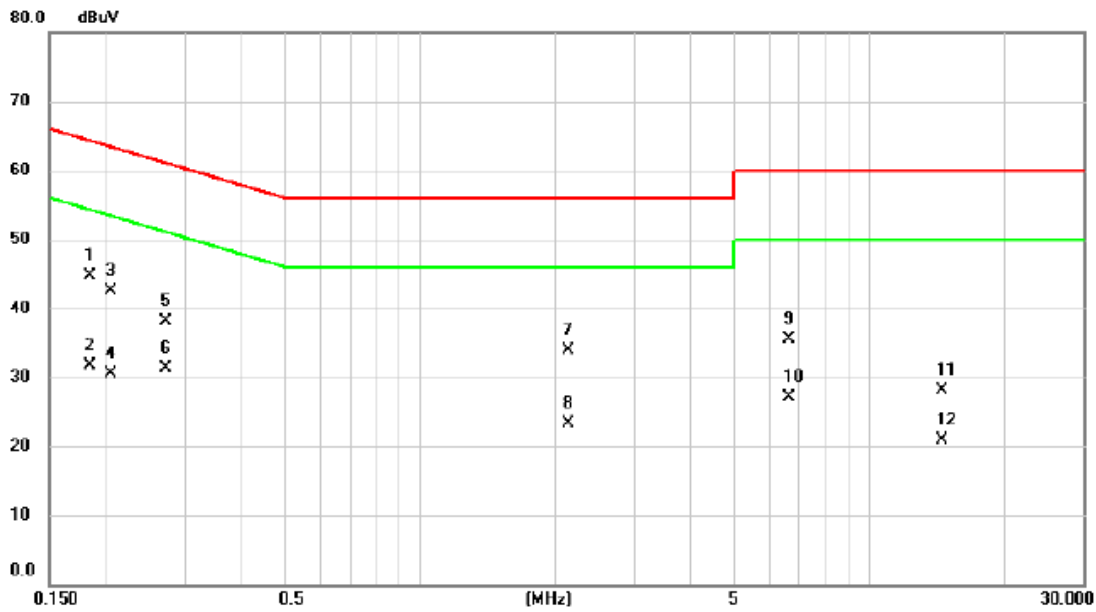

No.	Mk.	Freq. MHz	Reading Level dBuV	Correct Factor dB	Measure- ment dBuV	Limit dBuV	Margin dB	Detector	Comment
1	*	0.1844	35.12	9.59	44.71	64.29	-19.58	QP	
2		0.1844	22.13	9.59	31.72	54.29	-22.57	AVG	
3		0.2061	32.86	9.59	42.45	63.36	-20.91	QP	
4		0.2061	20.97	9.59	30.56	53.36	-22.80	AVG	
5		0.2730	28.50	9.58	38.08	61.03	-22.95	QP	
6		0.2730	21.64	9.58	31.22	51.03	-19.81	AVG	
7		2.1440	24.35	9.64	33.99	56.00	-22.01	QP	
8		2.1440	13.68	9.64	23.32	46.00	-22.68	AVG	
9		6.6271	25.84	9.67	35.51	60.00	-24.49	QP	
10		6.6271	17.43	9.67	27.10	50.00	-22.90	AVG	
11		14.5942	18.42	9.78	28.20	60.00	-31.80	QP	
12		14.5942	11.08	9.78	20.86	50.00	-29.14	AVG	

**REMARKS:**

- (1) Measurement Value = Reading Level + Correct Factor.
- (2) Margin Level = Measurement Value - Limit Value.

## APPENDIX D CONTENTION BASED PROTOCOL

Test Mode UNII-5, UNII-6, UNII-7, UNII-8

**Incumbent Signal (AWGN)  
Frequency: 6265 MHz**

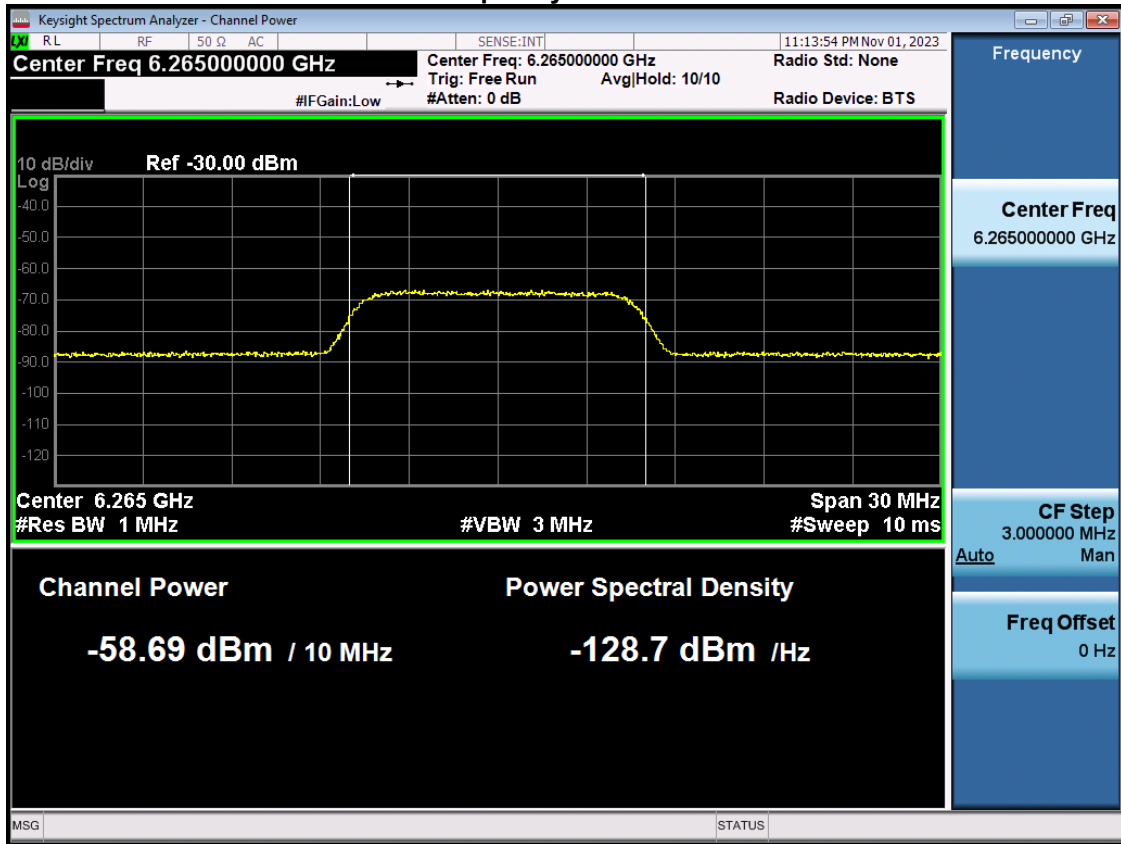



## Frequency: 6265 MHz

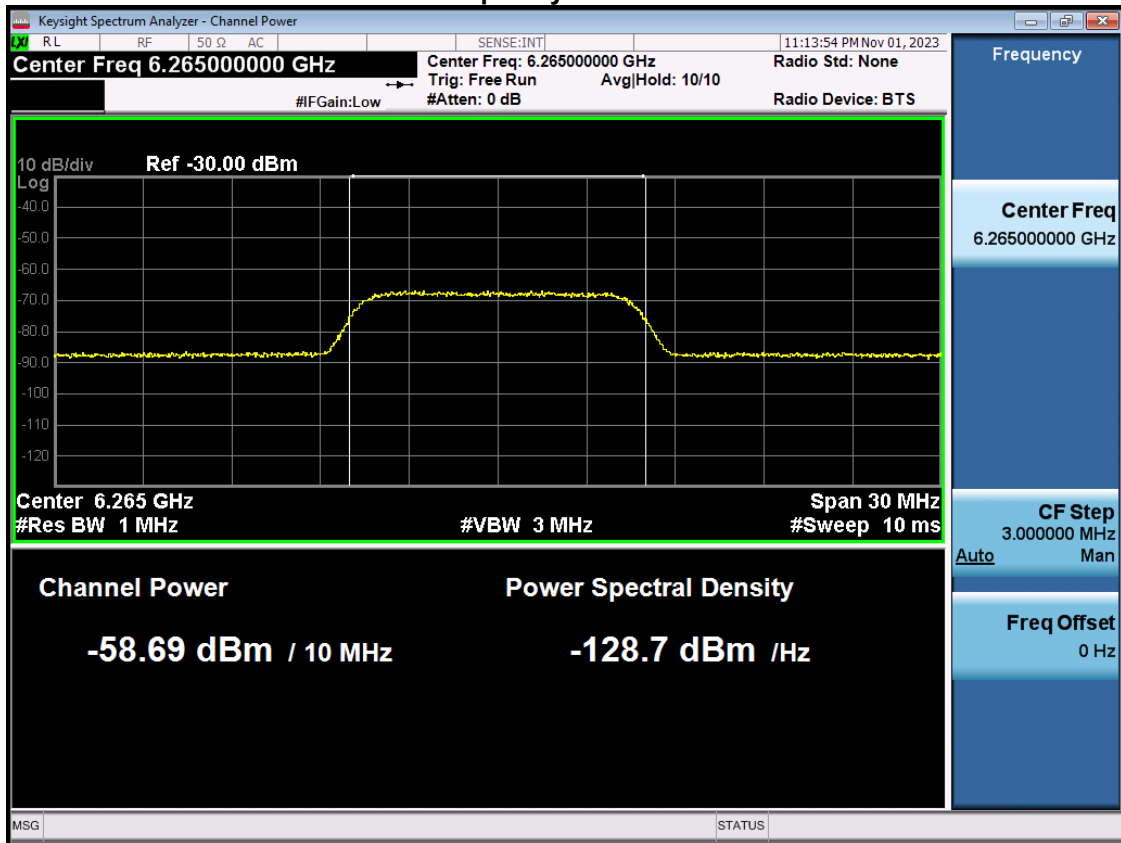

## Frequency: 6425 MHz

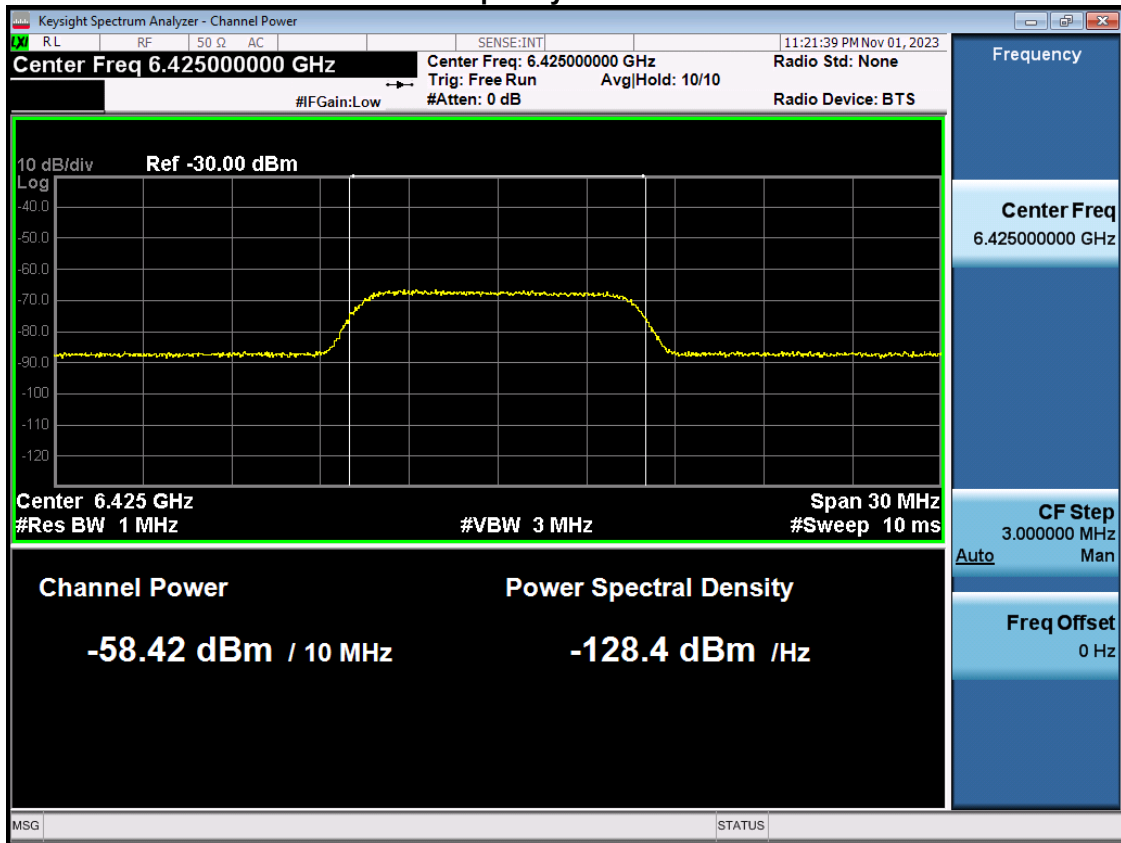

## Frequency: 6585 MHz

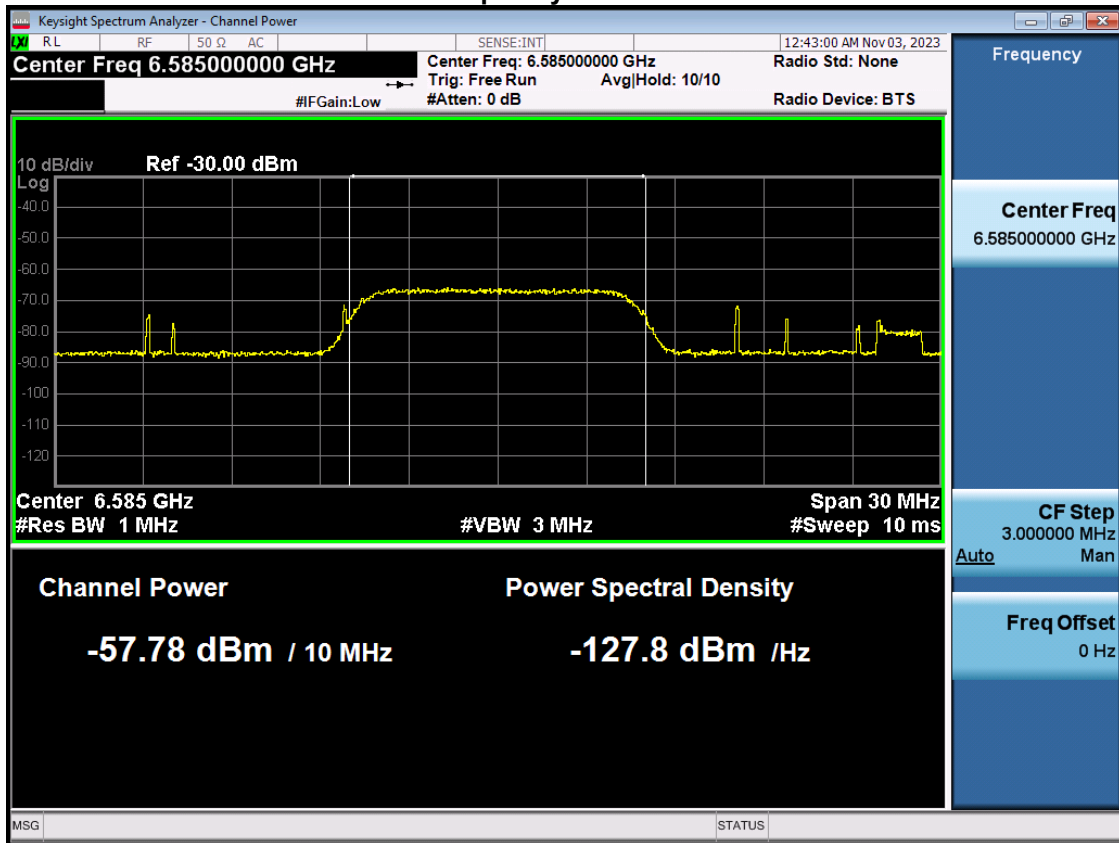

## Frequency: 6905 MHz

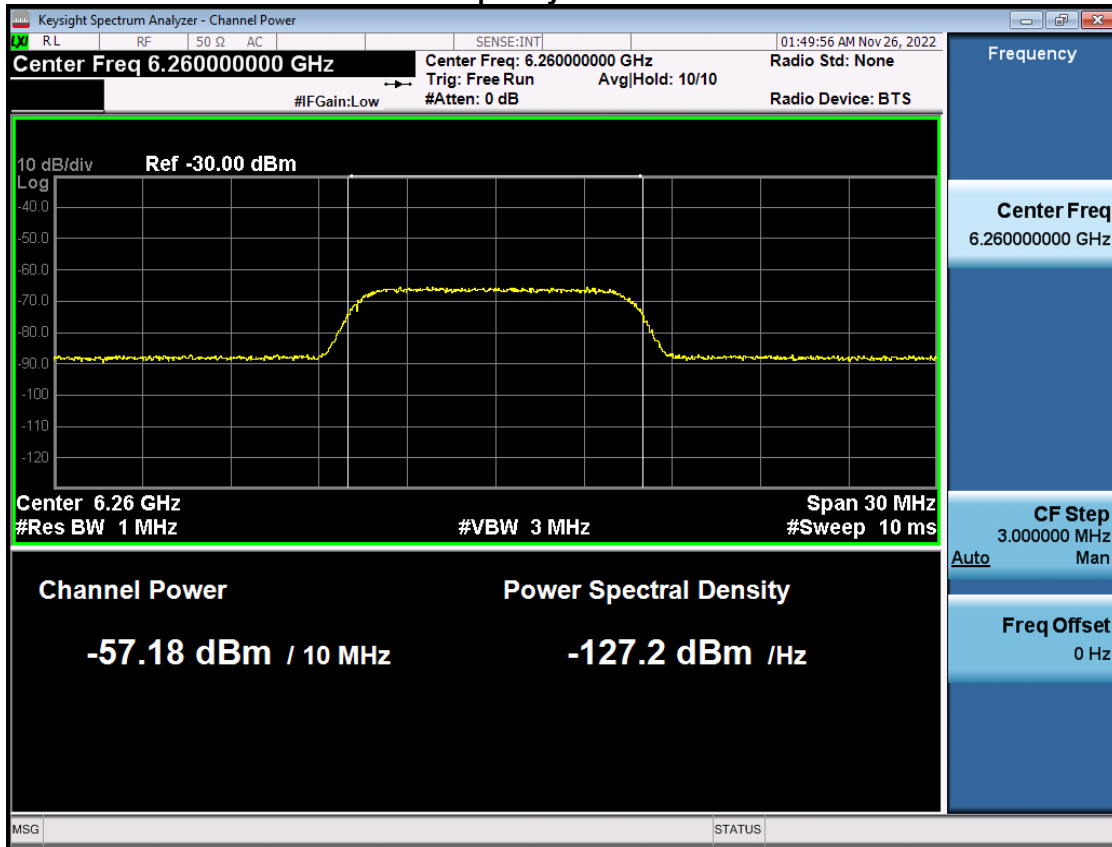

**Detection power level and detection probability**

Bands	Test Mode	Bandwidth (MHz)	Channel	Frequency (MHz)	interference Frequency (MHz)	Detection power level (dBm)	Detection Power Limit (dBm)	Number of Times	Number of Detected	Detection Probability	Detection Probability Limit	Test Result
UNII-5	802.11be	320	63	6265	6110	-58.98	-58.61	10	10	100%	100%	Pass
					6265	-58.69	-58.61	10	10	100%	100%	Pass
					6420	-58.70	-58.61	10	10	100%	100%	Pass
UNII-6	802.11be	320	95	6425	6270	-61.56	-58.32	10	9	90%	90%	Pass
					6425	-61.32	-58.32	10	10	100%	100%	Pass
					6580	-61.32	-58.32	10	10	100%	100%	Pass
UNII-7	802.11be	320	127	6585	6430	-59.55	-57.71	10	10	100%	100%	Pass
					6585	-59.45	-57.71	10	10	100%	100%	Pass
					6740	-60.56	-57.71	10	10	100%	100%	Pass
UNII-8	802.11be	320	191	6905	6750	-57.85	-57.71	10	9	90%	90%	Pass
					6905	-57.73	-57.71	10	10	100%	100%	Pass
					7060	-57.75	-57.71	10	10	100%	100%	Pass

## Contention-Based Protocol EUT Channel: CH63 Incumbent Signal Frequency: 6110MHz

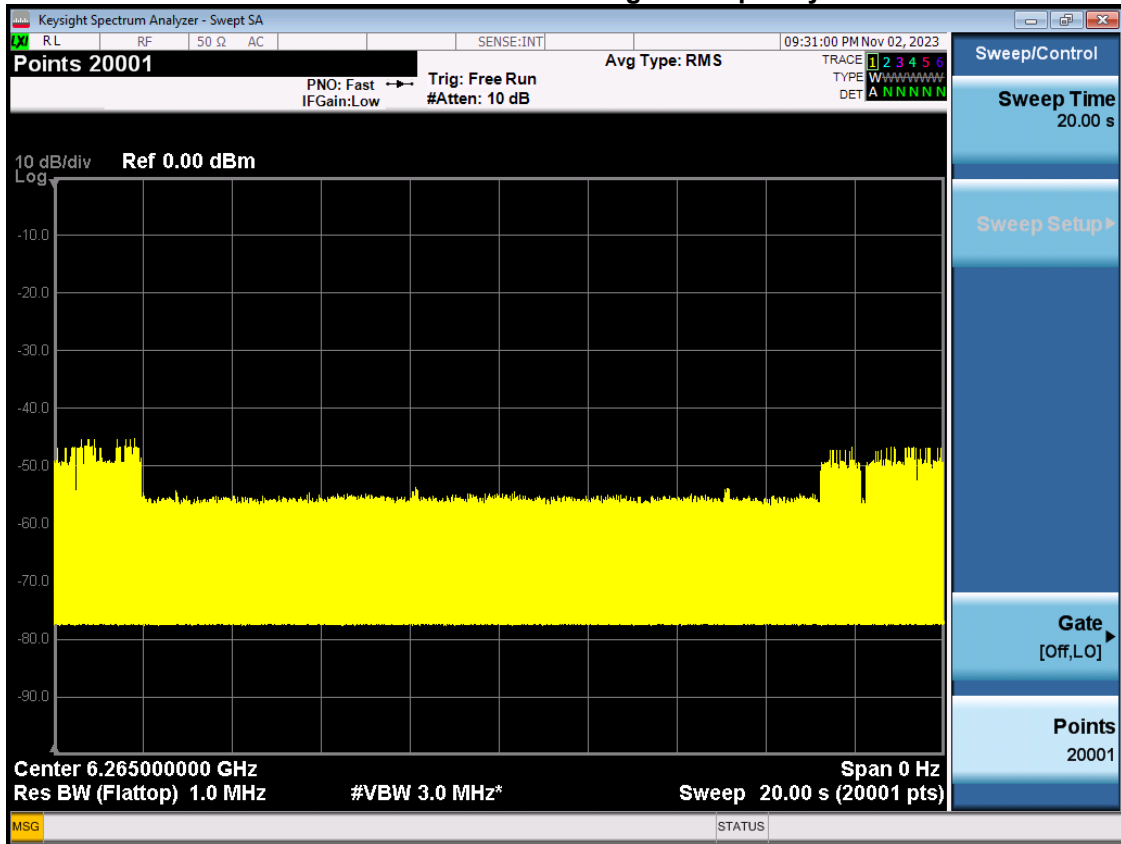

### EUT Channel: CH63 Incumbent Signal Frequency: 6265 MHz

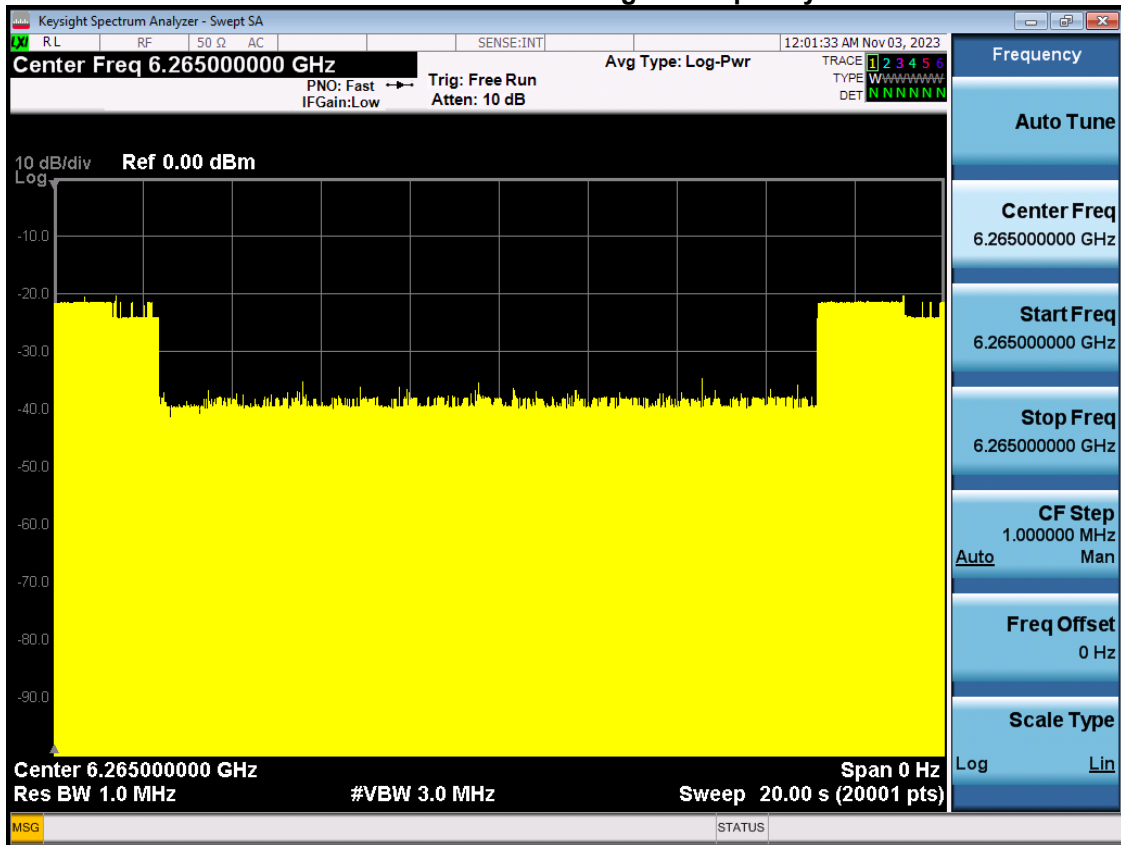

### EUT Channel: CH63 Incumbent Signal Frequency: 6420 MHz

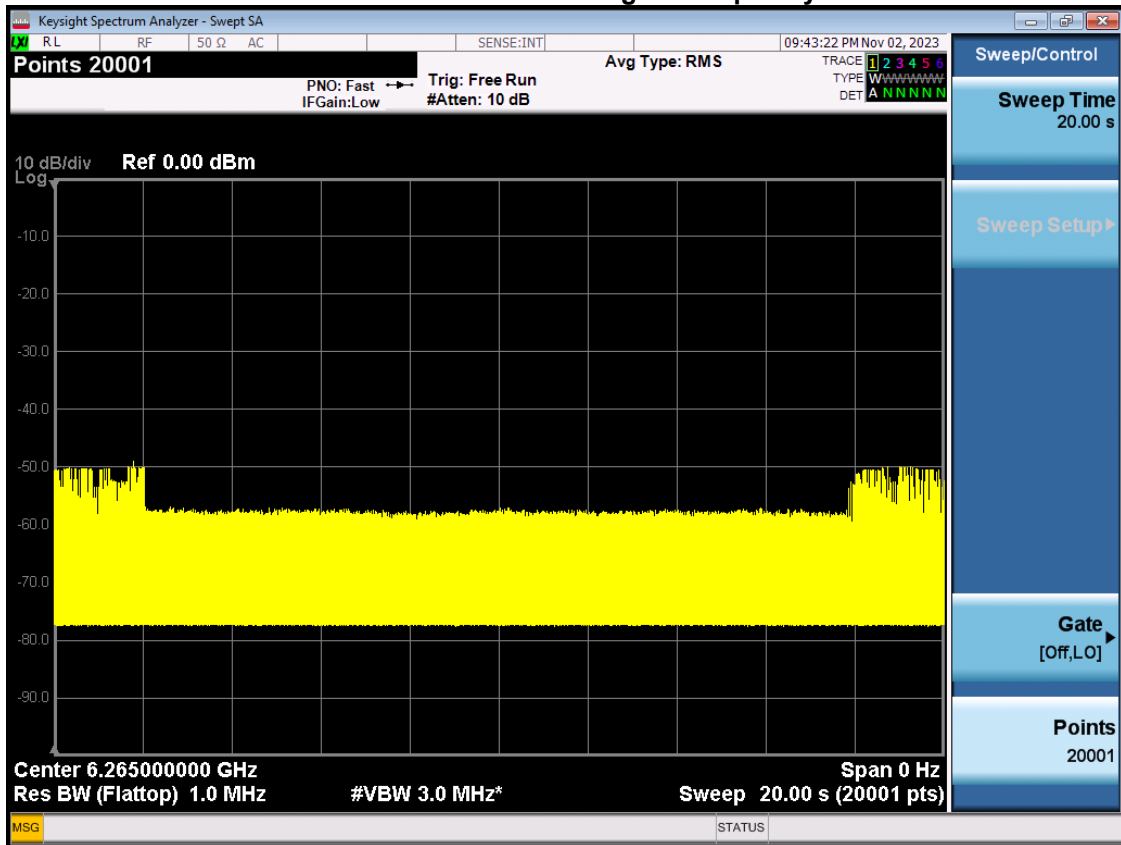



### EUT Channel: CH95 Incumbent Signal Frequency: 6270 MHz

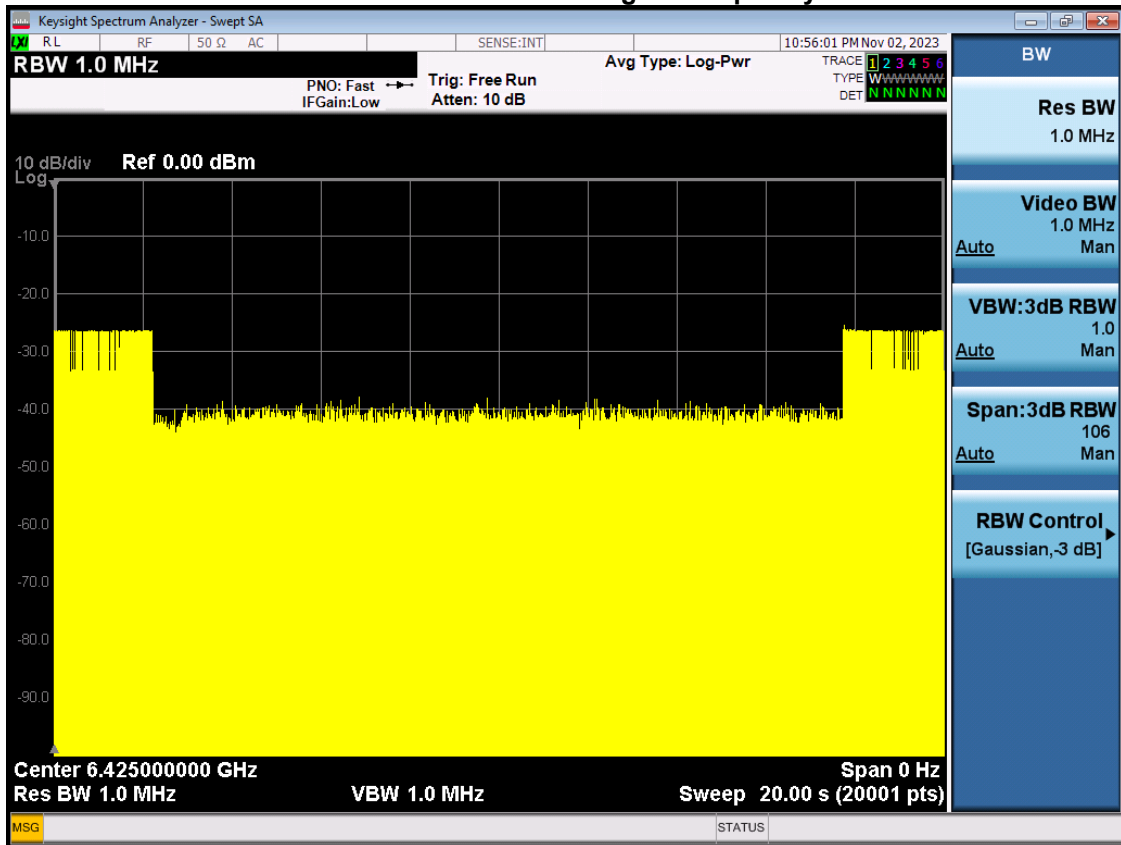

### EUT Channel: CH95 Incumbent Signal Frequency: 6425 MHz

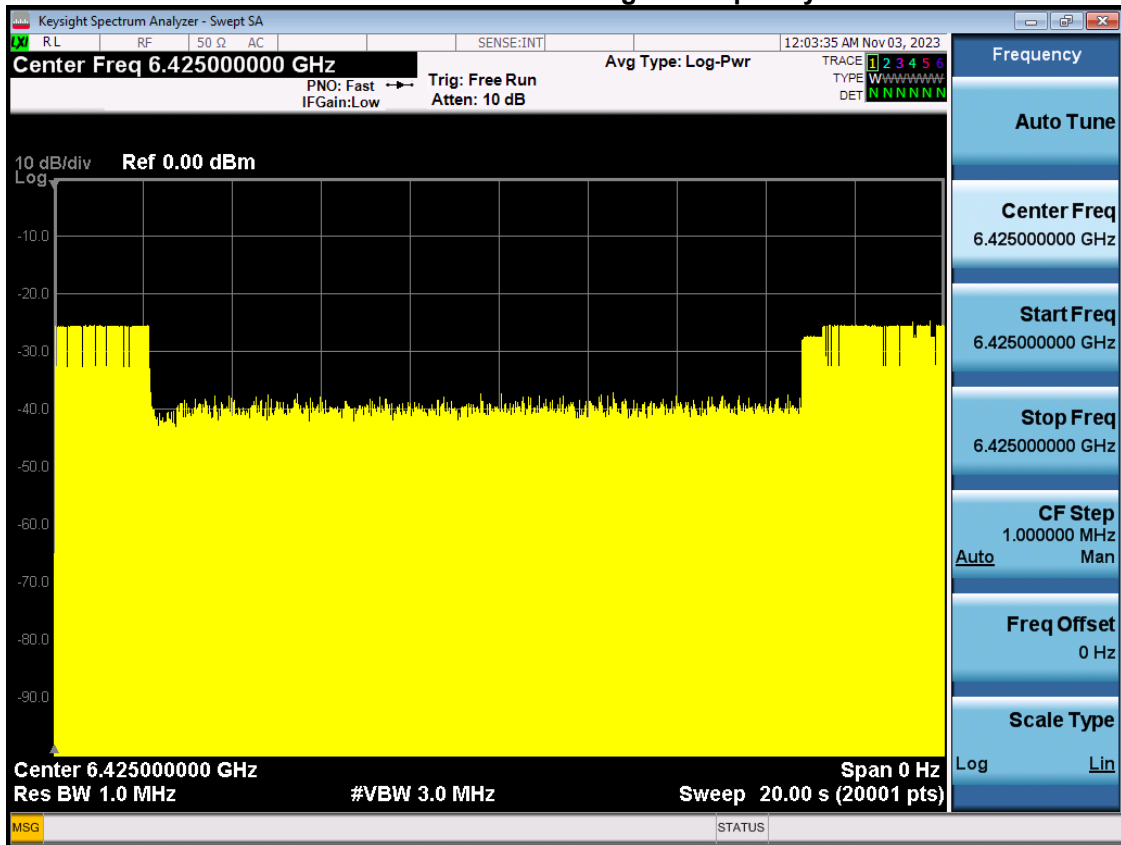

### EUT Channel: CH95 Incumbent Signal Frequency: 6580 MHz

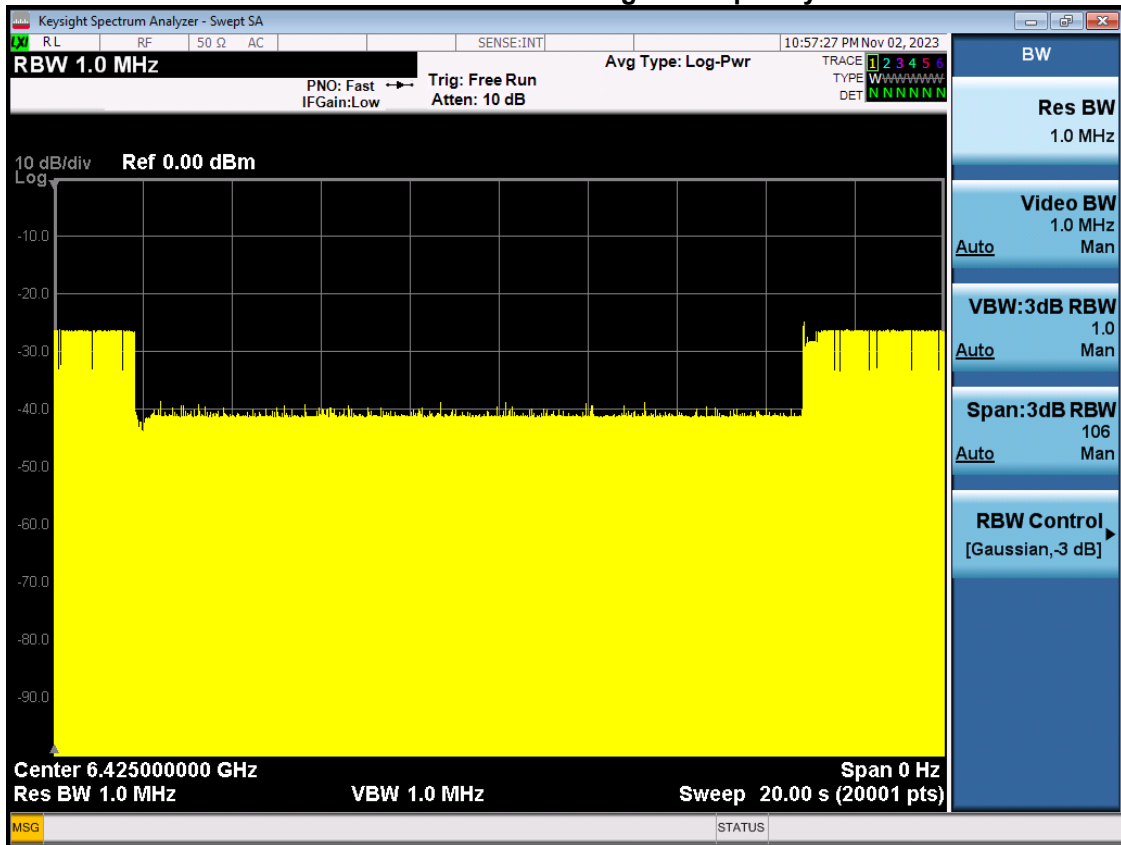

### EUT Channel: CH127 Incumbent Signal Frequency: 6430 MHz

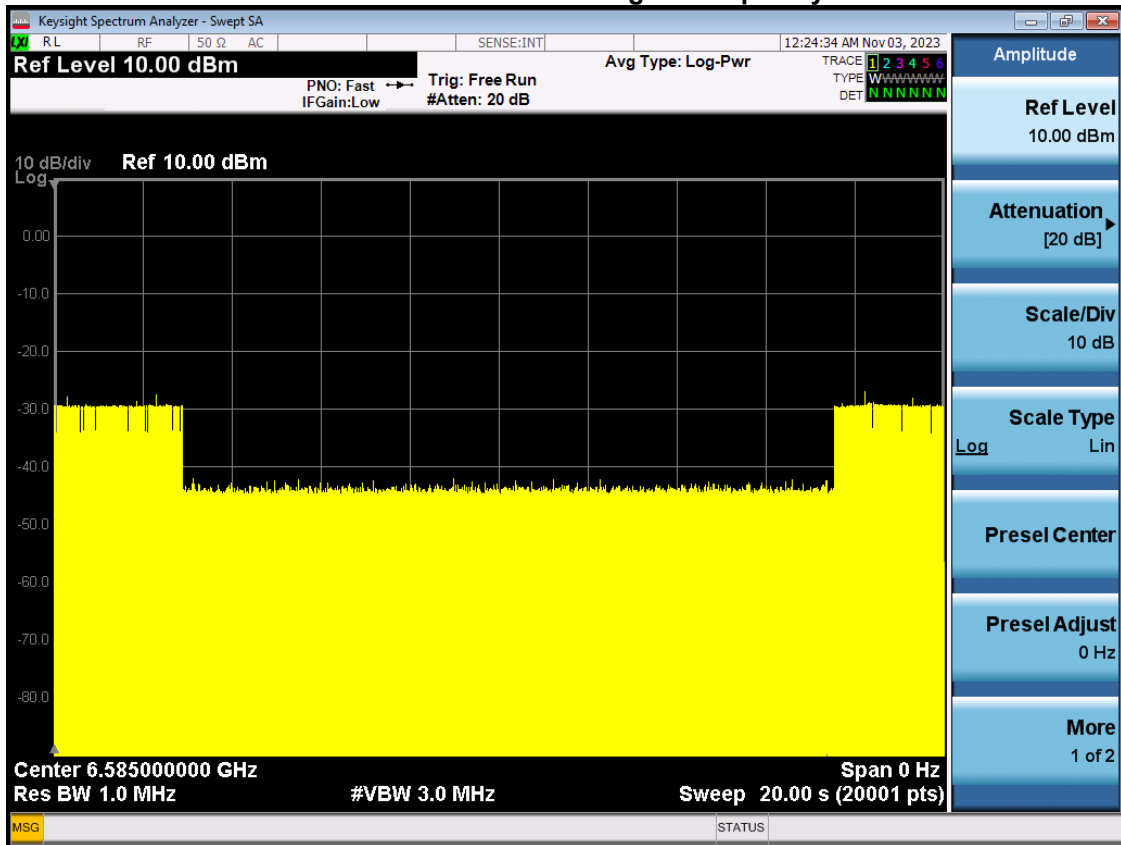

### EUT Channel: CH127 Incumbent Signal Frequency: 6585 MHz

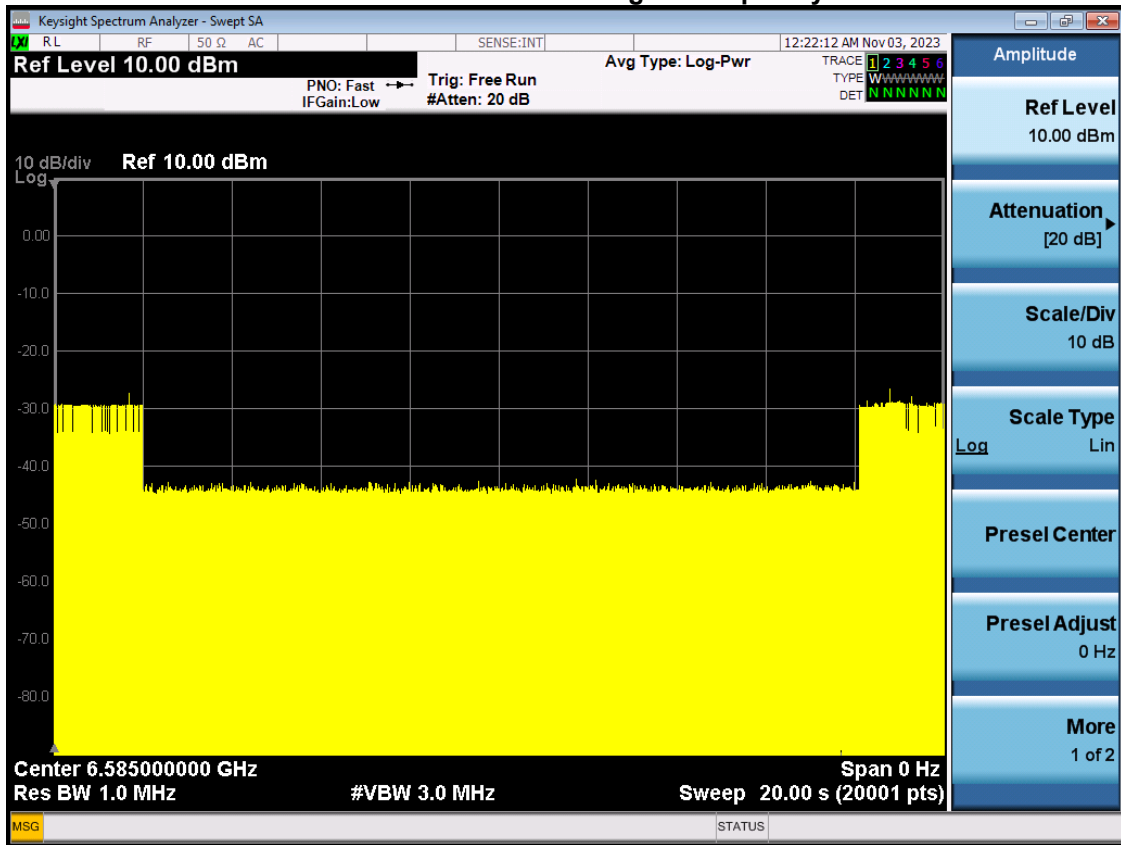

### EUT Channel: CH127 Incumbent Signal Frequency: 6740 MHz

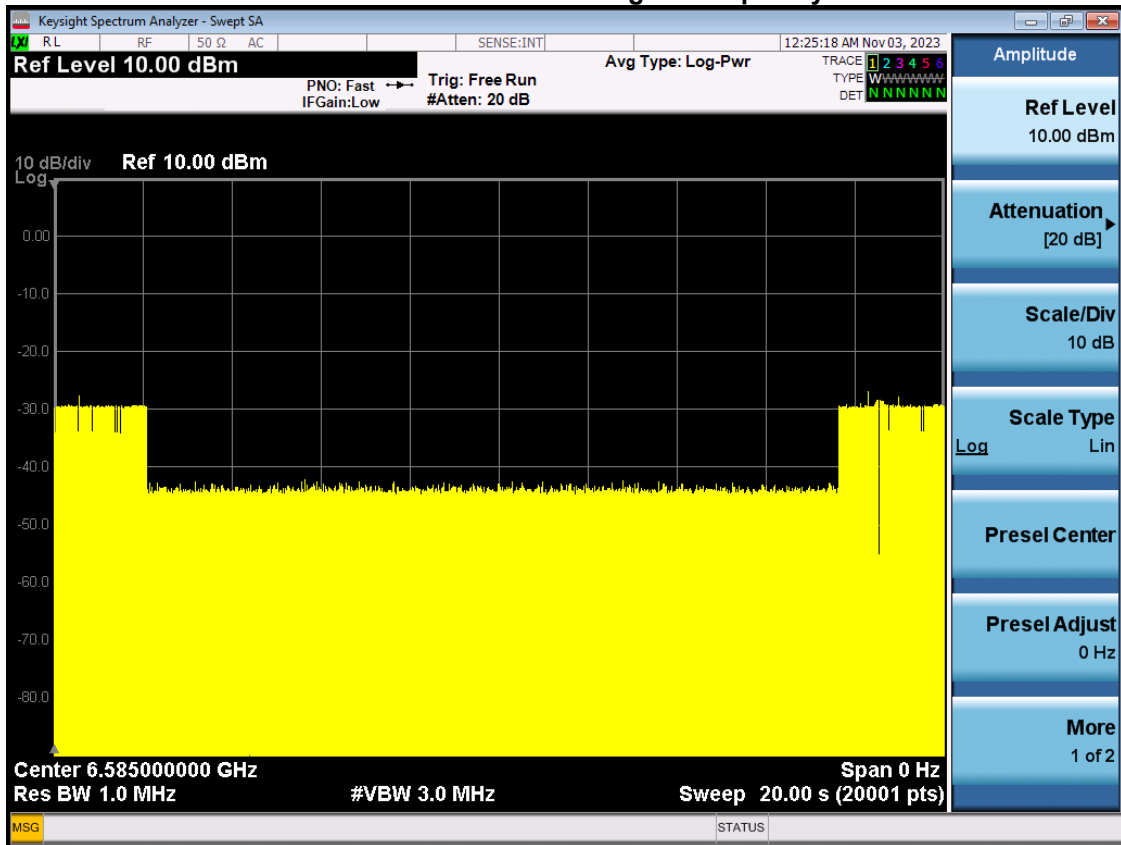

### EUT Channel: CH191 Incumbent Signal Frequency: 6750 MHz

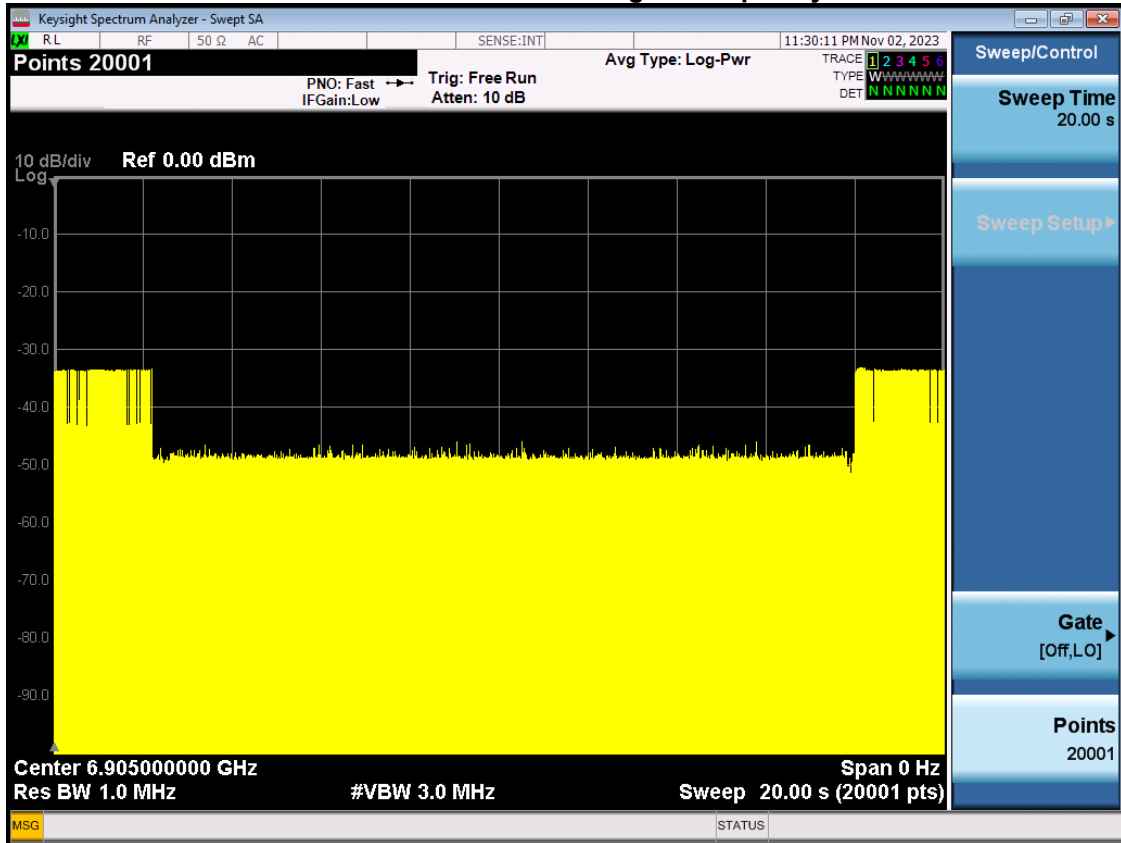

### EUT Channel: CH191 Incumbent Signal Frequency: 6905 MHz

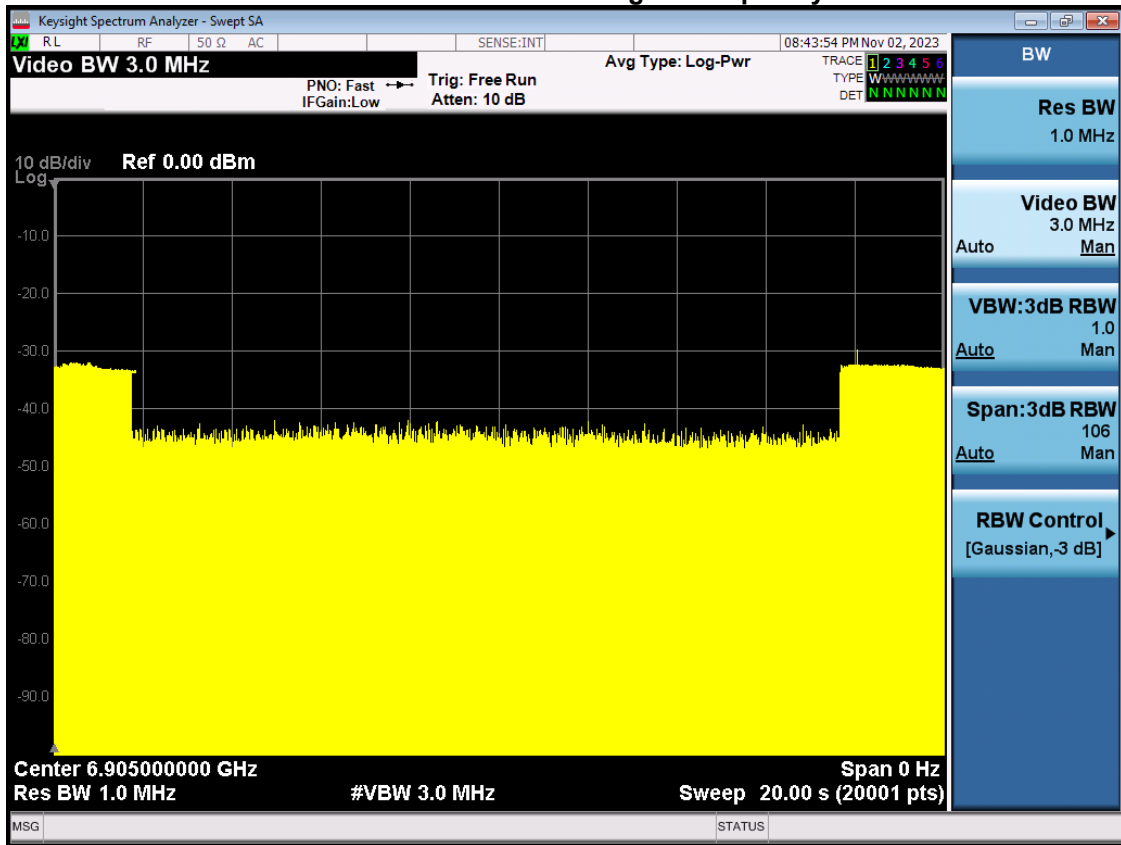



### EUT Channel: CH191 Incumbent Signal Frequency: 7060 MHz

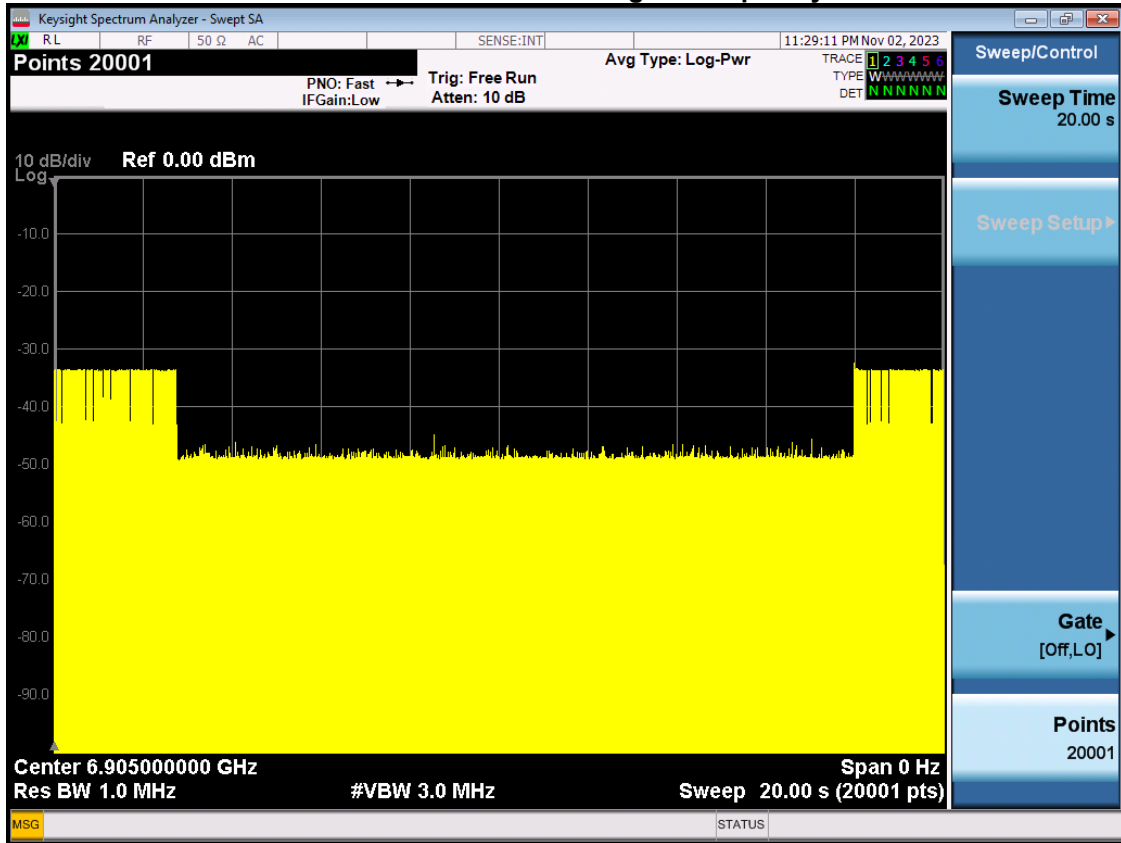

End of Test Report