

FCC Radio Test Report

FCC ID: RWO-RZ090484**This report concerns: Class II Permissive Changes**

Report No. : BTL-FCCP-4-2211C022
Equipment : Notebook PC
Model Name : RZ09-0485
Brand Name : RAZER
Applicant : Razer Inc.
Address : 9 Pasteur, Suite 100, Irvine, CA92618, USA.
Manufacturer : Razer Inc.
Address : 9 Pasteur, Suite 100, Irvine, CA92618, USA.

Radio Function : RLAN 5 GHz (U-NII 1, U-NII 2A, U-NII 2C, U-NII 3)

FCC Rule Part(s) : FCC CFR Title 47, Part 15, Subpart E (15.407)
Measurement Procedure(s) : ANSI C63.10-2013

Date of Receipt : 2022/11/09
Date of Test : 2022/11/25 ~ 2023/1/19
Issued Date : 2023/1/31

The above equipment has been tested and found in compliance with the requirement of the above standards by BTL Inc.

Prepared by

: Eric Lee
Eric Lee, Engineer

Approved by

: Jerry Chuang
Jerry Chuang, Supervisor

**BTL Inc.**

No.18, Ln. 171, Sec. 2, Jiuzong Rd., Neihu Dist., Taipei City 114, Taiwan

Tel: +886-2-2657-3299 Fax: +886-2-2657-3331 Web: www.newbtl.com Service mail: btl_qa@newbtl.com

Declaration

BTL represents to the client that testing is done in accordance with standard procedures as applicable and that test instruments used has been calibrated with standards traceable to international standard(s) and/or national standard(s).

BTL's reports apply only to the specific samples tested under conditions. It is manufacture's responsibility to ensure that additional production units of this model are manufactured with the identical electrical and mechanical components. **BTL** shall have no liability for any declarations, inferences or generalizations drawn by the client or others from **BTL** issued reports.

This report is the confidential property of the client. As a mutual protection to the clients, the public and ourselves, the test report shall not be reproduced, except in full, without our written approval.

BTL's laboratory quality assurance procedures are in compliance with the **ISO/IEC 17025** requirements, and accredited by the conformity assessment authorities listed in this test report.

BTL is not responsible for the sampling stage, so the results only apply to the sample as received.

The information, data and test plan are provided by manufacturer which may affect the validity of results, so it is manufacturer's responsibility to ensure that the apparatus meets the essential requirements of applied standards and in all the possible configurations as representative of its intended use.

Limitation

For the use of the authority's logo is limited unless the Test Standard(s)/Scope(s)/Item(s) mentioned in this test report is (are) included in the conformity assessment authorities acceptance respective.

Please note that the measurement uncertainty is provided for informational purpose only and are not use in determining the Pass/Fail results.

CONTENTS

REVISION HISTORY	4
1 SUMMARY OF TEST RESULTS	5
1.1 TEST FACILITY	6
1.2 MEASUREMENT UNCERTAINTY	6
1.3 TEST ENVIRONMENT CONDITIONS	7
1.4 TABLE OF PARAMETERS OF TEST SOFTWARE SETTING	7
2 GENERAL INFORMATION	9
2.1 DESCRIPTION OF EUT	9
2.2 TEST MODES	13
2.3 BLOCK DIAGRAM SHOWING THE CONFIGURATION OF SYSTEM TESTED	14
2.4 SUPPORT UNITS	15
3 AC POWER LINE CONDUCTED EMISSIONS TEST	16
3.1 LIMIT	16
3.2 TEST PROCEDURE	16
3.3 DEVIATION FROM TEST STANDARD	16
3.4 TEST SETUP	17
3.5 TEST RESULT	17
4 RADIATED EMISSIONS TEST	18
4.1 LIMIT	18
4.2 TEST PROCEDURE	19
4.3 DEVIATION FROM TEST STANDARD	19
4.4 TEST SETUP	20
4.5 EUT OPERATING CONDITIONS	21
4.6 TEST RESULT – BELOW 30 MHZ	21
4.7 TEST RESULT – 30 MHZ TO 1 GHZ	21
4.8 TEST RESULT – ABOVE 1 GHZ	21
5 OUTPUT POWER TEST	22
5.1 LIMIT	22
5.2 TEST PROCEDURE	22
5.3 DEVIATION FROM TEST STANDARD	22
5.4 TEST SETUP	22
5.5 EUT OPERATING CONDITIONS	22
5.6 TEST RESULT	22
6 LIST OF MEASURING EQUIPMENTS	23
7 EUT TEST PHOTO	24
8 EUT PHOTOS	24
APPENDIX A AC POWER LINE CONDUCTED EMISSIONS	25
APPENDIX B RADIATED EMISSIONS - 30 MHZ TO 1 GHZ	30
APPENDIX C RADIATED EMISSIONS - ABOVE 1 GHZ	33
APPENDIX D OUTPUT POWER	64

REVISION HISTORY

Report No.	Version	Description	Issued Date	Note
BTL-FCCP-4-2211C022	R00	Original Report.	2023/1/4	Invalid
BTL-FCCP-4-2211C022	R01	Revised report to address TAF Audit's comments.	2023/1/31	Valid

1 SUMMARY OF TEST RESULTS

Test procedures according to the technical standards.

Standard(s) Section	Description	Test Result	Judgement	Remark
15.207	AC Power Line Conducted Emissions	APPENDIX A	Pass	-----
15.205 15.209 15.407(b)	Radiated Emissions	APPENDIX B APPENDIX C	Pass	-----
15.407(a)	Bandwidth	-----	Pass	-----
15.407(a)	Output Power	APPENDIX D	Pass	-----
15.407(a)	Power Spectral Density	-----	Pass	-----
15.203	Antenna Requirement	-----	Pass	-----
15.407(c)	Automatically Discontinue Transmission	-----	Pass	NOTE (3)

NOTE:

- (1) "N/A" denotes test is not applicable in this Test Report.
- (2) The report format version is TP.1.1.1.
- (3) The EUT can detect the controlling signal of ACK message transmitting from remote device and verify whether it shall resend or discontinue transmission.
- (4) The antenna gain of EUT is smaller than that of the module. So in this report the worst cases of radiated spurious emissions and AC Power Line Conducted Emissions were evaluated and recorded. And evaluated the output power items and recorded in the report. For the test results of all other test items please refer to module test reports.

1.1 TEST FACILITY

The test facilities used to collect the test data in this report:

No. 72, Ln. 169, Sec. 2, Datong Rd., Xizhi Dist., New Taipei City 221, Taiwan

The test sites and facilities are covered under FCC RN: 674415 and DN: TW0659.

C06 CB21 CB22

No. 68-1, Ln. 169, Sec. 2, Datong Rd., Xizhi Dist., New Taipei City 221, Taiwan

The test sites and facilities are covered under FCC RN: 674415 and DN: TW0659.

C05 CB08 CB11 CB15 CB16
 SR10

1.2 MEASUREMENT UNCERTAINTY

The reported uncertainty of measurement $y \pm U$, where expanded uncertainty U is based on a standard uncertainty multiplied by a coverage factor of $k = 2$, providing a level of confidence of approximately **95 %**. The measurement instrumentation uncertainty considerations contained in CISPR 16-4-2. The BTL measurement uncertainty is less than the CISPR 16-4-2 U_{cispr} requirement.

A. AC power line conducted emissions test:

Test Site	Method	Measurement Frequency Range	U (dB)
C05	CISPR	150 kHz ~ 30MHz	3.44

B. Radiated emissions test :

Test Site	Measurement Frequency Range	U,(dB)
CB21	0.03 GHz ~ 0.2 GHz	4.17
	0.2 GHz ~ 1 GHz	4.72
	1 GHz ~ 6 GHz	5.21
	6 GHz ~ 18 GHz	5.51
	18 GHz ~ 26 GHz	3.69
	26 GHz ~ 40 GHz	4.23

C. Conducted test :

Test Item	U,(dB)
Output power	0.3669

NOTE:

Unless specifically mentioned, the uncertainty of measurement has not been taken into account to declare the compliance or non-compliance to the specification.

1.3 TEST ENVIRONMENT CONDITIONS

Test Item	Environment Condition	Test Voltage	Tested by
AC Power Line Conducted Emissions	19°C, 65%	AC 120V/60Hz	Jay Tien
Radiated emissions below 1 GHz	23°C, 59%	AC 120V/60Hz	Mark Wang
Radiated emissions above 1 GHz	23°C, 59%	AC 120V/60Hz	Mark Wang
Output Power	22.6°C, 51%	AC 120V/60Hz	Angela Wang

1.4 TABLE OF PARAMETERS OF TEST SOFTWARE SETTING

UNII-1				
Test Software	DRTU V02999.22.180.0			
Mode	5180 MHz	5200 MHz	5240 MHz	Data Rate
IEEE 802.11a_Main Ant.	18.375	20.75	20.75	6 Mbps
IEEE 802.11a_Aux Ant.	18.375	20.875	20.875	6 Mbps
IEEE 802.11n (HT20)	16.25	17.875	17.75	HT8
IEEE 802.11ax (HE20)	17	18.5	18.5	HE0
Mode	5190 MHz	5230 MHz		Data Rate
IEEE 802.11n (HT40)	15.25	17		HT8
IEEE 802.11ax (HE40)	14.125	18.5		HE0
Mode	5210 MHz			Data Rate
IEEE 802.11ac (VHT80)	15.375			VHT0
IEEE 802.11ax (HE80)	15.25			HE0

UNII-2A				
Test Software	DRTU V02999.22.180.0			
Mode	5260 MHz	5300 MHz	5320 MHz	Data Rate
IEEE 802.11a_Main Ant.	20.75	20.75	19.5	6 Mbps
IEEE 802.11a_Aux Ant.	20.875	20.875	19.5	6 Mbps
IEEE 802.11n (HT20)	18.125	18.125	16.5	HT8
IEEE 802.11ax (HE20)	18.5	18.5	16.125	HE0
Mode	5270 MHz	5310 MHz		Data Rate
IEEE 802.11n (HT40)	17.25	15.375		HT8
IEEE 802.11ax (HE40)	19.75	14.375		HE0
Mode	5290 MHz			Data Rate
IEEE 802.11ac (VHT80)	16			VHT0
IEEE 802.11ax (HE80)	14.875			HE0

UNII-1+ UNII-2A				
Test Software	DRTU V02999.22.180.0			
Mode	5250 MHz			Data Rate
IEEE 802.11ac (VHT160)	11.25			VHT0
IEEE 802.11ax (HE160)	11.75			HE0

UNII-2C				
Test Software	DRTU V02999.22.180.0			
Mode	5500 MHz	5580 MHz	5700 MHz	Data Rate
IEEE 802.11a_Main Ant.	19.625	21	20.25	6 Mbps
IEEE 802.11a_Aux Ant.	19.625	21	20.25	6 Mbps
IEEE 802.11n (HT20)	18	18	18	HT8
IEEE 802.11ax (HE20)	17.875	18.75	18.125	HE0
Mode	5510 MHz	5550 MHz	5670 MHz	Data Rate
IEEE 802.11n (HT40)	16.375	20.125	19.5	HT8
IEEE 802.11ax (HE40)	16.375	20.25	19.375	HE0
Mode	5530 MHz	5610 MHz		Data Rate
IEEE 802.11ac (VHT80)	17	20		VHT0
IEEE 802.11ax (HE80)	18.25	19.375		HE0
Mode	5570 MHz			Data Rate
IEEE 802.11ac (VHT160)	12.25			VHT0
IEEE 802.11ax (HE160)	13.75			HE0

UNII-3				
Test Software	DRTU V02999.22.180.0			
Mode	5745 MHz	5785 MHz	5825 MHz	Data Rate
IEEE 802.11a_Main Ant.	21.5	21.25	21.75	6 Mbps
IEEE 802.11a_Aux Ant.	21.25	21	21.25	6 Mbps
IEEE 802.11n (HT20)	20.625	20.875	21	HT8
IEEE 802.11ax (HE20)	20.875	20.75	21	HE0
Mode	5755 MHz	5795 MHz		Data Rate
IEEE 802.11n (HT40)	19.75	20.25		HT8
IEEE 802.11ax (HE40)	19.75	20.625		HE0
Mode	5775 MHz			Data Rate
IEEE 802.11ac (VHT80)	17.875			VHT0
IEEE 802.11ax (HE80)	18			HE0

2 GENERAL INFORMATION

2.1 DESCRIPTION OF EUT

Equipment	Notebook PC
Model Name	RZ09-0485
Brand Name	RAZER
Model Difference	N/A
Power Source	1# DC voltage supplied from AC adapter. Model: RC30-024801 2# Supplied from battery. Model: RC30-0248
Power Rating	1# I/P: 100-240V, 3.6A ,50/60Hz O/P: 19.5V===11.8A 2# DC 15.4V, 5209mAh, 80Wh
Products Covered	1* POWER Adapter 1* AC Cable
Operation Band	UNII-1: 5150 MHz to 5250 MHz UNII-2A: 5250 MHz to 5350 MHz UNII-2C: 5470 MHz to 5725 MHz UNII-3: 5725 MHz to 5850 MHz
Operation Frequency	UNII-1: 5180 MHz to 5240 MHz UNII-2A: 5260 MHz to 5320 MHz UNII-2C: 5500 MHz to 5700 MHz UNII-3: 5745 MHz to 5825 MHz
Modulation Technology	IEEE 802.11a/n/ac: OFDM IEEE 802.11ax: OFDMA
Transfer Rate	IEEE 802.11a: 54/48/36/24/18/12/9/6 Mbps IEEE 802.11n: up to 300 Mbps IEEE 802.11ac: up to 1733.4 Mbps IEEE 802.11ax: up to 2402 Mbps
Output Power Max. for UNII-1	For Main Ant.: IEEE 802.11a: 20.58 dBm (0.1143 W) For Aux Ant.: IEEE 802.11a: 20.83 dBm (0.1211 W) For MIMO: IEEE 802.11n (HT20): 20.87 dBm (0.1222 W) IEEE 802.11n (HT40): 20.45 dBm (0.1109 W) IEEE 802.11ac (VHT80): 18.67 dBm (0.0737 W) IEEE 802.11ax (HE20): 21.50 dBm (0.1412 W) IEEE 802.11ax (HE40): 21.74 dBm (0.1492 W) IEEE 802.11ax (HE80): 18.46 dBm (0.0701 W)
Output Power Max. for UNII-2A	For Main Ant.: IEEE 802.11a: 20.67 dBm (0.1167 W) For Aux Ant.: IEEE 802.11a: 20.86 dBm (0.1219 W) For MIMO: IEEE 802.11n (HT20): 21.23 dBm (0.1326 W) IEEE 802.11n (HT40): 20.56 dBm (0.1138 W) IEEE 802.11ac (VHT80): 19.21 dBm (0.0833 W) IEEE 802.11ax (HE20): 21.51 dBm (0.1415 W) IEEE 802.11ax (HE40): 22.96 dBm (0.1977 W) IEEE 802.11ax (HE80): 18.09 dBm (0.0644 W)
Output Power Max. for UNII-1+ UNII-2A	IEEE 802.11ac (VHT160): 15.16 dBm (0.0328 W) IEEE 802.11ax (HE160): 15.87 dBm (0.0387 W)

Output Power Max. for UNII-2C	For Main Ant.: IEEE 802.11a: 20.90 dBm (0.1230 W) For Aux Ant.: IEEE 802.11a: 20.69 dBm (0.1172 W) For MIMO: IEEE 802.11n (HT20): 21.33 dBm (0.1357 W) IEEE 802.11n (HT40): 23.67 dBm (0.2328 W) IEEE 802.11ac (VHT80): 23.30 dBm (0.2136 W) IEEE 802.11ac (VHT160): 16.37 dBm (0.0434 W) IEEE 802.11ax (HE20): 21.77 dBm (0.1502 W) IEEE 802.11ax (HE40): 23.68 dBm (0.2332 W) IEEE 802.11ax (HE80): 22.62 dBm (0.1826 W) IEEE 802.11ax (HE160): 17.84 dBm (0.0608 W)
Output Power Max. for UNII-3	For Main Ant.: IEEE 802.11a: 20.94 dBm (0.1242 W) For Aux Ant.: IEEE 802.11a: 20.77 dBm (0.1194 W) For MIMO: IEEE 802.11n (HT20): 23.77 dBm (0.2380 W) IEEE 802.11n (HT40): 23.74 dBm (0.2356 W) IEEE 802.11ac (VHT80): 20.95 dBm (0.1245 W) IEEE 802.11ax (HE20): 23.85 dBm (0.2427 W) IEEE 802.11ax (HE40): 23.83 dBm (0.2413 W) IEEE 802.11ax (HE80): 21.08 dBm (0.1282 W)
Test Model	RZ09-0485
Sample Status	Engineering Sample
EUT Modification(s)	N/A

NOTE:

(1) The above EUT information is declared by manufacturer and for more detailed features description, please refers to the manufacturer's specifications or user's manual.

(2) Channel List:

IEEE 802.11a IEEE 802.11n(HT20) IEEE 802.11ac(VHT20) IEEE 802.11ax(HE20)		IEEE 802.11n(HT40) IEEE 802.11ac(VHT40) IEEE 802.11ax(HE40)		IEEE 802.11ac(VHT80) IEEE 802.11ax(HE80)	
UNII-1		UNII-1		UNII-1	
Channel	Frequency (MHz)	Channel	Frequency (MHz)	Channel	Frequency (MHz)
36	5180	38	5190	42	5210
40	5200	46	5230		
44	5220				
48	5240				

IEEE 802.11a IEEE 802.11n(HT20) IEEE 802.11ac(VHT20) IEEE 802.11ax(HE20)		IEEE 802.11n(HT40) IEEE 802.11ac(VHT40) IEEE 802.11ax(HE40)		IEEE 802.11ac(VHT80) IEEE 802.11ax(HE80)	
UNII-2A		UNII-2A		UNII-2A	
Channel	Frequency (MHz)	Channel	Frequency (MHz)	Channel	Frequency (MHz)
52	5260	54	5270	58	5290
56	5280	62	5310		
60	5300				
64	5320				

IEEE 802.11ac(VHT160) IEEE 802.11ax(HE160)	
UNII-1+ UNII-2A	
Channel	Frequency (MHz)
50	5250

IEEE 802.11a IEEE 802.11n(HT20) IEEE 802.11ac(VHT20) IEEE 802.11ax(HE20)		IEEE 802.11n(HT40) IEEE 802.11ac(VHT40) IEEE 802.11ax(HE40)		IEEE 802.11ac(VHT80) IEEE 802.11ax(HE80)	
UNII-2C		UNII-2C		UNII-2C	
Channel	Frequency (MHz)	Channel	Frequency (MHz)	Channel	Frequency (MHz)
100	5500	102	5510	106	5530
104	5520	110	5550	122	5610
108	5540	118	5590		
112	5560	126	5630		
116	5580	134	5670		
120	5600				
124	5620				
128	5640				
132	5660				
136	5680				
140	5700				

IEEE 802.11ac(VHT160) IEEE 802.11ax(HE160)	
UNII-2C	
Channel	Frequency (MHz)
114	5570

IEEE 802.11a IEEE 802.11n(HT20) IEEE 802.11ac(VHT20) IEEE 802.11ax(HE20)		IEEE 802.11n(HT40) IEEE 802.11ac(VHT40) IEEE 802.11ax(HE40)		IEEE 802.11ac(VHT80) IEEE 802.11ax(HE80)	
UNII-3		UNII-3		UNII-3	
Channel	Frequency (MHz)	Channel	Frequency (MHz)	Channel	Frequency (MHz)
149	5745	151	5755	155	5775
153	5765	159	5795		
157	5785				
161	5805				
165	5825				

(3) Table for Filed Antenna:

Ant.	Manufacturer	P/N	Type	Connector	Gain (dBi)
1	Amphenol	BY5973-15-001-C	PIFA	N/A	3.76
2	Amphenol	BY5962-15-001-C	PIFA	N/A	3.59

Note:

- 1) This EUT supports MIMO 2X2, any transmit signals are uncorrelated with each other, so Directional gain= $10\log[(10^{G1/10}+10^{G2/10}+...+10^{GN/10})/N]$ dBi, that is Directional gain= $10\log[(10^{3.76/10}+10^{3.59/10})/2]$ dBi=3.68.
 - 2) Ant.1 refers to main antenna, Ant.2 refers to aux antenna.
 - 3) The AUX antenna connector of the module connected to the MAIN antenna of the EUT and the MAIN antenna connector of the module connected to the AUX antenna of the EUT.
- (4) The above Antenna information are derived from the antenna data sheet provided by manufacturer and for more detailed features description, please refer to the manufacturer's specifications, the laboratory shall not be held responsible.

2.2 TEST MODES

Test Items	Test mode	Channel	Note
AC power line conducted emissions	Normal/Idle	-	-
Transmitter Radiated Emissions (below 1GHz)	TX Mode_IEEE 802.11ac (VHT80)	155	-
Transmitter Radiated Emissions (above 1GHz)	TX Mode_IEEE 802.11a	48/52/140/149	Bandedge
	TX Mode_IEEE 802.11ac (VHT80)	42/58/122/155	
	TX Mode_IEEE 802.11ax (HE160)	50/114	
	TX Mode_IEEE 802.11a	48/56/120/149	Harmonic
	TX Mode_IEEE 802.11ac (VHT80)	42/58/122/155	
	TX Mode_IEEE 802.11ax (HE160)	50/114	
Output Power	TX Mode_IEEE 802.11a	36/40/48 52/60/64	-
	TX Mode_IEEE 802.11n (HT20) TX Mode_IEEE 802.11ax (HE20)	100/116/140 149/157/165	
	TX Mode_IEEE 802.11n (HT40) TX Mode_IEEE 802.11ax (HE40)	38/46/ 54/62 102/110/134 151/159	
	TX Mode_IEEE 802.11ac (VHT80) TX Mode_IEEE 802.11ax (HE80)	42, 58 106/122, 155	
	TX Mode_IEEE 802.11ac (VHT160) TX Mode_IEEE 802.11ax (HE160)	50/114	

NOTE:

- (1) For radiated emission band edge test, both Vertical and Horizontal are evaluated, but only the worst case (Vertical) is recorded.

2.3 BLOCK DIAGRAM SHOWING THE CONFIGURATION OF SYSTEM TESTED

Equipment letters and Cable numbers refer to item numbers described in the tables of clause 2.4.

AC power line conducted emissions

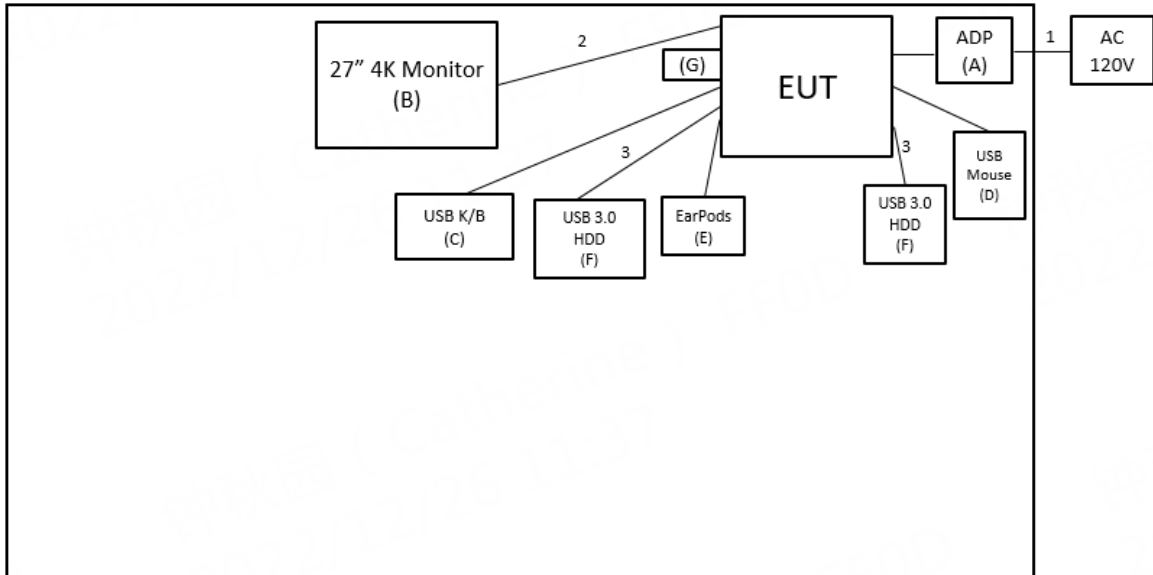

Radiated Emissions

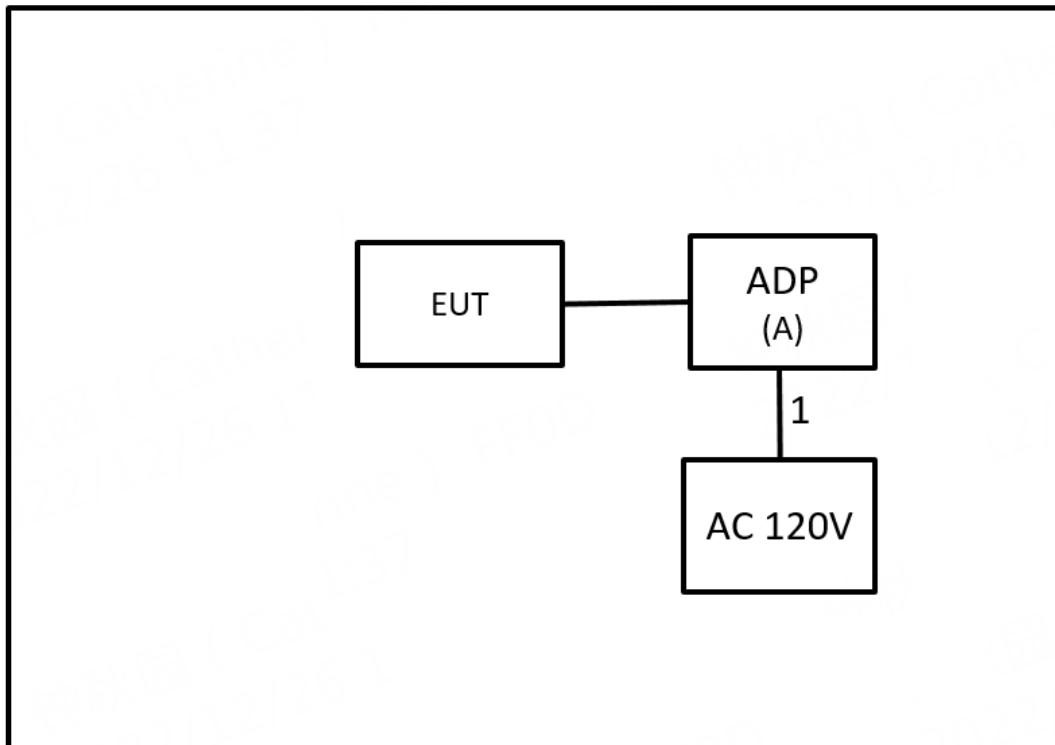

2.4 SUPPORT UNITS

AC power line conducted emissions

Item	Equipment	Brand	Model No.	Series No.	Remarks
A	ADP	Razer	RC30-024801	N/A	Supplied by test requester.
B	27" 4K Monitor	DELL	U2720Q	CN-083VF-WSL00-0 B7-332L	Furnished by test lab.
C	USB K/B	DELL	KB216t	CN-0W33XP-L0300- 797-05TY-A03	Furnished by test lab.
D	USB Mouse	DELL	MOCZUL	CN-049TWY-PRC00- 79E-01HA	Furnished by test lab.
E	EarPods	Apple	A1472	N/A	Furnished by test lab.
F	USB 3.0 HDD	WD	WDBC3C0010BSL-0B	WX81A88ALJUC	Furnished by test lab.
G	USB Dongle	Kingston	DataTraveler Exodia	N/A	Furnished by test lab.

Item	Shielded	Ferrite Core	Length	Cable Type	Remarks
1	No	No	1.2m	Power Cable	Supplied by test requester.
2	No	No	1.7m	HDMI Cable	Furnished by test lab.
3	No	No	18cm	TypeC to TypeC Cable	Furnished by test lab.

Radiated Emissions

Item	Equipment	Brand	Model No.	Series No.	Remarks
A	ADP	Razer	RC30-024801	N/A	Supplied by test requester.

Item	Shielded	Ferrite Core	Length	Cable Type	Remarks
1	N/A	N/A	1m	Power Cable	Supplied by test requester.

3 AC POWER LINE CONDUCTED EMISSIONS TEST

3.1 LIMIT

Frequency (MHz)	Limit (dB μ V)	
	Quasi-peak	Average
0.15 - 0.5	66 - 56 *	56 - 46 *
0.50 - 5.0	56	46
5.0 - 30.0	60	50

NOTE:

- (1) The tighter limit applies at the band edges.
- (2) The limit of " * " marked band means the limitation decreases linearly with the logarithm of the frequency in the range.
- (3) The test result calculated as following:
 Measurement Value = Reading Level + Correct Factor
 Correct Factor = Insertion Loss + Cable Loss + Attenuator Factor (if use)
 Margin Level = Measurement Value – Limit Value
 Calculation example:

Reading Level		Correct Factor		Measurement Value
38.22	+	3.45	=	41.67

Measurement Value		Limit Value		Margin Level
41.67	-	60	=	-18.33

The following table is the setting of the receiver.

Receiver Parameter	Setting
Attenuation	10 dB
Start Frequency	0.15 MHz
Stop Frequency	30 MHz
IF Bandwidth	9 KHz

3.2 TEST PROCEDURE

- a. The EUT was placed 0.8 m above the horizontal ground plane with the EUT being connected to the power mains through a line impedance stabilization network (LISN).
 All other support equipment were powered from an additional LISN(s).
 The LISN provides 50 Ohm/50uH of impedance for the measuring instrument.
- b. Interconnecting cables that hang closer than 40 cm to the ground plane shall be folded back and forth in the center forming a bundle to keep the cable above 40 cm.
- c. Excess I/O cables that are not connected to a peripheral shall be bundled in the center.
 The end of the cable will be terminated, using the correct terminating impedance.
 The overall length shall not exceed 1 m.
- d. The LISN is spaced at least 80 cm from the nearest part of the EUT chassis.
- e. For the actual test configuration, please refer to the related Item - EUT TEST PHOTO.

NOTE:

- (1) In the results, each reading is marked as Peak, QP or AVG per the detector used.
 BW=9 kHz (6 dB Bandwidth)
- (2) All readings are Peak unless otherwise stated QP or AVG in column of Note. Both the QP and the AVG readings must be less than the limit for compliance.

3.3 DEVIATION FROM TEST STANDARD

No deviation.

3.4 TEST SETUP

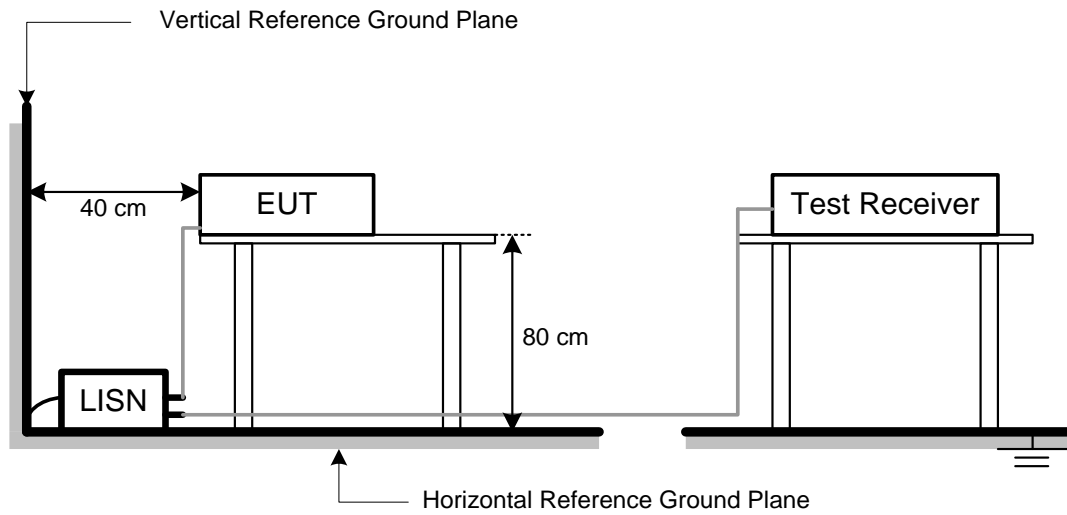

3.5 TEST RESULT

Please refer to the APPENDIX A.

4 RADIATED EMISSIONS TEST

4.1 LIMIT

In case the emission fall within the restricted band specified on 15.205, then the 15.209 limit in the table below has to be followed.

LIMITS OF RADIATED EMISSIONS MEASUREMENT (9 kHz to 1000 MHz)

Frequency (MHz)	Field Strength (microvolts/meter)	Measurement Distance (meters)
0.009~0.490	2400/F(KHz)	300
0.490~1.705	24000/F(KHz)	30
1.705~30.0	30	30
30~88	100	3
88~216	150	3
216~960	200	3
960~1000	500	3

LIMITS OF UNWANTED EMISSION OUT OF THE RESTRICTED BANDS

Frequency (MHz)	EIRP Limit (dBm)	Equivalent Field Strength at 3m (dBμV/m)
5150-5250	-27	68.3
5250-5350	-27	68.3
5470-5725	-27	68.3
5725-5850	-27 (NOTE 2)	68.3
	10 (NOTE 2)	105.3
	15.6 (NOTE 2)	110.9
	27 (NOTE 2)	122.3

NOTE:

(1) The following formula is used to convert the equipment isotropic radiated power (eirp) to field strength:

$$E = \frac{1000000\sqrt{30P}}{3} \mu\text{V/m, where P is the eirp (Watts)}$$

(2) According to FCC 16-24, All emissions shall be limited to a level of -27 dBm/MHz at 75 MHz or more above or below the band edge increasing linearly to 10 dBm/MHz at 25 MHz above or below the band edge, and from 25 MHz above or below the band edge increasing linearly to a level of 15.6 dBm/MHz at 5 MHz above or below the band edge, and from 5 MHz above or below the band edge increasing linearly to a level of 27 dBm/MHz at the band edge.

(3) The test result calculated as following:

Measurement Value = Reading Level + Correct Factor

Correct Factor = Antenna Factor + Cable Loss - Amplifier Gain(if use)

Margin Level = Measurement Value - Limit Value

Calculation example:

Reading Level		Correct Factor		Measurement Value
36.23	+	-11.97	=	24.26

Measurement Value		Limit Value		Margin Level
24.26	-	40	=	-15.74

Spectrum Parameter	Setting
Attenuation	Auto
Start Frequency	1000 MHz
Stop Frequency	10th carrier harmonic
RBW / VBW (Emission in restricted band)	1MHz / 3MHz for Peak, 1MHz / 1/T for Average

Spectrum Parameter	Setting
Attenuation	Auto
Start ~ Stop Frequency	9KHz~90KHz for PK/AVG detector
Start ~ Stop Frequency	90KHz~110KHz for QP detector
Start ~ Stop Frequency	110KHz~490KHz for PK/AVG detector
Start ~ Stop Frequency	490KHz~30MHz for QP detector
Start ~ Stop Frequency	30MHz~1000MHz for QP detector

4.2 TEST PROCEDURE

- a. The measuring distance of 3 m shall be used for measurements. The EUT was placed on the top of a rotating table 0.8 meter above the ground at a 3 meter semi-anechoic chamber. The table was rotated 360 degrees to determine the position of the highest radiation.(below 1GHz)
- b. The measuring distance of 3 m shall be used for measurements. The EUT was placed on the top of a rotating table 1.5 meter above the ground at a 3 meter semi-anechoic chamber. The table was rotated 360 degrees to determine the position of the highest radiation.(above 1GHz)
- c. The height of the equipment or of the substitution antenna shall be 0.8 m or 1.5 m, the height of the test antenna shall vary between 1 m to 4 m. Both horizontal and vertical polarizations of the antenna are set to make the measurement.
- d. For each suspected emission, the EUT was arranged to its worst case and then the antenna was tuned to heights find the maximum reading (used Bore sight function).
- e. The receiver system was set to peak and average detect function and specified bandwidth with maximum hold mode when the test frequency is above 1GHz.
- f. The initial step in collecting radiated emission data is a receiver peak detector mode pre-scanning the measurement frequency range. Significant peaks are then marked and then Quasi Peak detector mode re-measured.
- g. All readings are Peak unless otherwise stated QP in column of Note. Peak denotes that the Peak reading compliance with the QP Limits and then QP Mode measurement didn't perform. (below 1GHz)
- h. All readings are Peak Mode value unless otherwise stated AVG in column of Note. If the Peak Mode Measured value compliance with the Peak Limits and lower than AVG Limits, the EUT shall be deemed to meet both Peak & AVG Limits and then only Peak Mode was measured, but AVG Mode didn't perform. (above 1GHz)
- i. For the actual test configuration, please refer to the related Item – EUT TEST PHOTO.

4.3 DEVIATION FROM TEST STANDARD

No deviation.

4.4 TEST SETUP

9 kHz to 30 MHz

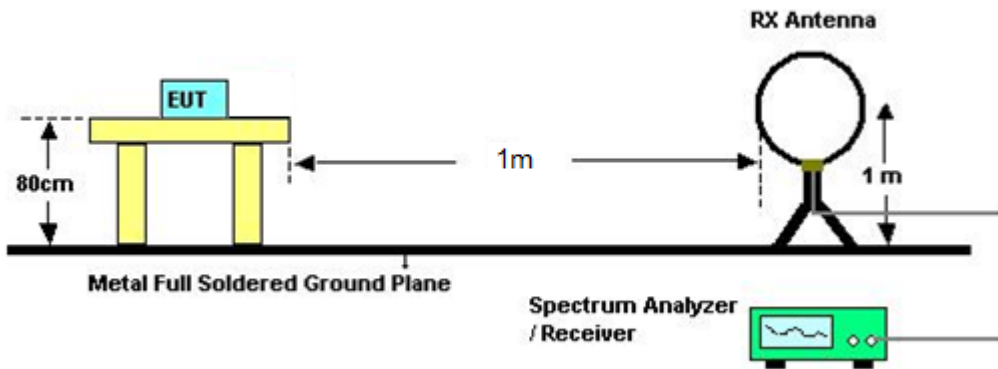

30 MHz to 1 GHz

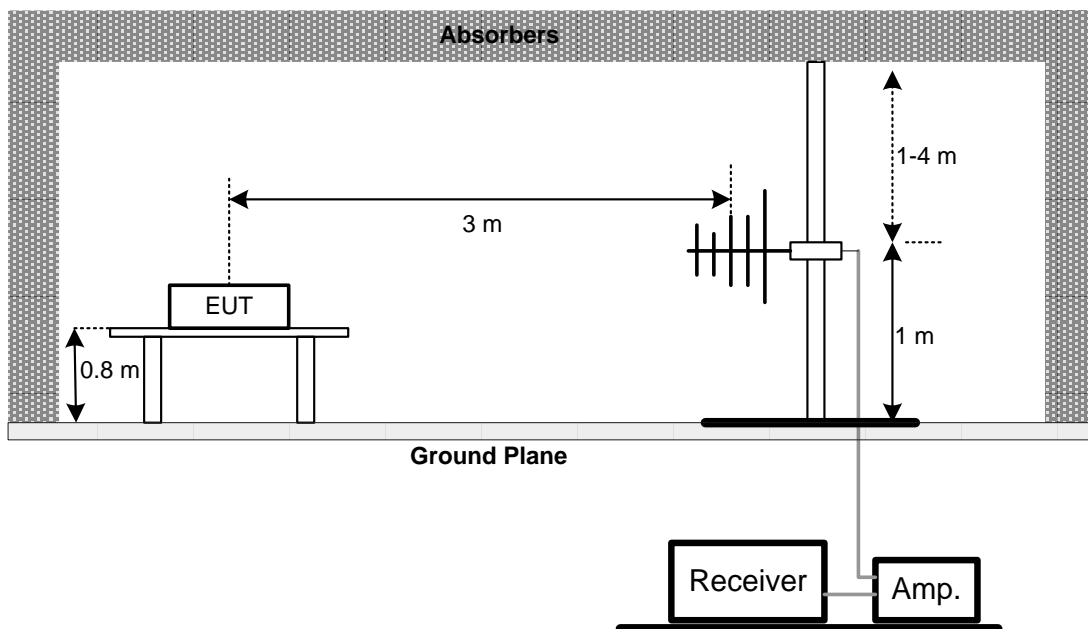

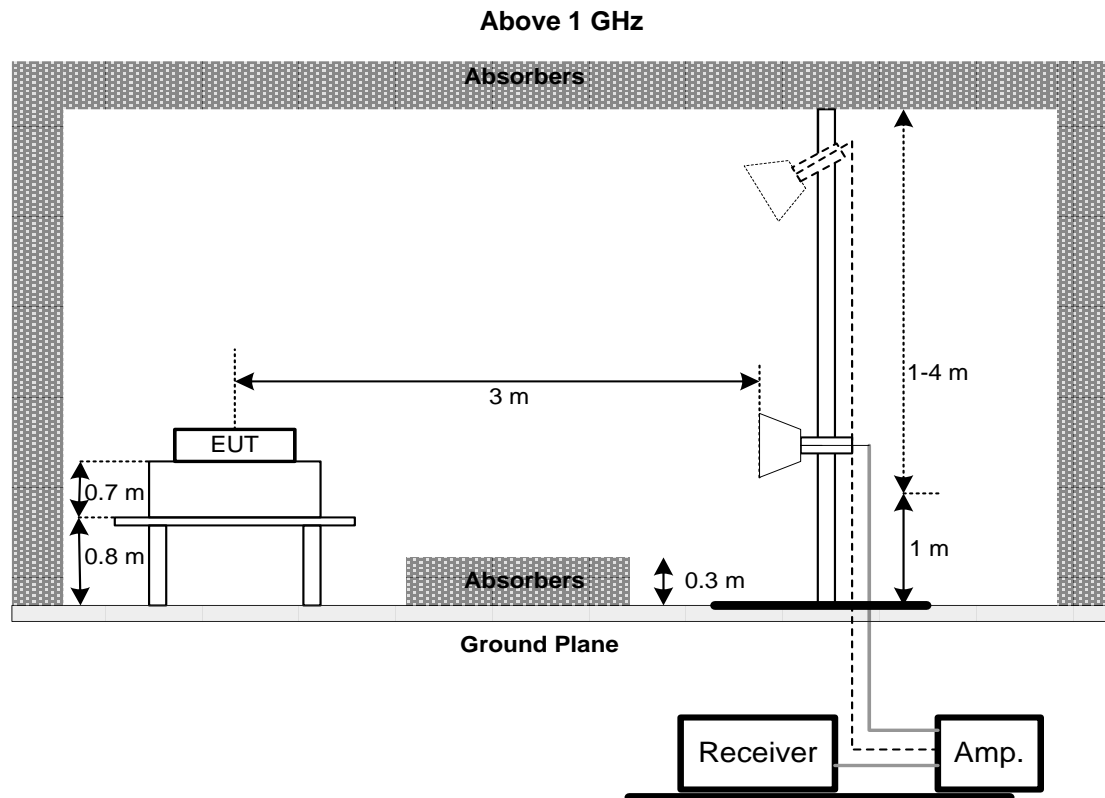

4.5 EUT OPERATING CONDITIONS

The EUT was programmed to be in continuously transmitting mode.

4.6 TEST RESULT – BELOW 30 MHZ

There were no emissions found below 30 MHz within 20 dB of the limit.

4.7 TEST RESULT – 30 MHZ TO 1 GHZ

Please refer to the APPENDIX B.

4.8 TEST RESULT – ABOVE 1 GHZ

Please refer to the APPENDIX C.

NOTE:

- (1) No limit: This is fundamental signal, the judgment is not applicable. For fundamental signal judgment was referred to Peak output test.

5 OUTPUT POWER TEST

5.1 LIMIT

FCC Part15, Subpart E (15.407)			
Section	Test Item	Limit	Frequency Range (MHz)
15.407(a)	Maximum Output Power	Fixed:1 Watt (30 dBm) Mobile and portable: 250 mW (24 dBm)	5150-5250
		250 mW or 11 dBm + 10 log B, where B is the 26 dB emission bandwidth in megahertz	5250-5350
			5470-5725
		1 Watt (30dBm)	5725-5850

Note: The maximum e.i.r.p at any elevation angle above 30 degrees as measured from the horizon must not exceed 125 mW(21 dBm).

5.2 TEST PROCEDURE

- The EUT was directly connected to the power meter and antenna output port as show in the block diagram below.
- Method PM-G (Measurement using a gated RF average power meter):
Measurements may be performed using a wideband gated RF power meter provided that the gateparameters are adjusted such that the power is measured only when the EUT is transmitting at itsmaximum power control level. Since the measurement is made only during the ON time of thetransmitter, no duty cycle correction factor is required.

5.3 DEVIATION FROM TEST STANDARD

No deviation.

5.4 TEST SETUP

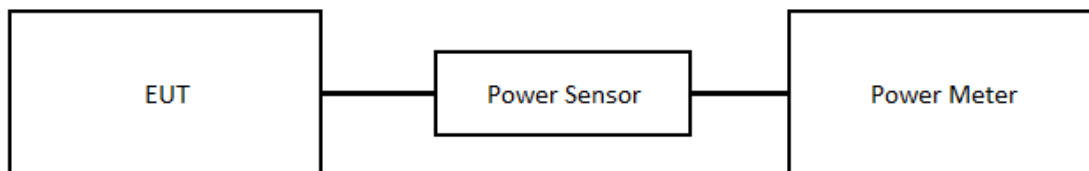

5.5 EUT OPERATING CONDITIONS

The EUT was programmed to be in continuously transmitting mode.

5.6 TEST RESULT

Please refer to the APPENDIX D.

6 LIST OF MEASURING EQUIPMENTS

AC Power Line Conducted Emissions						
Item	Kind of Equipment	Manufacturer	Type No.	Serial No.	Calibrated Date	Calibrated Until
1	TWO-LINE V-NETWORK	R&S	ENV216	101521	2022/9/28	2023/9/27
2	Test Cable	EMCI	EMCCFD300-BM-BMR-5000	220331	2022/3/31	2023/3/30
3	EMI Test Receiver	R&S	ESR 7	101433	2022/11/16	2023/11/15
4	Measurement Software	EZ	EZ EMC (Version NB-03A1-01)	N/A	N/A	N/A

Radiated Emissions						
Item	Kind of Equipment	Manufacturer	Type No.	Serial No.	Calibrated Date	Calibrated Until
1	Preamplifier	EMCI	EMC330N	980850	2022/9/19	2023/9/18
2	Preamplifier	EMCI	EMC118A45SE	980819	2022/3/8	2023/3/7
3	Preamplifier	EMCI	EMC184045SE	980882	2022/2/9	2023/2/8
4	Preamplifier	EMCI	EMC001340	980579	2022/9/30	2023/9/29
5	Test Cable	EMCI	EMC104-SM-SM-1000	220319	2022/3/15	2023/3/14
6	Test Cable	EMCI	EMC104-SM-SM-3000	220322	2022/3/15	2023/3/14
7	Test Cable	EMCI	EMC104-SM-SM-7000	220324	2022/3/15	2023/3/14
8	EXA Signal Analyzer	keysight	N9020B	MY57120120	2022/3/7	2023/3/6
9	Loop Ant	Electro-Metrics	EMCI-LPA600	291	2022/9/19	2023/9/18
10	Horn Antenna	RFSPIN	DRH18-E	211202A18EN	2022/5/18	2023/5/17
11	Horn Ant	Schwarzbeck	BBHA 9170D	1136	2022/5/18	2023/5/17
12	Log-bicon Antenna	Schwarzbeck	VULB9168	1369	2022/5/20	2023/5/19
13	6dB Attenuator	EMCI	EMCI-N-6-06	AT-N0625	2022/5/20	2023/5/19
14	Test Cable	EMCI	EMC101G-KM-KM-3000	220329	2022/3/15	2023/3/14
15	Test Cable	EMCI	EMC102-KM-KM-1000	220327	2022/3/15	2023/3/14
16	Measurement Software	EZ	EZ EMC (Version NB-03A1-01)	N/A	N/A	N/A

Output Power						
Item	Kind of Equipment	Manufacturer	Type No.	Serial No.	Calibrated Date	Calibrated Until
1	Power Meter	Anritsu	ML2495A	1128008	2022/6/1	2023/5/31
2	Power Sensor	Anritsu	MA2411B	1126001	2022/6/1	2023/5/31

Remark: "N/A" denotes no model name, no serial no. or no calibration specified.
All calibration period of equipment list is one year.

7 EUT TEST PHOTO

Please refer to document Appendix No.: TP-2211C022-1 (APPENDIX-TEST PHOTOS).

8 EUT PHOTOS

Please refer to document Appendix No.: EP-2211C022-1 (APPENDIX-EUT PHOTOS).

APPENDIX A AC POWER LINE CONDUCTED EMISSIONS

Test Mode	Normal	Tested Date	2022/12/21
Test Frequency	-	Phase	Line

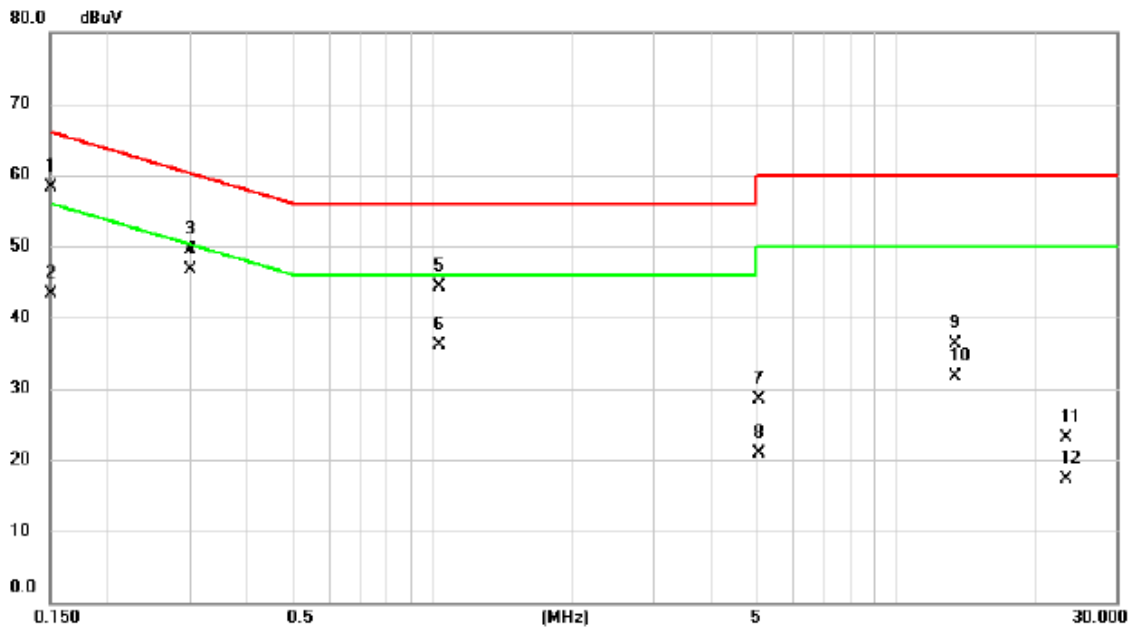

No.	Mk.	Freq.	Reading Level	Correct Factor	Measurement	Limit	Margin	Detector	Comment
		MHz	dBuV	dB	dBuV	dBuV	dB		
1		0.1500	48.68	9.63	58.31	66.00	-7.69	QP	
2		0.1500	33.76	9.63	43.39	56.00	-12.61	AVG	
3		0.3007	39.94	9.65	49.59	60.22	-10.63	QP	
4	*	0.3007	36.97	9.65	46.62	50.22	-3.60	AVG	
5		1.0320	34.66	9.70	44.36	56.00	-11.64	QP	
6		1.0320	26.41	9.70	36.11	46.00	-9.89	AVG	
7		5.0775	18.56	9.85	28.41	60.00	-31.59	QP	
8		5.0775	11.04	9.85	20.89	50.00	-29.11	AVG	
9		13.4812	26.25	9.98	36.23	60.00	-23.77	QP	
10		13.4812	21.72	9.98	31.70	50.00	-18.30	AVG	
11		23.3250	13.12	10.05	23.17	60.00	-36.83	QP	
12		23.3250	7.34	10.05	17.39	50.00	-32.61	AVG	

REMARKS:

- (1) Measurement Value = Reading Level + Correct Factor.
- (2) Margin Level = Measurement Value - Limit Value.

Test Mode	Normal	Tested Date	2022/12/21
Test Frequency	-	Phase	Neutral

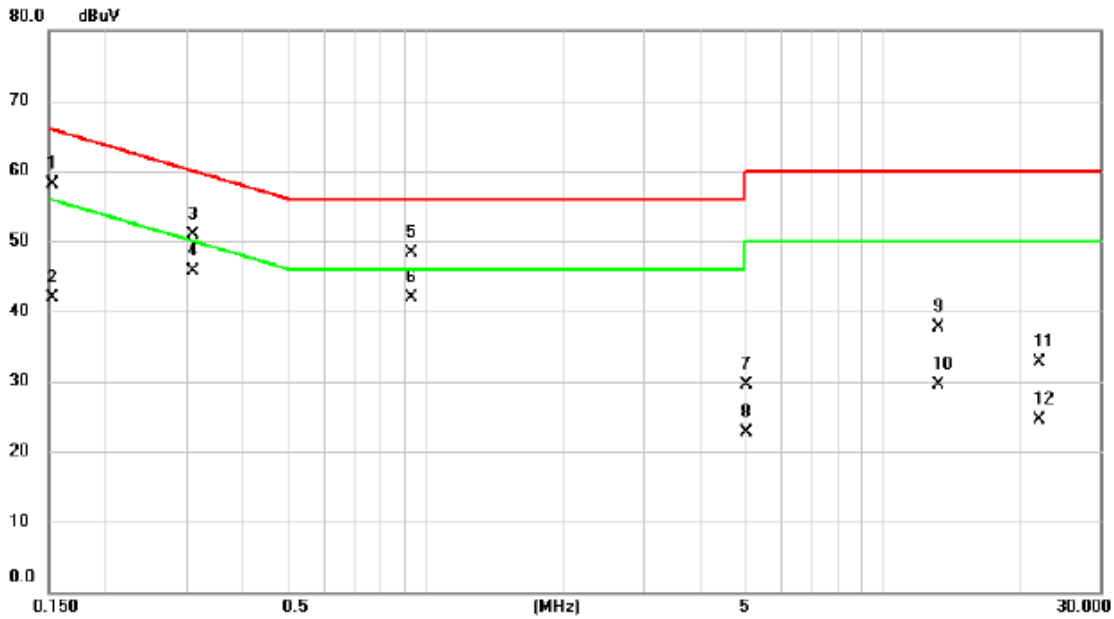

No.	Mk.	Freq. MHz	Reading Level dBuV	Correct Factor dB	Measure- ment dBuV	Limit dBuV	Margin dB	Detector	Comment
1		0.1522	48.46	9.65	58.11	65.88	-7.77	QP	
2		0.1522	32.29	9.65	41.94	55.88	-13.94	AVG	
3		0.3097	41.28	9.66	50.94	59.98	-9.04	QP	
4		0.3097	35.96	9.66	45.62	49.98	-4.36	AVG	
5		0.9307	38.59	9.71	48.30	56.00	-7.70	QP	
6	*	0.9307	32.23	9.71	41.94	46.00	-4.06	AVG	
7		5.0460	19.71	9.86	29.57	60.00	-30.43	QP	
8		5.0460	12.90	9.86	22.76	50.00	-27.24	AVG	
9		13.2360	27.64	10.04	37.68	60.00	-22.32	QP	
10		13.2360	19.38	10.04	29.42	50.00	-20.58	AVG	
11		22.0740	22.53	10.19	32.72	60.00	-27.28	QP	
12		22.0740	14.23	10.19	24.42	50.00	-25.58	AVG	

REMARKS:

- (1) Measurement Value = Reading Level + Correct Factor.
- (2) Margin Level = Measurement Value - Limit Value.

Test Mode	Idle	Tested Date	2022/12/21
Test Frequency	-	Phase	Line

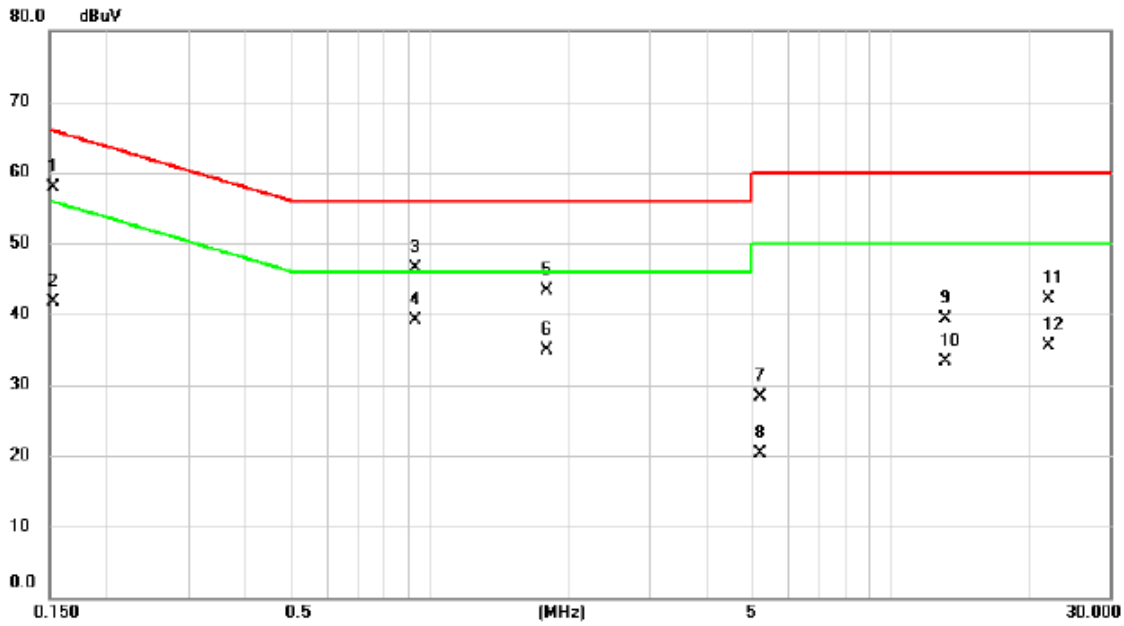

No.	Mk.	Freq.	Reading Level	Correct Factor	Measurement	Limit	Margin	Detector	Comment
		MHz	dBuV	dB	dBuV	dBuV	dB		
1		0.1522	48.32	9.64	57.96	65.88	-7.92	QP	
2		0.1522	32.05	9.64	41.69	55.88	-14.19	AVG	
3		0.9330	36.89	9.70	46.59	56.00	-9.41	QP	
4	*	0.9330	29.35	9.70	39.05	46.00	-6.95	AVG	
5		1.7970	33.55	9.73	43.28	56.00	-12.72	QP	
6		1.7970	25.24	9.73	34.97	46.00	-11.03	AVG	
7		5.2125	18.44	9.85	28.29	60.00	-31.71	QP	
8		5.2125	10.51	9.85	20.36	50.00	-29.64	AVG	
9		13.2045	29.34	9.98	39.32	60.00	-20.68	QP	
10		13.2045	23.32	9.98	33.30	50.00	-16.70	AVG	
11		21.9975	32.12	10.04	42.16	60.00	-17.84	QP	
12		21.9975	25.37	10.04	35.41	50.00	-14.59	AVG	

REMARKS:

- (1) Measurement Value = Reading Level + Correct Factor.
- (2) Margin Level = Measurement Value - Limit Value.

Test Mode	Idle	Tested Date	2022/12/21
Test Frequency	-	Phase	Neutral

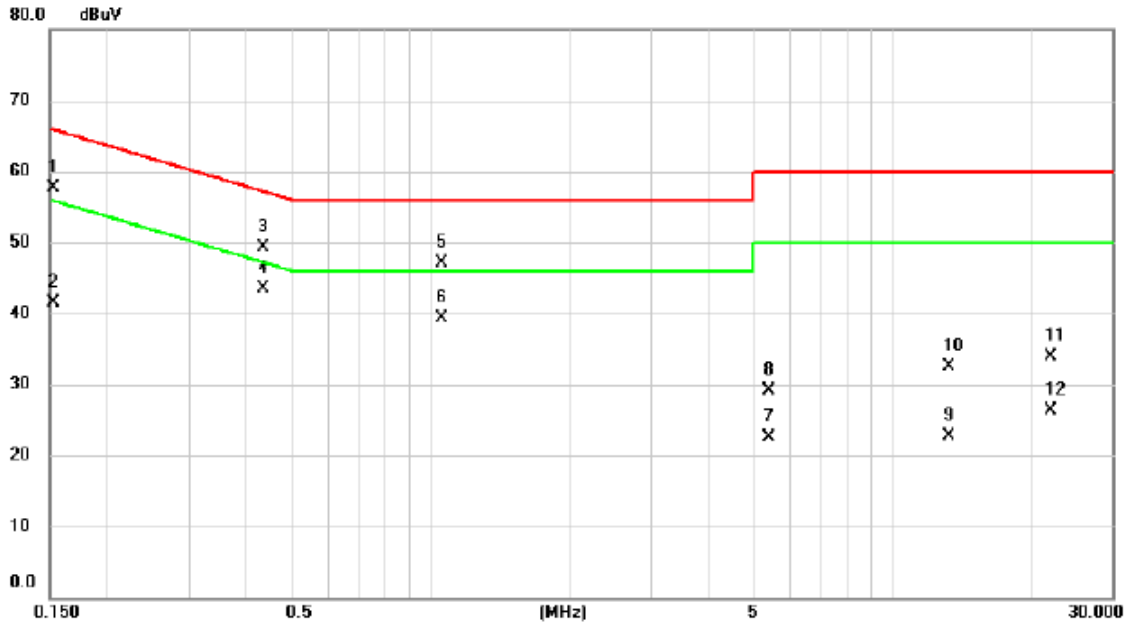

No.	Mk.	Freq. MHz	Reading Level dBuV	Correct Factor dB	Measure- ment dBuV	Limit dBuV	Margin dB	Detector	Comment
1		0.1522	47.98	9.65	57.63	65.88	-8.25	QP	
2		0.1522	31.85	9.65	41.50	55.88	-14.38	AVG	
3		0.4357	39.70	9.67	49.37	57.14	-7.77	QP	
4	*	0.4357	33.76	9.67	43.43	47.14	-3.71	AVG	
5		1.0611	37.44	9.71	47.15	56.00	-8.85	QP	
6		1.0611	29.50	9.71	39.21	46.00	-6.79	AVG	
7		5.4082	12.65	9.87	22.52	60.00	-37.48	QP	
8		5.4082	19.26	9.87	29.13	50.00	-20.87	AVG	
9		13.2247	12.58	10.04	22.62	60.00	-37.38	QP	
10		13.2247	22.38	10.04	32.42	50.00	-17.58	AVG	
11		22.0335	23.68	10.19	33.87	60.00	-26.13	QP	
12		22.0335	16.04	10.19	26.23	50.00	-23.77	AVG	

REMARKS:

- (1) Measurement Value = Reading Level + Correct Factor.
- (2) Margin Level = Measurement Value - Limit Value.

APPENDIX B RADIATED EMISSIONS - 30 MHZ TO 1 GHZ

Test Mode	IEEE 802.11ac (VHT80)	Test Date	2023/1/19
Test Frequency	5775MHz	Polarization	Vertical
Temp	23°C	Hum.	59%

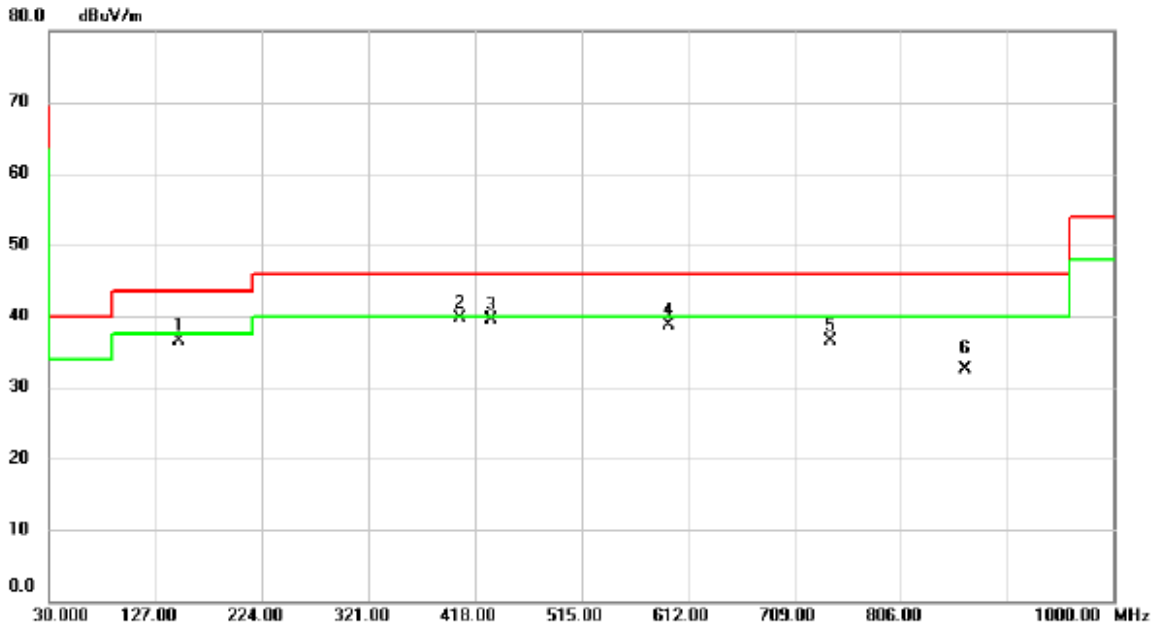

No.	Mk.	Freq. MHz	Reading Level dBuV	Correct Factor dB	Measure- ment dBuV/m	Limit dBuV/m	Over dB	Detector	Comment
1		148.5016	48.46	-11.90	36.56	43.50	-6.94	peak	
2	*	404.6463	48.30	-8.65	39.65	46.00	-6.35	peak	
3		432.3560	47.31	-7.89	39.42	46.00	-6.58	peak	
4		593.9903	42.97	-4.34	38.63	46.00	-7.37	peak	
5		742.4973	38.20	-1.74	36.46	46.00	-9.54	peak	
6		864.4910	32.77	-0.29	32.48	46.00	-13.52	QP	

REMARKS:

- (1) Measurement Value = Reading Level + Correct Factor.
- (2) Margin Level = Measurement Value - Limit Value.

Test Mode	IEEE 802.11ac (VHT80)	Test Date	2023/1/19
Test Frequency	5775MHz	Polarization	Horizontal
Temp	23°C	Hum.	59%

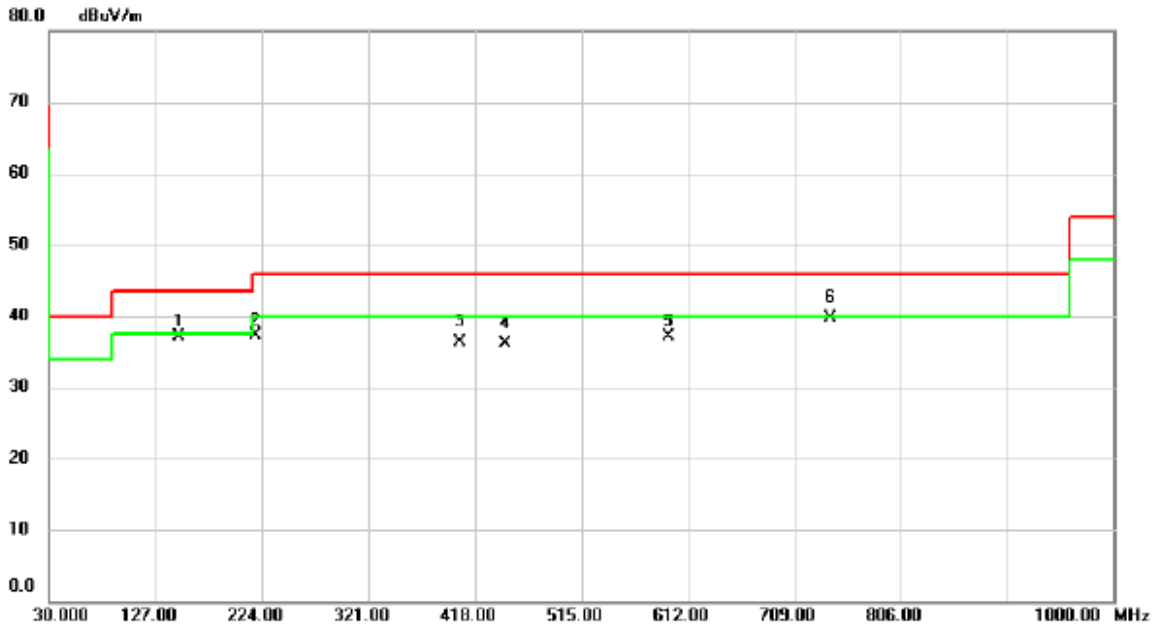

No.	Mk.	Freq. MHz	Reading Level dBuV	Correct Factor dB	Measure- ment dBuV/m	Limit dBuV/m	Over dB	Detector	Comment
1	*	148.5016	49.01	-11.90	37.11	43.50	-6.39	peak	
2		218.4386	52.61	-15.34	37.27	46.00	-8.73	peak	
3		404.8725	45.02	-8.64	36.38	46.00	-9.62	QP	
4		445.4833	43.64	-7.53	36.11	46.00	-9.89	QP	
5		593.9580	41.42	-4.34	37.08	46.00	-8.92	peak	
6		742.4973	41.35	-1.74	39.61	46.00	-6.39	QP	

REMARKS:

- (1) Measurement Value = Reading Level + Correct Factor.
- (2) Margin Level = Measurement Value - Limit Value.

APPENDIX C RADIATED EMISSIONS - ABOVE 1 GHZ

Test Mode	IEEE 802.11a	Test Date	2022/12/6
Test Frequency	5240MHz	Polarization	Vertical
Temp	23°C	Hum.	59%

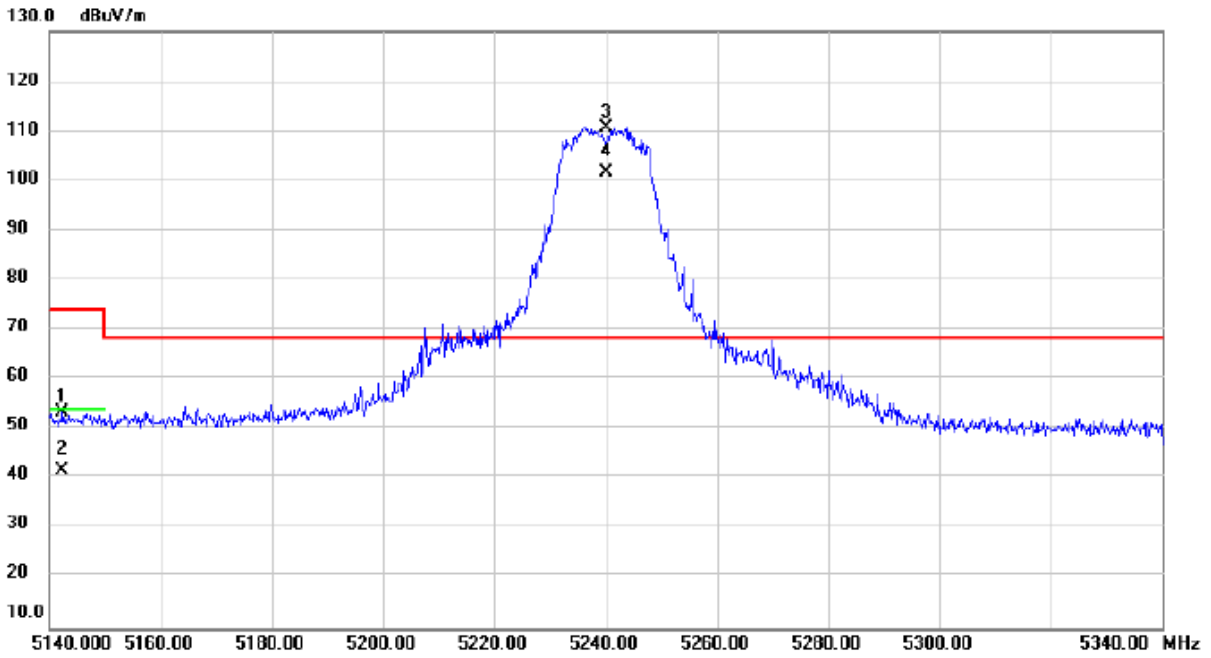

No.	Mk.	Freq. MHz	Reading Level dBuV	Correct Factor dB	Measure- ment dBuV/m	Limit dBuV/m	Over dB	Detector	Comment
1		5142.233	51.93	1.37	53.30	74.00	-20.70	peak	
2		5142.233	40.29	1.37	41.66	54.00	-12.34	AVG	
3	*	5240.000	109.37	1.40	110.77	68.20	42.57	peak	No Limit
4	X	5240.000	100.13	1.40	101.53	68.20	33.33	AVG	No Limit

REMARKS:

- (1) Measurement Value = Reading Level + Correct Factor.
- (2) Margin Level = Measurement Value - Limit Value.

Test Mode	IEEE 802.11a	Test Date	2022/12/6
Test Frequency	5260MHz	Polarization	Vertical
Temp	23°C	Hum.	59%

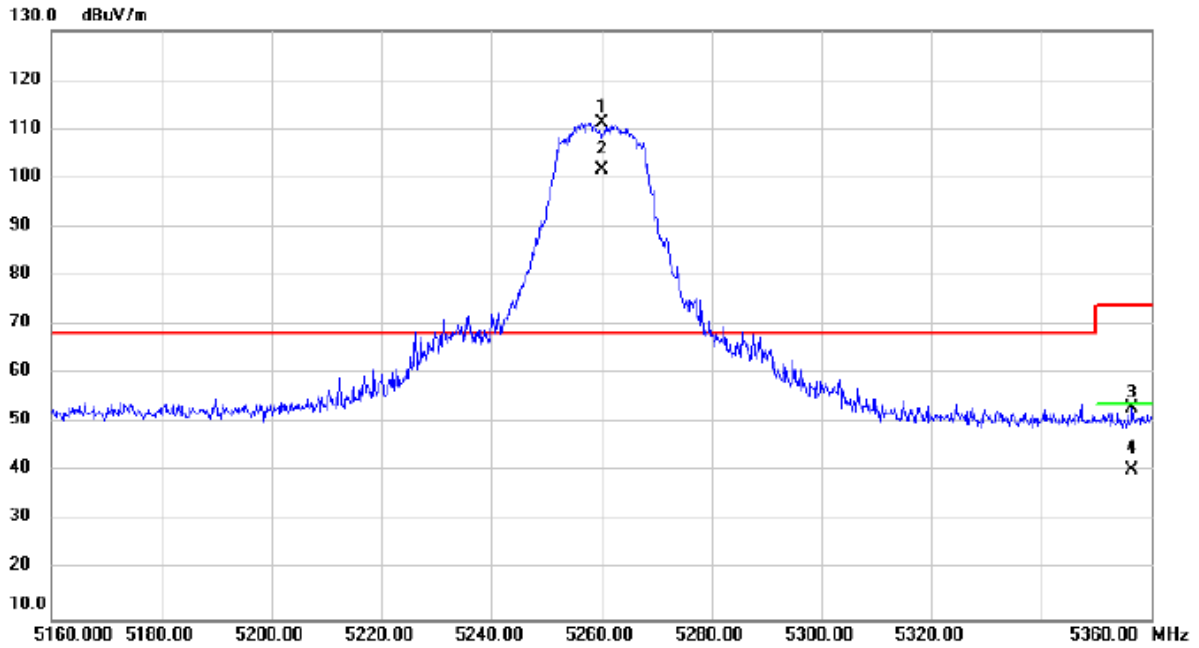

No.	Mk.	Freq.	Reading Level	Correct Factor	Measurement	Limit	Over	Detector	Comment
		MHz	dBuV	dB	dBuV/m	dBuV/m	dB		
1	*	5260.000	109.95	1.41	111.36	68.20	43.16	peak	No Limit
2	X	5260.000	100.17	1.41	101.58	68.20	33.38	AVG	No Limit
3		5356.420	51.59	1.44	53.03	74.00	-20.97	peak	
4		5356.420	39.05	1.44	40.49	54.00	-13.51	AVG	

REMARKS:

- (1) Measurement Value = Reading Level + Correct Factor.
- (2) Margin Level = Measurement Value - Limit Value.

Test Mode	IEEE 802.11a	Test Date	2022/12/6
Test Frequency	5700MHz	Polarization	Vertical
Temp	23°C	Hum.	59%

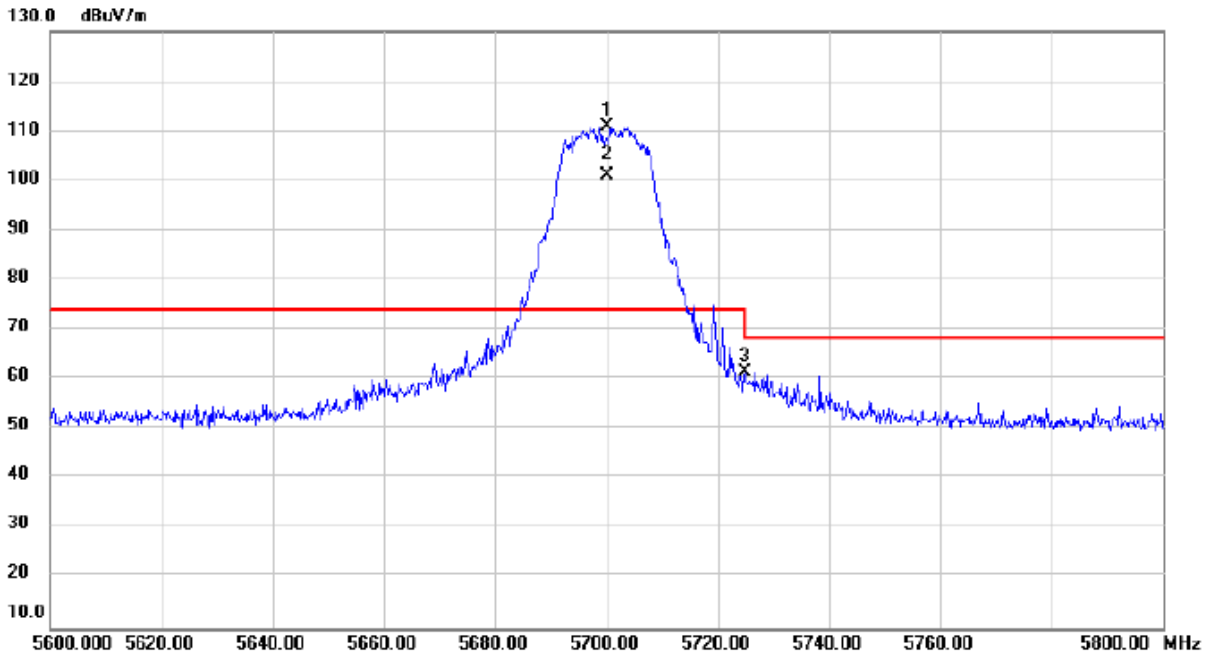

No.	Mk.	Freq. MHz	Reading Level dBuV	Correct Factor dB	Measure- ment dBuV/m	Limit dBuV/m	Over dB	Detector	Comment
1	*	5700.000	109.11	1.89	111.00	74.00	37.00	peak	No Limit
2	X	5700.000	99.17	1.89	101.06	74.00	27.06	AVG	No Limit
3		5725.060	59.62	1.95	61.57	68.20	-6.63	peak	

REMARKS:

- (1) Measurement Value = Reading Level + Correct Factor.
- (2) Margin Level = Measurement Value - Limit Value.

Test Mode	IEEE 802.11a	Test Date	2022/12/6
Test Frequency	5745MHz	Polarization	Vertical
Temp	53°C	Hum.	59%

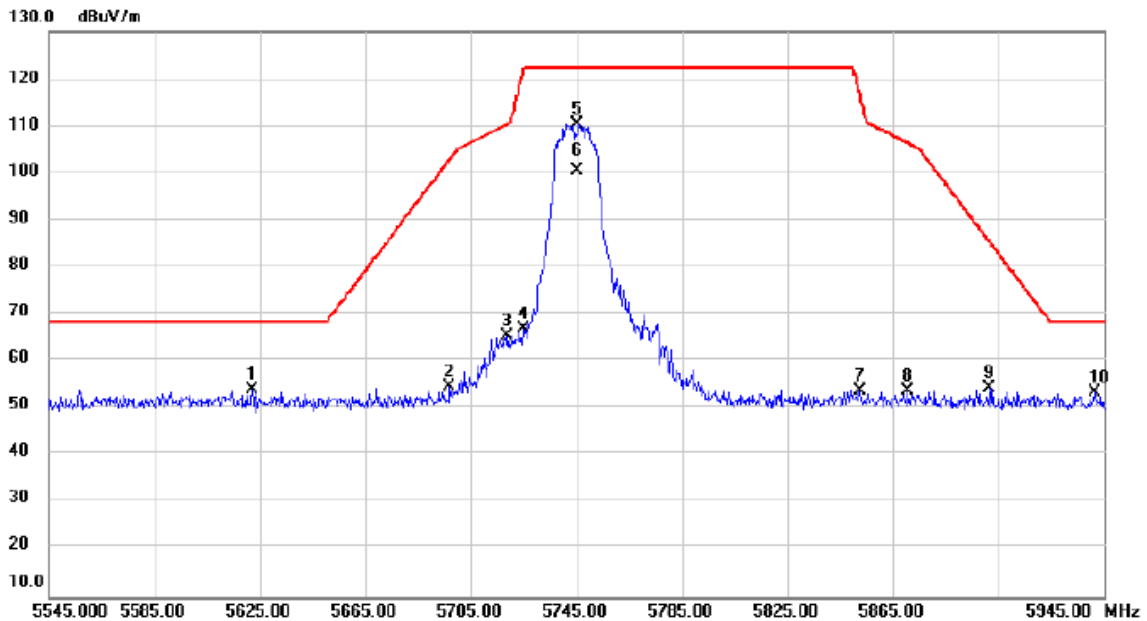

No.	Mk.	Freq. MHz	Reading Level dBuV	Correct Factor dB	Measure- ment dBuV/m	Limit dBuV/m	Over dB	Detector	Comment
1		5622.067	52.19	1.73	53.92	68.20	-14.28	peak	
2		5696.640	52.60	1.89	54.49	102.72	-48.23	peak	
3		5718.640	63.39	1.93	65.32	110.42	-45.10	peak	
4		5724.973	64.94	1.93	66.87	122.14	-55.27	peak	
5	*	5745.000	108.51	1.98	110.49	122.20	-11.71	peak	No Limit
6		5745.000	98.59	1.98	100.57	122.20	-21.63	AVG	No Limit
7		5852.213	51.40	2.20	53.60	117.15	-63.55	peak	
8		5870.840	51.31	2.24	53.55	106.36	-52.81	peak	
9		5901.747	52.04	2.30	54.34	85.37	-31.03	peak	
10		5941.440	50.92	2.38	53.30	68.20	-14.90	peak	

REMARKS:

- (1) Measurement Value = Reading Level + Correct Factor.
- (2) Margin Level = Measurement Value - Limit Value.

Test Mode	IEEE 802.11ac (VHT80)	Test Date	2022/12/6
Test Frequency	5210MHz	Polarization	Vertical
Temp	23°C	Hum.	59%

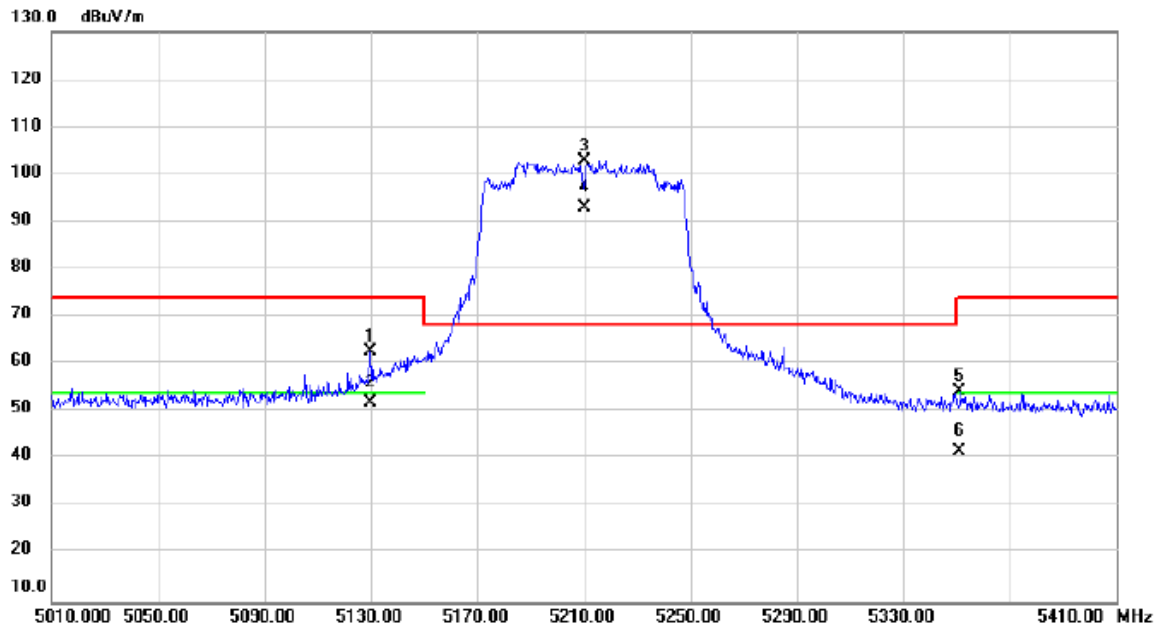

No.	Mk.	Freq.	Reading Level	Correct Factor	Measurement	Limit	Over		
		MHz	dBuV	dB	dBuV/m	dBuV/m	dB	Detector	Comment
1		5129.707	61.26	1.36	62.62	74.00	-11.38	peak	
2		5129.707	50.60	1.36	51.96	54.00	-2.04	AVG	
3	*	5210.000	101.48	1.39	102.87	68.20	34.67	peak	No Limit
4	X	5210.000	91.58	1.39	92.97	68.20	24.77	AVG	No Limit
5		5351.320	52.80	1.43	54.23	74.00	-19.77	peak	
6		5351.320	40.10	1.43	41.53	54.00	-12.47	AVG	

REMARKS:

- (1) Measurement Value = Reading Level + Correct Factor.
- (2) Margin Level = Measurement Value - Limit Value.

Test Mode	IEEE 802.11ac (VHT80)	Test Date	2022/12/6
Test Frequency	5290MHz	Polarization	Vertical
Temp	53°C	Hum.	59%

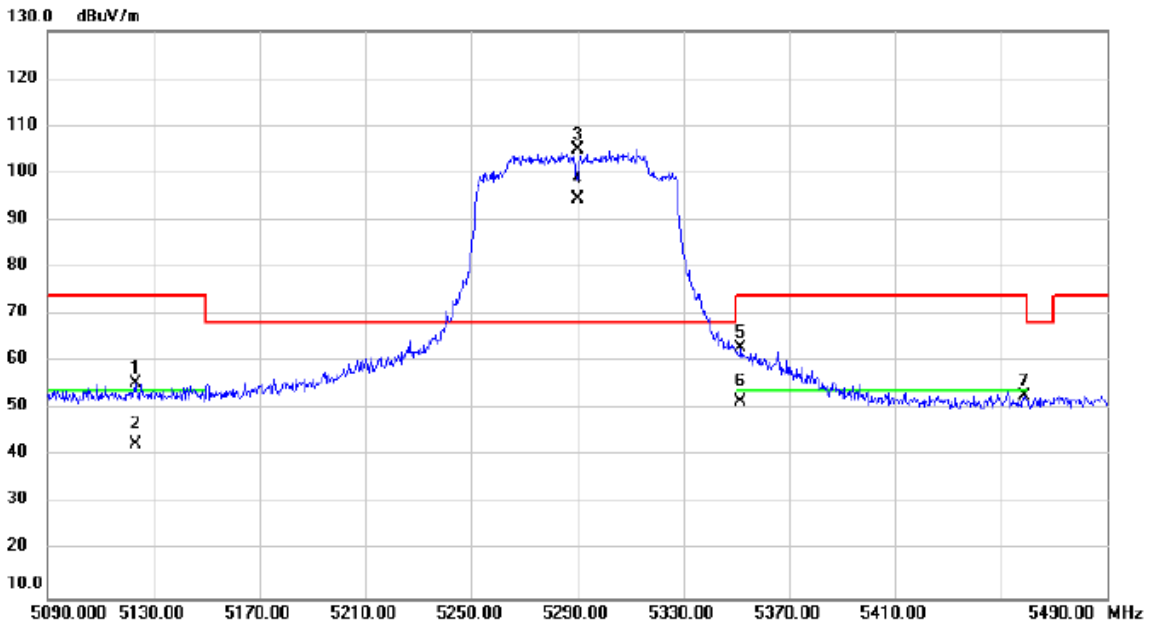

No.	Mk.	Freq.	Reading Level	Correct Factor	Measurement	Limit	Over		
		MHz	dBuV	dB	dBuV/m	dBuV/m	dB	Detector	Comment
1		5123.147	54.20	1.36	55.56	74.00	-18.44	peak	
2		5123.147	41.30	1.36	42.66	54.00	-11.34	AVG	
3	*	5290.000	103.44	1.42	104.86	68.20	36.66	peak	No Limit
4	X	5290.000	92.91	1.42	94.33	68.20	26.13	AVG	No Limit
5		5351.773	61.65	1.44	63.09	74.00	-10.91	peak	
6		5351.773	50.09	1.44	51.53	54.00	-2.47	AVG	
7		5458.800	51.29	1.47	52.76	74.00	-21.24	peak	

REMARKS:

- (1) Measurement Value = Reading Level + Correct Factor.
- (2) Margin Level = Measurement Value - Limit Value.

Test Mode	IEEE 802.11ac (VHT80)	Test Date	2022/12/6
Test Frequency	5610MHz	Polarization	Vertical
Temp	23°C	Hum.	59%

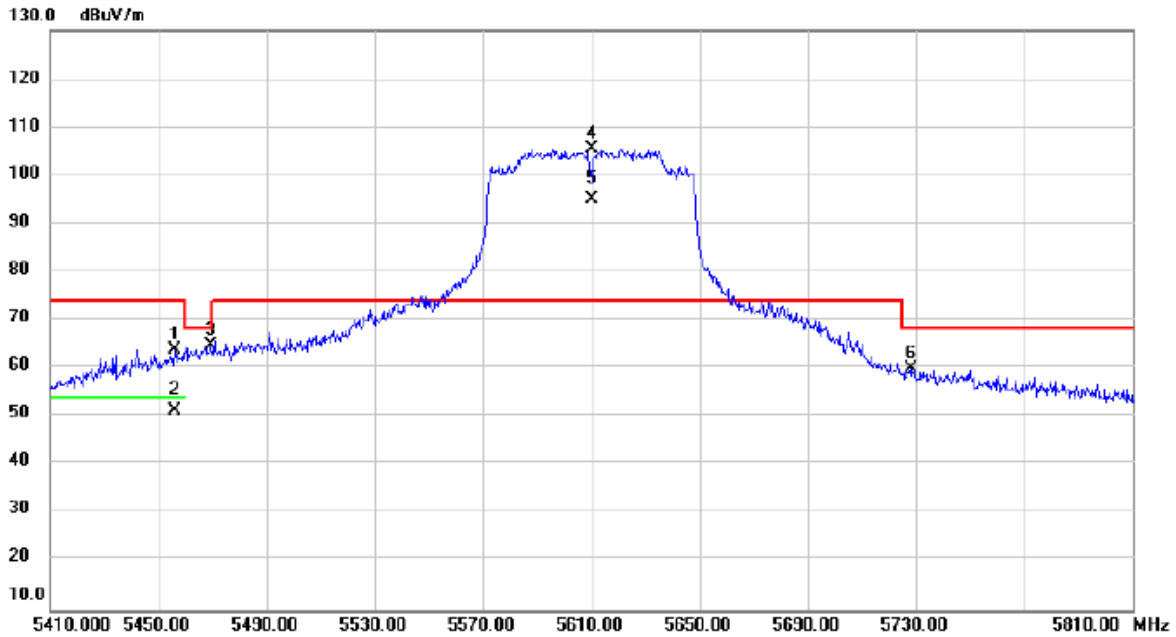

No.	Mk.	Freq.	Reading Level	Correct Factor	Measurement	Limit	Over		
		MHz	dBuV	dB	dBuV/m	dBuV/m	dB	Detector	Comment
1		5456.000	62.39	1.47	63.86	74.00	-10.14	peak	
2		5456.000	49.82	1.47	51.29	54.00	-2.71	AVG	
3		5469.373	63.13	1.48	64.61	68.20	-3.59	peak	
4	*	5610.000	103.92	1.71	105.63	74.00	31.63	peak	No Limit
5	X	5610.000	93.34	1.71	95.05	74.00	21.05	AVG	No Limit
6		5728.360	58.06	1.95	60.01	68.20	-8.19	peak	

REMARKS:

- (1) Measurement Value = Reading Level + Correct Factor.
- (2) Margin Level = Measurement Value - Limit Value.

Test Mode	IEEE 802.11ac (VHT80)	Test Date	2022/12/6
Test Frequency	5775MHz	Polarization	Vertical
Temp	53°C	Hum.	59%

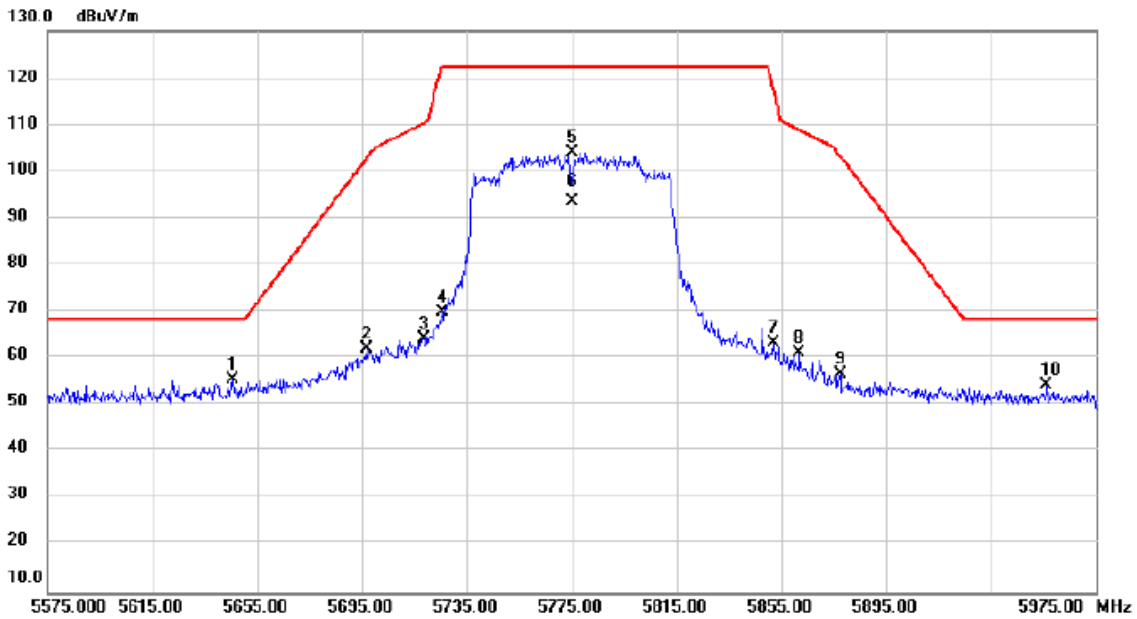

No.	Mk.	Freq. MHz	Reading Level dBuV	Correct Factor dB	Measure- ment dBuV/m	Limit dBuV/m	Over dB	Detector	Comment
1	*	5645.680	53.56	1.78	55.34	68.20	-12.86	peak	
2		5696.640	60.13	1.89	62.02	102.72	-40.70	peak	
3		5718.533	62.18	1.93	64.11	110.39	-46.28	peak	
4		5725.573	68.03	1.95	69.98	122.20	-52.22	peak	
5		5775.000	101.96	2.06	104.02	122.20	-18.18	peak	No Limit
6		5775.000	91.44	2.06	93.50	122.20	-28.70	AVG	No Limit
7		5851.973	60.99	2.20	63.19	117.70	-54.51	peak	
8		5861.867	58.92	2.23	61.15	108.88	-47.73	peak	
9		5877.680	54.52	2.26	56.78	103.21	-46.43	peak	
10		5956.280	51.75	2.41	54.16	68.20	-14.04	peak	

REMARKS:

- (1) Measurement Value = Reading Level + Correct Factor.
- (2) Margin Level = Measurement Value - Limit Value.

Test Mode	IEEE 802.11ax (HE160)	Test Date	2022/12/6
Test Frequency	5250MHz	Polarization	Vertical
Temp	23°C	Hum.	59%

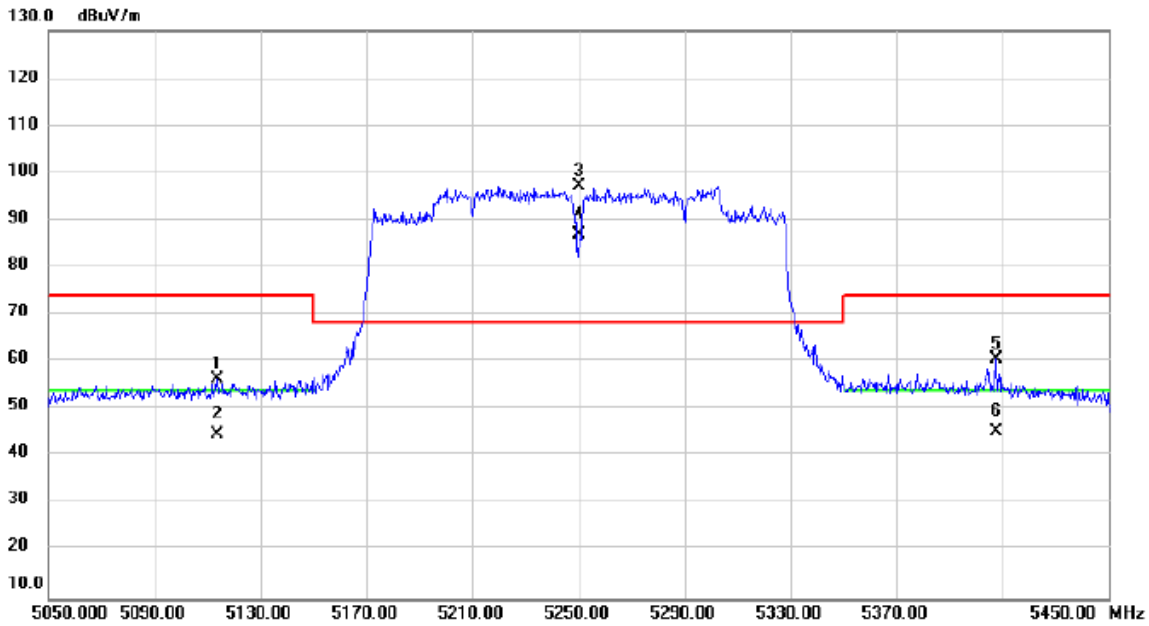

No.	Mk.	Freq. MHz	Reading Level dBuV	Correct Factor dB	Measure- ment dBuV/m	Limit dBuV/m	Over dB	Detector	Comment
1		5113.800	54.90	1.36	56.26	74.00	-17.74	peak	
2		5113.800	43.17	1.36	44.53	54.00	-9.47	AVG	
3	*	5250.000	95.76	1.41	97.17	68.20	28.97	peak	No Limit
4	X	5250.000	85.56	1.41	86.97	68.20	18.77	AVG	No Limit
5		5407.560	59.02	1.46	60.48	74.00	-13.52	peak	
6		5407.560	43.84	1.46	45.30	54.00	-8.70	AVG	

REMARKS:

- (1) Measurement Value = Reading Level + Correct Factor.
- (2) Margin Level = Measurement Value - Limit Value.

Test Mode	IEEE 802.11ax (HE160)	Test Date	2022/12/6
Test Frequency	5570MHz	Polarization	Vertical
Temp	53°C	Hum.	59%

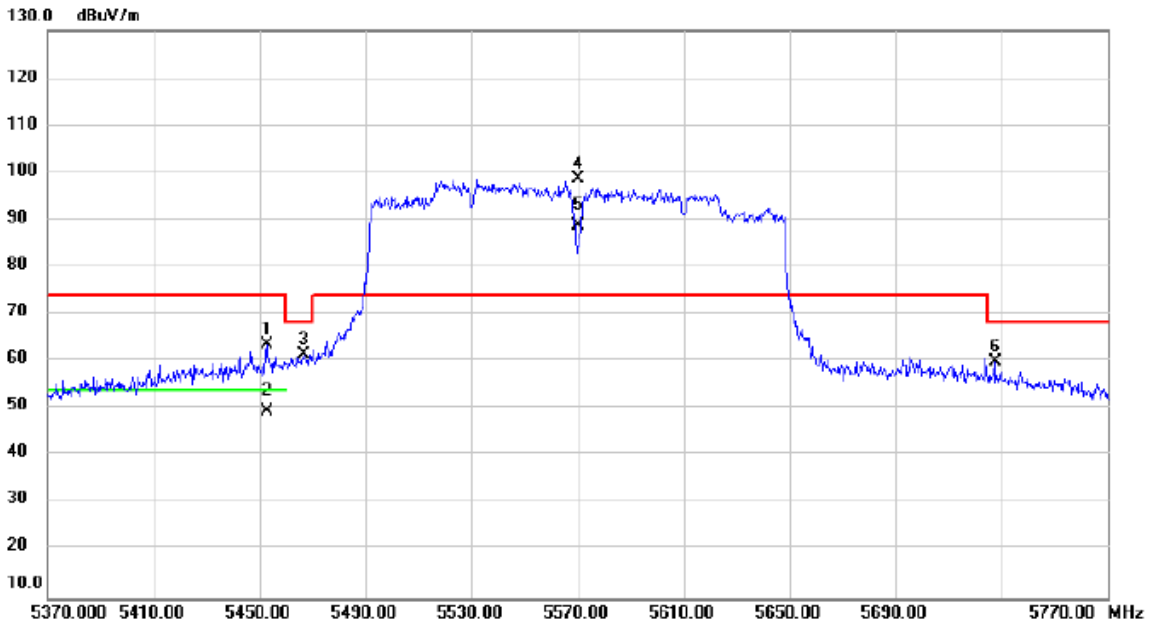

No.	Mk.	Freq.	Reading Level	Correct Factor	Measurement	Limit	Over	Detector	Comment
		MHz	dBuV	dB	dBuV/m	dBuV/m	dB		
1		5452.680	62.03	1.47	63.50	74.00	-10.50	peak	
2		5452.680	47.84	1.47	49.31	54.00	-4.69	AVG	
3		5466.907	59.96	1.48	61.44	68.20	-6.76	peak	
4	*	5570.000	97.05	1.63	98.68	74.00	24.68	peak	No Limit
5	X	5570.000	87.04	1.63	88.67	74.00	14.67	AVG	No Limit
6		5727.373	57.93	1.95	59.88	68.20	-8.32	peak	

REMARKS:

- (1) Measurement Value = Reading Level + Correct Factor.
- (2) Margin Level = Measurement Value - Limit Value.

Test Mode	IEEE 802.11a	Test Date	2022/12/6
Test Frequency	5240MHz	Polarization	Vertical
Temp	23°C	Hum.	59%

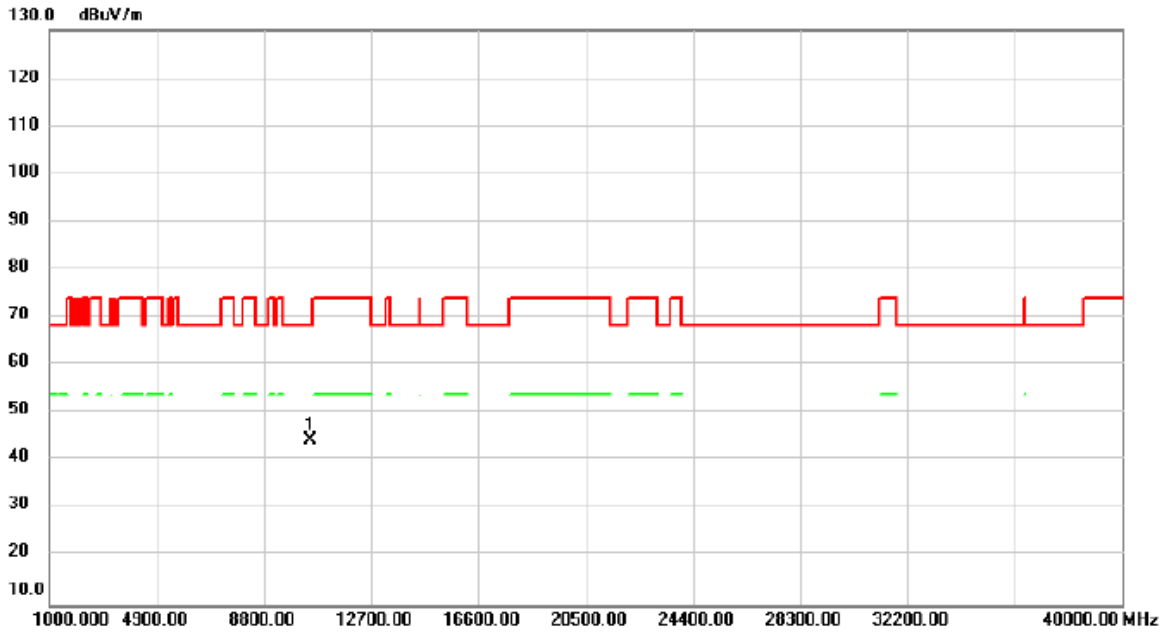

No.	Mk.	Freq.	Reading Level	Correct Factor	Measurement	Limit	Over	Detector	Comment
		MHz	dBuV	dB	dBuV/m	dBuV/m	dB		
1	*	10480.00	38.72	5.75	44.47	68.20	-23.73	peak	

REMARKS:

- (1) Measurement Value = Reading Level + Correct Factor.
- (2) Margin Level = Measurement Value - Limit Value.

Test Mode	IEEE 802.11a	Test Date	2022/12/6
Test Frequency	5240MHz	Polarization	Horizontal
Temp	23°C	Hum.	59%

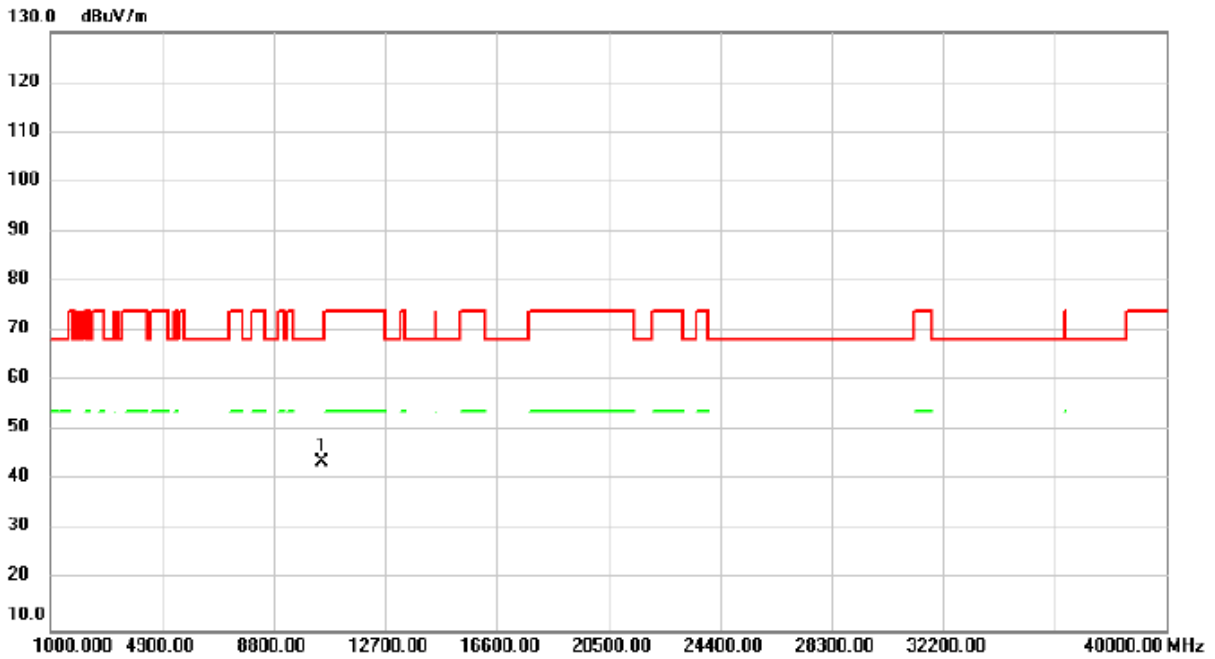

No.	Mk.	Freq.	Reading Level	Correct Factor	Measurement	Limit	Over	Detector	Comment
		MHz	dBuV	dB	dBuV/m	dBuV/m	dB		
1	*	10480.00	38.06	5.75	43.81	68.20	-24.39	peak	

REMARKS:

- (1) Measurement Value = Reading Level + Correct Factor.
- (2) Margin Level = Measurement Value - Limit Value.

Test Mode	IEEE 802.11a	Test Date	2022/12/6
Test Frequency	5280MHz	Polarization	Vertical
Temp	23°C	Hum.	59%

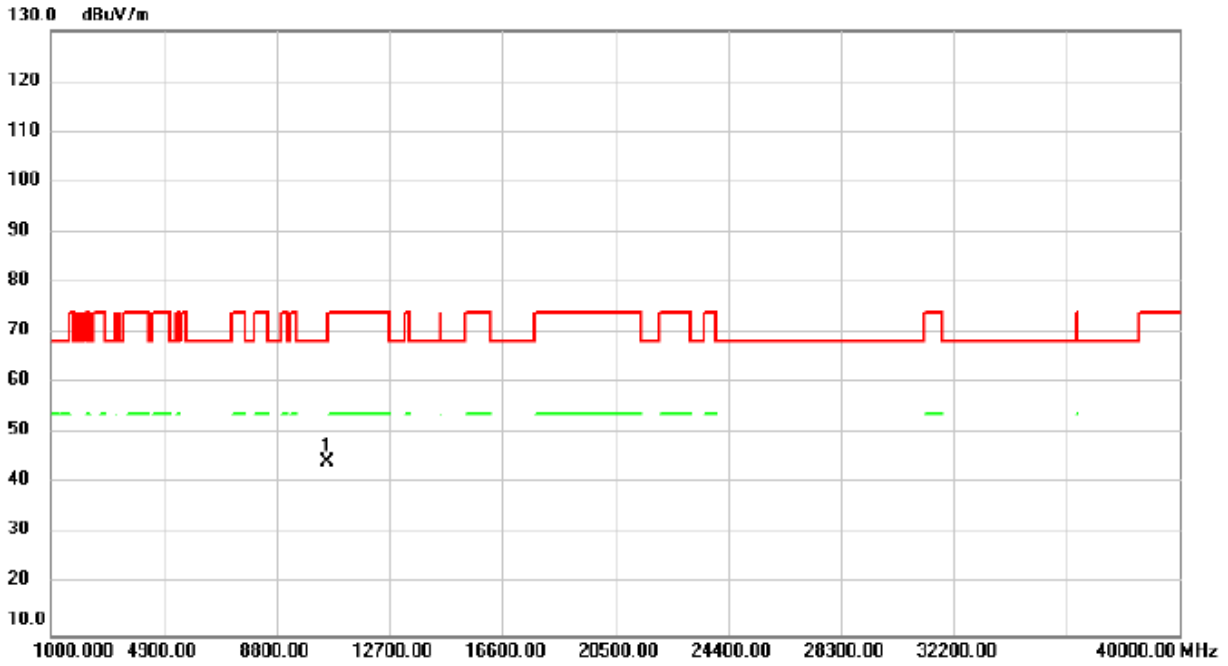

No.	Mk.	Freq.	Reading Level	Correct Factor	Measurement	Limit	Over	Detector	Comment
		MHz	dBuV	dB	dBuV/m	dBuV/m	dB		
1	*	10560.00	38.52	5.69	44.21	68.20	-23.99	peak	

REMARKS:

- (1) Measurement Value = Reading Level + Correct Factor.
- (2) Margin Level = Measurement Value - Limit Value.

Test Mode	IEEE 802.11a	Test Date	2022/12/6
Test Frequency	5280MHz	Polarization	Horizontal
Temp	23°C	Hum.	59%

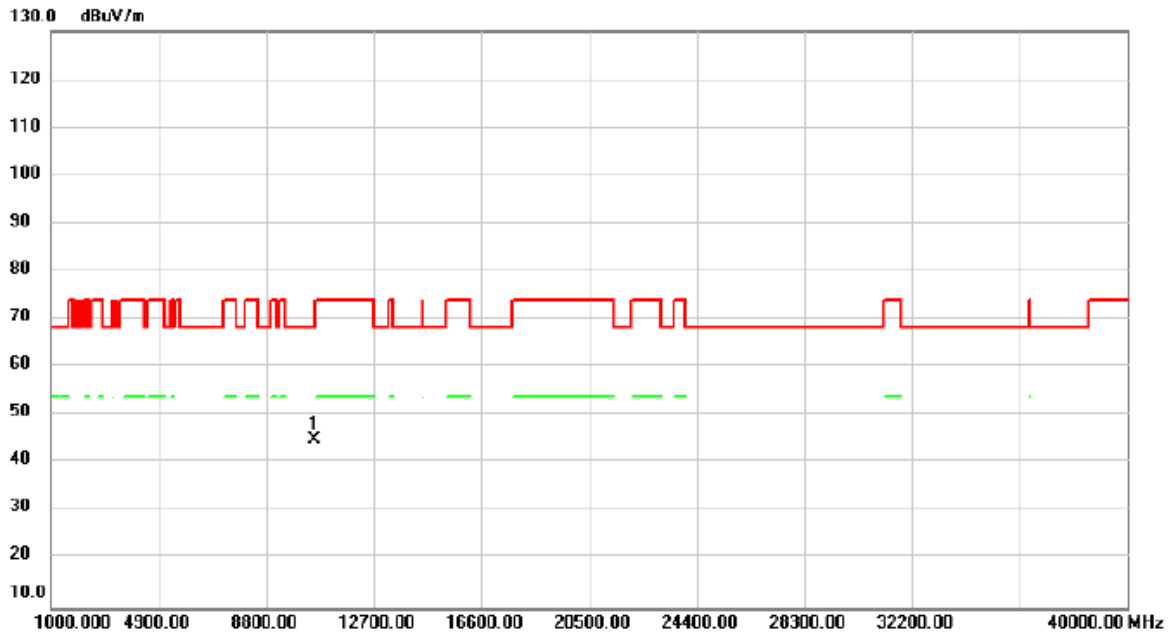

No.	Mk.	Freq.	Reading Level	Correct Factor	Measurement	Limit	Over	Detector	Comment
		MHz	dBuV	dB	dBuV/m	dBuV/m	dB		
1	*	10560.00	39.13	5.69	44.82	68.20	-23.38	peak	

REMARKS:

- (1) Measurement Value = Reading Level + Correct Factor.
- (2) Margin Level = Measurement Value - Limit Value.

Test Mode	IEEE 802.11a	Test Date	2022/12/6
Test Frequency	5600MHz	Polarization	Vertical
Temp	23°C	Hum.	59%

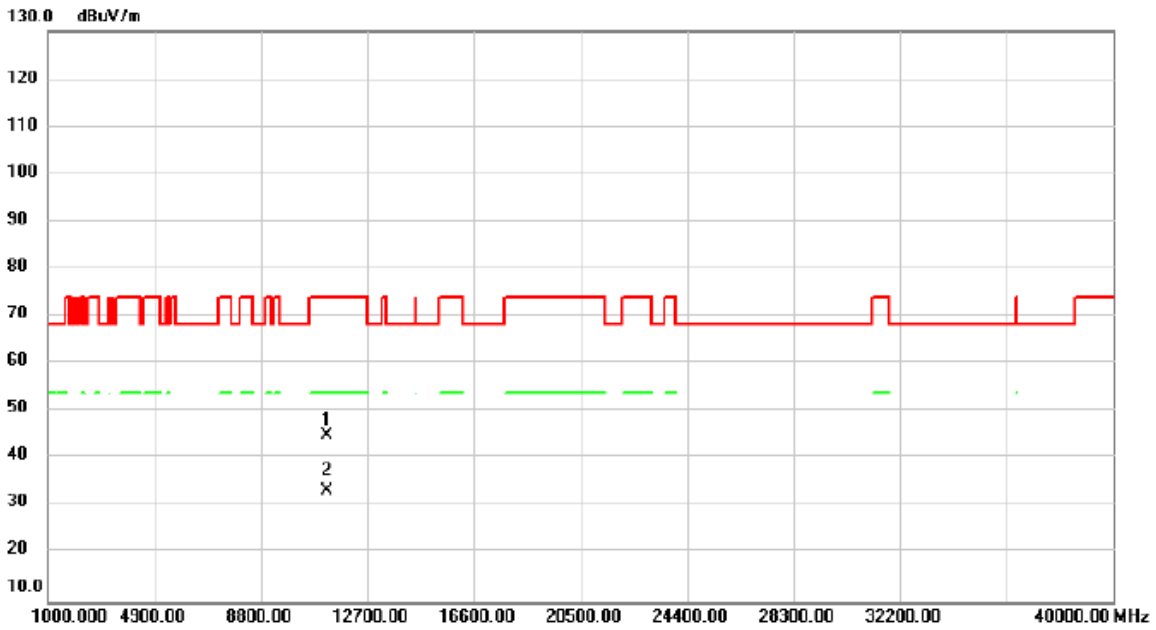

No.	Mk.	Freq. MHz	Reading Level dBuV	Correct Factor dB	Measure- ment dBuV/m	Limit dBuV/m	Over dB	Detector	Comment
1		11200.00	39.13	5.78	44.91	74.00	-29.09	peak	
2	*	11200.00	27.50	5.78	33.28	54.00	-20.72	AVG	

REMARKS:

- (1) Measurement Value = Reading Level + Correct Factor.
- (2) Margin Level = Measurement Value - Limit Value.

Test Mode	IEEE 802.11a	Test Date	2022/12/6
Test Frequency	5600MHz	Polarization	Horizontal
Temp	23°C	Hum.	59%

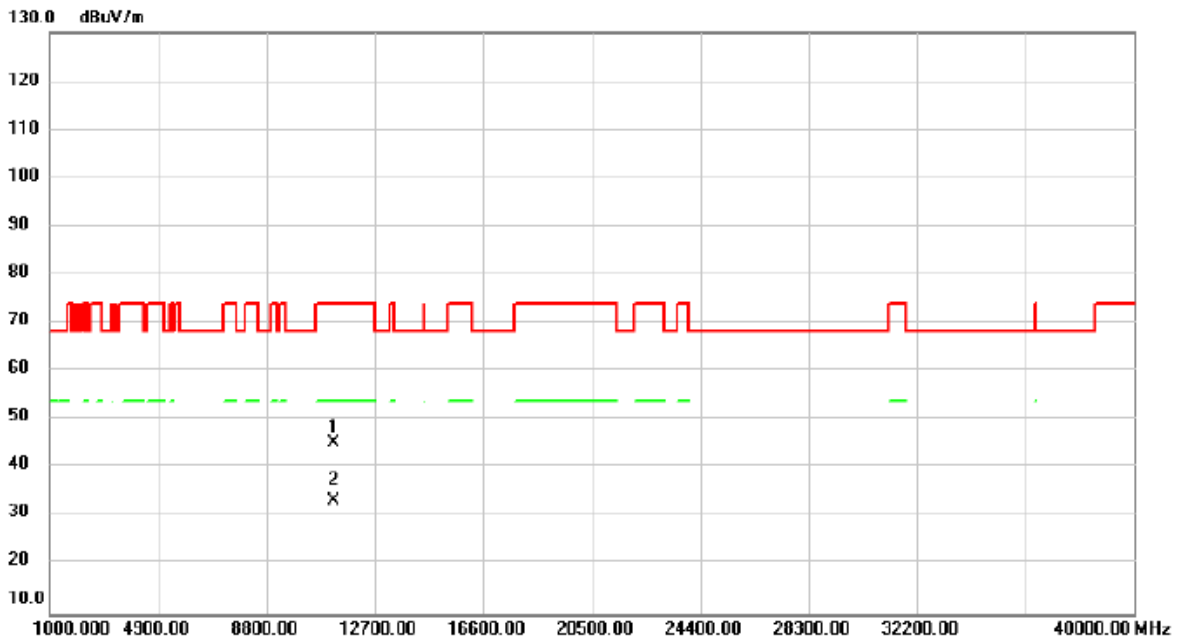

No.	Mk.	Freq.	Reading Level	Correct Factor	Measurement	Limit	Over	Detector	Comment
		MHz	dBuV	dB	dBuV/m	dBuV/m	dB		
1		11200.00	39.61	5.78	45.39	74.00	-28.61	peak	
2	*	11200.00	27.50	5.78	33.28	54.00	-20.72	AVG	

REMARKS:

- (1) Measurement Value = Reading Level + Correct Factor.
- (2) Margin Level = Measurement Value - Limit Value.

Test Mode	IEEE 802.11a	Test Date	2022/12/6
Test Frequency	5745MHz	Polarization	Vertical
Temp	23°C	Hum.	59%

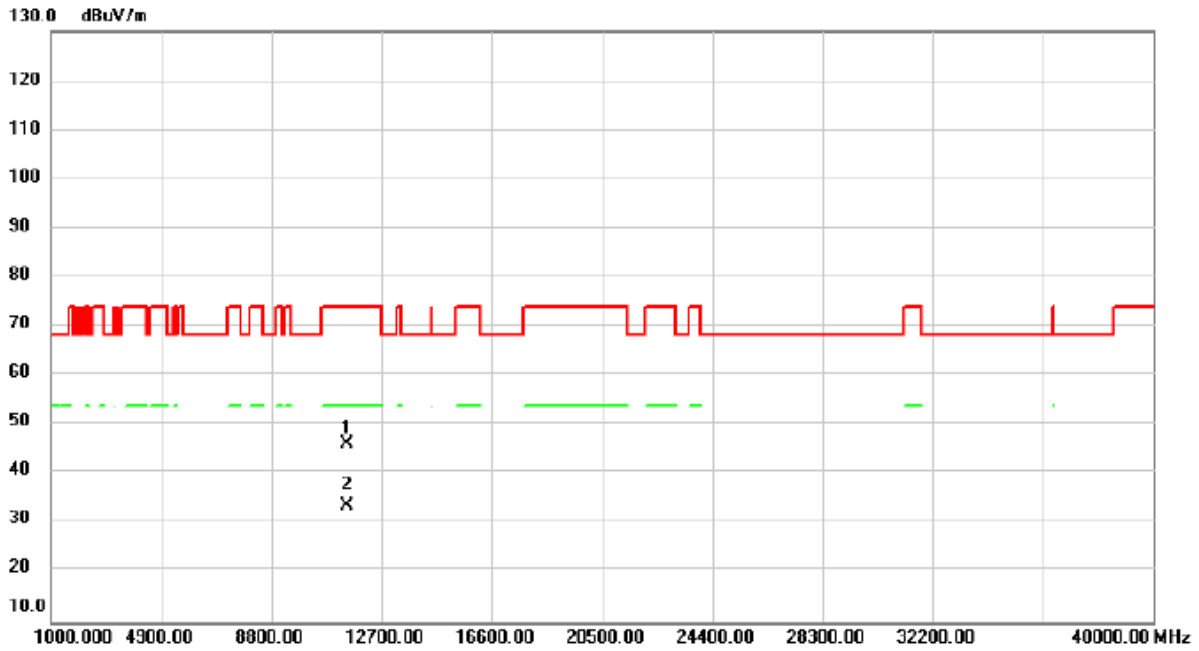

No.	Mk.	Freq. MHz	Reading Level dBuV	Correct Factor dB	Measure- ment dBuV/m	Limit dBuV/m	Over dB	Detector	Comment
1		11490.00	39.93	6.26	46.19	74.00	-27.81	peak	
2	*	11490.00	27.33	6.26	33.59	54.00	-20.41	AVG	

REMARKS:

- (1) Measurement Value = Reading Level + Correct Factor.
- (2) Margin Level = Measurement Value - Limit Value.

Test Mode	IEEE 802.11a	Test Date	2022/12/6
Test Frequency	5745MHz	Polarization	Horizontal
Temp	23°C	Hum.	59%

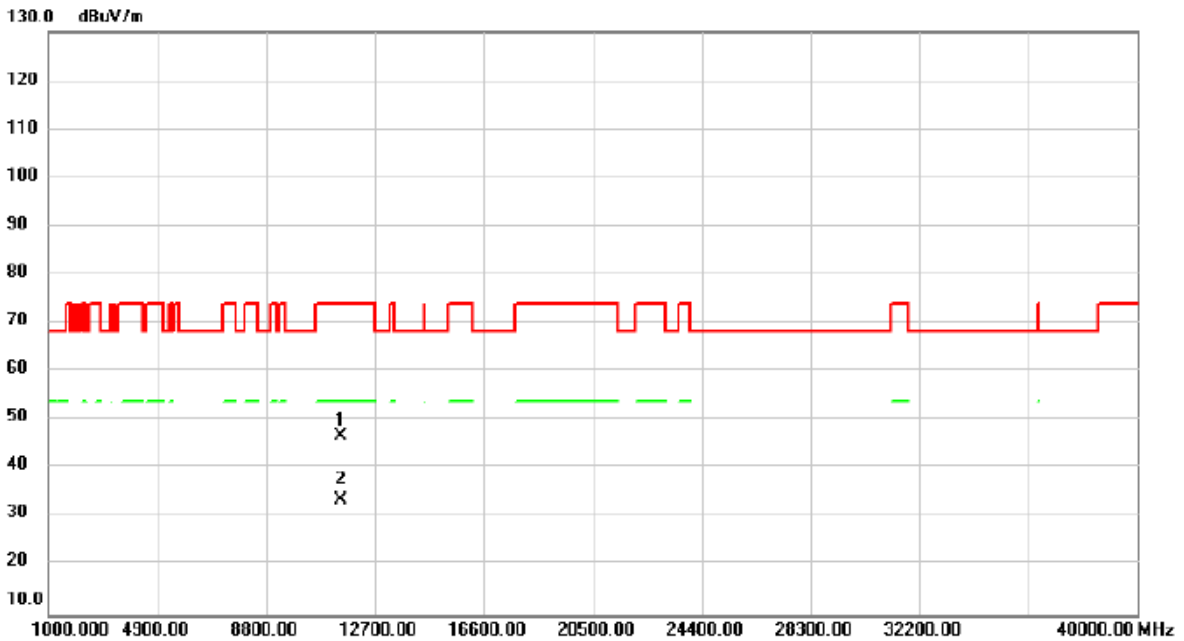

No.	Mk.	Freq.	Reading Level	Correct Factor	Measurement	Limit	Over	Detector	Comment
		MHz	dBuV	dB	dBuV/m	dBuV/m	dB		
1		11490.00	40.62	6.26	46.88	74.00	-27.12	peak	
2	*	11490.00	27.26	6.26	33.52	54.00	-20.48	AVG	

REMARKS:

- (1) Measurement Value = Reading Level + Correct Factor.
- (2) Margin Level = Measurement Value - Limit Value.

Test Mode	IEEE 802.11ac (VHT80)	Test Date	2022/12/6
Test Frequency	5210MHz	Polarization	Vertical
Temp	23°C	Hum.	59%

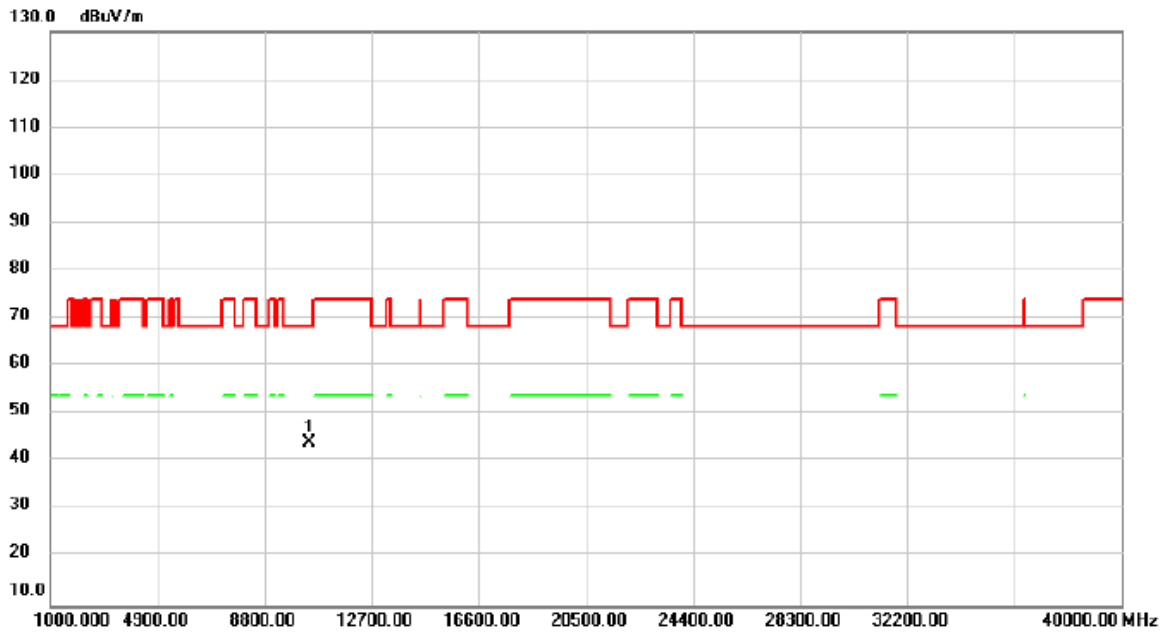

No.	Mk.	Freq.	Reading Level	Correct Factor	Measurement	Limit	Over	Detector	Comment
		MHz	dBuV	dB	dBuV/m	dBuV/m	dB		
1	*	10420.00	38.29	5.78	44.07	68.20	-24.13	peak	

REMARKS:

- (1) Measurement Value = Reading Level + Correct Factor.
- (2) Margin Level = Measurement Value - Limit Value.

Test Mode	IEEE 802.11ac (VHT80)	Test Date	2022/12/6
Test Frequency	5210MHz	Polarization	Horizontal
Temp	23°C	Hum.	59%

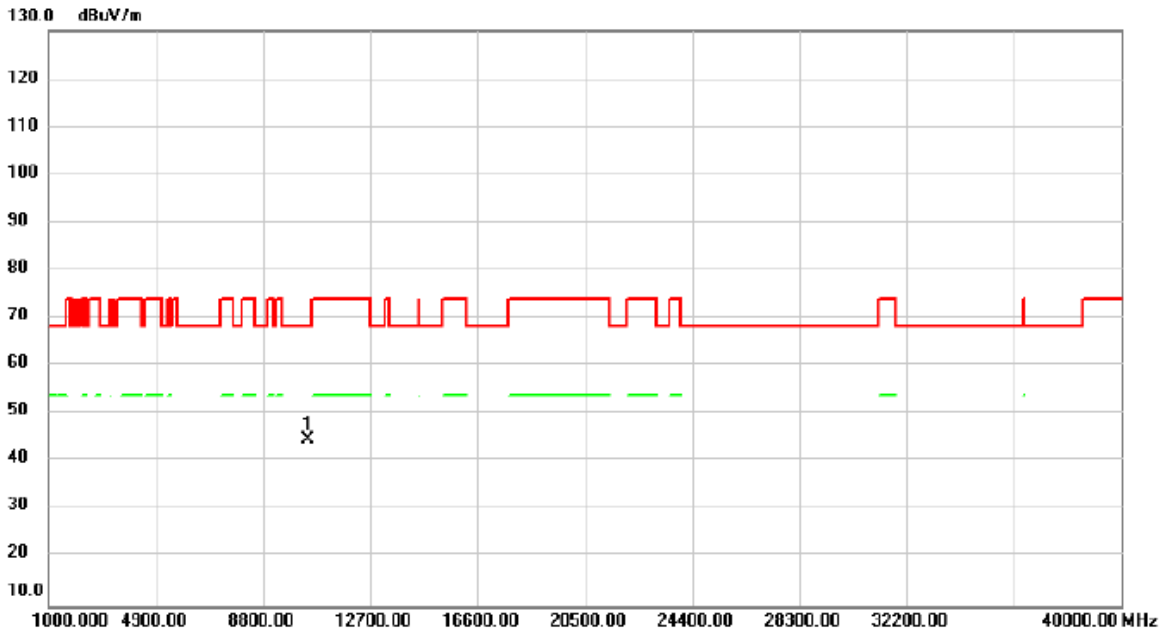

No.	Mk.	Freq.	Reading Level	Correct Factor	Measurement	Limit	Over	Detector	Comment
		MHz	dBuV	dB	dBuV/m	dBuV/m	dB		
1	*	10420.00	38.96	5.78	44.74	68.20	-23.46	peak	

REMARKS:

- (1) Measurement Value = Reading Level + Correct Factor.
- (2) Margin Level = Measurement Value - Limit Value.

Test Mode	IEEE 802.11ac (VHT80)	Test Date	2022/12/6
Test Frequency	5290MHz	Polarization	Vertical
Temp	23°C	Hum.	59%

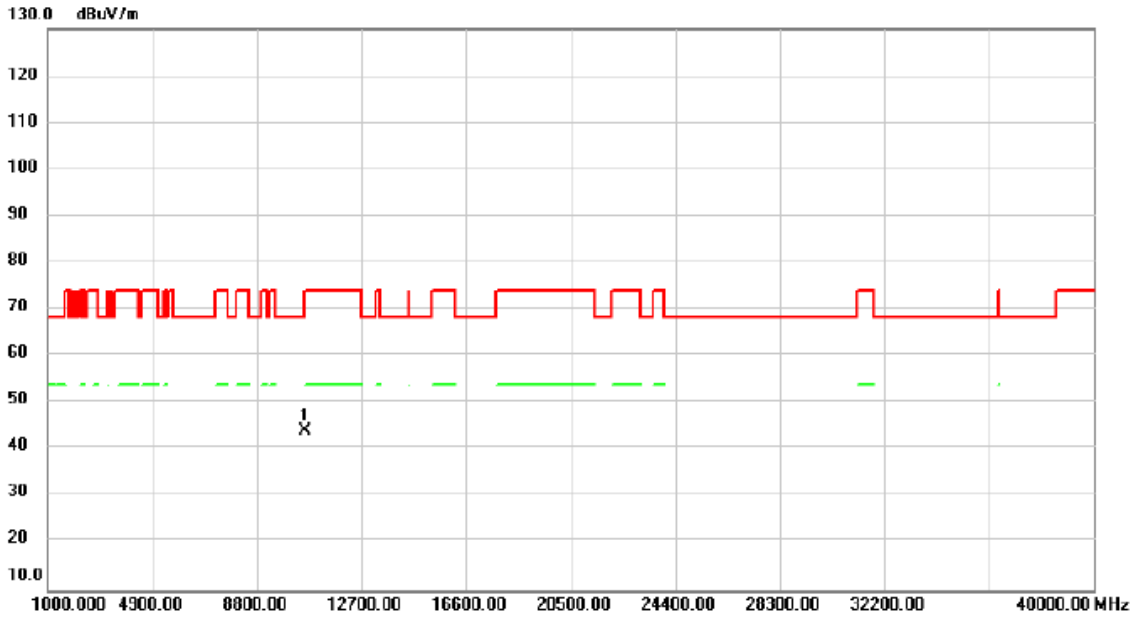

No.	Mk.	Freq.	Reading Level	Correct Factor	Measurement	Limit	Over	Detector	Comment
		MHz	dBuV	dB	dBuV/m	dBuV/m	dB		
1	*	10580.00	38.45	5.69	44.14	68.20	-24.06	peak	

REMARKS:

- (1) Measurement Value = Reading Level + Correct Factor.
- (2) Margin Level = Measurement Value - Limit Value.

Test Mode	IEEE 802.11ac (VHT80)	Test Date	2022/12/6
Test Frequency	5290MHz	Polarization	Horizontal
Temp	23°C	Hum.	59%

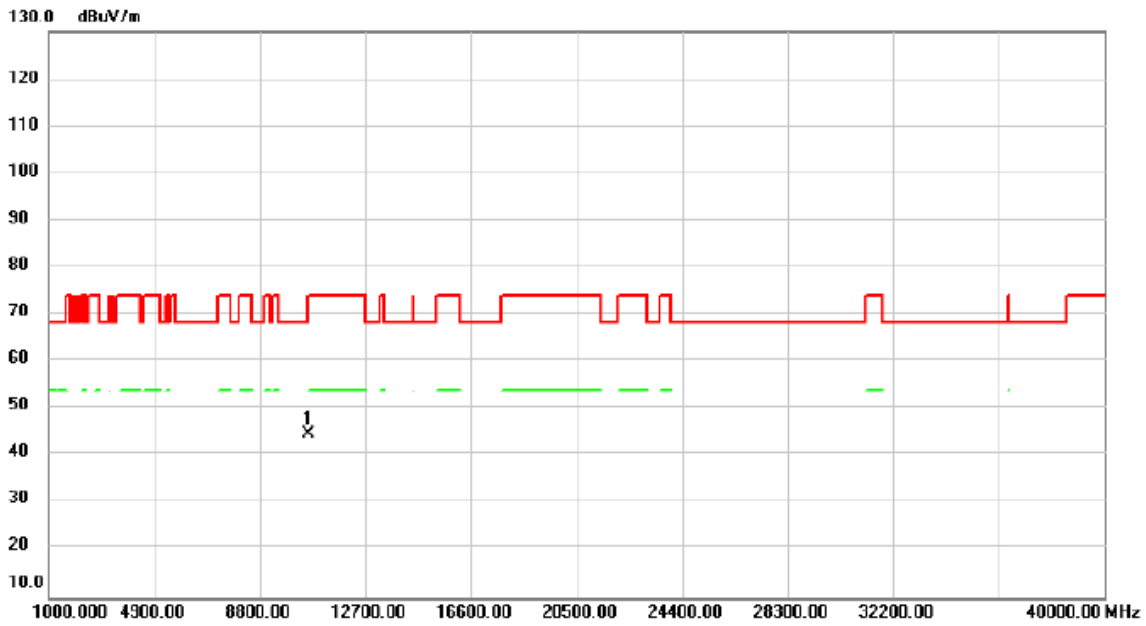

No.	Mk.	Freq.	Reading Level	Correct Factor	Measurement	Limit	Over	Detector	Comment
		MHz	dBuV	dB	dBuV/m	dBuV/m	dB		
1	*	10580.00	38.94	5.69	44.63	68.20	-23.57	peak	

REMARKS:

- (1) Measurement Value = Reading Level + Correct Factor.
- (2) Margin Level = Measurement Value - Limit Value.

Test Mode	IEEE 802.11ac (VHT80)	Test Date	2022/12/6
Test Frequency	5610MHz	Polarization	Vertical
Temp	23°C	Hum.	59%

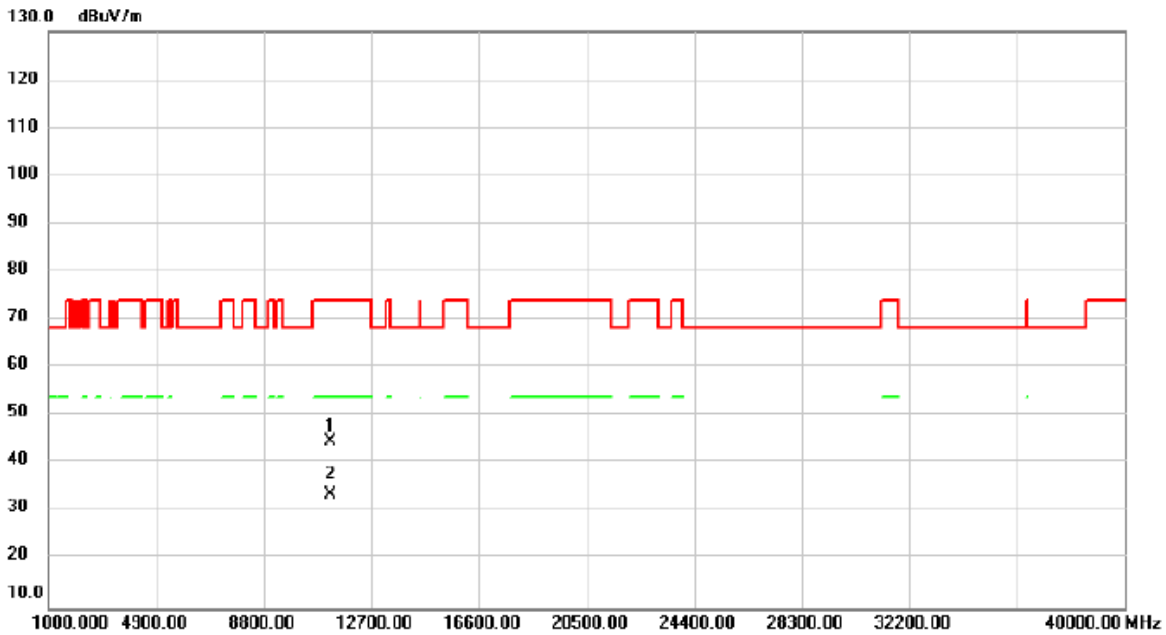

No.	Mk.	Freq.	Reading Level	Correct Factor	Measurement	Limit	Over	Detector	Comment
		MHz	dBuV	dB	dBuV/m	dBuV/m	dB		
1		11220.00	38.74	5.82	44.56	74.00	-29.44	peak	
2	*	11220.00	27.60	5.82	33.42	54.00	-20.58	AVG	

REMARKS:

- (1) Measurement Value = Reading Level + Correct Factor.
- (2) Margin Level = Measurement Value - Limit Value.

Test Mode	IEEE 802.11ac (VHT80)	Test Date	2022/12/6
Test Frequency	5610MHz	Polarization	Horizontal
Temp	23°C	Hum.	59%

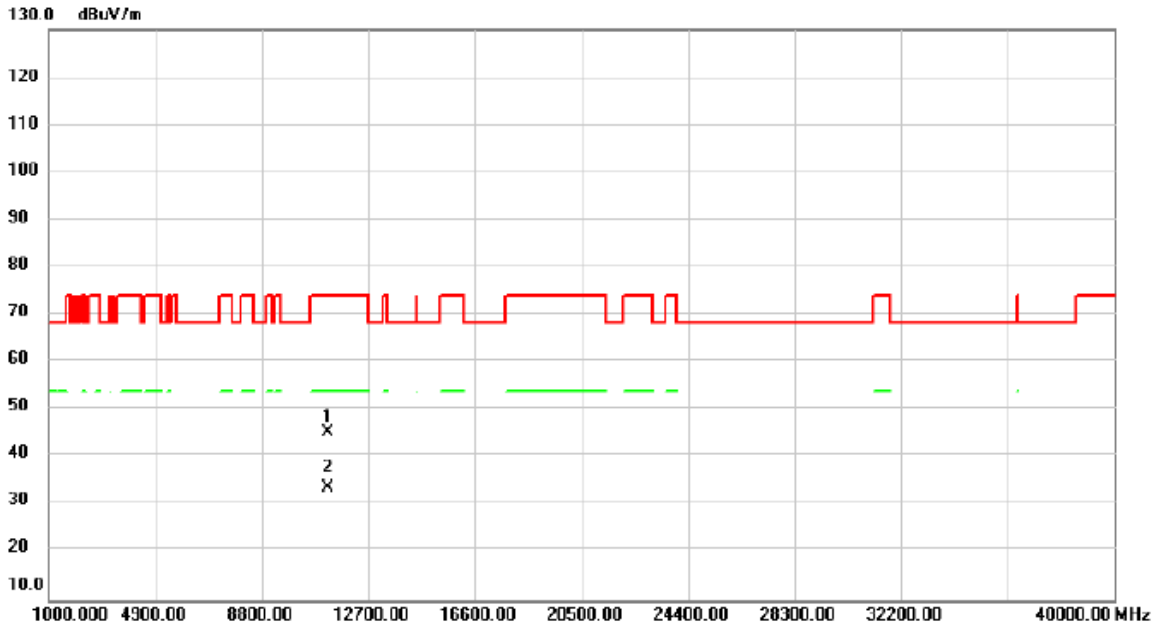

No.	Mk.	Freq.	Reading Level	Correct Factor	Measurement	Limit	Over	Detector	Comment
		MHz	dBuV	dB	dBuV/m	dBuV/m	dB		
1		11220.00	39.41	5.82	45.23	74.00	-28.77	peak	
2	*	11220.00	27.60	5.82	33.42	54.00	-20.58	AVG	

REMARKS:

- (1) Measurement Value = Reading Level + Correct Factor.
- (2) Margin Level = Measurement Value - Limit Value.

Test Mode	IEEE 802.11ac (VHT80)	Test Date	2022/12/6
Test Frequency	5775MHz	Polarization	Vertical
Temp	23°C	Hum.	59%

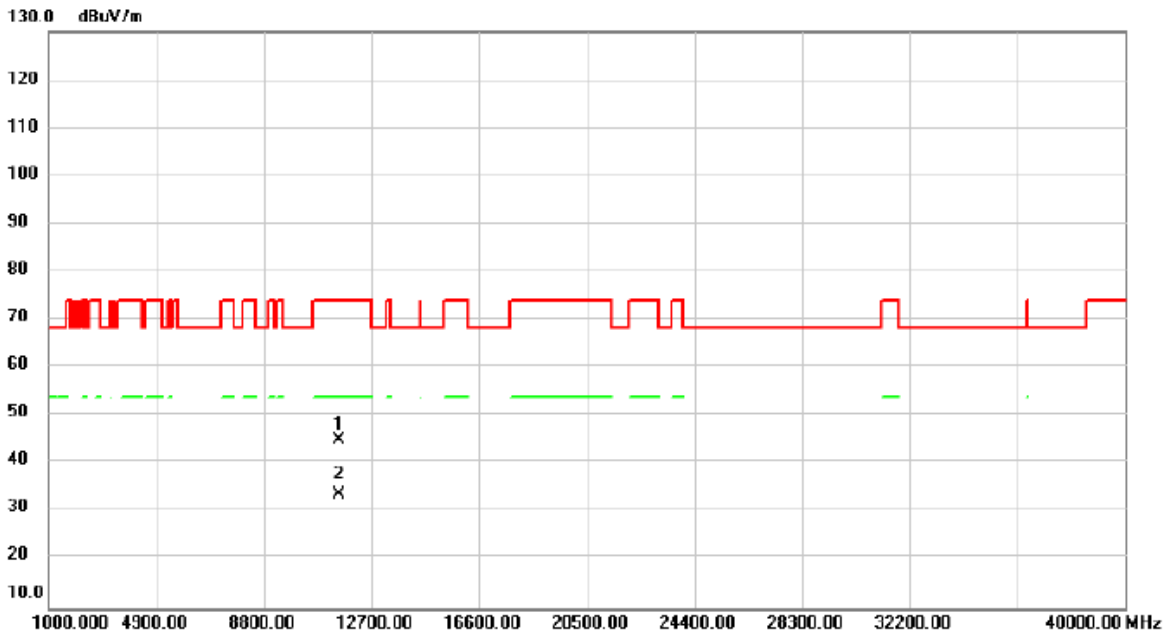

No.	Mk.	Freq.	Reading Level	Correct Factor	Measurement	Limit	Over	Detector	Comment
		MHz	dBuV	dB	dBuV/m	dBuV/m	dB		
1		11550.00	38.50	6.31	44.81	74.00	-29.19	peak	
2	*	11550.00	27.25	6.31	33.56	54.00	-20.44	AVG	

REMARKS:

- (1) Measurement Value = Reading Level + Correct Factor.
- (2) Margin Level = Measurement Value - Limit Value.

Test Mode	IEEE 802.11ac (VHT80)	Test Date	2022/12/6
Test Frequency	5775MHz	Polarization	Horizontal
Temp	23°C	Hum.	59%

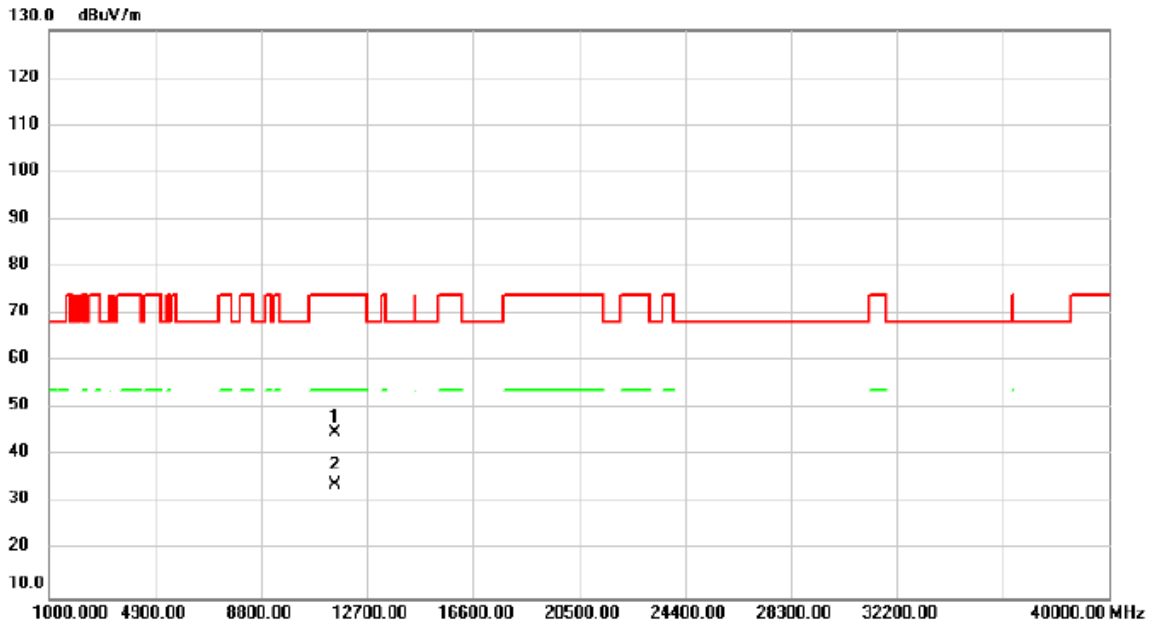

No.	Mk.	Freq.	Reading Level	Correct Factor	Measurement	Limit	Over	Detector	Comment
		MHz	dBuV	dB	dBuV/m	dBuV/m	dB		
1		11550.00	38.77	6.31	45.08	74.00	-28.92	peak	
2	*	11550.00	27.52	6.31	33.83	54.00	-20.17	AVG	

REMARKS:

- (1) Measurement Value = Reading Level + Correct Factor.
- (2) Margin Level = Measurement Value - Limit Value.

Test Mode	IEEE 802.11ax (HE160)	Test Date	2022/12/6
Test Frequency	5250MHz	Polarization	Vertical
Temp	23°C	Hum.	59%

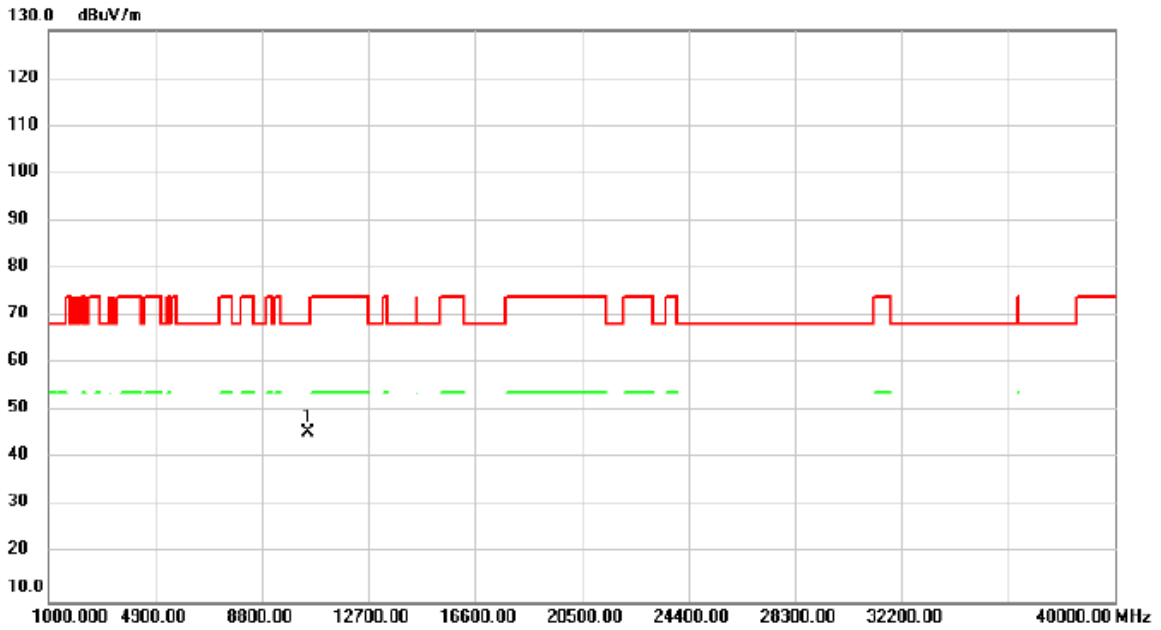

No.	Mk.	Freq.	Reading Level	Correct Factor	Measurement	Limit	Over	Detector	Comment
		MHz	dBuV	dB	dBuV/m	dBuV/m	dB		
1	*	10500.00	39.84	5.73	45.57	68.20	-22.63	peak	

REMARKS:

- (1) Measurement Value = Reading Level + Correct Factor.
- (2) Margin Level = Measurement Value - Limit Value.

Test Mode	IEEE 802.11ax (HE160)	Test Date	2022/12/6
Test Frequency	5250MHz	Polarization	Horizontal
Temp	23°C	Hum.	59%

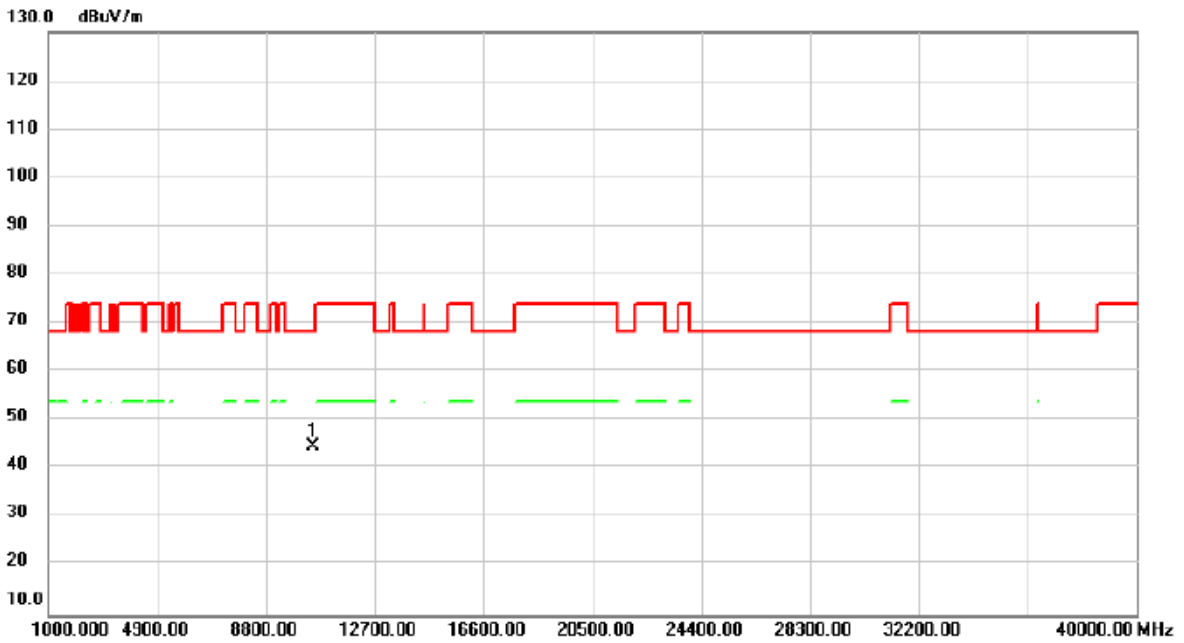

No.	Mk.	Freq.	Reading Level	Correct Factor	Measurement	Limit	Over	Detector	Comment
		MHz	dBuV	dB	dBuV/m	dBuV/m	dB		
1	*	10500.00	38.94	5.73	44.67	68.20	-23.53	peak	

REMARKS:

- (1) Measurement Value = Reading Level + Correct Factor.
- (2) Margin Level = Measurement Value - Limit Value.

Test Mode	IEEE 802.11ax (HE160)	Test Date	2022/12/6
Test Frequency	5570MHz	Polarization	Vertical
Temp	23°C	Hum.	59%

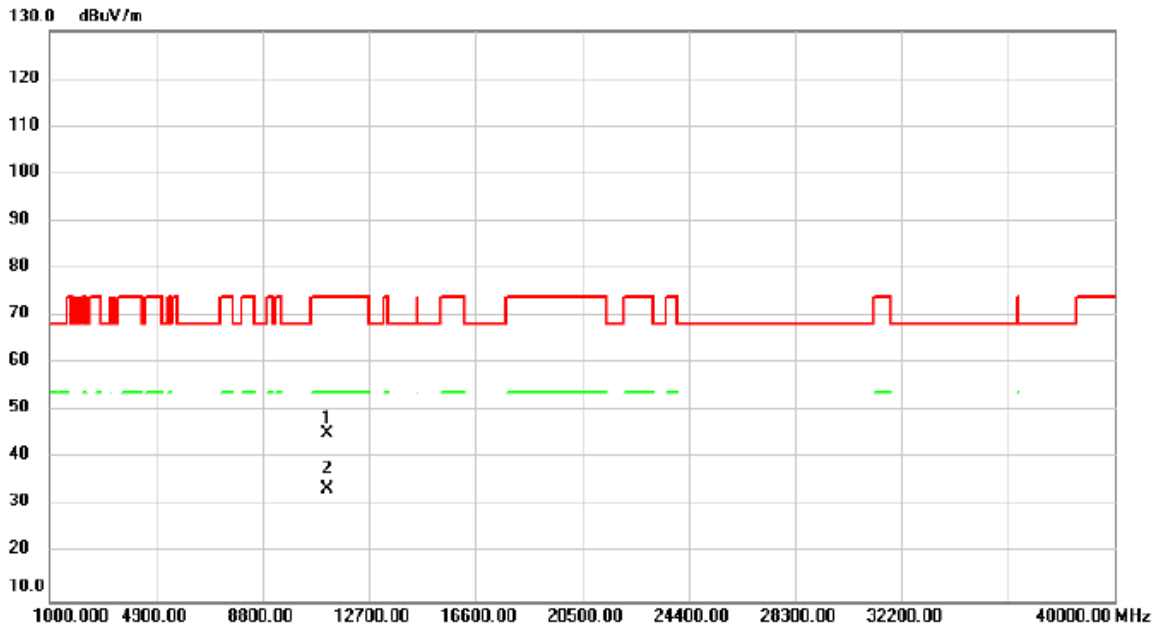

No.	Mk.	Freq. MHz	Reading Level dBuV	Correct Factor dB	Measure- ment dBuV/m	Limit dBuV/m	Over dB	Detector	Comment
1		11140.00	39.41	5.69	45.10	74.00	-28.90	peak	
2	*	11140.00	27.89	5.69	33.58	54.00	-20.42	AVG	

REMARKS:

- (1) Measurement Value = Reading Level + Correct Factor.
- (2) Margin Level = Measurement Value - Limit Value.

Test Mode	IEEE 802.11ax (HE160)	Test Date	2022/12/6
Test Frequency	5570MHz	Polarization	Horizontal
Temp	23°C	Hum.	59%

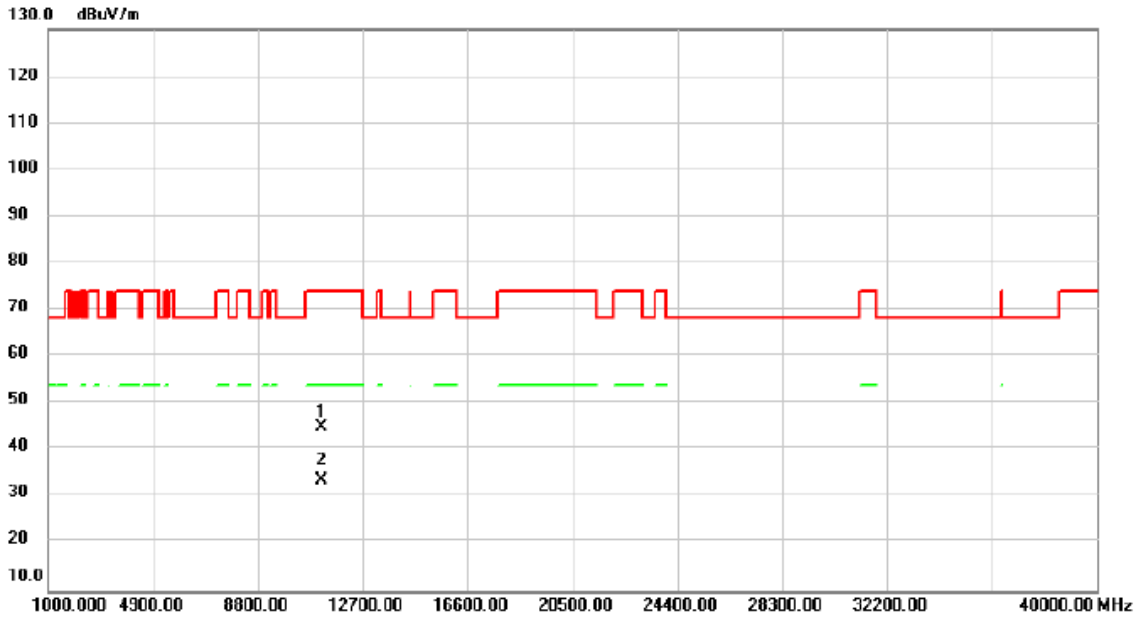

No.	Mk.	Freq. MHz	Reading Level dBuV	Correct Factor dB	Measure- ment dBuV/m	Limit dBuV/m	Over dB	Detector	Comment
1		11140.00	39.33	5.69	45.02	74.00	-28.98	peak	
2	*	11140.00	27.80	5.69	33.49	54.00	-20.51	AVG	

REMARKS:

- (1) Measurement Value = Reading Level + Correct Factor.
- (2) Margin Level = Measurement Value - Limit Value.

APPENDIX D OUTPUT POWER

Test Mode	IEEE 802.11a_Main Ant.	Tested Date	2022/11/25
-----------	------------------------	-------------	------------

Test Frequency (MHz)	Output Power (dBm)	Output Power (W)	Max. Limit (dBm)	Max. Limit (W)	Result
5180	18.37	0.0687	23.98	0.2500	Pass
5200	20.51	0.1125	23.98	0.2500	Pass
5240	20.58	0.1143	23.98	0.2500	Pass
5260	20.49	0.1119	23.98	0.2500	Pass
5300	20.67	0.1167	23.98	0.2500	Pass
5320	19.47	0.0885	23.98	0.2500	Pass
5500	19.73	0.0940	23.98	0.2500	Pass
5580	20.90	0.1230	23.98	0.2500	Pass
5700	20.00	0.1000	23.98	0.2500	Pass
5745	20.94	0.1242	30.00	1.0000	Pass
5785	20.75	0.1189	30.00	1.0000	Pass
5825	20.66	0.1164	30.00	1.0000	Pass

Test Mode	IEEE 802.11a_Aux Ant.	Tested Date	2022/11/25
-----------	-----------------------	-------------	------------

Test Frequency (MHz)	Output Power (dBm)	Output Power (W)	Max. Limit (dBm)	Max. Limit (W)	Result
5180	18.76	0.0752	23.98	0.2500	Pass
5200	20.77	0.1194	23.98	0.2500	Pass
5240	20.83	0.1211	23.98	0.2500	Pass
5260	20.71	0.1178	23.98	0.2500	Pass
5300	20.86	0.1219	23.98	0.2500	Pass
5320	19.53	0.0897	23.98	0.2500	Pass
5500	19.67	0.0927	23.98	0.2500	Pass
5580	20.69	0.1172	23.98	0.2500	Pass
5700	20.16	0.1038	23.98	0.2500	Pass
5745	20.77	0.1194	30.00	1.0000	Pass
5785	20.71	0.1178	30.00	1.0000	Pass
5825	20.75	0.1189	30.00	1.0000	Pass

Test Mode	IEEE 802.11n (HT20)_Aux Ant.	Tested Date	2022/11/25
-----------	------------------------------	-------------	------------

Test Frequency (MHz)	Output Power (dBm)	Output Power (W)	Max. Limit (dBm)	Max. Limit (W)	Result
5180	15.93	0.0392	23.98	0.2500	Pass
5200	17.81	0.0604	23.98	0.2500	Pass
5240	17.68	0.0586	23.98	0.2500	Pass
5260	18.12	0.0649	23.98	0.2500	Pass
5300	18.19	0.0659	23.98	0.2500	Pass
5320	16.67	0.0465	23.98	0.2500	Pass
5500	18.21	0.0662	23.98	0.2500	Pass
5580	18.06	0.0640	23.98	0.2500	Pass
5700	17.42	0.0552	23.98	0.2500	Pass
5745	20.24	0.1057	30.00	1.0000	Pass
5785	20.45	0.1109	30.00	1.0000	Pass
5825	20.56	0.1138	30.00	1.0000	Pass

Test Mode	IEEE 802.11n (HT20)_Main Ant.	Tested Date	2022/11/25
-----------	-------------------------------	-------------	------------

Test Frequency (MHz)	Output Power (dBm)	Output Power (W)	Max. Limit (dBm)	Max. Limit (W)	Result
5180	16.17	0.0414	23.98	0.2500	Pass
5200	17.91	0.0618	23.98	0.2500	Pass
5240	17.79	0.0601	23.98	0.2500	Pass
5260	18.31	0.0678	23.98	0.2500	Pass
5300	18.11	0.0647	23.98	0.2500	Pass
5320	16.72	0.0470	23.98	0.2500	Pass
5500	18.42	0.0695	23.98	0.2500	Pass
5580	18.16	0.0655	23.98	0.2500	Pass
5700	18.03	0.0635	23.98	0.2500	Pass
5745	20.69	0.1172	30.00	1.0000	Pass
5785	21.04	0.1271	30.00	1.0000	Pass
5825	20.89	0.1227	30.00	1.0000	Pass

Test Mode	IEEE 802.11n (HT20)_Total	Tested Date	2022/11/25
-----------	---------------------------	-------------	------------

Test Frequency (MHz)	Output Power (dBm)	Output Power (W)	Max. Limit (dBm)	Max. Limit (W)	Result
5180	19.06	0.0806	23.98	0.2500	Pass
5200	20.87	0.1222	23.98	0.2500	Pass
5240	20.75	0.1187	23.98	0.2500	Pass
5260	21.23	0.1326	23.98	0.2500	Pass
5300	21.16	0.1306	23.98	0.2500	Pass
5320	21.12	0.1294	23.98	0.2500	Pass
5500	21.33	0.1357	23.98	0.2500	Pass
5580	18.26	0.0669	23.98	0.2500	Pass
5700	20.75	0.1187	23.98	0.2500	Pass
5745	23.48	0.2229	30.00	1.0000	Pass
5785	23.77	0.2380	30.00	1.0000	Pass
5825	23.74	0.2365	30.00	1.0000	Pass

Test Mode	IEEE 802.11n (HT40)_Aux Ant.	Tested Date	2022/11/25
-----------	------------------------------	-------------	------------

Test Frequency (MHz)	Output Power (dBm)	Output Power (W)	Max. Limit (dBm)	Max. Limit (W)	Result
5190	15.67	0.0369	23.98	0.2500	Pass
5230	17.41	0.0551	23.98	0.2500	Pass
5270	17.48	0.0560	23.98	0.2500	Pass
5310	15.72	0.0373	23.98	0.2500	Pass
5510	16.28	0.0425	23.98	0.2500	Pass
5550	20.29	0.1069	23.98	0.2500	Pass
5670	19.44	0.0879	23.98	0.2500	Pass
5755	19.80	0.0955	30.00	1.0000	Pass
5795	20.37	0.1089	30.00	1.0000	Pass

Test Mode	IEEE 802.11n (HT40)_Main Ant.	Tested Date	2022/11/25
-----------	-------------------------------	-------------	------------

Test Frequency (MHz)	Output Power (dBm)	Output Power (W)	Max. Limit (dBm)	Max. Limit (W)	Result
5190	15.88	0.0387	23.98	0.2500	Pass
5230	17.47	0.0558	23.98	0.2500	Pass
5270	17.62	0.0578	23.98	0.2500	Pass
5310	15.88	0.0387	23.98	0.2500	Pass
5510	16.82	0.0481	23.98	0.2500	Pass
5550	21.00	0.1259	23.98	0.2500	Pass
5670	20.13	0.1030	23.98	0.2500	Pass
5755	20.51	0.1125	30.00	1.0000	Pass
5795	21.06	0.1276	30.00	1.0000	Pass

Test Mode	IEEE 802.11n (HT40)_Total	Tested Date	2022/11/25
-----------	---------------------------	-------------	------------

Test Frequency (MHz)	Output Power (dBm)	Output Power (W)	Max. Limit (dBm)	Max. Limit (W)	Result
5190	18.79	0.0756	23.98	0.2500	Pass
5230	20.45	0.1109	23.98	0.2500	Pass
5270	20.56	0.1138	23.98	0.2500	Pass
5310	18.81	0.0761	23.98	0.2500	Pass
5510	19.57	0.0905	23.98	0.2500	Pass
5550	23.67	0.2328	23.98	0.2500	Pass
5670	22.81	0.1909	23.98	0.2500	Pass
5755	23.18	0.2080	30.00	1.0000	Pass
5795	23.74	0.2365	30.00	1.0000	Pass

Test Mode	IEEE 802.11ac (VHT80)_Aux Ant.	Tested Date	2022/11/25
-----------	--------------------------------	-------------	------------

Test Frequency (MHz)	Output Power (dBm)	Output Power (W)	Max. Limit (dBm)	Max. Limit (W)	Result
5210	15.40	0.0347	23.98	0.2500	Pass
5290	16.12	0.0409	23.98	0.2500	Pass
5530	17.01	0.0502	23.98	0.2500	Pass
5610	20.06	0.1014	23.98	0.2500	Pass
5775	17.62	0.0578	30.00	1.0000	Pass

Test Mode	IEEE 802.11ac (VHT80)_Main Ant.	Tested Date	2022/11/25
-----------	---------------------------------	-------------	------------

Test Frequency (MHz)	Output Power (dBm)	Output Power (W)	Max. Limit (dBm)	Max. Limit (W)	Result
5210	15.91	0.0390	23.98	0.2500	Pass
5290	16.27	0.0424	23.98	0.2500	Pass
5530	17.34	0.0542	23.98	0.2500	Pass
5610	20.50	0.1122	23.98	0.2500	Pass
5775	18.24	0.0667	30.00	1.0000	Pass

Test Mode	IEEE 802.11ac (VHT80)_Total	Tested Date	2022/11/25
-----------	-----------------------------	-------------	------------

Test Frequency (MHz)	Output Power (dBm)	Output Power (W)	Max. Limit (dBm)	Max. Limit (W)	Result
5210	18.67	0.0737	23.98	0.2500	Pass
5290	19.21	0.0833	23.98	0.2500	Pass
5530	20.19	0.1044	23.98	0.2500	Pass
5610	23.30	0.2136	23.98	0.2500	Pass
5775	20.95	0.1245	30.00	1.0000	Pass

Test Mode	IEEE 802.11ac (VHT160)_Aux Ant.	Tested Date	2022/11/25
-----------	---------------------------------	-------------	------------

Test Frequency (MHz)	Output Power (dBm)	Output Power (W)	Max. Limit (dBm)	Max. Limit (W)	Result
5250	12.17	0.0165	23.98	0.2500	Pass
5570	12.94	0.0197	23.98	0.2500	Pass

Test Mode	IEEE 802.11ac (VHT160)_Main Ant.	Tested Date	2022/11/25
-----------	----------------------------------	-------------	------------

Test Frequency (MHz)	Output Power (dBm)	Output Power (W)	Max. Limit (dBm)	Max. Limit (W)	Result
5250	12.12	0.0163	23.98	0.2500	Pass
5570	13.75	0.0237	23.98	0.2500	Pass

Test Mode	IEEE 802.11ac (VHT160)_Total	Tested Date	2022/11/25
-----------	------------------------------	-------------	------------

Test Frequency (MHz)	Output Power (dBm)	Output Power (W)	Max. Limit (dBm)	Max. Limit (W)	Result
5250	15.16	0.0328	23.98	0.2500	Pass
5570	16.37	0.0434	23.98	0.2500	Pass

Test Mode	IEEE 802.11ax (HE20)_Aux Ant.	Tested Date	2022/11/25
-----------	-------------------------------	-------------	------------

Test Frequency (MHz)	Output Power (dBm)	Output Power (W)	Max. Limit (dBm)	Max. Limit (W)	Result
5180	17.02	0.0504	23.98	0.2500	Pass
5200	18.17	0.0656	23.98	0.2500	Pass
5240	18.35	0.0684	23.98	0.2500	Pass
5260	18.37	0.0687	23.98	0.2500	Pass
5300	18.37	0.0687	23.98	0.2500	Pass
5320	15.92	0.0391	23.98	0.2500	Pass
5500	17.64	0.0581	23.98	0.2500	Pass
5580	18.52	0.0711	23.98	0.2500	Pass
5700	17.37	0.0546	23.98	0.2500	Pass
5745	20.46	0.1112	30.00	1.0000	Pass
5785	20.45	0.1109	30.00	1.0000	Pass
5825	20.39	0.1094	30.00	1.0000	Pass

Test Mode	IEEE 802.11ax (HE20)_Main Ant.	Tested Date	2022/11/25
-----------	--------------------------------	-------------	------------

Test Frequency (MHz)	Output Power (dBm)	Output Power (W)	Max. Limit (dBm)	Max. Limit (W)	Result
5180	17.19	0.0524	23.98	0.2500	Pass
5200	18.78	0.0755	23.98	0.2500	Pass
5240	18.62	0.0728	23.98	0.2500	Pass
5260	18.62	0.0728	23.98	0.2500	Pass
5300	18.55	0.0716	23.98	0.2500	Pass
5320	16.09	0.0406	23.98	0.2500	Pass
5500	17.99	0.0630	23.98	0.2500	Pass
5580	18.98	0.0791	23.98	0.2500	Pass
5700	18.27	0.0671	23.98	0.2500	Pass
5745	21.19	0.1315	30.00	1.0000	Pass
5785	20.93	0.1239	30.00	1.0000	Pass
5825	21.18	0.1312	30.00	1.0000	Pass

Test Mode	IEEE 802.11ax (HE20)_Total	Tested Date	2022/11/25
-----------	----------------------------	-------------	------------

Test Frequency (MHz)	Output Power (dBm)	Output Power (W)	Max. Limit (dBm)	Max. Limit (W)	Result
5180	20.12	0.1027	23.98	0.2500	Pass
5200	21.50	0.1411	23.98	0.2500	Pass
5240	21.50	0.1412	23.98	0.2500	Pass
5260	21.51	0.1415	23.98	0.2500	Pass
5300	21.47	0.1403	23.98	0.2500	Pass
5320	19.02	0.0797	23.98	0.2500	Pass
5500	20.83	0.1210	23.98	0.2500	Pass
5580	21.77	0.1502	23.98	0.2500	Pass
5700	20.85	0.1217	23.98	0.2500	Pass
5745	23.85	0.2427	30.00	1.0000	Pass
5785	23.71	0.2348	30.00	1.0000	Pass
5825	23.81	0.2406	30.00	1.0000	Pass

Test Mode	IEEE 802.11ax (HE40)_Aux Ant.	Tested Date	2022/11/25
-----------	-------------------------------	-------------	------------

Test Frequency (MHz)	Output Power (dBm)	Output Power (W)	Max. Limit (dBm)	Max. Limit (W)	Result
5190	14.15	0.0260	23.98	0.2500	Pass
5230	18.40	0.0692	23.98	0.2500	Pass
5270	19.91	0.0979	23.98	0.2500	Pass
5310	14.92	0.0310	23.98	0.2500	Pass
5510	16.08	0.0406	23.98	0.2500	Pass
5550	20.40	0.1096	23.98	0.2500	Pass
5670	18.91	0.0778	23.98	0.2500	Pass
5755	19.57	0.0906	30.00	1.0000	Pass
5795	20.59	0.1146	30.00	1.0000	Pass

Test Mode	IEEE 802.11ax (HE40)_Main Ant.	Tested Date	2022/11/25
-----------	--------------------------------	-------------	------------

Test Frequency (MHz)	Output Power (dBm)	Output Power (W)	Max. Limit (dBm)	Max. Limit (W)	Result
5190	15.01	0.0317	23.98	0.2500	Pass
5230	19.03	0.0800	23.98	0.2500	Pass
5270	19.99	0.0998	23.98	0.2500	Pass
5310	15.13	0.0326	23.98	0.2500	Pass
5510	16.66	0.0463	23.98	0.2500	Pass
5550	20.92	0.1236	23.98	0.2500	Pass
5670	19.27	0.0845	23.98	0.2500	Pass
5755	20.27	0.1064	30.00	1.0000	Pass
5795	21.03	0.1268	30.00	1.0000	Pass

Test Mode	IEEE 802.11ax (HE40)_Total	Tested Date	2022/11/25
-----------	----------------------------	-------------	------------

Test Frequency (MHz)	Output Power (dBm)	Output Power (W)	Max. Limit (dBm)	Max. Limit (W)	Result
5190	17.61	0.0577	23.98	0.2500	Pass
5230	21.74	0.1492	23.98	0.2500	Pass
5270	22.96	0.1977	23.98	0.2500	Pass
5310	18.04	0.0636	23.98	0.2500	Pass
5510	19.39	0.0869	23.98	0.2500	Pass
5550	23.68	0.2332	23.98	0.2500	Pass
5670	22.10	0.1623	23.98	0.2500	Pass
5755	22.94	0.1970	30.00	1.0000	Pass
5795	23.83	0.2413	30.00	1.0000	Pass

Test Mode	IEEE 802.11ax (HE80)_Aux Ant.	Tested Date	2022/11/25
-----------	-------------------------------	-------------	------------

Test Frequency (MHz)	Output Power (dBm)	Output Power (W)	Max. Limit (dBm)	Max. Limit (W)	Result
5210	15.13	0.0326	23.98	0.2500	Pass
5290	15.03	0.0318	23.98	0.2500	Pass
5530	18.23	0.0665	23.98	0.2500	Pass
5610	19.30	0.0851	23.98	0.2500	Pass
5775	17.87	0.0612	30.00	1.0000	Pass

Test Mode	IEEE 802.11ax (HE80)_Main Ant.	Tested Date	2022/11/25
-----------	--------------------------------	-------------	------------

Test Frequency (MHz)	Output Power (dBm)	Output Power (W)	Max. Limit (dBm)	Max. Limit (W)	Result
5210	15.74	0.0375	23.98	0.2500	Pass
5290	15.13	0.0326	23.98	0.2500	Pass
5530	18.62	0.0728	23.98	0.2500	Pass
5610	19.89	0.0975	23.98	0.2500	Pass
5775	18.26	0.0670	30.00	1.0000	Pass

Test Mode	IEEE 802.11ax (HE80)_Total	Tested Date	2022/11/25
-----------	----------------------------	-------------	------------

Test Frequency (MHz)	Output Power (dBm)	Output Power (W)	Max. Limit (dBm)	Max. Limit (W)	Result
5210	18.46	0.0701	23.98	0.2500	Pass
5290	18.09	0.0644	23.98	0.2500	Pass
5530	21.44	0.1393	23.98	0.2500	Pass
5610	22.62	0.1826	23.98	0.2500	Pass
5775	21.08	0.1282	30.00	1.0000	Pass

Test Mode	IEEE 802.11ax (HE160)_Aux Ant.	Tested Date	2022/11/25
-----------	--------------------------------	-------------	------------

Test Frequency (MHz)	Output Power (dBm)	Output Power (W)	Max. Limit (dBm)	Max. Limit (W)	Result
5250	12.72	0.0187	23.98	0.2500	Pass
5570	14.55	0.0285	23.98	0.2500	Pass

Test Mode	IEEE 802.11ax (HE160)_Main Ant.	Tested Date	2022/11/25
-----------	---------------------------------	-------------	------------

Test Frequency (MHz)	Output Power (dBm)	Output Power (W)	Max. Limit (dBm)	Max. Limit (W)	Result
5250	13.00	0.0200	23.98	0.2500	Pass
5570	15.09	0.0323	23.98	0.2500	Pass

Test Mode	IEEE 802.11ax (HE160)_Total	Tested Date	2022/11/25
-----------	-----------------------------	-------------	------------

Test Frequency (MHz)	Output Power (dBm)	Output Power (W)	Max. Limit (dBm)	Max. Limit (W)	Result
5250	15.87	0.0387	23.98	0.2500	Pass
5570	17.84	0.0608	23.98	0.2500	Pass

End of Test Report