

# FCC Radio Test Report

**FCC ID: RWO-RZ090484****This report concerns: Class II Permissive Changes**

**Report No.** : BTL-FCCP-2-2209C159  
**Equipment** : Notebook PC  
**Model Name** : RZ09-0483  
**Brand Name** : RAZER  
**Applicant** : Razer Inc.  
**Address** : 9 Pasteur, Suite 100, Irvine, CA92618, USA.  
**Manufacturer** : Razer Inc.  
**Address** : 9 Pasteur, Suite 100, Irvine, CA92618, USA.

**Radio Function** : Bluetooth Low Energy (5.0)

**FCC Rule Part(s)** : FCC CFR Title 47, Part 15, Subpart C (15.247)  
**Measurement Procedure(s)** : ANSI C63.10-2013

**Date of Receipt** : 2022/10/18  
**Date of Test** : 2022/11/22~2023/1/17  
**Issued Date** : 2023/1/17

The above equipment has been tested and found in compliance with the requirement of the above standards by BTL Inc.

**Prepared by** : Eric Lee  
Eric Lee, Engineer

**Approved by** : Jerry Chuang  
Jerry Chuang, Supervisor

**BTL Inc.**

No.18, Ln. 171, Sec. 2, Jiuzong Rd., Neihu Dist., Taipei City 114, Taiwan

Tel: +886-2-2657-3299 Fax: +886-2-2657-3331 Web: www.newbtl.com Service mail: btl\_qa@newbtl.com

**Declaration**

**BTL** represents to the client that testing is done in accordance with standard procedures as applicable and that test instruments used has been calibrated with standards traceable to international standard(s) and/or national standard(s).

**BTL's** reports apply only to the specific samples tested under conditions. It is manufacture's responsibility to ensure that additional production units of this model are manufactured with the identical electrical and mechanical components. **BTL** shall have no liability for any declarations, inferences or generalizations drawn by the client or others from **BTL** issued reports.

This report is the confidential property of the client. As a mutual protection to the clients, the public and ourselves, the test report shall not be reproduced, except in full, without our written approval.

**BTL's** laboratory quality assurance procedures are in compliance with the **ISO/IEC 17025** requirements, and accredited by the conformity assessment authorities listed in this test report.

**BTL** is not responsible for the sampling stage, so the results only apply to the sample as received.

The information, data and test plan are provided by manufacturer which may affect the validity of results, so it is manufacturer's responsibility to ensure that the apparatus meets the essential requirements of applied standards and in all the possible configurations as representative of its intended use.

**Limitation**

For the use of the authority's logo is limited unless the Test Standard(s)/Scope(s)/Item(s) mentioned in this test report is (are) included in the conformity assessment authorities acceptance respective.

Please note that the measurement uncertainty is provided for informational purpose only and are not use in determining the Pass/Fail results.

**CONTENTS**

REVISION HISTORY	4
1 SUMMARY OF TEST RESULTS	5
1.1 TEST FACILITY	6
1.2 MEASUREMENT UNCERTAINTY	6
1.3 TEST ENVIRONMENT CONDITIONS	6
1.4 TABLE OF PARAMETERS OF TEST SOFTWARE SETTING	7
2 GENERAL INFORMATION	8
2.1 DESCRIPTION OF EUT	8
2.2 TEST MODES	10
2.3 BLOCK DIAGRAM SHOWING THE CONFIGURATION OF SYSTEM TESTED	11
2.4 SUPPORT UNITS	12
3 AC POWER LINE CONDUCTED EMISSIONS TEST	13
3.1 LIMIT	13
3.2 TEST PROCEDURE	13
3.3 DEVIATION FROM TEST STANDARD	13
3.4 TEST SETUP	14
3.5 TEST RESULT	14
4 RADIATED EMISSIONS TEST	15
4.1 LIMIT	15
4.2 TEST PROCEDURE	16
4.3 DEVIATION FROM TEST STANDARD	16
4.4 TEST SETUP	17
4.5 EUT OPERATING CONDITIONS	19
4.6 TEST RESULT – BELOW 30 MHZ	19
4.7 TEST RESULT – 30 MHZ TO 1 GHZ	19
4.8 TEST RESULT – ABOVE 1 GHZ	19
5 OUTPUT POWER TEST	20
5.1 APPLIED PROCEDURES / LIMIT	20
5.2 TEST PROCEDURE	20
5.3 DEVIATION FROM STANDARD	20
5.4 TEST SETUP	20
5.5 EUT OPERATION CONDITIONS	20
5.6 TEST RESULTS	20
6 LIST OF MEASURING EQUIPMENTS	21
7 EUT TEST PHOTO	22
8 EUT PHOTOS	22
APPENDIX A AC POWER LINE CONDUCTED EMISSIONS	23
APPENDIX B RADIATED EMISSIONS - 30 MHZ TO 1 GHZ	28
APPENDIX C RADIATED EMISSIONS - ABOVE 1 GHZ	31
APPENDIX D OUTPUT POWER	35

**REVISION HISTORY**

Report No.	Version	Description	Issued Date	Note
BTL-FCCP-2-2209C159	R00	Original Report.	2022/12/22	Invalid
BTL-FCCP-2-2209C159	R01	Revised report to address TAF Audit's comments.	2023/1/17	Valid

## 1 SUMMARY OF TEST RESULTS

Test procedures according to the technical standards.

Standard(s) Section	Description	Test Result	Judgement	Remark
15.207	AC Power Line Conducted Emissions	APPENDIX A	Pass	-----
15.205 15.209 15.247(d)	Radiated Emissions	APPENDIX B APPENDIX C	Pass	-----
15.247(a)(2)	Bandwidth	-----	Pass	-----
15.247(b)(3)	Output Power	APPENDIX D	Pass	-----
15.247(e)	Power Spectral Density	-----	Pass	-----
15.247(d)	Antenna conducted Spurious Emission	-----	Pass	-----
15.203	Antenna Requirement	-----	Pass	-----

**NOTE:**

- (1) "N/A" denotes test is not applicable in this Test Report.
- (2) The report format version is TP.1.1.1.
- (3) The antenna gain of EUT is smaller than that of the module. So in this report the worst cases of radiated spurious emissions and AC Power Line Conducted Emissions were evaluated and recorded. And evaluated the output power items and recorded in the report. For the test results of all other test items please refer to module test reports.

### 1.1 TEST FACILITY

The test facilities used to collect the test data in this report:

No. 72, Ln. 169, Sec. 2, Datong Rd., Xizhi Dist., New Taipei City 221, Taiwan

The test sites and facilities are covered under FCC RN: 674415 and DN: TW0659.

C06       CB21       CB22

No. 68-1, Ln. 169, Sec. 2, Datong Rd., Xizhi Dist., New Taipei City 221, Taiwan

The test sites and facilities are covered under FCC RN: 674415 and DN: TW0659.

C05       CB08       CB11       CB15       CB16  
 SR10

### 1.2 MEASUREMENT UNCERTAINTY

The reported uncertainty of measurement  $y \pm U$ , where expanded uncertainty  $U$  is based on a standard uncertainty multiplied by a coverage factor of  $k = 2$ , providing a level of confidence of approximately **95 %**. The measurement instrumentation uncertainty considerations contained in CISPR 16-4-2. The BTL measurement uncertainty is less than the CISPR 16-4-2  $U_{\text{cispr}}$  requirement.

A. AC power line conducted emissions test:

Test Site	Method	Measurement Frequency Range	U (dB)
C05	CISPR	150 kHz ~ 30MHz	3.44

B. Radiated emissions test :

Test Site	Measurement Frequency Range	U,(dB)
CB21	0.03 GHz ~ 0.2 GHz	4.17
	0.2 GHz ~ 1 GHz	4.72
	1 GHz ~ 6 GHz	5.21
	6 GHz ~ 18 GHz	5.51
	18 GHz ~ 26 GHz	3.69
	26 GHz ~ 40 GHz	4.23

C. Conducted test :

Test Item	U,(dB)
Output power	0.3669

NOTE:

Unless specifically mentioned, the uncertainty of measurement has not been taken into account to declare the compliance or non-compliance to the specification.

### 1.3 TEST ENVIRONMENT CONDITIONS

Test Item	Environment Condition	Test Voltage	Tested by
AC Power Line Conducted Emissions	23°C, 58%	AC 120V/60Hz	Jay Tien
Radiated emissions below 1 GHz	23°C, 59%	AC 120V/60Hz	Mark Wang
Radiated emissions above 1 GHz	23°C, 59%	AC 120V/60Hz	Mark Wang
Output Power	22.3°C, 52%	AC 120V/60Hz	Angela Wang

**1.4 TABLE OF PARAMETERS OF TEST SOFTWARE SETTING**

Test Software	DRTU V02593.22.170.0			
Modulation Mode	2402 MHz	2440 MHz	2480 MHz	Data Rate
BLE 5.0	10	12	14	1 Mbps

## 2 GENERAL INFORMATION

### 2.1 DESCRIPTION OF EUT

Equipment	Notebook PC
Model Name	RZ09-0483
Brand Name	RAZER
Model Difference	N/A
Power Source	1# DC voltage supplied from AC adapter. Model 1: RC30-042 Model 2: RC30-0484 2# Supplied from battery. Model : RC30-0483
Power Rating	1# Model 1: I/P: 100-240V~ 4A MAX,50/60Hz O/P: 19.5V===14.36A Model 2: I/P: 100-240V~ 4.5A,50/60Hz O/P: 19.5V===16.92A 2# DC 15.4V, 6182mAh, 95.2Wh
Products Covered	2* POWER Adapter 1* AC Cable
Operation Band	2400 MHz ~ 2483.5 MHz
Operation Frequency	2402 MHz ~ 2480 MHz
Modulation Technology	GFSK
Transfer Rate	1 Mbps
Output Power Max.	1 Mbps: 8.86 dBm (0.0077 W)
Test Model	RZ09-0483
Sample Status	Engineering Sample
EUT Modification(s)	N/A

**NOTE:**

- (1) The above EUT information is declared by manufacturer and for more detailed features description, please refers to the manufacturer's specifications or user's manual.



## (2) Channel List:

Channel	Frequency (MHz)	Channel	Frequency (MHz)
00	2402	20	2442
01	2404	21	2444
02	2406	22	2446
03	2408	23	2448
04	2410	24	2450
05	2412	25	2452
06	2414	26	2454
07	2416	27	2456
08	2418	28	2458
09	2420	29	2460
10	2422	30	2462
11	2424	31	2464
12	2426	32	2466
13	2428	33	2468
14	2430	34	2470
15	2432	35	2472
16	2434	36	2474
17	2436	37	2476
18	2438	38	2478
19	2440	39	2480

## (3) Table for Filed Antenna:

Ant.	Manufacturer	P/N	Type	Connector	Gain (dBi)
1	Amphenol Taiwan Corporation	BY5962-15-001-C	PIFA	N/A	2.98

Note:

(1) Ant.1 refers to main antenna.

(2) The AUX antenna connector of the module connected to the MAIN antenna of the EUT.

- (4) The above Antenna information are derived from the antenna data sheet provided by manufacturer and for more detailed features description, please refer to the manufacturer's specifications, the laboratory shall not be held responsible.

**2.2 TEST MODES**

Test Items	Test mode	Channel	Note
AC power line conducted emissions	Normal/Idle	-	-
Transmitter Radiated Emissions (below 1GHz)	1 Mbps	39	-
Transmitter Radiated Emissions (above 1GHz)	1 Mbps	39	Bandedge
	1 Mbps	39	Harmonic
Output Power	1 Mbps	00/19/39	-

**NOTE:**

- (1) For radiated emission band edge test, both Vertical and Horizontal are evaluated, but only the worst case (Vertical) is recorded.
- (2) This Notebook PC has two mainboards with two adapters. Both mainboard MB1 (with adapter RC30-0484) and mainboard MB2 (with adapter RC30-042) had been pre-tested and in this report only recorded the worst case.

### 2.3 BLOCK DIAGRAM SHOWING THE CONFIGURATION OF SYSTEM TESTED

Equipment letters and Cable numbers refer to item numbers described in the tables of clause 2.4.

AC power line conducted emissions

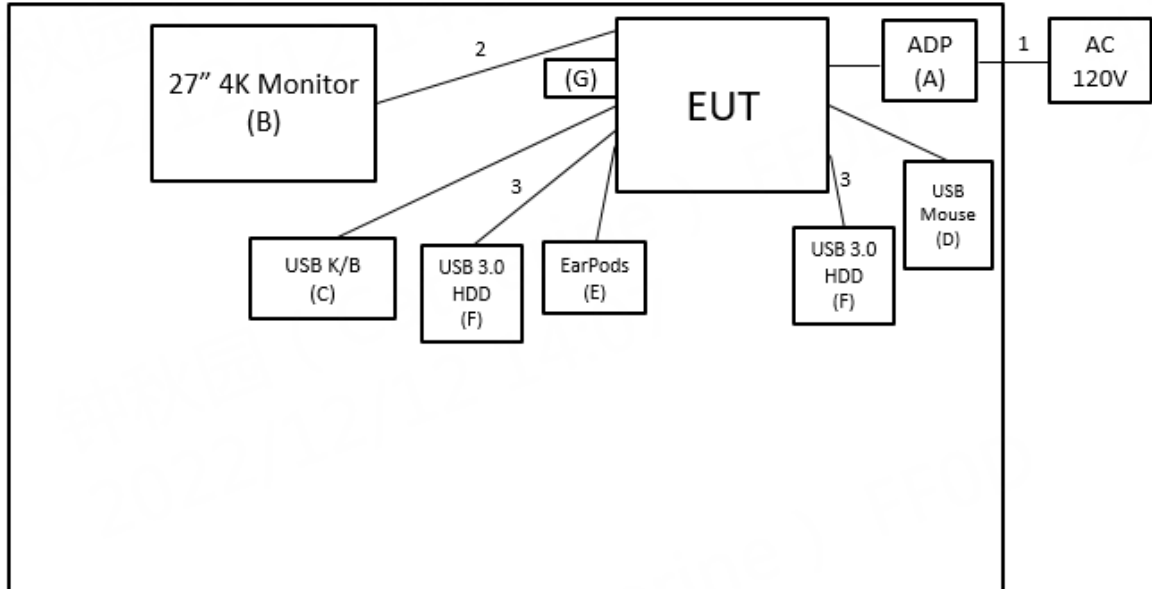

Radiated Emissions

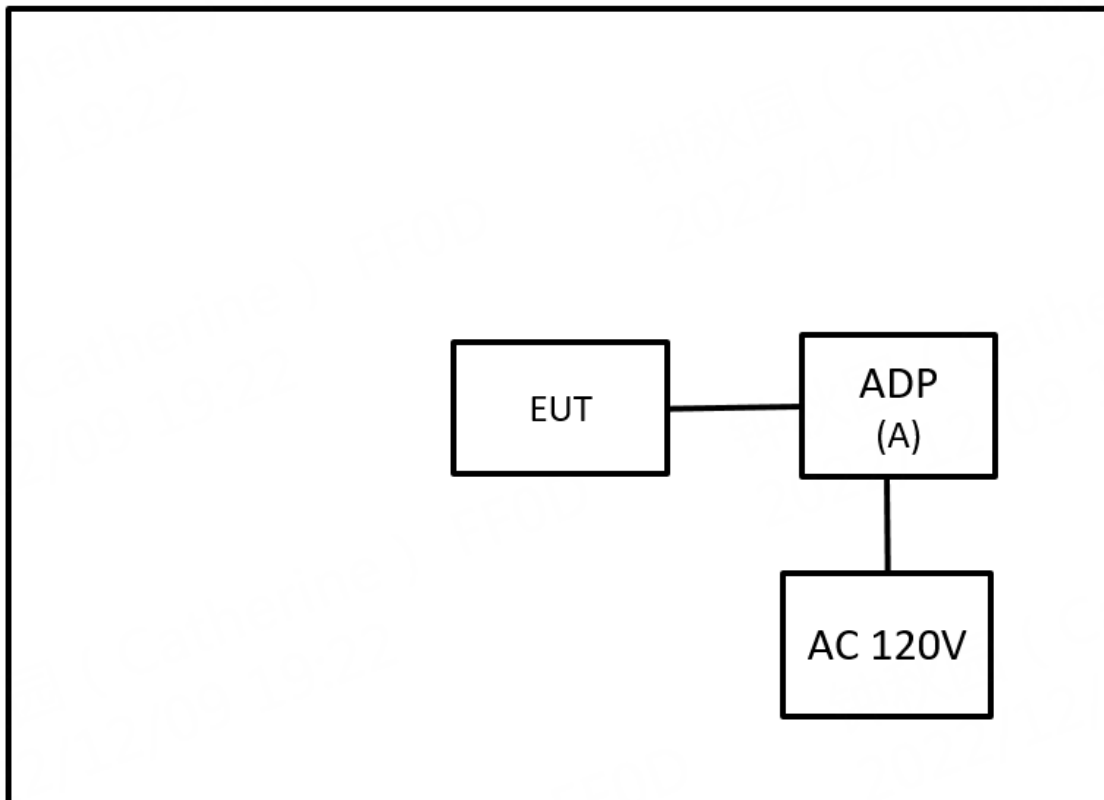

**2.4 SUPPORT UNITS**

## AC power line conducted emissions

Item	Equipment	Brand	Model No.	Series No.	Remarks
A	ADP	Razer	RC30-042	952226U26100653	Supplied by test requester.
B	27" 4K Monitor	DELL	U2720Q	CN-083VF-WSL00-0 B7-332L	Furnished by test lab.
C	USB K/B	DELL	KB216t	CN-0W33XP-L0300- 797-05TY-A03	Furnished by test lab.
D	USB Mouse	DELL	MOCZUL	CN-049TWY-PRC00- 79E-01HA	Furnished by test lab.
E	EarPods	Apple	A1472	N/A	Furnished by test lab.
F	USB 3.0 HDD	WD	WDBC3C0010BSL-0B	WX81A88ALJUC	Furnished by test lab.
G	USB Dongle	Kingston	DataTraveler Exodia	N/A	Furnished by test lab.

Item	Shielded	Ferrite Core	Length	Cable Type	Remarks
1	No	No	1.2m	Power Cable	Supplied by test requester.
2	No	No	1.7m	HDMI Cable	Furnished by test lab.
3	No	No	18cm	TypeC to TypeC Cable	Furnished by test lab.

## Radiated Emissions

Item	Equipment	Brand	Model No.	Series No.	Remarks
A	ADP	Razer	RC30-042	952226U26100653	Supplied by test requester.

Item	Shielded	Ferrite Core	Length	Cable Type	Remarks
1	N/A	N/A	1m	PowerCode	Supplied by test requester.

### 3 AC POWER LINE CONDUCTED EMISSIONS TEST

#### 3.1 LIMIT

Frequency (MHz)	Limit (dB $\mu$ V)	
	Quasi-peak	Average
0.15 - 0.5	66 - 56 *	56 - 46 *
0.50 - 5.0	56	46
5.0 - 30.0	60	50

**NOTE:**

- (1) The tighter limit applies at the band edges.
- (2) The limit of " \* " marked band means the limitation decreases linearly with the logarithm of the frequency in the range.
- (3) The test result calculated as following:  
 Measurement Value = Reading Level + Correct Factor  
 Correct Factor = Insertion Loss + Cable Loss + Attenuator Factor (if use)  
 Margin Level = Measurement Value – Limit Value  
 Calculation example:

Reading Level		Correct Factor		Measurement Value
38.22	+	3.45	=	41.67

Measurement Value		Limit Value		Margin Level
41.67	-	60	=	-18.33

The following table is the setting of the receiver.

Receiver Parameter	Setting
Attenuation	10 dB
Start Frequency	0.15 MHz
Stop Frequency	30 MHz
IF Bandwidth	9 KHz

#### 3.2 TEST PROCEDURE

- a. The EUT was placed 0.8 m above the horizontal ground plane with the EUT being connected to the power mains through a line impedance stabilization network (LISN).  
 All other support equipment were powered from an additional LISN(s).  
 The LISN provides 50 Ohm/50uH of impedance for the measuring instrument.
- b. Interconnecting cables that hang closer than 40 cm to the ground plane shall be folded back and forth in the center forming a bundle to keep the cable above 40 cm.
- c. Excess I/O cables that are not connected to a peripheral shall be bundled in the center.  
 The end of the cable will be terminated, using the correct terminating impedance.  
 The overall length shall not exceed 1 m.
- d. The LISN is spaced at least 80 cm from the nearest part of the EUT chassis.
- e. For the actual test configuration, please refer to the related Item – EUT TEST PHOTO.

**NOTE:**

- (1) In the results, each reading is marked as Peak, QP or AVG per the detector used.  
 BW=9 kHz (6 dB Bandwidth)
- (2) All readings are Peak unless otherwise stated QP or AVG in column of Note. Both the QP and the AVG readings must be less than the limit for compliance.

#### 3.3 DEVIATION FROM TEST STANDARD

No deviation.

### 3.4 TEST SETUP

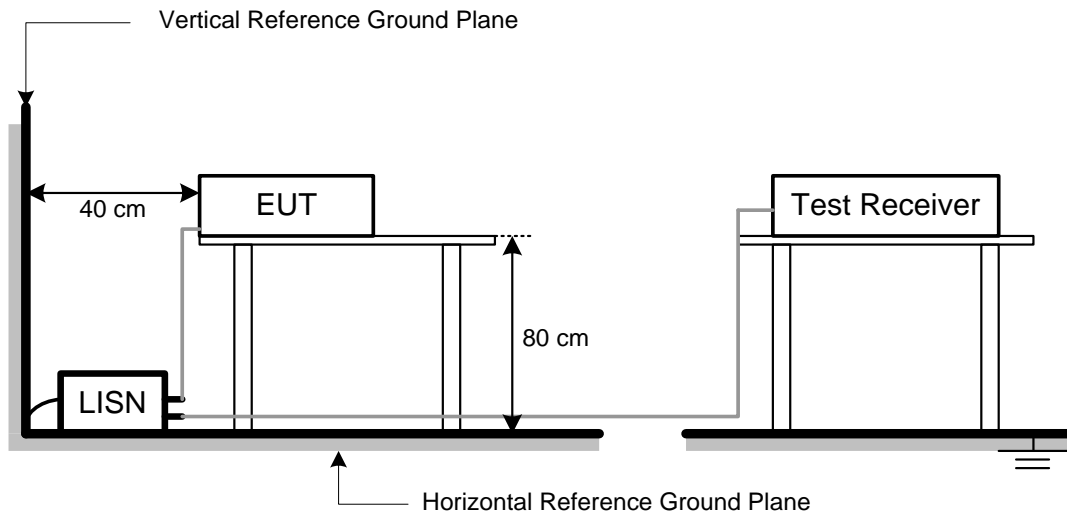

### 3.5 TEST RESULT

Please refer to the **APPENDIX A**.

## 4 RADIATED EMISSIONS TEST

### 4.1 LIMIT

In case the emission fall within the restricted band specified on 15.205, then the 15.209 limit in the table below has to be followed.

#### LIMITS OF RADIATED EMISSIONS MEASUREMENT (9 kHz to 1000 MHz)

Frequency (MHz)	Field Strength (microvolts/meter)	Measurement Distance (meters)
0.009~0.490	2400/F(KHz)	300
0.490~1.705	24000/F(KHz)	30
1.705~30.0	30	30
30~88	100	3
88~216	150	3
216~960	200	3
960~1000	500	3

#### LIMITS OF RADIATED EMISSIONS MEASUREMENT (Above 1000 MHz)

Frequency (MHz)	Radiated Emissions (dBuV/m)		Measurement Distance (meters)
	Peak	Average	
Above 1000	74	54	3

#### NOTE:

- (1) The limit for radiated test was performed according to FCC CFR Title 47, Part 15, Subpart C.
- (2) The tighter limit applies at the band edges.
- (3) Emission level (dBuV/m)=20log Emission level (uV/m).
- (4) The test result calculated as following:  
 Measurement Value = Reading Level + Correct Factor  
 Correct Factor = Antenna Factor + Cable Loss - Amplifier Gain(if use)  
 Margin Level = Measurement Value - Limit Value  
 Calculation example:

Reading Level		Correct Factor	=	Measurement Value
41.91	+	-8.36	=	33.55

Measurement Value		Limit Value	=	Margin Level
33.55	-	43.50	=	-9.95

Spectrum Parameter	Setting
Attenuation	Auto
Start Frequency	1000 MHz
Stop Frequency	10th carrier harmonic
RBW / VBW (Emission in restricted band)	1MHz / 3MHz for Peak, 1MHz / 1/T for Average

Spectrum Parameter	Setting
Attenuation	Auto
Start ~ Stop Frequency	9KHz~90KHz for PK/AVG detector
Start ~ Stop Frequency	90KHz~110KHz for QP detector
Start ~ Stop Frequency	110KHz~490KHz for PK/AVG detector
Start ~ Stop Frequency	490KHz~30MHz for QP detector
Start ~ Stop Frequency	30MHz~1000MHz for QP detector

#### 4.2 TEST PROCEDURE

- a. The measuring distance of 3 m shall be used for measurements. The EUT was placed on the top of a rotating table 0.8 meter above the ground at a 3 meter semi-anechoic chamber. The table was rotated 360 degrees to determine the position of the highest radiation.(below 1GHz)
- b. The measuring distance of 3 m shall be used for measurements. The EUT was placed on the top of a rotating table 1.5 meter above the ground at a 3 meter semi-anechoic chamber. The table was rotated 360 degrees to determine the position of the highest radiation.(above 1GHz)
- c. The height of the equipment or of the substitution antenna shall be 0.8 m or 1.5 m, the height of the test antenna shall vary between 1 m to 4 m. Both horizontal and vertical polarizations of the antenna are set to make the measurement.
- d. For each suspected emission, the EUT was arranged to its worst case and then the antenna was tuned to heights find the maximum reading (used Bore sight function).
- e. The receiver system was set to peak and average detect function and specified bandwidth with maximum hold mode when the test frequency is above 1GHz.
- f. The initial step in collecting radiated emission data is a receiver peak detector mode pre-scanning the measurement frequency range. Significant peaks are then marked and then Quasi Peak detector mode re-measured.
- g. All readings are Peak unless otherwise stated QP in column of Note. Peak denotes that the Peak reading compliance with the QP Limits and then QP Mode measurement didn't perform. (below 1GHz)
- h. All readings are Peak Mode value unless otherwise stated AVG in column of Note. If the Peak Mode Measured value compliance with the Peak Limits and lower than AVG Limits, the EUT shall be deemed to meet both Peak & AVG Limits and then only Peak Mode was measured, but AVG Mode didn't perform. (above 1GHz)
- i. For the actual test configuration, please refer to the related Item – EUT TEST PHOTO.

#### 4.3 DEVIATION FROM TEST STANDARD

No deviation.



## 4.4 TEST SETUP

9 kHz to 30 MHz

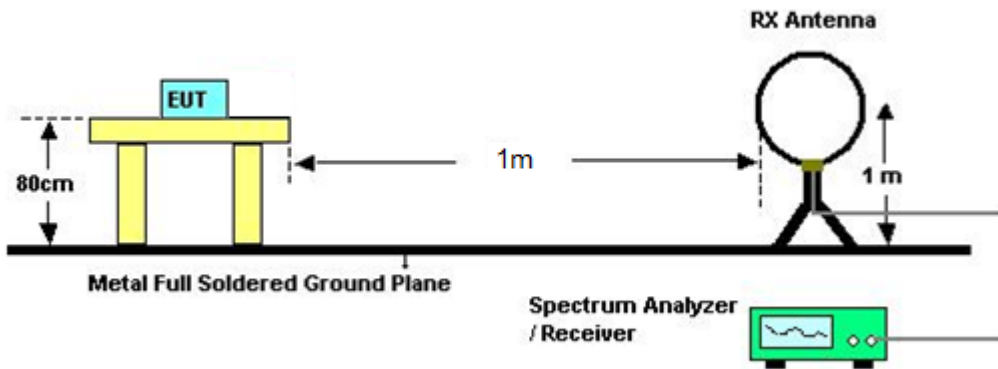

30 MHz to 1 GHz

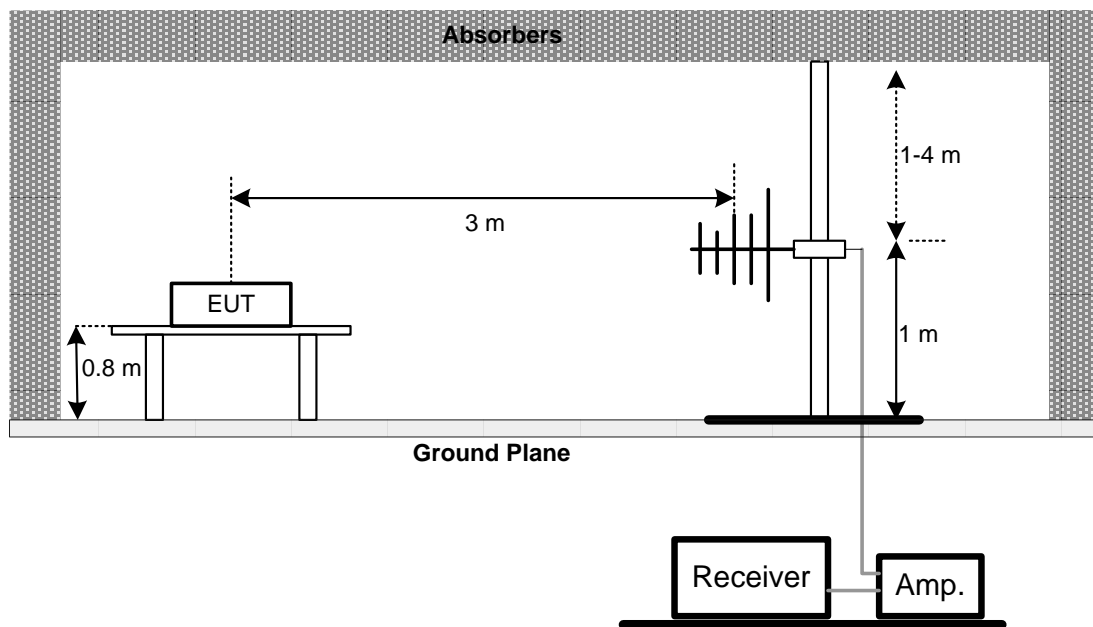

Above 1 GHz

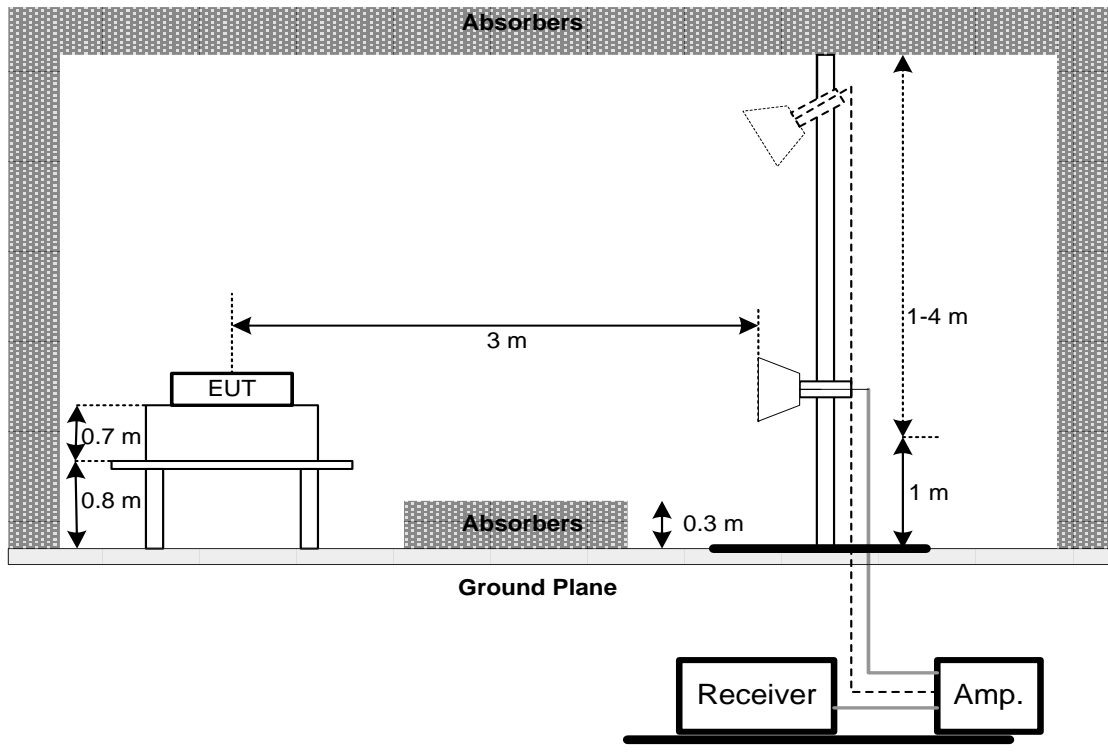

**4.5 EUT OPERATING CONDITIONS**

The EUT was programmed to be in continuously transmitting mode.

**4.6 TEST RESULT – BELOW 30 MHZ**

There were no emissions found below 30 MHz within 20 dB of the limit.

**4.7 TEST RESULT – 30 MHZ TO 1 GHZ**

Please refer to the APPENDIX B.

**4.8 TEST RESULT – ABOVE 1 GHZ**

Please refer to the APPENDIX C.

**NOTE:**

- (1) No limit: This is fundamental signal, the judgment is not applicable.  
For fundamental signal judgment was referred to Peak output test.

## 5 OUTPUT POWER TEST

### 5.1 APPLIED PROCEDURES / LIMIT

FCC Part15 (15.247) , Subpart C				
Section	Test Item	Limit	Frequency Range (MHz)	Result
15.247(b)(3)	Maximum Output Power	1 watt or 30dBm	2400-2483.5	PASS

### 5.2 TEST PROCEDURE

- a. The EUT was directly connected to the power meter and antenna output port as show in the block diagram below,
- b. The maximum peak conducted output power was performed in accordance with FCC KDB 558074 D01 15.247 Meas Guidance.

### 5.3 DEVIATION FROM STANDARD

No deviation.

### 5.4 TEST SETUP



### 5.5 EUT OPERATION CONDITIONS

The EUT was programmed to be in continuously transmitting mode.

### 5.6 TEST RESULTS

Please refer to the APPENDIX D.

## 6 LIST OF MEASURING EQUIPMENTS

AC Power Line Conducted Emissions						
Item	Kind of Equipment	Manufacturer	Type No.	Serial No.	Calibrated Date	Calibrated Until
1	TWO-LINE V-NETWORK	R&S	ENV216	101051	2022/6/15	2023/6/14
2	Test Cable	EMCI	EMCRG58-BM-B M-9000	210501	2022/5/2	2023/5/1
3	EMI Test Receiver	R&S	ESR 7	101433	2022/11/16	2023/11/15
4	Measurement Software	EZ	EZ EMC (Version NB-03A1-01)	N/A	N/A	N/A

Radiated Emissions						
Item	Kind of Equipment	Manufacturer	Type No.	Serial No.	Calibrated Date	Calibrated Until
1	Preamplifier	EMCI	EMC330N	980850	2022/9/19	2023/9/18
2	Preamplifier	EMCI	EMC118A45SE	980819	2022/3/8	2023/3/7
3	Preamplifier	EMCI	EMC184045SE	980882	2022/2/9	2023/2/8
4	Preamplifier	EMCI	EMC001340	980579	2022/9/30	2023/9/29
5	Test Cable	EMCI	EMC104-SM-SM-1000	220319	2022/3/15	2023/3/14
6	Test Cable	EMCI	EMC104-SM-SM-3000	220322	2022/3/15	2023/3/14
7	Test Cable	EMCI	EMC104-SM-SM-7000	220324	2022/3/15	2023/3/14
8	EXA Signal Analyzer	keysight	N9020B	MY57120120	2022/3/7	2023/3/6
9	Loop Ant	Electro-Metrics	EMCI-LPA600	291	2022/9/19	2023/9/18
10	Horn Antenna	RFSPIN	DRH18-E	211202A18EN	2022/5/18	2023/5/17
11	Horn Ant	Schwarzbeck	BBHA 9170D	1136	2022/5/18	2023/5/17
12	Log-bicon Antenna	Schwarzbeck	VULB9168	1369	2022/5/20	2023/5/19
13	6dB Attenuator	EMCI	EMCI-N-6-06	AT-N0625	2022/5/20	2023/5/19
14	Measurement Software	EZ	EZ EMC (Version NB-03A1-01)	N/A	N/A	N/A

Output Power						
Item	Kind of Equipment	Manufacturer	Type No.	Serial No.	Calibrated Date	Calibrated Until
1	Power Meter	Anritsu	ML2495A	1128008	2022/6/1	2023/5/31
2	Power Sensor	Anritsu	MA2411B	1126001	2022/6/1	2023/5/31

Remark: "N/A" denotes no model name, no serial no. or no calibration specified.  
All calibration period of equipment list is one year.

## **7 EUT TEST PHOTO**

Please refer to document Appendix No.: TP-2209C159-1 (APPENDIX-TEST PHOTOS).

## **8 EUT PHOTOS**

Please refer to document Appendix No.: EP-2209C159-1 (APPENDIX-EUT PHOTOS).

## **APPENDIX A AC POWER LINE CONDUCTED EMISSIONS**

Test Mode	Normal	Tested Date	2022/11/23
Test Frequency	-	Phase	Line

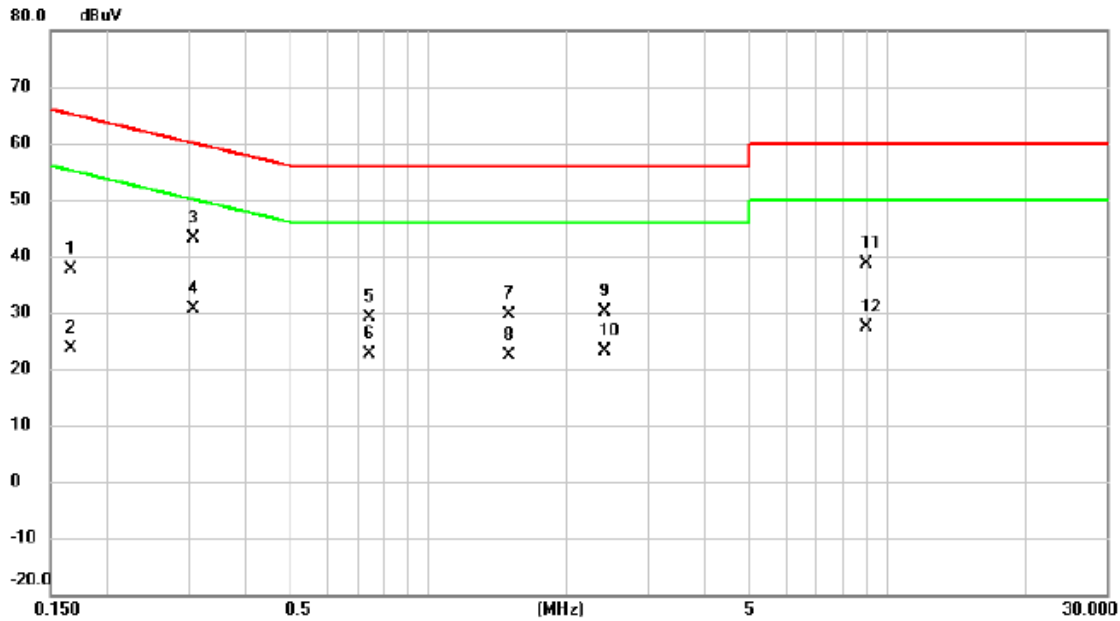

No.	Mk.	Freq. MHz	Reading Level dBuV	Correct Factor dB	Measure- ment dBuV	Limit dBuV	Margin dB	Detector	Comment
1		0.1657	37.60	0.02	37.62	65.17	-27.55	QP	
2		0.1657	23.66	0.02	23.68	55.17	-31.49	AVG	
3	*	0.3074	43.23	0.02	43.25	60.04	-16.79	QP	
4		0.3074	30.66	0.02	30.68	50.04	-19.36	AVG	
5		0.7440	29.02	0.03	29.05	56.00	-26.95	QP	
6		0.7440	22.72	0.03	22.75	46.00	-23.25	AVG	
7		1.4977	29.54	0.06	29.60	56.00	-26.40	QP	
8		1.4977	22.24	0.06	22.30	46.00	-23.70	AVG	
9		2.4180	30.15	0.08	30.23	56.00	-25.77	QP	
10		2.4180	23.15	0.08	23.23	46.00	-22.77	AVG	
11		9.0262	38.47	0.18	38.65	60.00	-21.35	QP	
12		9.0262	27.13	0.18	27.31	50.00	-22.69	AVG	

**REMARKS:**

- (1) Measurement Value = Reading Level + Correct Factor.
- (2) Margin Level = Measurement Value - Limit Value.



Test Mode	Normal	Tested Date	2022/11/23
Test Frequency	-	Phase	Neutral

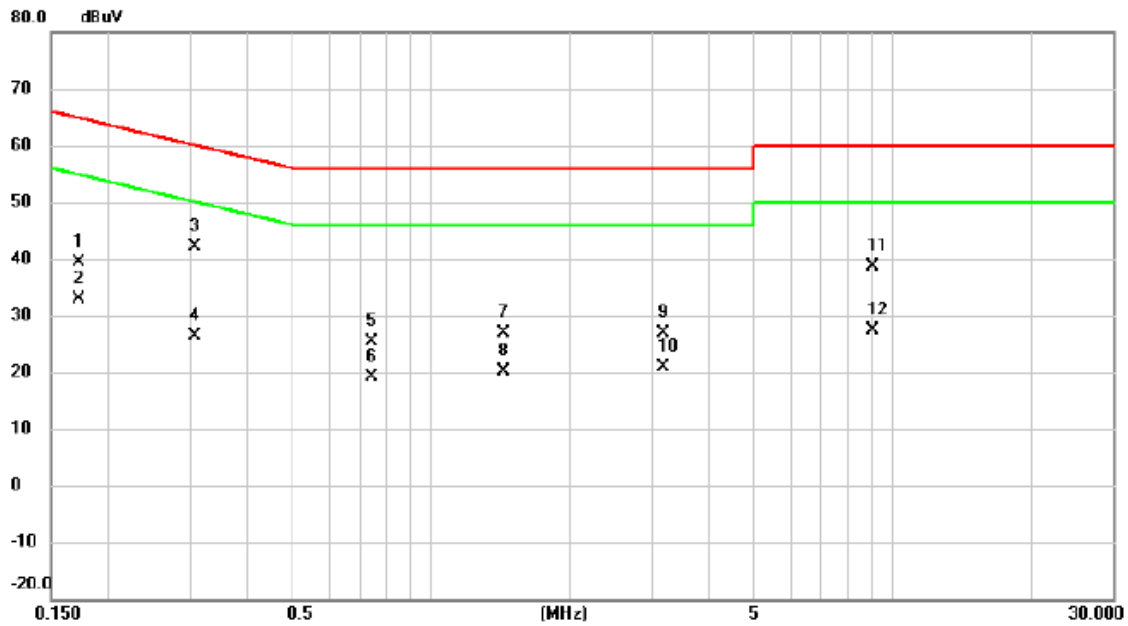

No.	Mk.	Freq.	Reading Level	Correct Factor	Measurement	Limit	Margin	Detector	Comment
		MHz	dBuV	dB	dBuV	dBuV	dB		
1		0.1725	39.31	0.02	39.33	64.84	-25.51	QP	
2		0.1725	32.80	0.02	32.82	54.84	-22.02	AVG	
3	*	0.3075	42.17	0.02	42.19	60.04	-17.85	QP	
4		0.3075	26.45	0.02	26.47	50.04	-23.57	AVG	
5		0.7440	25.30	0.03	25.33	56.00	-30.67	QP	
6		0.7440	19.20	0.03	19.23	46.00	-26.77	AVG	
7		1.4370	26.82	0.06	26.88	56.00	-29.12	QP	
8		1.4370	20.04	0.06	20.10	46.00	-25.90	AVG	
9		3.1762	26.83	0.10	26.93	56.00	-29.07	QP	
10		3.1762	20.82	0.10	20.92	46.00	-25.08	AVG	
11		9.0510	38.42	0.18	38.60	60.00	-21.40	QP	
12		9.0510	27.13	0.18	27.31	50.00	-22.69	AVG	

**REMARKS:**

- (1) Measurement Value = Reading Level + Correct Factor.
- (2) Margin Level = Measurement Value - Limit Value.

Test Mode	Idle	Tested Date	2022/11/23
Test Frequency	-	Phase	Line

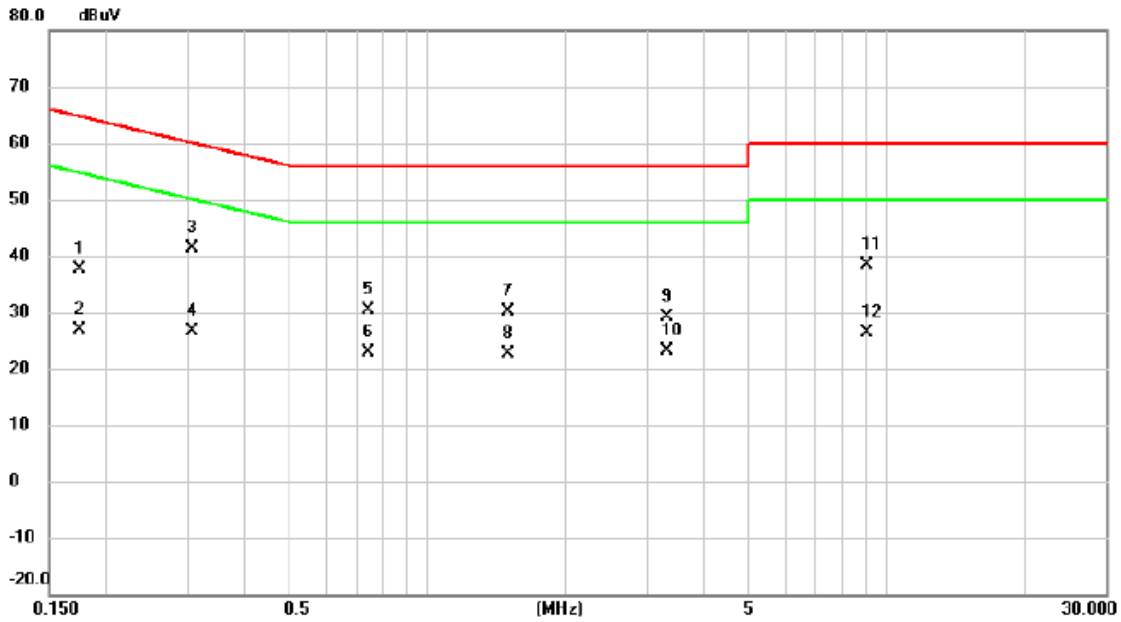

No. Mk.	Freq. MHz	Reading Level dBuV	Correct Factor dB	Measurement dBuV	Limit dBuV	Margin dB	Detector	Comment
1	0.1748	37.58	0.02	37.60	64.73	-27.13	QP	
2	0.1748	26.83	0.02	26.85	54.73	-27.88	AVG	
3 *	0.3075	41.43	0.02	41.45	60.04	-18.59	QP	
4	0.3075	26.58	0.02	26.60	50.04	-23.44	AVG	
5	0.7417	30.29	0.03	30.32	56.00	-25.68	QP	
6	0.7417	22.84	0.03	22.87	46.00	-23.13	AVG	
7	1.4978	30.14	0.06	30.20	56.00	-25.80	QP	
8	1.4978	22.64	0.06	22.70	46.00	-23.30	AVG	
9	3.3135	29.07	0.10	29.17	56.00	-26.83	QP	
10	3.3135	23.12	0.10	23.22	46.00	-22.78	AVG	
11	9.0487	38.28	0.18	38.46	60.00	-21.54	QP	
12	9.0487	26.28	0.18	26.46	50.00	-23.54	AVG	

REMARKS:

- (1) Measurement Value = Reading Level + Correct Factor.
- (2) Margin Level = Measurement Value - Limit Value.

Test Mode	Idle	Tested Date	2022/11/23
Test Frequency	-	Phase	Neutral

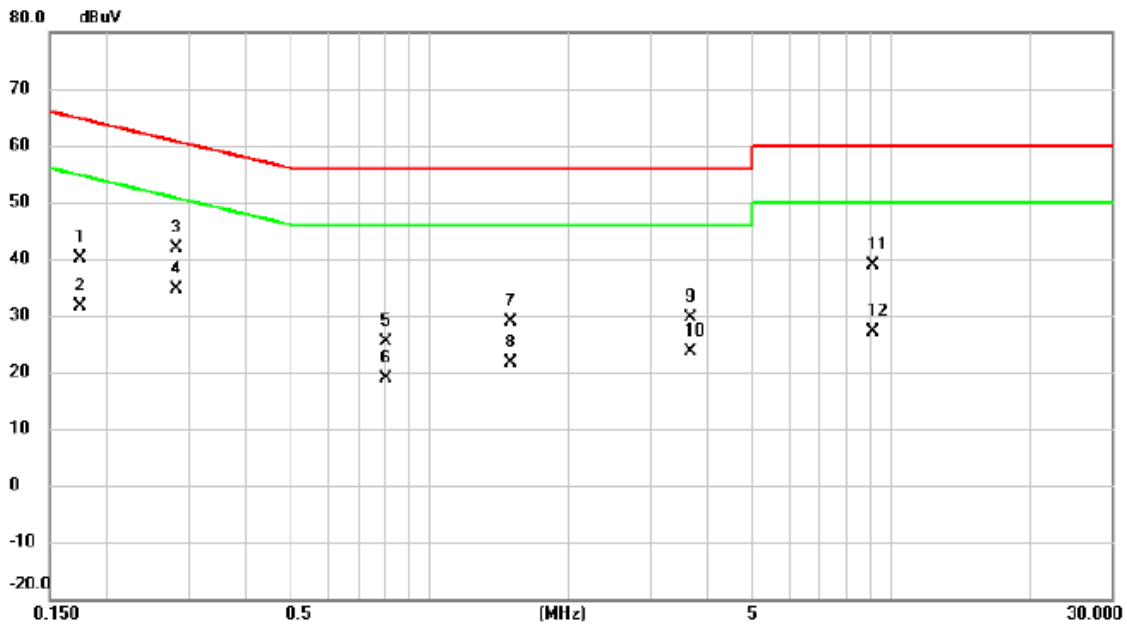

No.	Mk.	Freq. MHz	Reading Level dBuV	Correct Factor dB	Measure- ment dBuV	Limit dBuV	Margin dB	Detector	Comment
1		0.1747	40.13	0.02	40.15	64.73	-24.58	QP	
2		0.1747	31.60	0.02	31.62	54.73	-23.11	AVG	
3		0.2827	41.85	0.02	41.87	60.74	-18.87	QP	
4	*	0.2827	34.55	0.02	34.57	50.74	-16.17	AVG	
5		0.8047	25.31	0.04	25.35	56.00	-30.65	QP	
6		0.8047	18.88	0.04	18.92	46.00	-27.08	AVG	
7		1.4955	28.82	0.06	28.88	56.00	-27.12	QP	
8		1.4955	21.63	0.06	21.69	46.00	-24.31	AVG	
9		3.6802	29.44	0.11	29.55	56.00	-26.45	QP	
10		3.6802	23.53	0.11	23.64	46.00	-22.36	AVG	
11		9.0960	38.65	0.18	38.83	60.00	-21.17	QP	
12		9.0960	27.04	0.18	27.22	50.00	-22.78	AVG	

**REMARKS:**

- (1) Measurement Value = Reading Level + Correct Factor.
- (2) Margin Level = Measurement Value - Limit Value.

## **APPENDIX B RADIATED EMISSIONS - 30 MHZ TO 1 GHZ**

Test Mode	BLE 5.0 (1 Mbps)	Test Date	2023/1/17
Test Frequency	2480MHz	Polarization	Vertical
Temp	23°C	Hum.	59%

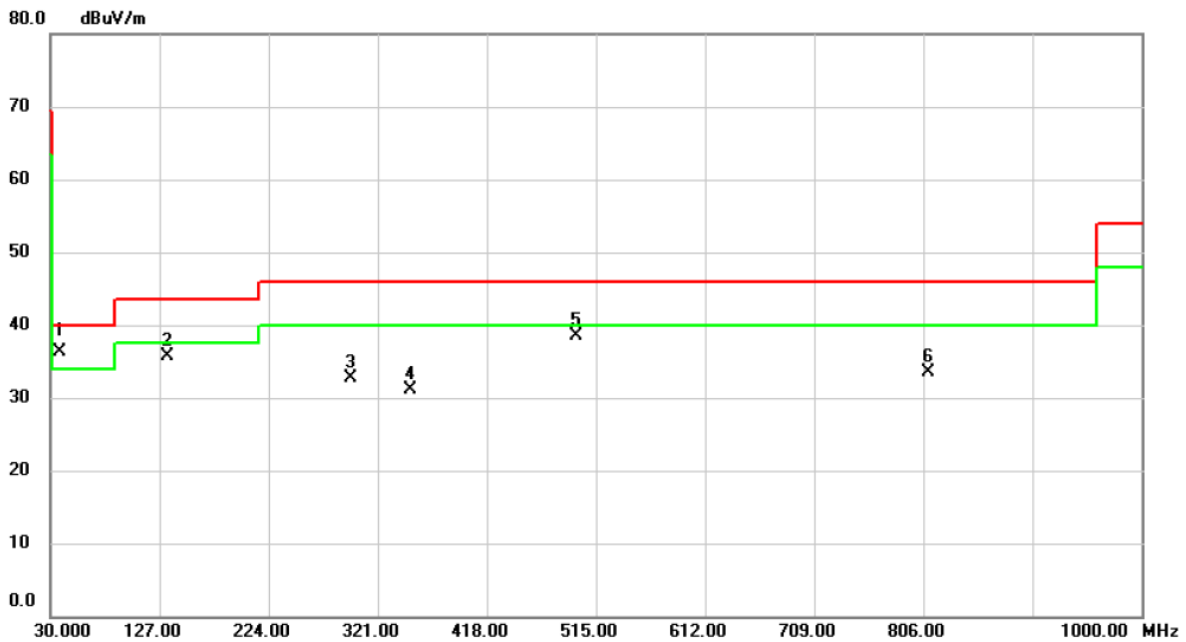

No.	Mk.	Freq. MHz	Reading Level dBuV	Correct Factor dB	Measure- ment dBuV/m	Limit dBuV/m	Over dB	Detector	Comment
1	*	38.0510	48.40	-12.11	36.29	40.00	-3.71	QP	
2		133.7253	48.76	-13.01	35.75	43.50	-7.75	peak	
3		297.0087	44.15	-11.51	32.64	46.00	-13.36	peak	
4		350.4880	41.45	-10.35	31.10	46.00	-14.90	peak	
5		497.3137	45.00	-6.57	38.43	46.00	-7.57	peak	
6		810.0092	34.47	-0.95	33.52	46.00	-12.48	peak	

**REMARKS:**

- (1) Measurement Value = Reading Level + Correct Factor.
- (2) Margin Level = Measurement Value - Limit Value.

Test Mode	BLE 5.0 (1 Mbps)	Test Date	2023/1/17
Test Frequency	2480MHz	Polarization	Horizontal
Temp	23°C	Hum.	59%

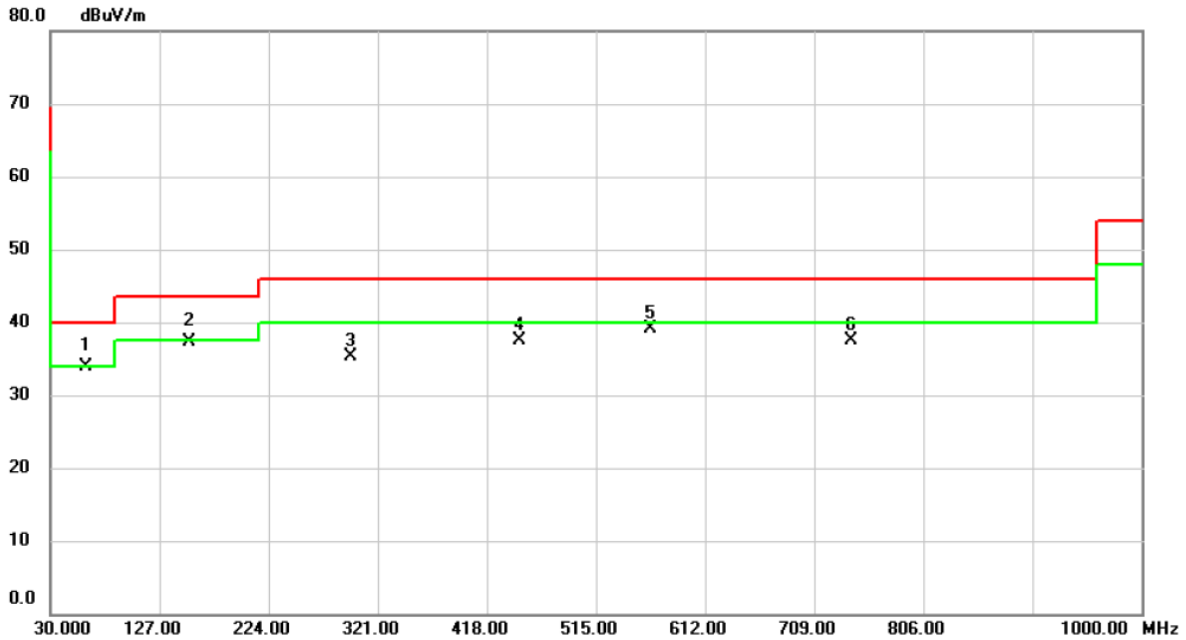

No.	Mk.	Freq. MHz	Reading Level dBuV	Correct Factor dB	Measure- ment dBuV/m	Limit dBuV/m	Over dB	Detector	Comment
1	*	61.6220	46.20	-12.33	33.87	40.00	-6.13	QP	
2		154.0630	49.12	-11.79	37.33	43.50	-6.17	QP	
3		297.0087	46.84	-11.51	35.33	46.00	-10.67	peak	
4		447.2293	44.93	-7.48	37.45	46.00	-8.55	peak	
5		563.5323	44.40	-5.21	39.19	46.00	-6.81	peak	
6		742.4973	39.29	-1.74	37.55	46.00	-8.45	peak	

**REMARKS:**

(1) Measurement Value = Reading Level + Correct Factor.

(2) Margin Level = Measurement Value - Limit Value.

## APPENDIX C RADIATED EMISSIONS - ABOVE 1 GHZ

Test Mode	BLE 5.0 (1 Mbps)	Test Date	2022/11/25
Test Frequency	2480MHz	Polarization	Vertical
Temp	23°C	Hum.	59%

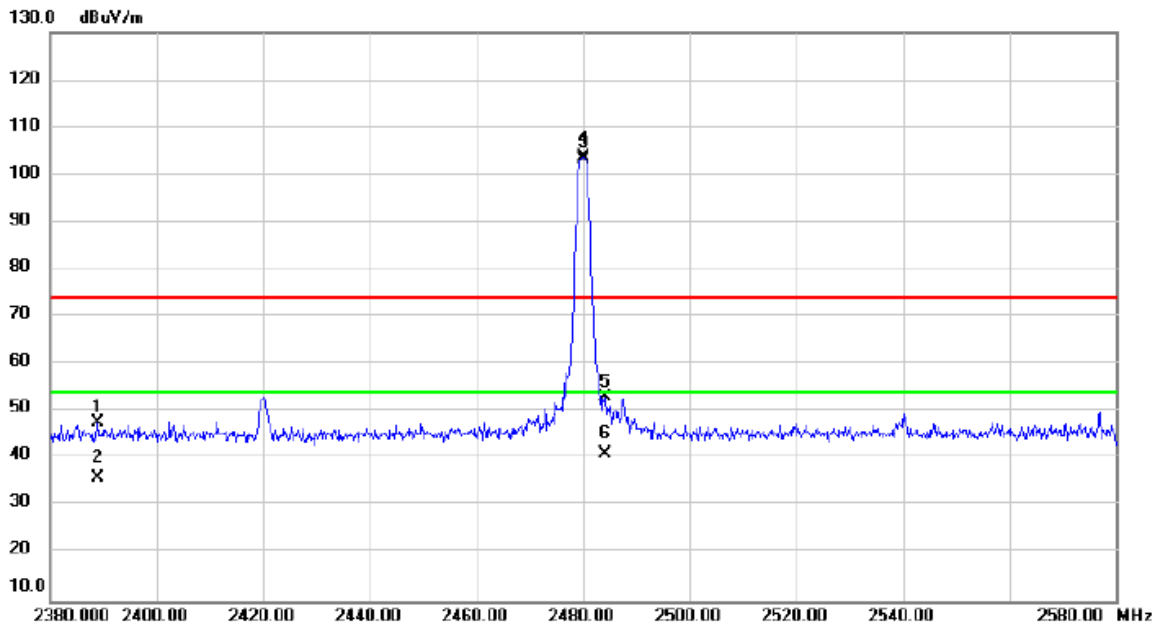

No.	Mk.	Freq. MHz	Reading Level dBuV	Correct Factor dB	Measure- ment dBuV/m	Limit dBuV/m	Over dB	Detector	Comment
1	X	2389.007	53.40	-5.77	47.63	74.00	-26.37	peak	
2	X	2389.007	41.65	-5.77	35.88	54.00	-18.12	AVG	
3	X	2480.000	109.49	-5.65	103.84	74.00	29.84	peak	No Limit
4	*	2480.000	108.92	-5.65	103.27	54.00	49.27	AVG	No Limit
5	X	2484.153	58.77	-5.65	53.12	74.00	-20.88	peak	
6	X	2484.153	46.56	-5.65	40.91	54.00	-13.09	AVG	

**REMARKS:**

- (1) Measurement Value = Reading Level + Correct Factor.
- (2) Margin Level = Measurement Value - Limit Value.



Test Mode	BLE 5.0 (1 Mbps)	Test Date	2022/11/25
Test Frequency	2480MHz	Polarization	Vertical
Temp	23°C	Hum.	59%

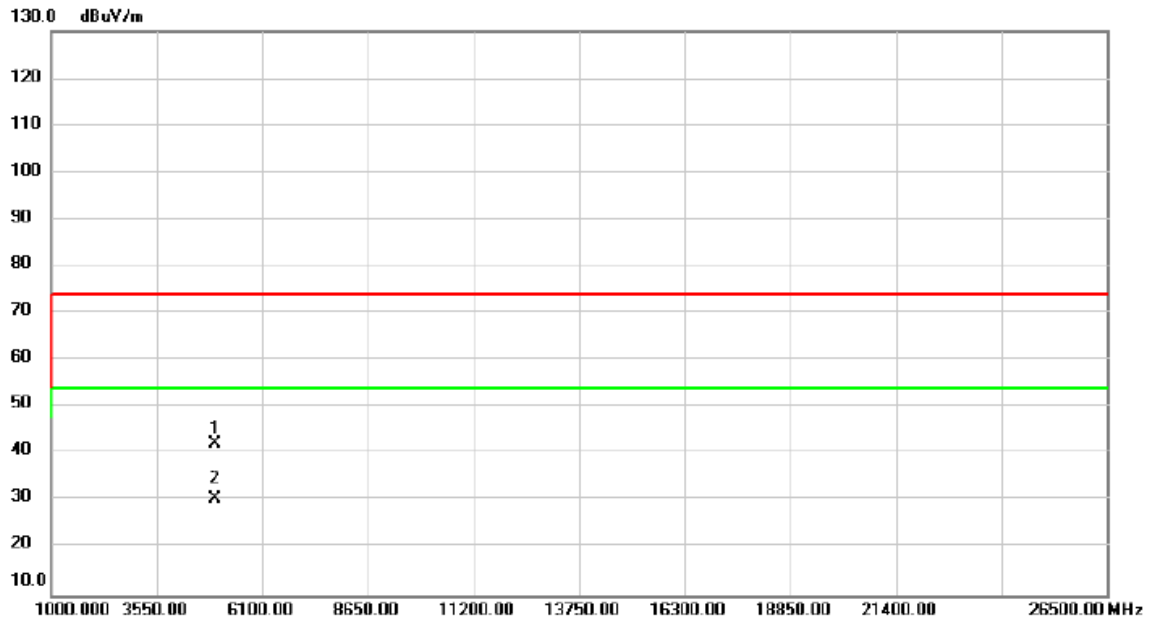

No.	Mk.	Freq. MHz	Reading Level dBuV	Correct Factor dB	Measure- ment dBuV/m	Limit dBuV/m	Over dB	Detector	Comment
1		4960.000	41.00	1.18	42.18	74.00	-31.82	peak	
2	*	4960.000	29.28	1.18	30.46	54.00	-23.54	AVG	

**REMARKS:**

- (1) Measurement Value = Reading Level + Correct Factor.
- (2) Margin Level = Measurement Value - Limit Value.

Test Mode	BLE 5.0 (1 Mbps)	Test Date	2022/11/25
Test Frequency	2480MHz	Polarization	Horizontal
Temp	23°C	Hum.	59%

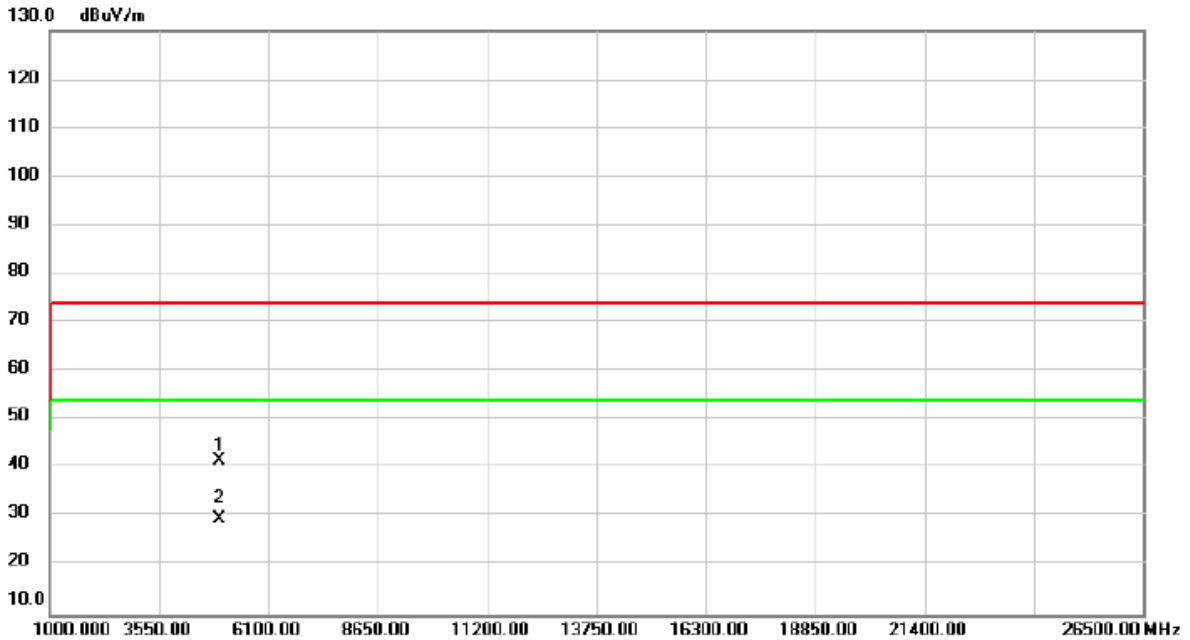

No.	Mk.	Freq. MHz	Reading Level dBuV	Correct Factor dB	Measure- ment dBuV/m	Limit dBuV/m	Over dB	Detector	Comment
1		4960.000	40.56	1.18	41.74	74.00	-32.26	peak	
2	*	4960.000	28.40	1.18	29.58	54.00	-24.42	AVG	

**REMARKS:**

- (1) Measurement Value = Reading Level + Correct Factor.
- (2) Margin Level = Measurement Value - Limit Value.

## APPENDIX D OUTPUT POWER

Test Mode :	1Mbps	Tested Date	2022/11/22
-------------	-------	-------------	------------

Frequency (MHz)	Output Power (dBm)	Output Power (W)	Max. Limit (dBm)	Max. Limit (W)	Test Result
2402	8.24	0.0067	30.00	1.0000	Pass
2440	8.46	0.0070	30.00	1.0000	Pass
2480	8.86	0.0077	30.00	1.0000	Pass

**End of Test Report**