

FCC Radio Test Report

FCC ID: RWO-RZ090484

This report concerns: **Class II Permissive Change**

Report No. : BTL-FCCP-3-2208C205
Equipment : Notebook PC
Model Name : RZ09-0484
Brand Name : RAZER
Applicant : Razer Inc.
Address : 9 Pasteur, Suite 100, Irvine, CA92618, USA.
Manufacturer : Razer Inc.
Address : 9 Pasteur, Suite 100, Irvine, CA92618, USA.

Radio Function : RLAN 5 GHz (U-NII 1, U-NII 2A, U-NII 2C, U-NII 3)

FCC Rule Part(s) : FCC CFR Title 47, Part 15, Subpart E (15.407)
Measurement : ANSI C63.10-2013
Procedure(s)

Date of Receipt : 2022/10/18
Date of Test : 2022/11/23~2022/12/16
Issued Date : 2022/12/22

The above equipment has been tested and found in compliance with the requirement of the above standards by BTL Inc.

Prepared by : Eric Lee
 Eric Lee, Engineer

Approved by : Jerry Chuang
 Jerry Chuang, Supervisor

**BTL Inc.**

No.18, Ln. 171, Sec. 2, Jiuzong Rd., Neihu Dist., Taipei City 114, Taiwan

Tel: +886-2-2657-3299 Fax: +886-2-2657-3331 Web: www.newbtl.com Service mail: btl_qa@newbtl.com

Declaration

BTL represents to the client that testing is done in accordance with standard procedures as applicable and that test instruments used has been calibrated with standards traceable to international standard(s) and/or national standard(s).

BTL's reports apply only to the specific samples tested under conditions. It is manufacture's responsibility to ensure that additional production units of this model are manufactured with the identical electrical and mechanical components. **BTL** shall have no liability for any declarations, inferences or generalizations drawn by the client or others from **BTL** issued reports.

This report is the confidential property of the client. As a mutual protection to the clients, the public and ourselves, the test report shall not be reproduced, except in full, without our written approval.

BTL's laboratory quality assurance procedures are in compliance with the **ISO/IEC 17025** requirements, and accredited by the conformity assessment authorities listed in this test report.

BTL is not responsible for the sampling stage, so the results only apply to the sample as received.

The information, data and test plan are provided by manufacturer which may affect the validity of results, so it is manufacturer's responsibility to ensure that the apparatus meets the essential requirements of applied standards and in all the possible configurations as representative of its intended use.

Limitation

For the use of the authority's logo is limited unless the Test Standard(s)/Scope(s)/Item(s) mentioned in this test report is (are) included in the conformity assessment authorities acceptance respective.

Please note that the measurement uncertainty is provided for informational purpose only and are not use in determining the Pass/Fail results.

CONTENTS

REVISION HISTORY	4
1 SUMMARY OF TEST RESULTS	5
1.1 TEST FACILITY	6
1.2 MEASUREMENT UNCERTAINTY	6
1.3 TEST ENVIRONMENT CONDITIONS	7
1.4 TABLE OF PARAMETERS OF TEST SOFTWARE SETTING	7
2 GENERAL INFORMATION	9
2.1 DESCRIPTION OF EUT	9
2.2 TEST MODES	13
2.3 BLOCK DIAGRAM SHOWING THE CONFIGURATION OF SYSTEM TESTED	14
2.4 SUPPORT UNITS	15
3 AC POWER LINE CONDUCTED EMISSIONS TEST	16
3.1 LIMIT	16
3.2 TEST PROCEDURE	16
3.3 DEVIATION FROM TEST STANDARD	16
3.4 TEST SETUP	17
3.5 TEST RESULT	17
4 RADIATED EMISSIONS TEST	18
4.1 LIMIT	18
4.2 TEST PROCEDURE	19
4.3 DEVIATION FROM TEST STANDARD	19
4.4 TEST SETUP	20
4.5 EUT OPERATING CONDITIONS	22
4.6 TEST RESULT – BELOW 30 MHZ	22
4.7 TEST RESULT – 30 MHZ TO 1 GHZ	22
4.8 TEST RESULT – ABOVE 1 GHZ	22
5 OUTPUT POWER TEST	23
5.1 LIMIT	23
5.2 TEST PROCEDURE	23
5.3 DEVIATION FROM TEST STANDARD	23
5.4 TEST SETUP	23
5.5 EUT OPERATING CONDITIONS	23
5.6 TEST RESULT	23
6 LIST OF MEASURING EQUIPMENTS	24
7 EUT TEST PHOTO	25
8 EUT PHOTOS	25
APPENDIX A AC POWER LINE CONDUCTED EMISSIONS	26
APPENDIX B RADIATED EMISSIONS - 30 MHZ TO 1 GHZ	31
APPENDIX C RADIATED EMISSIONS - ABOVE 1 GHZ	34
APPENDIX D CONDUCTED OUTPUT POWER	65

REVISION HISTORY

Report No.	Version	Description	Issued Date	Note
BTL-FCCP-4-2208C205	R00	Original Report.	2022/12/22	Valid

1 SUMMARY OF TEST RESULTS

Test procedures according to the technical standards.

Standard(s) Section	Description	Test Result	Judgement	Remark
15.207	AC Power Line Conducted Emissions	APPENDIX A	Pass	-----
15.205 15.209 15.407(b)	Radiated Emissions	APPENDIX B APPENDIX C	Pass	-----
15.407(a)	Bandwidth	-----	-----	-----
15.407(a)	Output Power	APPENDIX D	Pass	-----
15.407(a)	Power Spectral Density	-----	-----	-----
15.203	Antenna Requirement	-----	-----	-----
15.407(c)	Automatically Discontinue Transmission	-----	-----	NOTE (3)

NOTE:

- (1) "N/A" denotes test is not applicable in this Test Report.
- (2) The report format version is TP.1.1.1.
- (3) The EUT can detect the controlling signal of ACK message transmitting from remote device and verify whether it shall resend or discontinue transmission.
- (4) The antenna gain of EUT is smaller than that of the module. So in this report the worst cases of radiated spurious emissions and AC Power Line Conducted Emissions were evaluated and recorded. And evaluated the output power items and recorded in the report. For the test results of all other test items please refer to module test reports.

1.1 TEST FACILITY

The test facilities used to collect the test data in this report:

No. 72, Ln. 169, Sec. 2, Datong Rd., Xizhi Dist., New Taipei City 221, Taiwan

The test sites and facilities are covered under FCC RN: 674415 and DN: TW0659.

C06 CB21 CB22

No. 68-1, Ln. 169, Sec. 2, Datong Rd., Xizhi Dist., New Taipei City 221, Taiwan

The test sites and facilities are covered under FCC RN: 674415 and DN: TW0659.

C05 CB08 CB11 CB15 CB16
 SR10

1.2 MEASUREMENT UNCERTAINTY

The reported uncertainty of measurement $y \pm U$, where expanded uncertainty U is based on a standard uncertainty multiplied by a coverage factor of $k = 2$, providing a level of confidence of approximately **95 %**. The measurement instrumentation uncertainty considerations contained in CISPR 16-4-2. The BTL measurement uncertainty is less than the CISPR 16-4-2 U_{cispr} requirement.

A. AC power line conducted emissions test:

Test Site	Method	Measurement Frequency Range	U (dB)
C05	CISPR	150 kHz ~ 30MHz	3.44

B. Radiated emissions test:

Test Site	Measurement Frequency Range	U,(dB)
CB15	0.03 GHz ~ 0.2 GHz	4.17
	0.2 GHz ~ 1 GHz	4.72
	1 GHz ~ 6 GHz	5.21
	6 GHz ~ 18 GHz	5.51
	18 GHz ~ 26 GHz	3.69
	26 GHz ~ 40 GHz	4.23

C. Conducted test:

Test Item	U,(dB)
Output power	0.3669

NOTE:

Unless specifically mentioned, the uncertainty of measurement has not been taken into account to declare the compliance or non-compliance to the specification.

1.3 TEST ENVIRONMENT CONDITIONS

Test Item	Environment Condition	Test Voltage	Tested by
AC Power Line Conducted Emissions	23°C, 58%	AC 120 V	Jay Tien
Radiated emissions below 1 GHz	23°C, 59%	AC 120 V	Mark Luo
Radiated emissions above 1 GHz	23°C, 59%	AC 120 V	Mark Luo
Output Power	22.6°C, 51%	AC 120 V	Angela Wang

1.4 TABLE OF PARAMETERS OF TEST SOFTWARE SETTING

UNII-1				
Test Software	DRTU V02999.22.180.0			
Mode	5180 MHz	5200 MHz	5240 MHz	Data Rate
IEEE 802.11a_Main Ant.	18	20.375	20.375	6 Mbps
IEEE 802.11a_Aux Ant.	19	20.375	20.375	6 Mbps
IEEE 802.11n (HT20)	16.875	17.375	17.5	HT8
IEEE 802.11ax (HE20)	17.25	17.25	17.25	HE0
Mode	5190 MHz	5230 MHz		Data Rate
IEEE 802.11n (HT40)	15.875	17		HT8
IEEE 802.11ax (HE40)	14.75	16.75		HE0
Mode	5210 MHz			Data Rate
IEEE 802.11ac (VHT80)	16			VHT0
IEEE 802.11ax (HE80)	15.875			HE0

UNII-2A				
Test Software	DRTU V02999.22.180.0			
Mode	5260 MHz	5300 MHz	5320 MHz	Data Rate
IEEE 802.11a_Main Ant.	20.75	20.75	18.75	6 Mbps
IEEE 802.11a_Aux Ant.	20.875	20.875	20.125	6 Mbps
IEEE 802.11n (HT20)	18.125	18.125	17.125	HT8
IEEE 802.11ax (HE20)	18.5	18.5	16.75	HE0
Mode	5270 MHz	5310 MHz		Data Rate
IEEE 802.11n (HT40)	17.25	16		HT8
IEEE 802.11ax (HE40)	19.75	15		HE0
Mode	5290 MHz			Data Rate
IEEE 802.11ac (VHT80)	16			VHT0
IEEE 802.11ax (HE80)	15.5			HE0

UNII-1+ UNII-2A				
Test Software	DRTU V02999.22.180.0			
Mode	5250 MHz			Data Rate
IEEE 802.11ac (VHT160)	11.875			VHT0
IEEE 802.11ax (HE160)	11.75			HE0

UNII-2C				
Test Software	DRTU V02999.22.180.0			
Mode	5500 MHz	5580 MHz	5700 MHz	Data Rate
IEEE 802.11a_Main Ant.	20.5	21	20.25	6 Mbps
IEEE 802.11a_Aux Ant.	20.25	21	20.25	6 Mbps
IEEE 802.11n (HT20)	18.625	18.625	18.625	HT8
IEEE 802.11ax (HE20)	18.5	18.75	18.75	HE0
Mode	5510 MHz	5550 MHz	5670 MHz	Data Rate
IEEE 802.11n (HT40)	17	20.125	19.5	HT8
IEEE 802.11ax (HE40)	17	20.25	20	HE0
Mode	5530 MHz	5610 MHz		Data Rate
IEEE 802.11ac (VHT80)	17	20		VHT0
IEEE 802.11ax (HE80)	18.875	20		HE0
Mode	5570 MHz			Data Rate
IEEE 802.11ac (VHT160)	12.875			VHT0
IEEE 802.11ax (HE160)	13.75			HE0

UNII-3				
Test Software	DRTU V02999.22.180.0			
Mode	5745 MHz	5785 MHz	5825 MHz	Data Rate
IEEE 802.11a_Main Ant.	21.5	21.25	21.75	6 Mbps
IEEE 802.11a_Aux Ant.	21.25	21	21.25	6 Mbps
IEEE 802.11n (HT20)	20.625	20.875	21	HT8
IEEE 802.11ax (HE20)	20.875	20.75	21	HE0
Mode	5755 MHz	5795 MHz		Data Rate
IEEE 802.11n (HT40)	19.75	20.25		HT8
IEEE 802.11ax (HE40)	19.75	20.625		HE0
Mode	5775 MHz			Data Rate
IEEE 802.11ac (VHT80)	17.875			VHT0
IEEE 802.11ax (HE80)	18			HE0

2 GENERAL INFORMATION

2.1 DESCRIPTION OF EUT

Equipment	Notebook PC
Model Name	RAZER
Brand Name	RZ09-0484
Model Difference	N/A
Power Source	1# DC voltage supplied from AC adapter. 1)Model: RC30-0484 2)Model: RC30-042 2# Supplied from battery. Model: RC30-0484
Power Rating	1# 1) I/P: 100-240V~ 4.5A 50/60Hz O/P: 19.5V===16.92A TOTAL 330W 2) I/P: 100-240V~ 4A MAX 50/60Hz O/P: 19.5V===14.36A TOTAL 280.0W 2# DC 15.4V, 5955mAh, 91.7Wh
Products Covered	2* Power Adapter 1* AC Cable
Operation Band	UNII-1: 5150 MHz to 5250 MHz UNII-2A: 5250 MHz to 5350 MHz UNII-2C: 5470 MHz to 5725 MHz UNII-3: 5725 MHz to 5850 MHz
Operation Frequency	UNII-1: 5180 MHz to 5240 MHz UNII-2A: 5260 MHz to 5320 MHz UNII-2C: 5500 MHz to 5700 MHz UNII-3: 5745 MHz to 5825 MHz
Modulation Technology	IEEE 802.11a/n/ac: OFDM IEEE 802.11ax: OFDMA
Transfer Rate	IEEE 802.11a: 54/48/36/24/18/12/9/6 Mbps IEEE 802.11n: Up to 300 Mbps IEEE 802.11ac: Up to 1733.4 Mbps IEEE 802.11ax: Up to 2402 Mbps
Output Power Max. for UNII-1	For Main: IEEE 802.11a: 20.16 dBm (0.1038 W) For AUX: IEEE 802.11a: 20.21 dBm (0.1050 W) For MIMO: IEEE 802.11n (HT20): 20.24 dBm (0.1057 W) IEEE 802.11n (HT40): 20.04 dBm (0.1009 W) IEEE 802.11ac (VHT80): 19.21 dBm (0.0833 W) IEEE 802.11ax (HE20): 20.26 dBm (0.1062 W) IEEE 802.11ax (HE40): 19.98 dBm (0.0995 W) IEEE 802.11ax (HE80): 19.08 dBm (0.0809 W)
Output Power Max. for UNII-2A	For Main: IEEE 802.11a: 20.62 dBm (0.1153 W) For AUX: IEEE 802.11a: 20.78 dBm (0.1197 W) For MIMO: IEEE 802.11n (HT20): 21.16 dBm (0.1305 W) IEEE 802.11n (HT40): 20.54 dBm (0.1131 W) IEEE 802.11ac (VHT80): 19.26 dBm (0.0843 W) IEEE 802.11ax (HE20): 21.46 dBm (0.1401 W) IEEE 802.11ax (HE40): 22.87 dBm (0.1936 W) IEEE 802.11ax (HE80): 18.69 dBm (0.0740 W)
Output Power Max. for UNII-1+ UNII-2A	IEEE 802.11ac (VHT160): 15.82 dBm (0.0382 W) IEEE 802.11ax (HE160): 15.90 dBm (0.0389 W)

Output Power Max. for UNII-2C	For Main: IEEE 802.11a: 20.75 dBm (0.1189 W) For AUX: IEEE 802.11a: 20.70 dBm (0.1175 W) For MIMO: IEEE 802.11n (HT20): 21.33 dBm (0.1357 W) IEEE 802.11n (HT40): 23.68 dBm (0.2335 W) IEEE 802.11ac (VHT80): 23.27 dBm (0.2122 W) IEEE 802.11ac (VHT160): 16.93 dBm (0.0493 W) IEEE 802.11ax (HE20): 21.65 dBm (0.1461 W) IEEE 802.11ax (HE40): 23.58 dBm (0.2279 W) IEEE 802.11ax (HE80): 23.13 dBm (0.2055 W) IEEE 802.11ax (HE160): 17.85 dBm (0.0610 W)
Output Power Max. for UNII-3	For Main: IEEE 802.11a: 20.84 dBm (0.1213 W) For AUX: IEEE 802.11a: 20.91 dBm (0.1233 W) For MIMO: IEEE 802.11n (HT20): 23.72 dBm (0.2356 W) IEEE 802.11n (HT40): 23.67 dBm (0.2330 W) IEEE 802.11ac (VHT80): 20.98 dBm (0.1252 W) IEEE 802.11ax (HE20): 23.83 dBm (0.2414 W) IEEE 802.11ax (HE40): 23.87 dBm (0.2439 W) IEEE 802.11ax (HE80): 21.03 dBm (0.1267 W)
Test Model	RZ09-0484
Sample Status	Engineering Sample
EUT Modification(s)	N/A

NOTE:

(1) The above EUT information is declared by manufacturer and for more detailed features description, please refers to the manufacturer's specifications or user's manual.

(2) Channel List:

IEEE 802.11a IEEE 802.11n(HT20) IEEE 802.11ac(VHT20) IEEE 802.11ax(HE20)		IEEE 802.11n(HT40) IEEE 802.11ac(VHT40) IEEE 802.11ax(HE40)		IEEE 802.11ac(VHT80) IEEE 802.11ax(HE80)	
UNII-1		UNII-1		UNII-1	
Channel	Frequency (MHz)	Channel	Frequency (MHz)	Channel	Frequency (MHz)
36	5180	38	5190	42	5210
40	5200	46	5230		
44	5220				
48	5240				

IEEE 802.11a IEEE 802.11n(HT20) IEEE 802.11ac(VHT20) IEEE 802.11ax(HE20)		IEEE 802.11n(HT40) IEEE 802.11ac(VHT40) IEEE 802.11ax(HE40)		IEEE 802.11ac(VHT80) IEEE 802.11ax(HE80)	
UNII-2A		UNII-2A		UNII-2A	
Channel	Frequency (MHz)	Channel	Frequency (MHz)	Channel	Frequency (MHz)
52	5260	54	5270	58	5290
56	5280	62	5310		
60	5300				
64	5320				

IEEE 802.11ac(VHT160) IEEE 802.11ax(HE160)	
UNII-1+ UNII-2A	
Channel	Frequency (MHz)
50	5250

IEEE 802.11a IEEE 802.11n(HT20) IEEE 802.11ac(VHT20) IEEE 802.11ax(HE20)		IEEE 802.11n(HT40) IEEE 802.11ac(VHT40) IEEE 802.11ax(HE40)		IEEE 802.11ac(VHT80) IEEE 802.11ax(HE80)	
UNII-2C		UNII-2C		UNII-2C	
Channel	Frequency (MHz)	Channel	Frequency (MHz)	Channel	Frequency (MHz)
100	5500	102	5510	106	5530
104	5520	110	5550	122	5610
108	5540	118	5590		
112	5560	126	5630		
116	5580	134	5670		
120	5600				
124	5620				
128	5640				
132	5660				
136	5680				
140	5700				

IEEE 802.11ac(VHT160) IEEE 802.11ax(HE160)	
UNII-2C	
Channel	Frequency (MHz)
114	5570

IEEE 802.11a IEEE 802.11n(HT20) IEEE 802.11ac(VHT20) IEEE 802.11ax(HE20)		IEEE 802.11n(HT40) IEEE 802.11ac(VHT40) IEEE 802.11ax(HE40)		IEEE 802.11ac(VHT80) IEEE 802.11ax(HE80)	
UNII-3		UNII-3		UNII-3	
Channel	Frequency (MHz)	Channel	Frequency (MHz)	Channel	Frequency (MHz)
149	5745	151	5755	155	5775
153	5765	159	5795		
157	5785				
161	5805				
165	5825				

(3) Table for Filed Antenna:

Ant.	Manufacturer	P/N	Type	Connector	Gain (dBi)
1	Amphenol Taiwan Corporation	BY5963-16-001-C	PIFA	N/A	3.56
2		BY5963-16-001-C	PIFA	N/A	3.44

Note:

- 1) The EUT incorporates a MIMO function. Physically, the EUT provides two completed transmitters and receivers (2T2R).
- 2) Ant.1 refers to main antenna, Ant.2 refers to aux antenna.
- 3) The AUX antenna connector of the module connected to the MAIN antenna of the EUT and the MAIN antenna connector of the module connected to the AUX antenna of the EUT.
- 4) The above Antenna information are derived from the antenna data sheet provided by manufacturer and for more detailed features description, please refer to the manufacturer's specifications, the laboratory shall not be held responsible.

2.2 TEST MODES

Test Items	Test mode	Channel	Note
AC power line conducted emissions	Normal/Idle	-	-
Transmitter Radiated Emissions (below 1GHz)	TX Mode_IEEE 802.11a	149	-
Transmitter Radiated Emissions (above 1GHz)	TX Mode_IEEE 802.11a	40/56/140/149	Bandedge
	TX Mode_IEEE 802.11ac (VHT80)	42/58/122/155	
	TX Mode_IEEE 802.11ax (HE160)	50/114	
	TX Mode_IEEE 802.11a	48/56/120/149	Harmonic
	TX Mode_IEEE 802.11ac (VHT80)	42/58/122/155	
	TX Mode_IEEE 802.11ax (HE160)	50/114	
Output Power	TX Mode_IEEE 802.11a	36/40/48 52/60/64	-
	TX Mode_IEEE 802.11n (HT20) TX Mode_IEEE 802.11ax (HE20)	100/116/140 149/157/165	
	TX Mode_IEEE 802.11n (HT40) TX Mode_IEEE 802.11ax (HE40)	38/46/ 54/62 102/110/134 151/159	
	TX Mode_IEEE 802.11ac (VHT80) TX Mode_IEEE 802.11ax (HE80)	42/58 106/122/155	
	TX Mode_IEEE 802.11ac (VHT160) TX Mode_IEEE 802.11ax (HE160)	50/114	

NOTE:

- (1) For radiated emission band edge test, both Vertical and Horizontal are evaluated, but only the worst case (Vertical) is recorded.
- (2) This Notebook PC has two mainboards with two adapters. Both mainboard APF22003_MB (with adapter RC09-0484) and mainboard APF22003_MB2 (with adapter RC30-042) had been pre-tested and in this report only recorded the worst case.

2.3 BLOCK DIAGRAM SHOWING THE CONFIGURATION OF SYSTEM TESTED

Equipment letters and Cable numbers refer to item numbers described in the tables of clause 2.4.

AC power line conducted emissions

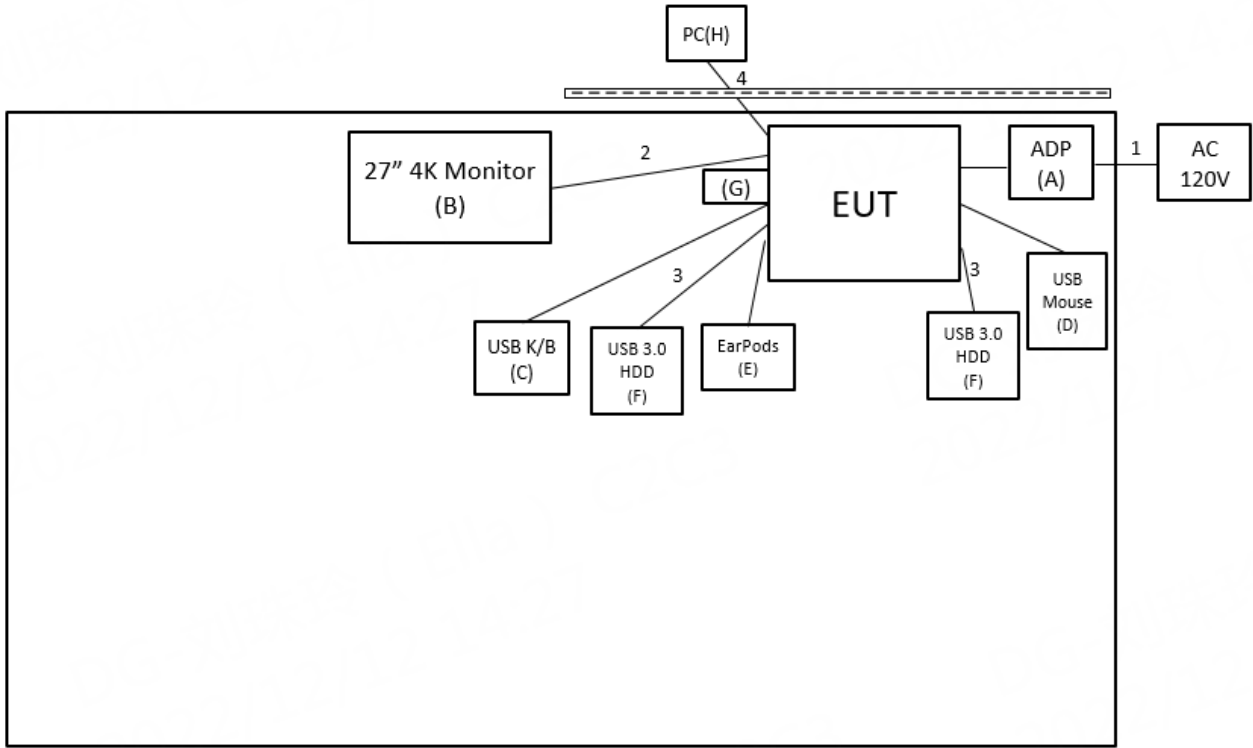

Radiated Emissions

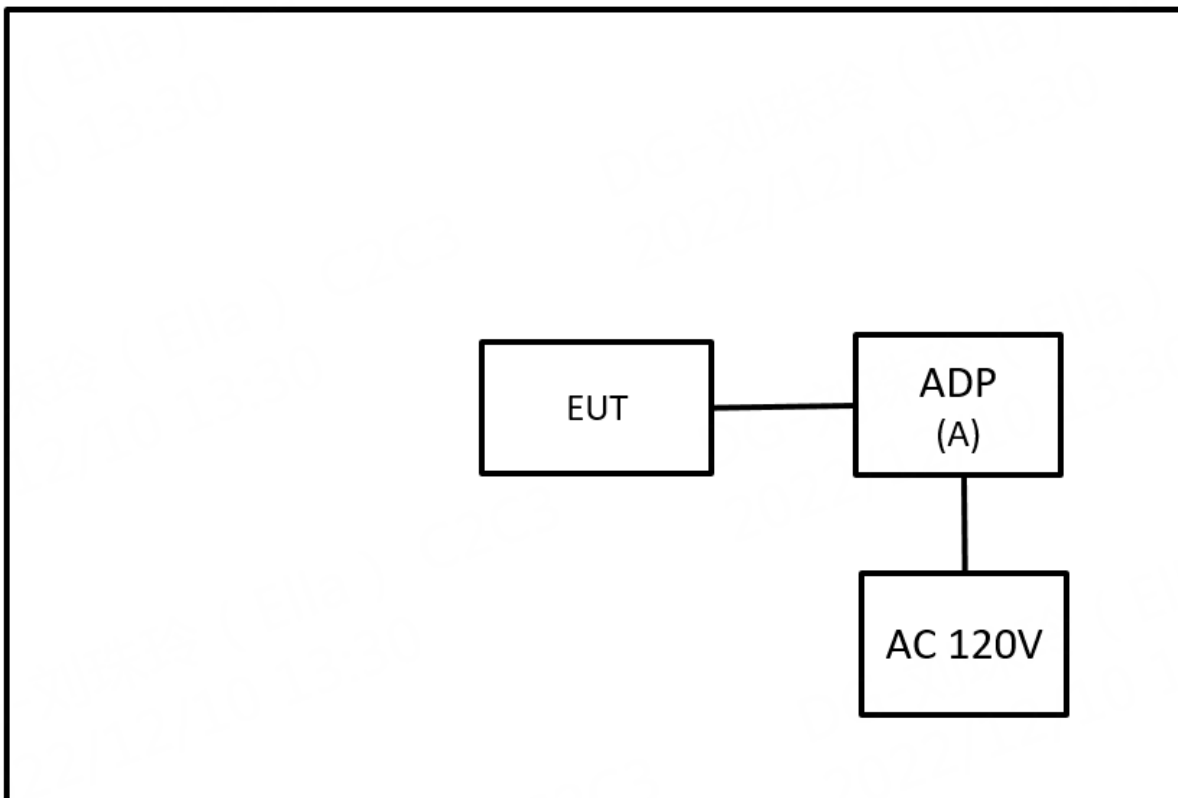

2.4 SUPPORT UNITS

AC power line conducted emissions

Item	Equipment	Brand	Model No.	Series No.	Remarks
A	ADP	Razer	RC30-0484	N/A	Supplied by test requester
B	27" 4K Monitor	DELL	U2720Q	CN-083VF-WSL0 0-0B7-332L	Furnished by test lab.
C	USB K/B	DELL	KB216t	CN-0W33XP-L03 00-797-05TY-A03	Furnished by test lab.
D	USB Mouse	DELL	MOCZUL	CN-049TWY-PRC 00-79E-01HA	Furnished by test lab.
E	EarPods	Apple	A1472	N/A	Furnished by test lab.
F	USB 3.0 HDD	WD	WDBC3C0010B SL-0B	WX81A88ALJUC	Furnished by test lab.
G	USB Dongle	Kingston	DataTraveler Exodia	N/A	Furnished by test lab.
H	PC	DELL	OptiPlex 790 MT	64NJVBX	Furnished by test lab.

Radiated Emissions

Item	Shielded	Ferrite Core	Length	Cable Type	Remarks
1	NO	NO	1.2m	Power Cable	Furnished by test lab.
2	NO	NO	1.7m	HDMI Cable	Furnished by test lab.
3	NO	NO	18cm	TypeC to TypeC Cable	Furnished by test lab.
4	NO	NO	2m	RJ-45 Cable	Furnished by test lab.

3 AC POWER LINE CONDUCTED EMISSIONS TEST

3.1 LIMIT

Frequency (MHz)	Limit (dB μ V)	
	Quasi-peak	Average
0.15 - 0.5	66 - 56 *	56 - 46 *
0.50 - 5.0	56	46
5.0 - 30.0	60	50

NOTE:

- (1) The tighter limit applies at the band edges.
- (2) The limit of " * " marked band means the limitation decreases linearly with the logarithm of the frequency in the range.
- (3) The test result calculated as following:
 Measurement Value = Reading Level + Correct Factor
 Correct Factor = Insertion Loss + Cable Loss + Attenuator Factor (if use)
 Margin Level = Measurement Value – Limit Value
 Calculation example:

Reading Level		Correct Factor		Measurement Value
38.22	+	3.45	=	41.67

Measurement Value		Limit Value		Margin Level
41.67	-	60	=	-18.33

The following table is the setting of the receiver.

Receiver Parameter	Setting
Attenuation	10 dB
Start Frequency	0.15 MHz
Stop Frequency	30 MHz
IF Bandwidth	9 KHz

3.2 TEST PROCEDURE

- a. The EUT was placed 0.8 m above the horizontal ground plane with the EUT being connected to the power mains through a line impedance stabilization network (LISN).
 All other support equipment were powered from an additional LISN(s).
 The LISN provides 50 Ohm/50uH of impedance for the measuring instrument.
- b. Interconnecting cables that hang closer than 40 cm to the ground plane shall be folded back and forth in the center forming a bundle to keep the cable above 40 cm.
- c. Excess I/O cables that are not connected to a peripheral shall be bundled in the center.
 The end of the cable will be terminated, using the correct terminating impedance.
 The overall length shall not exceed 1 m.
- d. The LISN is spaced at least 80 cm from the nearest part of the EUT chassis.
- e. For the actual test configuration, please refer to the related Item - EUT TEST PHOTO.

NOTE:

- (1) In the results, each reading is marked as Peak, QP or AVG per the detector used.
 BW=9 kHz (6 dB Bandwidth)
- (2) All readings are Peak unless otherwise stated QP or AVG in column of Note. Both the QP and the AVG readings must be less than the limit for compliance.

3.3 DEVIATION FROM TEST STANDARD

No deviation.

3.4 TEST SETUP

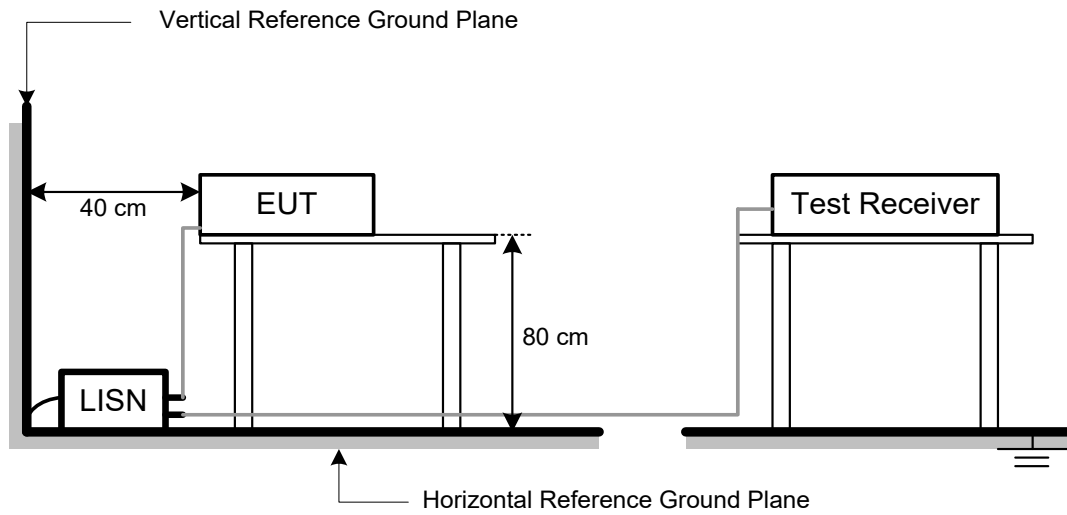

3.5 TEST RESULT

Please refer to the APPENDIX A.

4 RADIATED EMISSIONS TEST

4.1 LIMIT

In case the emission fall within the restricted band specified on 15.205, then the 15.209 limit in the table below has to be followed.

LIMITS OF RADIATED EMISSIONS MEASUREMENT (9 kHz to 1000 MHz)

Frequency (MHz)	Field Strength (microvolts/meter)	Measurement Distance (meters)
0.009~0.490	2400/F(KHz)	300
0.490~1.705	24000/F(KHz)	30
1.705~30.0	30	30
30~88	100	3
88~216	150	3
216~960	200	3
960~1000	500	3

LIMITS OF UNWANTED EMISSION OUT OF THE RESTRICTED BANDS

Frequency (MHz)	EIRP Limit (dBm)	Equivalent Field Strength at 3m (dBμV/m)
5150-5250	-27	68.3
5250-5350	-27	68.3
5470-5725	-27	68.3
5725-5850	-27 (NOTE 2)	68.3
	10 (NOTE 2)	105.3
	15.6 (NOTE 2)	110.9
	27 (NOTE 2)	122.3

NOTE:

(1) The following formula is used to convert the equipment isotropic radiated power (eirp) to field strength:

$$E = \frac{1000000\sqrt{30P}}{3} \mu\text{V/m, where P is the eirp (Watts)}$$

(2) According to FCC 16-24, all emissions shall be limited to a level of -27 dBm/MHz at 75 MHz or more above or below the band edge increasing linearly to 10 dBm/MHz at 25 MHz above or below the band edge, and from 25 MHz above or below the band edge increasing linearly to a level of 15.6 dBm/MHz at 5 MHz above or below the band edge, and from 5 MHz above or below the band edge increasing linearly to a level of 27 dBm/MHz at the band edge.

(3) The test result calculated as following:

Measurement Value = Reading Level + Correct Factor

Correct Factor = Antenna Factor + Cable Loss - Amplifier Gain(if use)

Margin Level = Measurement Value - Limit Value

Calculation example:

Reading Level		Correct Factor		Measurement Value
36.23	+	-11.97	=	24.26

Measurement Value		Limit Value		Margin Level
24.26	-	40	=	-15.74

Spectrum Parameter	Setting
Attenuation	Auto
Start Frequency	1000 MHz
Stop Frequency	10th carrier harmonic
RBW / VBW (Emission in restricted band)	1MHz / 3MHz for Peak, 1MHz / 1/T for Average

Spectrum Parameter	Setting
Attenuation	Auto
Start ~ Stop Frequency	9KHz~90KHz for PK/AVG detector
Start ~ Stop Frequency	90KHz~110KHz for QP detector
Start ~ Stop Frequency	110KHz~490KHz for PK/AVG detector
Start ~ Stop Frequency	490KHz~30MHz for QP detector
Start ~ Stop Frequency	30MHz~1000MHz for QP detector

4.2 TEST PROCEDURE

- a. The measuring distance of 3 m shall be used for measurements. The EUT was placed on the top of a rotating table 0.8 meter above the ground at a 3 meter semi-anechoic chamber. The table was rotated 360 degrees to determine the position of the highest radiation.(below 1GHz)
- b. The measuring distance of 3 m shall be used for measurements. The EUT was placed on the top of a rotating table 1.5 meter above the ground at a 3 meter semi-anechoic chamber. The table was rotated 360 degrees to determine the position of the highest radiation.(above 1GHz)
- c. The height of the equipment or of the substitution antenna shall be 0.8 m or 1.5 m, the height of the test antenna shall vary between 1 m to 4 m. Both horizontal and vertical polarizations of the antenna are set to make the measurement.
- d. For each suspected emission, the EUT was arranged to its worst case and then the antenna was tuned to heights find the maximum reading (used Bore sight function).
- e. The receiver system was set to peak and average detect function and specified bandwidth with maximum hold mode when the test frequency is above 1GHz.
- f. The initial step in collecting radiated emission data is a receiver peak detector mode pre-scanning the measurement frequency range. Significant peaks are then marked and then Quasi Peak detector mode re-measured.
- g. All readings are Peak unless otherwise stated QP in column of Note. Peak denotes that the Peak reading compliance with the QP Limits and then QP Mode measurement didn't perform. (below 1GHz)
- h. All readings are Peak Mode value unless otherwise stated AVG in column of Note. If the Peak Mode Measured value compliance with the Peak Limits and lower than AVG Limits, the EUT shall be deemed to meet both Peak & AVG Limits and then only Peak Mode was measured, but AVG Mode didn't perform. (above 1GHz)
- i. For the actual test configuration, please refer to the related Item – EUT TEST PHOTO.

4.3 DEVIATION FROM TEST STANDARD

No deviation.

4.4 TEST SETUP

9 kHz to 30 MHz

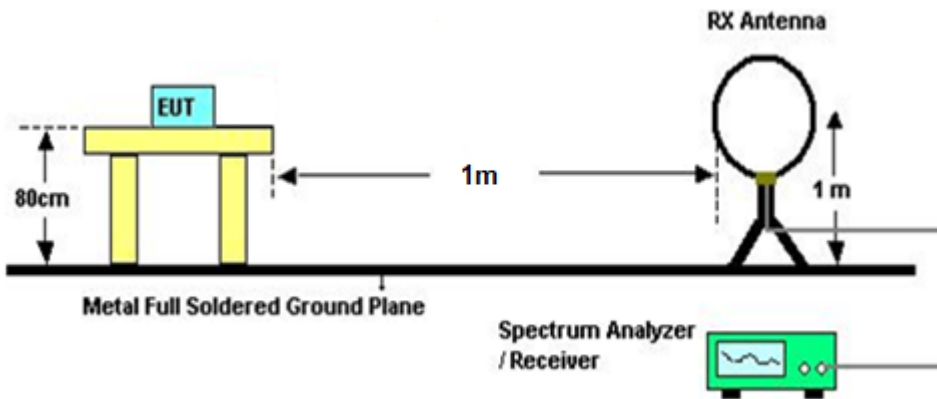

30 MHz to 1 GHz

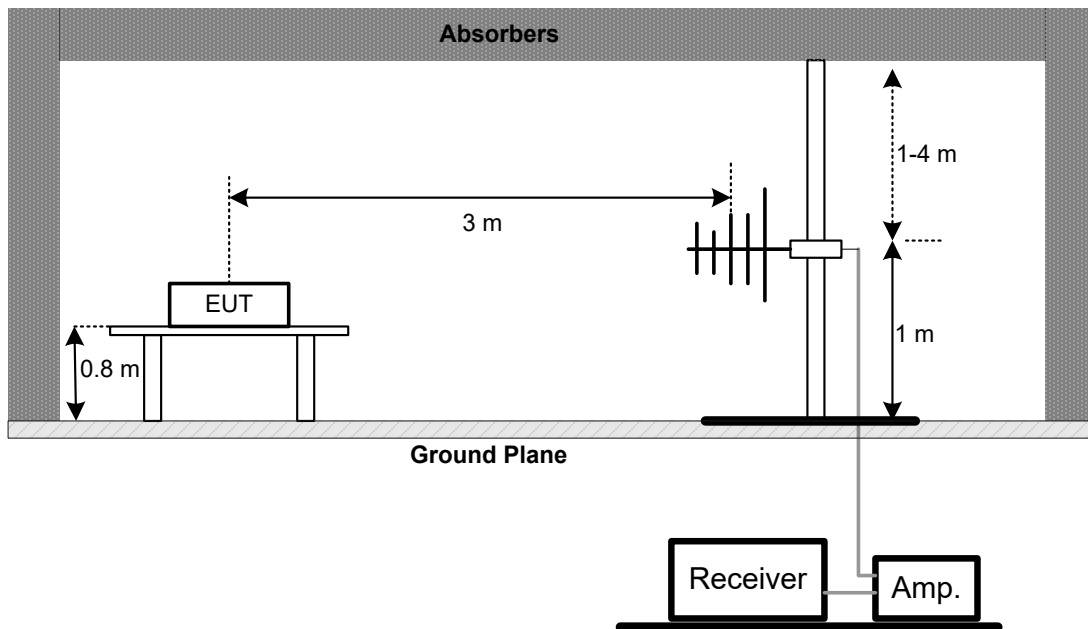

Above 1 GHz

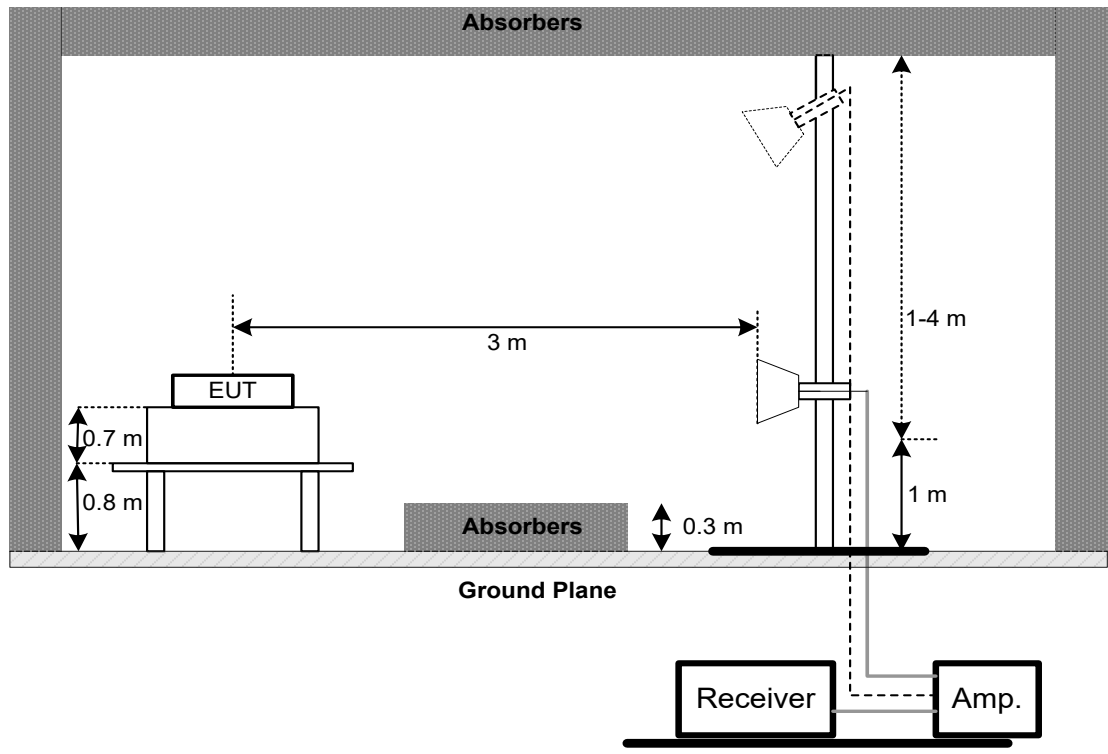

4.5 EUT OPERATING CONDITIONS

The EUT was programmed to be in continuously transmitting mode.

4.6 TEST RESULT – BELOW 30 MHZ

There were no emissions found below 30 MHz within 20 dB of the limit.

4.7 TEST RESULT – 30 MHZ TO 1 GHZ

Please refer to the APPENDIX B.

4.8 TEST RESULT – ABOVE 1 GHZ

Please refer to the APPENDIX C.

NOTE:

- (1) No limit: This is fundamental signal, the judgment is not applicable.
For fundamental signal judgment was referred to Peak output test.

5 OUTPUT POWER TEST

5.1 LIMIT

FCC Part15, Subpart E (15.407)			
Section	Test Item	Limit	Frequency Range (MHz)
15.407(a)	Maximum Output Power	Fixed:1 Watt (30 dBm) Mobile and portable: 250 mW (24 dBm)	5150-5250
		250 mW or 11 dBm + 10 log B, where B is the 26 dB emission bandwidth in megahertz	5250-5350
			5470-5725
		1 Watt (30dBm)	5725-5850

Note: The maximum e.i.r.p at any elevation angle above 30 degrees as measured from the horizon must not exceed 125 mW(21 dBm).

5.2 TEST PROCEDURE

- a. The EUT was directly connected to the power meter and antenna output port as show in the block diagram below.
- b. The maximum peak conducted output power was performed in accordance with method of clause E. 3. a) FCC KDB 789033 D02 General UNII Test Procedures New Rules v02r01.
 - a)Method PM (Measurement using an RF average power meter):
 - (i) Measurements may be performed using a wideband RF power meter with a thermocouple detector or equivalent if all of the following conditions are satisfied
The EUT is configured to transmit continuously or to transmit with a constant duty cycle.
At all times when the EUT is transmitting, it must be transmitting at its maximum power control level.
The integration period of the power meter exceeds the repetition period of the transmitted signal by at least a factor of five.
 - (ii) If the transmitter does not transmit continuously, measure the duty cycle, x, of the transmitter output signal as described in II.B.
 - (iii) Measure the average power of the transmitter. This measurement is an average over both the on and off periods of the transmitter.
 - (iv) Adjust the measurement in dBm by adding 10 log (1/x) where x is the duty cycle (e.g., 10 log (1/0.25) if the duty cycle is 25%).

5.3 DEVIATION FROM TEST STANDARD

No deviation.

5.4 TEST SETUP

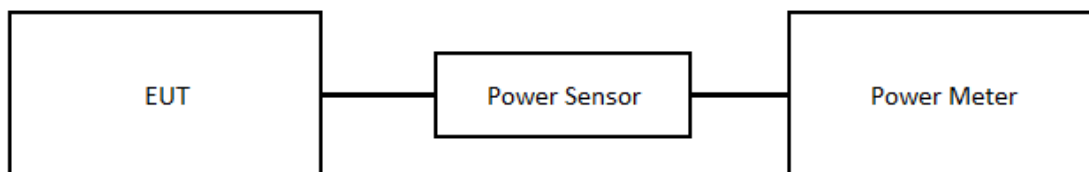

5.5 EUT OPERATING CONDITIONS

The EUT was programmed to be in continuously transmitting mode.

5.6 TEST RESULT

Please refer to the APPENDIX D.

6 LIST OF MEASURING EQUIPMENTS

AC Power Line Conducted Emissions						
Item	Kind of Equipment	Manufacturer	Type No.	Serial No.	Calibrated Date	Calibrated Until
1	TWO-LINE V-NETWORK	R&S	ENV216	101051	2022/6/15	2023/6/14
2	Test Cable	EMCI	EMCRG58-BM-B M-9000	210501	2022/5/2	2023/5/1
3	EMI Test Receiver	R&S	ESR 7	101433	2022/11/16	2023/11/15
4	Measurement Software	EZ	EZ_EMCI (Version NB-03A1-01)	N/A	N/A	N/A

Radiated Emissions						
Item	Kind of Equipment	Manufacturer	Type No.	Serial No.	Calibrated Date	Calibrated Until
1	Preamplifier	EMCI	EMC330N	980850	2022/9/19	2023/9/18
2	Preamplifier	EMCI	EMC118A45SE	980819	2022/3/8	2023/3/7
3	Preamplifier	EMCI	EMC184045SE	980882	2022/2/9	2023/2/8
4	Preamplifier	EMCI	EMC001340	980579	2022/9/30	2023/9/29
5	Test Cable	EMCI	EMC104-SM-SM-1000	220319	2022/3/15	2023/3/14
6	Test Cable	EMCI	EMC104-SM-SM-3000	220322	2022/3/15	2023/3/14
7	Test Cable	EMCI	EMC104-SM-SM-7000	220324	2022/3/15	2023/3/14
8	EXA Signal Analyzer	keysight	N9020B	MY57120120	2022/3/7	2023/3/6
9	Loop Ant	Electro-Metrics	EMCI-LPA600	291	2022/9/19	2023/9/18
10	Horn Antenna	RFSPIN	DRH18-E	211202A18EN	2022/5/18	2023/5/17
11	Horn Ant	Schwarzbeck	BBHA 9170D	1136	2022/5/18	2023/5/17
12	Log-bicon Antenna	Schwarzbeck	VULB9168	1369	2022/5/20	2023/5/19
13	6dB Attenuator	EMCI	EMCI-N-6-06	AT-N0625	2022/5/20	2023/5/19
14	Test Cable	EMCI	EMC101G-KM-K M-3000	220329	2022/3/15	2023/3/14
15	Test Cable	EMCI	EMC102-KM-KM-1000	220327	2022/3/15	2023/3/14
16	Measurement Software	EZ	EZ_EMCI (Version NB-03A1-01)	N/A	N/A	N/A

Output Power						
Item	Kind of Equipment	Manufacturer	Type No.	Serial No.	Calibrated Date	Calibrated Until
1	Power Meter	Keysight	8990B	MY51000517	2022/3/18	2023/3/17
2	Power Sensor	Keysight	N1923A	MY58310005	2022/3/18	2023/3/17

Remark: "N/A" denotes no model name, no serial no. or no calibration specified.
All calibration period of equipment list is one year.

7 EUT TEST PHOTO

Please refer to document Appendix No.: TP-2208C205-1 (APPENDIX-TEST PHOTOS).

8 EUT PHOTOS

Please refer to document Appendix No.: EP-2208C205-1 (APPENDIX-EUT PHOTOS).

APPENDIX A AC POWER LINE CONDUCTED EMISSIONS

Test Mode	Normal	Tested Date	2022/11/25
Test Frequency	-	Phase	Line

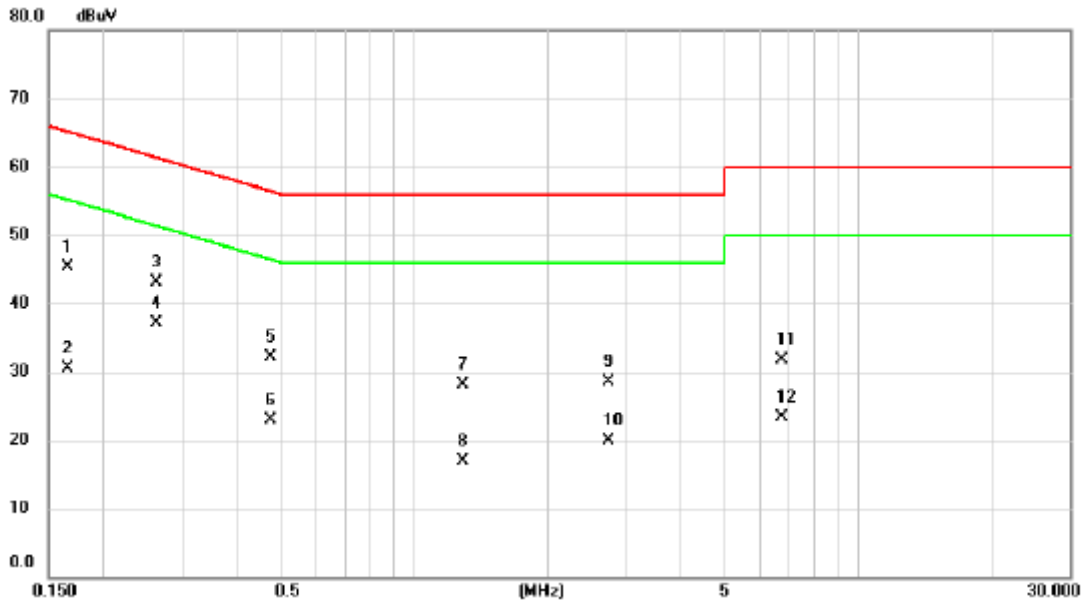

No. Mk.	Freq. MHz	Reading Level dBuV	Correct Factor dB	Measurement dBuV	Limit dBuV	Margin dB	Detector	Comment
1	0.1658	35.69	9.64	45.33	65.17	-19.84	QP	
2	0.1658	20.81	9.64	30.45	55.17	-24.72	AVG	
3	0.2625	33.39	9.63	43.02	61.35	-18.33	QP	
4 *	0.2625	27.39	9.63	37.02	51.35	-14.33	AVG	
5	0.4762	22.52	9.63	32.15	56.41	-24.26	QP	
6	0.4762	13.22	9.63	22.85	46.41	-23.56	AVG	
7	1.2908	18.51	9.68	28.19	56.00	-27.81	QP	
8	1.2908	7.26	9.68	16.94	46.00	-29.06	AVG	
9	2.7420	18.81	9.72	28.53	56.00	-27.47	QP	
10	2.7420	10.20	9.72	19.92	46.00	-26.08	AVG	
11	6.7313	21.90	9.80	31.70	60.00	-28.30	QP	
12	6.7313	13.54	9.80	23.34	50.00	-26.66	AVG	

REMARKS:

- (1) Measurement Value = Reading Level + Correct Factor.
- (2) Margin Level = Measurement Value - Limit Value.

Test Mode	Normal	Tested Date	2022/11/25
Test Frequency	-	Phase	Neutral

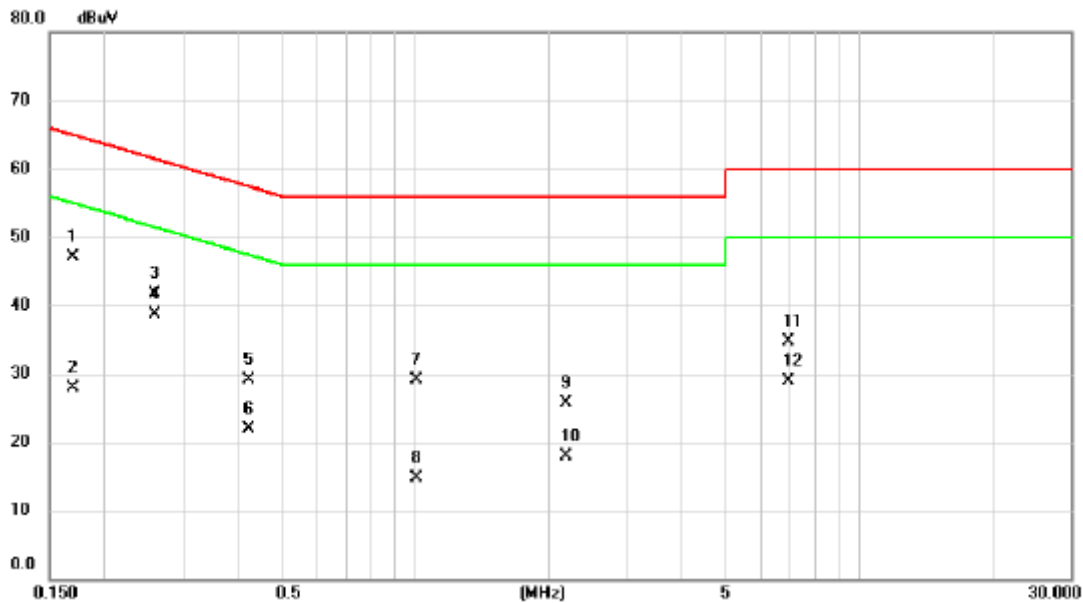

No. Mk.	Freq. MHz	Reading Level dBuV	Correct Factor dB	Measurement dBuV	Limit dBuV	Margin dB	Detector	Comment
1	0.1703	37.51	9.65	47.16	64.95	-17.79	QP	
2	0.1703	18.23	9.65	27.88	54.95	-27.07	AVG	
3	0.2602	32.03	9.64	41.67	61.43	-19.76	QP	
4 *	0.2602	29.01	9.64	38.65	51.43	-12.78	AVG	
5	0.4222	19.42	9.64	29.06	57.40	-28.34	QP	
6	0.4222	12.33	9.64	21.97	47.40	-25.43	AVG	
7	1.0072	19.38	9.68	29.06	56.00	-26.94	QP	
8	1.0072	5.09	9.68	14.77	46.00	-31.23	AVG	
9	2.1840	15.99	9.72	25.71	56.00	-30.29	QP	
10	2.1840	8.23	9.72	17.95	46.00	-28.05	AVG	
11	6.9180	24.93	9.83	34.76	60.00	-25.24	QP	
12	6.9180	18.99	9.83	28.82	50.00	-21.18	AVG	

REMARKS:

- (1) Measurement Value = Reading Level + Correct Factor.
- (2) Margin Level = Measurement Value - Limit Value.

Test Mode	Idle	Tested Date	2022/11/25
Test Frequency	-	Phase	Line

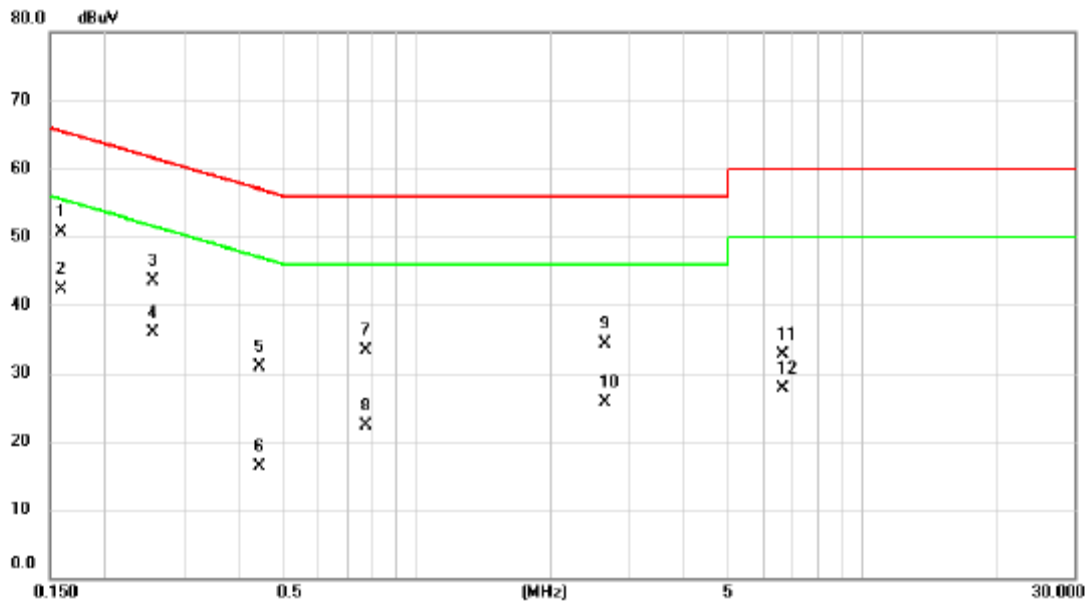

No. Mk.	Freq. MHz	Reading Level dBuV	Correct Factor dB	Measurement dBuV	Limit dBuV	Margin dB	Detector	Comment
1	0.1590	41.02	9.64	50.66	65.52	-14.86	QP	
2 *	0.1590	32.73	9.64	42.37	55.52	-13.15	AVG	
3	0.2556	33.96	9.63	43.59	61.57	-17.98	QP	
4	0.2556	26.23	9.63	35.86	51.57	-15.71	AVG	
5	0.4447	21.25	9.63	30.88	56.97	-26.09	QP	
6	0.4447	6.73	9.63	16.36	46.97	-30.61	AVG	
7	0.7687	23.59	9.66	33.25	56.00	-22.75	QP	
8	0.7687	12.70	9.66	22.36	46.00	-23.64	AVG	
9	2.6452	24.63	9.72	34.35	56.00	-21.65	QP	
10	2.6452	15.90	9.72	25.62	46.00	-20.38	AVG	
11	6.6480	22.96	9.80	32.76	60.00	-27.24	QP	
12	6.6480	17.85	9.80	27.65	50.00	-22.35	AVG	

REMARKS:

- (1) Measurement Value = Reading Level + Correct Factor.
- (2) Margin Level = Measurement Value - Limit Value.

Test Mode	Idle	Tested Date	2022/11/25
Test Frequency	-	Phase	Neutral

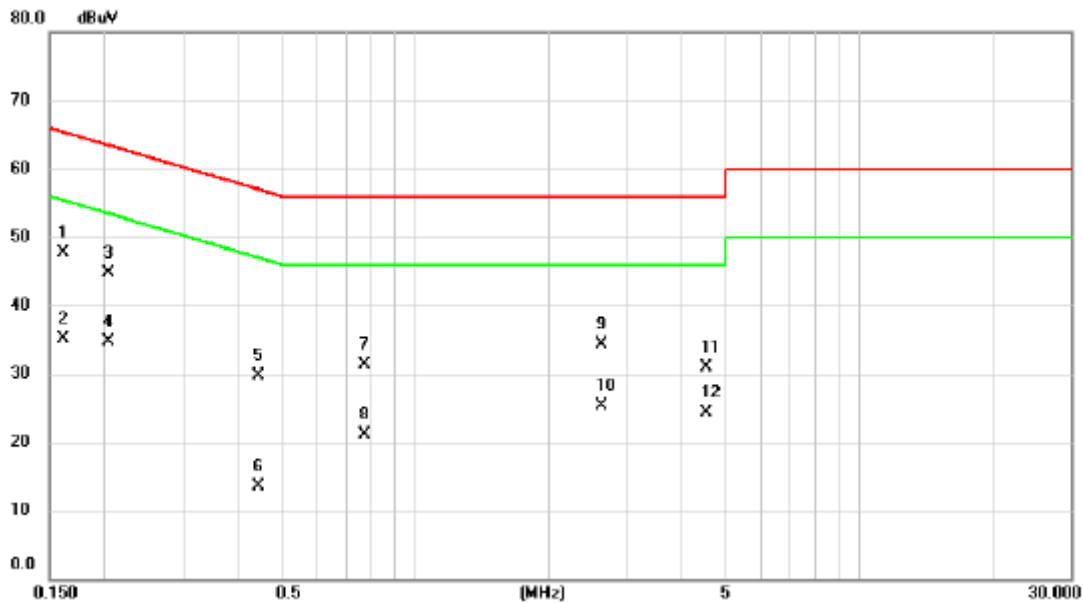

No.	Mk.	Freq.	Reading Level	Correct Factor	Measurement	Limit	Margin	Detector	Comment
		MHz	dBuV	dB	dBuV	dBuV	dB		
1	*	0.1612	38.01	9.65	47.66	65.40	-17.74	QP	
2		0.1612	25.51	9.65	35.16	55.40	-20.24	AVG	
3		0.2040	34.97	9.64	44.61	63.45	-18.84	QP	
4		0.2040	24.98	9.64	34.62	53.45	-18.83	AVG	
5		0.4447	19.97	9.64	29.61	56.97	-27.36	QP	
6		0.4447	3.83	9.64	13.47	46.97	-33.50	AVG	
7		0.7710	21.72	9.67	31.39	56.00	-24.61	QP	
8		0.7710	11.39	9.67	21.06	46.00	-24.94	AVG	
9		2.6362	24.49	9.73	34.22	56.00	-21.78	QP	
10		2.6362	15.67	9.73	25.40	46.00	-20.60	AVG	
11		4.5240	21.15	9.78	30.93	56.00	-25.07	QP	
12		4.5240	14.51	9.78	24.29	46.00	-21.71	AVG	

REMARKS:

- (1) Measurement Value = Reading Level + Correct Factor.
- (2) Margin Level = Measurement Value - Limit Value.

APPENDIX B RADIATED EMISSIONS - 30 MHZ TO 1 GHZ

Test Mode	IEEE 802.11a	Test Date	2022/12/15
Test Frequency	5475MHz	Polarization	Vertical
Temp	23°C	Hum.	59%

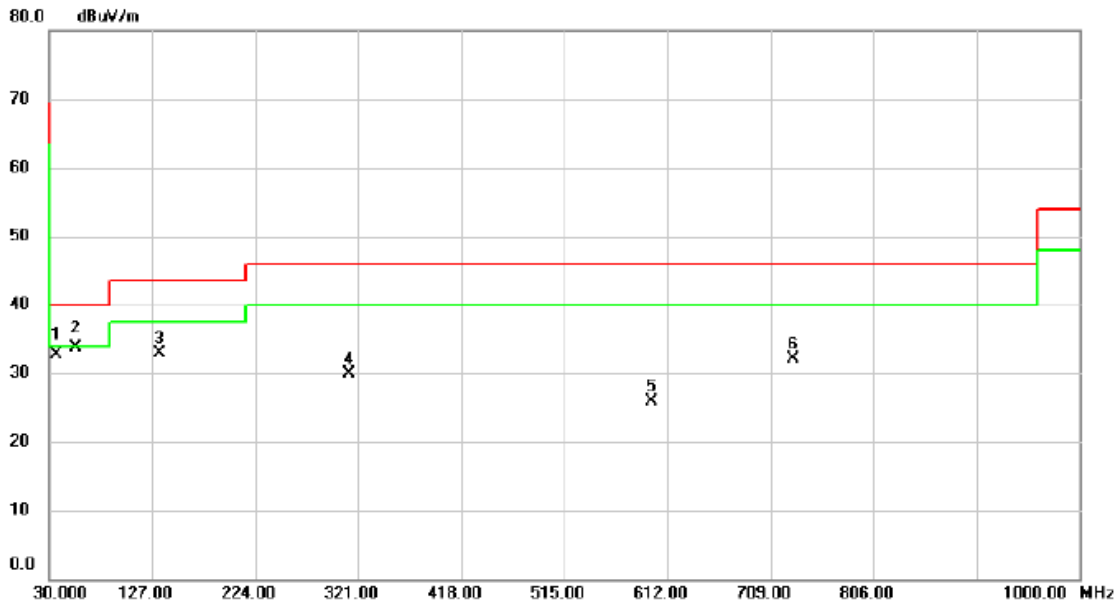

No.	Mk.	Freq. MHz	Reading Level dBuV	Correct Factor dB	Measure- ment dBuV/m	Limit dBuV/m	Over dB	Detector	Comment
1		37.0162	50.78	-18.08	32.70	40.00	-7.30	QP	
2	*	54.9937	52.02	-18.40	33.62	40.00	-6.38	QP	
3		133.6283	52.14	-19.33	32.81	43.50	-10.69	peak	
4		312.0113	47.94	-18.04	29.90	46.00	-16.10	peak	
5		596.6093	36.61	-10.74	25.87	46.00	-20.13	peak	
6		730.3723	40.42	-8.39	32.03	46.00	-13.97	peak	

REMARKS:

- (1) Measurement Value = Reading Level + Correct Factor.
- (2) Margin Level = Measurement Value - Limit Value.

Test Mode	IEEE 802.11a	Test Date	2022/12/15
Test Frequency	5475MHz	Polarization	Horizontal
Temp	23°C	Hum.	59%

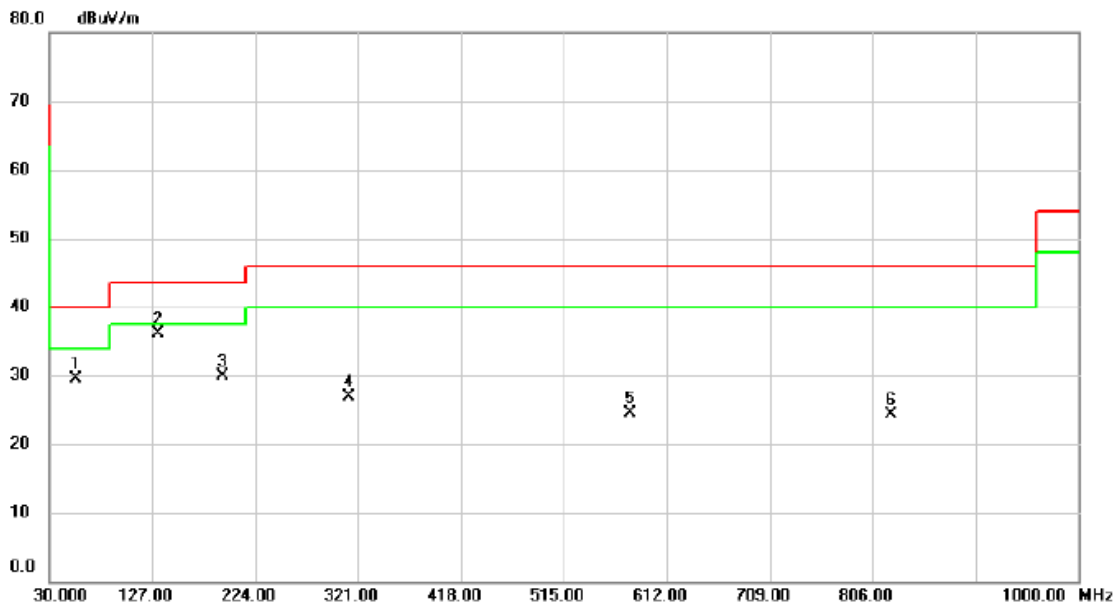

No.	Mk.	Freq. MHz	Reading Level dBuV	Correct Factor dB	Measure- ment dBuV/m	Limit dBuV/m	Over dB	Detector	Comment
1		55.1230	47.91	-18.41	29.50	40.00	-10.50	peak	
2	*	132.9170	55.41	-19.36	36.05	43.50	-7.45	peak	
3		193.4127	51.26	-21.32	29.94	43.50	-13.56	peak	
4		312.1083	44.95	-18.04	26.91	46.00	-19.09	peak	
5		577.9530	35.87	-11.28	24.59	46.00	-21.41	peak	
6		823.0397	31.11	-6.79	24.32	46.00	-21.68	peak	

REMARKS:

- (1) Measurement Value = Reading Level + Correct Factor.
- (2) Margin Level = Measurement Value - Limit Value.

APPENDIX C RADIATED EMISSIONS - ABOVE 1 GHZ

Test Mode	IEEE 802.11a	Test Date	2022/12/1
Test Frequency	5200MHz	Polarization	Vertical
Temp	23°C	Hum.	59%

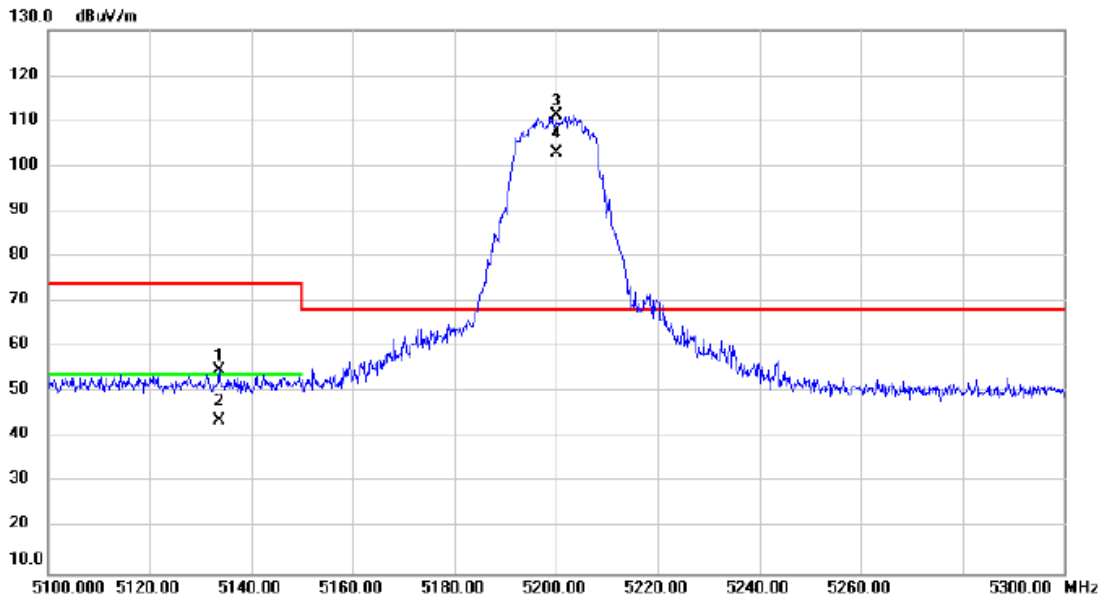

No.	Mk.	Freq.	Reading Level	Correct Factor	Measurement	Limit	Over	Detector	Comment
		MHz	dBuV	dB	dBuV/m	dBuV/m	dB		
1		5133.673	53.39	1.37	54.76	74.00	-19.24	peak	
2		5133.673	42.35	1.37	43.72	54.00	-10.28	AVG	
3	*	5200.000	109.72	1.39	111.11	68.20	42.91	peak	No Limit
4	X	5200.000	101.33	1.39	102.72	68.20	34.52	AVG	No Limit

REMARKS:

- (1) Measurement Value = Reading Level + Correct Factor.
- (2) Margin Level = Measurement Value - Limit Value.

Test Mode	IEEE 802.11a	Test Date	2022/12/1
Test Frequency	5280MHz	Polarization	Vertical
Temp	23°C	Hum.	59%

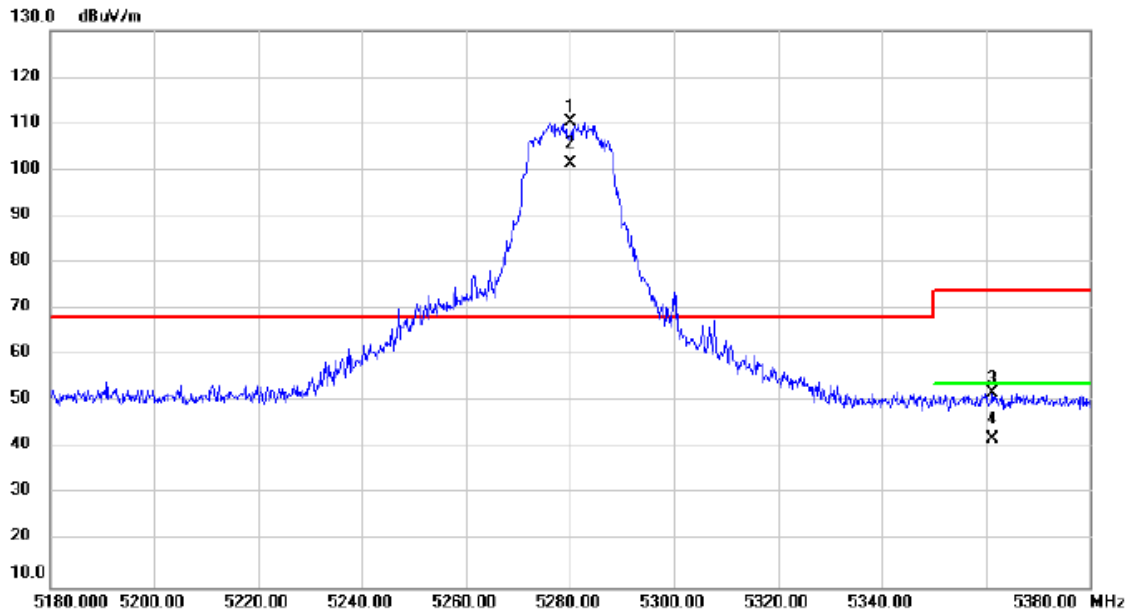

No.	Mk.	Freq.	Reading Level	Correct Factor	Measurement	Limit	Over	Detector	Comment
		MHz	dBuV	dB	dBuV/m	dBuV/m	dB		
1	*	5280.000	108.87	1.42	110.29	68.20	42.09	peak	No Limit
2	X	5280.000	99.82	1.42	101.24	68.20	33.04	AVG	No Limit
3		5361.307	50.37	1.44	51.81	74.00	-22.19	peak	
4		5361.307	40.41	1.44	41.85	54.00	-12.15	AVG	

REMARKS:

- (1) Measurement Value = Reading Level + Correct Factor.
- (2) Margin Level = Measurement Value - Limit Value.

Test Mode	IEEE 802.11a	Test Date	2022/12/1
Test Frequency	5700MHz	Polarization	Vertical
Temp	23°C	Hum.	59%

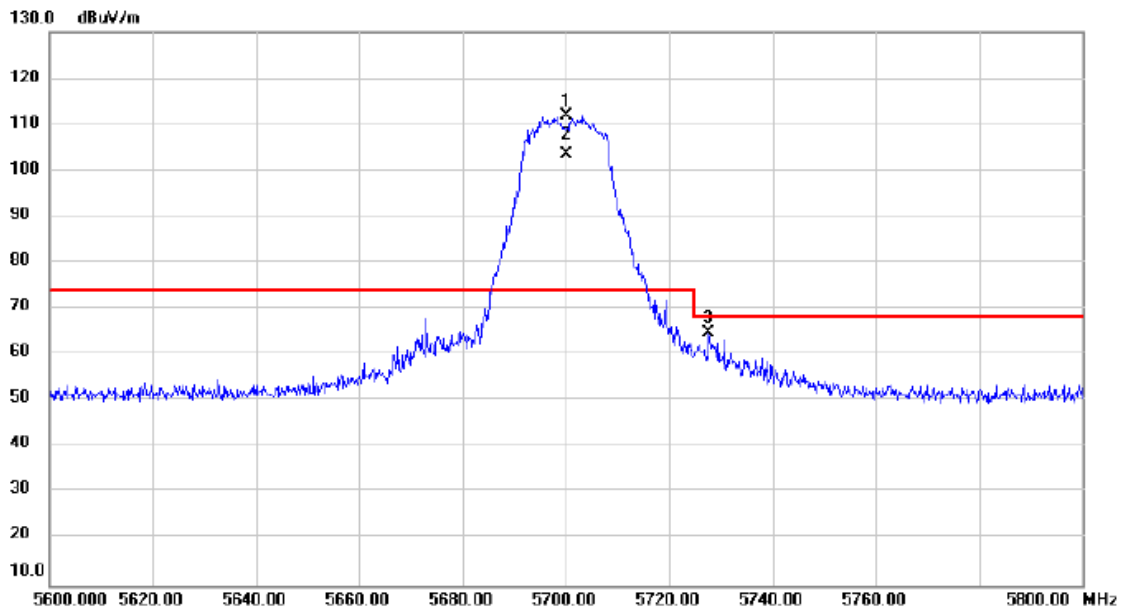

No.	Mk.	Freq.	Reading Level	Correct Factor	Measurement	Limit	Over	Detector	Comment
		MHz	dBuV	dB	dBuV/m	dBuV/m	dB		
1	*	5700.000	110.11	1.89	112.00	74.00	38.00	peak	No Limit
2	X	5700.000	101.49	1.89	103.38	74.00	29.38	AVG	No Limit
3		5727.667	62.66	1.95	64.61	68.20	-3.59	peak	

REMARKS:

- (1) Measurement Value = Reading Level + Correct Factor.
- (2) Margin Level = Measurement Value - Limit Value.

Test Mode	IEEE 802.11a	Test Date	2022/12/1
Test Frequency	5745MHz	Polarization	Vertical
Temp	23°C	Hum.	59%

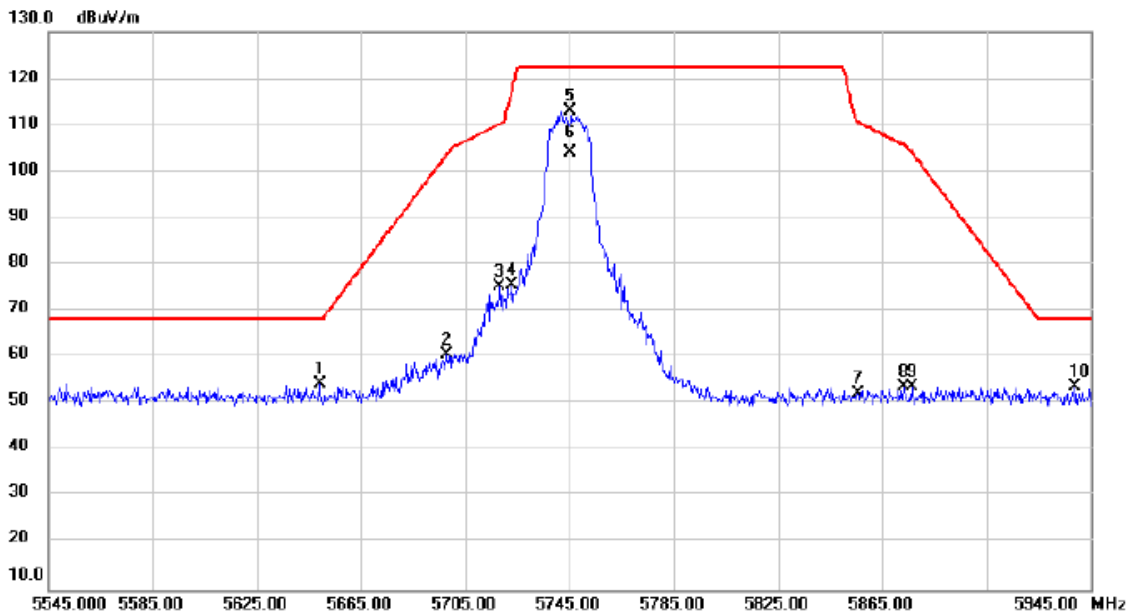

No.	Mk.	Freq. MHz	Reading Level dBuV	Correct Factor dB	Measure- ment dBuV/m	Limit dBuV/m	Over dB	Detector	Comment
1		5649.280	52.56	1.79	54.35	68.20	-13.85	peak	
2		5697.893	58.72	1.89	60.61	103.65	-43.04	peak	
3		5718.253	73.40	1.93	75.33	110.31	-34.98	peak	
4		5722.733	73.64	1.93	75.57	117.03	-41.46	peak	
5	*	5745.000	111.07	1.98	113.05	122.20	-9.15	peak	No Limit
6		5745.000	102.20	1.98	104.18	122.20	-18.02	AVG	No Limit
7		5855.427	50.06	2.21	52.27	110.68	-58.41	peak	
8		5873.067	51.53	2.24	53.77	105.74	-51.97	peak	
9		5876.293	51.52	2.26	53.78	104.24	-50.46	peak	
10		5938.693	51.15	2.37	53.52	68.20	-14.68	peak	

REMARKS:

- (1) Measurement Value = Reading Level + Correct Factor.
- (2) Margin Level = Measurement Value - Limit Value.

Test Mode	IEEE 802.11ac (VHT80)	Test Date	2022/12/1
Test Frequency	5210MHz	Polarization	Vertical
Temp	23°C	Hum.	59%

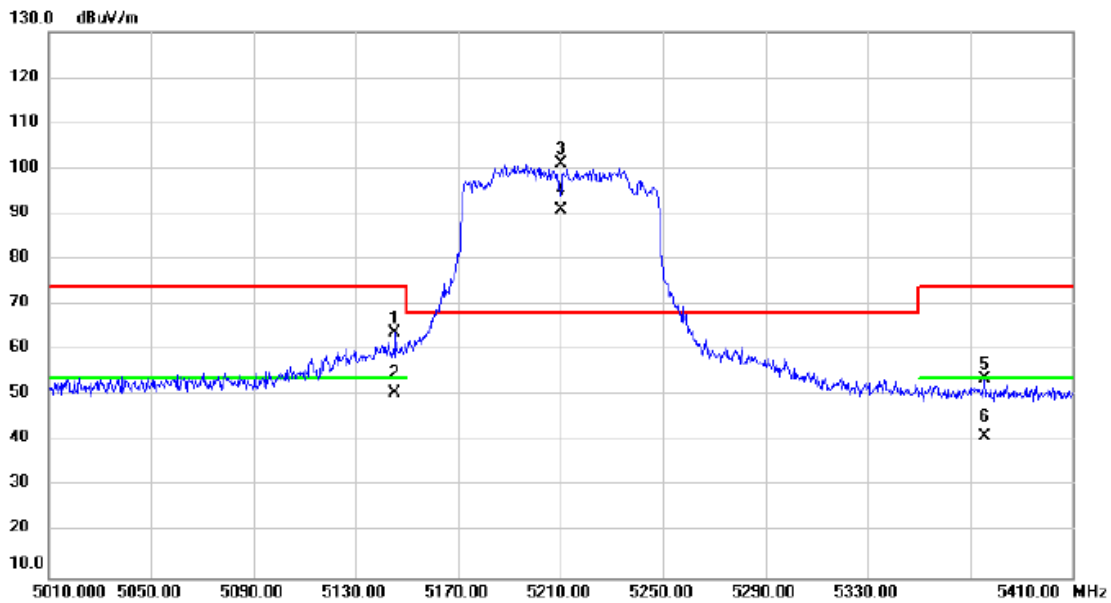

No.	Mk.	Freq. MHz	Reading Level dBuV	Correct Factor dB	Measure- ment dBuV/m	Limit dBuV/m	Over dB	Detector	Comment
1		5145.347	62.61	1.37	63.98	74.00	-10.02	peak	
2		5145.347	49.38	1.37	50.75	54.00	-3.25	AVG	
3	*	5210.000	99.67	1.39	101.06	68.20	32.86	peak	No Limit
4	X	5210.000	89.53	1.39	90.92	68.20	22.72	AVG	No Limit
5		5375.600	52.27	1.45	53.72	74.00	-20.28	peak	
6		5375.600	39.74	1.45	41.19	54.00	-12.81	AVG	

REMARKS:

- (1) Measurement Value = Reading Level + Correct Factor.
- (2) Margin Level = Measurement Value - Limit Value.

Test Mode	IEEE 802.11ac (VHT80)	Test Date	2022/12/1
Test Frequency	5290MHz	Polarization	Vertical
Temp	23°C	Hum.	59%

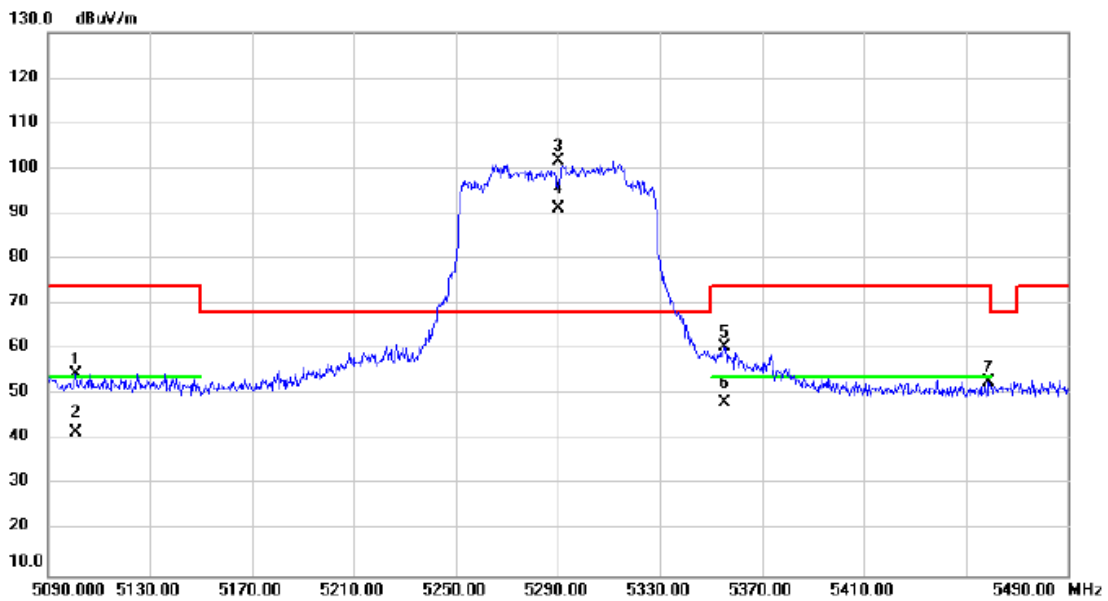

No.	Mk.	Freq. MHz	Reading Level dBuV	Correct Factor dB	Measure- ment dBuV/m	Limit dBuV/m	Over dB	Detector	Comment
1		5100.800	53.15	1.35	54.50	74.00	-19.50	peak	
2		5100.800	40.43	1.35	41.78	54.00	-12.22	AVG	
3	*	5290.000	100.24	1.42	101.66	68.20	33.46	peak	No Limit
4	X	5290.000	89.68	1.42	91.10	68.20	22.90	AVG	No Limit
5		5355.573	59.25	1.44	60.69	74.00	-13.31	peak	
6		5355.573	46.71	1.44	48.15	54.00	-5.85	AVG	
7		5458.947	51.17	1.47	52.64	74.00	-21.36	peak	

REMARKS:

- (1) Measurement Value = Reading Level + Correct Factor.
- (2) Margin Level = Measurement Value - Limit Value.

Test Mode	IEEE 802.11ac (VHT80)	Test Date	2022/12/1
Test Frequency	5610MHz	Polarization	Vertical
Temp	23°C	Hum.	59%

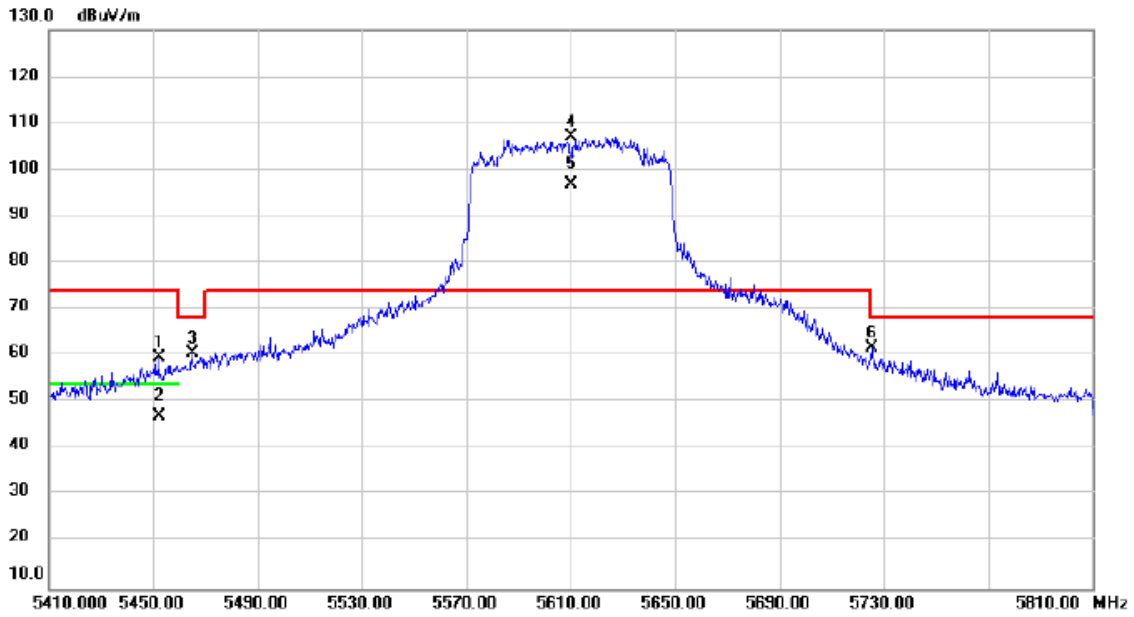

No.	Mk.	Freq.	Reading Level	Correct Factor	Measurement	Limit	Over	Detector	Comment
		MHz	dBuV	dB	dBuV/m	dBuV/m	dB		
1		5452.147	58.06	1.47	59.53	74.00	-14.47	peak	
2		5452.147	45.51	1.47	46.98	54.00	-7.02	AVG	
3		5465.067	59.19	1.48	60.67	68.20	-7.53	peak	
4	*	5610.000	105.30	1.71	107.01	74.00	33.01	peak	No Limit
5	X	5610.000	95.13	1.71	96.84	74.00	22.84	AVG	No Limit
6		5725.373	59.75	1.95	61.70	68.20	-6.50	peak	

REMARKS:

- (1) Measurement Value = Reading Level + Correct Factor.
- (2) Margin Level = Measurement Value - Limit Value.

Test Mode	IEEE 802.11ac (VHT80)	Test Date	2022/12/1
Test Frequency	5775MHz	Polarization	Vertical
Temp	23°C	Hum.	59%

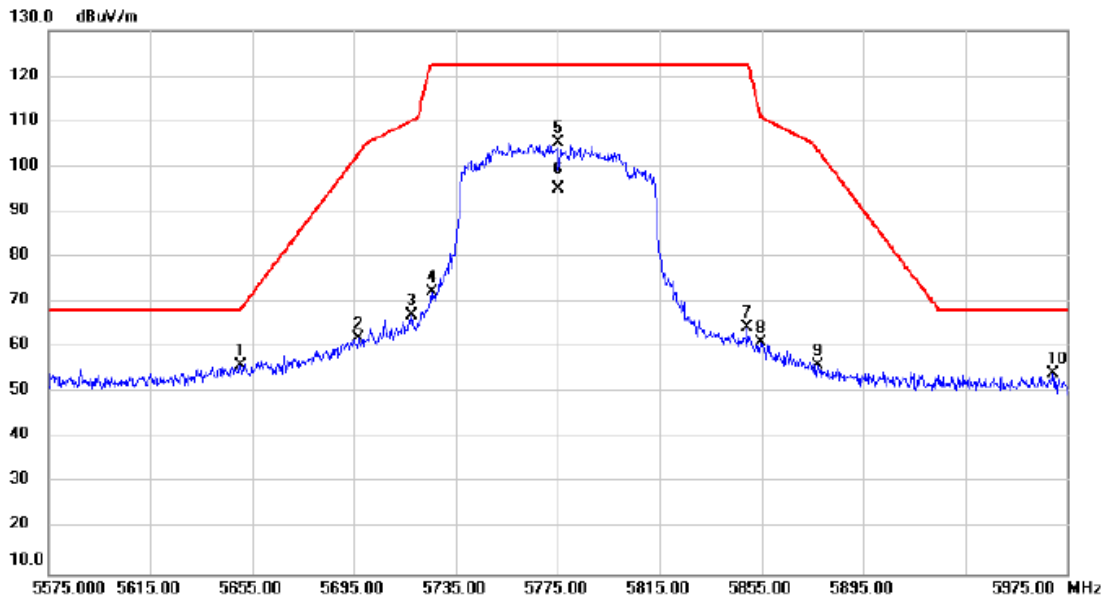

No.	Mk.	Freq.	Reading Level	Correct Factor	Measurement	Limit	Over		
		MHz	dBuV	dB	dBuV/m	dBuV/m	dB	Detector	Comment
1	*	5650.587	54.24	1.79	56.03	68.64	-12.61	peak	
2		5696.933	60.30	1.89	62.19	102.94	-40.75	peak	
3		5717.933	65.11	1.93	67.04	110.22	-43.18	peak	
4		5725.560	70.26	1.95	72.21	122.20	-49.99	peak	
5		5775.000	103.22	2.06	105.28	122.20	-16.92	peak	No Limit
6		5775.000	92.86	2.06	94.92	122.20	-27.28	AVG	No Limit
7		5849.533	62.14	2.20	64.34	122.20	-57.86	peak	
8		5854.973	58.92	2.21	61.13	110.86	-49.73	peak	
9		5877.267	53.84	2.26	56.10	103.52	-47.42	peak	
10		5969.147	51.67	2.44	54.11	68.20	-14.09	peak	

REMARKS:

- (1) Measurement Value = Reading Level + Correct Factor.
- (2) Margin Level = Measurement Value - Limit Value.

Test Mode	IEEE 802.11ax (HE160)	Test Date	2022/12/1
Test Frequency	5250MHz	Polarization	Vertical
Temp	23°C	Hum.	59%

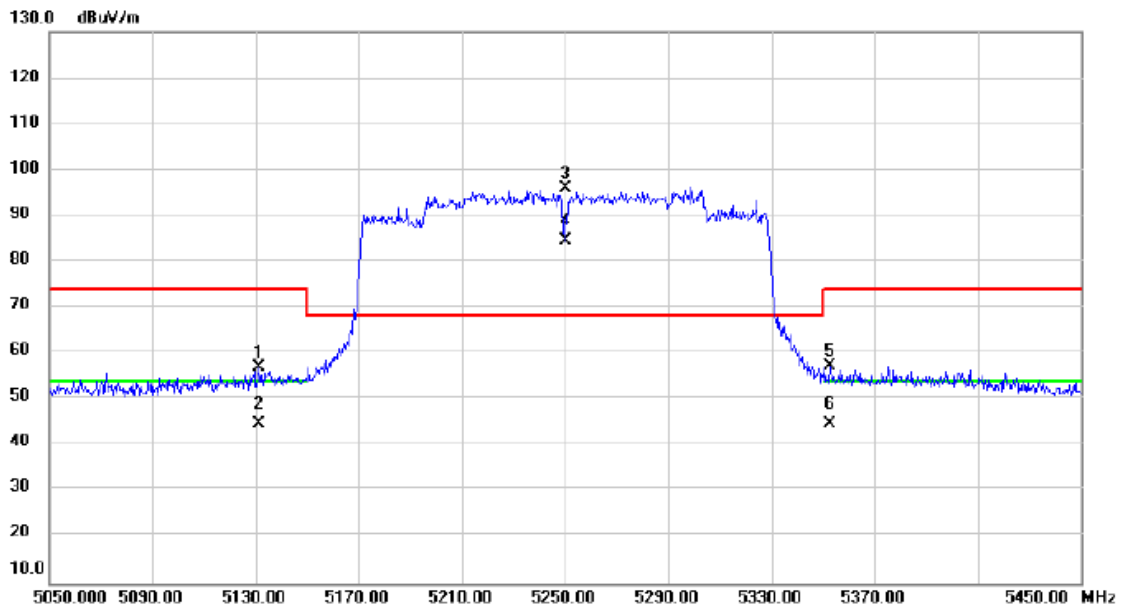

No.	Mk.	Freq. MHz	Reading Level dBuV	Correct Factor dB	Measure- ment dBuV/m	Limit dBuV/m	Over dB	Detector	Comment
1		5131.493	55.69	1.36	57.05	74.00	-16.95	peak	
2		5131.493	43.15	1.36	44.51	54.00	-9.49	AVG	
3	*	5250.000	94.69	1.41	96.10	68.20	27.90	peak	No Limit
4	X	5250.000	83.07	1.41	84.48	68.20	16.28	AVG	No Limit
5		5352.800	55.92	1.44	57.36	74.00	-16.64	peak	
6		5352.800	43.19	1.44	44.63	54.00	-9.37	AVG	

REMARKS:

- (1) Measurement Value = Reading Level + Correct Factor.
- (2) Margin Level = Measurement Value - Limit Value.

Test Mode	IEEE 802.11ax (HE160)	Test Date	2022/12/1
Test Frequency	5570MHz	Polarization	Vertical
Temp	23°C	Hum.	59%

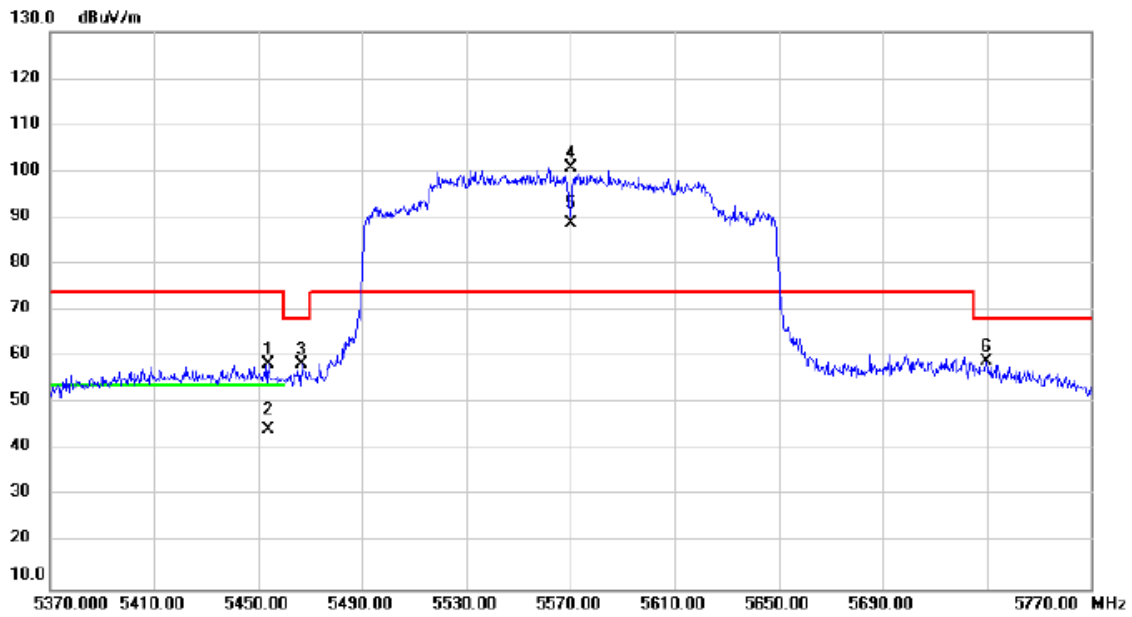

No.	Mk.	Freq. MHz	Reading Level dBuV	Correct Factor dB	Measure- ment dBuV/m	Limit dBuV/m	Over dB	Detector	Comment
1		5454.187	56.87	1.47	58.34	74.00	-15.66	peak	
2		5454.187	42.87	1.47	44.34	54.00	-9.66	AVG	
3		5466.587	56.88	1.48	58.36	68.20	-9.84	peak	
4	*	5570.000	99.00	1.63	100.63	74.00	26.63	peak	No Limit
5	X	5570.000	87.24	1.63	88.87	74.00	14.87	AVG	No Limit
6		5729.720	57.12	1.95	59.07	68.20	-9.13	peak	

REMARKS:

- (1) Measurement Value = Reading Level + Correct Factor.
- (2) Margin Level = Measurement Value - Limit Value.

Test Mode	IEEE 802.11a	Test Date	2022/12/1
Test Frequency	5240MHz	Polarization	Vertical
Temp	23°C	Hum.	59%

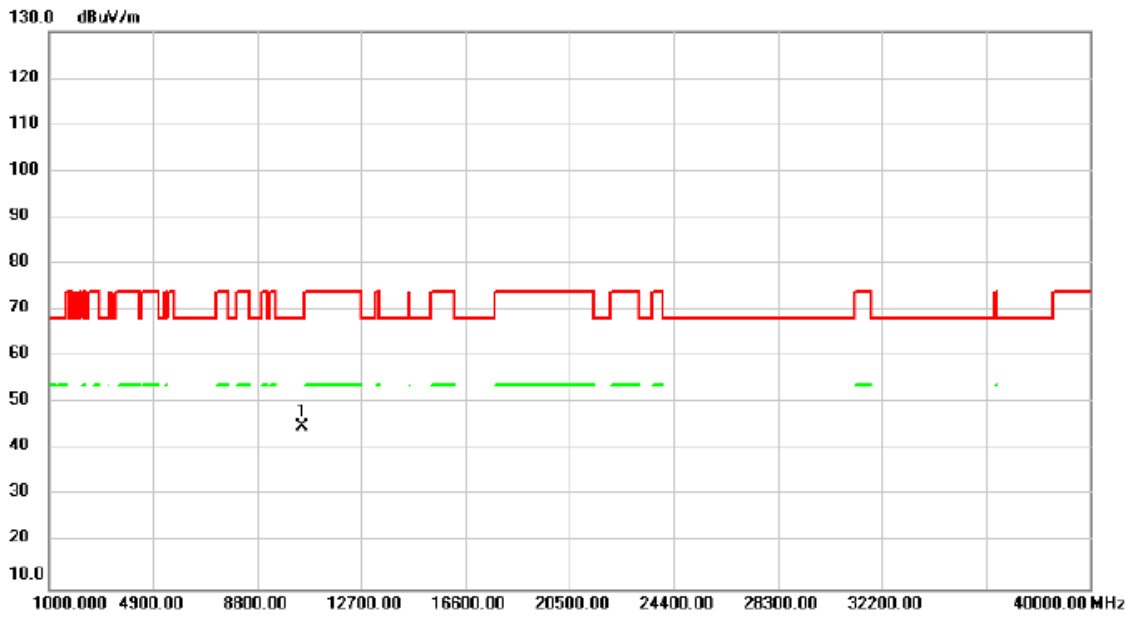

No.	Mk.	Freq.	Reading Level	Correct Factor	Measurement	Limit	Over	Detector	Comment
		MHz	dBuV	dB	dBuV/m	dBuV/m	dB		
1	*	10480.00	39.34	5.75	45.09	68.20	-23.11	peak	

REMARKS:

- (1) Measurement Value = Reading Level + Correct Factor.
- (2) Margin Level = Measurement Value - Limit Value.

Test Mode	IEEE 802.11a	Test Date	2022/12/1
Test Frequency	5240MHz	Polarization	Horizontal
Temp	23°C	Hum.	59%

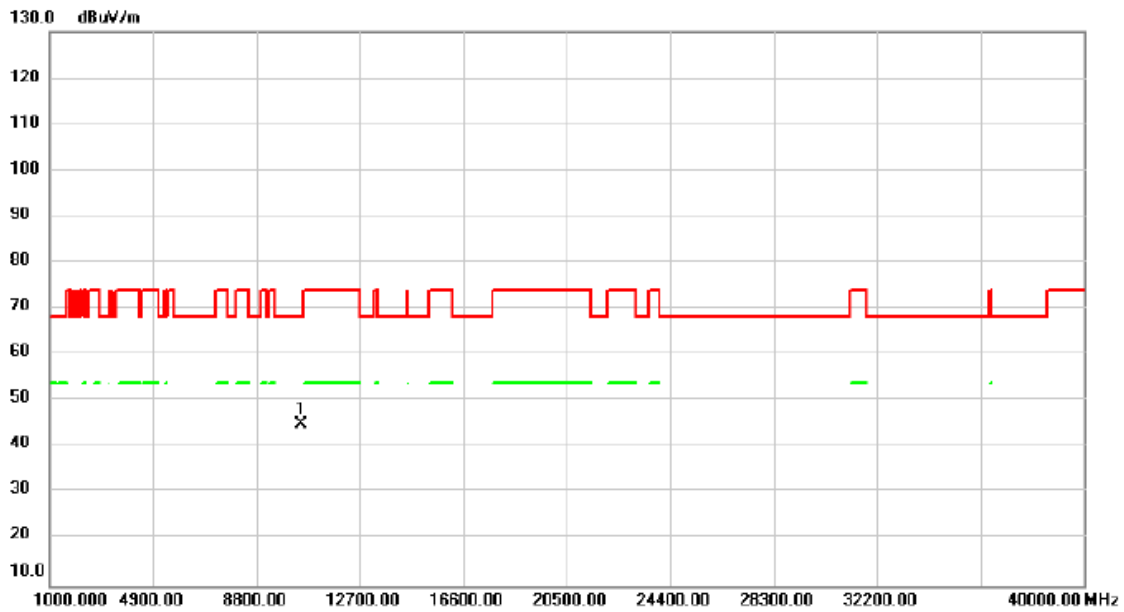

No.	Mk.	Freq.	Reading Level	Correct Factor	Measurement	Limit	Over	Detector	Comment
		MHz	dBuV	dB	dBuV/m	dBuV/m	dB		
1	*	10480.00	39.19	5.75	44.94	68.20	-23.26	peak	

REMARKS:

- (1) Measurement Value = Reading Level + Correct Factor.
- (2) Margin Level = Measurement Value - Limit Value.

Test Mode	IEEE 802.11a	Test Date	2022/12/1
Test Frequency	5280MHz	Polarization	Vertical
Temp	23°C	Hum.	59%

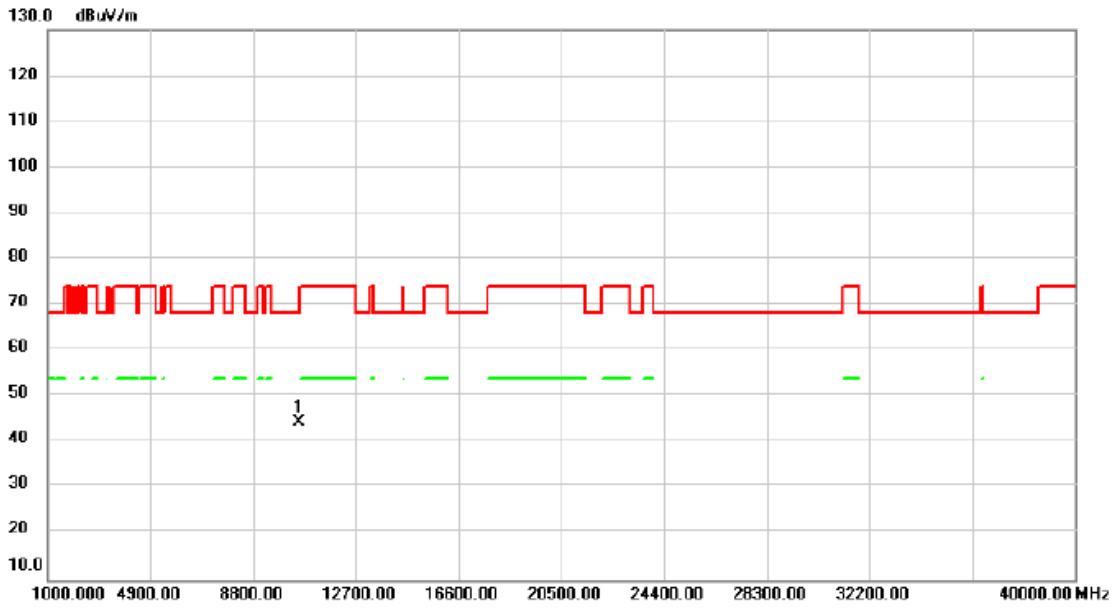

No. Mk.	Freq. MHz	Reading Level dBuV	Correct Factor dB	Measurement dBuV/m	Limit dBuV/m	Over dB	Detector	Comment
1 *	10560.00	38.68	5.69	44.37	68.20	-23.83	peak	

REMARKS:

- (1) Measurement Value = Reading Level + Correct Factor.
- (2) Margin Level = Measurement Value - Limit Value.

Test Mode	IEEE 802.11a	Test Date	2022/12/1
Test Frequency	5280MHz	Polarization	Horizontal
Temp	23°C	Hum.	59%

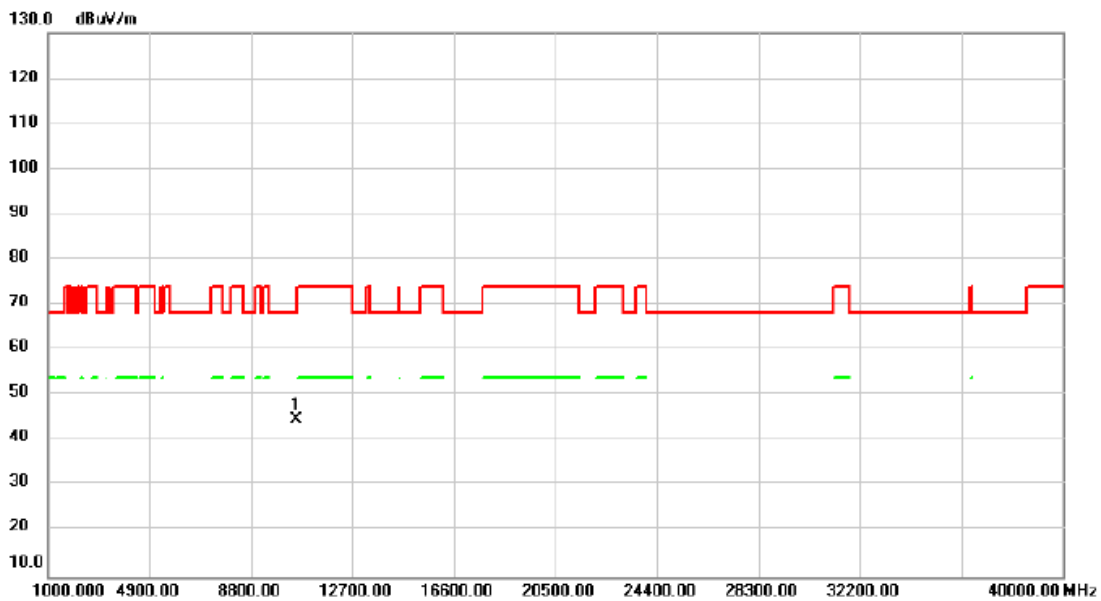

No.	Mk.	Freq.	Reading Level	Correct Factor	Measurement	Limit	Over	Detector	Comment
		MHz	dBuV	dB	dBuV/m	dBuV/m	dB		
1	*	10560.00	39.08	5.69	44.77	68.20	-23.43	peak	

REMARKS:

- (1) Measurement Value = Reading Level + Correct Factor.
- (2) Margin Level = Measurement Value - Limit Value.

Test Mode	IEEE 802.11a	Test Date	2022/12/1
Test Frequency	5600MHz	Polarization	Vertical
Temp	23°C	Hum.	59%

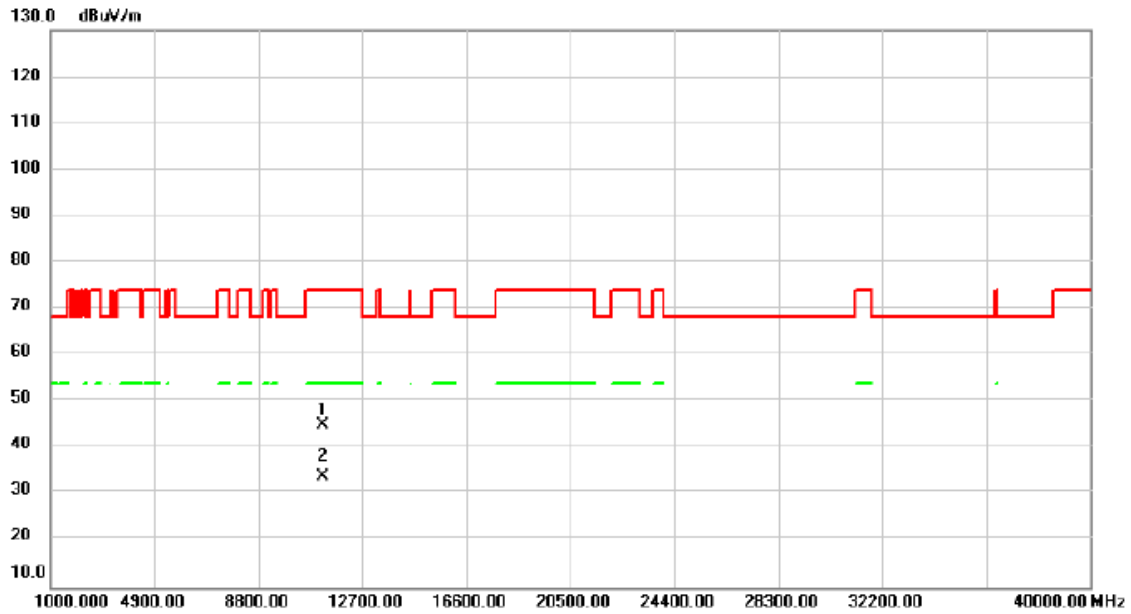

No.	Mk.	Freq. MHz	Reading Level dBuV	Correct Factor dB	Measure- ment dBuV/m	Limit dBuV/m	Over dB	Detector	Comment
1		11200.00	39.30	5.78	45.08	74.00	-28.92	peak	
2	*	11200.00	28.01	5.78	33.79	54.00	-20.21	AVG	

REMARKS:

- (1) Measurement Value = Reading Level + Correct Factor.
- (2) Margin Level = Measurement Value - Limit Value.

Test Mode	IEEE 802.11a	Test Date	2022/12/1
Test Frequency	5600MHz	Polarization	Horizontal
Temp	23°C	Hum.	59%

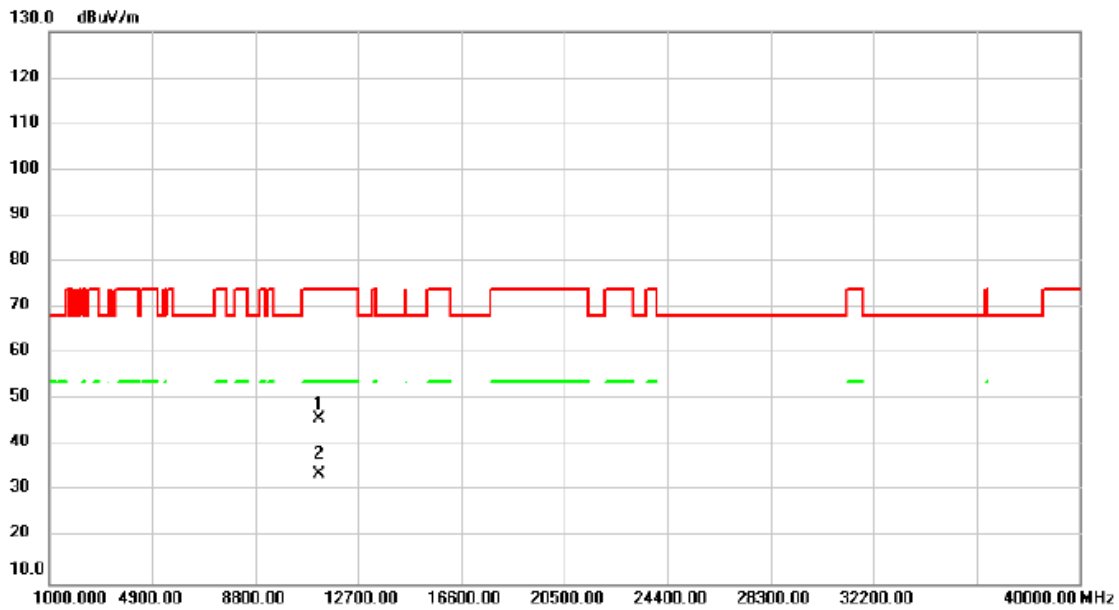

No.	Mk.	Freq.	Reading Level	Correct Factor	Measurement	Limit	Over	Detector	Comment
		MHz	dBuV	dB	dBuV/m	dBuV/m	dB		
1		11200.00	39.95	5.78	45.73	74.00	-28.27	peak	
2	*	11200.00	28.11	5.78	33.89	54.00	-20.11	AVG	

REMARKS:

- (1) Measurement Value = Reading Level + Correct Factor.
- (2) Margin Level = Measurement Value - Limit Value.

Test Mode	IEEE 802.11a	Test Date	2022/12/1
Test Frequency	5745MHz	Polarization	Vertical
Temp	23°C	Hum.	59%

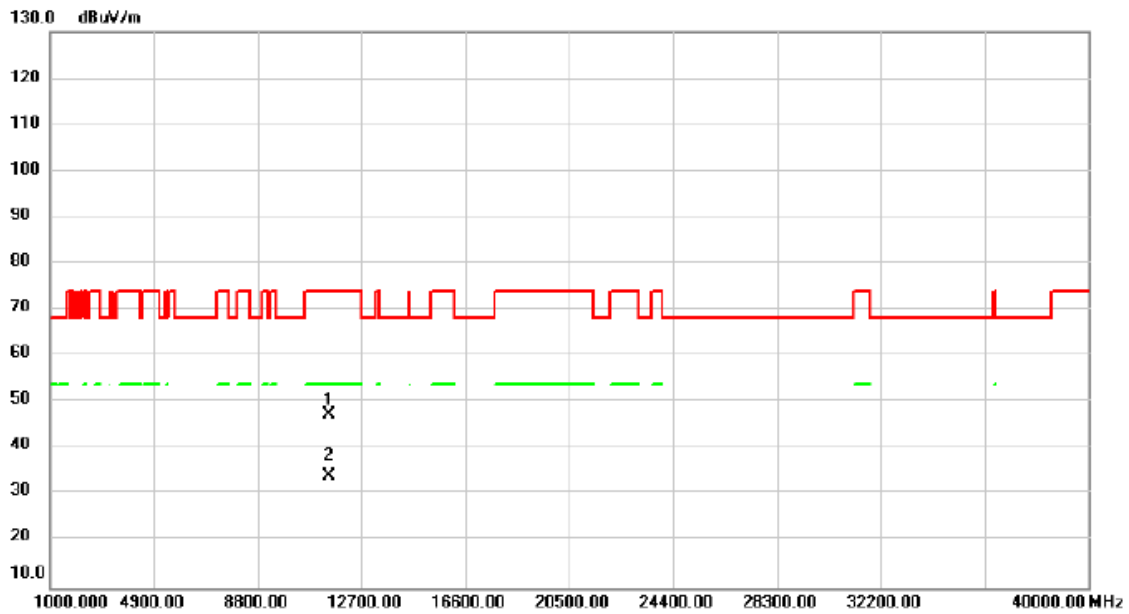

No.	Mk.	Freq.	Reading Level	Correct Factor	Measurement	Limit	Over	Detector	Comment
		MHz	dBuV	dB	dBuV/m	dBuV/m	dB		
1		11490.00	41.18	6.26	47.44	74.00	-26.56	peak	
2	*	11490.00	27.79	6.26	34.05	54.00	-19.95	AVG	

REMARKS:

- (1) Measurement Value = Reading Level + Correct Factor.
- (2) Margin Level = Measurement Value - Limit Value.

Test Mode	IEEE 802.11a	Test Date	2022/12/1
Test Frequency	5745MHz	Polarization	Horizontal
Temp	23°C	Hum.	59%

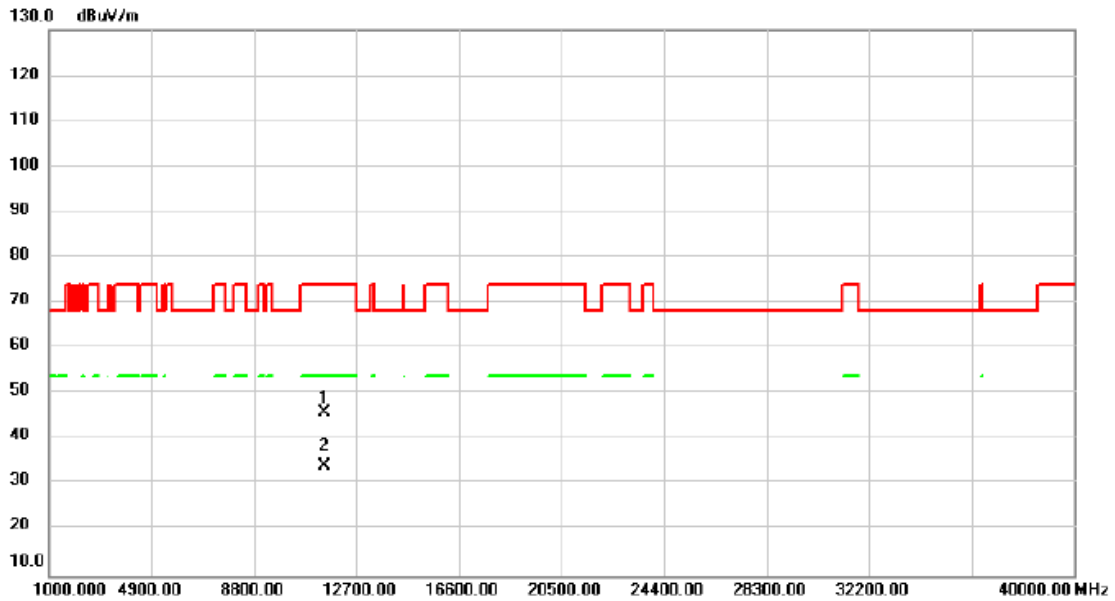

No.	Mk.	Freq. MHz	Reading Level dBuV	Correct Factor dB	Measure- ment dBuV/m	Limit dBuV/m	Over dB	Detector	Comment
1		11490.00	39.70	6.26	45.96	74.00	-28.04	peak	
2	*	11490.00	27.82	6.26	34.08	54.00	-19.92	AVG	

REMARKS:

- (1) Measurement Value = Reading Level + Correct Factor.
- (2) Margin Level = Measurement Value - Limit Value.

Test Mode	IEEE 802.11ac (VHT80)	Test Date	2022/12/1
Test Frequency	5210MHz	Polarization	Vertical
Temp	23°C	Hum.	59%

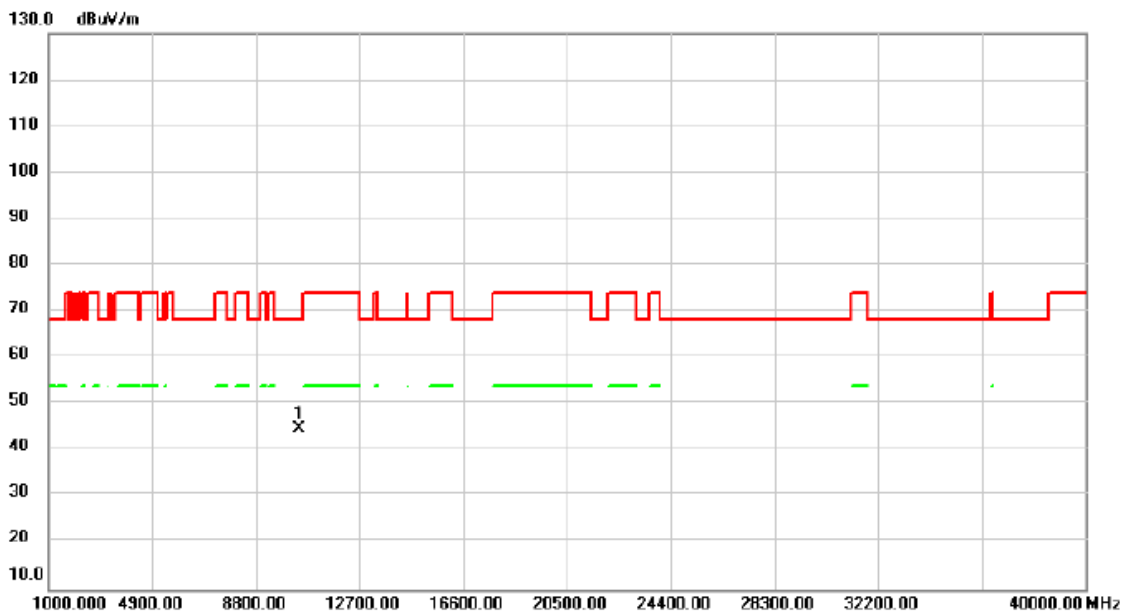

No.	Mk.	Freq.	Reading Level	Correct Factor	Measurement	Limit	Over	Detector	Comment
		MHz	dBuV	dB	dBuV/m	dBuV/m	dB		
1	*	10420.00	38.92	5.78	44.70	68.20	-23.50	peak	

REMARKS:

- (1) Measurement Value = Reading Level + Correct Factor.
- (2) Margin Level = Measurement Value - Limit Value.

Test Mode	IEEE 802.11ac (VHT80)	Test Date	2022/12/1
Test Frequency	5210MHz	Polarization	Horizontal
Temp	23°C	Hum.	59%

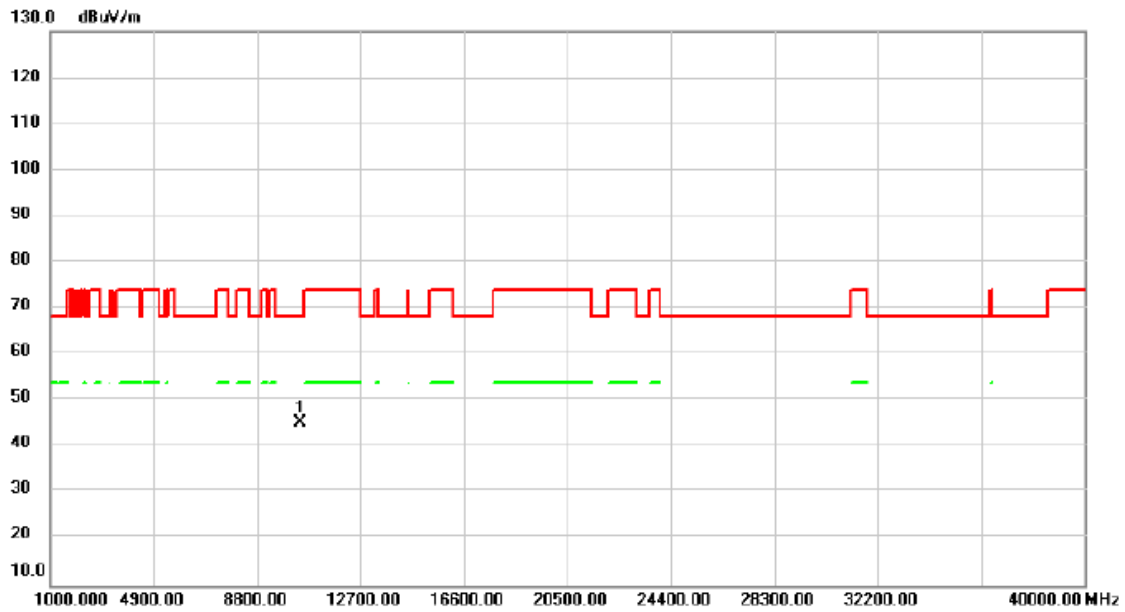

No.	Mk.	Freq.	Reading Level	Correct Factor	Measurement	Limit	Over	Detector	Comment
		MHz	dBuV	dB	dBuV/m	dBuV/m	dB		
1	*	10420.00	39.43	5.78	45.21	68.20	-22.99	peak	

REMARKS:

- (1) Measurement Value = Reading Level + Correct Factor.
- (2) Margin Level = Measurement Value - Limit Value.

Test Mode	IEEE 802.11ac (VHT80)	Test Date	2022/12/1
Test Frequency	5290MHz	Polarization	Vertical
Temp	23°C	Hum.	59%

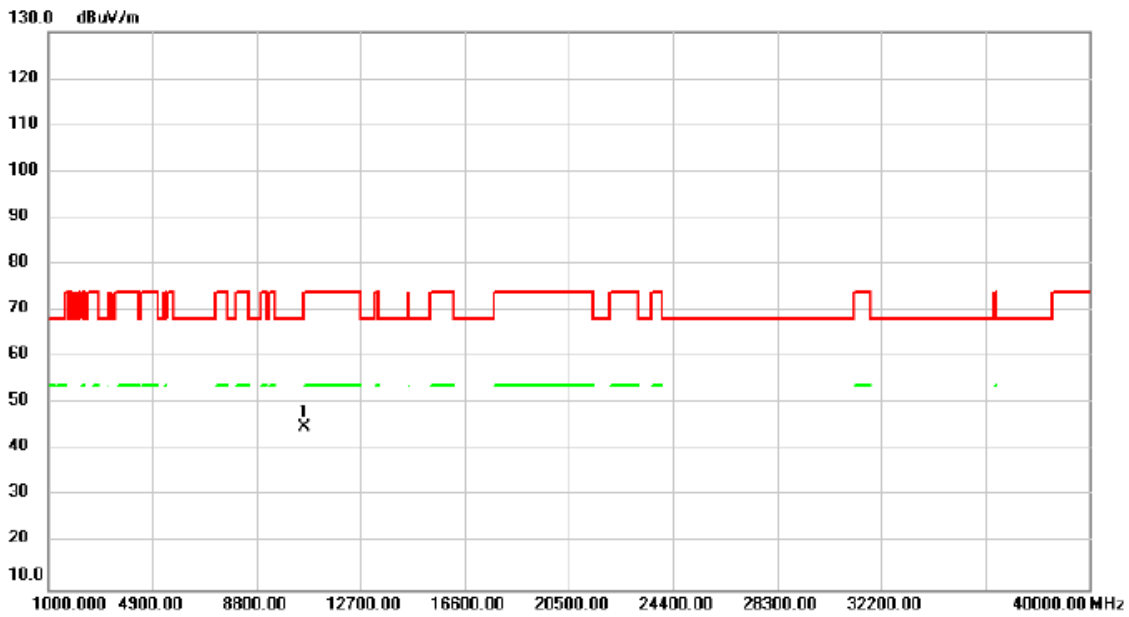

No.	Mk.	Freq.	Reading Level	Correct Factor	Measurement	Limit	Over	Detector	Comment
		MHz	dBuV	dB	dBuV/m	dBuV/m	dB		
1	*	10580.00	39.40	5.69	45.09	68.20	-23.11	peak	

REMARKS:

- (1) Measurement Value = Reading Level + Correct Factor.
- (2) Margin Level = Measurement Value - Limit Value.

Test Mode	IEEE 802.11ac (VHT80)	Test Date	2022/12/1
Test Frequency	5290MHz	Polarization	Horizontal
Temp	23°C	Hum.	59%

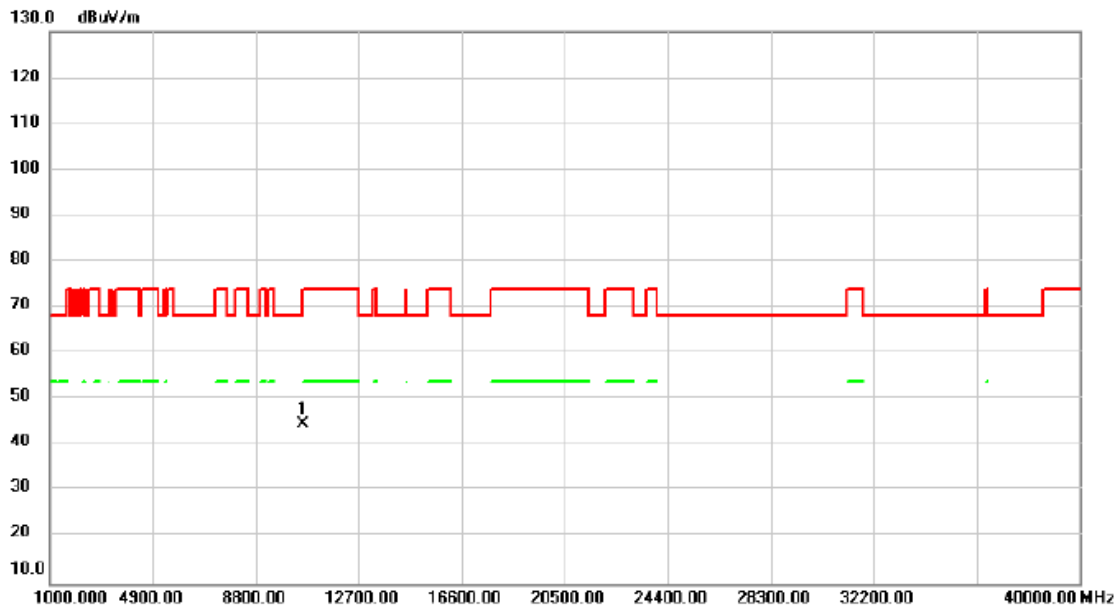

No.	Mk.	Freq.	Reading Level	Correct Factor	Measurement	Limit	Over	Detector	Comment
		MHz	dBuV	dB	dBuV/m	dBuV/m	dB		
1	*	10580.00	39.00	5.69	44.69	68.20	-23.51	peak	

REMARKS:

- (1) Measurement Value = Reading Level + Correct Factor.
- (2) Margin Level = Measurement Value - Limit Value.

Test Mode	IEEE 802.11ac (VHT80)	Test Date	2022/12/1
Test Frequency	5610MHz	Polarization	Vertical
Temp	23°C	Hum.	59%

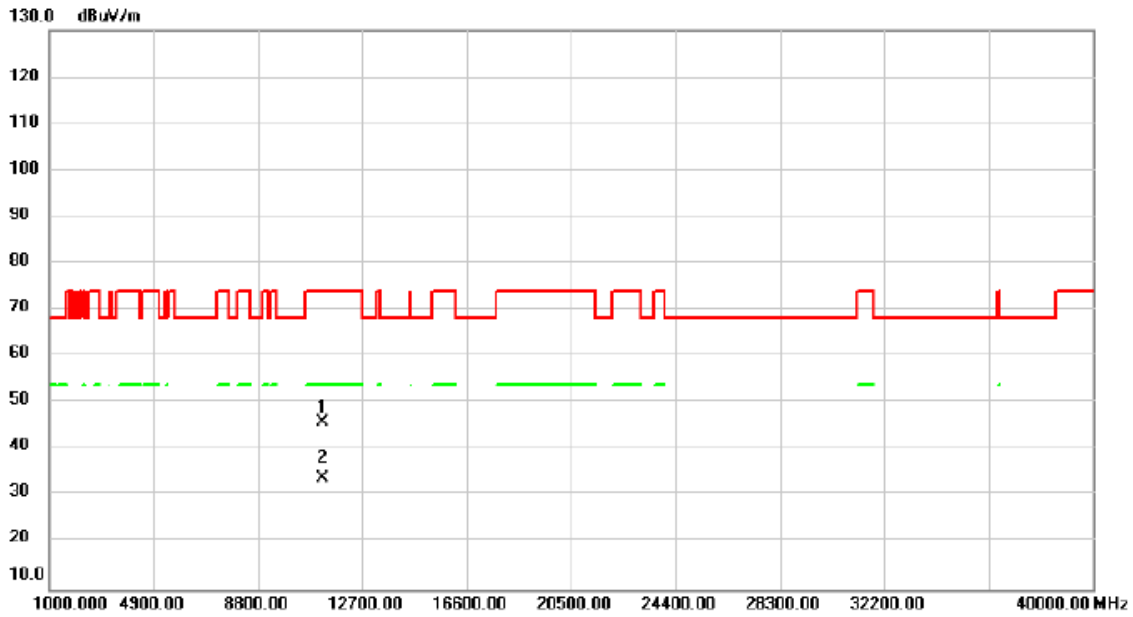

No.	Mk.	Freq. MHz	Reading Level dBuV	Correct Factor dB	Measure- ment dBuV/m	Limit dBuV/m	Over dB	Detector	Comment
1		11220.00	39.88	5.82	45.70	74.00	-28.30	peak	
2	*	11220.00	27.99	5.82	33.81	54.00	-20.19	AVG	

REMARKS:

- (1) Measurement Value = Reading Level + Correct Factor.
- (2) Margin Level = Measurement Value - Limit Value.

Test Mode	IEEE 802.11ac (VHT80)	Test Date	2022/12/1
Test Frequency	5610MHz	Polarization	Horizontal
Temp	23°C	Hum.	59%

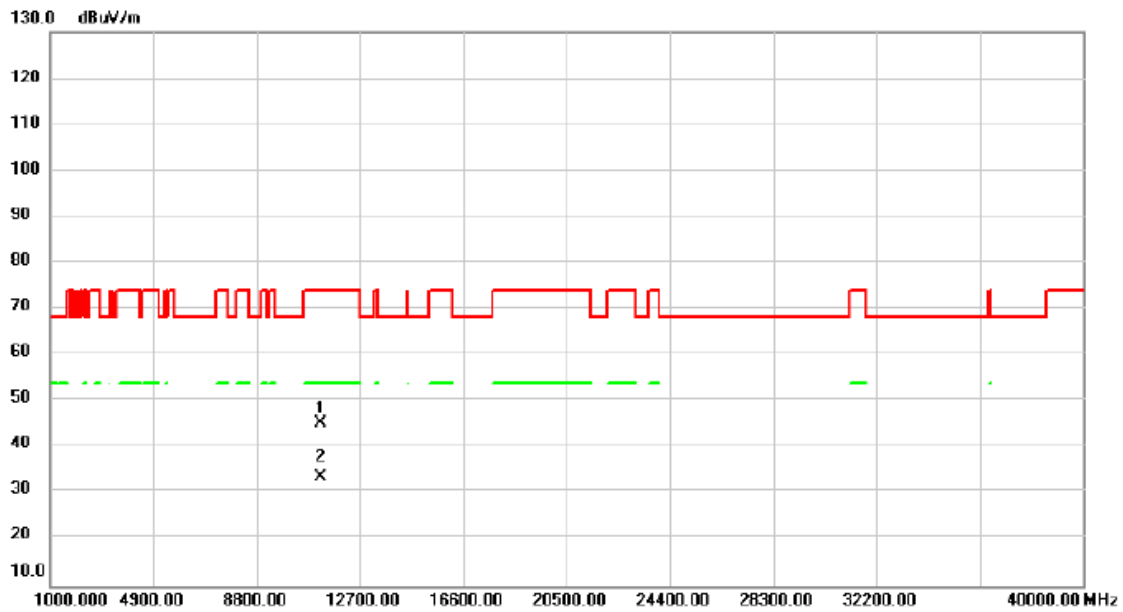

No.	Mk.	Freq.	Reading Level	Correct Factor	Measurement	Limit	Over	Detector	Comment
		MHz	dBuV	dB	dBuV/m	dBuV/m	dB		
1		11220.00	39.41	5.82	45.23	74.00	-28.77	peak	
2	*	11220.00	27.84	5.82	33.66	54.00	-20.34	AVG	

REMARKS:

- (1) Measurement Value = Reading Level + Correct Factor.
- (2) Margin Level = Measurement Value - Limit Value.

Test Mode	IEEE 802.11ac (VHT80)	Test Date	2022/12/1
Test Frequency	5775MHz	Polarization	Vertical
Temp	23°C	Hum.	59%

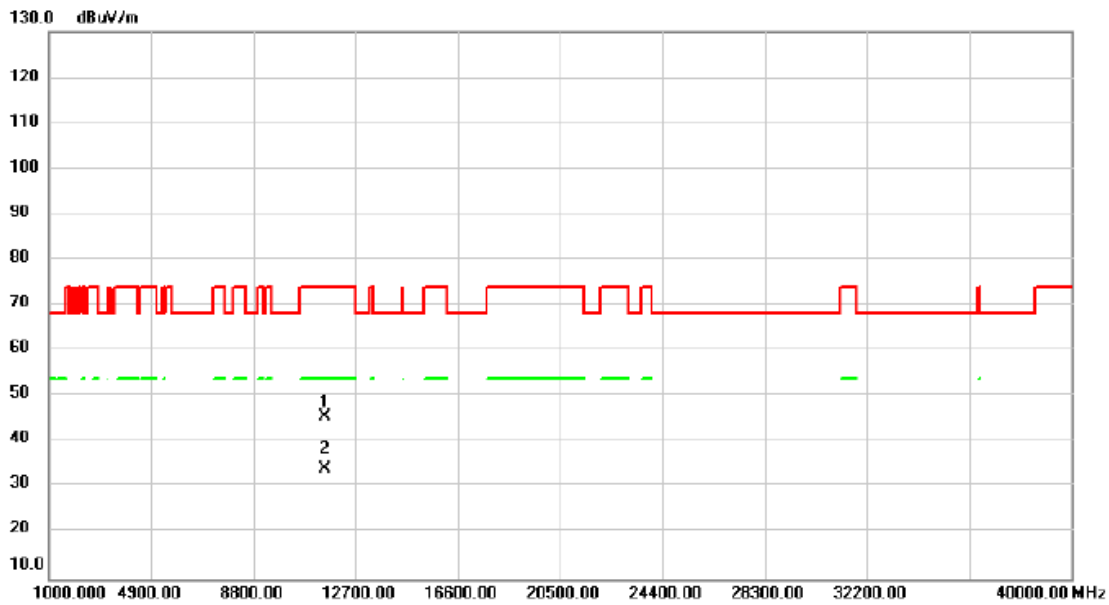

No.	Mk.	Freq.	Reading Level	Correct Factor	Measurement	Limit	Over	Detector	Comment
		MHz	dBuV	dB	dBuV/m	dBuV/m	dB		
1		11550.00	39.31	6.31	45.62	74.00	-28.38	peak	
2	*	11550.00	27.74	6.31	34.05	54.00	-19.95	AVG	

REMARKS:

- (1) Measurement Value = Reading Level + Correct Factor.
- (2) Margin Level = Measurement Value - Limit Value.

Test Mode	IEEE 802.11ac (VHT80)	Test Date	2022/12/1
Test Frequency	5775MHz	Polarization	Horizontal
Temp	23°C	Hum.	59%

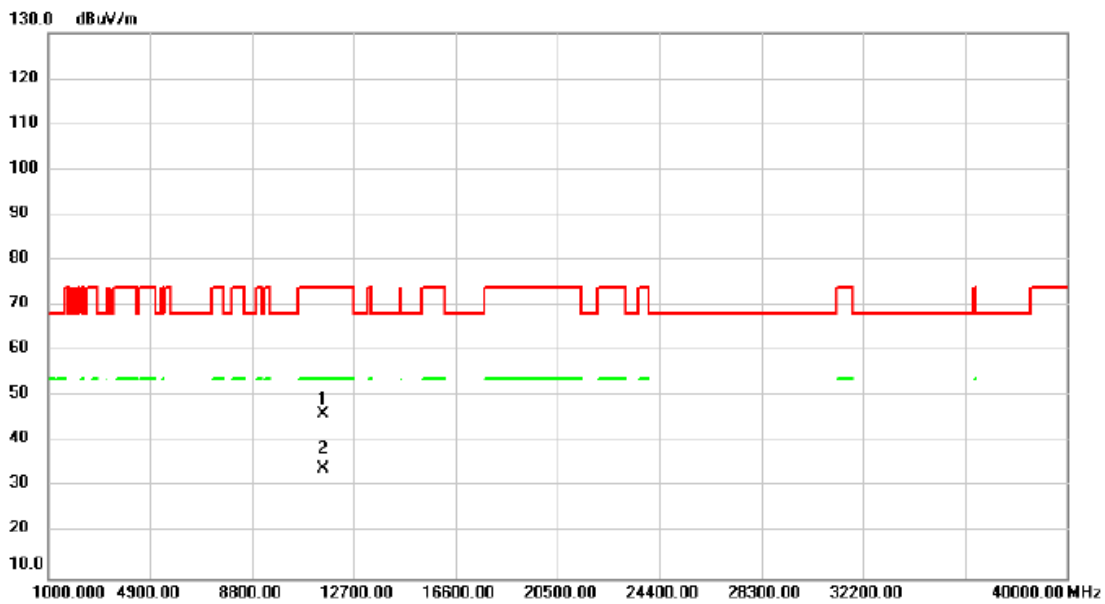

No.	Mk.	Freq.	Reading Level	Correct Factor	Measurement	Limit	Over	Detector	Comment
		MHz	dBuV	dB	dBuV/m	dBuV/m	dB		
1		11550.00	39.86	6.31	46.17	74.00	-27.83	peak	
2	*	11550.00	27.73	6.31	34.04	54.00	-19.96	AVG	

REMARKS:

- (1) Measurement Value = Reading Level + Correct Factor.
- (2) Margin Level = Measurement Value - Limit Value.

Test Mode	IEEE 802.11ax (HE160)	Test Date	2022/12/1
Test Frequency	5250MHz	Polarization	Vertical
Temp	23°C	Hum.	59%

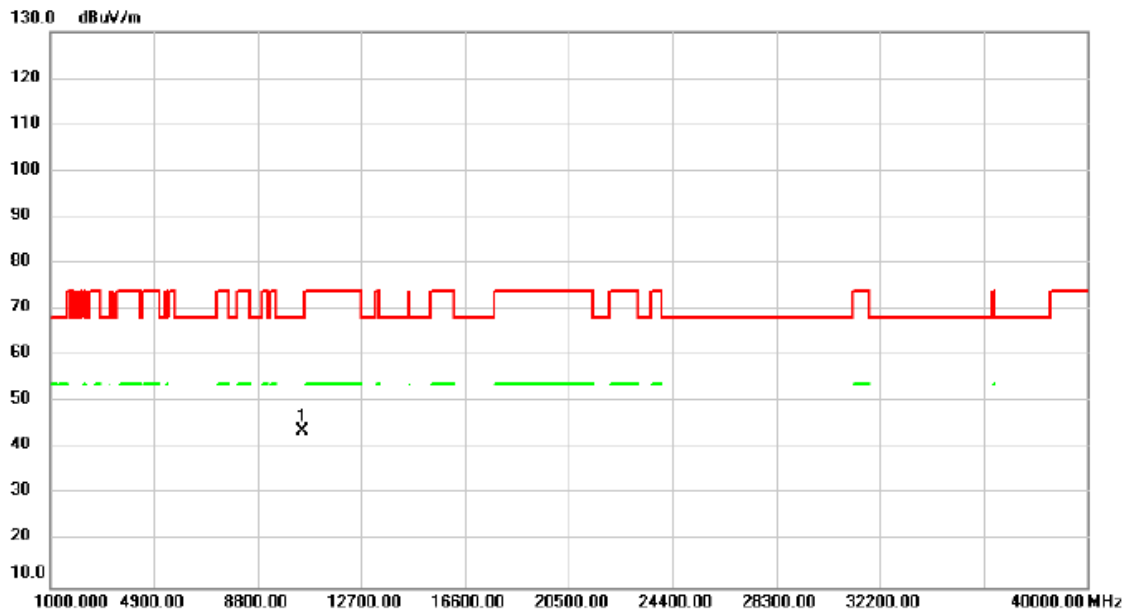

No.	Mk.	Freq.	Reading Level	Correct Factor	Measurement	Limit	Over	Detector	Comment
		MHz	dBuV	dB	dBuV/m	dBuV/m	dB		
1	*	10500.00	38.12	5.73	43.85	68.20	-24.35	peak	

REMARKS:

- (1) Measurement Value = Reading Level + Correct Factor.
- (2) Margin Level = Measurement Value - Limit Value.

Test Mode	IEEE 802.11ax (HE160)	Test Date	2022/12/1
Test Frequency	5250MHz	Polarization	Horizontal
Temp	23°C	Hum.	59%

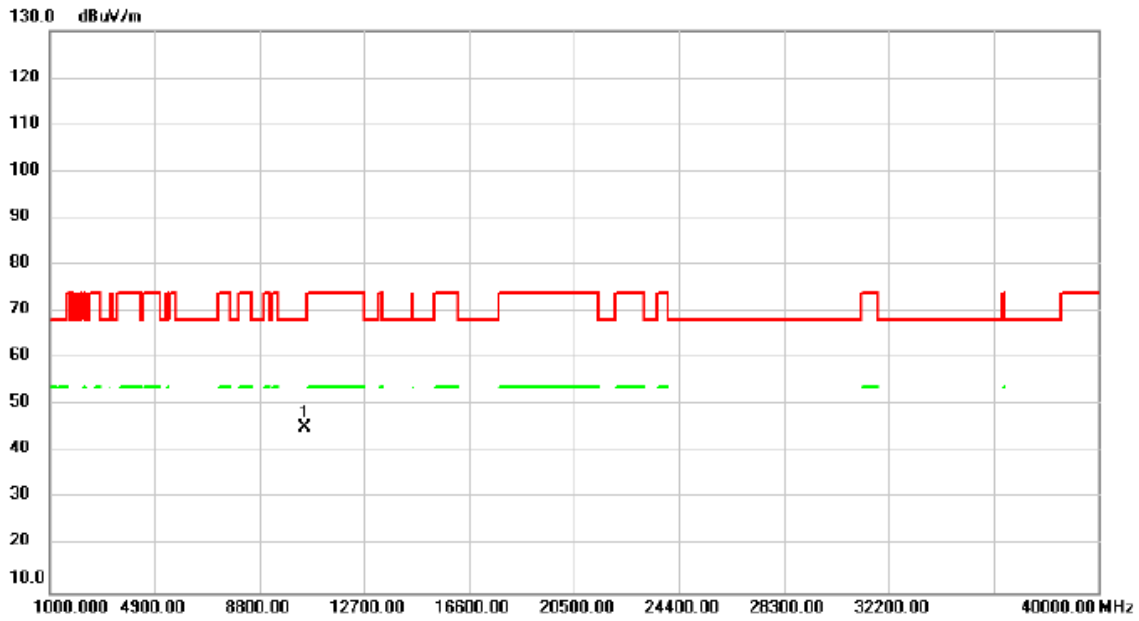

No.	Mk.	Freq.	Reading Level	Correct Factor	Measurement	Limit	Over	Detector	Comment
		MHz	dBuV	dB	dBuV/m	dBuV/m	dB		
1	*	10500.00	39.44	5.73	45.17	68.20	-23.03	peak	

REMARKS:

- (1) Measurement Value = Reading Level + Correct Factor.
- (2) Margin Level = Measurement Value - Limit Value.

Test Mode	IEEE 802.11ax (HE160)	Test Date	2022/12/1
Test Frequency	5570MHz	Polarization	Vertical
Temp	23°C	Hum.	59%

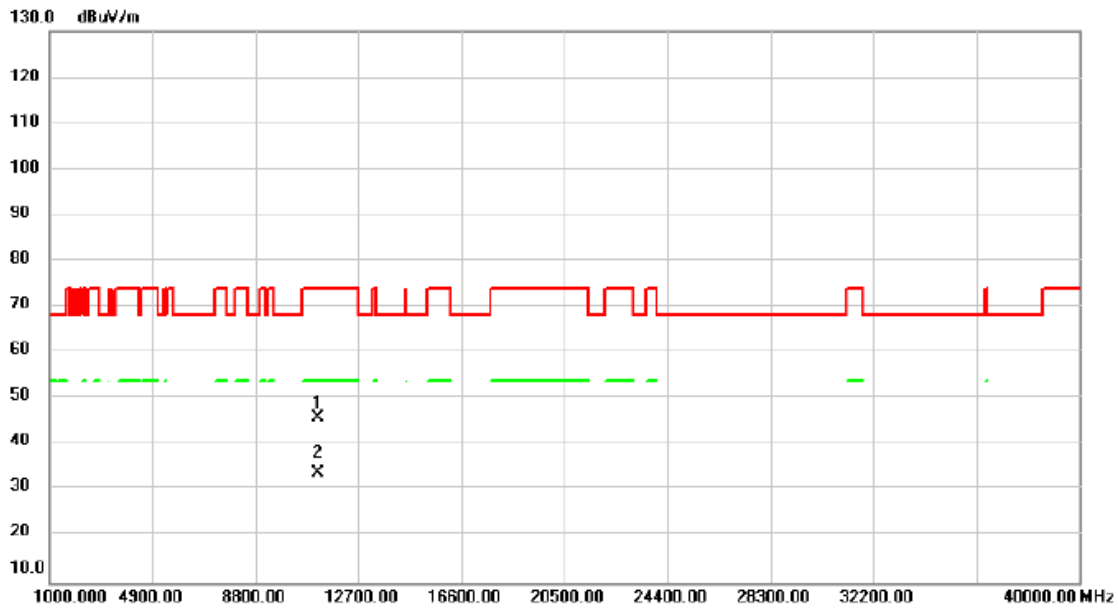

No.	Mk.	Freq.	Reading Level	Correct Factor	Measurement	Limit	Over	Detector	Comment
		MHz	dBuV	dB	dBuV/m	dBuV/m	dB		
1		11140.00	40.30	5.69	45.99	74.00	-28.01	peak	
2	*	11140.00	28.15	5.69	33.84	54.00	-20.16	AVG	

REMARKS:

- (1) Measurement Value = Reading Level + Correct Factor.
- (2) Margin Level = Measurement Value - Limit Value.

Test Mode	IEEE 802.11ax (HE160)	Test Date	2022/12/1
Test Frequency	5570MHz	Polarization	Horizontal
Temp	23°C	Hum.	59%

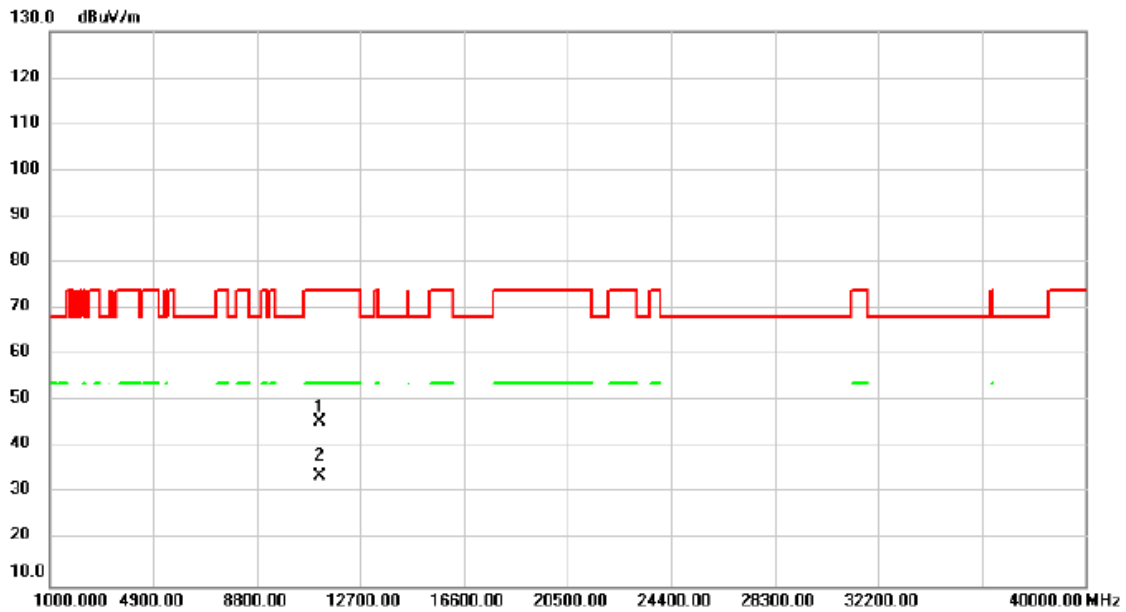

No.	Mk.	Freq.	Reading Level	Correct Factor	Measurement	Limit	Over	Detector	Comment
		MHz	dBuV	dB	dBuV/m	dBuV/m	dB		
1		11140.00	39.86	5.69	45.55	74.00	-28.45	peak	
2	*	11140.00	28.06	5.69	33.75	54.00	-20.25	AVG	

REMARKS:

- (1) Measurement Value = Reading Level + Correct Factor.
- (2) Margin Level = Measurement Value - Limit Value.

APPENDIX D CONDUCTED OUTPUT POWER

For Main

Test Mode	IEEE 802.11a	Tested Date	2022/11/25
-----------	--------------	-------------	------------

Test Frequency (MHz)	Conducted Power (dBm)	Conducted Power (W)	Max. Limit (dBm)	Max. Limit (W)	Result
5180	17.93	0.0621	23.98	0.2500	Pass
5200	20.07	0.1016	23.98	0.2500	Pass
5240	20.16	0.1038	23.98	0.2500	Pass
5260	20.50	0.1122	23.98	0.2500	Pass
5300	20.62	0.1153	23.98	0.2500	Pass
5320	18.57	0.0719	23.98	0.2500	Pass
5500	19.99	0.0998	23.98	0.2500	Pass
5580	20.75	0.1189	23.98	0.2500	Pass
5700	20.03	0.1007	23.98	0.2500	Pass
5745	20.84	0.1213	30.00	1.0000	Pass
5785	20.80	0.1202	30.00	1.0000	Pass
5825	20.68	0.1169	30.00	1.0000	Pass

For AUX

Test Mode	IEEE 802.11a	Tested Date	2022/11/25
-----------	--------------	-------------	------------

Test Frequency (MHz)	Conducted Power (dBm)	Conducted Power (W)	Max. Limit (dBm)	Max. Limit (W)	Result
5180	19.47	0.0885	23.98	0.2500	Pass
5200	20.21	0.1050	23.98	0.2500	Pass
5240	20.17	0.1040	23.98	0.2500	Pass
5260	20.62	0.1153	23.98	0.2500	Pass
5300	20.78	0.1197	23.98	0.2500	Pass
5320	20.06	0.1014	23.98	0.2500	Pass
5500	20.09	0.1021	23.98	0.2500	Pass
5580	20.70	0.1175	23.98	0.2500	Pass
5700	20.07	0.1016	23.98	0.2500	Pass
5745	20.91	0.1233	30.00	1.0000	Pass
5785	20.64	0.1159	30.00	1.0000	Pass
5825	20.75	0.1189	30.00	1.0000	Pass

For MIMO

Test Mode	IEEE 802.11n (HT20)_ Main	Tested Date	2022/11/25
-----------	---------------------------	-------------	------------

Test Frequency (MHz)	Conducted Power (dBm)	Conducted Power (W)	Max. Limit (dBm)	Max. Limit (W)	Result
5180	16.59	0.0456	23.98	0.2500	Pass
5200	16.88	0.0488	23.98	0.2500	Pass
5240	16.94	0.0494	23.98	0.2500	Pass
5260	18.08	0.0643	23.98	0.2500	Pass
5300	18.12	0.0649	23.98	0.2500	Pass
5320	17.08	0.0511	23.98	0.2500	Pass
5500	18.15	0.0653	23.98	0.2500	Pass
5580	18.09	0.0644	23.98	0.2500	Pass
5700	17.92	0.0619	23.98	0.2500	Pass
5745	20.19	0.1045	30.00	1.0000	Pass
5785	20.39	0.1094	30.00	1.0000	Pass
5825	20.36	0.1086	30.00	1.0000	Pass

Test Mode	IEEE 802.11n (HT20)_ Aux	Tested Date	2022/11/25
-----------	--------------------------	-------------	------------

Test Frequency (MHz)	Conducted Power (dBm)	Conducted Power (W)	Max. Limit (dBm)	Max. Limit (W)	Result
5180	16.84	0.0483	23.98	0.2500	Pass
5200	17.35	0.0543	23.98	0.2500	Pass
5240	17.51	0.0564	23.98	0.2500	Pass
5260	18.21	0.0662	23.98	0.2500	Pass
5300	18.16	0.0655	23.98	0.2500	Pass
5320	17.23	0.0528	23.98	0.2500	Pass
5500	18.44	0.0698	23.98	0.2500	Pass
5580	18.53	0.0713	23.98	0.2500	Pass
5700	18.55	0.0716	23.98	0.2500	Pass
5745	20.67	0.1167	30.00	1.0000	Pass
5785	21.01	0.1262	30.00	1.0000	Pass
5825	20.74	0.1186	30.00	1.0000	Pass

Test Mode	IEEE 802.11n (HT20)_ Total	Tested Date	2022/11/25
-----------	----------------------------	-------------	------------

Test Frequency (MHz)	Conducted Power (dBm)	Conducted Power (W)	Max. Limit (dBm)	Max. Limit (W)	Result
5180	19.73	0.0939	23.98	0.2500	Pass
5200	20.13	0.1031	23.98	0.2500	Pass
5240	20.24	0.1058	23.98	0.2500	Pass
5260	21.16	0.1305	23.98	0.2500	Pass
5300	21.15	0.1303	23.98	0.2500	Pass
5320	20.17	0.1039	23.98	0.2500	Pass
5500	21.31	0.1351	23.98	0.2500	Pass
5580	21.33	0.1357	23.98	0.2500	Pass
5700	21.26	0.1336	23.98	0.2500	Pass
5745	23.45	0.2212	30.00	1.0000	Pass
5785	23.72	0.2356	30.00	1.0000	Pass
5825	23.56	0.2272	30.00	1.0000	Pass

Test Mode	IEEE 802.11n (HT40) _Main	Tested Date	2022/11/25
-----------	---------------------------	-------------	------------

Test Frequency (MHz)	Conducted Power (dBm)	Conducted Power (W)	Max. Limit (dBm)	Max. Limit (W)	Result
5190	16.04	0.0402	23.98	0.2500	Pass
5230	16.71	0.0469	23.98	0.2500	Pass
5270	17.45	0.0556	23.98	0.2500	Pass
5310	16.22	0.0419	23.98	0.2500	Pass
5510	17.12	0.0515	23.98	0.2500	Pass
5550	20.41	0.1099	23.98	0.2500	Pass
5670	19.43	0.0877	23.98	0.2500	Pass
5755	19.78	0.0951	30.00	1.0000	Pass
5795	20.48	0.1117	30.00	1.0000	Pass

Test Mode	IEEE 802.11n (HT40) _Aux	Tested Date	2022/11/25
-----------	--------------------------	-------------	------------

Test Frequency (MHz)	Conducted Power (dBm)	Conducted Power (W)	Max. Limit (dBm)	Max. Limit (W)	Result
5190	16.15	0.0412	23.98	0.2500	Pass
5230	17.32	0.0540	23.98	0.2500	Pass
5270	17.60	0.0575	23.98	0.2500	Pass
5310	16.18	0.0415	23.98	0.2500	Pass
5510	17.26	0.0532	23.98	0.2500	Pass
5550	20.92	0.1236	23.98	0.2500	Pass
5670	20.05	0.1012	23.98	0.2500	Pass
5755	20.47	0.1114	30.00	1.0000	Pass
5795	20.84	0.1213	30.00	1.0000	Pass

Test Mode	IEEE 802.11n (HT40) _Total	Tested Date	2022/11/25
-----------	----------------------------	-------------	------------

Test Frequency (MHz)	Conducted Power (dBm)	Conducted Power (W)	Max. Limit (dBm)	Max. Limit (W)	Result
5190	19.11	0.0814	23.98	0.2500	Pass
5230	20.04	0.1008	23.98	0.2500	Pass
5270	20.54	0.1131	23.98	0.2500	Pass
5310	19.21	0.0834	23.98	0.2500	Pass
5510	20.20	0.1047	23.98	0.2500	Pass
5550	23.68	0.2335	23.98	0.2500	Pass
5670	22.76	0.1889	23.98	0.2500	Pass
5755	23.15	0.2065	30.00	1.0000	Pass
5795	23.67	0.2330	30.00	1.0000	Pass

Test Mode	IEEE 802.11ac (VHT80) _Main	Tested Date	2022/11/25
-----------	-----------------------------	-------------	------------

Test Frequency (MHz)	Conducted Power (dBm)	Conducted Power (W)	Max. Limit (dBm)	Max. Limit (W)	Result
5210	15.94	0.0393	23.98	0.2500	Pass
5290	16.20	0.0417	23.98	0.2500	Pass
5530	16.90	0.0490	23.98	0.2500	Pass
5610	19.93	0.0984	23.98	0.2500	Pass
5775	17.71	0.0590	30.00	1.0000	Pass

Test Mode	IEEE 802.11ac (VHT80) _Aux	Tested Date	2022/11/25
-----------	----------------------------	-------------	------------

Test Frequency (MHz)	Conducted Power (dBm)	Conducted Power (W)	Max. Limit (dBm)	Max. Limit (W)	Result
5210	16.44	0.0441	23.98	0.2500	Pass
5290	16.30	0.0427	23.98	0.2500	Pass
5530	17.20	0.0525	23.98	0.2500	Pass
5610	20.56	0.1138	23.98	0.2500	Pass
5775	18.21	0.0662	30.00	1.0000	Pass

Test Mode	IEEE 802.11ac (VHT80) _Total	Tested Date	2022/11/25
-----------	------------------------------	-------------	------------

Test Frequency (MHz)	Conducted Power (dBm)	Conducted Power (W)	Max. Limit (dBm)	Max. Limit (W)	Result
5210	19.21	0.0833	23.98	0.2500	Pass
5290	19.26	0.0843	23.98	0.2500	Pass
5530	20.06	0.1015	23.98	0.2500	Pass
5610	23.27	0.2122	23.98	0.2500	Pass
5775	20.98	0.1252	30.00	1.0000	Pass

Test Mode	IEEE 802.11ac (VHT160) _Main	Tested Date	2022/11/25
-----------	------------------------------	-------------	------------

Test Frequency (MHz)	Conducted Power (dBm)	Conducted Power (W)	Max. Limit (dBm)	Max. Limit (W)	Result
5250	12.84	0.0192	23.98	0.2500	Pass
5570	13.54	0.0226	23.98	0.2500	Pass

Test Mode	IEEE 802.11ac (VHT160) _Aux	Tested Date	2022/11/25
-----------	-----------------------------	-------------	------------

Test Frequency (MHz)	Conducted Power (dBm)	Conducted Power (W)	Max. Limit (dBm)	Max. Limit (W)	Result
5250	12.78	0.0190	23.98	0.2500	Pass
5570	14.26	0.0267	23.98	0.2500	Pass

Test Mode	IEEE 802.11ac (VHT160) _Total	Tested Date	2022/11/25
-----------	-------------------------------	-------------	------------

Test Frequency (MHz)	Conducted Power (dBm)	Conducted Power (W)	Max. Limit (dBm)	Max. Limit (W)	Result
5250	15.82	0.0382	23.98	0.2500	Pass
5570	16.93	0.0493	23.98	0.2500	Pass

Test Mode	IEEE 802.11ax (HE20) _Main	Tested Date	2022/11/25
-----------	----------------------------	-------------	------------

Test Frequency (MHz)	Conducted Power (dBm)	Conducted Power (W)	Max. Limit (dBm)	Max. Limit (W)	Result
5180	16.97	0.0498	23.98	0.2500	Pass
5200	16.95	0.0495	23.98	0.2500	Pass
5240	16.96	0.0497	23.98	0.2500	Pass
5260	18.33	0.0681	23.98	0.2500	Pass
5300	18.30	0.0676	23.98	0.2500	Pass
5320	16.55	0.0452	23.98	0.2500	Pass
5500	18.21	0.0662	23.98	0.2500	Pass
5580	18.41	0.0693	23.98	0.2500	Pass
5700	17.97	0.0627	23.98	0.2500	Pass
5745	20.37	0.1089	30.00	1.0000	Pass
5785	20.48	0.1117	30.00	1.0000	Pass
5825	20.49	0.1119	30.00	1.0000	Pass

Test Mode	IEEE 802.11ax (HE20) _Aux	Tested Date	2022/11/25
-----------	---------------------------	-------------	------------

Test Frequency (MHz)	Conducted Power (dBm)	Conducted Power (W)	Max. Limit (dBm)	Max. Limit (W)	Result
5180	17.52	0.0565	23.98	0.2500	Pass
5200	17.47	0.0558	23.98	0.2500	Pass
5240	17.53	0.0566	23.98	0.2500	Pass
5260	18.55	0.0716	23.98	0.2500	Pass
5300	18.60	0.0724	23.98	0.2500	Pass
5320	16.72	0.0470	23.98	0.2500	Pass
5500	18.61	0.0726	23.98	0.2500	Pass
5580	18.85	0.0767	23.98	0.2500	Pass
5700	18.82	0.0762	23.98	0.2500	Pass
5745	21.18	0.1312	30.00	1.0000	Pass
5785	20.97	0.1250	30.00	1.0000	Pass
5825	21.12	0.1294	30.00	1.0000	Pass

Test Mode	IEEE 802.11ax (HE20) _Total	Tested Date	2022/11/25
-----------	-----------------------------	-------------	------------

Test Frequency (MHz)	Conducted Power (dBm)	Conducted Power (W)	Max. Limit (dBm)	Max. Limit (W)	Result
5180	20.26	0.1063	23.98	0.2500	Pass
5200	20.23	0.1054	23.98	0.2500	Pass
5240	20.26	0.1063	23.98	0.2500	Pass
5260	21.45	0.1397	23.98	0.2500	Pass
5300	21.46	0.1401	23.98	0.2500	Pass
5320	19.65	0.0922	23.98	0.2500	Pass
5500	21.42	0.1388	23.98	0.2500	Pass
5580	21.65	0.1461	23.98	0.2500	Pass
5700	21.43	0.1389	23.98	0.2500	Pass
5745	23.80	0.2401	30.00	1.0000	Pass
5785	23.74	0.2367	30.00	1.0000	Pass
5825	23.83	0.2414	30.00	1.0000	Pass

Test Mode	IEEE 802.11ax (HE40) _Main	Tested Date	2022/11/25
-----------	----------------------------	-------------	------------

Test Frequency (MHz)	Conducted Power (dBm)	Conducted Power (W)	Max. Limit (dBm)	Max. Limit (W)	Result
5190	14.83	0.0304	23.98	0.2500	Pass
5230	16.71	0.0469	23.98	0.2500	Pass
5270	19.67	0.0927	23.98	0.2500	Pass
5310	15.38	0.0345	23.98	0.2500	Pass
5510	16.63	0.0460	23.98	0.2500	Pass
5550	20.32	0.1076	23.98	0.2500	Pass
5670	19.36	0.0863	23.98	0.2500	Pass
5755	19.69	0.0931	30.00	1.0000	Pass
5795	20.60	0.1148	30.00	1.0000	Pass

Test Mode	IEEE 802.11ax (HE40) _Aux	Tested Date	2022/11/25
-----------	---------------------------	-------------	------------

Test Frequency (MHz)	Conducted Power (dBm)	Conducted Power (W)	Max. Limit (dBm)	Max. Limit (W)	Result
5190	15.52	0.0356	23.98	0.2500	Pass
5230	17.22	0.0527	23.98	0.2500	Pass
5270	20.04	0.1009	23.98	0.2500	Pass
5310	15.72	0.0373	23.98	0.2500	Pass
5510	16.94	0.0494	23.98	0.2500	Pass
5550	20.80	0.1202	23.98	0.2500	Pass
5670	20.05	0.1012	23.98	0.2500	Pass
5755	20.09	0.1021	30.00	1.0000	Pass
5795	21.11	0.1291	30.00	1.0000	Pass

Test Mode	IEEE 802.11ax (HE40) _Total	Tested Date	2022/11/25
-----------	-----------------------------	-------------	------------

Test Frequency (MHz)	Conducted Power (dBm)	Conducted Power (W)	Max. Limit (dBm)	Max. Limit (W)	Result
5190	18.20	0.0661	23.98	0.2500	Pass
5230	19.98	0.0996	23.98	0.2500	Pass
5270	22.87	0.1936	23.98	0.2500	Pass
5310	18.56	0.0718	23.98	0.2500	Pass
5510	19.80	0.0955	23.98	0.2500	Pass
5550	23.58	0.2279	23.98	0.2500	Pass
5670	22.73	0.1875	23.98	0.2500	Pass
5755	22.90	0.1952	30.00	1.0000	Pass
5795	23.87	0.2439	30.00	1.0000	Pass

Test Mode	IEEE 802.11ax (HE80) _Aux	Tested Date	2022/11/25
-----------	---------------------------	-------------	------------

Test Frequency (MHz)	Conducted Power (dBm)	Conducted Power (W)	Max. Limit (dBm)	Max. Limit (W)	Result
5210	15.87	0.0386	23.98	0.2500	Pass
5290	15.67	0.0369	23.98	0.2500	Pass
5530	18.75	0.0750	23.98	0.2500	Pass
5610	19.77	0.0948	23.98	0.2500	Pass
5775	17.77	0.0598	30.00	1.0000	Pass

Test Mode	IEEE 802.11ax (HE80) _Main	Tested Date	2022/11/25
-----------	----------------------------	-------------	------------

Test Frequency (MHz)	Conducted Power (dBm)	Conducted Power (W)	Max. Limit (dBm)	Max. Limit (W)	Result
5210	16.26	0.0423	23.98	0.2500	Pass
5290	15.69	0.0371	23.98	0.2500	Pass
5530	19.11	0.0815	23.98	0.2500	Pass
5610	20.44	0.1107	23.98	0.2500	Pass
5775	18.25	0.0668	30.00	1.0000	Pass

Test Mode	IEEE 802.11ax (HE80) _Total	Tested Date	2022/11/25
-----------	-----------------------------	-------------	------------

Test Frequency (MHz)	Conducted Power (dBm)	Conducted Power (W)	Max. Limit (dBm)	Max. Limit (W)	Result
5210	19.08	0.0809	23.98	0.2500	Pass
5290	18.69	0.0740	23.98	0.2500	Pass
5530	21.94	0.1565	23.98	0.2500	Pass
5610	23.13	0.2055	23.98	0.2500	Pass
5775	21.03	0.1267	30.00	1.0000	Pass

Test Mode	IEEE 802.11ax (HE160) _Main	Tested Date	2022/11/25
-----------	-----------------------------	-------------	------------

Test Frequency (MHz)	Conducted Power (dBm)	Conducted Power (W)	Max. Limit (dBm)	Max. Limit (W)	Result
5250	12.78	0.0190	23.98	0.2500	Pass
5570	14.66	0.0292	23.98	0.2500	Pass

Test Mode	IEEE 802.11ax (HE160) _Aux	Tested Date	2022/11/25
-----------	----------------------------	-------------	------------

Test Frequency (MHz)	Conducted Power (dBm)	Conducted Power (W)	Max. Limit (dBm)	Max. Limit (W)	Result
5250	12.99	0.0199	23.98	0.2500	Pass
5570	15.02	0.0318	23.98	0.2500	Pass

Test Mode	IEEE 802.11ax (HE160) _Total	Tested Date	2022/11/25
-----------	------------------------------	-------------	------------

Test Frequency (MHz)	Conducted Power (dBm)	Conducted Power (W)	Max. Limit (dBm)	Max. Limit (W)	Result
5250	15.90	0.0389	23.98	0.2500	Pass
5570	17.85	0.0610	23.98	0.2500	Pass

End of Test Report