

FCC Radio Test Report

FCC ID: RWO-RZ090484

This report concerns: **Class II Permissive Change**

Report No. : BTL-FCCP-3-2208C205
Equipment : Notebook PC
Model Name : RZ09-0484
Brand Name : RAZER
Applicant : Razer Inc.
Address : 9 Pasteur, Suite 100, Irvine, CA92618, USA.
Manufacturer : Razer Inc.
Address : 9 Pasteur, Suite 100, Irvine, CA92618, USA.

Radio Function : WLAN 2.4 GHz

FCC Rule Part(s) : FCC CFR Title 47, Part 15, Subpart C (15.247)
Measurement : ANSI C63.10-2013
Procedure(s)

Date of Receipt : 2022/10/18
Date of Test : 2022/11/23~2022/12/16
Issued Date : 2022/12/22

The above equipment has been tested and found in compliance with the requirement of the above standards by BTL Inc.

Prepared by : Eric Lee
Eric Lee, Engineer

Approved by : Jerry Chuang
Jerry Chuang, Supervisor

**BTL Inc.**

No.18, Ln. 171, Sec. 2, Jiuzong Rd., Neihu Dist., Taipei City 114, Taiwan

Tel: +886-2-2657-3299 Fax: +886-2-2657-3331 Web: www.newbtl.com Service mail: btl_qa@newbtl.com

Declaration

BTL represents to the client that testing is done in accordance with standard procedures as applicable and that test instruments used has been calibrated with standards traceable to international standard(s) and/or national standard(s).

BTL's reports apply only to the specific samples tested under conditions. It is manufacture's responsibility to ensure that additional production units of this model are manufactured with the identical electrical and mechanical components. **BTL** shall have no liability for any declarations, inferences or generalizations drawn by the client or others from **BTL** issued reports.

This report is the confidential property of the client. As a mutual protection to the clients, the public and ourselves, the test report shall not be reproduced, except in full, without our written approval.

BTL's laboratory quality assurance procedures are in compliance with the **ISO/IEC 17025** requirements, and accredited by the conformity assessment authorities listed in this test report.

BTL is not responsible for the sampling stage, so the results only apply to the sample as received.

The information, data and test plan are provided by manufacturer which may affect the validity of results, so it is manufacturer's responsibility to ensure that the apparatus meets the essential requirements of applied standards and in all the possible configurations as representative of its intended use.

Limitation

For the use of the authority's logo is limited unless the Test Standard(s)/Scope(s)/Item(s) mentioned in this test report is (are) included in the conformity assessment authorities acceptance respective.

Please note that the measurement uncertainty is provided for informational purpose only and are not use in determining the Pass/Fail results.

CONTENTS

REVISION HISTORY	4
1 SUMMARY OF TEST RESULTS	5
1.1 TEST FACILITY	6
1.2 MEASUREMENT UNCERTAINTY	6
1.3 TEST ENVIRONMENT CONDITIONS	7
1.4 TABLE OF PARAMETERS OF TEXT SOFTWARE SETTING	7
2 GENERAL INFORMATION	8
2.1 DESCRIPTION OF EUT	8
2.2 TEST MODES	10
2.3 BLOCK DIAGRAM SHOWING THE CONFIGURATION OF SYSTEM TESTED	11
2.4 SUPPORT UNITS	12
3 AC POWER LINE CONDUCTED EMISSIONS TEST	13
3.1 LIMIT	13
3.2 TEST PROCEDURE	13
3.3 DEVIATION FROM TEST STANDARD	13
3.4 TEST SETUP	14
3.5 TEST RESULT	14
4 RADIATED EMISSIONS TEST	15
4.1 LIMIT	15
4.2 TEST PROCEDURE	16
4.3 DEVIATION FROM TEST STANDARD	16
4.4 TEST SETUP	16
4.5 EUT OPERATING CONDITIONS	17
4.6 TEST RESULT – BELOW 30 MHZ	18
4.7 TEST RESULT – 30 MHZ TO 1 GHZ	18
4.8 TEST RESULT – ABOVE 1 GHZ	18
5 OUTPUT POWER TEST	19
5.1 LIMIT	19
5.2 TEST PROCEDURE	19
5.3 DEVIATION FROM TEST STANDARD	19
5.4 TEST SETUP	19
5.5 EUT OPERATING CONDITIONS	19
5.6 TEST RESULT	19
6 LIST OF MEASURING EQUIPMENTS	20
7 EUT TEST PHOTO	21
8 EUT PHOTOS	21
APPENDIX A AC POWER LINE CONDUCTED EMISSIONS	22
APPENDIX B RADIATED EMISSIONS - 30 MHZ TO 1 GHZ	27
APPENDIX C RADIATED EMISSIONS - ABOVE 1 GHZ	30
APPENDIX D OUTPUT POWER	37

REVISION HISTORY

Report No.	Version	Description	Issued Date	Note
BTL-FCCP-3-2208C205	R00	Original Report.	2022/12/22	Valid

1 SUMMARY OF TEST RESULTS

Test procedures according to the technical standards.

Standard(s) Section	Description	Test Result	Judgement	Remark
15.207	AC Power Line Conducted Emissions	APPENDIX A	Pass	-----
15.205 15.209 15.247(d)	Radiated Emissions	APPENDIX B APPENDIX C	Pass	-----
15.247(a)	Bandwidth	-----	-----	-----
15.247(b)	Output Power	APPENDIX D	Pass	-----
15.247(e)	Power Spectral Density	-----	-----	-----
15.247(d)	Antenna conducted Spurious Emission	-----	-----	-----
15.203	Antenna Requirement	-----	-----	-----

NOTE:

- (1) "N/A" denotes test is not applicable in this Test Report.
- (2) The report format version is TP.1.1.1.
- (3) The antenna gain of EUT is smaller than that of the module. So in this report the worst cases of radiated spurious emissions and AC Power Line Conducted Emissions were evaluated and recorded. And evaluated the output power items and recorded in the report. For the test results of all other test items please refer to module test reports.

1.1 TEST FACILITY

The test facilities used to collect the test data in this report:

No. 72, Ln. 169, Sec. 2, Datong Rd., Xizhi Dist., New Taipei City 221, Taiwan

The test sites and facilities are covered under FCC RN: 674415 and DN: TW0659.

C06 CB21 CB22

No. 68-1, Ln. 169, Sec. 2, Datong Rd., Xizhi Dist., New Taipei City 221, Taiwan

The test sites and facilities are covered under FCC RN: 674415 and DN: TW0659.

C05 CB08 CB11 CB15 CB16
 SR10

1.2 MEASUREMENT UNCERTAINTY

The reported uncertainty of measurement $y \pm U$, where expanded uncertainty U is based on a standard uncertainty multiplied by a coverage factor of $k = 2$, providing a level of confidence of approximately **95 %**.

The measurement instrumentation uncertainty considerations contained in CISPR 16-4-2. The BTL measurement uncertainty is less than the CISPR 16-4-2 U_{cispr} requirement.

A. AC power line conducted emissions test:

Test Site	Method	Measurement Frequency Range	U (dB)
C05	CISPR	150 kHz ~ 30MHz	3.44

B. Radiated emissions test:

Test Site	Measurement Frequency Range	U,(dB)
CB21	0.03 GHz ~ 0.2 GHz	4.17
	0.2 GHz ~ 1 GHz	4.72
	1 GHz ~ 6 GHz	5.21
	6 GHz ~ 18 GHz	5.51
	18 GHz ~ 26 GHz	3.69
	26 GHz ~ 40 GHz	4.23

C. Conducted test:

Test Item	U,(dB)
Output power	0.3669

NOTE:

Unless specifically mentioned, the uncertainty of measurement has not been taken into account to declare the compliance or non-compliance to the specification.

1.3 TEST ENVIRONMENT CONDITIONS

Test Item	Environment Condition	Test Voltage	Tested by
AC Power Line Conducted Emissions	23°C, 58%	AC 120 V	Jay Tien
Radiated emissions below 1 GHz	23°C, 59%	AC 120 V	Mark Luo
Radiated emissions above 1 GHz	23°C, 59%	AC 120 V	Mark Luo
Output Power	22.6°C, 52%	AC 120 V	Angela Wang

1.4 TABLE OF PARAMETERS OF TEXT SOFTWARE SETTING

Main Ant.						
Test Software	DRTU V02999.22.180.0					
Mode	2412 MHz	2437 MHz	2462 MHz	2467MHz	2472MHz	Data Rate
IEEE 802.11b	19.5	23	22.125	17.25	14.25	1 Mbps
IEEE 802.11g	17.75	23	17.75	15.25	11.75	6 Mbps

Aux Ant.						
Test Software	DRTU V02999.22.180.0					
Mode	2412 MHz	2437 MHz	2462 MHz	2467MHz	2472MHz	Data Rate
IEEE 802.11b	19.5	23	22.125	17.25	14.25	1 Mbps
IEEE 802.11g	17.75	23	17.75	15.25	11.75	6 Mbps

MIMO						
Test Software	DRTU V02999.22.180.0					
Mode	2412 MHz	2437 MHz	2462 MHz	2467 MHz	2472 MHz	Data Rate
IEEE 802.11n (HT20)	16	23	18.5	14.25	12.25	HT 0
IEEE 802.11ax (HE20)	18.5	23	18.5	12	9.75	HE 0
Mode	2422 MHz	2437 MHz	2452 MHz	2457 MHz	2462 MHz	Data Rate
IEEE 802.11n (HT40)	15	17.75	14.25	8.25	9.125	HT 0
IEEE 802.11ax (HE40)	15	18.25	15	10.75	9.25	HE 0

2 GENERAL INFORMATION

2.1 DESCRIPTION OF EUT

Equipment	Notebook PC
Model Name	RAZER
Brand Name	RZ09-0484
Model Difference	N/A
Power Source	1# DC voltage supplied from AC adapter. 1)Model: RC30-0484 2)Model: RC30-042 2# Supplied from battery. Model: RC30-0484
Power Rating	1# 1) I/P: 100-240V~ 4.5A 50/60Hz O/P: 19.5V===16.92A TOTAL 330W 2) I/P: 100-240V~ 4A MAX 50/60Hz O/P: 19.5V=== 14.36A TOTAL 280.0W 2# DC 15.4V, 5955mAh, 91.7Wh
Products Covered	2* Power Adapter 1* AC Cable
Operation Band	2400 MHz ~ 2483.5 MHz
Operation Frequency	2412 MHz ~ 2472 MHz
Modulation Technology	IEEE 802.11b: DSSS IEEE 802.11g: OFDM IEEE 802.11n: OFDM IEEE 802.11ax: OFDMA
Transfer Rate	IEEE 802.11b: 11/5.5/2/1 Mbps IEEE 802.11g: 54/48/36/24/18/12/9/6 Mbps IEEE 802.11n: up to 300 Mbps IEEE 802.11ax: up to 573.6 Mbps
Max. e.i.r.p.	For Main: IEEE 802.11b: 23.58 dBm (0.2280 W) IEEE 802.11g: 24.29 dBm (0.2685 W) For Aux: IEEE 802.11b: 23.96 dBm (0.2489 W) IEEE 802.11g: 24.61 dBm (0.2891 W) For MIMO: IEEE 802.11n(HT20): 27.07 dBm (0.5089 W) IEEE 802.11n(HT40): 25.71 dBm (0.3724 W) IEEE 802.11ax(HE20): 26.87 dBm (0.4859 W) IEEE 802.11ax(HE40): 26.15 dBm (0.4121 W)
Test Model	RZ09-0484
Sample Status	Engineering Sample
EUT Modification(s)	N/A

NOTE:

(1) The above EUT information is declared by manufacturer and for more detailed features description, please refers to the manufacturer's specifications or user's manual.

(2) Channel List:

CH01 - CH13 for IEEE 802.11b, IEEE 802.11g, IEEE 802.11n(HT20), IEEE 802.11ax(HE20) CH03 - CH11 for IEEE 802.11n(HT40), IEEE 802.11ax(HE40)					
Channel	Frequency (MHz)	Channel	Frequency (MHz)	Channel	Frequency (MHz)
01	2412	06	2437	11	2462
02	2417	07	2442	12	2467
03	2422	08	2447	13	2472
04	2427	09	2452		
05	2432	10	2457		

(3) Table for Filed Antenna:

Ant.	Manufacturer	P/N	Type	Connector	Gain (dBi)
1	Amphenol Taiwan Corporation	BY5963-16-001-C	PIFA	N/A	2.20
2		BY5963-16-002-C	PIFA	N/A	2.37

Note:

- 1) This EUT supports MIMO 2X2, any transmit signals are uncorrelated with each other, so Directional gain = $10\log[(10^{G1/10} + 10^{G2/10} + \dots + 10^{GN/10})/N]$ dBi, that is Directional gain = $10\log[(10^{2.20/10} + 10^{2.37/10})/2]$ dBi = 2.29.
- 2) Ant.1 refers to main antenna, Ant.2 refers to aux antenna.
- 3) The AUX antenna connector of the module connected to the MAIN antenna of the EUT and the MAIN antenna connector of the module connected to the AUX antenna of the EUT.
- 4) The above Antenna information are derived from the antenna data sheet provided by manufacturer and for more detailed features description, please refer to the manufacturer's specifications, the laboratory shall not be held responsible.

2.2 TEST MODES

Test Items	Test mode	Channel	Note
AC power line conducted emissions	Normal/Idle	-	-
Transmitter Radiated Emissions (below 1GHz)	TX Mode_IEEE 802.11b	06	-
Transmitter Radiated Emissions (above 1GHz)	TX Mode_IEEE 802.11b	11	Bandedge
	TX Mode_IEEE 802.11ax (HE40)	09	
Transmitter Radiated Emissions (above 1GHz)	TX Mode_IEEE 802.11b	06	Harmonic
	TX Mode_IEEE 802.11ax (HE40)	06	
Output Power	TX Mode_IEEE 802.11b	01/06/11	-
	TX Mode_IEEE 802.11g		
	TX Mode_IEEE 802.11n (HT20)		
	TX Mode_IEEE 802.11ax (HE20)		
	TX Mode_IEEE 802.11n (HT40)	03/06/09	
	TX Mode_IEEE 802.11ax (HE40)		

NOTE:

- (1) For radiated emission band edge test, both Vertical and Horizontal are evaluated, but only the worst case (Vertical) is recorded.
- (2) This Notebook PC has two mainboards with two adapters. Both mainboard APF22003_MB (with adapter RC09-0484) and mainboard APF22003_MB2 (with adapter RC30-042) had been pre-tested and in this report only recorded the worst case.

2.3 BLOCK DIAGRAM SHOWING THE CONFIGURATION OF SYSTEM TESTED

Equipment letters and Cable numbers refer to item numbers described in the tables of clause 2.4.

AC power line conducted emissions

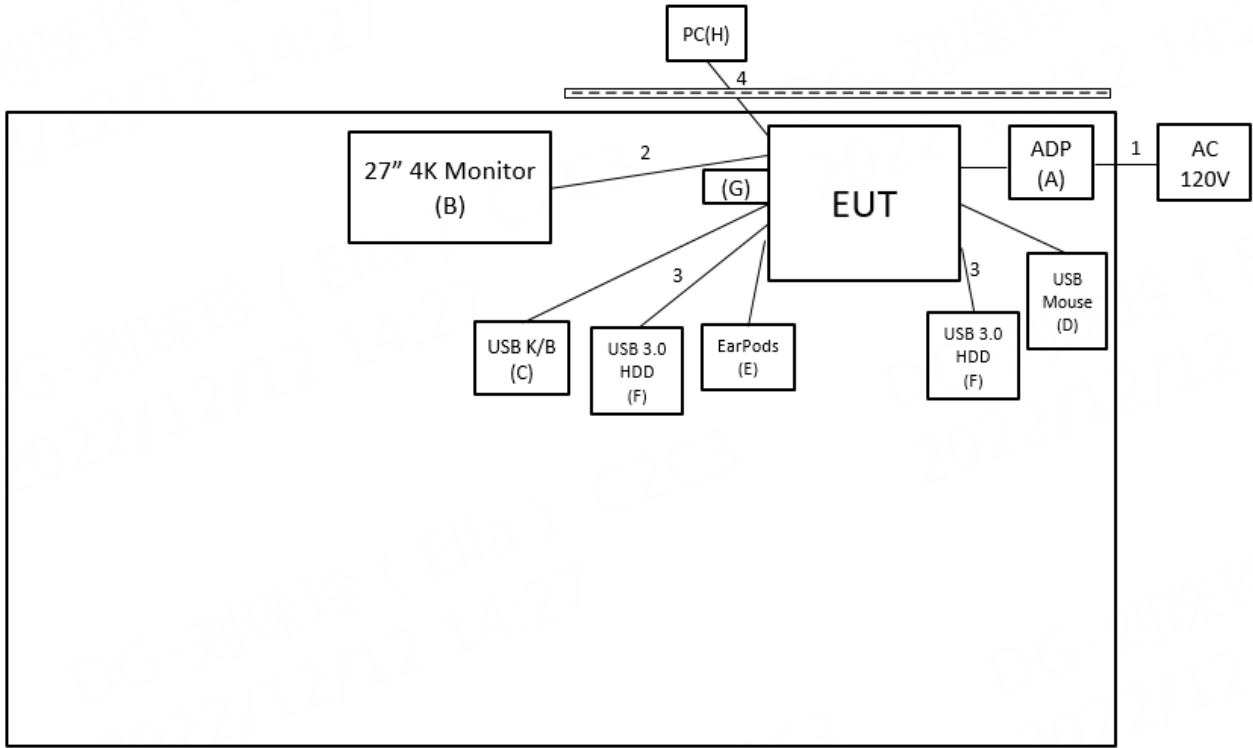

Radiated Emissions

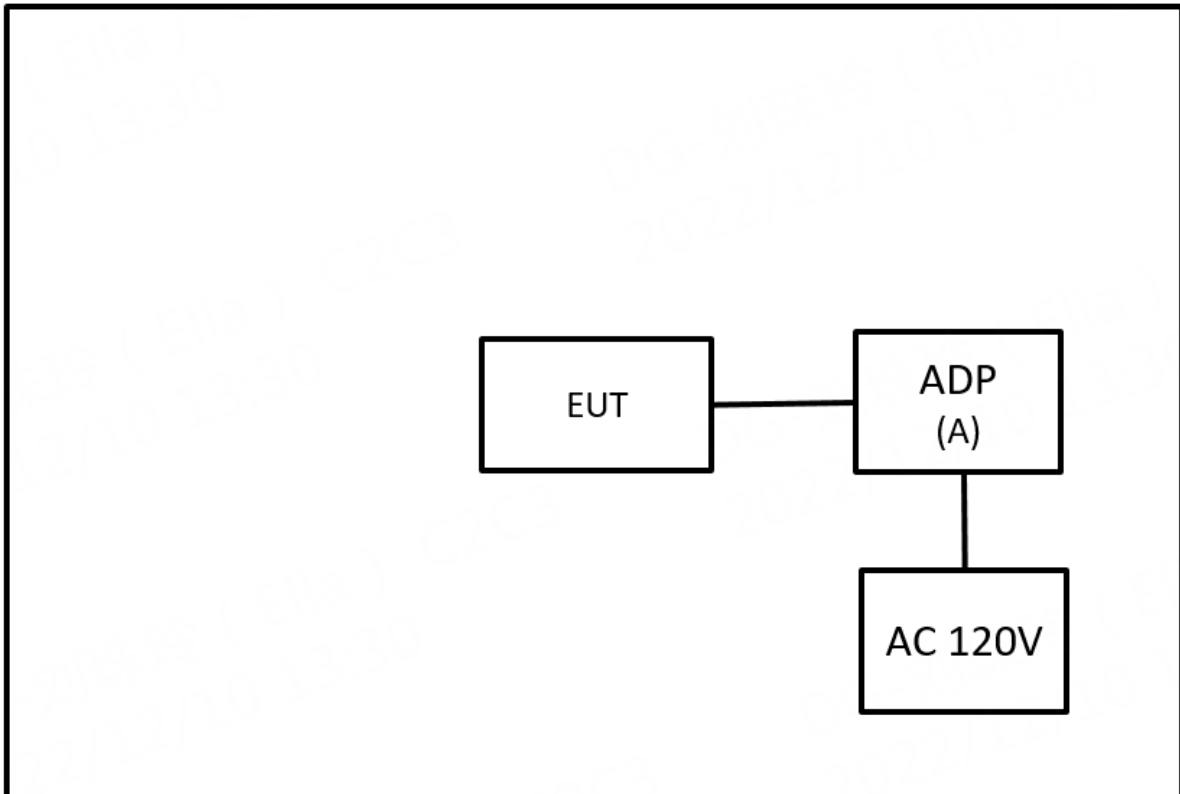

2.4 SUPPORT UNITS

AC power line conducted emissions

Item	Equipment	Brand	Model No.	Series No.	Remarks
A	ADP	Razer	RC30-0484	N/A	Supplied by test requester
B	27" 4K Monitor	DELL	U2720Q	CN-083VF-WSL0 0-0B7-332L	Furnished by test lab.
C	USB K/B	DELL	KB216t	CN-0W33XP-L03 00-797-05TY-A03	Furnished by test lab.
D	USB Mouse	DELL	MOCZUL	CN-049TWY-PRC 00-79E-01HA	Furnished by test lab.
E	EarPods	Apple	A1472	N/A	Furnished by test lab.
F	USB 3.0 HDD	WD	WDBC3C0010B SL-0B	WX81A88ALJUC	Furnished by test lab.
G	USB Dongle	Kingston	DataTraveler Exodia	N/A	Furnished by test lab.
H	PC	DELL	OptiPlex 790 MT	64NJVBX	Furnished by test lab.

Radiated Emissions

Item	Shielded	Ferrite Core	Length	Cable Type	Remarks
1	NO	NO	1.2m	Power Cable	Furnished by test lab.
2	NO	NO	1.7m	HDMI Cable	Furnished by test lab.
3	NO	NO	18cm	TypeC to TypeC Cable	Furnished by test lab.
4	NO	NO	2m	RJ-45 Cable	Furnished by test lab.

3 AC POWER LINE CONDUCTED EMISSIONS TEST

3.1 LIMIT

Frequency (MHz)	Limit (dB μ V)	
	Quasi-peak	Average
0.15 - 0.5	66 - 56 *	56 - 46 *
0.50 - 5.0	56	46
5.0 - 30.0	60	50

NOTE:

- (1) The tighter limit applies at the band edges.
- (2) The limit of " * " marked band means the limitation decreases linearly with the logarithm of the frequency in the range.
- (3) The test result calculated as following:
 Measurement Value = Reading Level + Correct Factor
 Correct Factor = Insertion Loss + Cable Loss + Attenuator Factor (if use)
 Margin Level = Measurement Value – Limit Value
 Calculation example:

Reading Level		Correct Factor		Measurement Value
38.22	+	3.45	=	41.67

Measurement Value		Limit Value		Margin Level
41.67	-	60	=	-18.33

The following table is the setting of the receiver.

Receiver Parameter	Setting
Attenuation	10 dB
Start Frequency	0.15 MHz
Stop Frequency	30 MHz
IF Bandwidth	9 KHz

3.2 TEST PROCEDURE

- a. The EUT was placed 0.8 m above the horizontal ground plane with the EUT being connected to the power mains through a line impedance stabilization network (LISN).
 All other support equipment were powered from an additional LISN(s).
 The LISN provides 50 Ohm/50uH of impedance for the measuring instrument.
- b. Interconnecting cables that hang closer than 40 cm to the ground plane shall be folded back and forth in the center forming a bundle to keep the cable above 40 cm.
- c. Excess I/O cables that are not connected to a peripheral shall be bundled in the center.
 The end of the cable will be terminated, using the correct terminating impedance.
 The overall length shall not exceed 1 m.
- d. The LISN is spaced at least 80 cm from the nearest part of the EUT chassis.
- e. For the actual test configuration, please refer to the related Item - EUT TEST PHOTO.

NOTE:

- (1) In the results, each reading is marked as Peak, QP or AVG per the detector used.
 BW=9 kHz (6 dB Bandwidth)
- (2) All readings are Peak unless otherwise stated QP or AVG in column of Note. Both the QP and the AVG readings must be less than the limit for compliance.

3.3 DEVIATION FROM TEST STANDARD

No deviation.

3.4 TEST SETUP

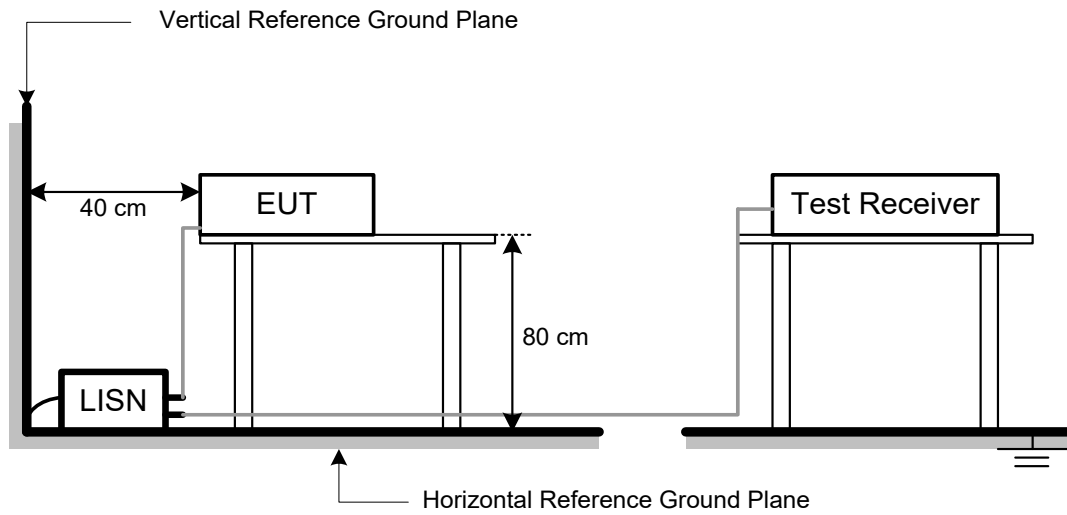

3.5 TEST RESULT

Please refer to the **APPENDIX A**.

4 RADIATED EMISSIONS TEST

4.1 LIMIT

In case the emission fall within the restricted band specified on 15.205, then the 15.209 limit in the table below has to be followed.

LIMITS OF RADIATED EMISSIONS MEASUREMENT (9 kHz to 1000 MHz)

Frequency (MHz)	Field Strength (microvolts/meter)	Measurement Distance (meters)
0.009~0.490	2400/F(KHz)	300
0.490~1.705	24000/F(KHz)	30
1.705~30.0	30	30
30~88	100	3
88~216	150	3
216~960	200	3
960~1000	500	3

LIMITS OF RADIATED EMISSIONS MEASUREMENT (Above 1000 MHz)

Frequency (MHz)	Radiated Emissions (dBuV/m)		Measurement Distance (meters)
	Peak	Average	
Above 1000	74	54	3

NOTE:

- (1) The limit for radiated test was performed according to FCC CFR Title 47, Part 15, Subpart C.
- (2) The tighter limit applies at the band edges.
- (3) Emission level (dBuV/m)=20log Emission level (uV/m).
- (4) The test result calculated as following:

Measurement Value = Reading Level + Correct Factor

Correct Factor = Antenna Factor + Cable Loss - Amplifier Gain(if use)

Margin Level = Measurement Value - Limit Value

Calculation example:

Reading Level		Correct Factor		Measurement Value
19.11	+	2.11	=	21.22

Measurement Value		Limit Value		Margin Level
21.22	-	54	=	-32.78

Spectrum Parameter	Setting
Attenuation	Auto
Start Frequency	1000 MHz
Stop Frequency	10th carrier harmonic
RBW / VBW (Emission in restricted band)	1MHz / 3MHz for Peak, 1MHz / 1/T for Average

Spectrum Parameter	Setting
Attenuation	Auto
Start ~ Stop Frequency	9KHz~90KHz for PK/AVG detector
Start ~ Stop Frequency	90KHz~110KHz for QP detector
Start ~ Stop Frequency	110KHz~490KHz for PK/AVG detector
Start ~ Stop Frequency	490KHz~30MHz for QP detector
Start ~ Stop Frequency	30MHz~1000MHz for QP detector

4.2 TEST PROCEDURE

- a. The measuring distance of 3 m shall be used for measurements. The EUT was placed on the top of a rotating table 0.8 meter above the ground at a 3 meter semi-anechoic chamber. The table was rotated 360 degrees to determine the position of the highest radiation.(below 1GHz)
- b. The measuring distance of 3 m shall be used for measurements. The EUT was placed on the top of a rotating table 1.5 meter above the ground at a 3 meter semi-anechoic chamber. The table was rotated 360 degrees to determine the position of the highest radiation.(above 1GHz)
- c. The height of the equipment or of the substitution antenna shall be 0.8 m or 1.5 m, the height of the test antenna shall vary between 1 m to 4 m. Both horizontal and vertical polarizations of the antenna are set to make the measurement.
- d. For each suspected emission, the EUT was arranged to its worst case and then the antenna was tuned to heights find the maximum reading (used Bore sight function).
- e. The receiver system was set to peak and average detect function and specified bandwidth with maximum hold mode when the test frequency is above 1GHz.
- f. The initial step in collecting radiated emission data is a receiver peak detector mode pre-scanning the measurement frequency range. Significant peaks are then marked and then Quasi Peak detector mode re-measured.
- g. All readings are Peak unless otherwise stated QP in column of Note. Peak denotes that the Peak reading complies with the QP Limits and then QP Mode measurement didn't perform. (below 1GHz)
- h. All readings are Peak Mode value unless otherwise stated AVG in column of Note. If the Peak Mode Measured value complies with the Peak Limits and lower than AVG Limits, the EUT shall be deemed to meet both Peak & AVG Limits and then only Peak Mode was measured, but AVG Mode didn't perform. (above 1GHz)
- i. For the actual test configuration, please refer to the related Item – EUT TEST PHOTO.

4.3 DEVIATION FROM TEST STANDARD

No deviation.

4.4 TEST SETUP

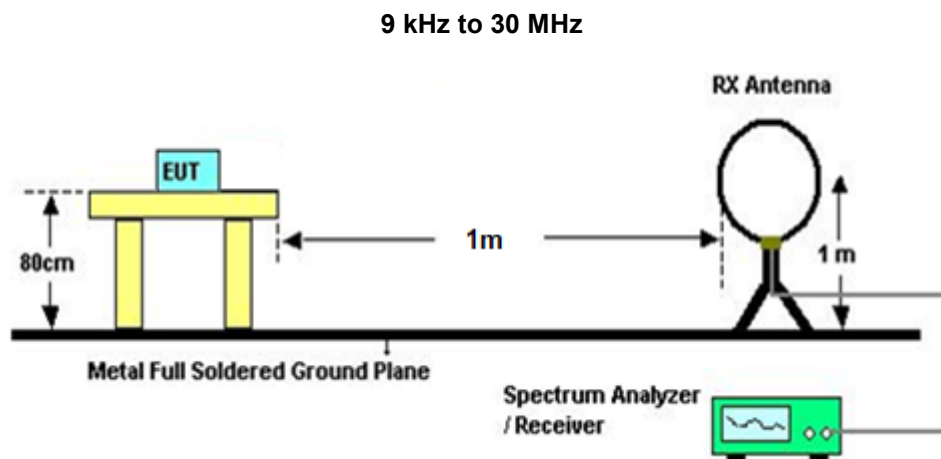

30 MHz to 1 GHz

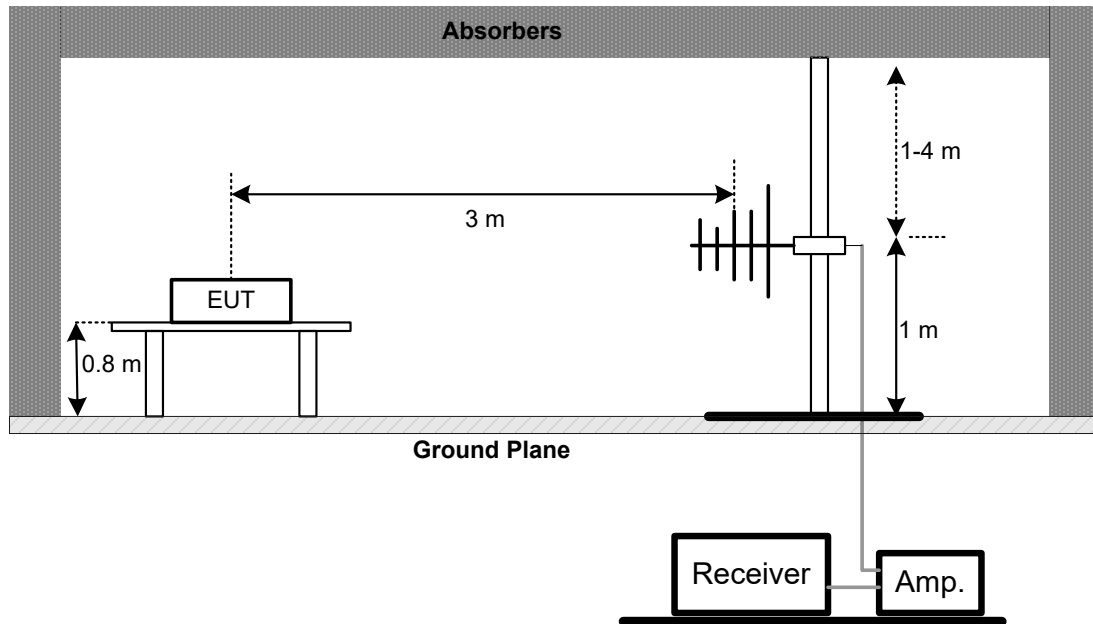

Above 1 GHz

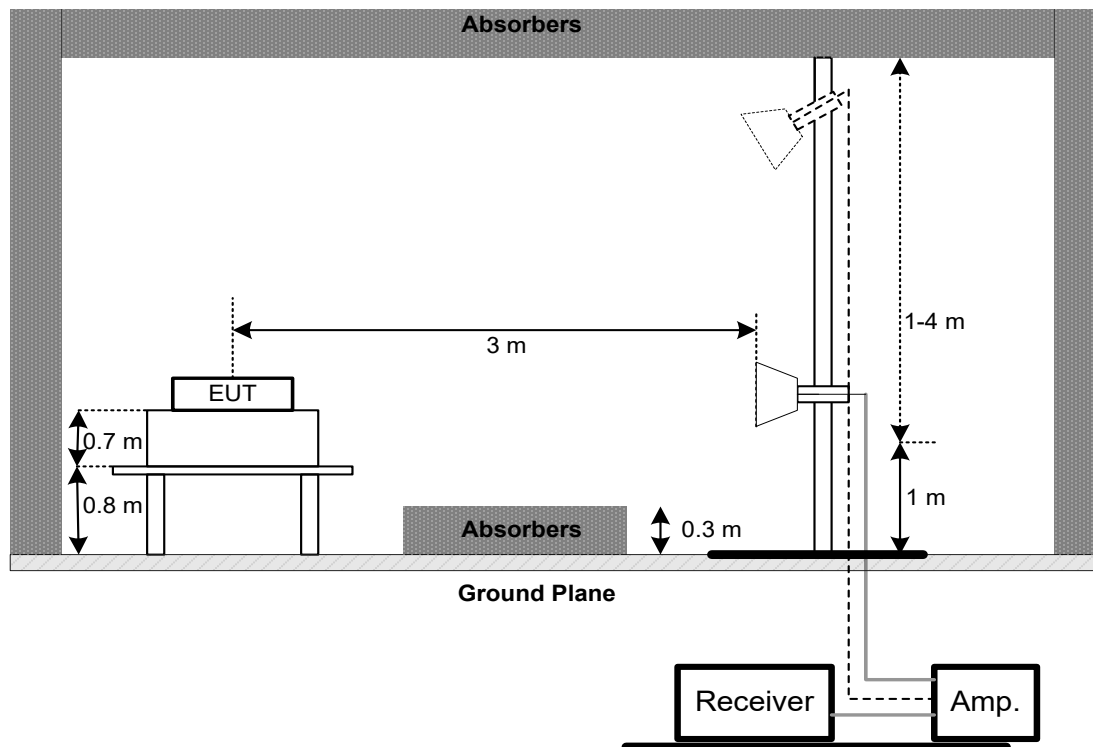

4.5 EUT OPERATING CONDITIONS

The EUT was programmed to be in continuously transmitting mode.

4.6 TEST RESULT – BELOW 30 MHZ

There were no emissions found below 30 MHz within 20 dB of the limit.

4.7 TEST RESULT – 30 MHZ TO 1 GHZ

Please refer to the APPENDIX B.

4.8 TEST RESULT – ABOVE 1 GHZ

Please refer to the APPENDIX C.

NOTE:

- (1) No limit: This is fundamental signal, the judgment is not applicable.
For fundamental signal judgment was referred to Peak output test.

5 OUTPUT POWER TEST

5.1 LIMIT

FCC Part15, Subpart C (15.247)		
Section	Test Item	Limit
15.247(b)	Maximum Output Power	1 Watt or 30dBm

5.2 TEST PROCEDURE

- The EUT was directly connected to the power meter and antenna output port as show in the block diagram below.
- The maximum peak conducted output power was performed in accordance with FCC KDB 558074 D01 15.247 Meas Guidance.
- Subclause 11.9.1.1 of ANSI C63.10 is applied. The maximum peak conducted output power may be measured using a broadband peak RF power meter. The power meter shall have a video bandwidth that is greater than or equal to the DTS bandwidth and shall use a fast-responding diode detector.

5.3 DEVIATION FROM TEST STANDARD

No deviation.

5.4 TEST SETUP

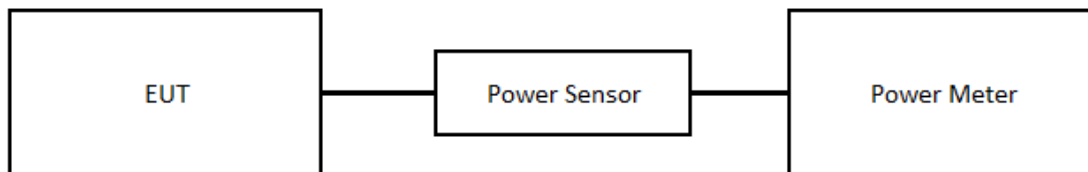

5.5 EUT OPERATING CONDITIONS

The EUT was programmed to be in continuously transmitting mode.

5.6 TEST RESULT

Please refer to the APPENDIX D.

6 LIST OF MEASURING EQUIPMENTS

AC Power Line Conducted Emissions						
Item	Kind of Equipment	Manufacturer	Type No.	Serial No.	Calibrated Date	Calibrated Until
1	TWO-LINE V-NETWORK	R&S	ENV216	101521	2022/9/28	2023/9/27
2	Test Cable	EMCI	EMCCFD300-BM-BMR-5000	220331	2022/3/31	2023/3/30
3	EMI Test Receiver	R&S	ESR 7	101433	2022/11/16	2023/11/15
4	Measurement Software	EZ	EZ EMC (Version NB-03A1-01)	N/A	N/A	N/A

Radiated Emissions						
Item	Kind of Equipment	Manufacturer	Type No.	Serial No.	Calibrated Date	Calibrated Until
1	Preamplifier	EMCI	EMC330N	980850	2022/9/19	2023/9/18
2	Preamplifier	EMCI	EMC118A45SE	980819	2022/3/8	2023/3/7
3	Preamplifier	EMCI	EMC184045SE	980882	2022/2/9	2023/2/8
4	Preamplifier	EMCI	EMC001340	980579	2022/9/30	2023/9/29
5	Test Cable	EMCI	EMC104-SM-SM-1000	220319	2022/3/15	2023/3/14
6	Test Cable	EMCI	EMC104-SM-SM-3000	220322	2022/3/15	2023/3/14
7	Test Cable	EMCI	EMC104-SM-SM-7000	220324	2022/3/15	2023/3/14
8	EXA Signal Analyzer	keysight	N9020B	MY57120120	2022/3/7	2023/3/6
9	Loop Ant	Electro-Metrics	EMCI-LPA600	291	2022/9/19	2023/9/18
10	Horn Antenna	RFSPIN	DRH18-E	211202A18EN	2022/5/18	2023/5/17
11	Horn Ant	Schwarzbeck	BBHA 9170D	1136	2022/5/18	2023/5/17
12	Log-bicon Antenna	Schwarzbeck	VULB9168	1369	2022/5/20	2023/5/19
13	6dB Attenuator	EMCI	EMCI-N-6-06	AT-N0625	2022/5/20	2023/5/19
14	Measurement Software	EZ	EZ EMC (Version NB-03A1-01)	N/A	N/A	N/A

Output Power						
Item	Kind of Equipment	Manufacturer	Type No.	Serial No.	Calibrated Date	Calibrated Until
1	Power Meter	Anritsu	ML2495A	1128008	2022/6/1	2023/5/31
2	Power Sensor	Anritsu	MA2411B	1126001	2022/6/1	2023/5/31

Remark: "N/A" denotes no model name, no serial no. or no calibration specified.
All calibration period of equipment list is one year.

7 EUT TEST PHOTO

Please refer to document Appendix No.: TP-2208C205-1 (APPENDIX-TEST PHOTOS).

8 EUT PHOTOS

Please refer to document Appendix No.: EP-2208C205-1 (APPENDIX-EUT PHOTOS).

APPENDIX A AC POWER LINE CONDUCTED EMISSIONS

Test Mode	Normal	Tested Date	2022/11/25
Test Frequency	-	Phase	Line

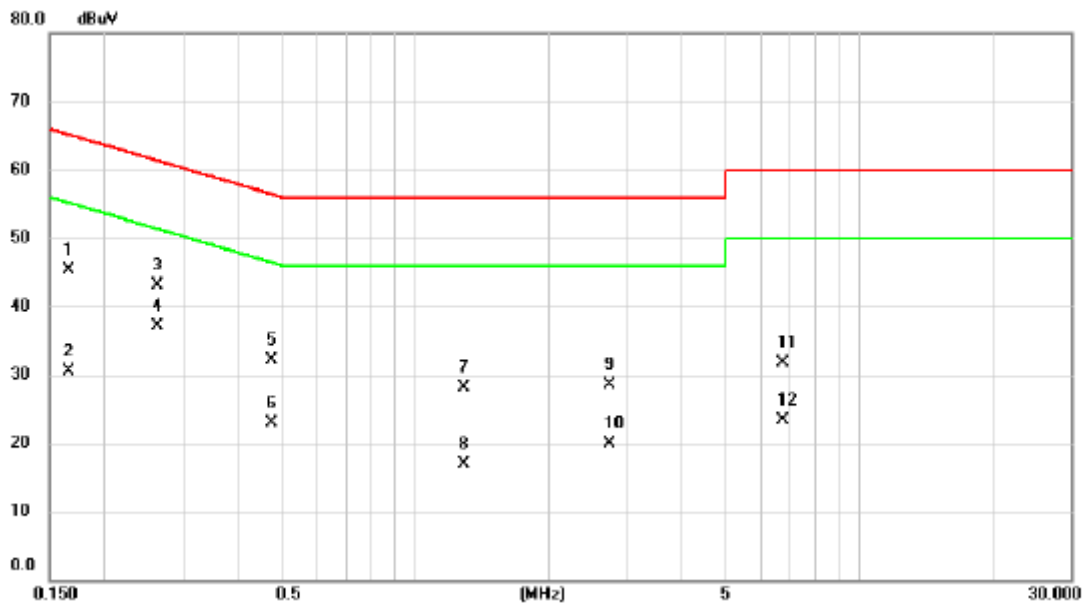

No. Mk.	Freq. MHz	Reading Level dBuV	Correct Factor dB	Measurement dBuV	Limit dBuV	Margin dB	Detector	Comment
1	0.1658	35.69	9.64	45.33	65.17	-19.84	QP	
2	0.1658	20.81	9.64	30.45	55.17	-24.72	AVG	
3	0.2625	33.39	9.63	43.02	61.35	-18.33	QP	
4 *	0.2625	27.39	9.63	37.02	51.35	-14.33	AVG	
5	0.4762	22.52	9.63	32.15	56.41	-24.26	QP	
6	0.4762	13.22	9.63	22.85	46.41	-23.56	AVG	
7	1.2908	18.51	9.68	28.19	56.00	-27.81	QP	
8	1.2908	7.26	9.68	16.94	46.00	-29.06	AVG	
9	2.7420	18.81	9.72	28.53	56.00	-27.47	QP	
10	2.7420	10.20	9.72	19.92	46.00	-26.08	AVG	
11	6.7313	21.90	9.80	31.70	60.00	-28.30	QP	
12	6.7313	13.54	9.80	23.34	50.00	-26.66	AVG	

REMARKS:

- (1) Measurement Value = Reading Level + Correct Factor.
- (2) Margin Level = Measurement Value - Limit Value.

Test Mode	Normal	Tested Date	2022/11/25
Test Frequency	-	Phase	Neutral

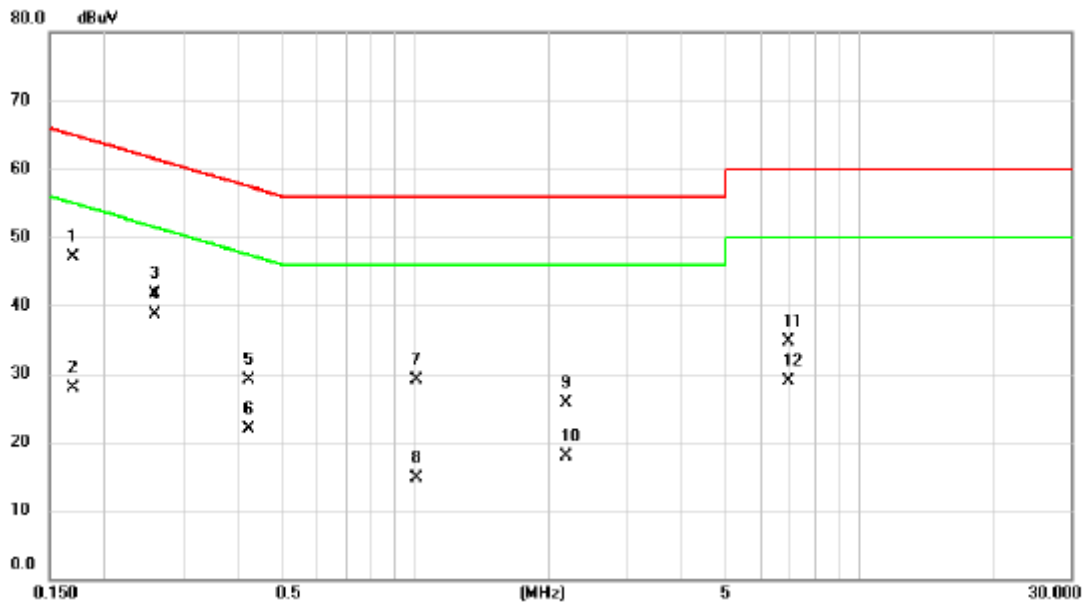

No. Mk.	Freq. MHz	Reading Level dBuV	Correct Factor dB	Measurement dBuV	Limit dBuV	Margin dB	Detector	Comment
1	0.1703	37.51	9.65	47.16	64.95	-17.79	QP	
2	0.1703	18.23	9.65	27.88	54.95	-27.07	AVG	
3	0.2602	32.03	9.64	41.67	61.43	-19.76	QP	
4 *	0.2602	29.01	9.64	38.65	51.43	-12.78	AVG	
5	0.4222	19.42	9.64	29.06	57.40	-28.34	QP	
6	0.4222	12.33	9.64	21.97	47.40	-25.43	AVG	
7	1.0072	19.38	9.68	29.06	56.00	-26.94	QP	
8	1.0072	5.09	9.68	14.77	46.00	-31.23	AVG	
9	2.1840	15.99	9.72	25.71	56.00	-30.29	QP	
10	2.1840	8.23	9.72	17.95	46.00	-28.05	AVG	
11	6.9180	24.93	9.83	34.76	60.00	-25.24	QP	
12	6.9180	18.99	9.83	28.82	50.00	-21.18	AVG	

REMARKS:

- (1) Measurement Value = Reading Level + Correct Factor.
- (2) Margin Level = Measurement Value - Limit Value.

Test Mode	Idle	Tested Date	2022/11/25
Test Frequency	-	Phase	Line

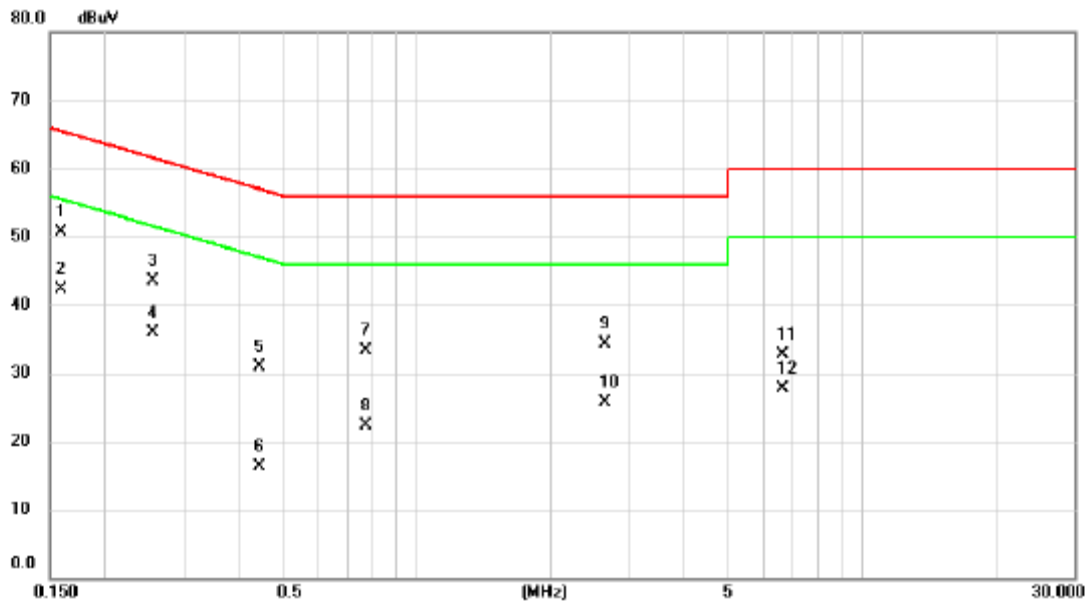

No. Mk.	Freq. MHz	Reading Level dBuV	Correct Factor dB	Measurement dBuV	Limit dBuV	Margin dB	Detector	Comment
1	0.1590	41.02	9.64	50.66	65.52	-14.86	QP	
2 *	0.1590	32.73	9.64	42.37	55.52	-13.15	AVG	
3	0.2556	33.96	9.63	43.59	61.57	-17.98	QP	
4	0.2556	26.23	9.63	35.86	51.57	-15.71	AVG	
5	0.4447	21.25	9.63	30.88	56.97	-26.09	QP	
6	0.4447	6.73	9.63	16.36	46.97	-30.61	AVG	
7	0.7687	23.59	9.66	33.25	56.00	-22.75	QP	
8	0.7687	12.70	9.66	22.36	46.00	-23.64	AVG	
9	2.6452	24.63	9.72	34.35	56.00	-21.65	QP	
10	2.6452	15.90	9.72	25.62	46.00	-20.38	AVG	
11	6.6480	22.96	9.80	32.76	60.00	-27.24	QP	
12	6.6480	17.85	9.80	27.65	50.00	-22.35	AVG	

REMARKS:

- (1) Measurement Value = Reading Level + Correct Factor.
- (2) Margin Level = Measurement Value - Limit Value.

Test Mode	Idle	Tested Date	2022/11/25
Test Frequency	-	Phase	Neutral

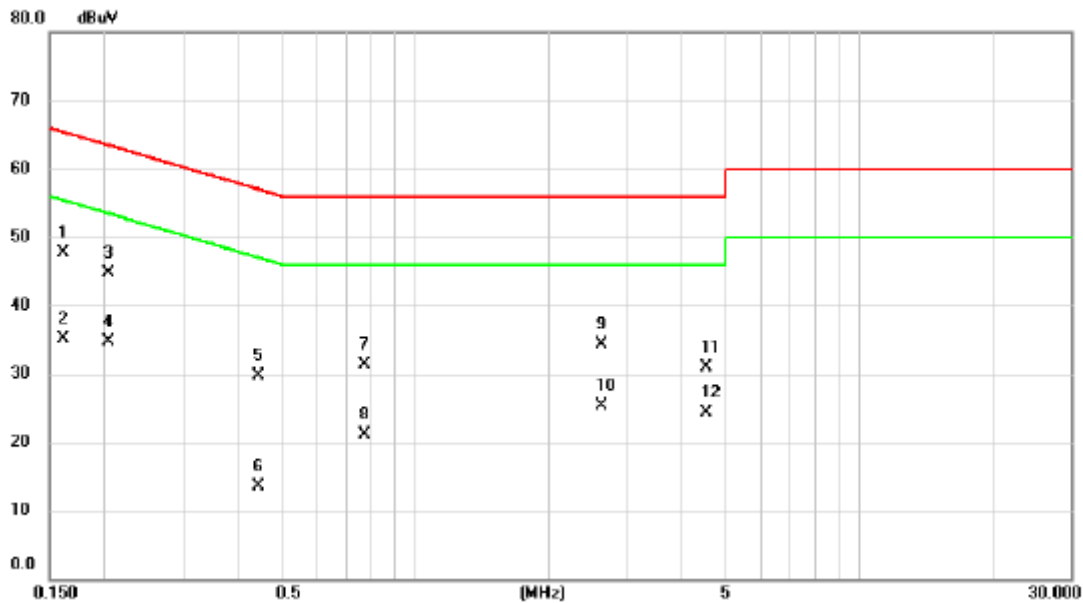

No.	Mk.	Freq.	Reading Level	Correct Factor	Measurement	Limit	Margin	Detector	Comment
		MHz	dBuV	dB	dBuV	dBuV	dB		
1	*	0.1612	38.01	9.65	47.66	65.40	-17.74	QP	
2		0.1612	25.51	9.65	35.16	55.40	-20.24	AVG	
3		0.2040	34.97	9.64	44.61	63.45	-18.84	QP	
4		0.2040	24.98	9.64	34.62	53.45	-18.83	AVG	
5		0.4447	19.97	9.64	29.61	56.97	-27.36	QP	
6		0.4447	3.83	9.64	13.47	46.97	-33.50	AVG	
7		0.7710	21.72	9.67	31.39	56.00	-24.61	QP	
8		0.7710	11.39	9.67	21.06	46.00	-24.94	AVG	
9		2.6362	24.49	9.73	34.22	56.00	-21.78	QP	
10		2.6362	15.67	9.73	25.40	46.00	-20.60	AVG	
11		4.5240	21.15	9.78	30.93	56.00	-25.07	QP	
12		4.5240	14.51	9.78	24.29	46.00	-21.71	AVG	

REMARKS:

- (1) Measurement Value = Reading Level + Correct Factor.
- (2) Margin Level = Measurement Value - Limit Value.

APPENDIX B RADIATED EMISSIONS - 30 MHZ TO 1 GHZ

Test Mode	IEEE 802.11b	Test Date	2022/12/15
Test Frequency	2437MHz	Polarization	Vertical
Temp	23°C	Hum.	59%

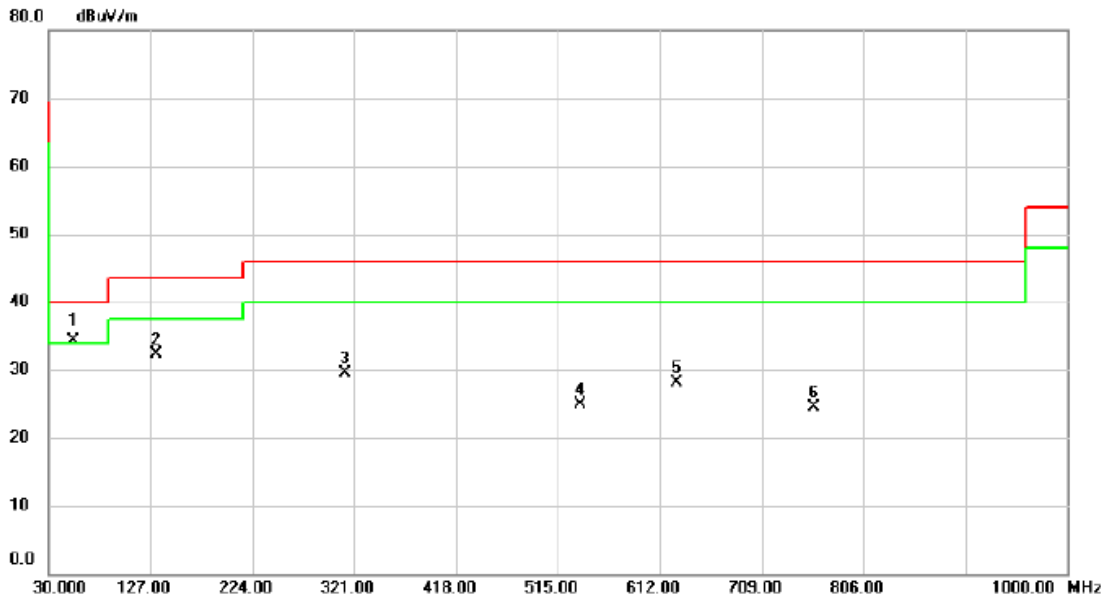

No.	Mk.	Freq. MHz	Reading Level dBuV	Correct Factor dB	Measure- ment dBuV/m	Limit dBuV/m	Over dB	Detector	Comment
1	*	54.5410	52.58	-18.37	34.21	40.00	-5.79	QP	
2		132.7877	51.60	-19.36	32.24	43.50	-11.26	peak	
3		312.1407	47.49	-18.04	29.45	46.00	-16.55	peak	
4		536.2430	37.30	-12.47	24.83	46.00	-21.17	peak	
5		628.6517	38.23	-10.16	28.07	46.00	-17.93	peak	
6		759.1490	32.15	-7.72	24.43	46.00	-21.57	peak	

REMARKS:

- (1) Measurement Value = Reading Level + Correct Factor.
- (2) Margin Level = Measurement Value - Limit Value.

Test Mode	IEEE 802.11b	Test Date	2022/12/15
Test Frequency	2437MHz	Polarization	Horizontal
Temp	23°C	Hum.	59%

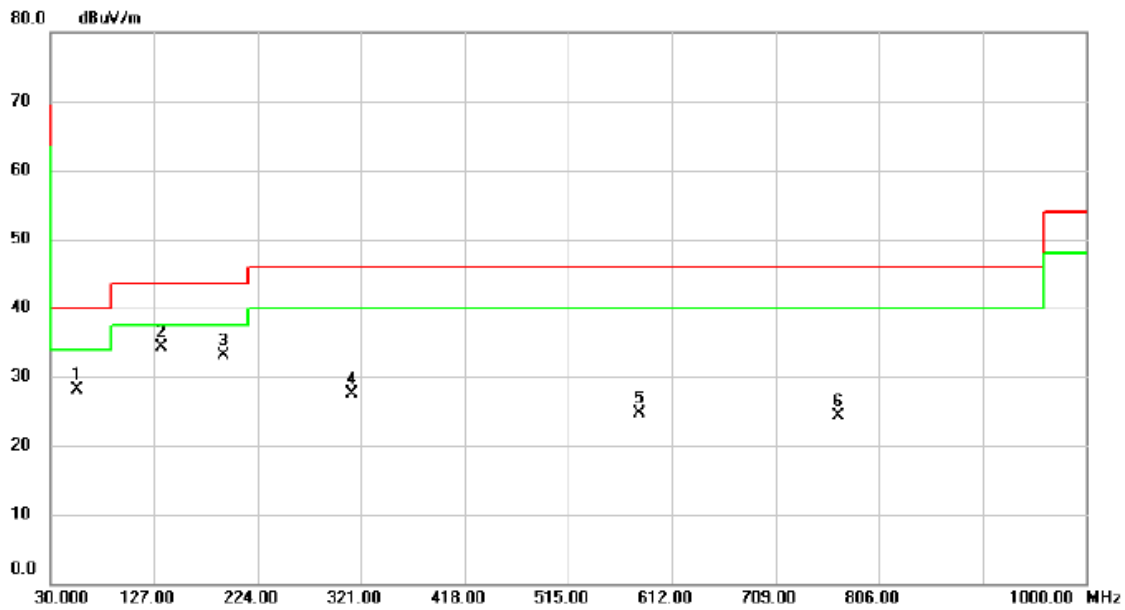

No.	Mk.	Freq. MHz	Reading Level dBuV	Correct Factor dB	Measure- ment dBuV/m	Limit dBuV/m	Over dB	Detector	Comment
1		54.6703	46.42	-18.38	28.04	40.00	-11.96	peak	
2	*	133.9840	53.55	-19.32	34.23	43.50	-9.27	peak	
3		192.3133	54.45	-21.27	33.18	43.50	-10.32	peak	
4		312.0760	45.48	-18.04	27.44	46.00	-18.56	peak	
5		581.1540	35.80	-11.19	24.61	46.00	-21.39	peak	
6		768.0082	31.79	-7.57	24.22	46.00	-21.78	peak	

REMARKS:

- (1) Measurement Value = Reading Level + Correct Factor.
- (2) Margin Level = Measurement Value - Limit Value.

APPENDIX C RADIATED EMISSIONS - ABOVE 1 GHZ

Test Mode	IEEE 802.11b	Test Date	2022/11/30
Test Frequency	2462MHz	Polarization	Vertical
Temp	23°C	Hum.	59%

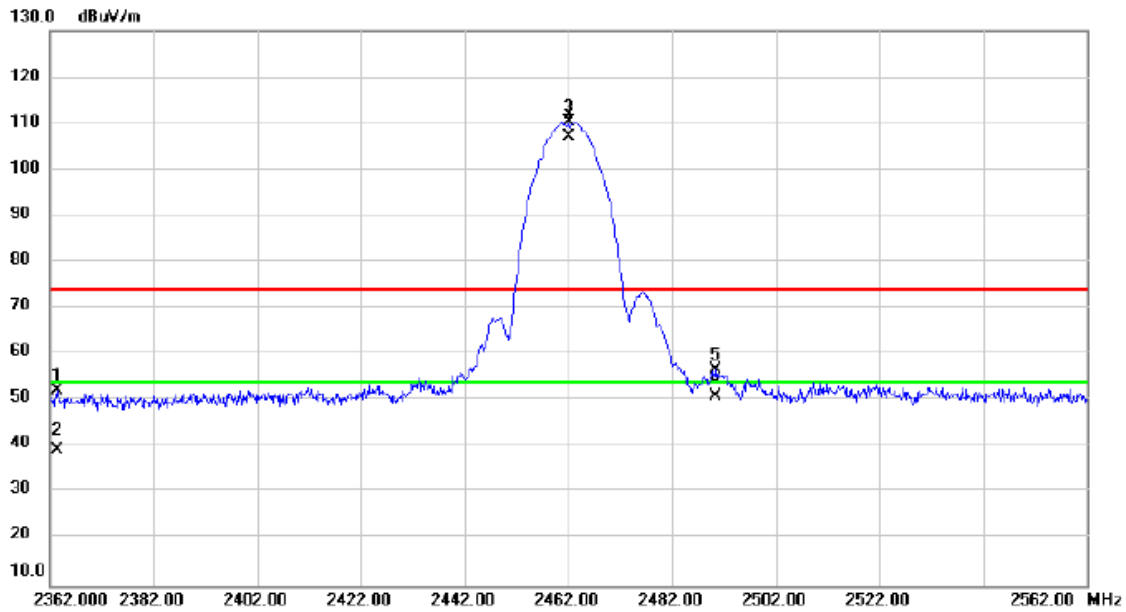

No.	Mk.	Freq. MHz	Reading Level dBuV	Correct Factor dB	Measure- ment dBuV/m	Limit dBuV/m	Over dB	Detector	Comment
1		2363.393	58.02	-5.81	52.21	74.00	-21.79	peak	
2		2363.393	44.93	-5.81	39.12	54.00	-14.88	AVG	
3	X	2462.000	116.05	-5.68	110.37	74.00	36.37	peak	No Limit
4	*	2462.000	112.75	-5.68	107.07	54.00	53.07	AVG	No Limit
5		2490.447	62.43	-5.63	56.80	74.00	-17.20	peak	
6		2490.447	56.45	-5.63	50.82	54.00	-3.18	AVG	

REMARKS:

- (1) Measurement Value = Reading Level + Correct Factor.
- (2) Margin Level = Measurement Value - Limit Value.

Test Mode	IEEE 802.11ax(HE40)	Test Date	2022/11/30
Test Frequency	2452MHz	Polarization	Vertical
Temp	23°C	Hum.	59%

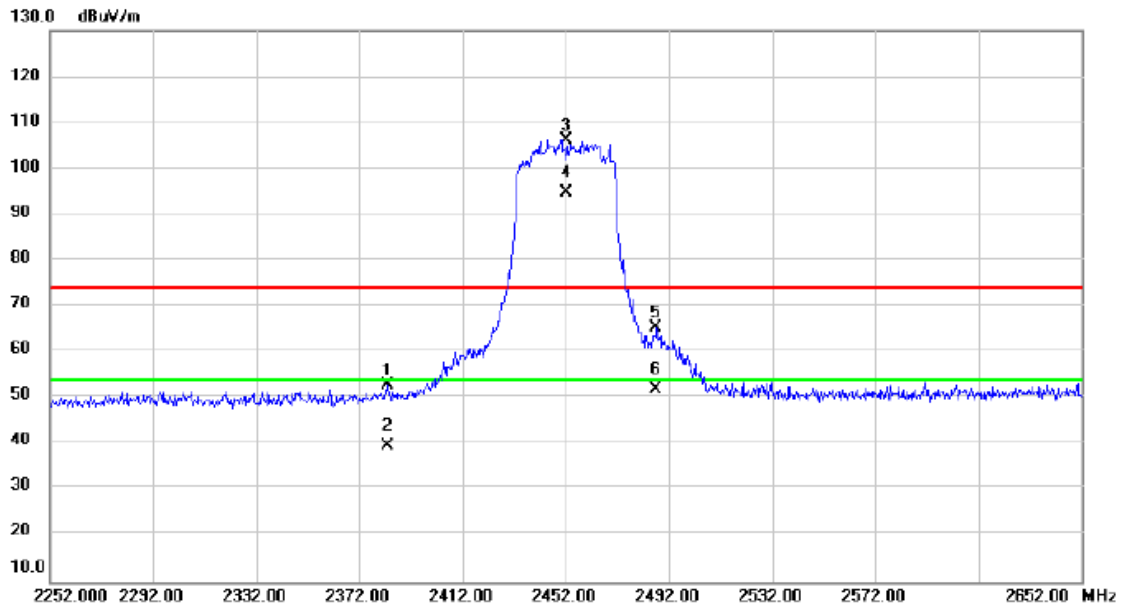

No.	Mk.	Freq. MHz	Reading Level dBuV	Correct Factor dB	Measure- ment dBuV/m	Limit dBuV/m	Over dB	Detector	Comment
1		2383.173	58.45	-5.78	52.67	74.00	-21.33	peak	
2		2383.173	45.38	-5.78	39.60	54.00	-14.40	AVG	
3	X	2452.000	111.84	-5.69	106.15	74.00	32.15	peak	No Limit
4	*	2452.000	100.56	-5.69	94.87	54.00	40.87	AVG	No Limit
5		2487.173	70.93	-5.63	65.30	74.00	-8.70	peak	
6		2487.173	57.36	-5.63	51.73	54.00	-2.27	AVG	

REMARKS:

- (1) Measurement Value = Reading Level + Correct Factor.
- (2) Margin Level = Measurement Value - Limit Value.

Test Mode	IEEE 802.11b	Test Date	2022/12/1
Test Frequency	2437MHz	Polarization	Vertical
Temp	23°C	Hum.	59%

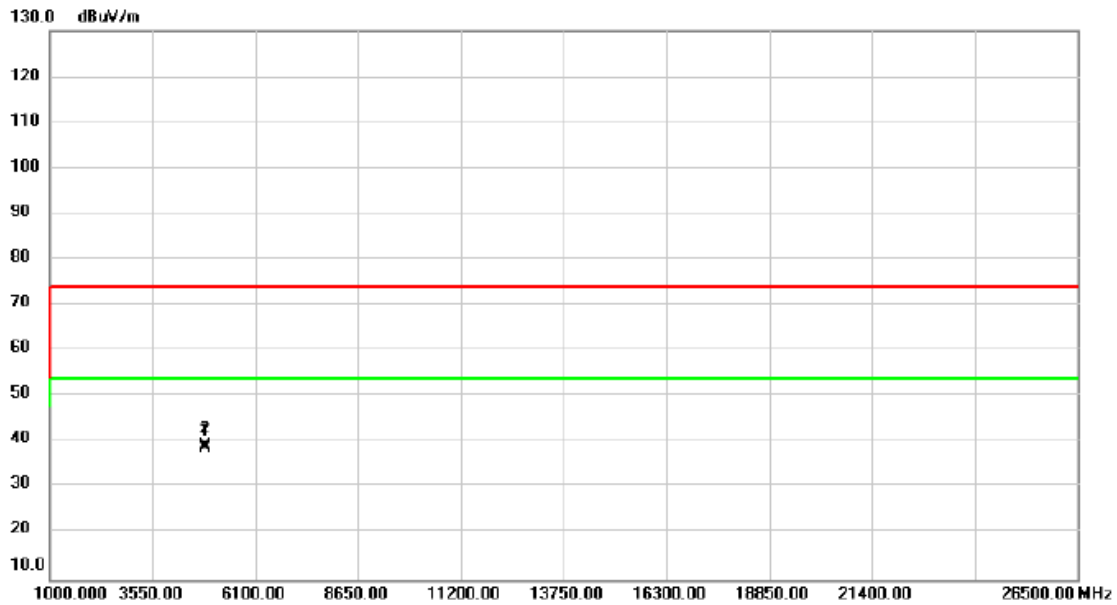

No.	Mk.	Freq. MHz	Reading Level dBuV	Correct Factor dB	Measure- ment dBuV/m	Limit dBuV/m	Over dB	Detector	Comment
1		4874.000	38.42	0.89	39.31	74.00	-34.69	peak	
2	*	4874.000	37.86	0.89	38.75	54.00	-15.25	AVG	

REMARKS:

- (1) Measurement Value = Reading Level + Correct Factor.
- (2) Margin Level = Measurement Value - Limit Value.

Test Mode	IEEE 802.11b	Test Date	2022/12/1
Test Frequency	2437MHz	Polarization	Horizontal
Temp	23°C	Hum.	59%

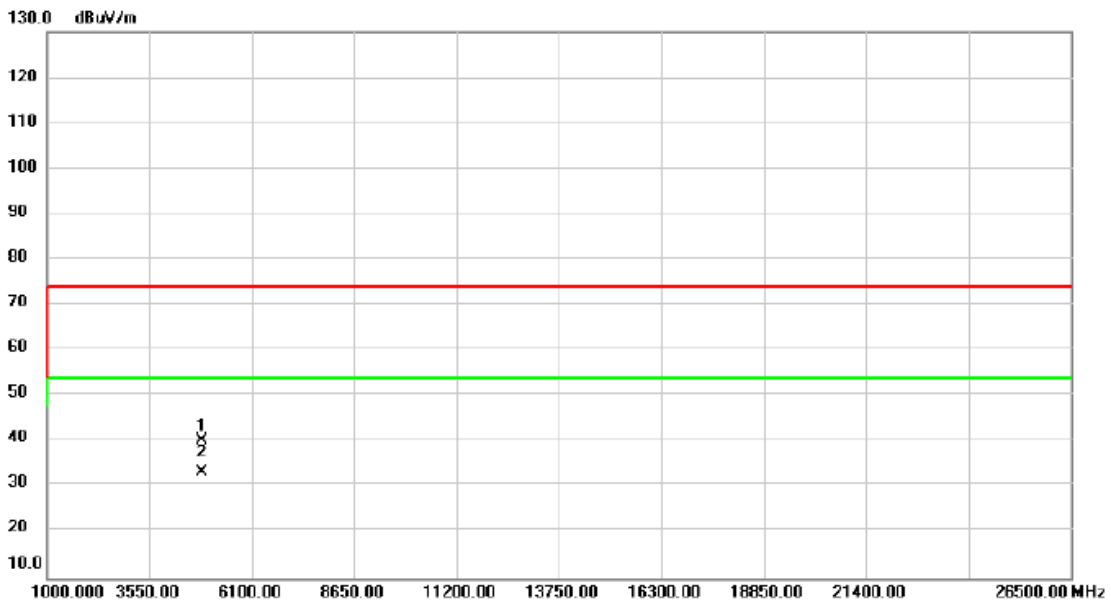

No.	Mk.	Freq. MHz	Reading Level dBuV	Correct Factor dB	Measure- ment dBuV/m	Limit dBuV/m	Over dB	Detector	Comment
1		4874.000	39.28	0.89	40.17	74.00	-33.83	peak	
2	*	4874.000	32.40	0.89	33.29	54.00	-20.71	AVG	

REMARKS:

- (1) Measurement Value = Reading Level + Correct Factor.
- (2) Margin Level = Measurement Value - Limit Value.

Test Mode	IEEE 802.11ax(HE40)	Test Date	2022/12/1
Test Frequency	2437MHz	Polarization	Vertical
Temp	23°C	Hum.	59%

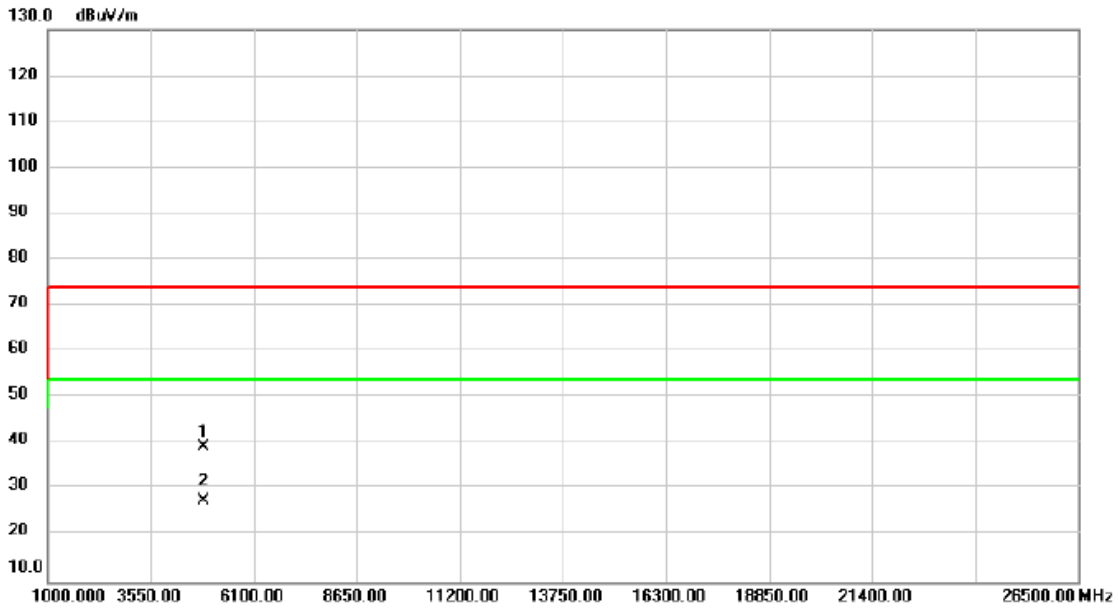

No. Mk.	Freq.	Reading Level	Correct Factor	Measurement	Limit	Over	Detector	Comment
	MHz	dBuV	dB	dBuV/m	dBuV/m	dB		
1	4874.000	38.37	0.89	39.26	74.00	-34.74	peak	
2 *	4874.000	26.62	0.89	27.51	54.00	-26.49	AVG	

REMARKS:

- (1) Measurement Value = Reading Level + Correct Factor.
- (2) Margin Level = Measurement Value - Limit Value.

Test Mode	IEEE 802.11ax(HE40)	Test Date	2022/12/1
Test Frequency	2437MHz	Polarization	Horizontal
Temp	23°C	Hum.	59%

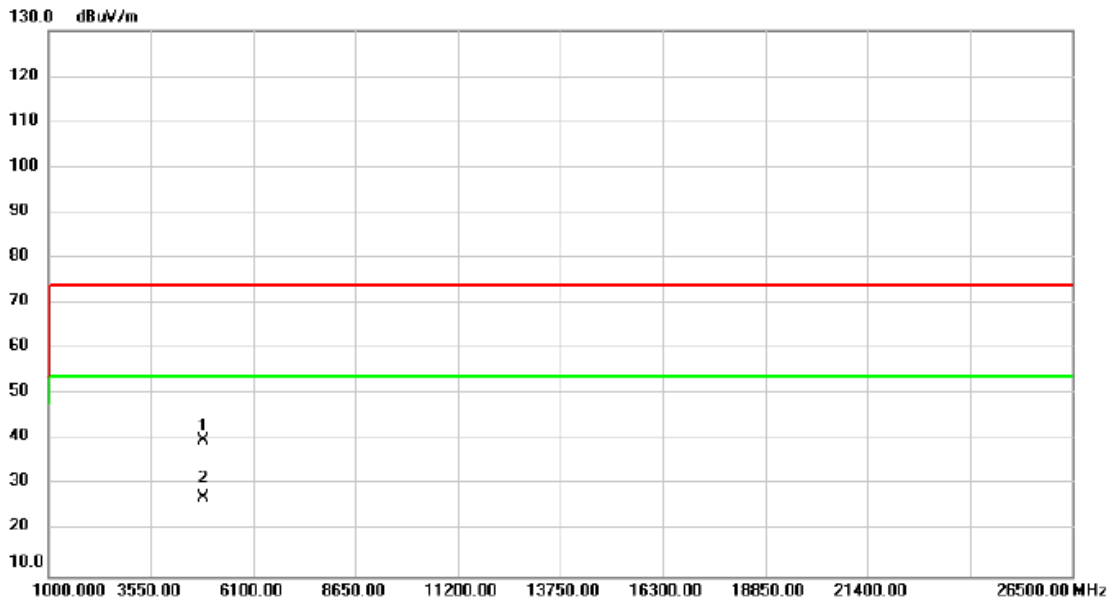

No.	Mk.	Freq. MHz	Reading Level dBuV	Correct Factor dB	Measure- ment dBuV/m	Limit dBuV/m	Over dB	Detector	Comment
1		4874.000	39.11	0.89	40.00	74.00	-34.00	peak	
2	*	4874.000	26.49	0.89	27.38	54.00	-26.62	AVG	

REMARKS:

- (1) Measurement Value = Reading Level + Correct Factor.
- (2) Margin Level = Measurement Value - Limit Value.

APPENDIX D OUTPUT POWER

For Main

Test Mode	IEEE 802.11b	Tested Date	2022/12/6
-----------	--------------	-------------	-----------

Frequency (MHz)	Conducted Power (dBm)	Conducted Power (W)	Limit (dBm)	Limit (W)	Result
2412	20.83	0.1211	30.00	1.0000	Complies
2437	23.58	0.2280	30.00	1.0000	Complies
2462	23.22	0.2099	30.00	1.0000	Complies
2467	18.78	0.0755	30.00	1.0000	Complies
2472	15.67	0.0369	30.00	1.0000	Complies

Test Mode	IEEE 802.11g	Tested Date	2022/12/6
-----------	--------------	-------------	-----------

Frequency (MHz)	Conducted Power (dBm)	Conducted Power (W)	Limit (dBm)	Limit (W)	Result
2412	21.40	0.1380	30.00	1.0000	Complies
2437	24.29	0.2685	30.00	1.0000	Complies
2462	21.36	0.1368	30.00	1.0000	Complies
2467	19.11	0.0815	30.00	1.0000	Complies
2472	16.10	0.0407	30.00	1.0000	Complies

For Aux

Test Mode	IEEE 802.11b	Tested Date	2022/12/6
-----------	--------------	-------------	-----------

Frequency (MHz)	Conducted Power (dBm)	Conducted Power (W)	Limit (dBm)	Limit (W)	Result
2412	21.02	0.1265	30.00	1.0000	Complies
2437	23.96	0.2489	30.00	1.0000	Complies
2462	23.64	0.2312	30.00	1.0000	Complies
2467	18.87	0.0771	30.00	1.0000	Complies
2472	15.62	0.0365	30.00	1.0000	Complies

Test Mode	IEEE 802.11g	Tested Date	2022/12/6
-----------	--------------	-------------	-----------

Frequency (MHz)	Conducted Power (dBm)	Conducted Power (W)	Limit (dBm)	Limit (W)	Result
2412	21.76	0.1500	30.00	1.0000	Complies
2437	24.61	0.2891	30.00	1.0000	Complies
2462	21.69	0.1476	30.00	1.0000	Complies
2467	19.39	0.0869	30.00	1.0000	Complies
2472	16.31	0.0428	30.00	1.0000	Complies

For MIMO

Test Mode	IEEE 802.11n (HT20)_Main	Tested Date	2022/12/6
-----------	--------------------------	-------------	-----------

Frequency (MHz)	Conducted Power (dBm)	Conducted Power (W)	Limit (dBm)	Limit (W)	Result
2412	19.95	0.0989	30.00	1.0000	Complies
2442	23.82	0.2410	30.00	1.0000	Complies
2462	21.78	0.1507	30.00	1.0000	Complies
2467	17.99	0.0630	30.00	1.0000	Complies
2472	16.64	0.0461	30.00	1.0000	Complies

Test Mode	IEEE 802.11n (HT20)_Aux	Tested Date	2022/12/6
-----------	-------------------------	-------------	-----------

Frequency (MHz)	Conducted Power (dBm)	Conducted Power (W)	Limit (dBm)	Limit (W)	Result
2412	20.34	0.1081	30.00	1.0000	Complies
2442	24.28	0.2679	30.00	1.0000	Complies
2462	22.18	0.1652	30.00	1.0000	Complies
2467	18.26	0.0670	30.00	1.0000	Complies
2472	16.98	0.0499	30.00	1.0000	Complies

Test Mode	IEEE 802.11n (HT20)_Total	Tested Date	2022/12/6
-----------	---------------------------	-------------	-----------

Frequency (MHz)	Conducted Power (dBm)	Conducted Power (W)	Limit (dBm)	Limit (W)	Result
2412	23.16	0.2070	30.00	1.0000	Complies
2442	27.07	0.5089	30.00	1.0000	Complies
2462	24.99	0.3159	30.00	1.0000	Complies
2467	21.14	0.1299	30.00	1.0000	Complies
2472	19.82	0.0960	30.00	1.0000	Complies

Test Mode	IEEE 802.11n (HT40)_Main	Tested Date	2022/12/6
-----------	--------------------------	-------------	-----------

Frequency (MHz)	Conducted Power (dBm)	Conducted Power (W)	Limit (dBm)	Limit (W)	Result
2422	20.61	0.1151	30.00	1.0000	Complies
2442	22.68	0.1854	30.00	1.0000	Complies
2452	19.68	0.0929	30.00	1.0000	Complies
2457	13.66	0.0232	30.00	1.0000	Complies
2462	14.83	0.0304	30.00	1.0000	Complies

Test Mode	IEEE 802.11n (HT40)_Aux	Tested Date	2022/12/6
-----------	-------------------------	-------------	-----------

Frequency (MHz)	Conducted Power (dBm)	Conducted Power (W)	Limit (dBm)	Limit (W)	Result
2422	20.73	0.1183	30.00	1.0000	Complies
2442	22.72	0.1871	30.00	1.0000	Complies
2452	20.14	0.1033	30.00	1.0000	Complies
2457	14.16	0.0261	30.00	1.0000	Complies
2462	15.25	0.0335	30.00	1.0000	Complies

Test Mode	IEEE 802.11n (HT40)_Total	Tested Date	2022/12/6
-----------	---------------------------	-------------	-----------

Frequency (MHz)	Conducted Power (dBm)	Conducted Power (W)	Limit (dBm)	Limit (W)	Result
2422	23.68	0.2334	30.00	1.0000	Complies
2442	25.71	0.3724	30.00	1.0000	Complies
2452	22.93	0.1962	30.00	1.0000	Complies
2457	16.93	0.0493	30.00	1.0000	Complies
2462	18.06	0.0639	30.00	1.0000	Complies

Test Mode	IEEE 802.11ax(HE20)_Main	Tested Date	2022/12/6
-----------	--------------------------	-------------	-----------

Frequency (MHz)	Conducted Power (dBm)	Conducted Power (W)	Limit (dBm)	Limit (W)	Result
2412	22.16	0.1644	30.00	1.0000	Complies
2442	23.64	0.2312	30.00	1.0000	Complies
2462	22.10	0.1622	30.00	1.0000	Complies
2467	16.21	0.0418	30.00	1.0000	Complies
2472	14.87	0.0307	30.00	1.0000	Complies

Test Mode	IEEE 802.11ax(HE20)_Aux	Tested Date	2022/12/6
-----------	-------------------------	-------------	-----------

Frequency (MHz)	Conducted Power (dBm)	Conducted Power (W)	Limit (dBm)	Limit (W)	Result
2412	22.47	0.1766	30.00	1.0000	Complies
2442	24.06	0.2547	30.00	1.0000	Complies
2462	22.30	0.1698	30.00	1.0000	Complies
2467	16.65	0.0462	30.00	1.0000	Complies
2472	14.52	0.0283	30.00	1.0000	Complies

Test Mode	IEEE 802.11ax(HE20)_Total	Tested Date	2022/12/6
-----------	---------------------------	-------------	-----------

Frequency (MHz)	Conducted Power (dBm)	Conducted Power (W)	Limit (dBm)	Limit (W)	Result
2412	25.33	0.3410	30.00	1.0000	Complies
2442	26.87	0.4859	30.00	1.0000	Complies
2462	25.21	0.3320	30.00	1.0000	Complies
2467	19.45	0.0880	30.00	1.0000	Complies
2472	17.71	0.0590	30.00	1.0000	Complies

Test Mode	IEEE 802.11ax(HE40)_Main	Tested Date	2022/12/6
-----------	--------------------------	-------------	-----------

Frequency (MHz)	Conducted Power (dBm)	Conducted Power (W)	Limit (dBm)	Limit (W)	Result
2422	20.40	0.1096	30.00	1.0000	Complies
2442	23.16	0.2070	30.00	1.0000	Complies
2452	20.59	0.1146	30.00	1.0000	Complies
2457	16.24	0.0421	30.00	1.0000	Complies
2462	15.24	0.0334	30.00	1.0000	Complies

Test Mode	IEEE 802.11ax(HE40)_Aux	Tested Date	2022/12/6
-----------	-------------------------	-------------	-----------

Frequency (MHz)	Conducted Power (dBm)	Conducted Power (W)	Limit (dBm)	Limit (W)	Result
2422	20.55	0.1135	30.00	1.0000	Complies
2442	23.12	0.2051	30.00	1.0000	Complies
2452	20.81	0.1205	30.00	1.0000	Complies
2457	16.61	0.0458	30.00	1.0000	Complies
2462	15.45	0.0351	30.00	1.0000	Complies

Test Mode	IEEE 802.11ax(HE40)_Total	Tested Date	2022/12/6
-----------	---------------------------	-------------	-----------

Frequency (MHz)	Conducted Power (dBm)	Conducted Power (W)	Limit (dBm)	Limit (W)	Result
2422	23.49	0.2231	30.00	1.0000	Complies
2442	26.15	0.4121	30.00	1.0000	Complies
2452	23.71	0.2351	30.00	1.0000	Complies
2457	19.44	0.0879	30.00	1.0000	Complies
2462	18.36	0.0685	30.00	1.0000	Complies

End of Test Report