

FCC Radio Test Report

FCC ID: RWO-RZ090484

This report concerns: **Class II Permissive Change**

Report No. : BTL-FCCP-1-2208C205
Equipment : Notebook PC
Model Name : RZ09-0484
Brand Name : RAZER
Applicant : Razer Inc.
Address : 9 Pasteur, Suite 100, Irvine, CA92618, USA.
Manufacturer : Razer Inc.
Address : 9 Pasteur, Suite 100, Irvine, CA92618, USA.

Radio Function : Bluetooth Low Energy (5.0)

FCC Rule Part(s) : FCC CFR Title 47, Part 15, Subpart C (15.247)
Measurement Procedure(s) : ANSI C63.10-2013

Date of Receipt : 2022/10/18
Date of Test : 2022/11/23~2022/12/16
Issued Date : 2022/12/22

The above equipment has been tested and found in compliance with the requirement of the above standards by BTL Inc.

Prepared by :

Eric Lee

Eric Lee, Engineer

Approved by :

Jerry Chuang

Jerry Chuang, Supervisor



BTL Inc.

No.18, Ln. 171, Sec. 2, Jiuzong Rd., Neihu Dist., Taipei City 114, Taiwan

Tel: +886-2-2657-3299 Fax: +886-2-2657-3331 Web: www.newbtl.com Service mail: btl_qa@newbtl.com

Declaration

BTL represents to the client that testing is done in accordance with standard procedures as applicable and that test instruments used has been calibrated with standards traceable to international standard(s) and/or national standard(s).

BTL's reports apply only to the specific samples tested under conditions. It is manufacture's responsibility to ensure that additional production units of this model are manufactured with the identical electrical and mechanical components. **BTL** shall have no liability for any declarations, inferences or generalizations drawn by the client or others from **BTL** issued reports.

This report is the confidential property of the client. As a mutual protection to the clients, the public and ourselves, the test report shall not be reproduced, except in full, without our written approval.

BTL's laboratory quality assurance procedures are in compliance with the **ISO/IEC 17025** requirements, and accredited by the conformity assessment authorities listed in this test report.

BTL is not responsible for the sampling stage, so the results only apply to the sample as received.

The information, data and test plan are provided by manufacturer which may affect the validity of results, so it is manufacturer's responsibility to ensure that the apparatus meets the essential requirements of applied standards and in all the possible configurations as representative of its intended use.

Limitation

For the use of the authority's logo is limited unless the Test Standard(s)/Scope(s)/Item(s) mentioned in this test report is (are) included in the conformity assessment authorities acceptance respective.

Please note that the measurement uncertainty is provided for informational purpose only and are not use in determining the Pass/Fail results.

CONTENTS

REVISION HISTORY	4
1 SUMMARY OF TEST RESULTS	5
1.1 TEST FACILITY	6
1.2 MEASUREMENT UNCERTAINTY	6
1.3 TEST ENVIRONMENT CONDITIONS	6
1.4 TABLE OF PARAMETERS OF TEXT SOFTWARE SETTING	6
2 GENERAL INFORMATION	7
2.1 DESCRIPTION OF EUT	7
2.2 TEST MODES	9
2.3 BLOCK DIAGRAM SHOWING THE CONFIGURATION OF SYSTEM TESTED	10
2.4 SUPPORT UNITS	11
3 AC POWER LINE CONDUCTED EMISSIONS TEST	12
3.1 LIMIT	12
3.2 TEST PROCEDURE	12
3.3 DEVIATION FROM TEST STANDARD	12
3.4 TEST SETUP	13
3.5 TEST RESULT	13
4 RADIATED EMISSIONS TEST	14
4.1 LIMIT	14
4.2 TEST PROCEDURE	15
4.3 DEVIATION FROM TEST STANDARD	15
4.4 TEST SETUP	15
4.5 EUT OPERATING CONDITIONS	17
4.6 TEST RESULT – BELOW 30 MHZ	17
4.7 TEST RESULT – 30 MHZ TO 1 GHZ	17
4.8 TEST RESULT – ABOVE 1 GHZ	17
5 OUTPUT POWER TEST	18
5.1 APPLIED PROCEDURES / LIMIT	18
5.2 TEST PROCEDURE	18
5.3 DEVIATION FROM STANDARD	18
5.4 TEST SETUP	18
5.5 EUT OPERATION CONDITIONS	18
5.6 TEST RESULTS	18
6 LIST OF MEASURING EQUIPMENTS	19
7 EUT TEST PHOTO	20
8 EUT PHOTOS	20
APPENDIX A AC POWER LINE CONDUCTED EMISSIONS	21
APPENDIX B RADIATED EMISSIONS - 30 MHZ TO 1 GHZ	26
APPENDIX C RADIATED EMISSIONS - ABOVE 1 GHZ	29
APPENDIX D OUTPUT POWER	33

REVISION HISTORY

Report No.	Version	Description	Issued Date	Note
BTL-FCCP-2-2208C205	R00	Original Report.	2022/12/22	Valid

1 SUMMARY OF TEST RESULTS

Test procedures according to the technical standards.

Standard(s) Section	Description	Test Result	Judgement	Remark
15.207	AC Power Line Conducted Emissions	APPENDIX A	Pass	-----
15.205 15.209 15.247(d)	Radiated Emissions	APPENDIX B APPENDIX C	Pass	-----
15.247(a)(2)	Bandwidth	-----	-----	-----
15.247(b)(3)	Output Power	APPENDIX D	Pass	-----
15.247(e)	Power Spectral Density	-----	-----	-----
15.247(d)	Antenna conducted Spurious Emission	-----	-----	-----
15.203	Antenna Requirement	-----	-----	-----

NOTE:

- (1) "N/A" denotes test is not applicable in this Test Report.
- (2) The report format version is TP.1.1.1.
- (3) The antenna gain of EUT is smaller than that of the module. So in this report the worst cases of radiated spurious emissions and AC Power Line Conducted Emissions were evaluated and recorded. And evaluated the output power items and recorded in the report. For the test results of all other test items please refer to module test reports.

1.1 TEST FACILITY

The test facilities used to collect the test data in this report:

No. 72, Ln. 169, Sec. 2, Datong Rd., Xizhi Dist., New Taipei City 221, Taiwan

The test sites and facilities are covered under FCC RN: 674415 and DN: TW0659.

C06 CB21 CB22

No. 68-1, Ln. 169, Sec. 2, Datong Rd., Xizhi Dist., New Taipei City 221, Taiwan

The test sites and facilities are covered under FCC RN: 674415 and DN: TW0659.

C05 CB08 CB11 CB15 CB16
 SR10

1.2 MEASUREMENT UNCERTAINTY

The reported uncertainty of measurement $y \pm U$, where expanded uncertainty U is based on a standard uncertainty multiplied by a coverage factor of $k = 2$, providing a level of confidence of approximately **95 %**.

The measurement instrumentation uncertainty considerations contained in CISPR 16-4-2. The BTL measurement uncertainty is less than the CISPR 16-4-2 U_{cispr} requirement.

A. AC power line conducted emissions test:

Test Site	Method	Measurement Frequency Range	U (dB)
C05	CISPR	150 kHz ~ 30MHz	3.44

B. Radiated emissions test:

Test Site	Measurement Frequency Range	U,(dB)
CB21	0.03 GHz ~ 0.2 GHz	4.17
	0.2 GHz ~ 1 GHz	4.72
	1 GHz ~ 6 GHz	5.21
	6 GHz ~ 18 GHz	5.51
	18 GHz ~ 26 GHz	3.69
	26 GHz ~ 40 GHz	4.23

C. Conducted test:

Test Item	U,(dB)
Output power	0.3669

NOTE:

Unless specifically mentioned, the uncertainty of measurement has not been taken into account to declare the compliance or non-compliance to the specification.

1.3 TEST ENVIRONMENT CONDITIONS

Test Item	Environment Condition	Test Voltage	Tested by
AC Power Line Conducted Emissions	23°C, 58%	AC 120 V	Jay Tien
Radiated emissions below 1 GHz	23°C, 59%	AC 120 V	Mark Luo
Radiated emissions above 1 GHz	23°C, 59%	AC 120 V	Mark Luo
Output Power	22.6°C, 51%	AC 120 V	Angela Wang

1.4 TABLE OF PARAMETERS OF TEXT SOFTWARE SETTING

Test Software	DRTU V02999.22.180.0			
Modulation Mode	2402 MHz	2440 MHz	2480 MHz	Data Rate
BLE 5.0	10	12	14	1 Mbps

2 GENERAL INFORMATION

2.1 DESCRIPTION OF EUT

Equipment	Notebook PC
Model Name	RAZER
Brand Name	RZ09-0484
Model Difference	N/A
Power Source	1# DC voltage supplied from AC adapter. 1)Model: RC30-0484 2)Model: RC30-042 2# Supplied from battery. Model: RC30-0484
Power Rating	1# 1) I/P: 100-240V~ 4.5A 50/60Hz O/P: 19.5V===16.92A TOTAL 330W 2) I/P: 100-240V~ 4A MAX 50/60Hz O/P: 19.5V===14.36A TOTAL 280.0W 2# DC 15.4V, 5955mAh, 91.7Wh
Products Covered	2* Power Adapter 1* AC Cable
Operation Band	2400 MHz ~ 2483.5 MHz
Operation Frequency	2402 MHz ~ 2480 MHz
Modulation Technology	GFSK
Transfer Rate	1 Mbps
Output Power Max.	1 Mbps: 8.74 dBm (0.0075W)
Test Model	RZ09-0484
Sample Status	Engineering Sample
EUT Modification(s)	N/A

NOTE:

- (1) The above EUT information is declared by manufacturer and for more detailed features description, please refers to the manufacturer's specifications or user's manual.

(2) Channel List:

Channel	Frequency (MHz)	Channel	Frequency (MHz)
00	2402	20	2442
01	2404	21	2444
02	2406	22	2446
03	2408	23	2448
04	2410	24	2450
05	2412	25	2452
06	2414	26	2454
07	2416	27	2456
08	2418	28	2458
09	2420	29	2460
10	2422	30	2462
11	2424	31	2464
12	2426	32	2466
13	2428	33	2468
14	2430	34	2470
15	2432	35	2472
16	2434	36	2474
17	2436	37	2476
18	2438	38	2478
19	2440	39	2480

(3) Table for Filed Antenna:

Ant.	Manufacturer	P/N	Type	Connector	Gain (dBi)
1	Amphenol Taiwan Corporation	BY5963-16-001-C	PIFA	N/A	2.20

Note:

- 1) Ant.1 refers to main antenna.
- 2) The AUX antenna connector of the module connected to the MAIN antenna of the EUT.
- (4) The above Antenna information are derived from the antenna data sheet provided by manufacturer and for more detailed features description, please refer to the manufacturer's specifications, the laboratory shall not be held responsible.

2.2 TEST MODES

Test Items	Test mode	Channel	Note
AC power line conducted emissions	Normal/Idle	-	-
Transmitter Radiated Emissions (below 1GHz)	1 Mbps	39	-
Transmitter Radiated Emissions (above 1GHz)	1 Mbps	39	Bandedge
	1 Mbps	39	Harmonic
Output Power	1 Mbps	00/19/39	-

NOTE:

- (1) For radiated emission band edge test, both Vertical and Horizontal are evaluated, but only the worst case (Vertical) is recorded.
- (2) This Notebook PC has two mainboards with two adapters. Both mainboard APF22003_MB (with adapter RC09-0484) and mainboard APF22003_MB2 (with adapter RC30-042) had been pre-tested and in this report only recorded the worst case.

2.3 BLOCK DIAGRAM SHOWING THE CONFIGURATION OF SYSTEM TESTED

Equipment letters and Cable numbers refer to item numbers described in the tables of clause 2.4.

AC power line conducted emissions

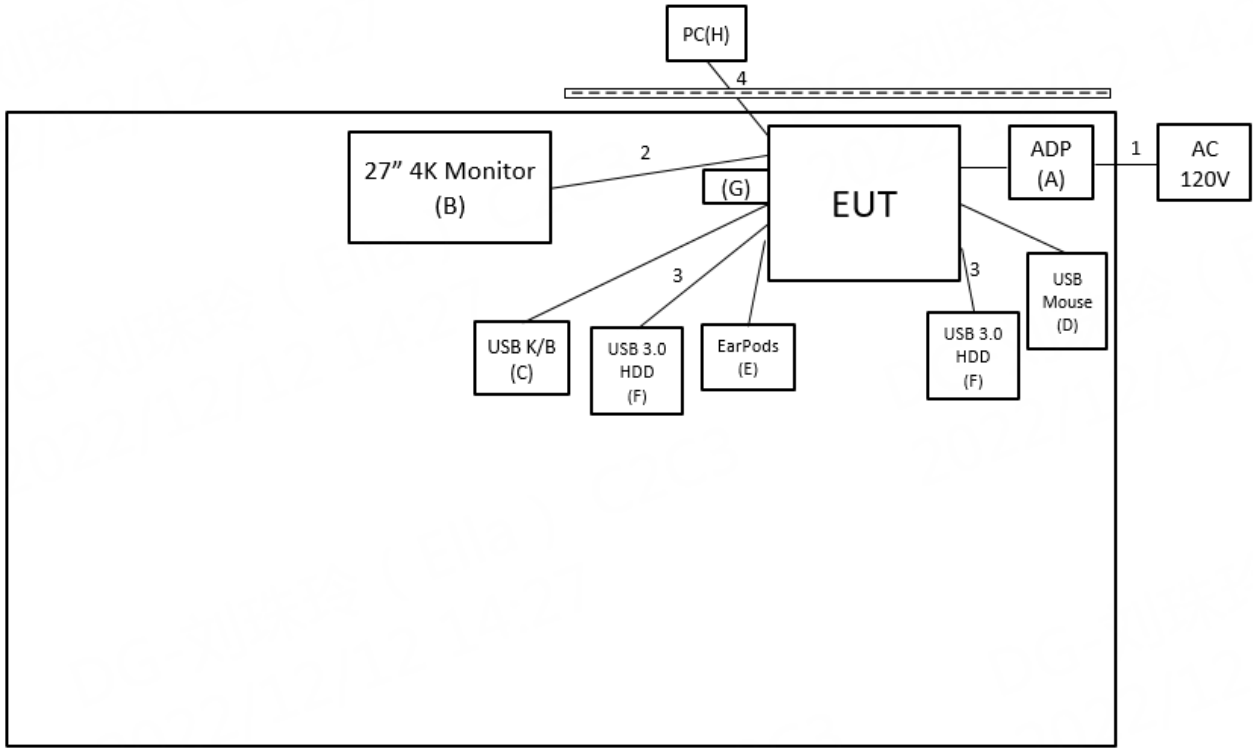

Radiated Emissions

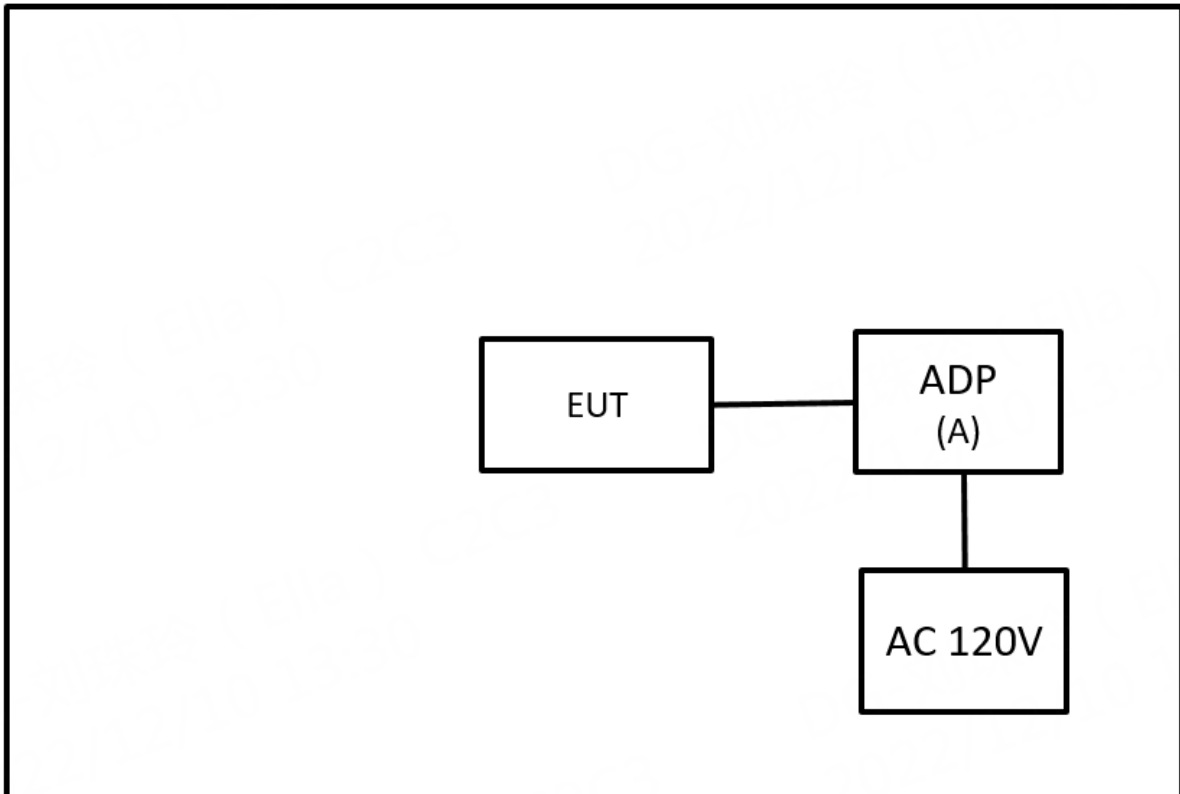

2.4 SUPPORT UNITS

AC power line conducted emissions

Item	Equipment	Brand	Model No.	Series No.	Remarks
A	ADP	Razer	RC30-0484	N/A	Supplied by test requester
B	27" 4K Monitor	DELL	U2720Q	CN-083VF-WSL0 0-0B7-332L	Furnished by test lab.
C	USB K/B	DELL	KB216t	CN-0W33XP-L03 00-797-05TY-A03	Furnished by test lab.
D	USB Mouse	DELL	MOCZUL	CN-049TWY-PRC 00-79E-01HA	Furnished by test lab.
E	EarPods	Apple	A1472	N/A	Furnished by test lab.
F	USB 3.0 HDD	WD	WD3C3C0010B SL-0B	WX81A88ALJUC	Furnished by test lab.
G	USB Dongle	Kingston	DataTraveler Exodia	N/A	Furnished by test lab.
H	PC	DELL	OptiPlex 790 MT	64NJVBX	Furnished by test lab.

Radiated Emissions

Item	Shielded	Ferrite Core	Length	Cable Type	Remarks
1	NO	NO	1.2m	Power Cable	Furnished by test lab.
2	NO	NO	1.7m	HDMI Cable	Furnished by test lab.
3	NO	NO	18cm	TypeC to TypeC Cable	Furnished by test lab.
4	NO	NO	2m	RJ-45 Cable	Furnished by test lab.

3 AC POWER LINE CONDUCTED EMISSIONS TEST

3.1 LIMIT

Frequency (MHz)	Limit (dB μ V)	
	Quasi-peak	Average
0.15 - 0.5	66 - 56 *	56 - 46 *
0.5 - 5.0	56	46
5.0 - 30.0	60	50

NOTE:

- (1) The tighter limit applies at the band edges.
- (2) The limit of " * " marked band means the limitation decreases linearly with the logarithm of the frequency in the range.
- (3) The test result calculated as following:
 Measurement Value = Reading Level + Correct Factor
 Correct Factor = Insertion Loss + Cable Loss + Attenuator Factor (if use)
 Margin Level = Measurement Value – Limit Value
 Calculation example:

Reading Level		Correct Factor		Measurement Value
38.22	+	3.45	=	41.67

Measurement Value		Limit Value		Margin Level
41.67	-	60	=	-18.33

The following table is the setting of the receiver.

Receiver Parameter	Setting
Attenuation	10 dB
Start Frequency	0.15 MHz
Stop Frequency	30 MHz
IF Bandwidth	9 KHz

3.2 TEST PROCEDURE

- a. The EUT was placed 0.8 m above the horizontal ground plane with the EUT being connected to the power mains through a line impedance stabilization network (LISN).
 All other support equipment were powered from an additional LISN(s).
 The LISN provides 50 Ohm/50uH of impedance for the measuring instrument.
- b. Interconnecting cables that hang closer than 40 cm to the ground plane shall be folded back and forth in the center forming a bundle to keep the cable above 40 cm.
- c. Excess I/O cables that are not connected to a peripheral shall be bundled in the center.
 The end of the cable will be terminated, using the correct terminating impedance.
 The overall length shall not exceed 1 m.
- d. The LISN is spaced at least 80 cm from the nearest part of the EUT chassis.
- e. For the actual test configuration, please refer to the related Item – EUT TEST PHOTO.

NOTE:

- (1) In the results, each reading is marked as Peak, QP or AVG per the detector used.
 BW=9 kHz (6 dB Bandwidth)
- (2) All readings are Peak unless otherwise stated QP or AVG in column of Note. Both the QP and the AVG readings must be less than the limit for compliance.

3.3 DEVIATION FROM TEST STANDARD

No deviation.

3.4 TEST SETUP

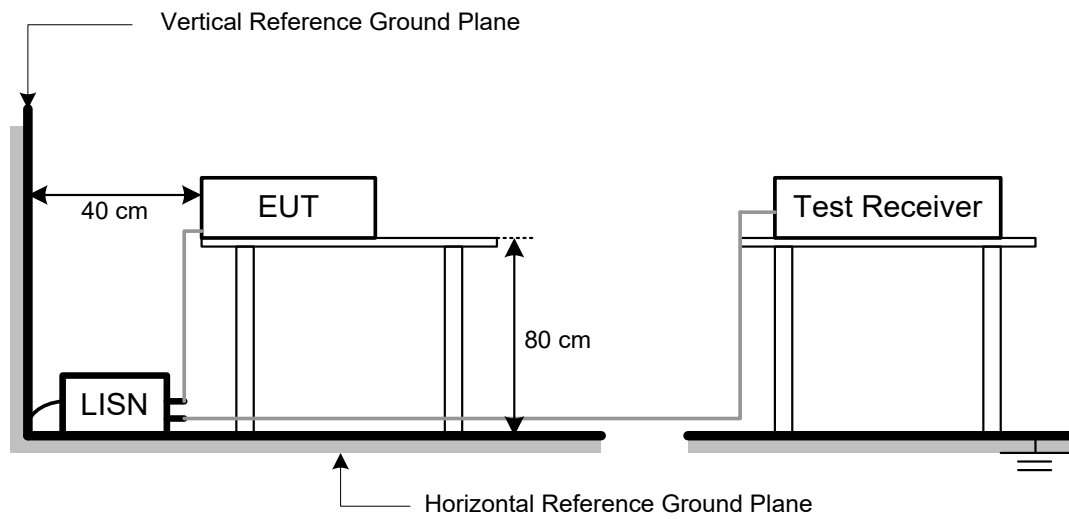

3.5 TEST RESULT

Please refer to the **APPENDIX A**.

4 RADIATED EMISSIONS TEST

4.1 LIMIT

In case the emission fall within the restricted band specified on 15.205, then the 15.209 limit in the table below has to be followed.

LIMITS OF RADIATED EMISSIONS MEASUREMENT (9 kHz to 1000 MHz)

Frequency (MHz)	Field Strength (microvolts/meter)	Measurement Distance (meters)
0.009~0.490	2400/F(KHz)	300
0.490~1.705	24000/F(KHz)	30
1.705~30.0	30	30
30~88	100	3
88~216	150	3
216~960	200	3
960~1000	500	3

LIMITS OF RADIATED EMISSIONS MEASUREMENT (Above 1000 MHz)

Frequency (MHz)	Radiated Emissions (dBuV/m)		Measurement Distance (meters)
	Peak	Average	
Above 1000	74	54	3

NOTE:

- (1) The limit for radiated test was performed according to FCC CFR Title 47, Part 15, Subpart C.
- (2) The tighter limit applies at the band edges.
- (3) Emission level (dBuV/m)=20log Emission level (uV/m).
- (4) The test result calculated as following:

Measurement Value = Reading Level + Correct Factor
 Correct Factor = Antenna Factor + Cable Loss - Amplifier Gain(if use)
 Margin Level = Measurement Value - Limit Value
 Calculation example:

Reading Level		Correct Factor	=	Measurement Value
41.91	+	-8.36	=	33.55

Measurement Value		Limit Value	=	Margin Level
33.55	-	43.50	=	-9.95

Spectrum Parameter	Setting
Attenuation	Auto
Start Frequency	1000 MHz
Stop Frequency	10th carrier harmonic
RBW / VBW (Emission in restricted band)	1MHz / 3MHz for Peak, 1MHz / 1/T for Average

Spectrum Parameter	Setting
Attenuation	Auto
Start ~ Stop Frequency	9KHz~90KHz for PK/AVG detector
Start ~ Stop Frequency	90KHz~110KHz for QP detector
Start ~ Stop Frequency	110KHz~490KHz for PK/AVG detector
Start ~ Stop Frequency	490KHz~30MHz for QP detector
Start ~ Stop Frequency	30MHz~1000MHz for QP detector

4.2 TEST PROCEDURE

- a. The measuring distance of 3 m shall be used for measurements. The EUT was placed on the top of a rotating table 0.8 meter above the ground at a 3 meter semi-anechoic chamber. The table was rotated 360 degrees to determine the position of the highest radiation.(below 1GHz)
- b. The measuring distance of 3 m shall be used for measurements. The EUT was placed on the top of a rotating table 1.5 meter above the ground at a 3 meter semi-anechoic chamber. The table was rotated 360 degrees to determine the position of the highest radiation.(above 1GHz)
- c. The height of the equipment or of the substitution antenna shall be 0.8 m or 1.5 m, the height of the test antenna shall vary between 1 m to 4 m. Both horizontal and vertical polarizations of the antenna are set to make the measurement.
- d. For each suspected emission, the EUT was arranged to its worst case and then the antenna was tuned to heights find the maximum reading (used Bore sight function).
- e. The receiver system was set to peak and average detect function and specified bandwidth with maximum hold mode when the test frequency is above 1GHz.
- f. The initial step in collecting radiated emission data is a receiver peak detector mode pre-scanning the measurement frequency range. Significant peaks are then marked and then Quasi Peak detector mode re-measured.
- g. All readings are Peak unless otherwise stated QP in column of Note. Peak denotes that the Peak reading compliance with the QP Limits and then QP Mode measurement didn't perform. (below 1GHz)
- h. All readings are Peak Mode value unless otherwise stated AVG in column of Note. If the Peak Mode Measured value compliance with the Peak Limits and lower than AVG Limits, the EUT shall be deemed to meet both Peak & AVG Limits and then only Peak Mode was measured, but AVG Mode didn't perform. (above 1GHz)
- i. For the actual test configuration, please refer to the related Item – EUT TEST PHOTO.

4.3 DEVIATION FROM TEST STANDARD

No deviation.

4.4 TEST SETUP

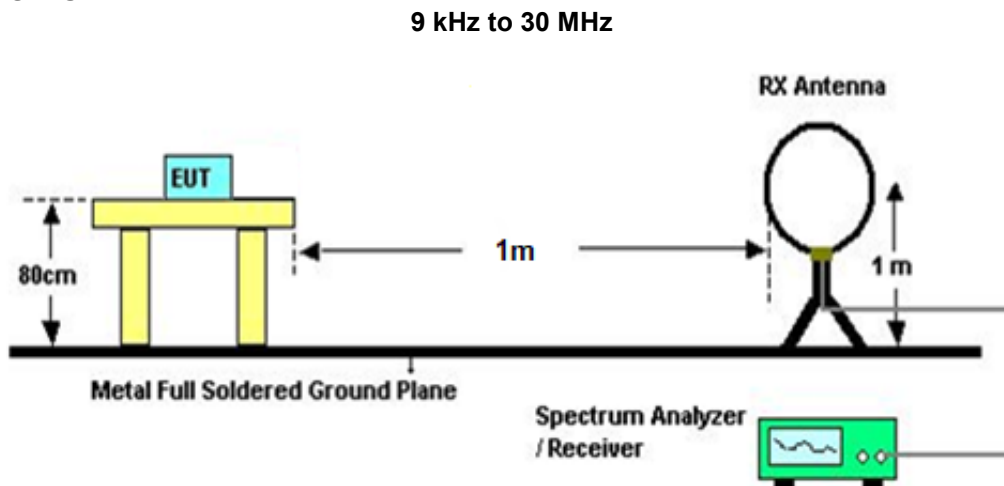

30 MHz to 1 GHz

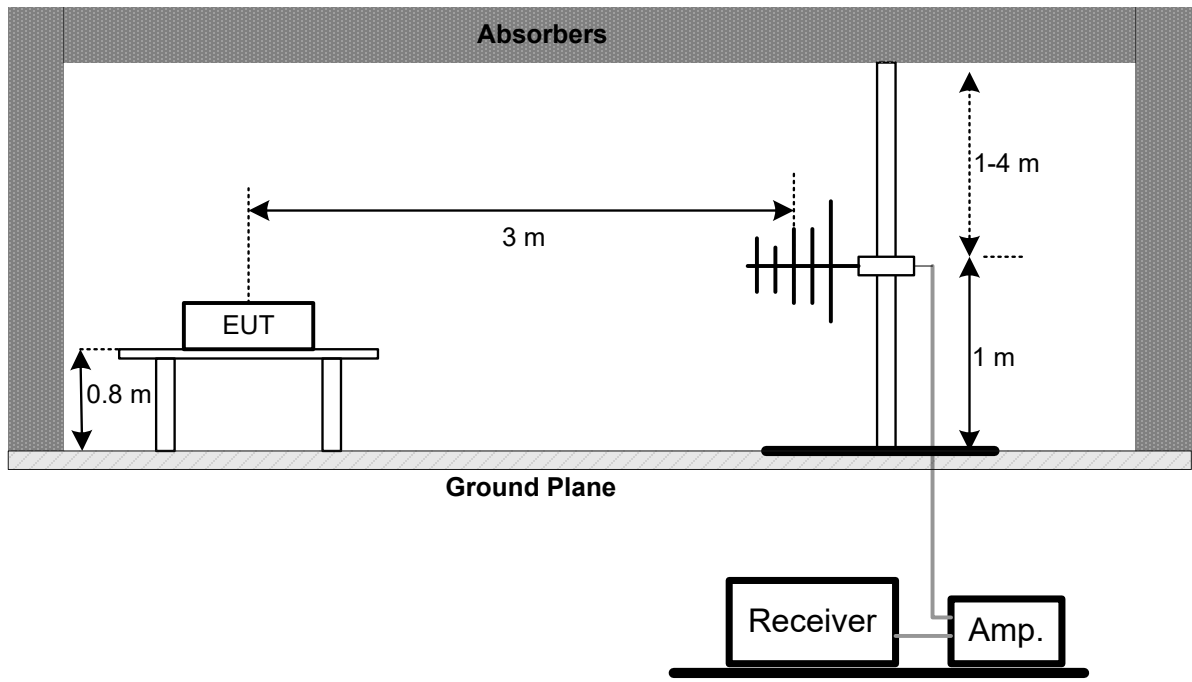

Above 1 GHz

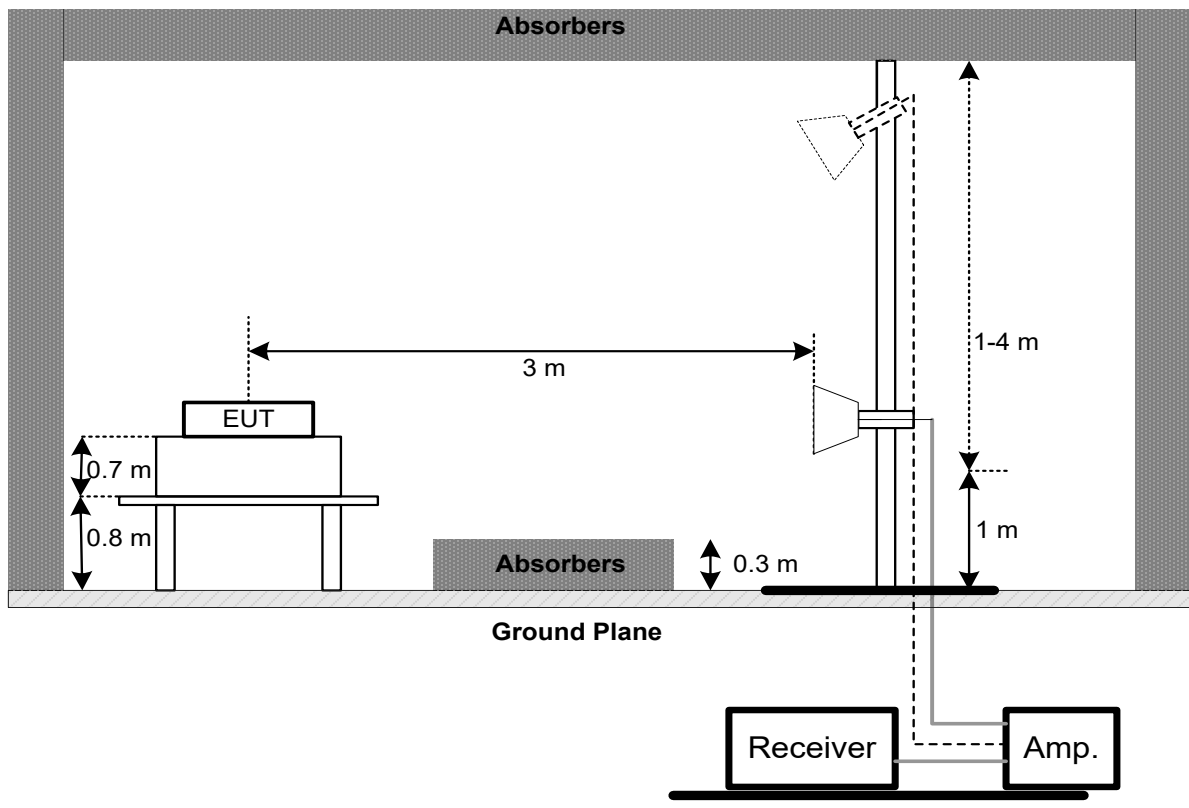

4.5 EUT OPERATING CONDITIONS

The EUT was programmed to be in continuously transmitting mode.

4.6 TEST RESULT – BELOW 30 MHZ

There were no emissions found below 30 MHz within 20 dB of the limit.

4.7 TEST RESULT – 30 MHZ TO 1 GHZ

Please refer to the APPENDIX B.

4.8 TEST RESULT – ABOVE 1 GHZ

Please refer to the APPENDIX C.

NOTE:

- (1) No limit: This is fundamental signal, the judgment is not applicable.
For fundamental signal judgment was referred to Peak output test.

5 OUTPUT POWER TEST

5.1 APPLIED PROCEDURES / LIMIT

FCC Part15 (15.247) , Subpart C				
Section	Test Item	Limit	Frequency Range (MHz)	Result
15.247(b)(3)	Maximum Output Power	1 watt or 30dBm	2400-2483.5	PASS

5.2 TEST PROCEDURE

- a. The EUT was directly connected to the power meter and antenna output port as show in the block diagram below,
- b. The maximum peak conducted output power was performed in accordance with FCC KDB 558074 D01 15.247 Meas Guidance.

5.3 DEVIATION FROM STANDARD

No deviation.

5.4 TEST SETUP



5.5 EUT OPERATION CONDITIONS

The EUT was programmed to be in continuously transmitting mode.

5.6 TEST RESULTS

Please refer to the APPENDIX D.

6 LIST OF MEASURING EQUIPMENTS

AC Power Line Conducted Emissions						
Item	Kind of Equipment	Manufacturer	Type No.	Serial No.	Calibrated Date	Calibrated Until
1	TWO-LINE V-NETWORK	R&S	ENV216	101521	2022/9/28	2023/9/27
2	Test Cable	EMCI	EMCCFD300-BM-BMR-5000	220331	2022/3/31	2023/3/30
3	EMI Test Receiver	R&S	ESR 7	101433	2022/11/16	2023/11/15
4	Measurement Software	EZ	EZ EMC (Version NB-03A1-01)	N/A	N/A	N/A

Radiated Emissions						
Item	Kind of Equipment	Manufacturer	Type No.	Serial No.	Calibrated Date	Calibrated Until
1	Preamplifier	EMCI	EMC330N	980850	2022/9/19	2023/9/18
2	Preamplifier	EMCI	EMC118A45SE	980819	2022/3/8	2023/3/7
3	Preamplifier	EMCI	EMC184045SE	980882	2022/2/9	2023/2/8
4	Preamplifier	EMCI	EMC001340	980579	2022/9/30	2023/9/29
5	Test Cable	EMCI	EMC104-SM-SM-1000	220319	2022/3/15	2023/3/14
6	Test Cable	EMCI	EMC104-SM-SM-3000	220322	2022/3/15	2023/3/14
7	Test Cable	EMCI	EMC104-SM-SM-7000	220324	2022/3/15	2023/3/14
8	EXA Signal Analyzer	keysight	N9020B	MY57120120	2022/3/7	2023/3/6
9	Loop Ant	Electro-Metrics	EMCI-LPA600	291	2022/9/19	2023/9/18
10	Horn Antenna	RFSPIN	DRH18-E	211202A18EN	2022/5/18	2023/5/17
11	Horn Ant	Schwarzbeck	BBHA 9170D	1136	2022/5/18	2023/5/17
12	Log-bicon Antenna	Schwarzbeck	VULB9168	1369	2022/5/20	2023/5/19
13	6dB Attenuator	EMCI	EMCI-N-6-06	AT-N0625	2022/5/20	2023/5/19
14	Measurement Software	EZ	EZ EMC (Version NB-03A1-01)	N/A	N/A	N/A

Output Power						
Item	Kind of Equipment	Manufacturer	Type No.	Serial No.	Calibrated Date	Calibrated Until
1	Power Meter	Anritsu	ML2495A	1128008	2022/6/1	2023/5/31
2	Power Sensor	Anritsu	MA2411B	1126001	2022/6/1	2023/5/31

Remark: "N/A" denotes no model name, no serial no. or no calibration specified.
All calibration period of equipment list is one year.

7 EUT TEST PHOTO

Please refer to document Appendix No.: TP-2208C205-1 (APPENDIX-TEST PHOTOS).

8 EUT PHOTOS

Please refer to document Appendix No.: EP-2208C205-1 (APPENDIX-EUT PHOTOS).

APPENDIX A AC POWER LINE CONDUCTED EMISSIONS

Test Mode	Normal	Tested Date	2022/11/25
Test Frequency	-	Phase	Line

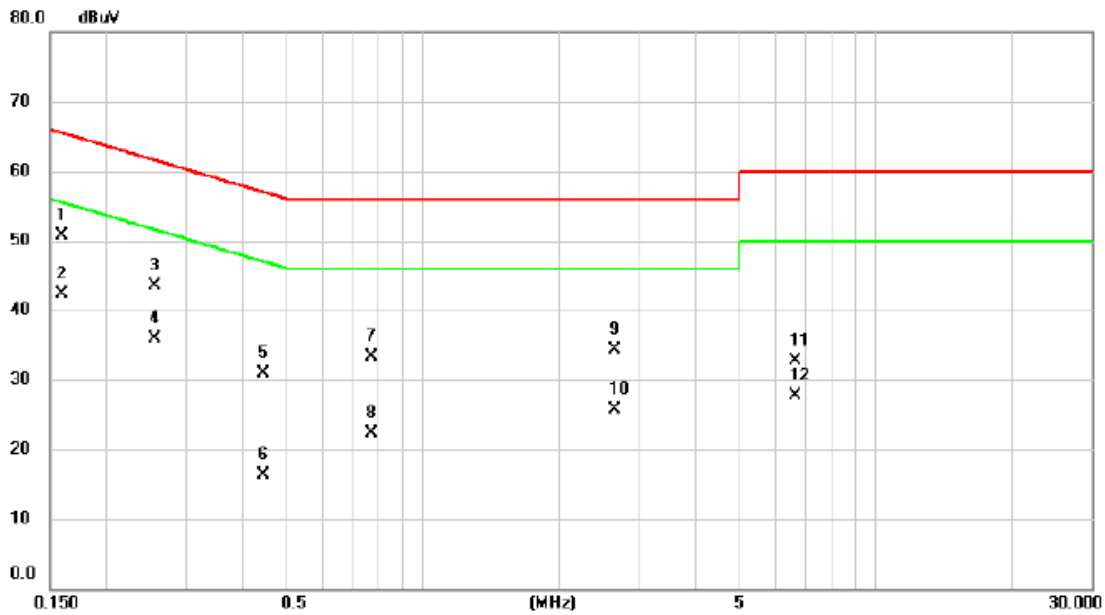

No.	Mk.	Freq. MHz	Reading Level dBuV	Correct Factor dB	Measure- ment dBuV	Limit dBuV	Margin dB	Detector	Comment
1		0.1590	41.02	9.64	50.66	65.52	-14.86	QP	
2	*	0.1590	32.73	9.64	42.37	55.52	-13.15	AVG	
3		0.2556	33.96	9.63	43.59	61.57	-17.98	QP	
4		0.2556	26.23	9.63	35.86	51.57	-15.71	AVG	
5		0.4447	21.25	9.63	30.88	56.97	-26.09	QP	
6		0.4447	6.73	9.63	16.36	46.97	-30.61	AVG	
7		0.7687	23.59	9.66	33.25	56.00	-22.75	QP	
8		0.7687	12.70	9.66	22.36	46.00	-23.64	AVG	
9		2.6452	24.63	9.72	34.35	56.00	-21.65	QP	
10		2.6452	15.90	9.72	25.62	46.00	-20.38	AVG	
11		6.6480	22.96	9.80	32.76	60.00	-27.24	QP	
12		6.6480	17.85	9.80	27.65	50.00	-22.35	AVG	

REMARKS:

- (1) Measurement Value = Reading Level + Correct Factor.
- (2) Margin Level = Measurement Value - Limit Value.

Test Mode	Normal	Tested Date	2022/11/25
Test Frequency	-	Phase	Neutral

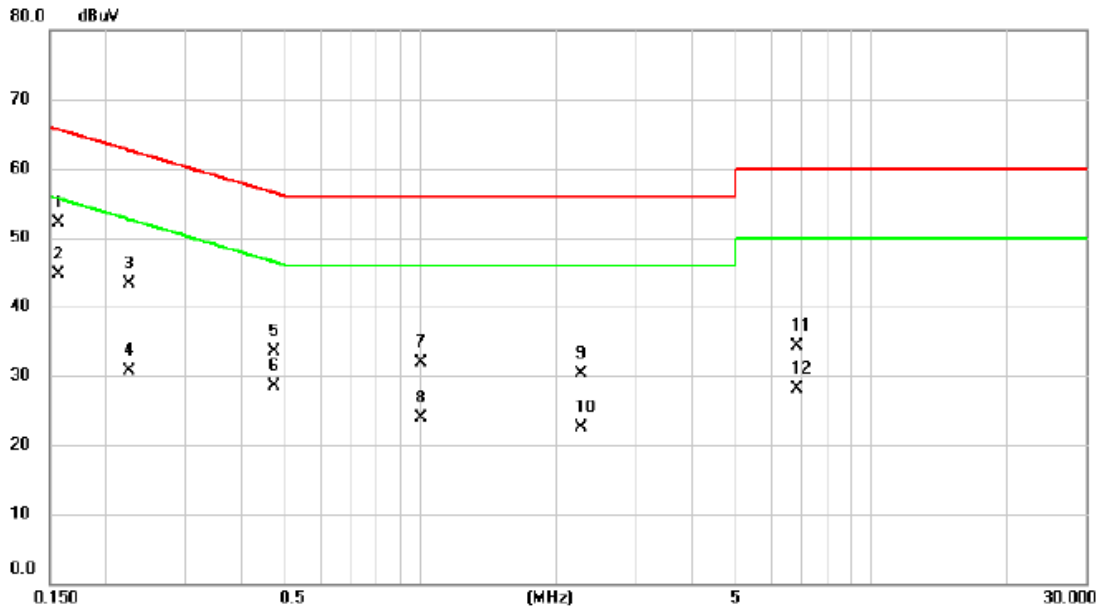

No.	Mk.	Freq. MHz	Reading Level dBuV	Correct Factor dB	Measure- ment dBuV	Limit dBuV	Margin dB	Detector	Comment
1		0.1573	42.54	9.65	52.19	65.61	-13.42	QP	
2	*	0.1573	35.07	9.65	44.72	55.61	-10.89	AVG	
3		0.2244	33.69	9.64	43.33	62.65	-19.32	QP	
4		0.2244	21.02	9.64	30.66	52.65	-21.99	AVG	
5		0.4740	23.83	9.64	33.47	56.44	-22.97	QP	
6		0.4740	18.90	9.64	28.54	46.44	-17.90	AVG	
7		1.0005	22.24	9.68	31.92	56.00	-24.08	QP	
8		1.0005	14.31	9.68	23.99	46.00	-22.01	AVG	
9		2.2628	20.57	9.72	30.29	56.00	-25.71	QP	
10		2.2628	12.83	9.72	22.55	46.00	-23.45	AVG	
11		6.8370	24.52	9.83	34.35	60.00	-25.65	QP	
12		6.8370	18.30	9.83	28.13	50.00	-21.87	AVG	

REMARKS:

- (1) Measurement Value = Reading Level + Correct Factor.
- (2) Margin Level = Measurement Value - Limit Value.

Test Mode	Idle	Tested Date	2022/11/25
Test Frequency	-	Phase	Line

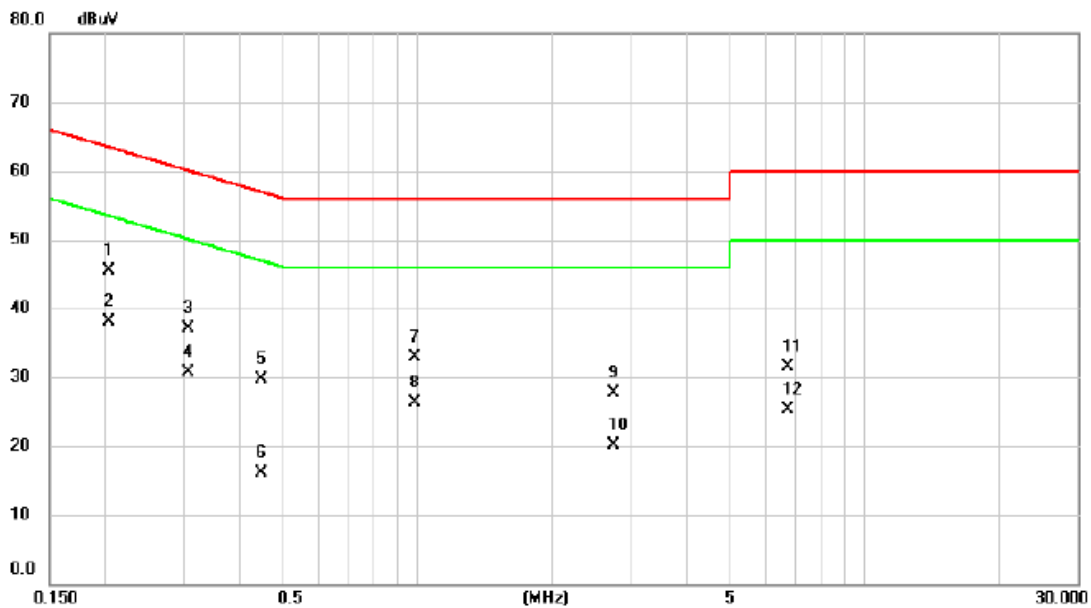

No. Mk.	Freq. MHz	Reading Level dBuV	Correct Factor dB	Measurement dBuV	Limit dBuV	Margin dB	Detector	Comment
1	0.2040	35.87	9.63	45.50	63.45	-17.95	QP	
2 *	0.2040	28.44	9.63	38.07	53.45	-15.38	AVG	
3	0.3074	27.51	9.63	37.14	60.04	-22.90	QP	
4	0.3074	21.13	9.63	30.76	50.04	-19.28	AVG	
5	0.4470	20.04	9.63	29.67	56.93	-27.26	QP	
6	0.4470	6.54	9.63	16.17	46.93	-30.76	AVG	
7	0.9870	23.18	9.67	32.85	56.00	-23.15	QP	
8	0.9870	16.71	9.67	26.38	46.00	-19.62	AVG	
9	2.7510	17.98	9.72	27.70	56.00	-28.30	QP	
10	2.7510	10.44	9.72	20.16	46.00	-25.84	AVG	
11	6.7132	21.77	9.80	31.57	60.00	-28.43	QP	
12	6.7132	15.55	9.80	25.35	50.00	-24.65	AVG	

REMARKS:

- (1) Measurement Value = Reading Level + Correct Factor.
- (2) Margin Level = Measurement Value - Limit Value.

Test Mode	Idle	Tested Date	2022/11/25
Test Frequency	-	Phase	Neutral

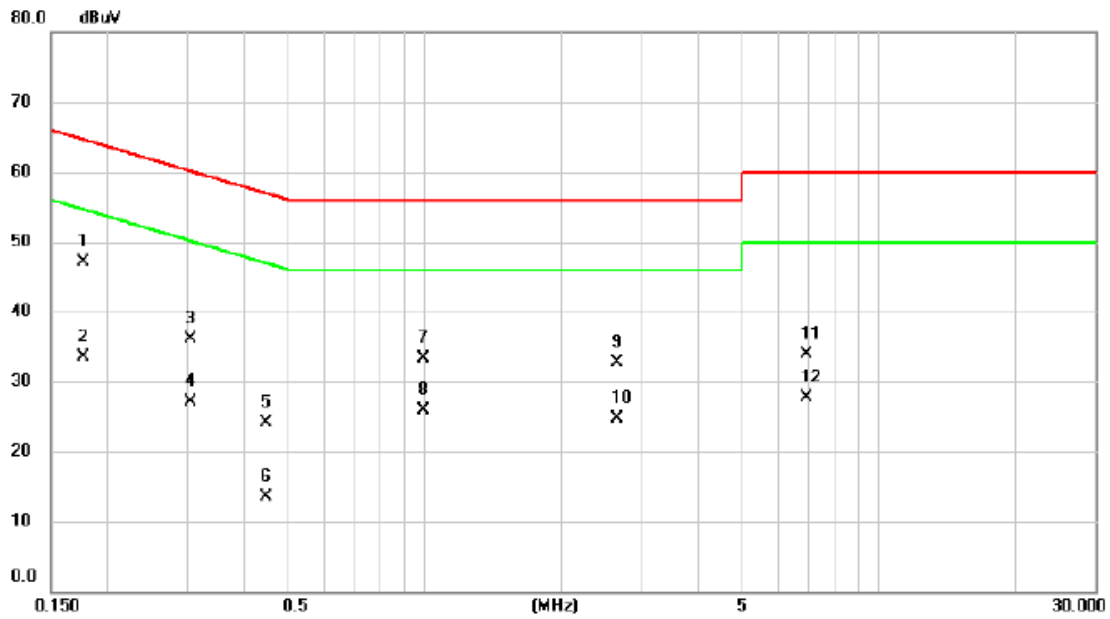

No. Mk.	Freq. MHz	Reading Level dBuV	Correct Factor dB	Measurement dBuV	Limit dBuV	Margin dB	Detector	Comment
1 *	0.1770	37.46	9.64	47.10	64.63	-17.53	QP	
2	0.1770	23.91	9.64	33.55	54.63	-21.08	AVG	
3	0.3052	26.44	9.64	36.08	60.10	-24.02	QP	
4	0.3052	17.42	9.64	27.06	50.10	-23.04	AVG	
5	0.4470	14.39	9.64	24.03	56.93	-32.90	QP	
6	0.4470	3.77	9.64	13.41	46.93	-33.52	AVG	
7	0.9960	23.53	9.68	33.21	56.00	-22.79	QP	
8	0.9960	16.15	9.68	25.83	46.00	-20.17	AVG	
9	2.6542	23.07	9.73	32.80	56.00	-23.20	QP	
10	2.6542	15.07	9.73	24.80	46.00	-21.20	AVG	
11	6.9337	24.06	9.83	33.89	60.00	-26.11	QP	
12	6.9337	17.90	9.83	27.73	50.00	-22.27	AVG	

REMARKS:

- (1) Measurement Value = Reading Level + Correct Factor.
- (2) Margin Level = Measurement Value - Limit Value.

APPENDIX B RADIATED EMISSIONS - 30 MHZ TO 1 GHZ

Test Mode	BLE 5.0 (1 Mbps)	Test Date	2022/12/15
Test Frequency	2480MHz	Polarization	Vertical
Temp	23°C	Hum.	59%

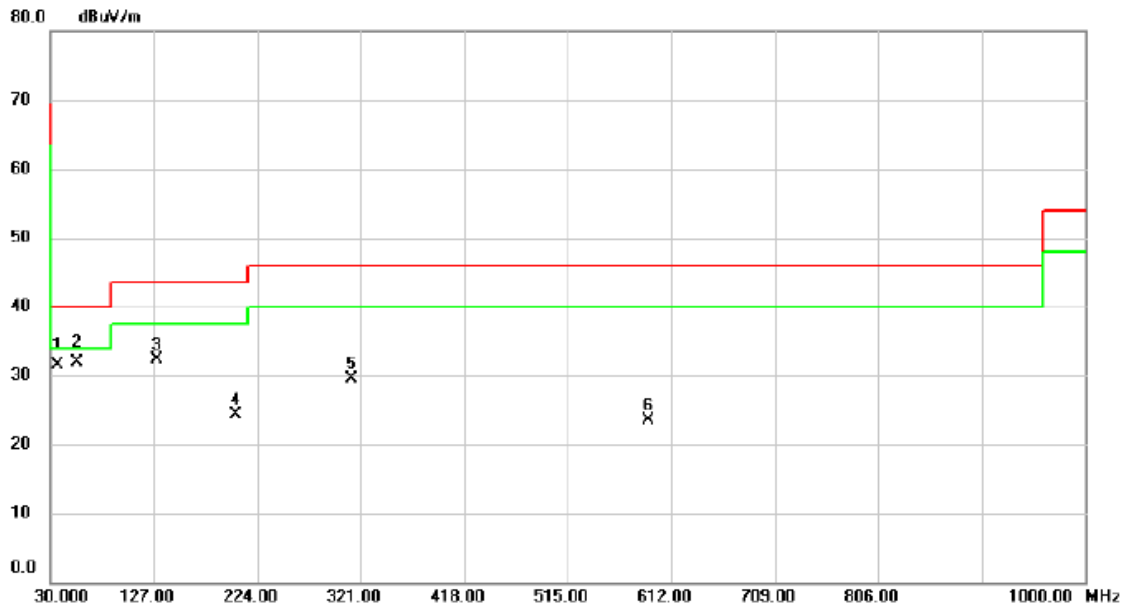

No.	Mk.	Freq. MHz	Reading Level dBuV	Correct Factor dB	Measure- ment dBuV/m	Limit dBuV/m	Over dB	Detector	Comment
1		37.0810	49.55	-18.07	31.48	40.00	-8.52	QP	
2	*	54.9613	50.21	-18.40	31.81	40.00	-8.19	QP	
3		130.0393	51.68	-19.47	32.21	43.50	-11.29	peak	
4		203.4360	46.00	-21.79	24.21	43.50	-19.29	peak	
5		312.0437	47.59	-18.04	29.55	46.00	-16.45	peak	
6		590.6277	34.48	-10.91	23.57	46.00	-22.43	peak	

REMARKS:

- (1) Measurement Value = Reading Level + Correct Factor.
- (2) Margin Level = Measurement Value - Limit Value.

Test Mode	BLE 5.0 (1 Mbps)	Test Date	2022/12/15
Test Frequency	2480MHz	Polarization	Horizontal
Temp	23°C	Hum.	59%

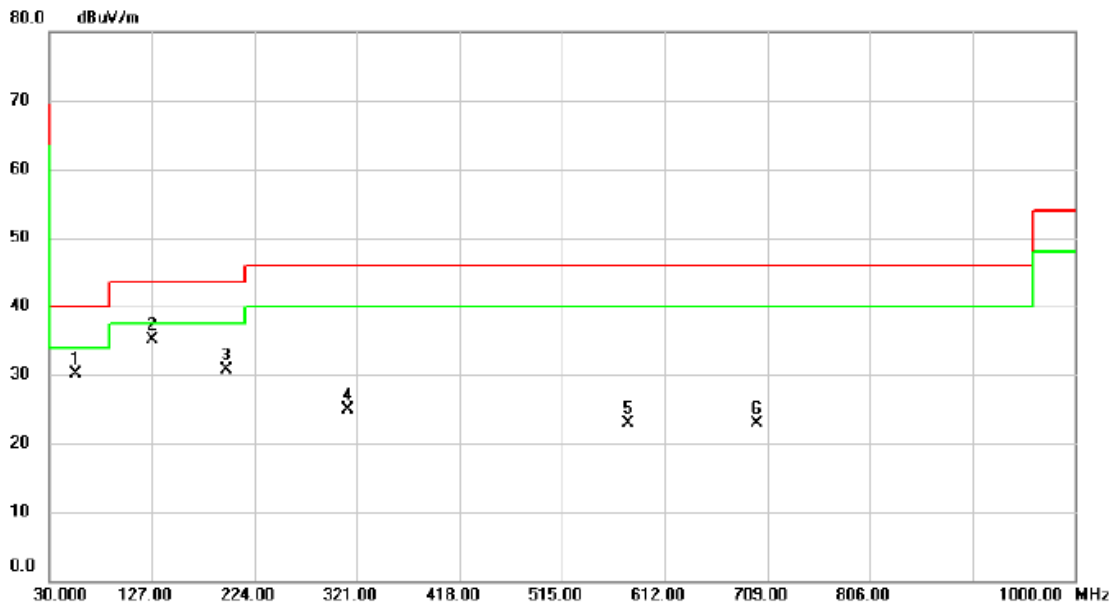

No. Mk.	Freq. MHz	Reading Level dBuV	Correct Factor dB	Measurement dBuV/m	Limit dBuV/m	Over dB	Detector	Comment
1	54.9937	48.50	-18.40	30.10	40.00	-9.90	peak	
2 *	127.9700	54.78	-19.60	35.18	43.50	-8.32	peak	
3	197.9393	52.22	-21.58	30.64	43.50	-12.86	peak	
4	312.3023	43.03	-18.04	24.99	46.00	-21.01	peak	
5	577.7590	34.14	-11.28	22.86	46.00	-23.14	peak	
6	699.1060	32.07	-9.20	22.87	46.00	-23.13	peak	

REMARKS:

- (1) Measurement Value = Reading Level + Correct Factor.
- (2) Margin Level = Measurement Value - Limit Value.

APPENDIX C RADIATED EMISSIONS - ABOVE 1 GHZ

Test Mode	BLE 5.0 (1 Mbps)	Test Date	2022/11/30
Test Frequency	2480MHz	Polarization	Vertical
Temp	23°C	Hum.	59%

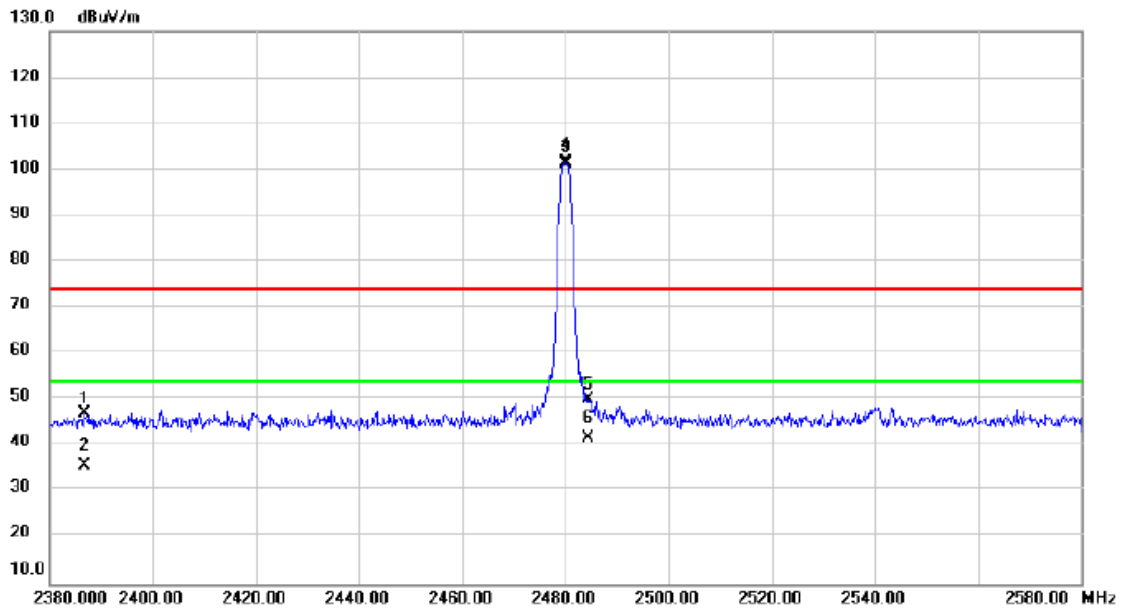

No.	Mk.	Freq. MHz	Reading Level dBuV	Correct Factor dB	Measure- ment dBuV/m	Limit dBuV/m	Over dB	Detector	Comment
1		2386.900	52.68	-5.77	46.91	74.00	-27.09	peak	
2		2386.900	41.55	-5.77	35.78	54.00	-18.22	AVG	
3	X	2480.000	107.40	-5.65	101.75	74.00	27.75	peak	No Limit
4	*	2480.000	106.85	-5.65	101.20	54.00	47.20	AVG	No Limit
5		2484.440	55.75	-5.64	50.11	74.00	-23.89	peak	
6		2484.440	47.35	-5.64	41.71	54.00	-12.29	AVG	

REMARKS:

- (1) Measurement Value = Reading Level + Correct Factor.
- (2) Margin Level = Measurement Value - Limit Value.

Test Mode	BLE 5.0 (1 Mbps)	Test Date	2022/12/1
Test Frequency	2480MHz	Polarization	Vertical
Temp	23°C	Hum.	59%

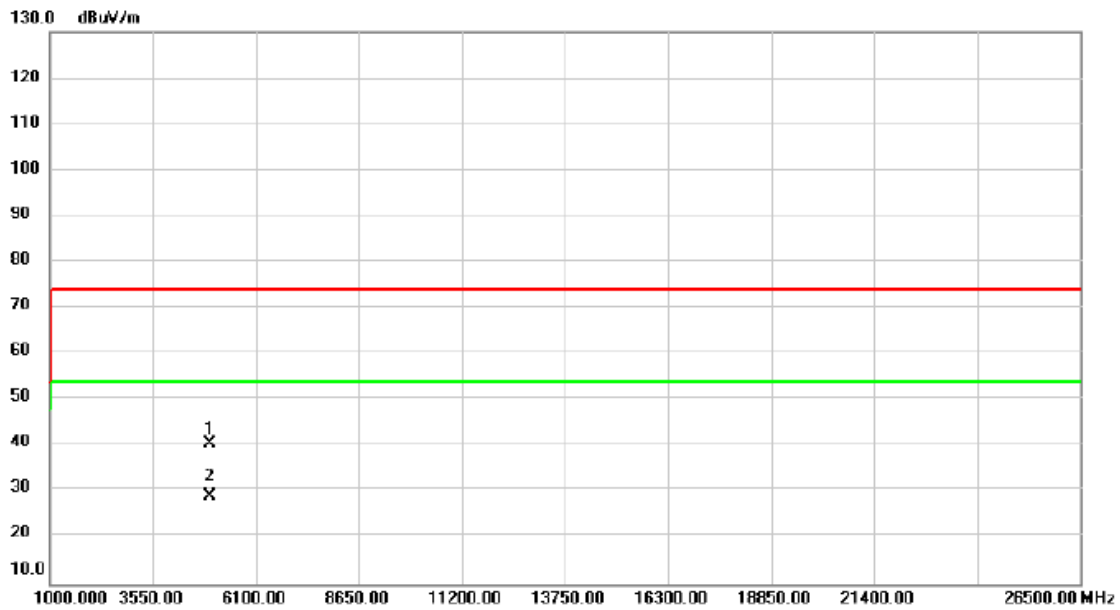

No.	Mk.	Freq.	Reading Level	Correct Factor	Measurement	Limit	Over	Detector	Comment
		MHz	dBuV	dB	dBuV/m	dBuV/m	dB		
1		4960.000	39.35	1.18	40.53	74.00	-33.47	peak	
2	*	4960.000	27.82	1.18	29.00	54.00	-25.00	AVG	

REMARKS:

- (1) Measurement Value = Reading Level + Correct Factor.
- (2) Margin Level = Measurement Value - Limit Value.

Test Mode	BLE 5.0 (1 Mbps)	Test Date	2022/12/1
Test Frequency	2480MHz	Polarization	Horizontal
Temp	23°C	Hum.	59%

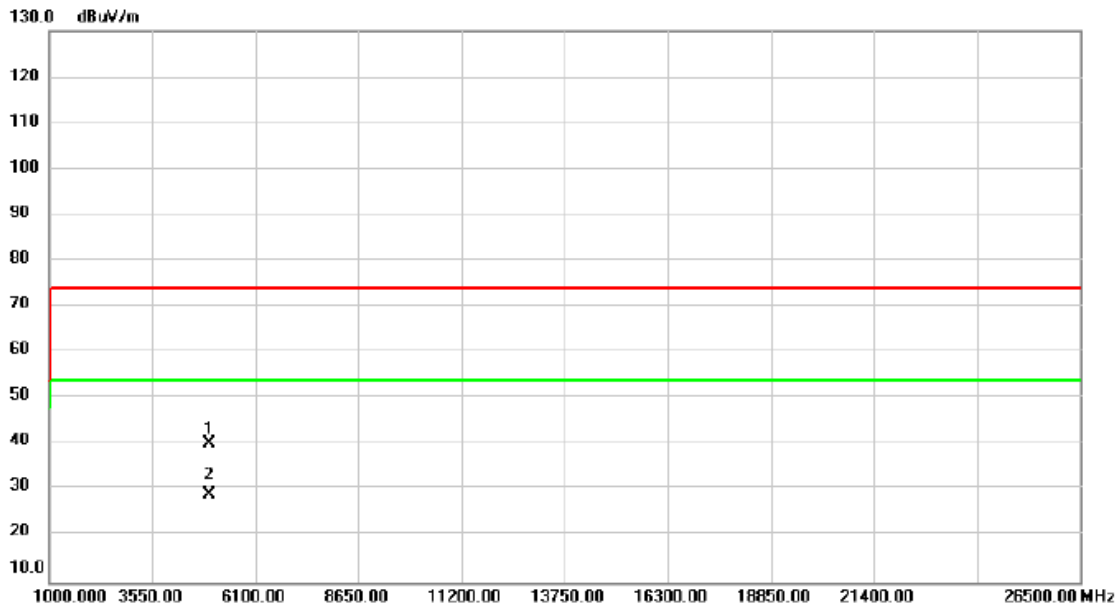

No.	Mk.	Freq.	Reading Level	Correct Factor	Measurement	Limit	Over	Detector	Comment
		MHz	dBuV	dB	dBuV/m	dBuV/m	dB		
1		4960.000	38.86	1.18	40.04	74.00	-33.96	peak	
2	*	4960.000	27.95	1.18	29.13	54.00	-24.87	AVG	

REMARKS:

- (1) Measurement Value = Reading Level + Correct Factor.
- (2) Margin Level = Measurement Value - Limit Value.

APPENDIX D OUTPUT POWER

Test Mode :	1Mbps	Tested Date	2022/11/25
-------------	-------	-------------	------------

Frequency (MHz)	Conducted Power (dBm)	Conducted Power (W)	Max. Limit (dBm)	Max. Limit (W)	Test Result
2402	8.13	0.0065	30.00	1.0000	Pass
2440	8.25	0.0067	30.00	1.0000	Pass
2480	8.74	0.0075	30.00	1.0000	Pass

End of Test Report