

FCC Radio Test Report

FCC ID: RWO-RZ090368QCNFA**This report concerns: Class II Permissive Changes**

Report No. : BTL-FCCP-1-2212C001
Equipment : Notebook PC
Model Name : RZ09-0482
Brand Name : RAZER
Applicant : Razer Inc.
Address : 9 Pasteur, Suite 100, Irvine, CA92618, USA.
Manufacturer : Razer Inc.
Address : 9 Pasteur, Suite 100, Irvine, CA92618, USA.

Radio Function : Bluetooth EDR

FCC Rule Part(s) : FCC CFR Title 47, Part 15, Subpart C (15.247)
Measurement Procedure(s) : ANSI C63.10-2013

Date of Receipt : 2022/12/19
Date of Test : 2022/12/19 ~ 2023/2/1
Issued Date : 2023/2/10

The above equipment has been tested and found in compliance with the requirement of the above standards by BTL Inc.

Prepared by : Eric Lee
 Eric Lee, Engineer

Approved by : Jerry Chuang
 Jerry Chuang, Supervisor

**BTL Inc.**

No.18, Ln. 171, Sec. 2, Jiuzong Rd., Neihu Dist., Taipei City 114, Taiwan

Tel: +886-2-2657-3299 Fax: +886-2-2657-3331 Web: www.newbtl.com Service mail: btl_qa@newbtl.com

Declaration

BTL represents to the client that testing is done in accordance with standard procedures as applicable and that test instruments used has been calibrated with standards traceable to international standard(s) and/or national standard(s).

BTL's reports apply only to the specific samples tested under conditions. It is manufacture's responsibility to ensure that additional production units of this model are manufactured with the identical electrical and mechanical components. **BTL** shall have no liability for any declarations, inferences or generalizations drawn by the client or others from **BTL** issued reports.

This report is the confidential property of the client. As a mutual protection to the clients, the public and ourselves, the test report shall not be reproduced, except in full, without our written approval.

BTL's laboratory quality assurance procedures are in compliance with the **ISO/IEC 17025** requirements, and accredited by the conformity assessment authorities listed in this test report.

BTL is not responsible for the sampling stage, so the results only apply to the sample as received.

The information, data and test plan are provided by manufacturer which may affect the validity of results, so it is manufacturer's responsibility to ensure that the apparatus meets the essential requirements of applied standards and in all the possible configurations as representative of its intended use.

Limitation

For the use of the authority's logo is limited unless the Test Standard(s)/Scope(s)/Item(s) mentioned in this test report is (are) included in the conformity assessment authorities acceptance respective.

Please note that the measurement uncertainty is provided for informational purpose only and are not use in determining the Pass/Fail results.

CONTENTS

1	SUMMARY OF TEST RESULTS	5
1.1	TEST FACILITY	6
1.2	MEASUREMENT UNCERTAINTY	6
1.3	TEST ENVIRONMENT CONDITIONS	6
1.4	TABLE OF PARAMETERS OF TEST SOFTWARE SETTING	6
2	GENERAL INFORMATION	7
2.1	DESCRIPTION OF EUT	7
2.2	TEST MODES	9
2.3	BLOCK DIAGRAM SHOWING THE CONFIGURATION OF SYSTEM TESTED	10
2.4	SUPPORT UNITS	11
3	AC POWER LINE CONDUCTED EMISSIONS TEST	12
3.1	LIMIT	12
3.2	TEST PROCEDURE	12
3.3	DEVIATION FROM TEST STANDARD	12
3.4	TEST SETUP	13
3.5	TEST RESULT	13
4	RADIATED EMISSIONS TEST	14
4.1	LIMIT	14
4.2	TEST PROCEDURE	15
4.3	DEVIATION FROM TEST STANDARD	15
4.4	TEST SETUP	15
4.5	EUT OPERATING CONDITIONS	16
4.6	TEST RESULT – BELOW 30 MHZ	17
4.7	TEST RESULT – 30 MHZ TO 1 GHZ	17
4.8	TEST RESULT – ABOVE 1 GHZ	17
5	OUTPUT POWER TEST	18
5.1	LIMIT	18
5.2	TEST PROCEDURE	18
5.3	DEVIATION FROM STANDARD	18
5.4	TEST SETUP	18
5.5	EUT OPERATION CONDITIONS	18
5.6	TEST RESULTS	18
6	LIST OF MEASURING EQUIPMENTS	19
7	EUT TEST PHOTO	20
8	EUT PHOTOS	20
APPENDIX A	AC POWER LINE CONDUCTED EMISSIONS	21
APPENDIX B	RADIATED EMISSIONS - 30 MHZ TO 1 GHZ	26
APPENDIX C	RADIATED EMISSIONS - ABOVE 1 GHZ	29
APPENDIX D	OUTPUT POWER	36

REVISION HISTORY

Report No.	Version	Description	Issued Date	Note
BTL-FCCP-1-2212C001	R00	Original Report.	2023/2/10	Valid

1 SUMMARY OF TEST RESULTS

Test procedures according to the technical standards.

Standard(s) Section	Description	Test Result	Judgement	Remark
15.207	AC Power Line Conducted Emissions	APPENDIX A	Pass	-----
15.205 15.209 15.247(d)	Radiated Emissions	APPENDIX B APPENDIX C	Pass	-----
15.247 (a)(1)(iii)	Number of Hopping Frequency	-----	Pass	-----
15.247 (a)(1)(iii)	Average Time of Occupancy	-----	Pass	-----
15.247 (a)(1)	Hopping Channel Separation	-----	Pass	-----
15.247 (a)(1)	Bandwidth	-----	Pass	-----
15.247 (b)(1)	Output Power	APPENDIX D	Pass	-----
15.247(d)	Antenna conducted Spurious Emission	-----	Pass	-----
15.203	Antenna Requirement	-----	Pass	-----

NOTE:

- (1) "N/A" denotes test is not applicable in this Test Report.
- (2) The report format version is TP.1.1.1.
- (3) The antenna gain of EUT is smaller than that of the module. So in this report the worst cases of radiated spurious emissions and AC Power Line Conducted Emissions were evaluated and recorded. And evaluated the output power items and recorded in the report. For the test results of all other test items please refer to module test reports.

1.1 TEST FACILITY

The test locations stated below are under the TAF Accreditation Number 0659.

The test location(s) used to collect the test data in this report are:

No. 68-1, Ln. 169, Sec. 2, Datong Rd., Xizhi Dist., New Taipei City 221, Taiwan
(FCC DN: TW0659)

C05 CB08 CB11 SR10 SR11

No. 72, Ln. 169, Sec. 2, Datong Rd., Xizhi Dist., New Taipei City 221, Taiwan
(FCC DN: TW0659)

C06 CB21 CB22

1.2 MEASUREMENT UNCERTAINTY

The reported uncertainty of measurement $y \pm U$, where expanded uncertainty U is based on a standard uncertainty multiplied by a coverage factor of $k = 2$, providing a level of confidence of approximately **95 %**. The measurement instrumentation uncertainty considerations contained in CISPR 16-4-2. The BTL measurement uncertainty is less than the CISPR 16-4-2 U_{cispr} requirement.

A. AC power line conducted emissions test:

Test Site	Method	Measurement Frequency Range	U (dB)
C05	CISPR	150 kHz ~ 30 MHz	3.44

B. Radiated emissions test:

Test Site	Measurement Frequency Range	U (dB)
CB21	0.03 GHz ~ 0.2 GHz	4.17
	0.2 GHz ~ 1 GHz	4.72
	1 GHz ~ 6 GHz	5.21
	6 GHz ~ 18 GHz	5.51
	18 GHz ~ 26 GHz	3.69
	26 GHz ~ 40 GHz	4.23

C. Conducted test:

Test Item	U,(dB)
Output power	0.3659

NOTE:

Unless specifically mentioned, the uncertainty of measurement has not been taken into account to declare the compliance or non-compliance to the specification.

1.3 TEST ENVIRONMENT CONDITIONS

Test Item	Environment Condition	Test Voltage	Tested by
AC Power Line Conducted Emissions	21°C, 65%	AC 120V/60Hz	Paul Shen
Radiated emissions below 1 GHz	23°C, 59%	AC 120V/60Hz	Mark Wang
Radiated emissions above 1 GHz	23°C, 59%	AC 120V/60Hz	Mark Wang
Output Power	22.3°C, 51%	AC 120V/60Hz	Tim Lee

1.4 TABLE OF PARAMETERS OF TEST SOFTWARE SETTING

Test Software	QRCT V4.0			
Modulation Mode	2402 MHz	2441 MHz	2480 MHz	Data Rate
GFSK	10	10	11	1 Mbps
$\pi/4$ -DQPSK	10	10	11	2 Mbps
8DPSK	11	10	11	3 Mbps

2 GENERAL INFORMATION

2.1 DESCRIPTION OF EUT

Equipment	Notebook PC
Model Name	RZ09-0482
Brand Name	RAZER
Model Difference	N/A
Power Source	#1 DC voltage supplied from AC adapter. #2 Supplied from battery. Model: RC30-0482
Power Rating	#1 I/P: 100-240V~3.6A 50/60Hz O/P: 19.5V==11.8A #2 DC 15.4V, 4422mAh, 68.1Wh
Products Covered	1* POWER Adapter: RC30-024801
Operation Band	2400 MHz ~ 2483.5 MHz
Operation Frequency	2402 MHz ~ 2480 MHz
Modulation Type	GFSK, $\pi/4$ -DQPSK, 8DPSK
Modulation Technology	FHSS
Transfer Rate	1 Mbps, 2 Mbps, 3Mbps
Output Power Max.	1 Mbps: 14.51 dBm (0.0282 W) 2 Mbps: 12.80 dBm (0.0191 W) 3 Mbps: 13.01 dBm (0.0200 W)
Test Model	RZ09-0482
Sample Status	Engineering Sample
EUT Modification(s)	N/A

NOTE:

- (1) The above EUT information is declared by manufacturer and for more detailed features description, please refers to the manufacturer's specifications or user's manual.

(2) Channel List:

Channel	Frequency (MHz)	Channel	Frequency (MHz)	Channel	Frequency (MHz)
00	2402	27	2429	54	2456
01	2403	28	2430	55	2457
02	2404	29	2431	56	2458
03	2405	30	2432	57	2459
04	2406	31	2433	58	2460
05	2407	32	2434	59	2461
06	2408	33	2435	60	2462
07	2409	34	2436	61	2463
08	2410	35	2437	62	2464
09	2411	36	2438	63	2465
10	2412	37	2439	64	2466
11	2413	38	2440	65	2467
12	2414	39	2441	66	2468
13	2415	40	2442	67	2469
14	2416	41	2443	68	2470
15	2417	42	2444	69	2471
16	2418	43	2445	70	2472
17	2419	44	2446	71	2473
18	2420	45	2447	72	2474
19	2421	46	2448	73	2475
20	2422	47	2449	74	2476
21	2423	48	2450	75	2477
22	2424	49	2451	76	2478
23	2425	50	2452	77	2479
24	2426	51	2453	78	2480
25	2427	52	2454		
26	2428	53	2455		

(3) Table for Filed Antenna:

Ant.	Manufacturer	P/N	Type	Connector	Gain (dBi)
1	Amphenol	BY5964-16-001-C	PIFA	N/A	3.16

Note:

(1) Ant.1 refers to main antenna.

(2) The AUX antenna connector of the module connected to the MAIN antenna of the EUT.

- (4) The above Antenna information are derived from the antenna data sheet provided by manufacturer and for more detailed features description, please refer to the manufacturer's specifications, the laboratory shall not be held responsible.

2.2 TEST MODES

Test Items	Test mode	Channel	Note
AC power line conducted emissions	Normal/Idle	-	-
Transmitter Radiated Emissions (below 1GHz)	1 Mbps	00	-
Transmitter Radiated Emissions (above 1GHz)	1/3 Mbps	00	Bandedge
	1/3 Mbps	00/39	Harmonic
Output Power	1/2/3 Mbps	00/39/78	-

NOTE:

- (1) For radiated emission band edge test, both Vertical and Horizontal are evaluated, but only the worst case (Vertical) is recorded.

2.3 BLOCK DIAGRAM SHOWING THE CONFIGURATION OF SYSTEM TESTED

Equipment letters and Cable numbers refer to item numbers described in the tables of clause 2.4.

AC power line conducted emissions

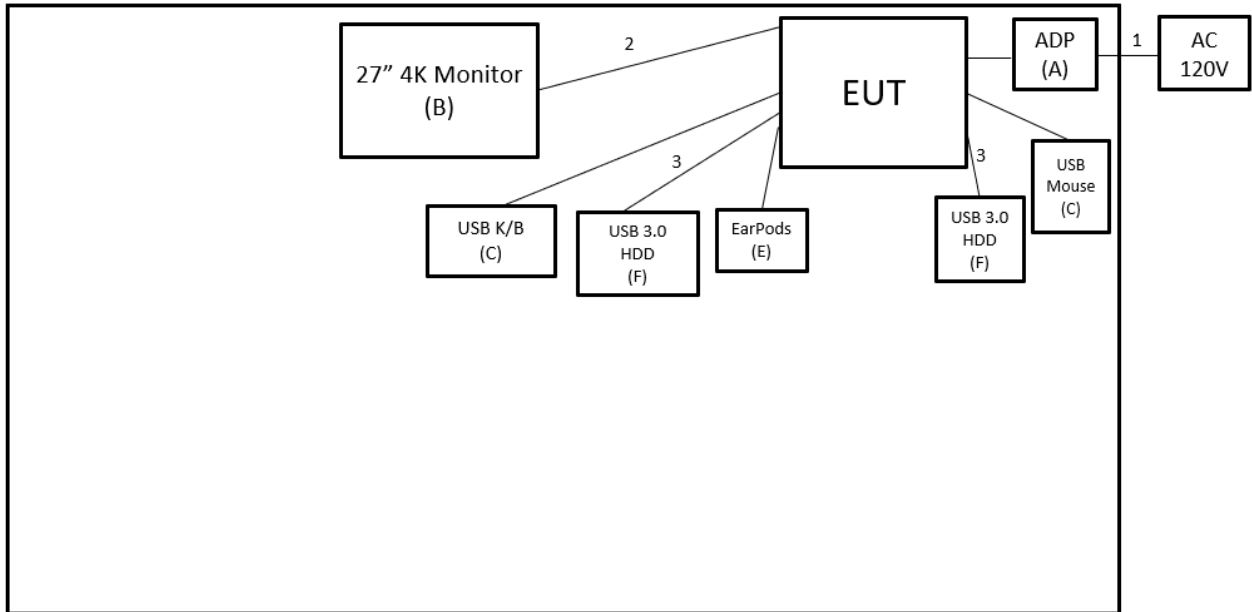

Radiated Emissions

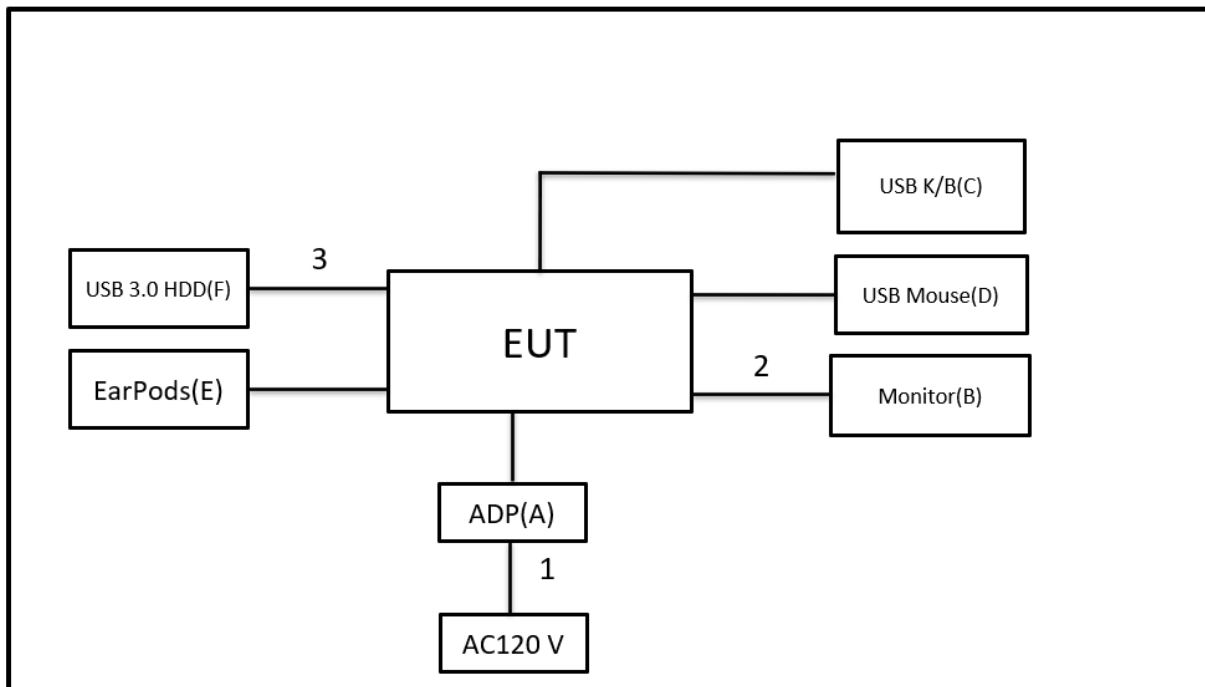

2.4 SUPPORT UNITS

AC power line conducted emissions

Item	Equipment	Brand	Model No.	Series No.	Remarks
A	ADP	Razer	RC30-024801	N/A	Supplied by test requester.
B	27" 4K Monitor	DELL	U2720Q	CN-083VF-WSL00-0B7-332L	Furnished by test lab.
C	USB K/B	DELL	KB216t	CN-0W33XP-L0300-797-05TY-A03	Furnished by test lab.
D	USB Mouse	DELL	MOCZUL	CN-049TWY-PRC00-79E-01HA	Furnished by test lab.
E	EarPods	Apple	A1472	N/A	Furnished by test lab.
F	USB 3.0 HDD	WD	WDBC3C0010BSL-0B	WX81A88ALJUC	Furnished by test lab.

Item	Shielded	Ferrite Core	Length	Cable Type	Remarks
1	N/A	N/A	1m	Power Cord	Furnished by test lab.
2	N/A	N/A	1.7m	HDMI Cable	Furnished by test lab.
3	N/A	N/A	0.18m	Type C to Type C Cable	Furnished by test lab.

Radiated Emissions

Item	Equipment	Brand	Model No.	Series No.	Remarks
A	ADP	Razer	RC30-024801	N/A	Supplied by test requester.
B	27" 4K Monitor	DELL	U2720Q	CN-083VF-WSL00-0B7-332L	Furnished by test lab.
C	USB K/B	DELL	KB216t	CN-0W33XP-L0300-797-05TY-A03	Furnished by test lab.
D	USB Mouse	DELL	MOCZUL	CN-049TWY-PRC00-79E-01HA	Furnished by test lab.
E	EarPods	Apple	A1472	N/A	Furnished by test lab.
F	USB 3.0 HDD	WD	WDBC3C0010BSL-0B	WX81A88ALJUC	Furnished by test lab.

Item	Shielded	Ferrite Core	Length	Cable Type	Remarks
1	N/A	N/A	1m	Power Cord	Supplied by test requester.
2	N/A	N/A	1.7m	HDMI Cable	Furnished by test lab.
3	N/A	N/A	0.18m	Type C to Type C Cable	Furnished by test lab.

3 AC POWER LINE CONDUCTED EMISSIONS TEST

3.1 LIMIT

Frequency (MHz)	Limit (dB μ V)	
	Quasi-peak	Average
0.15 - 0.5	66 - 56 *	56 - 46 *
0.50 - 5.0	56	46
5.0 - 30.0	60	50

NOTE:

- (1) The tighter limit applies at the band edges.
- (2) The limit of " * " marked band means the limitation decreases linearly with the logarithm of the frequency in the range.
- (3) The test result calculated as following:
 Measurement Value = Reading Level + Correct Factor
 Correct Factor = Insertion Loss + Cable Loss + Attenuator Factor (if use)
 Margin Level = Measurement Value – Limit Value
 Calculation example:

Reading Level		Correct Factor		Measurement Value
38.22	+	3.45	=	41.67

Measurement Value		Limit Value		Margin Level
41.67	-	60	=	-18.33

The following table is the setting of the receiver.

Receiver Parameter	Setting
Attenuation	10 dB
Start Frequency	0.15 MHz
Stop Frequency	30 MHz
IF Bandwidth	9 KHz

3.2 TEST PROCEDURE

- a. The EUT was placed 0.8 m above the horizontal ground plane with the EUT being connected to the power mains through a line impedance stabilization network (LISN).
 All other support equipment were powered from an additional LISN(s).
 The LISN provides 50 Ohm/50uH of impedance for the measuring instrument.
- b. Interconnecting cables that hang closer than 40 cm to the ground plane shall be folded back and forth in the center forming a bundle to keep the cable above 40 cm.
- c. Excess I/O cables that are not connected to a peripheral shall be bundled in the center.
 The end of the cable will be terminated, using the correct terminating impedance.
 The overall length shall not exceed 1 m.
- d. The LISN is spaced at least 80 cm from the nearest part of the EUT chassis.
- e. For the actual test configuration, please refer to the related Item - EUT TEST PHOTO.

NOTE:

- (1) In the results, each reading is marked as Peak, QP or AVG per the detector used.
 BW=9 kHz (6 dB Bandwidth)
- (2) All readings are Peak unless otherwise stated QP or AVG in column of Note. Both the QP and the AVG readings must be less than the limit for compliance.

3.3 DEVIATION FROM TEST STANDARD

No deviation.

3.4 TEST SETUP

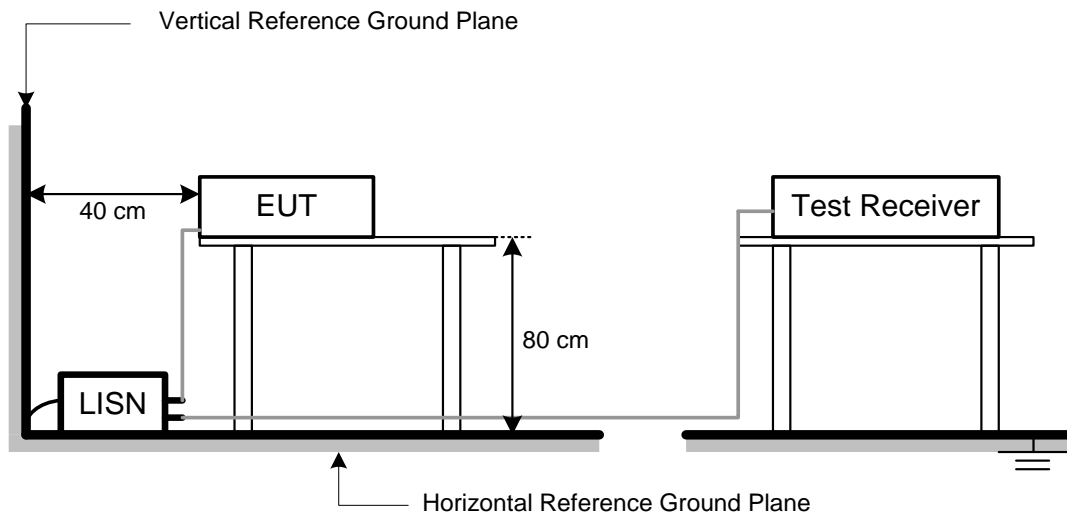

3.5 TEST RESULT

Please refer to the APPENDIX A.

4 RADIATED EMISSIONS TEST

4.1 LIMIT

In case the emission fall within the restricted band specified on 15.205, then the 15.209 limit in the table below has to be followed.

LIMITS OF RADIATED EMISSIONS MEASUREMENT (9 kHz to 1000 MHz)

Frequency (MHz)	Field Strength (microvolts/meter)	Measurement Distance (meters)
0.009~0.490	2400/F(KHz)	300
0.490~1.705	24000/F(KHz)	30
1.705~30.0	30	30
30~88	100	3
88~216	150	3
216~960	200	3
960~1000	500	3

LIMITS OF RADIATED EMISSIONS MEASUREMENT (Above 1000 MHz)

Frequency (MHz)	Radiated Emissions (dBuV/m)		Measurement Distance (meters)
	Peak	Average	
Above 1000	74	54	3

NOTE:

- (1) The limit for radiated test was performed according to FCC CFR Title 47, Part 15, Subpart C.
- (2) The tighter limit applies at the band edges.
- (3) Emission level (dBuV/m)=20log Emission level (uV/m).
- (4) The test result calculated as following:

Measurement Value = Reading Level + Correct Factor

Correct Factor = Antenna Factor + Cable Loss - Amplifier Gain(if use)

Margin Level = Measurement Value - Limit Value

Calculation example:

Reading Level		Correct Factor		Measurement Value
35.45	+	-11.37	=	24.08

Measurement Value		Limit Value		Margin Level
24.08	-	40	=	-15.92

Spectrum Parameter	Setting
Attenuation	Auto
Start Frequency	1000 MHz
Stop Frequency	10th carrier harmonic
RBW / VBW (Emission in restricted band)	1MHz / 3MHz for Peak, 1MHz / 1/T for Average

Spectrum Parameter	Setting
Attenuation	Auto
Start ~ Stop Frequency	9KHz~90KHz for PK/AVG detector
Start ~ Stop Frequency	90KHz~110KHz for QP detector
Start ~ Stop Frequency	110KHz~490KHz for PK/AVG detector
Start ~ Stop Frequency	490KHz~30MHz for QP detector
Start ~ Stop Frequency	30MHz~1000MHz for QP detector

4.2 TEST PROCEDURE

- a. The measuring distance of 3 m shall be used for measurements. The EUT was placed on the top of a rotating table 0.8 meter above the ground at a 3 meter semi-anechoic chamber. The table was rotated 360 degrees to determine the position of the highest radiation.(below 1GHz)
- b. The measuring distance of 3 m shall be used for measurements. The EUT was placed on the top of a rotating table 1.5 meter above the ground at a 3 meter semi-anechoic chamber. The table was rotated 360 degrees to determine the position of the highest radiation.(above 1GHz)
- c. The height of the equipment or of the substitution antenna shall be 0.8 m or 1.5 m, the height of the test antenna shall vary between 1 m to 4 m. Both horizontal and vertical polarizations of the antenna are set to make the measurement.
- d. For each suspected emission, the EUT was arranged to its worst case and then the antenna was tuned to heights find the maximum reading (used Bore sight function).
- e. The receiver system was set to peak and average detect function and specified bandwidth with maximum hold mode when the test frequency is above 1GHz.
- f. The initial step in collecting radiated emission data is a receiver peak detector mode pre-scanning the measurement frequency range. Significant peaks are then marked and then Quasi Peak detector mode re-measured.
- g. All readings are Peak unless otherwise stated QP in column of Note. Peak denotes that the Peak reading complies with the QP Limits and then QP Mode measurement didn't perform. (below 1GHz)
- h. All readings are Peak Mode value unless otherwise stated AVG in column of Note. If the Peak Mode Measured value complies with the Peak Limits and lower than AVG Limits, the EUT shall be deemed to meet both Peak & AVG Limits and then only Peak Mode was measured, but AVG Mode didn't perform. (above 1GHz)
- i. For the actual test configuration, please refer to the related Item – EUT TEST PHOTO.

4.3 DEVIATION FROM TEST STANDARD

No deviation.

4.4 TEST SETUP

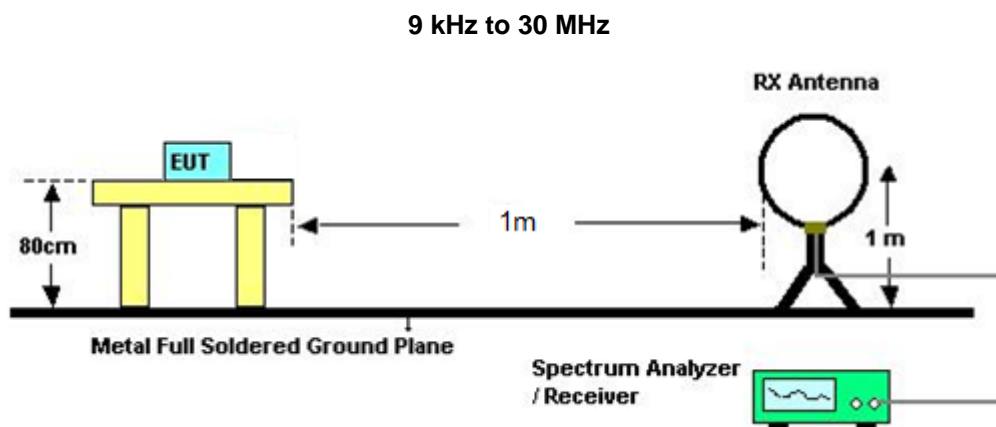

30 MHz to 1 GHz

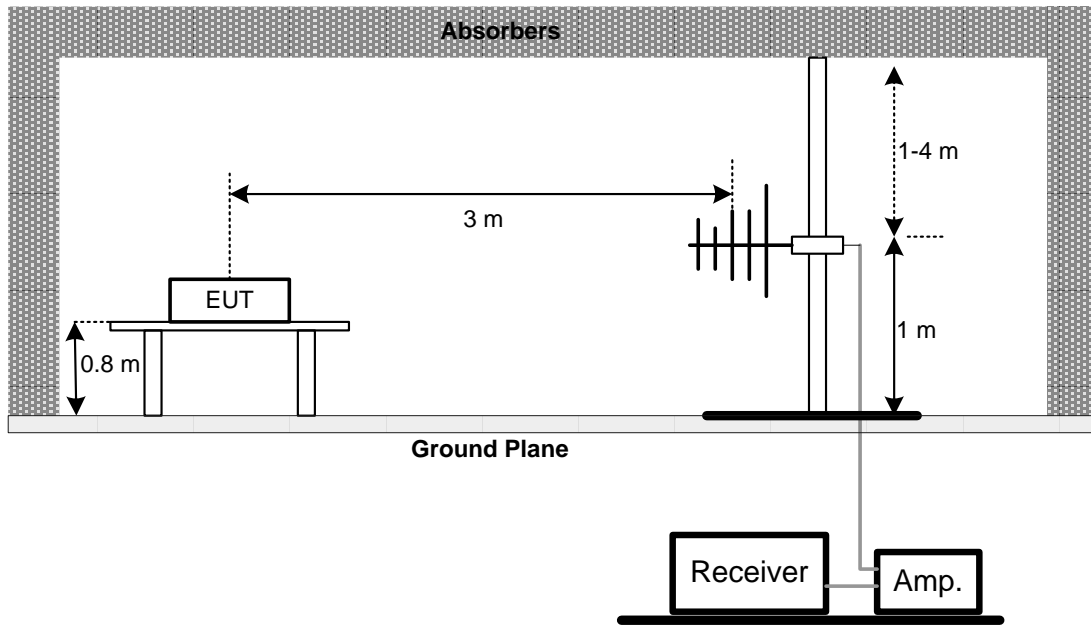

Above 1 GHz

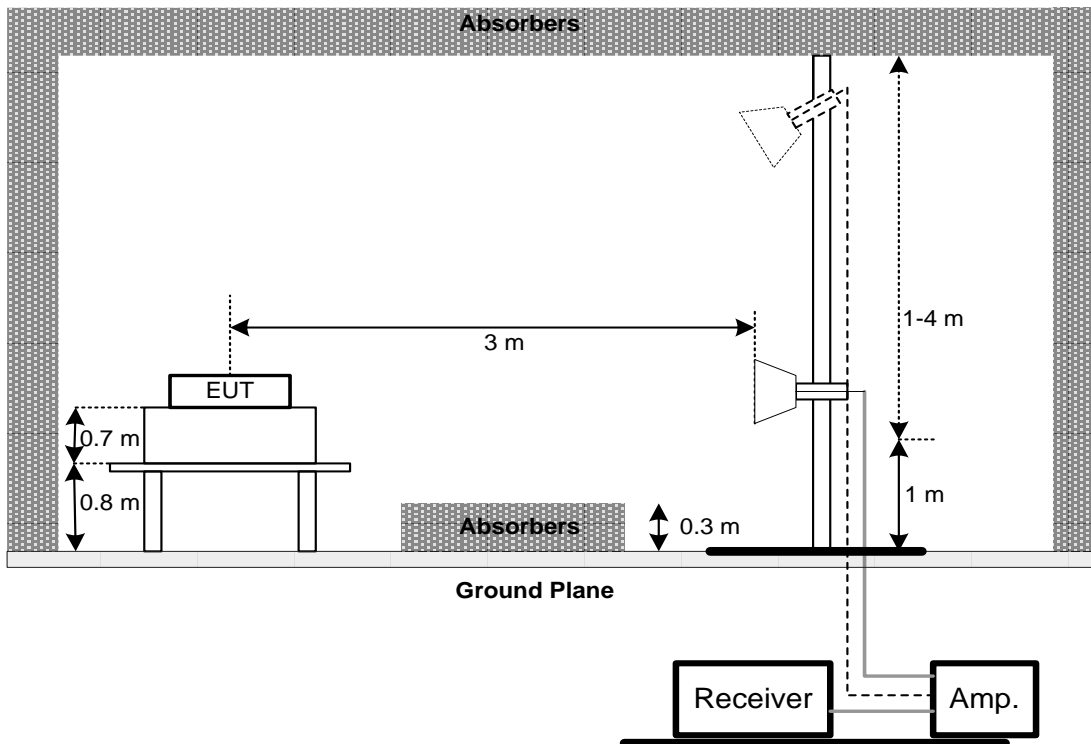

4.5 EUT OPERATING CONDITIONS

The EUT was programmed to be in continuously transmitting mode.

4.6 TEST RESULT – BELOW 30 MHZ

There were no emissions found below 30 MHz within 20 dB of the limit.

4.7 TEST RESULT – 30 MHZ TO 1 GHZ

Please refer to the APPENDIX B.

4.8 TEST RESULT – ABOVE 1 GHZ

Please refer to the APPENDIX C.

NOTE:

- (1) No limit: This is fundamental signal, the judgment is not applicable.
For fundamental signal judgment was referred to Peak output test.

5 OUTPUT POWER TEST

5.1 LIMIT

Section	Test Item	Limit	Frequency Range (MHz)	Result
15.247(b)(1)	Output Power	0.125Watt or 21dBm	2400-2483.5	PASS

5.2 TEST PROCEDURE

- a. The EUT was directly connected to the power meter and antenna output port as show in the block diagram below,
- b. Spectrum Setting: RBW= 3MHz, VBW= 3MHz, Sweep time = Auto.

5.3 DEVIATION FROM STANDARD

No deviation.

5.4 TEST SETUP

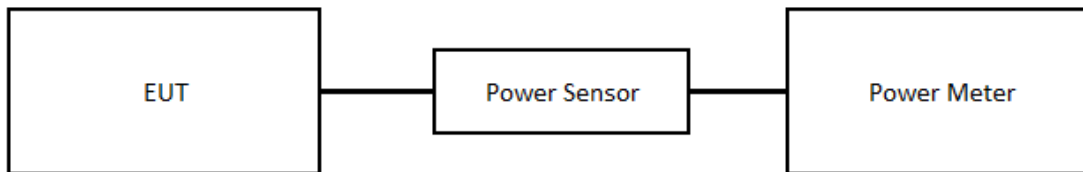

5.5 EUT OPERATION CONDITIONS

The EUT was programmed to be in continuously transmitting mode.

5.6 TEST RESULTS

Please refer to the APPENDIX D.

6 LIST OF MEASURING EQUIPMENTS

AC Power Line Conducted Emissions						
Item	Kind of Equipment	Manufacturer	Type No.	Serial No.	Calibrated Date	Calibrated Until
1	TWO-LINE V-NETWORK	R&S	ENV216	101521	2022/9/28	2023/9/27
2	Test Cable	EMCI	EMCCFD300-BM-BMR-5000	220331	2022/3/31	2023/3/30
3	EMI Test Receiver	R&S	ESR 7	101433	2022/11/16	2023/11/15
4	Measurement Software	EZ	EZ EMC (Version NB-03A1-01)	N/A	N/A	N/A

Radiated Emissions						
Item	Kind of Equipment	Manufacturer	Type No.	Serial No.	Calibrated Date	Calibrated Until
1	Preamplifier	EMCI	EMC330N	980850	2022/9/19	2023/9/18
2	Preamplifier	EMCI	EMC118A45SE	980819	2022/3/8	2023/3/7
3	Preamplifier	EMCI	EMC184045SE	980882	2022/2/9	2023/2/8
4	Preamplifier	EMCI	EMC001340	980579	2022/9/30	2023/9/29
5	Test Cable	EMCI	EMC104-SM-SM-1000	220319	2022/3/15	2023/3/14
6	Test Cable	EMCI	EMC104-SM-SM-3000	220322	2022/3/15	2023/3/14
7	Test Cable	EMCI	EMC104-SM-SM-7000	220324	2022/3/15	2023/3/14
8	EXA Signal Analyzer	keysight	N9020B	MY57120120	2022/3/7	2023/3/6
9	Loop Ant	Electro-Metrics	EMCI-LPA600	291	2022/9/19	2023/9/18
10	Horn Antenna	RFSPIN	DRH18-E	211202A18EN	2022/5/18	2023/5/17
11	Horn Ant	Schwarzbeck	BBHA 9170D	1136	2022/5/18	2023/5/17
12	Log-bicon Antenna	Schwarzbeck	VULB9168	1369	2022/5/20	2023/5/19
13	6dB Attenuator	EMCI	EMCI-N-6-06	AT-N0625	2022/5/20	2023/5/19
14	Measurement Software	EZ	EZ EMC (Version NB-03A1-01)	N/A	N/A	N/A

Output Power						
Item	Kind of Equipment	Manufacturer	Type No.	Serial No.	Calibrated Date	Calibrated Until
1	Power Meter	Anritsu	ML2495A	1128008	2022/6/1	2023/5/31
2	Power Sensor	Anritsu	MA2411B	1126001	2022/6/1	2023/5/31

Remark: "N/A" denotes no model name, no serial no. or no calibration specified.
All calibration period of equipment list is one year.

7 EUT TEST PHOTO

Please refer to document Appendix No.: TP-2212C001-1 (APPENDIX-TEST PHOTOS).

8 EUT PHOTOS

Please refer to document Appendix No.: EP-2212C001-1 (APPENDIX-EUT PHOTOS).

APPENDIX A AC POWER LINE CONDUCTED EMISSIONS

Test Mode	Normal	Tested Date	2023/1/6
Test Frequency	-	Phase	Line

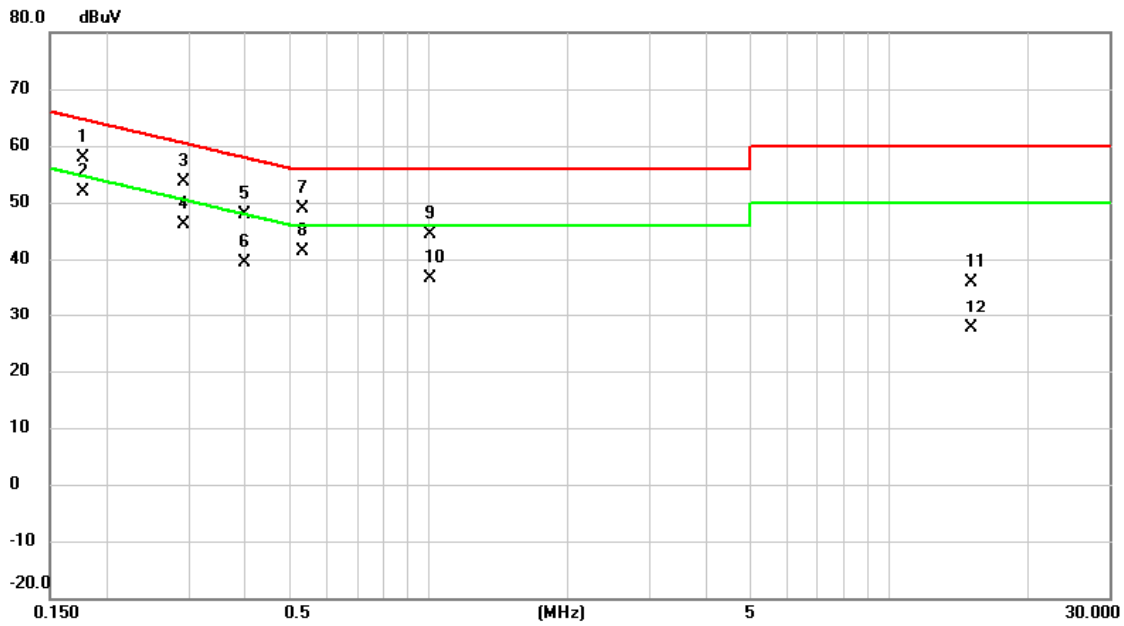

No.	Mk.	Freq. MHz	Reading Level dBuV	Correct Factor dB	Measure- ment dBuV	Limit dBuV	Margin dB	Detector	Comment
1		0.1770	48.22	9.63	57.85	64.63	-6.78	QP	
2	*	0.1770	42.19	9.63	51.82	54.63	-2.81	AVG	
3		0.2917	43.98	9.63	53.61	60.48	-6.87	QP	
4		0.2917	36.42	9.63	46.05	50.48	-4.43	AVG	
5		0.3997	38.17	9.63	47.80	57.86	-10.06	QP	
6		0.3997	29.72	9.63	39.35	47.86	-8.51	AVG	
7		0.5347	39.32	9.63	48.95	56.00	-7.05	QP	
8		0.5347	31.83	9.63	41.46	46.00	-4.54	AVG	
9		1.0072	34.80	9.67	44.47	56.00	-11.53	QP	
10		1.0072	26.85	9.67	36.52	46.00	-9.48	AVG	
11		15.0878	26.03	9.90	35.93	60.00	-24.07	QP	
12		15.0878	17.70	9.90	27.60	50.00	-22.40	AVG	

REMARKS:

(1) Measurement Value = Reading Level + Correct Factor.

(2) Margin Level = Measurement Value - Limit Value.

Test Mode	Normal	Tested Date	2023/1/6
Test Frequency	-	Phase	Neutral

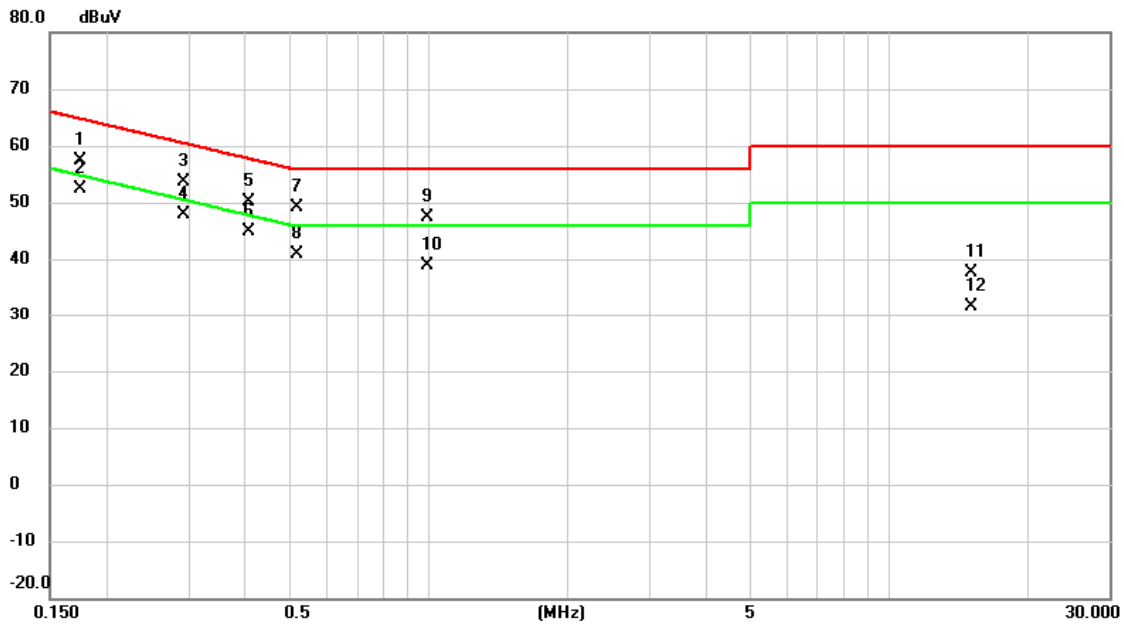

No.	Mk.	Freq. MHz	Reading Level dBuV	Correct Factor dB	Measure- ment dBuV	Limit dBuV	Margin dB	Detector	Comment
1		0.1748	47.63	9.65	57.28	64.73	-7.45	QP	
2	*	0.1748	42.73	9.65	52.38	54.73	-2.35	AVG	
3		0.2917	43.88	9.64	53.52	60.48	-6.96	QP	
4		0.2917	38.26	9.64	47.90	50.48	-2.58	AVG	
5		0.4087	40.53	9.64	50.17	57.67	-7.50	QP	
6		0.4087	35.24	9.64	44.88	47.67	-2.79	AVG	
7		0.5167	39.52	9.64	49.16	56.00	-6.84	QP	
8		0.5167	31.14	9.64	40.78	46.00	-5.22	AVG	
9		0.9960	37.73	9.68	47.41	56.00	-8.59	QP	
10		0.9960	29.25	9.68	38.93	46.00	-7.07	AVG	
11		15.0855	27.63	9.98	37.61	60.00	-22.39	QP	
12		15.0855	21.74	9.98	31.72	50.00	-18.28	AVG	

REMARKS:

- (1) Measurement Value = Reading Level + Correct Factor.
- (2) Margin Level = Measurement Value - Limit Value.

Test Mode	Idle	Tested Date	2023/1/6
Test Frequency	-	Phase	Line

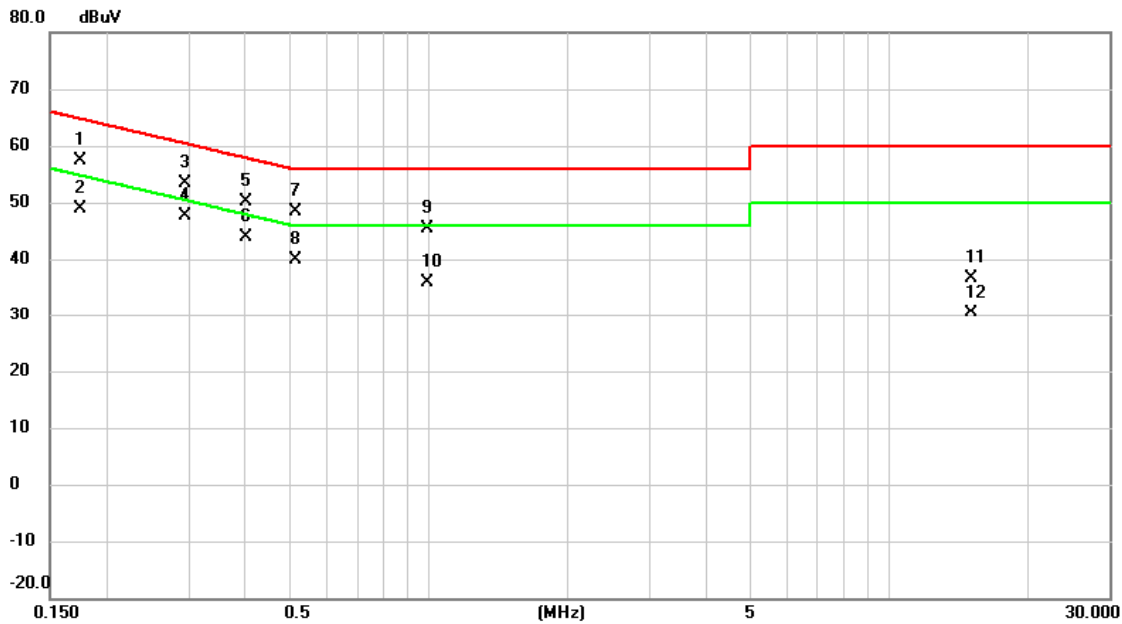

No.	Mk.	Freq. MHz	Reading Level dBuV	Correct Factor dB	Measure- ment dBuV	Limit dBuV	Margin dB	Detector	Comment
1		0.1748	47.63	9.64	57.27	64.73	-7.46	QP	
2		0.1748	39.22	9.64	48.86	54.73	-5.87	AVG	
3		0.2940	43.63	9.63	53.26	60.41	-7.15	QP	
4	*	0.2940	38.11	9.63	47.74	50.41	-2.67	AVG	
5		0.4020	40.44	9.63	50.07	57.81	-7.74	QP	
6		0.4020	34.22	9.63	43.85	47.81	-3.96	AVG	
7		0.5144	38.80	9.63	48.43	56.00	-7.57	QP	
8		0.5144	30.24	9.63	39.87	46.00	-6.13	AVG	
9		0.9960	35.62	9.67	45.29	56.00	-10.71	QP	
10		0.9960	26.09	9.67	35.76	46.00	-10.24	AVG	
11		15.0855	26.81	9.90	36.71	60.00	-23.29	QP	
12		15.0855	20.43	9.90	30.33	50.00	-19.67	AVG	

REMARKS:

(1) Measurement Value = Reading Level + Correct Factor.

(2) Margin Level = Measurement Value - Limit Value.

Test Mode	Idle	Tested Date	2023/1/6
Test Frequency	-	Phase	Neutral

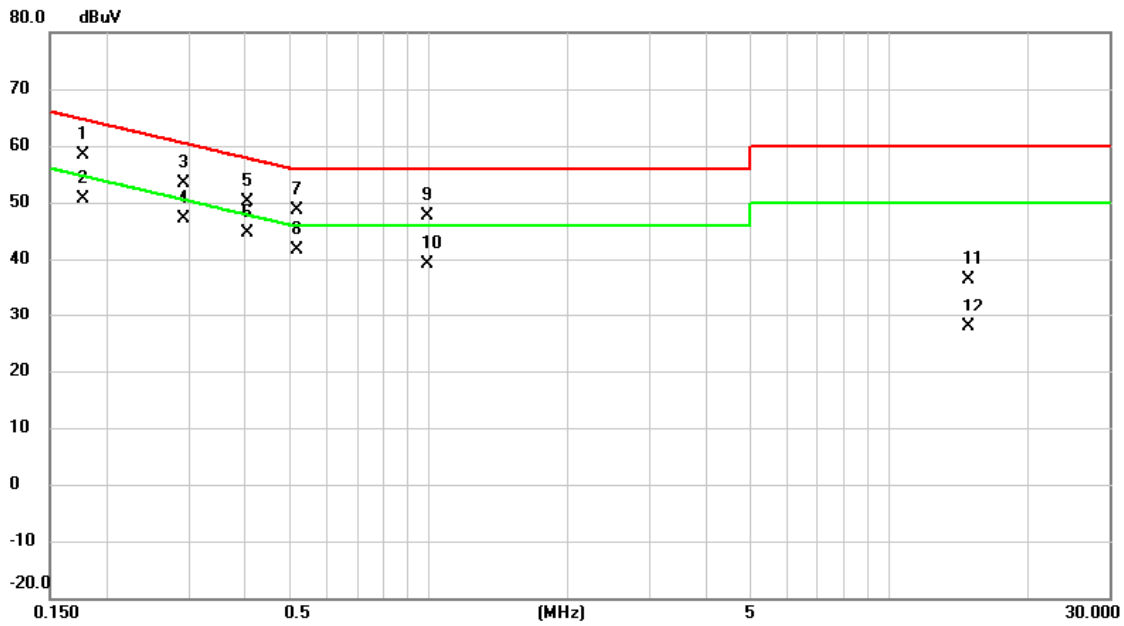

No.	Mk.	Freq. MHz	Reading Level dBuV	Correct Factor dB	Measure- ment dBuV	Limit dBuV	Margin dB	Detector	Comment
1		0.1770	48.63	9.64	58.27	64.63	-6.36	QP	
2		0.1770	41.07	9.64	50.71	54.63	-3.92	AVG	
3		0.2917	43.86	9.64	53.50	60.48	-6.98	QP	
4		0.2917	37.46	9.64	47.10	50.48	-3.38	AVG	
5		0.4042	40.60	9.64	50.24	57.77	-7.53	QP	
6	*	0.4042	34.89	9.64	44.53	47.77	-3.24	AVG	
7		0.5190	38.97	9.64	48.61	56.00	-7.39	QP	
8		0.5190	32.07	9.64	41.71	46.00	-4.29	AVG	
9		0.9892	37.89	9.68	47.57	56.00	-8.43	QP	
10		0.9892	29.53	9.68	39.21	46.00	-6.79	AVG	
11		14.8380	26.41	9.97	36.38	60.00	-23.62	QP	
12		14.8380	17.83	9.97	27.80	50.00	-22.20	AVG	

REMARKS:

(1) Measurement Value = Reading Level + Correct Factor.

(2) Margin Level = Measurement Value - Limit Value.

APPENDIX B RADIATED EMISSIONS - 30 MHZ TO 1 GHZ

Test Mode	BT(1Mbps)	Test Date	2023/1/5
Test Frequency	2402MHz	Polarization	Vertical
Temp	23°C	Hum.	59%

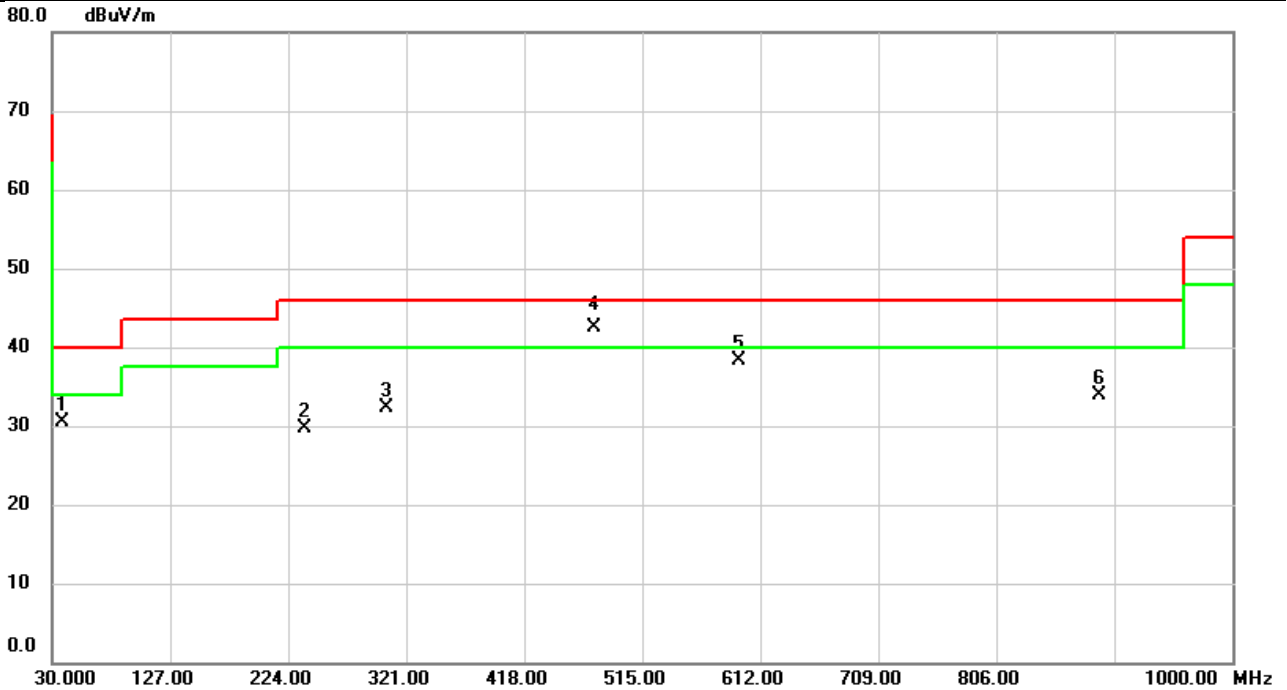

No.	Mk.	Freq.	Reading Level	Correct Factor	Measurement	Limit	Over	Detector	Comment
		MHz	dBuV	dB	dBuV/m	dBuV/m	dB		
1		38.2127	42.60	-12.10	30.50	40.00	-9.50	peak	
2		237.3537	43.45	-13.71	29.74	46.00	-16.26	peak	
3		305.3507	43.59	-11.35	32.24	46.00	-13.76	peak	
4	*	475.9737	49.53	-6.94	42.59	46.00	-3.41	QP	
5		594.2167	42.69	-4.33	38.36	46.00	-7.64	peak	
6		891.0043	33.97	-0.04	33.93	46.00	-12.07	peak	

REMARKS:

- (1) Measurement Value = Reading Level + Correct Factor.
- (2) Margin Level = Measurement Value - Limit Value.

Test Mode	BT(1Mbps)	Test Date	2023/1/5
Test Frequency	2402MHz	Polarization	Horizontal
Temp	23°C	Hum.	59%

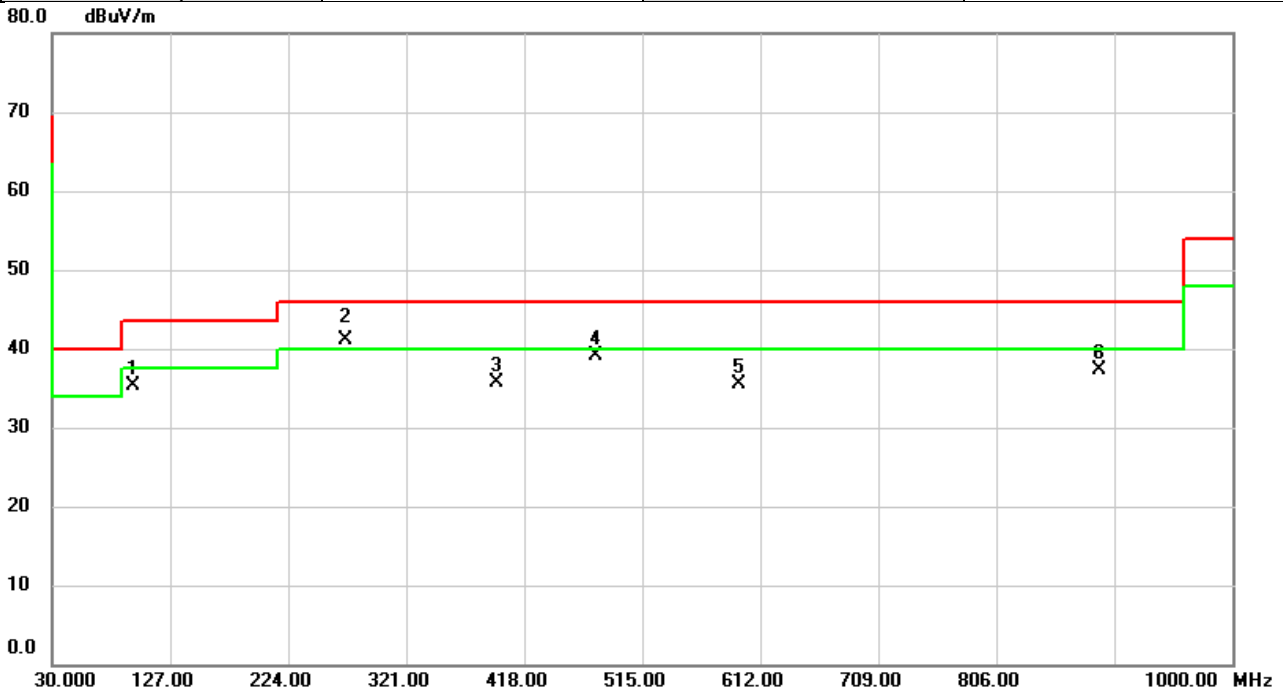

No.	Mk.	Freq. MHz	Reading Level dBuV	Correct Factor dB	Measure- ment dBuV/m	Limit dBuV/m	Over dB	Detector	Comment
1		96.0570	52.12	-16.81	35.31	43.50	-8.19	peak	
2	*	270.8510	53.21	-12.20	41.01	46.00	-4.99	QP	
3		395.8517	44.65	-8.91	35.74	46.00	-10.26	peak	
4		476.3293	46.06	-6.93	39.13	46.00	-6.87	peak	
5		594.0227	39.84	-4.34	35.50	46.00	-10.50	peak	
6		891.0043	37.30	-0.04	37.26	46.00	-8.74	peak	

REMARKS:

- (1) Measurement Value = Reading Level + Correct Factor.
- (2) Margin Level = Measurement Value - Limit Value.

APPENDIX C RADIATED EMISSIONS - ABOVE 1 GHZ

Test Mode	BT(1Mbps)	Test Date	2023/1/31
Test Frequency	2402MHz	Polarization	Vertical
Temp	23°C	Hum.	59%

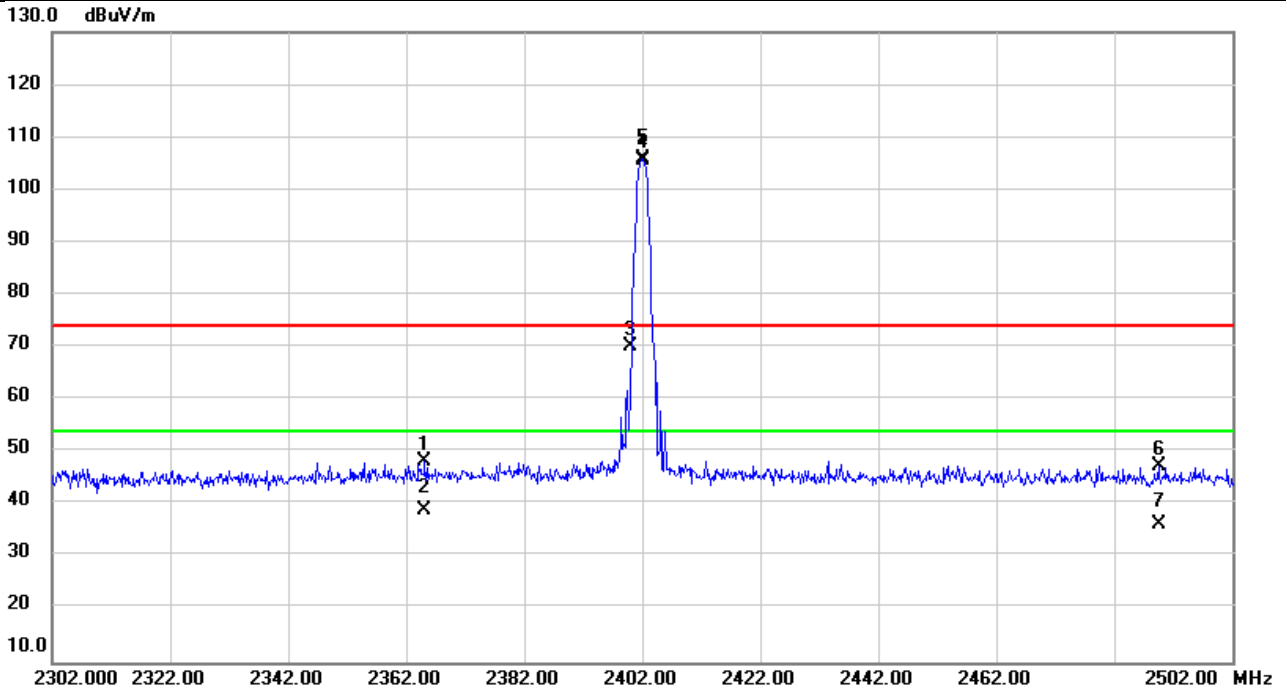

No.	Mk.	Freq.	Reading Level	Correct Factor	Measurement	Limit	Over	Detector	Comment
		MHz	dBuV	dB	dBuV/m	dBuV/m	dB		
1		2365.060	53.93	-5.80	48.13	74.00	-25.87	peak	
2		2365.060	44.65	-5.80	38.85	54.00	-15.15	AVG	
3		2400.000	76.02	-5.76	70.26	74.00	-3.74	peak	NoLimit
4	X	2402.000	111.55	-5.75	105.80	74.00	31.80	peak	NoLimit
5	*	2402.000	111.32	-5.75	105.57	54.00	51.57	AVG	NoLimit
6		2489.567	52.87	-5.63	47.24	74.00	-26.76	peak	
7		2489.567	41.78	-5.63	36.15	54.00	-17.85	AVG	

REMARKS:

- (1) Measurement Value = Reading Level + Correct Factor.
- (2) Margin Level = Measurement Value - Limit Value.

Test Mode	BT(3Mbps)	Test Date	2023/1/31
Test Frequency	2402MHz	Polarization	Vertical
Temp	23°C	Hum.	59%

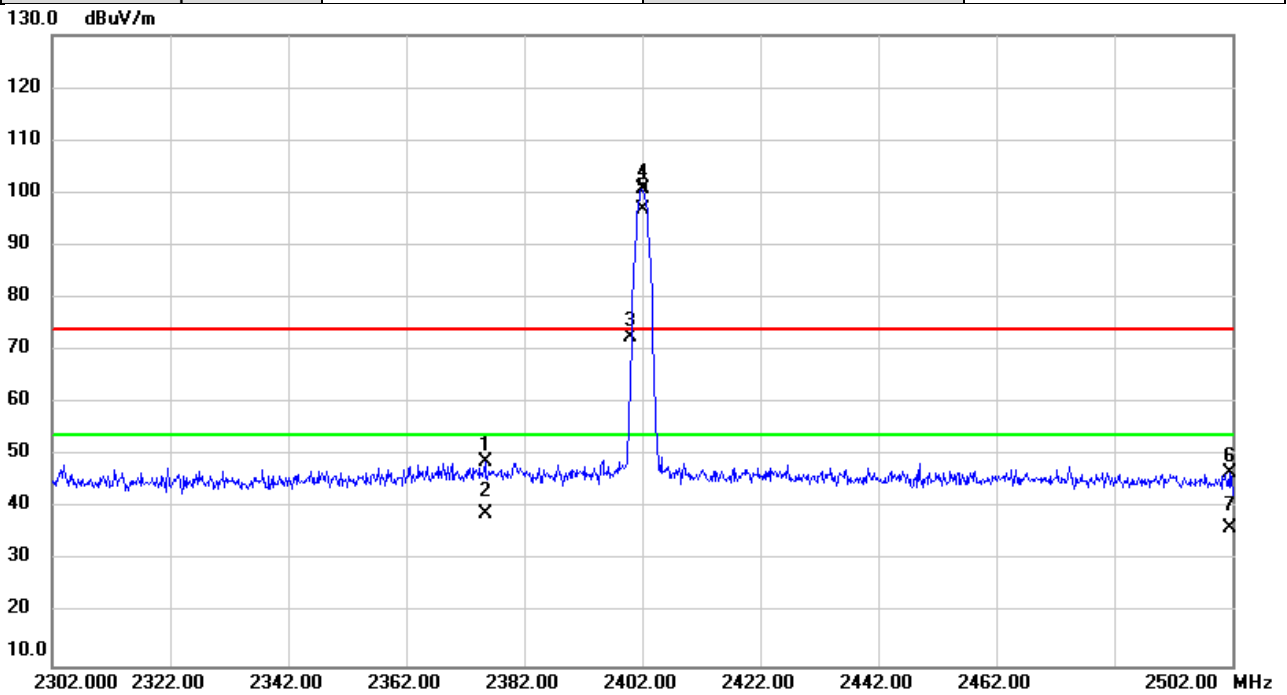

No.	Mk.	Freq.	Reading Level	Correct Factor	Measurement	Limit	Over	Detector	Comment
		MHz	dBuV	dB	dBuV/m	dBuV/m	dB		
1		2375.353	54.69	-5.78	48.91	74.00	-25.09	peak	
2		2375.353	44.64	-5.78	38.86	54.00	-15.14	AVG	
3		2400.000	78.21	-5.76	72.45	74.00	-1.55	peak	NoLimit
4	X	2402.000	106.43	-5.75	100.68	74.00	26.68	peak	NoLimit
5	*	2402.000	102.69	-5.75	96.94	54.00	42.94	AVG	NoLimit
6		2501.480	52.31	-5.61	46.70	74.00	-27.30	peak	
7		2501.480	41.85	-5.61	36.24	54.00	-17.76	AVG	

REMARKS:

- (1) Measurement Value = Reading Level + Correct Factor.
- (2) Margin Level = Measurement Value - Limit Value.

Test Mode	BT(1Mbps)	Test Date	2023/1/31
Test Frequency	2402MHz	Polarization	Vertical
Temp	23°C	Hum.	59%

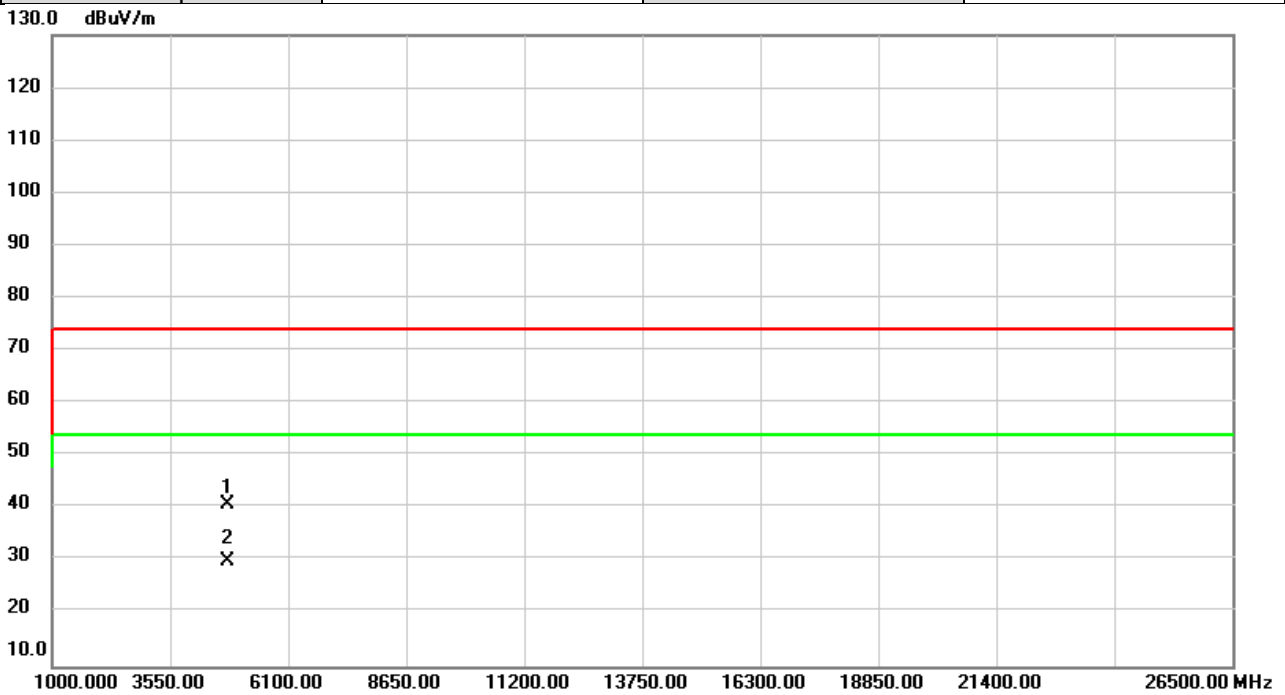

No.	Mk.	Freq. MHz	Reading Level dBuV	Correct Factor dB	Measure- ment dBuV/m	Limit dBuV/m	Over dB	Detector	Comment
1		4804.000	40.04	0.65	40.69	74.00	-33.31	peak	
2	*	4804.000	29.27	0.65	29.92	54.00	-24.08	AVG	

REMARKS:

- (1) Measurement Value = Reading Level + Correct Factor.
- (2) Margin Level = Measurement Value - Limit Value.

Test Mode	BT(1Mbps)	Test Date	2023/1/31
Test Frequency	2402MHz	Polarization	Horizontal
Temp	23°C	Hum.	59%

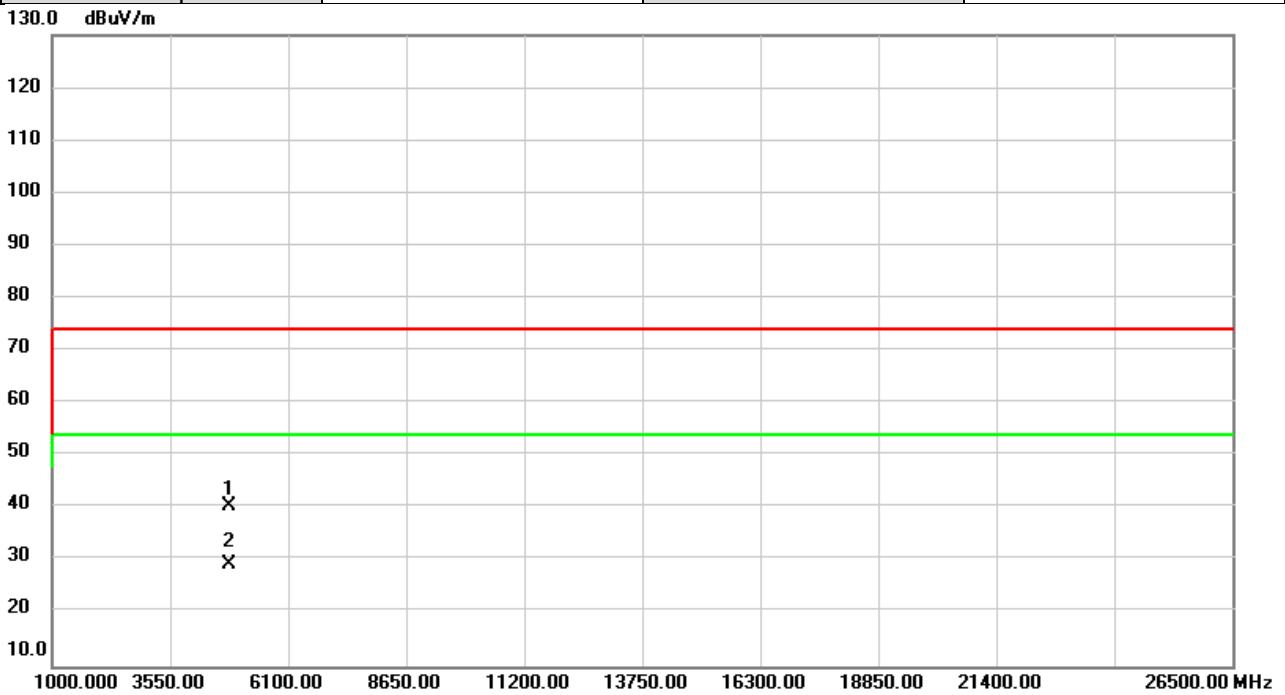

No.	Mk.	Freq. MHz	Reading Level dBuV	Correct Factor dB	Measure- ment dBuV/m	Limit dBuV/m	Over dB	Detector	Comment
1		4824.000	39.71	0.72	40.43	74.00	-33.57	peak	
2	*	4824.000	28.73	0.72	29.45	54.00	-24.55	AVG	

REMARKS:

- (1) Measurement Value = Reading Level + Correct Factor.
- (2) Margin Level = Measurement Value - Limit Value.

Test Mode	BT(3Mbps)	Test Date	2023/1/31
Test Frequency	2441MHz	Polarization	Vertical
Temp	23°C	Hum.	59%

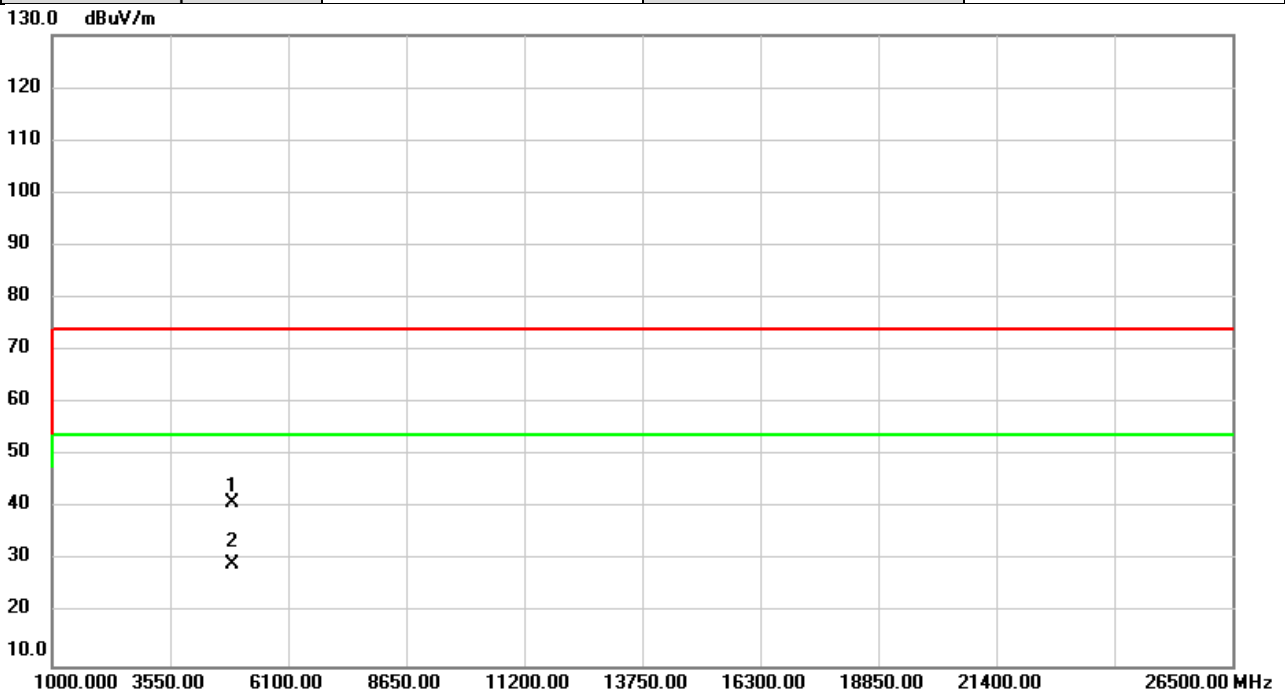

No.	Mk.	Freq. MHz	Reading Level dBuV	Correct Factor dB	Measure- ment dBuV/m	Limit dBuV/m	Over dB	Detector	Comment
1		4882.000	40.10	0.92	41.02	74.00	-32.98	peak	
2	*	4882.000	28.34	0.92	29.26	54.00	-24.74	AVG	

REMARKS:

- (1) Measurement Value = Reading Level + Correct Factor.
- (2) Margin Level = Measurement Value - Limit Value.

Test Mode	BT(3Mbps)	Test Date	2023/1/31
Test Frequency	2441MHz	Polarization	Horizontal
Temp	23°C	Hum.	59%

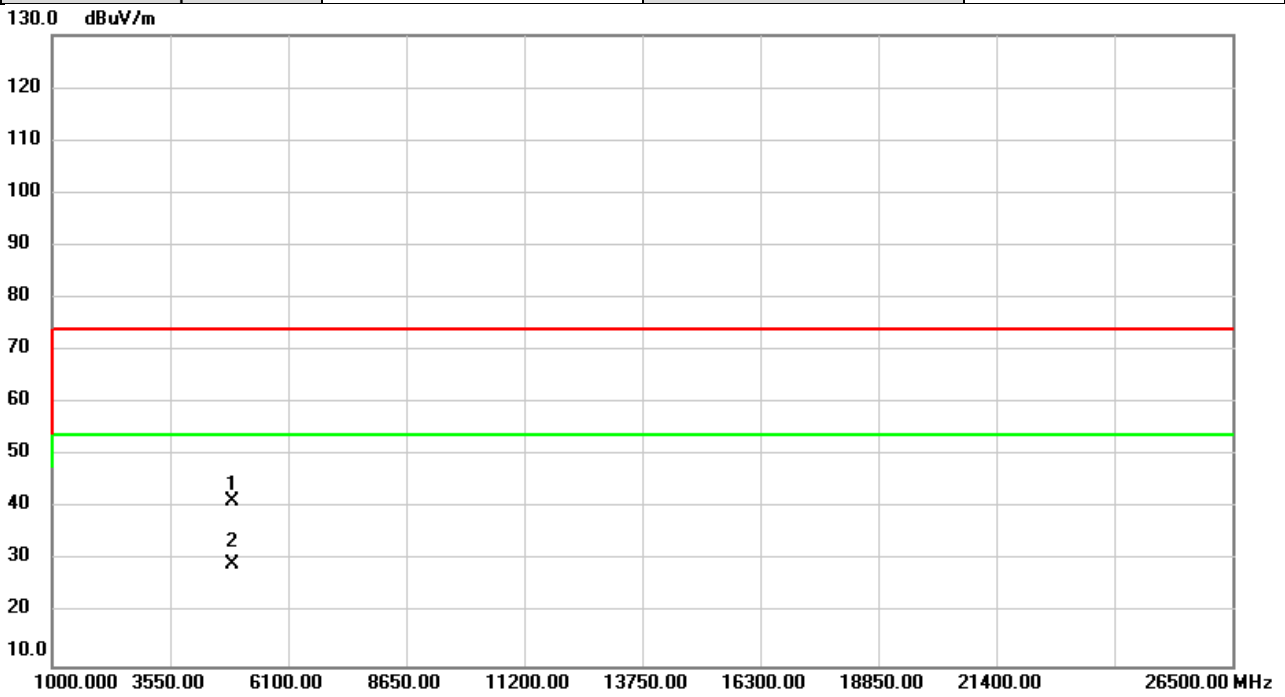

No.	Mk.	Freq. MHz	Reading Level dBuV	Correct Factor dB	Measure- ment dBuV/m	Limit dBuV/m	Over dB	Detector	Comment
1		4882.000	40.28	0.92	41.20	74.00	-32.80	peak	
2	*	4882.000	28.44	0.92	29.36	54.00	-24.64	AVG	

REMARKS:

- (1) Measurement Value = Reading Level + Correct Factor.
- (2) Margin Level = Measurement Value - Limit Value.

APPENDIX D OUTPUT POWER

Test Mode :	1Mbps	Tested Date	2023/1/13
-------------	-------	-------------	-----------

Frequency (MHz)	Output Power (dBm)	Output Power (W)	Max. Limit (dBm)	Max. Limit (W)	Test Result
2402	14.51	0.0282	21.00	0.1250	Pass
2441	14.09	0.0256	21.00	0.1250	Pass
2480	12.23	0.0167	21.00	0.1250	Pass

Test Mode :	2Mbps	Tested Date	2023/1/13
-------------	-------	-------------	-----------

Frequency (MHz)	Output Power (dBm)	Output Power (W)	Max. Limit (dBm)	Max. Limit (W)	Test Result
2402	12.80	0.0191	21.00	0.1250	Pass
2441	12.42	0.0175	21.00	0.1250	Pass
2480	10.41	0.0110	21.00	0.1250	Pass

Test Mode :	3Mbps	Tested Date	2023/1/13
-------------	-------	-------------	-----------

Frequency (MHz)	Output Power (dBm)	Output Power (W)	Max. Limit (dBm)	Max. Limit (W)	Test Result
2402	11.24	0.0133	21.00	0.1250	Pass
2441	13.01	0.0200	21.00	0.1250	Pass
2480	11.09	0.0129	21.00	0.1250	Pass

End of Test Report