

## Supplemental “Transmit Simultaneously” Test Report

**Report No.:** RF201119E01-8

**FCC ID:** J9C-QCNFA765

**Test Model:** QCNFA765

**Received Date:** Nov. 19, 2020

**Test Date:** Aug. 18 to Oct. 01, 2021

**Issued Date:** Oct. 05, 2021

**Applicant:** Qualcomm Technologies, Inc.

**Address:** 5775 Morehouse Drive, San Diego, CA 92121-1714

**Issued By:** Bureau Veritas Consumer Products Services (H.K.) Ltd., Taoyuan Branch  
Hsin Chu Laboratory

**Lab Address:** E-2, No.1, Li Hsin 1st Road, Hsinchu Science Park, Hsinchu City 300,  
Taiwa.

**Test Location:** E-2, No.1, Li Hsin 1st Road, Hsinchu Science Park, Hsinchu City 300,  
Taiwan.

**FCC Registration /  
Designation Number:** 723255 / TW2022



This report is for your exclusive use. Any copying or replication of this report to or for any other person or entity, or use of our name or trademark, is permitted only with our prior written permission. This report sets forth our findings solely with respect to the test samples identified herein. The results set forth in this report are not indicative or representative of the quality or characteristics of the lot from which a test sample was taken or any similar or identical product specifically and expressly noted. Our report includes all of the tests requested by you and the results thereof based upon the information that you provided to us. You have 60 days from date of issuance of this report to notify us of any material error or omission caused by our negligence, provided, however, that such notice shall be in writing and shall specifically address the issue you wish to raise. A failure to raise such issue within the prescribed time shall constitute your unqualified acceptance of the completeness of this report, the tests conducted and the correctness of the report contents. Unless specific mention, the uncertainty of measurement has been explicitly taken into account to declare the compliance or non-compliance to the specification. This report should not be used by the client to claim product certification, approval, or endorsement by TAF or any government agencies.

## Table of Contents

<b>Release Control Record</b> .....	<b>3</b>
<b>1 Certificate of Conformity</b> .....	<b>4</b>
<b>2 Summary of Test Results</b> .....	<b>5</b>
2.1 Measurement Uncertainty.....	5
2.2 Modification Record.....	5
<b>3 General Information</b> .....	<b>6</b>
3.1 General Description of EUT.....	6
3.2 Description of Antenna.....	8
3.2.1 Test Mode Applicability and Tested Channel Detail.....	9
3.3 Description of Support Units.....	11
3.3.1 Configuration of System under Test.....	12
<b>4 Test Types and Results</b> .....	<b>13</b>
4.1 Radiated Emission and Bandedge Measurement.....	13
4.1.1 Limits of Radiated Emission and Bandedge Measurement.....	13
4.1.2 Test Instruments.....	14
4.1.3 Test Procedures.....	16
4.1.4 Deviation from Test Standard.....	16
4.1.5 Test Setup.....	17
4.1.6 EUT Operating Conditions.....	18
4.1.7 Test Results (Mode 1).....	19
4.1.8 Test Results (Mode 2).....	22
4.2 Conducted Emission Measurement.....	25
4.2.1 Limits of Conducted Emission Measurement.....	25
4.2.2 Test Instruments.....	25
4.2.3 Test Procedures.....	26
4.2.4 Deviation from Test Standard.....	26
4.2.5 Test Setup.....	26
4.2.6 EUT Operating Conditions.....	26
4.2.7 Test Results (Mode 1).....	27
4.2.8 Test Results (Mode 2).....	29
4.3 Conducted Out of Band Emission Measurement.....	31
4.3.1 Limits of Conducted Out of Band Emission Measurement.....	31
4.3.2 Test Setup.....	31
4.3.3 Test Instruments.....	31
4.3.4 Test Procedures.....	31
4.3.5 Deviation from Test Standard.....	31
4.3.6 EUT Operating Conditions.....	31
4.3.7 Test Results (Mode 1).....	32
4.3.8 Test Results (Mode 2).....	32
<b>5 Pictures of Test Arrangements</b> .....	<b>33</b>
<b>Appendix – Information of the Testing Laboratories</b> .....	<b>34</b>

### Release Control Record

Issue No.	Description	Date Issued
RF201119E01-8	Original release.	Oct. 05, 2021

## 1 Certificate of Conformity

**Product:** Wi-Fi 6E BT 5.2 M.2 2230 Module

**Brand:** Qualcomm

**Test Model:** QCNFA765

**Sample Status:** Engineering sample

**Applicant:** Qualcomm Technologies, Inc.

**Test Date:** Aug. 18 to Oct. 01, 2021

**Standards:** 47 CFR FCC Part 15, Subpart C (Section 15.247)  
47 CFR FCC Part 15, Subpart E (Section 15.407)  
ANSI C63.10: 2013

The above equipment has been tested by **Bureau Veritas Consumer Products Services (H.K.) Ltd., Taoyuan Branch**, and found compliance with the requirement of the above standards. The test record, data evaluation & Equipment Under Test (EUT) configurations represented herein are true and accurate accounts of the measurements of the sample's EMC characteristics under the conditions specified in this report.

**Prepared by :** Phoenix Huang , **Date:** Oct. 05, 2021  
Phoenix Huang / Specialist

**Approved by :** Clark Lin , **Date:** Oct. 05, 2021  
Clark Lin / Technical Manager

## 2 Summary of Test Results

FCC Part 15, Subpart C, E (SECTION 15.247, 15.407)			
FCC Clause	Test Item	Result	Remarks
15.207 15.407(b)(6)	AC Power Conducted Emission	Pass	Meet the requirement of limit. Minimum passing margin is -11.60 dB at 0.58595 MHz.
15.205 / 15.209 / 15.247(d) 15.407(b) (1/2/3/4(i/ii)/6)	Radiated Emissions and Band Edge Measurement	Pass	Meet the requirement of limit. Minimum passing margin is -5.6 dB at 37.67 MHz.

**Note:**

Determining compliance based on the results of the compliance measurement, not taking into account measurement instrumentation uncertainty.

### 2.1 Measurement Uncertainty

Where relevant, the following measurement uncertainty levels have been estimated for tests performed on the EUT as specified in CISPR 16-4-2:

Measurement	Frequency	Expanded Uncertainty (k=2) ( $\pm$ )
Conducted Emissions at mains ports	150kHz ~ 30MHz	1.9 dB
Conducted Emissions	-	2.5 dB
Radiated Emissions up to 1 GHz	9kHz ~ 30MHz	3.1 dB
	30MHz ~ 1GHz	5.5 dB
Radiated Emissions above 1 GHz	1GHz ~ 18GHz	5.1 dB
	18GHz ~ 40GHz	5.3 dB

### 2.2 Modification Record

There were no modifications required for compliance.

### 3 General Information

#### 3.1 General Description of EUT

Product	Wi-Fi 6E BT 5.2 M.2 2230 Module
Brand	Qualcomm
Test Model	QCNFA765
Status of EUT	Engineering sample
Power Supply Rating	3.3Vdc from host equipment
Modulation Type	<b>WLAN:</b> CCK, DQPSK, DBPSK for DSSS 64QAM, 16QAM, QPSK, BPSK for OFDM 1024QAM for OFDM in 11ac mode and VHT20/40 in 2.4GHz mode 4096QAM for OFDMA in 11ax HE mode <b>BT-EDR:</b> GFSK, $\pi/4$ -DQPSK, 8DPSK <b>BT-LE:</b> GFSK
Modulation Technology	<b>WLAN:</b> DSSS, OFDM, OFDMA <b>BT-EDR:</b> FHSS <b>BT-LE:</b> DTS
Operating Frequency	<b>WLAN:</b> <b>2.4GHz:</b> 2.412 ~ 2.472GHz <b>5GHz:</b> 5.18~ 5.24GHz, 5.26 ~ 5.32GHz, 5.5 ~ 5.72GHz, 5.745 ~ 5.825GHz, 5.845 ~ 5.885 GHz <b>6GHz:</b> Under control by Standard Power AP: 5.935 ~ 6.415GHz, 6.535 ~ 6.855GHz Under control by Low-powerIndoor AP: 5.935 ~ 6.415GHz, 6.435 ~ 6.525GHz, 6.535 ~ 6.855GHz, 6.865 ~ 7.115GHz <b>BT-EDR:</b> 2.402 ~ 2.480 GHz <b>BT-LE:</b> 2.402 ~ 2.480 GHz
Antenna Type	Refer to section 3.2
Antenna Connector	Refer to section 3.2
Accessory Device	NA
Data Cable Supplied	NA

#### Note:

- This report is prepared for FCC class II change. The difference compared with the Report No.: RF201119E01-5 as the following:
  - ◆ Enable U-NII-4 and U-NII-3 & -4 span channels through software change.
- According to above conditions, for Radiated Emissions and Band Edge test item need to be performed and all data was tested to meet the requirements.
- This device of WLAN (2.4GHz & 5GHz U-NII-1 Band) can support hotspot mode.
- The module has two variant designs as following table:

SKU No.	Description
SKU #1	M.2 2230 E-key
SKU #2	M.2 2230 AE-key

From the above variants designs, the worst case was found in **SKU #1**. Therefore only the test data of the mode was recorded in this report.

- The product provides option to depopulate external LNA (Low-Noise amplifier) from 5GHz/6GHz receive path. This test report covers variation of with/without external LNA and test was conducted to confirm not change in RF compliance and EMC. And worst case was found in without external LNA.

6. Simultaneously transmission condition.

<b>Original</b>		
Condition	Technology	
1	WLAN(2.4GHz)	WLAN(6GHz)
2	WLAN(2.4GHz)	WLAN(5GHz)
3	WLAN(6GHz)	Bluetooth
4	WLAN(5GHz)	Bluetooth
<b>Newly</b>		
5	WLAN(2.4GHz)	WLAN(5.9GHz)
6	WLAN(5.9GHz)	Bluetooth

Note: The emission of the simultaneous operation has been evaluated and no non-compliance was found.

7. The device of WLAN (2.4GHz) and Bluetooth technology can't transmit simultaneously, it was used timely shared coexistence technology.

8. The EUT incorporates a MIMO function:

MODULATION MODE	<b>2.4GHz Band</b>			
	TX & RX CONFIGURATION			
802.11b	2TX		2RX	
802.11g	2TX		2RX	
802.11n (HT20)	2TX		2RX	
802.11n (HT40)	2TX		2RX	
VHT20	2TX		2RX	
VHT40	2TX		2RX	
802.11ax (HE20)	2TX		2RX	
802.11ax (HE40)	2TX		2RX	
802.11ax (RU26/52/106/242/484)	2TX		2RX	
MODULATION MODE	<b>5GHz Band</b>		<b>6GHz Band</b>	
	TX & RX CONFIGURATION		TX & RX CONFIGURATION	
802.11a	2TX	2RX	2TX	2RX
802.11n (HT20)	2TX	2RX	-	-
802.11n (HT40)	2TX	2RX	-	-
802.11ac (VHT20)	2TX	2RX	-	-
802.11ac (VHT40)	2TX	2RX	-	-
802.11ac (VHT80)	2TX	2RX	-	-
802.11ac (VHT160)	2TX	2RX	2TX	2RX
802.11ax (HE20)	2TX	2RX	2TX	2RX
802.11ax (HE40)	2TX	2RX	2TX	2RX
802.11ax (HE80)	2TX	2RX	2TX	2RX
802.11ax (HE160)	2TX	2RX	2TX	2RX
802.11ax (RU26/52/106/242/484/996/1992)	2TX	2RX	2TX	2RX

9. The above EUT information is declared by manufacturer and for more detailed features description, please refers to the manufacturer's specifications or user's manual.

### 3.2 Description of Antenna

The antenna gain was declared by client; please refer to the following table:

Antenna Set	RF Chain No.	Brand	Model	Antenna Net Gain (dBi)	Frequency Range	Cable Loss (dB)	Antenna Type	Connector Type	Cable Length
1	Chain0/1	HONGBO	260-25094	3.53	2.4~2.4835 GHz	0.76	PIFA	i-pex(MHF 4L)	300mm
				3.06	5.15~5.25 GHz	1.16			
				3.07	5.25~5.35 GHz	1.18			
				4.81	5.47~5.725 GHz	1.2			
				4.2	5.725~5.850 GHz	1.27			
2	Chain0/1	HONGBO	260-25083	5.09	5.850~5.895 GHz	1.29	PIFA	i-pex(MHF 4L)	300mm
				5.14	5.925~6.425 GHz	1.32			
				5.09	6.425~6.525 GHz	1.35			
				5.16	6.525~6.875 GHz	1.4			
				5.12	6.875~7.125 GHz	1.45			
3	Chain0/1	HONGBO	260-25084	3.22	2.4~2.4835 GHz	0.5	Monopole	i-pex(MHF 4L)	200mm
				3.35	5.150~5.250 GHz	0.76			
				3.42	5.250~5.350 GHz	0.78			
				4.77	5.470~5.725 GHz	0.81			
				4.72	5.725~5.850 GHz	0.85			
				4.71	5.850~5.895 GHz	0.86			
				4.75	5.925~6.425 GHz	0.87			
				4.29	6.425~6.525 GHz	0.91			
				4.81	6.525~6.875 GHz	0.96			
4.74	6.875~7.125 GHz	0.98							

Note: The above Antenna information is declared by manufacturer and for more detailed features description, please refer to the manufacturer's specifications, the laboratory shall not be held responsible.



### 3.2.1 Test Mode Applicability and Tested Channel Detail

EUT Configure Mode	Applicable To				Description
	RE $\geq$ 1G	RE<1G	PLC	OB	
-	√	√	√	√	-

Where **RE $\geq$ 1G**: Radiated Emission above 1GHz      **RE<1G**: Radiated Emission below 1GHz  
**PLC**: Power Line Conducted Emission      **OB**: Conducted Out-Band Emission Measurement

#### **Radiated Emission Test (Above 1GHz): (Radiated with 50 ohm load)**

The tested configurations represent the worst-case mode from all possible combinations by the maximum power.

Following channel(s) was (were) selected for the final test as listed below.

Configure Mode	MODE	AVAILABLE CHANNEL	TESTED CHANNEL	MODULATION TECHNOLOGY	MODULATION TYPE
1	2.4GHz: 802.11g +	1 to 13	6	OFDM	BPSK
	5.9GHz: 802.11ax (HE40)	167 to 175	175	OFDM	BPSK
2	BT-EDR +	0 to 78	0	FHSS	GFSK
	5.9GHz: 802.11ax (HE40)	167 to 175	175	OFDM	BPSK

#### **Radiated Emission Test (Below 1GHz): (Radiated with 50 ohm load)**

The tested configurations represent the worst-case mode from all possible combinations by the maximum power.

Following channel(s) was (were) selected for the final test as listed below.

Configure Mode	MODE	AVAILABLE CHANNEL	TESTED CHANNEL	MODULATION TECHNOLOGY	MODULATION TYPE
1	2.4GHz: 802.11g +	1 to 13	6	OFDM	BPSK
	5.9GHz: 802.11ax (HE40)	167 to 175	175	OFDM	BPSK
2	BT-EDR +	0 to 78	0	FHSS	GFSK
	5.9GHz: 802.11ax (HE40)	167 to 175	175	OFDM	BPSK

### Power Line Conducted Emission Test:

The tested configurations represent the worst-case mode from all possible combinations by the maximum power.

Following channel(s) was (were) selected for the final test as listed below.

Configure Mode	MODE	AVAILABLE CHANNEL	TESTED CHANNEL	MODULATION TECHNOLOGY	MODULATION TYPE
1	2.4GHz: 802.11g +	1 to 13	6	OFDM	BPSK
	5.9GHz: 802.11ax (HE40)	167 to 175	175	OFDM	BPSK
2	BT-EDR +	0 to 78	0	FHSS	GFSK
	5.9GHz: 802.11ax (HE40)	167 to 175	175	OFDM	BPSK

### Conducted Out-Band Emission Measurement:

The tested configurations represent the worst-case mode from all possible combinations by the maximum power.

Following channel(s) was (were) selected for the final test as listed below.

Configure Mode	MODE	AVAILABLE CHANNEL	TESTED CHANNEL	MODULATION TECHNOLOGY	MODULATION TYPE
1	2.4GHz: 802.11g +	1 to 13	6	OFDM	BPSK
	5.9GHz: 802.11ax (HE40)	167 to 175	175	OFDM	BPSK
2	BT-EDR +	0 to 78	0	FHSS	GFSK
	5.9GHz: 802.11ax (HE40)	167 to 175	175	OFDM	BPSK

### Test Condition:

Applicable To	Environmental Conditions	Input Power (system)	Tested By
RE $\geq$ 1G	25deg. C, 65%RH	120Vac, 60Hz	Tom Yang
RE $<$ 1G	24deg. C, 65%RH	120Vac, 60Hz	Tom Yang
PLC	25deg. C, 75%RH	120Vac, 60Hz	Tom Yang
OB	24deg. C, 57%RH	120Vac, 60Hz	Eric Peng

### 3.3 Description of Support Units

The EUT has been tested as an independent unit together with other necessary accessories or support units. The following support units or accessories were used to form a representative test configuration during the tests.

ID	Product	Brand	Model No.	Serial No.	FCC ID	Remarks
A.	Laptop	Dell	E5420	6FGHKV1	NA	Provided by Lab
B.	Test Tool	Qualcomm	Y6570	NA	NA	Supplied by client
C.	Adapter	PHIHONG	PSAA12A-120L6	NA	NA	Supplied by client

Note:

1. All power cords of the above support units are non-shielded (1.8m).

ID	Descriptions	Qty.	Length (m)	Shielding (Yes/No)	Cores (Qty.)	Remarks
1.	DC Cable	1	1.2	No	0	Supplied by client
2.	USB Cable	1	0.6	No	0	Provided by Lab

### 3.3.1 Configuration of System under Test

#### For Conducted Emissions test:

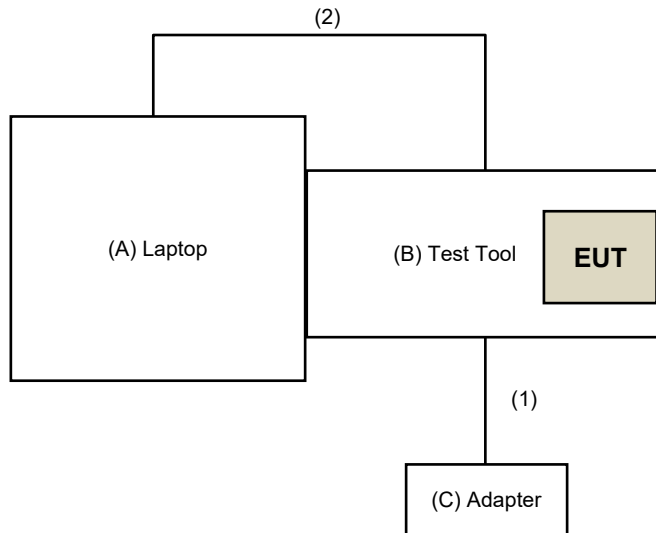

#### For other test:

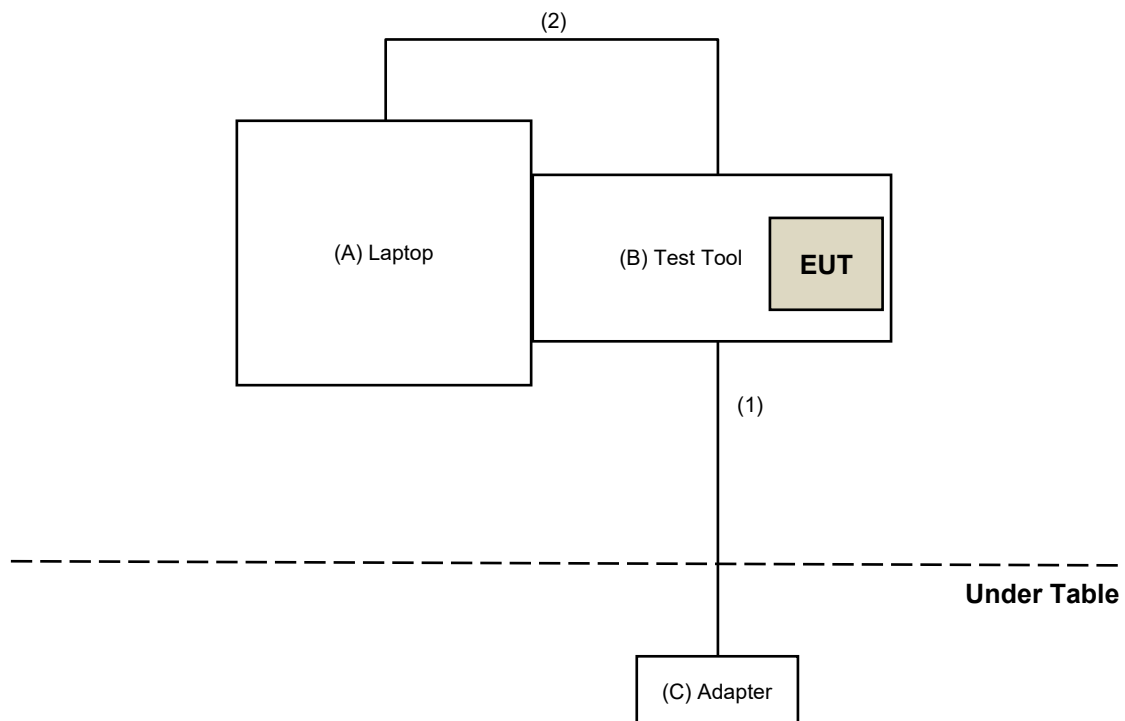

## 4 Test Types and Results

### 4.1 Radiated Emission and Bandedge Measurement

#### 4.1.1 Limits of Radiated Emission and Bandedge Measurement

Radiated emissions which fall in the restricted bands must comply with the radiated emission limits specified as below table.

Frequencies (MHz)	Field Strength (microvolts/meter)	Measurement Distance (meters)
0.009 ~ 0.490	2400/F(kHz)	300
0.490 ~ 1.705	24000/F(kHz)	30
1.705 ~ 30.0	30	30
30 ~ 88	100	3
88 ~ 216	150	3
216 ~ 960	200	3
Above 960	500	3

**Note:**

1. The lower limit shall apply at the transition frequencies.
2. Emission level (dBuV/m) = 20 log Emission level (uV/m).
3. For frequencies above 1000MHz, the field strength limits are based on average detector, however, the peak field strength of any emission shall not exceed the maximum permitted average limits, specified above by more than 20dB under any condition of modulation.

Limits of unwanted emission out of the restricted bands

Applicable To		Limit	
789033 D02 General UNII Test Procedure New Rules v02r01		Field Strength at 3m	
		PK:74 (dBµV/m)	AV:54 (dBµV/m)
Frequency Band	Applicable To	EIRP Limit	Equivalent Field Strength at 3m
5150~5250 MHz	15.407(b)(1)	PK:-27 (dBm/MHz)	PK:68.2(dBµV/m)
5250~5350 MHz	15.407(b)(2)		
5470~5725 MHz	15.407(b)(3)		
5725~5850 MHz	15.407(b)(4)(i)	PK:-27 (dBm/MHz) <sup>*1</sup> PK:10 (dBm/MHz) <sup>*2</sup> PK:15.6 (dBm/MHz) <sup>*3</sup> PK:27 (dBm/MHz) <sup>*4</sup>	PK: 68.2(dBµV/m) <sup>*1</sup> PK:105.2 (dBµV/m) <sup>*2</sup> PK: 110.8(dBµV/m) <sup>*3</sup> PK:122.2 (dBµV/m) <sup>*4</sup>
<sup>*1</sup> beyond 75 MHz or more above of the band edge. <sup>*3</sup> below the band edge increasing linearly to a level of 15.6 dBm/MHz at 5 MHz above.		<sup>*2</sup> below the band edge increasing linearly to 10 dBm/MHz at 25 MHz above. <sup>*4</sup> from 5 MHz above or below the band edge increasing linearly to a level of 27 dBm/MHz at the band edge.	

**Note:**

The following formula is used to convert the equipment isotropic radiated power (eirp) to field strength:

$$E = \frac{1000000\sqrt{30P}}{3} \mu\text{V/m, where P is the eirp (Watts).}$$

#### 4.1.2 Test Instruments

##### For Radiated Emission (Below 1GHz) test:

Description & Manufacturer	Model No.	Serial No.	Calibrated Date	Calibrated Until
Test Receiver Agilent	N9038A	MY51210202	Dec. 1, 2020	Nov. 30, 2021
Software	ADT_Radiated_V8.7.08	NA	NA	NA
Boresight Antenna Tower & Turn Table Max-Full	MF-7802BS	MF780208530	NA	NA
Pre_Amplifier EMCI	EMC001340	980142	May 24, 2021	May 23, 2022
LOOP ANTENNA Electro-Metrics	EM-6879	264	Mar. 5, 2021	Mar. 4, 2022
RF Coaxial Cable JYEBO	5D-FB	LOOPCAB-001	Jan. 7, 2021	Jan. 6, 2022
RF Coaxial Cable JYEBO	5D-FB	LOOPCAB-002	Jan. 7, 2021	Jan. 6, 2022
Pre_Amplifier EMCI	EMC330N	980701	Mar. 10, 2021	Mar. 9, 2022
Trilog Broadband Antenna Schwarzbeck	VULB 9168	9168-406	Nov. 6, 2020	Nov. 5, 2021
RF Coaxial Cable COMMATE/PEWC	8D	966-4-1	Mar. 17, 2021	Mar. 16, 2022
RF Coaxial Cable COMMATE/PEWC	8D	966-4-2	Mar. 17, 2021	Mar. 16, 2022
RF Coaxial Cable COMMATE/PEWC	8D	966-4-3	Mar. 17, 2021	Mar. 16, 2022
Fixed attenuator Mini-Circuits	UNAT-5+	PAD-ATT5-03	Jan. 11, 2021	Jan. 10, 2022

- Note: 1. The test was performed in 966 Chamber No. 4.  
 2. The calibration interval of the above test instruments is 12 months and the calibrations are traceable to NML/ROC and NIST/USA.  
 3. Tested Date: Aug. 18, 2021

**For Radiated Emission (Above 1GHz) test:**

Description & Manufacturer	Model No.	Serial No.	Calibrated Date	Calibrated Until
Test Receiver Agilent	N9038A	MY51210202	Dec. 1, 2020	Nov. 30, 2021
Software	ADT_Radiated_V8.7.08	NA	NA	NA
Boresight Antenna Tower & Turn Table Max-Full	MF-7802BS	MF780208530	NA	NA
Horn Antenna SCHWARZBECK	BBHA 9120D	9120D-783	Nov. 22, 2020	Nov. 21, 2021
Pre_Amplifier EMCI	EMC 12630 SE	980638	Apr. 7, 2021	Apr. 6, 2022
RF Cable-Frequency Range : 1-26.5GHz EMCI	EMC104-SM-SM-1200	160922	Dec. 25, 2020	Dec. 24, 2021
RF Coaxial Cable EMCI	EMC104-SM-SM-2000	180502	Apr. 26, 2021	Apr. 25, 2022
RF Coaxial Cable EMCI	EMC104-SM-SM-6000	180418	Apr. 26, 2021	Apr. 25, 2022
Pre_Amplifier EMCI	EMC184045SE	980387	Jan. 11, 2021	Jan. 10, 2022
Horn Antenna Schwarzbeck	BBHA 9170	BBHA9170519	Nov. 22, 2020	Nov. 21, 2021
RF Cable-Frequency range: 1-40GHz EMCI	EMC102-KM-KM-1200	160924	Jan. 11, 2021	Jan. 10, 2022
RF cable (40GHz) EMCI	EMC-KM-KM-4000	200214	Mar. 10, 2021	Mar. 9, 2022

- Note: 1. The test was performed in 966 Chamber No. 4.  
 2. The calibration interval of the above test instruments is 12 months and the calibrations are traceable to NML/ROC and NIST/USA.  
 3. Tested Date: Oct. 1, 2021

**For other test items:**

Description & Manufacturer	Model No.	Serial No.	Calibrated Date	Calibrated Until
Spectrum Analyzer R&S	FSV40	101516	Mar. 08, 2021	Mar. 07, 2022
10dB Attenuator Woken	MDCS18N-10	MDCS18N-10-01	Apr. 13, 2021	Apr. 12, 2022
Software	ADT_RF Test Software V6.6.5.4	NA	NA	NA

- NOTE:** 1. The test was performed in Oven room 2.  
 2. The calibration interval of the above test instruments is 12 months and the calibrations are traceable to NML/ROC and NIST/USA.  
 3. Tested Date: Sep. 24, 2021

#### 4.1.3 Test Procedures

##### **For Radiated emission below 30MHz**

- a. The EUT was placed on the top of a rotating table 0.8 meters above the ground at a 3 meter chamber room. The table was rotated 360 degrees to determine the position of the highest radiation.
- b. The EUT was set 3 meters away from the interference-receiving antenna, which was mounted on the top of a variable-height antenna tower.
- c. Parallel, perpendicular, and ground-parallel orientations of the antenna are set to make the measurement.
- d. For each suspected emission, the EUT was arranged to its worst case and the rotatable table was turned from 0 degrees to 360 degrees to find the maximum reading.
- e. The test-receiver system was set to Quasi-Peak Detect Function and Specified Bandwidth with Maximum Hold Mode.

##### **NOTE:**

1. The resolution bandwidth and video bandwidth of test receiver/spectrum analyzer is 9kHz at frequency below 30MHz.

##### **For Radiated emission above 30MHz**

- a. The EUT was placed on the top of a rotating table 0.8 meters (for 30MHz ~ 1GHz) / 1.5 meters (for above 1GHz) above the ground at 3 meter chamber room for test. The table was rotated 360 degrees to determine the position of the highest radiation.
- b. The EUT was set 3 meters away from the interference-receiving antenna, which was mounted on the top of a variable-height antenna tower.
- c. The height of antenna is varied from one meter to four meters above the ground to determine the maximum value of the field strength. Both horizontal and vertical polarizations of the antenna are set to make the measurement.
- d. For each suspected emission, the EUT was arranged to its worst case and then the antenna was tuned to heights from 1 meter to 4 meters and the rotatable table was turned from 0 degrees to 360 degrees to find the maximum reading.
- e. The test-receiver system was set to quasi-peak detect function and specified bandwidth with maximum hold mode when the test frequency is below 1 GHz.
- f. The test-receiver system was set to peak and average detects function and specified bandwidth with maximum hold mode when the test frequency is above 1 GHz. If the peak reading value also meets average limit, measurement with the average detector is unnecessary.

##### **Note:**

1. The resolution bandwidth and video bandwidth of test receiver/spectrum analyzer is 120kHz for Quasi-peak detection (QP) at frequency below 1GHz.
2. The resolution bandwidth of test receiver/spectrum analyzer is 1 MHz and the video bandwidth is 3 MHz for Peak detection (PK) at frequency above 1GHz.
3. The resolution bandwidth of test receiver/spectrum analyzer is 1MHz and the video bandwidth is  $\geq 1/T$  (Duty cycle < 98%) or 10Hz (Duty cycle  $\geq 98\%$ ) for Average detection (AV) at frequency above 1GHz.
4. All modes of operation were investigated and the worst-case emissions are reported.

#### 4.1.4 Deviation from Test Standard

No deviation.



#### 4.1.5 Test Setup

##### For Radiated emission below 30MHz

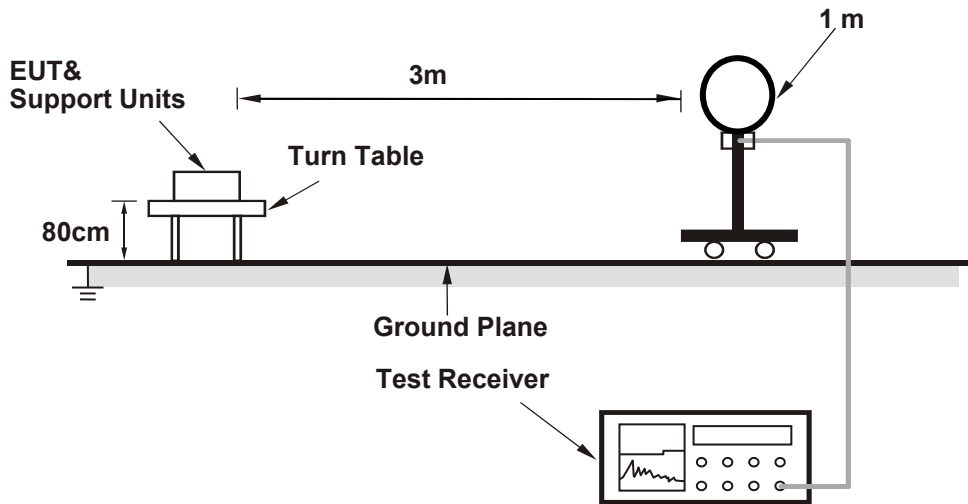

##### For Radiated emission 30MHz to 1GHz

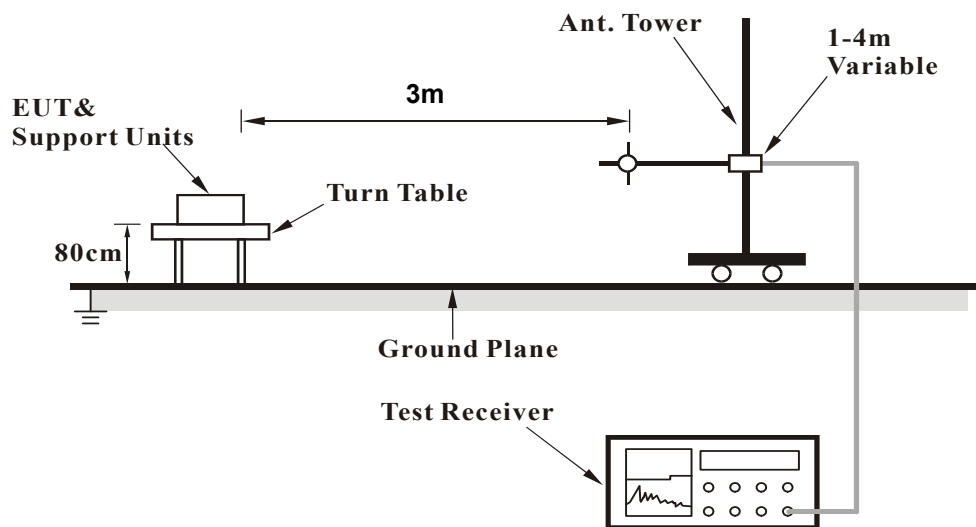

### For Radiated emission above 1GHz

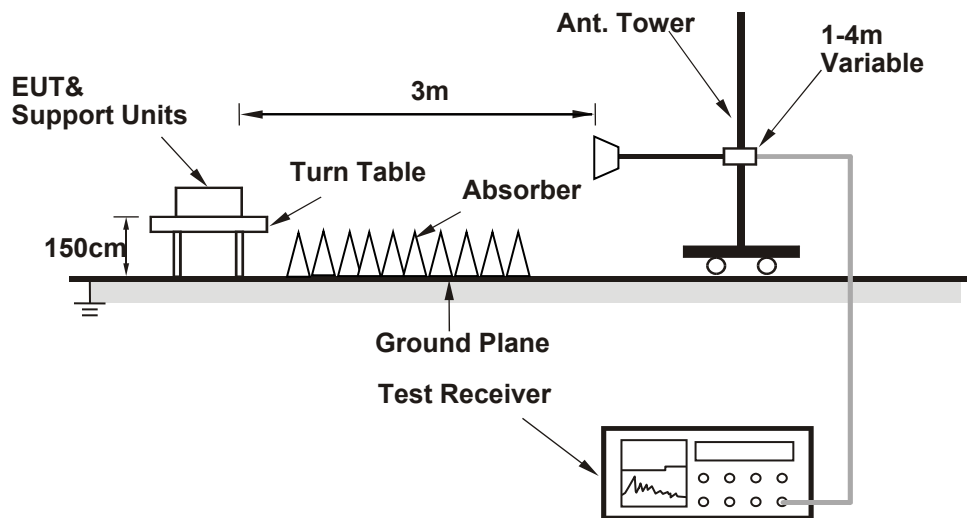

For the actual test configuration, please refer to the attached file (Test Setup Photo).

#### 4.1.6 EUT Operating Conditions

- a. Connected the EUT with the Laptop which is placed on the testing table.
- b. Controlling software (QRCT 4.0.00177.0) has been activated to set the EUT under transmission condition continuously at specific channel frequency.

#### 4.1.7 Test Results (Mode 1)

**Radiated test with 50ohm terminator on antenna port.**

#### Above 1GHz Data:

<b>Frequency Range</b>	1GHz ~ 40GHz	<b>Detector Function</b>	Peak (PK) Average (AV)
------------------------	--------------	--------------------------	---------------------------

Antenna Polarity & Test Distance : Horizontal at 3 m								
No	Frequency (MHz)	Emission Level (dBuV/m)	Limit (dBuV/m)	Margin (dB)	Antenna Height (m)	Table Angle (Degree)	Raw Value (dBuV)	Correction Factor (dB/m)
1	4874.00	42.1 PK	74.0	-31.9	2.00 H	192	38.3	3.8
2	4874.00	28.6 AV	54.0	-25.4	2.00 H	192	24.8	3.8
3	7311.00	44.7 PK	74.0	-29.3	2.47 H	333	35.0	9.7
4	7311.00	30.7 AV	54.0	-23.3	2.47 H	333	21.0	9.7
5	11750.00	48.8 PK	74.0	-25.2	1.58 H	212	34.6	14.2
6	11750.00	38.2 AV	54.0	-15.8	1.58 H	212	24.0	14.2
7	#17625.00	52.0 PK	88.2	-36.2	2.09 H	158	32.3	19.7
8	#17625.00	39.8 AV	68.2	-28.4	2.09 H	158	20.1	19.7
Antenna Polarity & Test Distance : Vertical at 3 m								
No	Frequency (MHz)	Emission Level (dBuV/m)	Limit (dBuV/m)	Margin (dB)	Antenna Height (m)	Table Angle (Degree)	Raw Value (dBuV)	Correction Factor (dB/m)
1	4874.00	40.3 PK	74.0	-33.7	1.74 V	190	36.5	3.8
2	4874.00	26.9 AV	54.0	-27.1	1.74 V	190	23.1	3.8
3	7311.00	44.6 PK	74.0	-29.4	2.02 V	73	34.9	9.7
4	7311.00	31.2 AV	54.0	-22.8	2.02 V	73	21.5	9.7
5	11750.00	51.5 PK	74.0	-22.5	3.10 V	285	37.3	14.2
6	11750.00	40.2 AV	54.0	-13.8	3.10 V	285	26.0	14.2
7	#17625.00	49.5 PK	88.2	-38.7	2.45 V	186	29.8	19.7
8	#17625.00	38.3 AV	68.2	-29.9	2.45 V	186	18.6	19.7

#### Remarks:

1. Emission Level(dBuV/m) = Raw Value(dBuV) + Correction Factor(dB/m)
2. Correction Factor(dB/m) = Antenna Factor(dB/m) + Cable Factor(dB) – Pre-Amplifier Factor(dB)
3. Margin value = Emission Level – Limit value
4. The other emission levels were very low against the limit.
5. "#": The radiated frequency is out of the restricted band.

### Below 1GHz Data:

Frequency Range	9kHz ~ 1GHz	Detector Function	Quasi-Peak (QP)
-----------------	-------------	-------------------	-----------------

Antenna Polarity & Test Distance : Horizontal at 3 m								
No	Frequency (MHz)	Emission Level (dBuV/m)	Limit (dBuV/m)	Margin (dB)	Antenna Height (m)	Table Angle (Degree)	Raw Value (dBuV)	Correction Factor (dB/m)
1	37.31	26.8 QP	40.0	-13.2	2.00 H	84	40.0	-13.2
2	96.68	27.8 QP	43.5	-15.7	2.00 H	52	45.4	-17.6
3	176.26	24.1 QP	43.5	-19.4	2.00 H	14	37.9	-13.8
4	318.06	30.9 QP	46.0	-15.1	1.00 H	123	42.3	-11.4
5	366.53	27.6 QP	46.0	-18.4	1.00 H	118	37.8	-10.2
6	454.25	30.9 QP	46.0	-15.1	2.00 H	102	38.7	-7.8

### Remarks:

1. Emission Level(dBuV/m) = Raw Value(dBuV) + Correction Factor(dB/m)
2. Correction Factor(dB/m) = Antenna Factor(dB/m) + Cable Factor(dB) – Pre-Amplifier Factor(dB)
3. Margin value = Emission Level – Limit value
4. The other emission levels were very low against the limit of frequency range 30MHz~1000MHz.
5. The emission levels were very low against the limit of frequency range 9kHz~30MHz: the amplitude of spurious emissions attenuated more than 20 dB below the permissible value to be report.

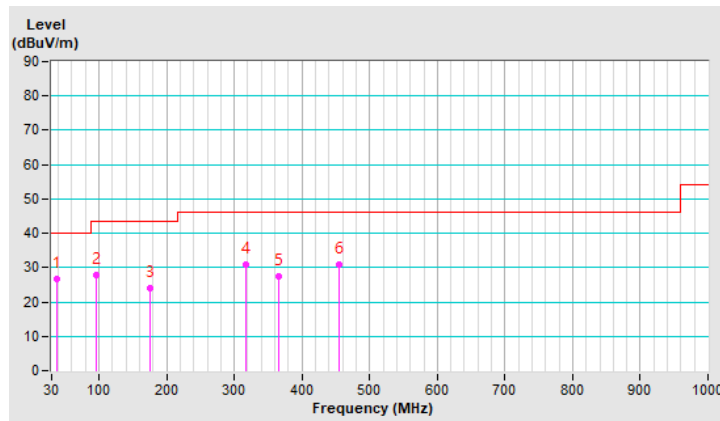

Frequency Range	9kHz ~ 1GHz	Detector Function	Quasi-Peak (QP)
-----------------	-------------	-------------------	-----------------

**Antenna Polarity & Test Distance : Vertical at 3 m**

No	Frequency (MHz)	Emission Level (dBuV/m)	Limit (dBuV/m)	Margin (dB)	Antenna Height (m)	Table Angle (Degree)	Raw Value (dBuV)	Correction Factor (dB/m)
1	37.67	34.4 QP	40.0	-5.6	1.00 V	8	47.6	-13.2
2	122.26	25.7 QP	43.5	-17.8	1.00 V	105	40.2	-14.5
3	170.98	27.7 QP	43.5	-15.8	1.00 V	35	40.9	-13.2
4	324.18	26.1 QP	46.0	-19.9	1.00 V	144	37.4	-11.3
5	454.37	24.9 QP	46.0	-21.1	2.00 V	117	32.7	-7.8
6	632.89	27.6 QP	46.0	-18.4	1.00 V	2	31.8	-4.2

**Remarks:**

1. Emission Level(dBuV/m) = Raw Value(dBuV) + Correction Factor(dB/m)
2. Correction Factor(dB/m) = Antenna Factor(dB/m) + Cable Factor(dB) – Pre-Amplifier Factor(dB)
3. Margin value = Emission Level – Limit value
4. The other emission levels were very low against the limit of frequency range 30MHz~1000MHz.
5. The emission levels were very low against the limit of frequency range 9kHz~30MHz: the amplitude of spurious emissions attenuated more than 20 dB below the permissible value to be report.

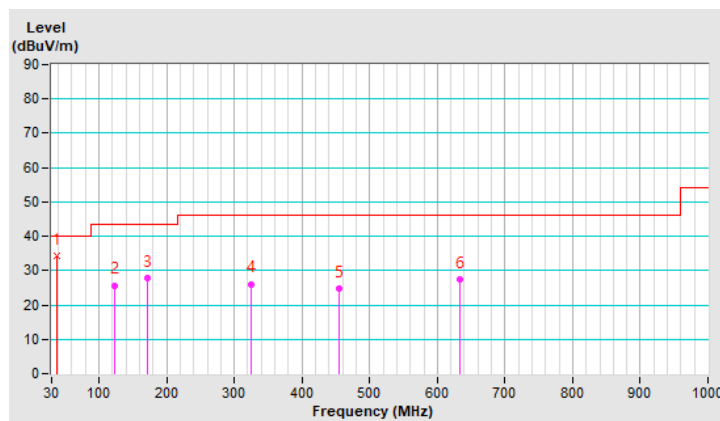

#### 4.1.8 Test Results (Mode 2)

**Radiated test with 50ohm terminator on antenna port.**

**Above 1GHz Data:**

<b>Frequency Range</b>	1GHz ~ 40GHz	<b>Detector Function</b>	Peak (PK) Average (AV)
------------------------	--------------	--------------------------	---------------------------

#### Antenna Polarity & Test Distance : Horizontal at 3 m

No	Frequency (MHz)	Emission Level (dBuV/m)	Limit (dBuV/m)	Margin (dB)	Antenna Height (m)	Table Angle (Degree)	Raw Value (dBuV)	Correction Factor (dB/m)
1	4804.00	39.8 PK	74.0	-34.2	1.39 H	305	36.0	3.8
2	4804.00	27.6 AV	54.0	-26.4	1.39 H	305	23.8	3.8
3	11750.00	49.4 PK	74.0	-24.6	1.68 H	219	35.2	14.2
4	11750.00	38.5 AV	54.0	-15.5	1.68 H	219	24.3	14.2
5	#17625.00	51.7 PK	88.2	-36.5	2.06 H	157	32.0	19.7
6	#17625.00	39.5 AV	68.2	-28.7	2.06 H	157	19.8	19.7

#### Antenna Polarity & Test Distance : Vertical at 3 m

No	Frequency (MHz)	Emission Level (dBuV/m)	Limit (dBuV/m)	Margin (dB)	Antenna Height (m)	Table Angle (Degree)	Raw Value (dBuV)	Correction Factor (dB/m)
1	4804.00	39.9 PK	74.0	-34.1	1.54 V	181	36.1	3.8
2	4804.00	27.9 AV	54.0	-26.1	1.54 V	181	24.1	3.8
3	11750.00	50.9 PK	74.0	-23.1	3.14 V	286	36.7	14.2
4	11750.00	40.1 AV	54.0	-13.9	3.14 V	286	25.9	14.2
5	#17625.00	49.7 PK	88.2	-38.5	2.37 V	180	30.0	19.7
6	#17625.00	38.6 AV	68.2	-29.6	2.37 V	180	18.9	19.7

#### Remarks:

1. Emission Level(dBuV/m) = Raw Value(dBuV) + Correction Factor(dB/m)
2. Correction Factor(dB/m) = Antenna Factor(dB/m) + Cable Factor(dB) – Pre-Amplifier Factor(dB)
3. Margin value = Emission Level – Limit value
4. The other emission levels were very low against the limit.
5. "#": The radiated frequency is out of the restricted band.

### Below 1GHz Data:

<b>Frequency Range</b>	9kHz ~ 1GHz	<b>Detector Function</b>	Quasi-Peak (QP)
------------------------	-------------	--------------------------	-----------------

Antenna Polarity & Test Distance : Horizontal at 3 m								
No	Frequency (MHz)	Emission Level (dBuV/m)	Limit (dBuV/m)	Margin (dB)	Antenna Height (m)	Table Angle (Degree)	Raw Value (dBuV)	Correction Factor (dB/m)
1	38.27	28.7 QP	40.0	-11.3	2.00 H	106	41.8	-13.1
2	98.69	30.2 QP	43.5	-13.3	2.00 H	55	47.4	-17.2
3	174.82	24.8 QP	43.5	-18.7	2.00 H	10	38.4	-13.6
4	317.86	29.6 QP	46.0	-16.4	1.00 H	139	41.0	-11.4
5	367.10	29.9 QP	46.0	-16.1	1.00 H	115	40.1	-10.2
6	454.02	29.7 QP	46.0	-16.3	2.00 H	76	37.5	-7.8

### Remarks:

1. Emission Level(dBuV/m) = Raw Value(dBuV) + Correction Factor(dB/m)
2. Correction Factor(dB/m) = Antenna Factor(dB/m) + Cable Factor(dB) – Pre-Amplifier Factor(dB)
3. Margin value = Emission Level – Limit value
4. The other emission levels were very low against the limit of frequency range 30MHz~1000MHz.
5. The emission levels were very low against the limit of frequency range 9kHz~30MHz: the amplitude of spurious emissions attenuated more than 20 dB below the permissible value to be report.

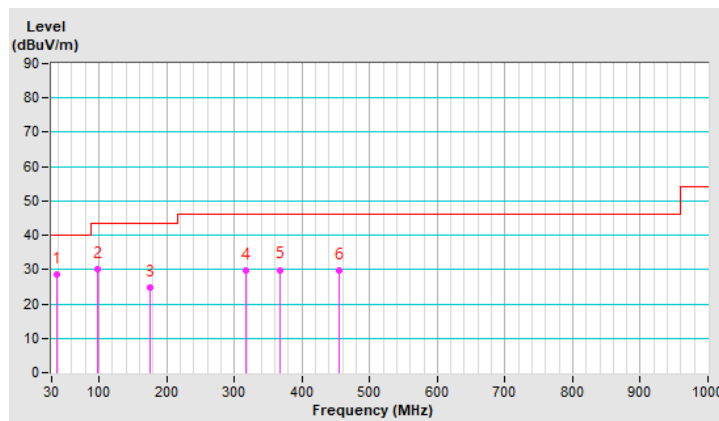

Frequency Range	9kHz ~ 1GHz	Detector Function	Quasi-Peak (QP)
-----------------	-------------	-------------------	-----------------

Antenna Polarity & Test Distance : Vertical at 3 m								
No	Frequency (MHz)	Emission Level (dBuV/m)	Limit (dBuV/m)	Margin (dB)	Antenna Height (m)	Table Angle (Degree)	Raw Value (dBuV)	Correction Factor (dB/m)
1	37.41	34.3 QP	40.0	-5.7	1.00 V	352	47.5	-13.2
2	123.15	24.5 QP	43.5	-19.0	1.00 V	129	38.9	-14.4
3	171.50	27.9 QP	43.5	-15.6	1.00 V	34	41.2	-13.3
4	323.45	24.6 QP	46.0	-21.4	1.00 V	142	35.9	-11.3
5	452.45	25.3 QP	46.0	-20.7	2.00 V	117	33.1	-7.8
6	633.89	28.5 QP	46.0	-17.5	1.00 V	348	32.6	-4.1

**Remarks:**

1. Emission Level(dBuV/m) = Raw Value(dBuV) + Correction Factor(dB/m)
2. Correction Factor(dB/m) = Antenna Factor(dB/m) + Cable Factor(dB) – Pre-Amplifier Factor(dB)
3. Margin value = Emission Level – Limit value
4. The other emission levels were very low against the limit of frequency range 30MHz~1000MHz.
5. The emission levels were very low against the limit of frequency range 9kHz~30MHz: the amplitude of spurious emissions attenuated more than 20 dB below the permissible value to be report.

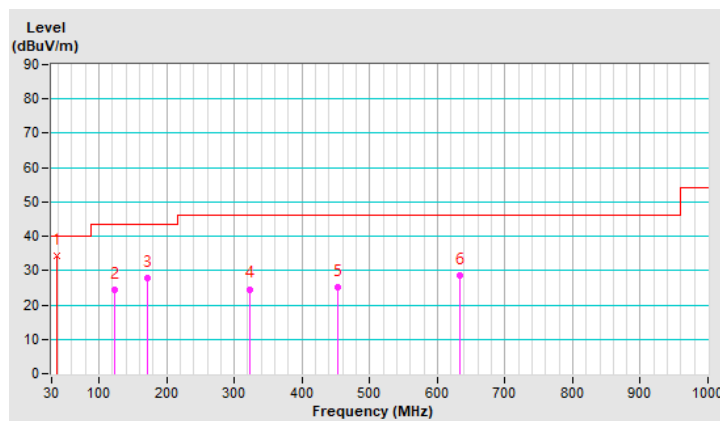



## 4.2 Conducted Emission Measurement

### 4.2.1 Limits of Conducted Emission Measurement

Frequency (MHz)	Conducted Limit (dBuV)	
	Quasi-peak	Average
0.15 - 0.5	66 - 56	56 - 46
0.50 - 5.0	56	46
5.0 - 30.0	60	50

Note: 1. The lower limit shall apply at the transition frequencies.

2. The limit decreases in line with the logarithm of the frequency in the range of 0.15 to 0.50MHz.

### 4.2.2 Test Instruments

Description & Manufacturer	Model No.	Serial No.	Calibrated Date	Calibrated Until
Test Receiver R&S	ESCS 30	847124/029	Oct. 20, 2020	Oct. 19, 2021
LISN R&S	ESH3-Z5	848773/004	Oct. 27, 2020	Oct. 26, 2021
LISN R & S	ESH3-Z5	835239/001	Mar. 26, 2021	Mar. 25, 2022
50 ohms Terminator	50	3	Oct. 26, 2020	Oct. 25, 2021
RF Coaxial Cable JYEBO	5D-FB	COCCAB-001	Sep. 26, 2020	Sep. 25, 2021
Fixed attenuator STI	STI02-2200-10	005	Aug. 29, 2020	Aug. 28, 2021
Software BVADT	BVADT_Cond_V7.3.7.4	NA	NA	NA

Note: 1. The test was performed in Conduction 1.

2. The calibration interval of the above test instruments is 12 months and the calibrations are traceable to NML/ROC and NIST/USA.

3. Tested Date: Aug. 18, 2021

#### 4.2.3 Test Procedures

- The EUT was placed 0.4 meters from the conducting wall of the shielded room with EUT being connected to the power mains through a line impedance stabilization network (LISN). Other support units were connected to the power mains through another LISN. The two LISNs provide 50 ohm/ 50uH of coupling impedance for the measuring instrument.
- Both lines of the power mains connected to the EUT were checked for maximum conducted interference.
- The frequency range from 150kHz to 30MHz was searched. Emission levels under (Limit - 20dB) was not recorded.

**Note:** The resolution bandwidth and video bandwidth of test receiver is 9kHz for quasi-peak detection (QP) and average detection (AV) at frequency 0.15MHz-30MHz.

#### 4.2.4 Deviation from Test Standard

No deviation.

#### 4.2.5 Test Setup

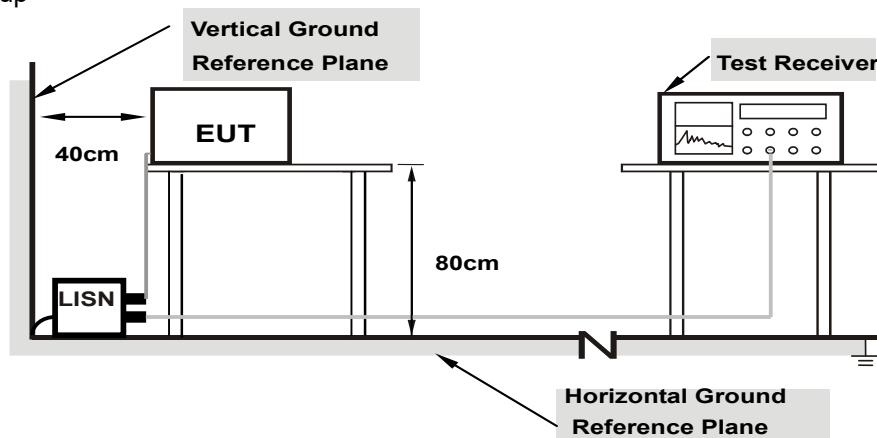

**Note:** 1.Support units were connected to second LISN.

For the actual test configuration, please refer to the attached file (Test Setup Photo).

#### 4.2.6 EUT Operating Conditions

Same as 4.1.6.

#### 4.2.7 Test Results (Mode 1)

<b>Frequency Range</b>	150kHz ~ 30MHz	<b>Detector Function &amp; Resolution Bandwidth</b>	Quasi-Peak (QP) / Average (AV), 9kHz
------------------------	----------------	---	--------------------------------------

Phase Of Power : Line (L)										
No	Frequency (MHz)	Correction Factor (dB)	Reading Value (dBuV)		Emission Level (dBuV)		Limit (dBuV)		Margin (dB)	
			Q.P.	AV.	Q.P.	AV.	Q.P.	AV.	Q.P.	AV.
1	0.15043	10.05	39.17	25.62	49.22	35.67	65.98	55.98	-16.76	-20.31
2	0.21453	10.05	30.17	15.81	40.22	25.86	63.03	53.03	-22.81	-27.17
3	0.38114	10.07	24.42	8.53	34.49	18.60	58.25	48.25	-23.76	-29.65
4	0.58573	10.08	32.73	24.14	42.81	34.22	56.00	46.00	-13.19	-11.78
5	0.91979	10.10	18.14	14.53	28.24	24.63	56.00	46.00	-27.76	-21.37
6	15.20557	10.93	26.73	20.53	37.66	31.46	60.00	50.00	-22.34	-18.54

**Remarks:**

1. Q.P. and AV. are abbreviations of quasi-peak and average individually.
2. The emission levels of other frequencies were very low against the limit.
3. Margin value = Emission level – Limit value
4. Correction factor = Insertion loss + Cable loss
5. Emission Level = Correction Factor + Reading Value

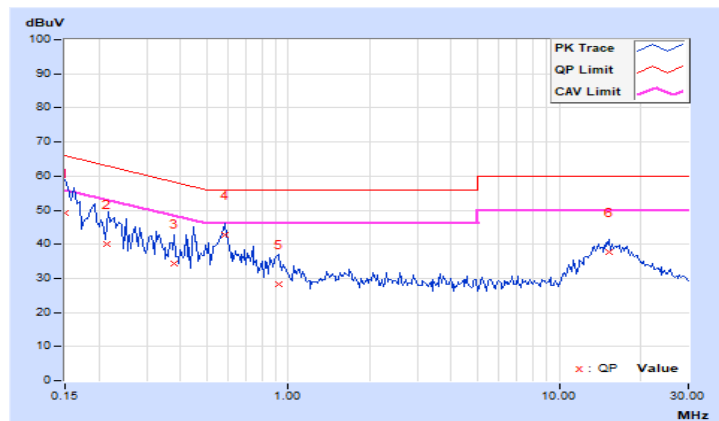

<b>Frequency Range</b>	150kHz ~ 30MHz	<b>Detector Function &amp; Resolution Bandwidth</b>	Quasi-Peak (QP) / Average (AV), 9kHz
------------------------	----------------	---	--------------------------------------

Phase Of Power : Neutral (N)										
No	Frequency (MHz)	Correction Factor (dB)	Reading Value (dBuV)		Emission Level (dBuV)		Limit (dBuV)		Margin (dB)	
			Q.P.	AV.	Q.P.	AV.	Q.P.	AV.	Q.P.	AV.
1	0.18147	10.03	33.14	18.17	43.17	28.20	64.42	54.42	-21.25	-26.22
2	0.27526	10.03	28.05	10.62	38.08	20.65	60.96	50.96	-22.88	-30.31
3	0.54018	10.05	22.31	12.54	32.36	22.59	56.00	46.00	-23.64	-23.41
4	1.16039	10.09	13.14	4.11	23.23	14.20	56.00	46.00	-32.77	-31.80
5	3.05884	10.17	12.03	1.52	22.20	11.69	56.00	46.00	-33.80	-34.31
6	17.05442	10.82	20.08	13.71	30.90	24.53	60.00	50.00	-29.10	-25.47

**Remarks:**

1. Q.P. and AV. are abbreviations of quasi-peak and average individually.
2. The emission levels of other frequencies were very low against the limit.
3. Margin value = Emission level – Limit value
4. Correction factor = Insertion loss + Cable loss
5. Emission Level = Correction Factor + Reading Value

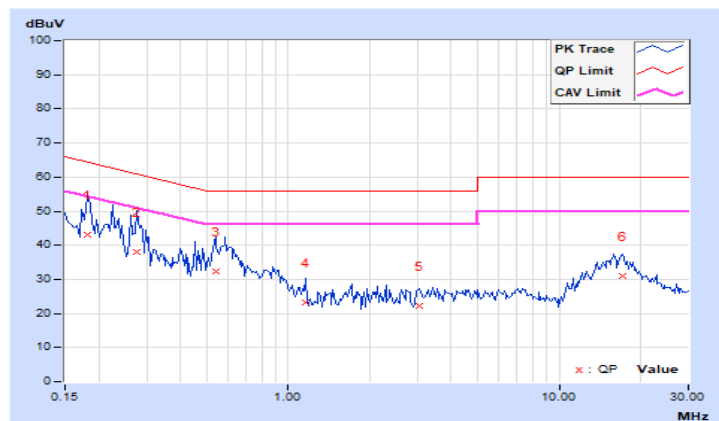

## 4.2.8 Test Results (Mode 2)

<b>Frequency Range</b>	150kHz ~ 30MHz	<b>Detector Function &amp; Resolution Bandwidth</b>	Quasi-Peak (QP) / Average (AV), 9kHz
------------------------	----------------	---	--------------------------------------

Phase Of Power : Line (L)										
No	Frequency (MHz)	Correction Factor (dB)	Reading Value (dBuV)		Emission Level (dBuV)		Limit (dBuV)		Margin (dB)	
			Q.P.	AV.	Q.P.	AV.	Q.P.	AV.	Q.P.	AV.
1	0.15044	10.05	39.85	25.43	49.90	35.48	65.98	55.98	-16.08	-20.50
2	0.21415	10.05	30.15	15.83	40.20	25.88	63.04	53.04	-22.84	-27.16
3	0.38178	10.07	24.14	8.56	34.21	18.63	58.24	48.24	-24.03	-29.61
<b>4</b>	<b>0.58595</b>	<b>10.08</b>	<b>32.76</b>	<b>24.32</b>	<b>42.84</b>	<b>34.40</b>	<b>56.00</b>	<b>46.00</b>	<b>-13.16</b>	<b>-11.60</b>
5	0.91905	10.10	18.85	14.65	28.95	24.75	56.00	46.00	-27.05	-21.25
6	15.20507	10.93	26.85	20.73	37.78	31.66	60.00	50.00	-22.22	-18.34

**Remarks:**

1. Q.P. and AV. are abbreviations of quasi-peak and average individually.
2. The emission levels of other frequencies were very low against the limit.
3. Margin value = Emission level – Limit value
4. Correction factor = Insertion loss + Cable loss
5. Emission Level = Correction Factor + Reading Value

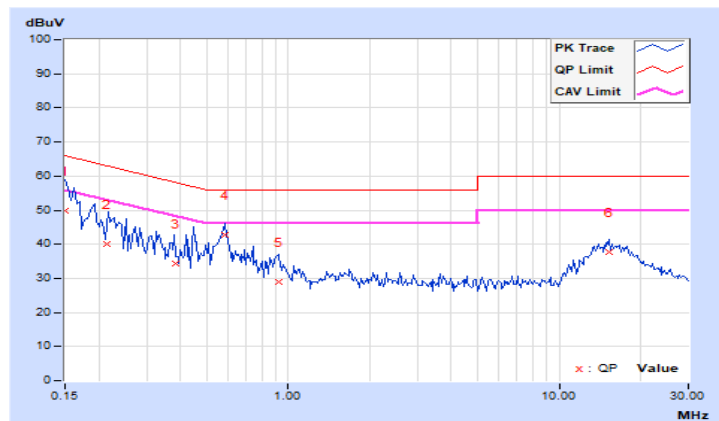

<b>Frequency Range</b>	150kHz ~ 30MHz	<b>Detector Function &amp; Resolution Bandwidth</b>	Quasi-Peak (QP) / Average (AV), 9kHz
------------------------	----------------	---	--------------------------------------

Phase Of Power : Neutral (N)										
No	Frequency (MHz)	Correction Factor (dB)	Reading Value (dBuV)		Emission Level (dBuV)		Limit (dBuV)		Margin (dB)	
			Q.P.	AV.	Q.P.	AV.	Q.P.	AV.	Q.P.	AV.
1	0.18125	10.03	33.08	18.55	43.11	28.58	64.43	54.43	-21.32	-25.85
2	0.27531	10.03	28.36	10.41	38.39	20.44	60.96	50.96	-22.57	-30.52
3	0.54022	10.05	22.18	12.46	32.23	22.51	56.00	46.00	-23.77	-23.49
4	1.16046	10.09	13.63	4.71	23.72	14.80	56.00	46.00	-32.28	-31.20
5	3.05897	10.17	12.65	1.85	22.82	12.02	56.00	46.00	-33.18	-33.98
6	17.05463	10.82	20.17	13.62	30.99	24.44	60.00	50.00	-29.01	-25.56

**Remarks:**

1. Q.P. and AV. are abbreviations of quasi-peak and average individually.
2. The emission levels of other frequencies were very low against the limit.
3. Margin value = Emission level – Limit value
4. Correction factor = Insertion loss + Cable loss
5. Emission Level = Correction Factor + Reading Value

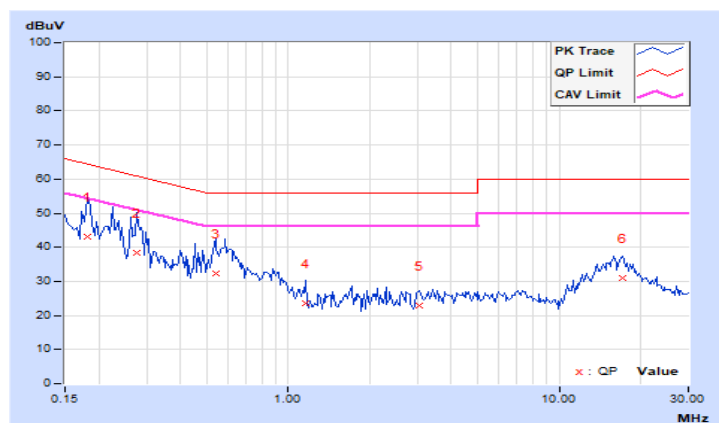

### 4.3 Conducted Out of Band Emission Measurement

#### 4.3.1 Limits of Conducted Out of Band Emission Measurement

Below 20dB of the highest emission level of operating band (in 100kHz Resolution Bandwidth).

#### 4.3.2 Test Setup

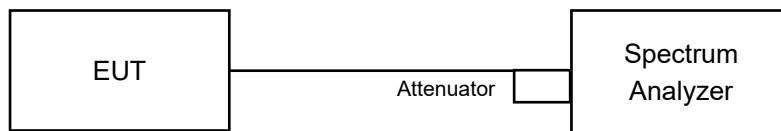

#### 4.3.3 Test Instruments

Refer to section 4.1.2 to get information of above instrument.

#### 4.3.4 Test Procedures

##### MEASUREMENT PROCEDURE REF

1. Set the RBW = 100 kHz.
2. Set the VBW  $\geq$  300 kHz.
3. Detector = peak.
4. Sweep time = auto couple.
5. Trace mode = max hold.
6. Allow trace to fully stabilize.
7. Use the peak marker function to determine the maximum power level in any 100 kHz band segment within the fundamental EBW.

##### MEASUREMENT PROCEDURE OOB

1. Set RBW = 100 kHz.
2. Set VBW  $\geq$  300 kHz.
3. Detector = peak.
4. Sweep = auto couple.
5. Trace Mode = max hold.
6. Allow trace to fully stabilize.
7. Use the peak marker function to determine the maximum amplitude level.

#### 4.3.5 Deviation from Test Standard

No deviation.

#### 4.3.6 EUT Operating Conditions

The software provided by client to enable the EUT under transmission condition continuously at specific channel frequencies individually.

### 4.3.7 Test Results (Mode 1)

The spectrum plots are attached on the following pages. D1 line indicates the highest level, and D2 line indicates the 20dB offset below D1. It shows compliance with the requirement.

#### 2.4GHz\_802.11g\_CH6 + 5.9GHz\_802.11ax (HE40)\_CH175

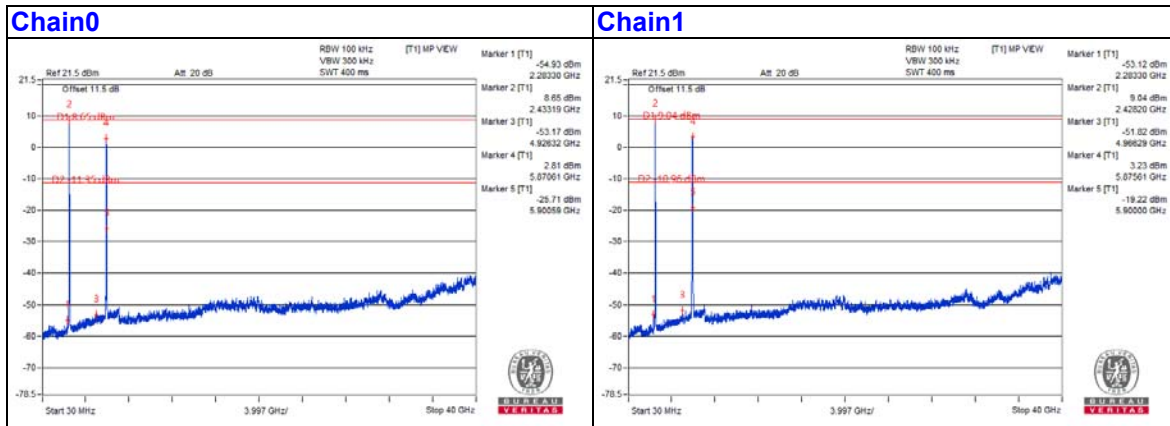

### 4.3.8 Test Results (Mode 2)

The spectrum plots are attached on the following pages. D1 line indicates the highest level, and D2 line indicates the 20dB offset below D1. It shows compliance with the requirement.

#### BT-EDR\_GFSK\_CH0 + 5.9GHz\_802.11ax (HE40)\_CH175

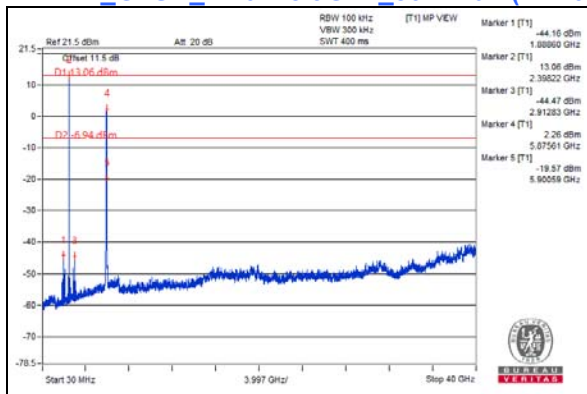



## 5 Pictures of Test Arrangements

Please refer to the attached file (Test Setup Photo).

## Appendix – Information of the Testing Laboratories

We, Bureau Veritas Consumer Products Services (H.K.) Ltd., Taoyuan Branch, were founded in 1988 to provide our best service in EMC, Radio, Telecom and Safety consultation. Our laboratories are FCC recognized accredited test firms and accredited according to ISO/IEC 17025.

If you have any comments, please feel free to contact us at the following:

### **Lin Kou EMC/RF Lab**

Tel: 886-2-26052180

Fax: 886-2-26051924

### **Hsin Chu EMC/RF/Telecom Lab**

Tel: 886-3-6668565

Fax: 886-3-6668323

### **Hwa Ya EMC/RF/Safety Lab**

Tel: 886-3-3183232

Fax: 886-3-3270892

**Email:** [service.adt@tw.bureauveritas.com](mailto:service.adt@tw.bureauveritas.com)

**Web Site:** [www.bureauveritas-adt.com](http://www.bureauveritas-adt.com)

The address and road map of all our labs can be found in our web site also.

--- END ---