

FCC Test Report

Report No.: RF201119E01-7

FCC ID: J9C-QCNFA765

Test Model: QCNFA765

Received Date: Nov. 19, 2020

Test Date: July 31 to Sep. 27, 2021

Issued Date: Oct. 01, 2021

Applicant: Qualcomm Technologies, Inc.

Address: 5775 Morehouse Drive, San Diego, CA 92121-1714

Issued By: Bureau Veritas Consumer Products Services (H.K.) Ltd., Taoyuan Branch
Hsin Chu Laboratory

Lab Address: E-2, No.1, Li Hsin 1st Road, Hsinchu Science Park, Hsinchu City 300,
Taiwan

Test Location: E-2, No.1, Li Hsin 1st Road, Hsinchu Science Park, Hsinchu City 300,
Taiwan

**FCC Registration /
Designation Number:** 723255 / TW2022



This report is for your exclusive use. Any copying or replication of this report to or for any other person or entity, or use of our name or trademark, is permitted only with our prior written permission. This report sets forth our findings solely with respect to the test samples identified herein. The results set forth in this report are not indicative or representative of the quality or characteristics of the lot from which a test sample was taken or any similar or identical product unless specifically and expressly noted. Our report includes all of the tests requested by you and the results thereof based upon the information that you provided to us. You have 60 days from date of issuance of this report to notify us of any material error or omission caused by our negligence, provided, however, that such notice shall be in writing and shall specifically address the issue you wish to raise. A failure to raise such issue within the prescribed time shall constitute your unqualified acceptance of the completeness of this report, the tests conducted and the correctness of the report contents. Unless specifically mentioned, the uncertainty of measurement has been explicitly taken into account to declare the compliance or non-compliance to the specification.

Table of Contents

Release Control Record	4
1 Certificate of Conformity	5
2 Summary of Test Results	6
2.1 Measurement Uncertainty.....	6
2.2 Modification Record.....	6
3 General Information	7
3.1 General Description of EUT.....	7
3.2 Description of Antenna.....	9
3.3 Description of Test Modes.....	10
3.3.1 Test Mode Applicability and Tested Channel Detail.....	11
3.4 Duty Cycle of Test Signal.....	14
3.5 Description of Support Units.....	16
3.5.1 Configuration of System under Test.....	17
3.6 General Description of Applied Standards and References.....	18
4 Test Types and Results	19
4.1 Unwanted Emission and Bandedge Measurement.....	19
4.1.1 Limits of Unwanted Emission and Bandedge Measurement.....	19
4.1.2 Test Instruments.....	20
4.1.3 Test Procedure.....	22
4.1.4 Test Setup.....	24
4.1.5 EUT Operating Condition.....	25
4.1.6 Test Results (Radiated Measurement).....	25
4.1.7 Test Results (Conducted Measurement).....	48
4.2 Conducted Emission Measurement.....	130
4.2.1 Limits of Conducted Emission Measurement.....	130
4.2.2 Test Instruments.....	130
4.2.3 Test Procedure.....	131
4.2.4 Test Setup.....	131
4.2.5 EUT Operating Condition.....	131
4.2.6 Test Results.....	132
4.3 Transmit Power Measurement.....	134
4.3.1 Limits of Transmit Power Measurement.....	134
4.3.2 Test Setup.....	134
4.3.3 Test Instruments.....	134
4.3.4 Test Procedure.....	134
4.3.5 EUT Operating Condition.....	134
4.3.6 Test Result.....	135
4.4 6dB Bandwidth Measurement.....	141
4.4.1 Limits of Emission Bandwidth Measurement.....	141
4.4.2 Test Setup.....	141
4.4.3 Test Instruments.....	141
4.4.4 Test Procedure.....	141
4.4.5 EUT Operating Condition.....	141
4.4.6 Test Results.....	142
4.5 Peak Power Spectral Density Measurement.....	146
4.5.1 Limits of Peak Power Spectral Density Measurement.....	146
4.5.2 Test Setup.....	146
4.5.3 Test Instruments.....	146
4.5.4 Test Procedure.....	146
4.5.5 EUT Operating Condition.....	146
4.5.6 Test Results.....	147
4.6 Frequency Stability Measurement.....	154
4.6.1 Limits of Frequency Stability Measurement.....	154

4.6.2	Test Setup.....	154
4.6.3	Test Instruments	154
4.6.4	Test Procedure	154
4.6.5	EUT Operating Condition	154
4.6.6	Test Results	155
4.7	Operational Restrictions for U-NII 4 Devices	156
4.7.1	Limits of Operational Restrictions for U-NII 4 Devices	156
4.7.2	Test Setup.....	156
4.7.3	Test Instruments	156
4.7.4	Test Procedure	156
4.7.5	Test Results	156
5	Pictures of Test Arrangements.....	157
6	Appendix A – Radiated Emission Measurement	158
6.1.1	Limits of Radiated Emission and Bandedge Measurement	158
6.1.2	Test Instruments	159
6.1.3	Test Procedure	160
6.1.4	Test Setup.....	160
6.1.5	EUT Operating Condition	160
6.1.6	Test Results	161
	Appendix – Information of the Testing Laboratories	189

Release Control Record

Issue No.	Description	Date Issued
RF201119E01-7	Original release.	Oct. 01, 2021

1 Certificate of Conformity

Product: Wi-Fi 6E BT 5.2 M.2 2230 Module

Brand: Qualcomm

Test Model: QCNFA765

Sample Status: Engineering sample

Applicant: Qualcomm Technologies, Inc.

Test Date: July 31 to Sep. 27, 2021

Standard: 47 CFR FCC Part 15, Subpart E (Section 15.407)
ANSI C63.10: 2013

The above equipment has been tested by **Bureau Veritas Consumer Products Services (H.K.) Ltd., Taoyuan Branch**, and found compliance with the requirement of the above standards. The test record, data evaluation & Equipment Under Test (EUT) configurations represented herein are true and accurate accounts of the measurements of the sample's EMC characteristics under the conditions specified in this report.

Prepared by : Phoenix Huang , **Date:** Oct. 01, 2021
Phoenix Huang / Specialist

Approved by : Clark Lin , **Date:** Oct. 01, 2021
Clark Lin / Technical Manager

2 Summary of Test Results

47 CFR FCC Part 15, Subpart E (Section 15.407)			
FCC Clause	Test Item	Result	Remarks
15.407(b)(8)	AC Power Conducted Emissions	Pass	Meet the requirement of limit. Minimum passing margin is -11.64 dB at 0.58547 MHz.
15.407(b)(5)(8)	Unwanted Emissions	Pass	Meet the requirement of limit. Minimum passing margin is -0.2 dB at 5928.05 MHz.
15.407(a)(3)	Max Average Transmit Power	Pass	Meet the requirement of limit.
15.407(a)(3)	Peak Power Spectral Density	Pass	Meet the requirement of limit.
15.407(e)	6dB Bandwidth Measurement	Pass	Meet the requirement of limit.
15.407(g)	Frequency Stability	Pass	Meet the requirement of limit.
15.403	Operational restrictions U-NII 4 devices	Pass	Declaration by applicant
15.203 or 15.403	Antenna Requirement	Pass	Antenna connector is i-pex(MHF 4L) not a standard connector.

Note:

Determining compliance based on the results of the compliance measurement, not taking into account measurement instrumentation uncertainty.

2.1 Measurement Uncertainty

Where relevant, the following measurement uncertainty levels have been estimated for tests performed on the EUT as specified in CISPR 16-4-2:

Measurement	Frequency	Expanded Uncertainty (k=2) (±)
Conducted Emissions at mains ports	150kHz ~ 30MHz	1.9 dB
Radiated Emissions up to 1 GHz	9kHz ~ 30MHz	3.1 dB
	30MHz ~ 1GHz	5.5 dB
Radiated Emissions above 1 GHz	1GHz ~ 18GHz	5.1 dB
	18GHz ~ 40GHz	5.3 dB

2.2 Modification Record

There were no modifications required for compliance.

3 General Information

3.1 General Description of EUT

Product	Wi-Fi 6E BT 5.2 M.2 2230 Module
Brand	Qualcomm
Test Model	QCNFA765
Status of EUT	Engineering sample
Power Supply Rating	3.3Vdc from host equipment
Modulation Type	64QAM, 16QAM, QPSK, BPSK for OFDM 256QAM for OFDM in 11ac mode 1024QAM for OFDMA in 11ax HE mode
Modulation Technology	OFDM, OFDMA
Transfer Rate	802.11a: up to 54 Mbps 802.11n: up to 300 Mbps 802.11ac: up to 2166.7 Mbps 802.11ax: up to 2969.7 Mbps
Operating Frequency	5.845 ~ 5.885 GHz
Number of Channel	802.11a, 802.11n (HT20), 802.11ac (VHT20), 802.11ax (HE20): 3 802.11n (HT40), 802.11ac (VHT40), 802.11ax (HE40): 2 802.11ac (VHT80), 802.11ax (HE80): 1 802.11ac (VHT160), 802.11ax (HE160): 1
EIRP	26.45 dBm (441.57 mW)
Antenna Type	Refer to section 3.2
Antenna Connector	Refer to section 3.2
Accessory Device	NA
Data Cable Supplied	NA

Note:

- This report is prepared for FCC class II change. The difference compared with the Report No.: RF201119E01-1 as the following:
 - ◆ Enable U-NII-4 and U-NII-3 & -4 span channels through software change.
- According to above conditions, for U-NII-4 band all of test items need to be performed and all data was tested to meet the requirements.
- This device of WLAN (2.4GHz & 5GHz U-NII-1 Band) can support hotspot mode.
- The module has two variant designs as following table:

SKU No.	Description
SKU #1	M.2 2230 E-key
SKU #2	M.2 2230 AE-key

From the above variants designs, the worst case was found in **SKU #1**. Therefore only the test data of the mode was recorded in this report.

- The product provides option to depopulate external LNA (Low-Noise amplifier) from 5GHz/6GHz receive path. This test report covers variation of with/without external LNA and test was conducted to confirm not change in RF compliance and EMC. And worst case was found in without external LNA.

6. Simultaneously transmission condition.

Condition	Technology	
1	WLAN(2.4GHz)	WLAN(6GHz)
2	WLAN(2.4GHz)	WLAN(5GHz)
3	WLAN(2.4GHz)	WLAN(5.9GHz)
4	WLAN(6GHz)	Bluetooth
5	WLAN(5GHz)	Bluetooth
6	WLAN(5.9GHz)	Bluetooth

Note: The emission of the simultaneous operation has been evaluated and no non-compliance was found.

7. The device of WLAN (2.4GHz) and Bluetooth technology can't transmit simultaneously, it was used timely shared coexistence technology.

8. The EUT incorporates a MIMO function:

MODULATION MODE	TX & RX CONFIGURATION	
802.11a	2TX	2RX
802.11n (HT20)	2TX	2RX
802.11n (HT40)	2TX	2RX
802.11ac (VHT20)	2TX	2RX
802.11ac (VHT40)	2TX	2RX
802.11ac (VHT80)	2TX	2RX
802.11ac (VHT160)	2TX	2RX
802.11ax (HE20)	2TX	2RX
802.11ax (HE40)	2TX	2RX
802.11ax (HE80)	2TX	2RX
802.11ax (HE160)	2TX	2RX
802.11ax (RU26/52/106/242/484/996/1992)	2TX	2RX

Note:

1. The EUT support Beamforming and non-beamforming mode, therefore both mode were investigated and the worst case scenario was identified. The worst case data (Beamforming mode) were presented in test report.
2. The modulation and bandwidth are similar for 802.11n mode for 20MHz (40MHz), 802.11ac mode for 20MHz (40MHz, 80MHz, 160MHz) and 802.11ax mode for 20MHz (40MHz, 80MHz, 160MHz), therefore the manufacturer will control the power for 802.11n/ac mode is the same as the 802.11ax mode or more lower than it and investigated worst case to representative mode in test report. (Final test mode refer to section 3.3.1)

9. The above EUT information is declared by manufacturer and for more detailed features description, please refers to the manufacturer's specifications or user's manual.

3.2 Description of Antenna

The antenna gain was declared by client; please refer to the following table:

Antenna Set	RF Chain No.	Brand	Model	Antenna Net Gain (dBi)	Frequency Range	Cable Loss (dB)	Antenna Type	Connector Type	Cable Length
1	Chain0/1	HONGBO	260-25094	3.53	2.4~2.4835 GHz	0.76	PIFA	i-pex(MHF 4L)	300mm
				3.06	5.15~5.25 GHz	1.16			
				3.07	5.25~5.35 GHz	1.18			
				4.81	5.47~5.725 GHz	1.2			
				4.2	5.725~5.850 GHz	1.27			
2	Chain0/1	HONGBO	260-25083	5.09	5.850~5.895 GHz	1.29	PIFA	i-pex(MHF 4L)	300mm
				5.14	5.925~6.425 GHz	1.32			
				5.09	6.425~6.525 GHz	1.35			
				5.16	6.525~6.875 GHz	1.4			
				5.12	6.875~7.125 GHz	1.45			
3	Chain0/1	HONGBO	260-25084	3.22	2.4~2.4835 GHz	0.5	Monopole	i-pex(MHF 4L)	200mm
				3.35	5.150~5.250 GHz	0.76			
				3.42	5.250~5.350 GHz	0.78			
				4.77	5.470~5.725 GHz	0.81			
				4.72	5.725~5.850 GHz	0.85			
				4.71	5.850~5.895 GHz	0.86			
				4.75	5.925~6.425 GHz	0.87			
				4.29	6.425~6.525 GHz	0.91			
				4.81	6.525~6.875 GHz	0.96			
				4.74	6.875~7.125 GHz	0.98			

Note:

1. The **Antenna Set 2** and **Antenna Set 3** were selected for the final test.
2. The above Antenna information is declared by manufacturer and for more detailed features description, please refer to the manufacturer's specifications, the laboratory shall not be held responsible.

3.3 Description of Test Modes

For U-NII-4

3 channels are provided for 802.11a, 802.11n, 802.11ac, 802.11ax (HE20):

Channel	Frequency	Channel	Frequency	Channel	Frequency
*169	5845 MHz	173	5865 MHz	177	5885 MHz

2 channels are provided for 802.11n, 802.11ac, 802.11ax (HE40):

Channel	Frequency	Channel	Frequency
*167	5835 MHz	175	5875 MHz

1 channel is provided for 802.11n, 802.11ac, 802.11ax (HE80):

Channel	Frequency
*171	5855 MHz

1 channel is provided for 802.11n, 802.11ac, 802.11ax (HE160):

Channel	Frequency
*163	5815 MHz

Note: * U-NII-3 & -4 span channels

3.3.1 Test Mode Applicability and Tested Channel Detail

EUT Configure Mode	Applicable To				Description
	UE \geq 1G	UE<1G	PLC	APCM	
-	√	√	√	√	-

Where **UE \geq 1G**: Unwanted Emission above 1GHz

UE<1G: Unwanted Emission below 1GHz

PLC: Power Line Conducted Emission

APCM: Antenna Port Conducted Measurement

Note: For RU Configuration (RU26, RU52, RU106 and RU242), the 20MHz Preamble and 40MHz Preamble had been pre-tested and the worst case was found in 20MHz Preamble.

Unwanted Emission Measurement (Above 1GHz): (Radiated with 50 ohm load & Conducted)

- Pre-Scan has been conducted to determine the worst-case mode from all possible combinations between available modulations, data rates, RU configurations and antenna ports (if EUT with antenna diversity architecture).
- Following channel(s) was (were) selected for the final test as listed below.

Mode	Available Channel	Tested Channel	Modulation Technology	Modulation Type	Data Rate Parameter	RU Configuration
802.11a	169 to 177	169, 173, 177	OFDM	BPSK	6Mb/s	
802.11ax (HE20)	169 to 177	169, 173, 177	OFDM	BPSK	MCS0	
802.11ax (HE40)	167 to 175	167, 175	OFDM	BPSK	MCS0	
802.11ax (HE80)	171	171	OFDM	BPSK	MCS0	
802.11ax (HE160)	163	163	OFDM	BPSK	MCS0	
802.11ax (RU26)	169 to 177	169, 173, 177	OFDMA	BPSK	MCS0	26/0, 26/4, 26/8
802.11ax (RU106) (only Bandedge)	169 to 177	169, 173, 177	OFDMA	BPSK	MCS0	106/53, 106/53, 106/54
802.11ax (RU242)	169 to 177	169, 173, 177	OFDMA	BPSK	MCS0	242/61
802.11ax (RU484)	167 to 175	167, 175	OFDMA	BPSK	MCS0	484/65
802.11ax (RU996)	171	171	OFDMA	BPSK	MCS0	996/67
802.11ax (RU1992)	163	163	OFDMA	BPSK	MCS0	1992/68

Note: For conducted measurement test result over the limit line, the emission was verified by radiated with antenna and the test result was passed by radiated measurement. (Please refer Appendix A)

Unwanted Emission Measurement (Above 1GHz): (Radiated with antenna)

- Following channel(s) was (were) selected for the final test as listed below.

Mode	Available Channel	Tested Channel	Modulation Technology	Modulation Type	Data Rate Parameter	RU Configuration
802.11ax (HE20)	169 to 177	177	OFDM	BPSK	MCS0	
802.11ax (HE40)	167 to 175	175	OFDM	BPSK	MCS0	
802.11ax (HE160)	163	163	OFDM	BPSK	MCS0	
802.11ax (RU106) (only Bandedge)	169 to 177	177	OFDMA	BPSK	MCS0	106/54
802.11ax (RU242)	169 to 177	177	OFDMA	BPSK	MCS0	242/61
802.11ax (RU996)	171	171	OFDMA	BPSK	MCS0	996/67
802.11ax (RU1992)	163	163	OFDMA	BPSK	MCS0	1992/68

Unwanted Emission Measurement (Below 1GHz): (Radiated with 50 ohm load & Conducted)

- Pre-Scan has been conducted to determine the worst-case mode from all possible combinations between available modulations, data rates, RU configurations and antenna ports (if EUT with antenna diversity architecture).
- Following channel(s) was (were) selected for the final test as listed below.

Mode	Available Channel	Tested Channel	Modulation Technology	Modulation Type	Data Rate Parameter
802.11ax (HE40)	167 to 175	175	OFDM	BPSK	MCS0

Power Line Conducted Emission Measurement:

- Pre-Scan has been conducted to determine the worst-case mode from all possible combinations between available modulations, data rates, RU configurations and antenna ports (if EUT with antenna diversity architecture).
- Following channel(s) was (were) selected for the final test as listed below.

Mode	Available Channel	Tested Channel	Modulation Technology	Modulation Type	Data Rate Parameter
802.11ax (HE40)	167 to 175	175	OFDM	BPSK	MCS0

Antenna Port Conducted Measurement:

- This item includes all test value of each mode, but only includes spectrum plot of worst value of each mode.
- Pre-Scan has been conducted to determine the worst-case mode from all possible combinations between available modulations, data rates, RU configurations and antenna ports (if EUT with antenna diversity architecture).
- Following channel(s) was (were) selected for the final test as listed below.

Mode	Available Channel	Tested Channel	Modulation Technology	Modulation Type	Data Rate Parameter	RU Configuration
802.11a	169 to 177	169, 173, 177	OFDM	BPSK	6Mb/s	-
802.11ac (VHT20) (output power only)	169 to 177	169, 173, 177	OFDM	BPSK	MCS0	-
802.11ac (VHT40) (output power only)	167 to 175	167, 175	OFDM	BPSK	MCS0	-
802.11ac (VHT80) (output power only)	171	171	OFDM	BPSK	MCS0	-
802.11ac (VHT160) (output power only)	163	163	OFDM	BPSK	MCS0	-
802.11ax (HE20)	169 to 177	169, 173, 177	OFDM	BPSK	MCS0	-
802.11ax (HE40)	167 to 175	167, 175	OFDM	BPSK	MCS0	-
802.11ax (HE80)	171	171	OFDM	BPSK	MCS0	-
802.11ax (HE160)	163	163	OFDM	BPSK	MCS0	-
802.11ax (RU26)	169 to 177	169, 173, 177	OFDMA	BPSK	MCS0	26/0, 26/4, 26/8
802.11ax (RU52)	169 to 177	169, 173, 177	OFDMA	BPSK	MCS0	52/37, 52/38, 52/40
802.11ax (RU106)	169 to 177	169, 173, 177	OFDMA	BPSK	MCS0	106/53, 106/53, 106/54
802.11ax (RU242)	169 to 177	169, 173, 177	OFDMA	BPSK	MCS0	242/61
802.11ax (RU484)	167 to 175	167, 175	OFDMA	BPSK	MCS0	484/65
802.11ax (RU996)	171	171	OFDMA	BPSK	MCS0	996/67
802.11ax (RU1992)	163	163	OFDMA	BPSK	MCS0	1992/68

Test Condition:

Applicable To	Environmental Conditions	Input Power (System)	Tested By
UE \geq 1G	25deg. C, 65%RH	120Vac, 60Hz	Tom Yang, Carter Lin
UE<1G	24deg. C, 65%RH	120Vac, 60Hz	Tom Yang
PLC	25deg. C, 69%RH	120Vac, 60Hz	Tom Yang
APCM	32~33deg. C, 57~58%RH	120Vac, 60Hz	Eric Peng

3.4 Duty Cycle of Test Signal

Duty cycle of test signal is $\geq 98\%$, duty factor is not required.

- 802.11a: Duty cycle = 1.975 ms/1.996 ms = 0.989
- 802.11ax (HE20): Duty cycle = 5.344 ms/5.371 ms = 0.995
- 802.11ax (HE40): Duty cycle = 5.413 ms/5.436 ms = 0.996
- 802.11ax (HE80): Duty cycle = 3.494 ms/3.514 ms = 0.994
- 802.11ax (HE160): Duty cycle = 2.156 ms/2.191 ms = 0.984
- 802.11ax (RU26): Duty cycle = 5.083 ms/5.105 ms = 0.996
- 802.11ax (RU52): Duty cycle = 5.072 ms/5.092 ms = 0.996
- 802.11ax (RU106): Duty cycle = 4.765 ms/4.792 ms = 0.994
- 802.11ax (RU242): Duty cycle = 4.665 ms/4.685 ms = 0.996
- 802.11ax (RU484): Duty cycle = 4.661 ms/4.681 ms = 0.996
- 802.11ax (RU996): Duty cycle = 1.626 ms/1.644 ms = 0.989
- 802.11ax (RU1992): Duty cycle = 2.152 ms/2.174 ms = 0.99

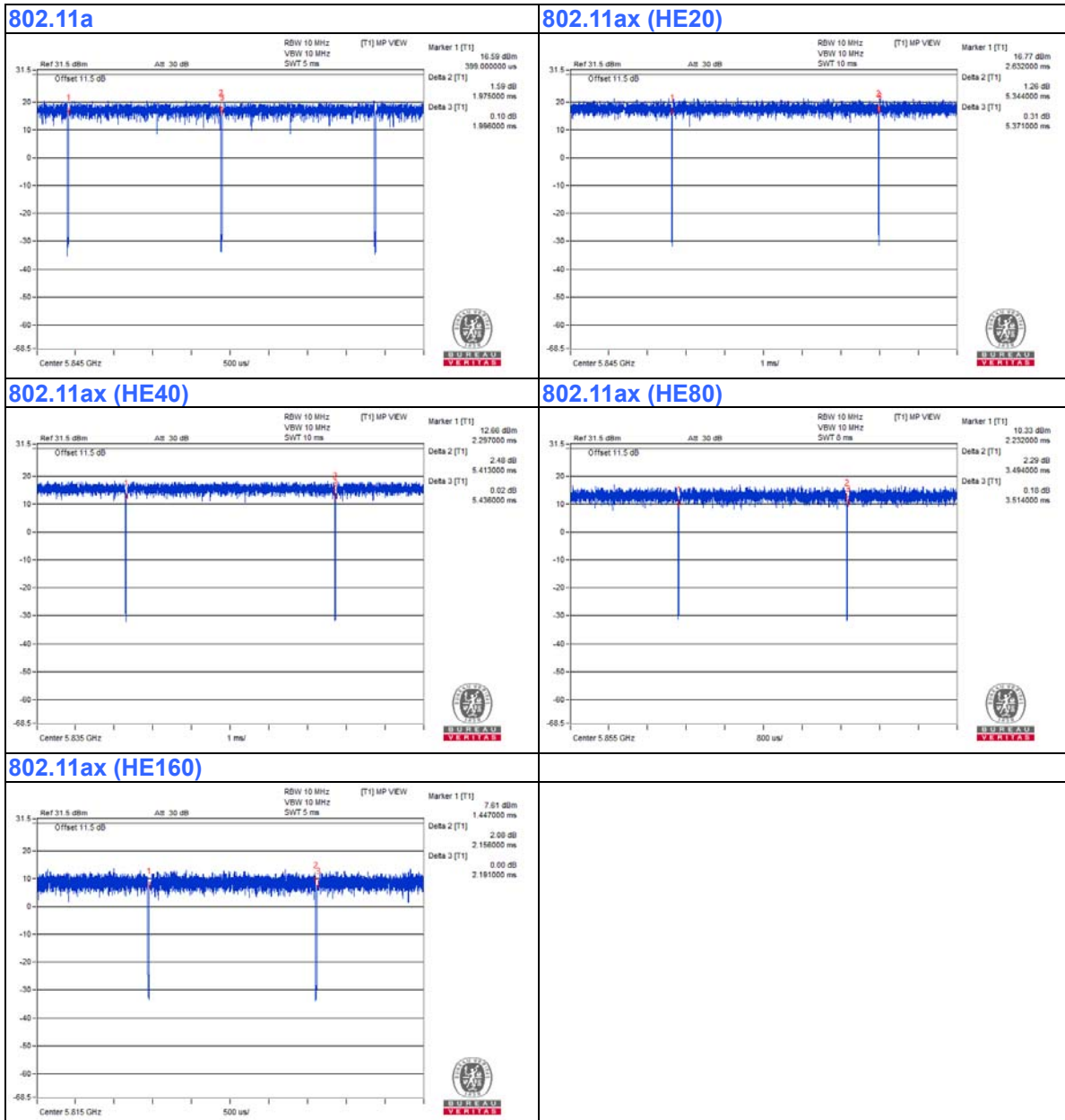

802.11ax (RU26)

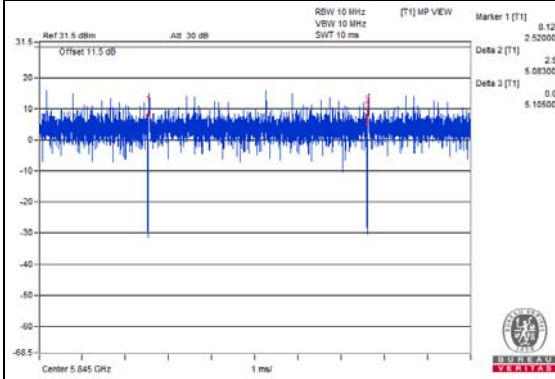

802.11ax (RU52)

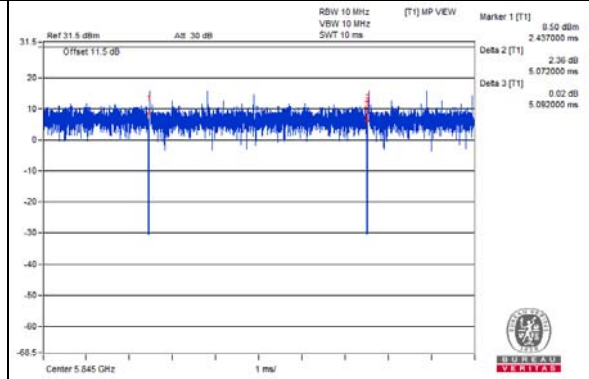

802.11ax (RU106)

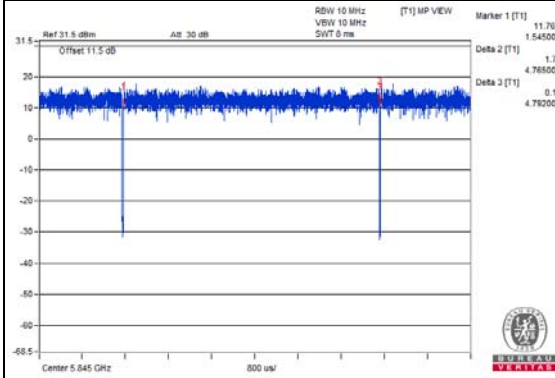

802.11ax (RU242)

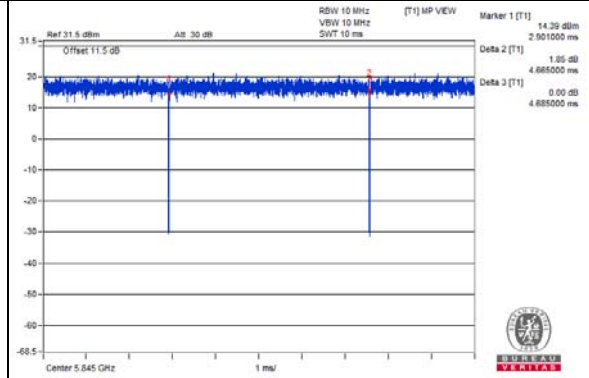

802.11ax (RU484)

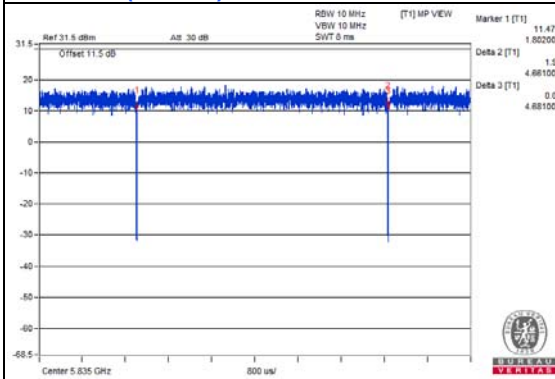

802.11ax (RU996)

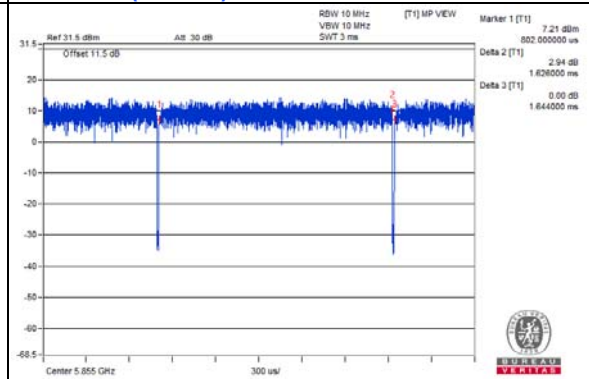

802.11ax (RU1992)

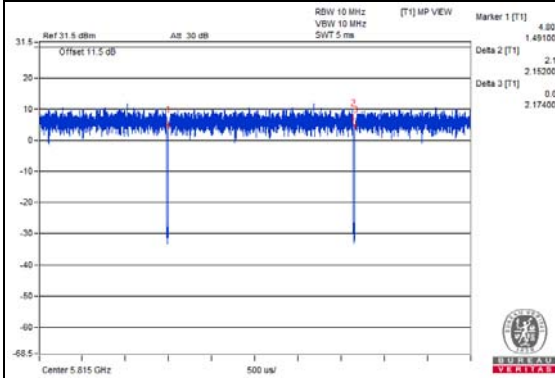

3.5 Description of Support Units

The EUT has been tested as an independent unit together with other necessary accessories or support units. The following support units or accessories were used to form a representative test configuration during the tests.

ID	Product	Brand	Model No.	Serial No.	FCC ID	Remarks
A.	Laptop	Dell	E5420	6FGHKV1	NA	Provided by Lab
B.	Test Tool	Qualcomm	Y6570	NA	NA	Supplied by client
C.	Adapter	PHIHONG	PSAA12A-120L6	NA	NA	Supplied by client

Note:

1. All power cords of the above support units are non-shielded (1.8m).

ID	Descriptions	Qty.	Length (m)	Shielding (Yes/No)	Cores (Qty.)	Remarks
1.	DC Cable	1	1.2	No	0	Supplied by client
2.	USB Cable	1	0.6	Yes	0	Provided by Lab

3.5.1 Configuration of System under Test

For Conducted Emissions test:

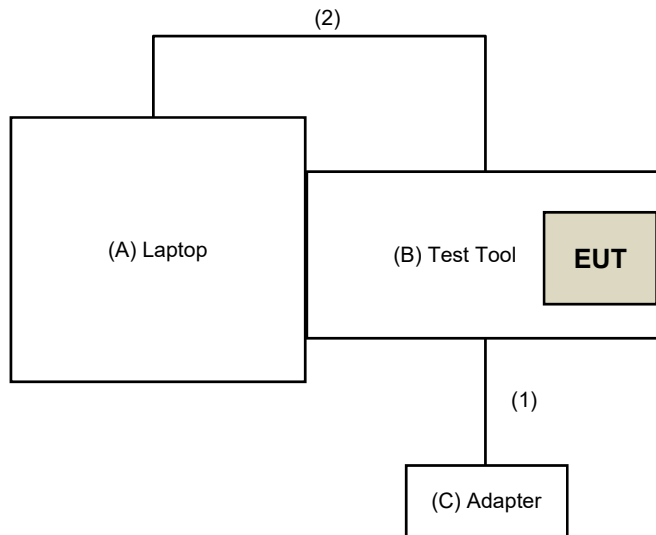

For other test:

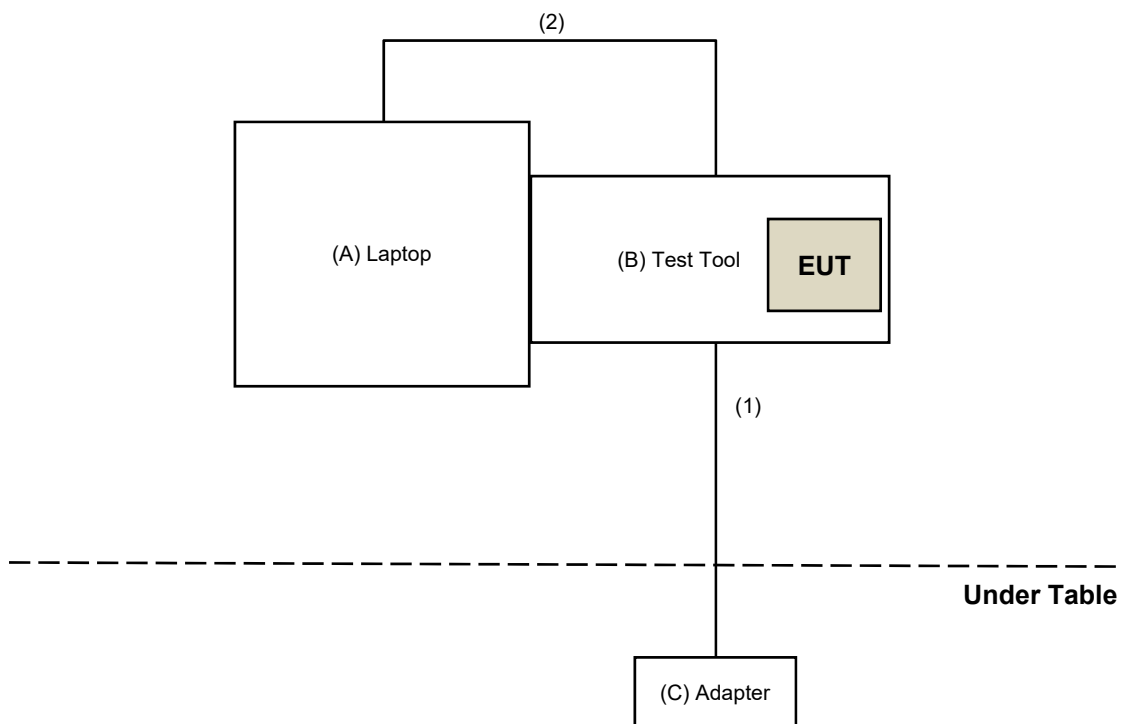

3.6 General Description of Applied Standards and References

The EUT is a RF Product. According to the specifications of the manufacturer, it must comply with the requirements of the following standards and references:

Test Standard:

FCC Part 15, Subpart E (15.407)

ANSI C63.10-2013

All test items have been performed and recorded as per the above standards.

References Test Guidance:

KDB 291074 D02 EMC Measurement v01

KDB 789033 D02 General UNII Test Procedure New Rules v02r01

KDB 662911 D01 Multiple Transmitter Output v02r01

All test items have been performed as a reference to the above KDB test guidance.

4 Test Types and Results

4.1 Unwanted Emission and Bandedge Measurement

4.1.1 Limits of Unwanted Emission and Bandedge Measurement

Unwanted emissions which fall in the restricted bands must comply with the radiated emission limits specified as below table.

Frequencies (MHz)	Field Strength (microvolts/meter)	Measurement Distance (meters)
0.009 ~ 0.490	2400/F(kHz)	300
0.490 ~ 1.705	24000/F(kHz)	30
1.705 ~ 30.0	30	30
30 ~ 88	100	3
88 ~ 216	150	3
216 ~ 960	200	3
Above 960	500	3

NOTE:

1. The lower limit shall apply at the transition frequencies.
2. Emission level (dBuV/m) = 20 log Emission level (uV/m).
3. For frequencies above 1000MHz, the field strength limits are based on average detector, however, the peak field strength of any emission shall not exceed the maximum permitted average limits, specified above by more than 20dB under any condition of modulation.

Limits of unwanted emission out of the restricted bands

- (i) For an indoor access point or subordinate device, all emissions at or above 5.895 GHz shall not exceed an e.i.r.p. of 15 dBm/MHz and shall decrease linearly to an e.i.r.p. of -7 dBm/MHz at or above 5.925 GHz.
- (ii) For a client device, all emissions at or above 5.895 GHz shall not exceed an e.i.r.p. of -5 dBm/MHz and shall decrease linearly to an e.i.r.p. of -27 dBm/MHz at or above 5.925 GHz.
- (iii) For a client device or indoor access point or subordinate device, all emissions below 5.725 GHz shall not exceed an e.i.r.p. of -27 dBm/MHz at 5.65 GHz increasing linearly to 10 dBm/MHz at 5.7 GHz, and from 5.7 GHz increasing linearly to a level of 15.6 dBm/MHz at 5.72 GHz, and from 5.72 GHz increasing linearly to a level of 27 dBm/MHz at 5.725 GHz.

Note:

The following formula is used to convert the equipment isotropic radiated power (eirp) to field strength:

$$E = \frac{1000000\sqrt{30P}}{3} \mu\text{V/m, where } P \text{ is the eirp (Watts).}$$

4.1.2 Test Instruments

For Radiated Emission & Bandedge test:

DESCRIPTION & MANUFACTURER	MODEL NO.	SERIAL NO.	CALIBRATED DATE	CALIBRATED UNTIL
Test Receiver Agilent	N9038A	MY51210202	Dec. 01, 2020	Nov. 30, 2021
Pre-Amplifier EMCI	EMC001340	980142	May 24, 2021	May 23, 2022
Loop Antenna Electro-Metrics	EM-6879	264	Mar. 05, 2021	Mar. 04, 2022
RF Cable	5D-FB	LOOPCAB-001	Jan. 07, 2021	Jan. 06, 2022
RF Cable	5D-FB	LOOPCAB-002	Jan. 07, 2021	Jan. 06, 2022
Pre-Amplifier EMCI	EMC330N	980701	Mar. 10, 2021	Mar. 09, 2022
Trilog Broadband Antenna SCHWARZBECK	VULB 9168	9168-406	Nov. 06, 2020	Nov. 05, 2021
RF Cable	8D	966-4-1	Mar. 17, 2021	Mar. 16, 2022
RF Cable	8D	966-4-2	Mar. 17, 2021	Mar. 16, 2022
RF Cable	8D	966-4-3	Mar. 17, 2021	Mar. 16, 2022
Fixed attenuator Mini-Circuits	UNAT-5+	PAD-ATT5-03	Jan. 11, 2021	Jan. 10, 2022
Horn_Antenna SCHWARZBECK	BBHA 9120D	9120D-783	Nov. 22, 2020	Nov. 21, 2021
Pre-Amplifier EMCI	EMC 12630 SE	980638	Apr. 07, 2021	Apr. 06, 2022
RF Cable	EMC104-SM-SM-1200	160922	Dec. 25, 2020	Dec. 24, 2021
RF Cable	EMC104-SM-SM-2000	180502	Apr. 26, 2021	Apr. 25, 2022
RF Cable	EMC104-SM-SM-6000	180418	Apr. 26, 2021	Apr. 25, 2022
Pre-Amplifier EMCI	EMC184045SE	980387	Jan. 11, 2021	Jan. 10, 2022
Horn_Antenna SCHWARZBECK	BBHA 9170	BBHA9170519	Nov. 22, 2020	Nov. 21, 2021
RF Cable	EMC102-KM-KM-1200	160924	Jan. 11, 2021	Jan. 10, 2022
RF Cable	EMC-KM-KM-4000	200214	Mar. 10, 2021	Mar. 09, 2022
Software	ADT_Radiated_V8.7.08	NA	NA	NA
Boresight Antenna Tower & Turn Table Max-Full	MF-7802BS	MF780208530	NA	NA

Note:

1. The calibration interval of the above test instruments is 12 months and the calibrations are traceable to NML/ROC and NIST/USA.
2. The test was performed in 966 Chamber No. 4.
3. Tested Date: July 31 to Aug. 06, 2021

For other test items:

DESCRIPTION & MANUFACTURER	MODEL NO.	SERIAL NO.	CALIBRATED DATE	CALIBRATED UNTIL
Spectrum Analyzer R&S	FSV40	101516	Mar. 08, 2021	Mar. 07, 2022
Power meter Anritsu	ML2495A	1529002	June 21, 2021	June 20, 2022
Power sensor Anritsu	MA2411B	1339443	May 31, 2021	May 30, 2022
10dB Attenuator Woken	MDCS18N-10	MDCS18N-10-01	Apr. 13, 2021	Apr. 12, 2022
DC Power Supply Topward	6603D	795558	NA	NA
Temperature & Humidity Chamber Giant Force	GTH-150-40-SP-AR	MAA0812-008	Jan. 14, 2021	Jan. 13, 2022
True RMS Clamp Meter FLUKE	325	31130711WS	June 02, 2021	June 01, 2022
Software	ADT_RF Test Software V6.6.5.4	NA	NA	NA

- NOTE:**
1. The test was performed in Oven room 2.
 2. The calibration interval of the above test instruments is 12 months and the calibrations are traceable to NML/ROC and NIST/USA.
 3. Tested Date: Sep. 24, 2021

4.1.3 Test Procedure

Following FCC KDB 789033 D02 General UNII Test Procedures:

Radiated versus Conducted Measurements.

The unwanted emission limits in both the restricted and non-restricted bands are based on antenna-port conducted measurements in conjunction with cabinet emissions tests are permitted to demonstrate compliance.

The following steps was performed:

- a. Cabinet emissions measurements. Radiated measurement was performed to ensure that cabinet emissions are below the emission limits. For the cabinet-emission measurements the antenna was replaced by a termination matching the nominal impedance of the antenna.
- b. Conducted tests was performed using equipment that matches the nominal impedance of the antenna assembly used with the EUT.
- c. EIRP calculation. A value representative of an upper bound on out-of-band antenna gain (in dBi) shall be added to the measured antenna-port conducted emission power to compute EIRP within the specified measurement bandwidth. (For emissions in the restricted bands, additional calculations are required to convert EIRP to field strength at the specified distance.) The upper bound on antenna gain for a device with a single RF output shall be selected as the maximum in-band gain of the antenna across all operating bands or 2 dBi, whichever is greater.
- d. EIRP adjustments for multiple outputs. (Follow the procedures specified in FCC KDB Publication 662911)
- e. For all of Radiation emission test

For Radiated emission below 30MHz

- e-1.1. The EUT was placed on the top of a rotating table 0.8 meters above the ground at a 3 meter chamber room. The table was rotated 360 degrees to determine the position of the highest radiation.
- e-1.2. The EUT was set 3 meters away from the interference-receiving antenna, which was mounted on the top of a variable-height antenna tower.
- e-1.3. Parallel, perpendicular, and ground-parallel orientations of the antenna are set to make the measurement.
- e-1.4. For each suspected emission, the EUT was arranged to its worst case and the rotatable table was turned from 0 degrees to 360 degrees to find the maximum reading.
- e-1.5. The test-receiver system was set to Quasi-Peak Detect Function and Specified Bandwidth with Maximum Hold Mode.

Note:

1. The resolution bandwidth and video bandwidth of test receiver/spectrum analyzer is 9kHz at frequency below 30MHz.
2. KDB 414788 OATS and Chamber Correlation Justification
 - Based on FCC 15.31(f)(2) : measurements may be performed at a distance closer than that specified in the regulations; however, an attempts should be made to avoid making measurements in the near field.
 - OATs and chamber correlation testing had been performed and chamber measured test result is the worst case test result.

For Radiated emission above 30MHz

- e-2.1. The EUT was placed on the top of a rotating table 0.8 meters (for 30MHz ~ 1GHz) / 1.5 meters (for above 1GHz) above the ground at 3 meter chamber room for test. The table was rotated 360 degrees to determine the position of the highest radiation.
- e-2.2. The EUT was set 3 meters away from the interference-receiving antenna, which was mounted on the top of a variable-height antenna tower.
- e-2.3. The height of antenna is varied from one meter to four meters above the ground to determine the maximum value of the field strength. Both horizontal and vertical polarizations of the antenna are set to make the measurement.
- e-2.4. For each suspected emission, the EUT was arranged to its worst case and then the antenna was tuned to heights from 1 meter to 4 meters and the rotatable table was turned from 0 degrees to 360 degrees to find the maximum reading.
- e-2.5. The test-receiver system was set to quasi-peak detect function and specified bandwidth with maximum hold mode when the test frequency is below 1 GHz.
- e-2.6. The test-receiver system was set to peak and average detects function and specified bandwidth with maximum hold mode when the test frequency is above 1 GHz. If the peak reading value also meets average limit, measurement with the average detector is unnecessary.

Note:

1. The resolution bandwidth and video bandwidth of test receiver/spectrum analyzer is 120kHz for Quasi-peak detection (QP) at frequency below 1GHz.
2. The resolution bandwidth of test receiver/spectrum analyzer is 1 MHz and the video bandwidth is 3 MHz for Peak detection (PK) at frequency above 1GHz.
3. The resolution bandwidth of test receiver/spectrum analyzer is 1MHz and the video bandwidth is $\geq 1/T$ (Duty cycle < 98%) or 10Hz (Duty cycle $\geq 98\%$) for Average detection (AV) at frequency above 1GHz.
4. All modes of operation were investigated and the worst-case emissions are reported.

4.1.4 Test Setup

**For radiated configuration:
For Radiated emission below 30MHz**

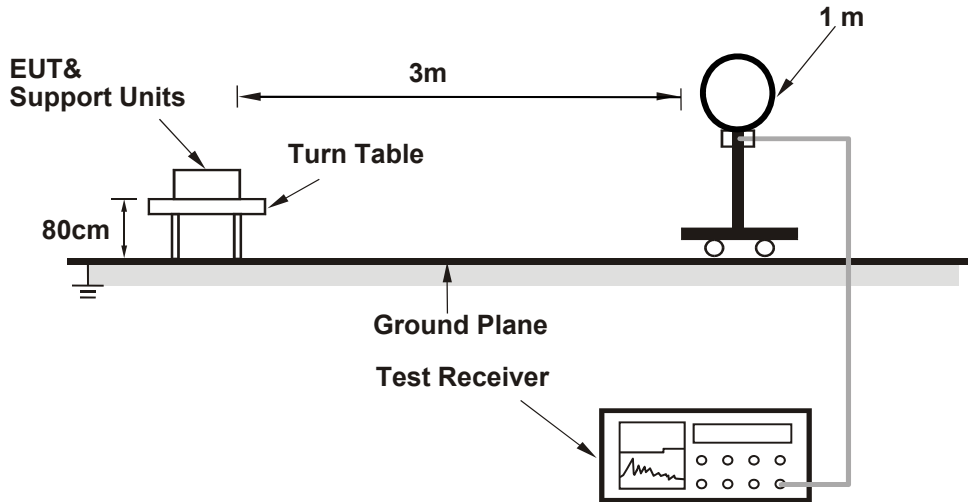

For Radiated emission 30MHz to 1GHz

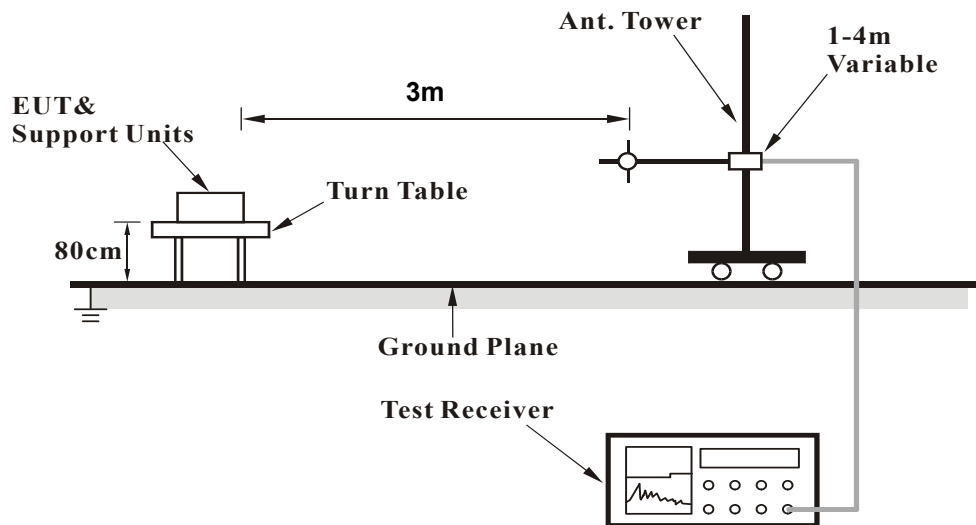

For Radiated emission above 1GHz

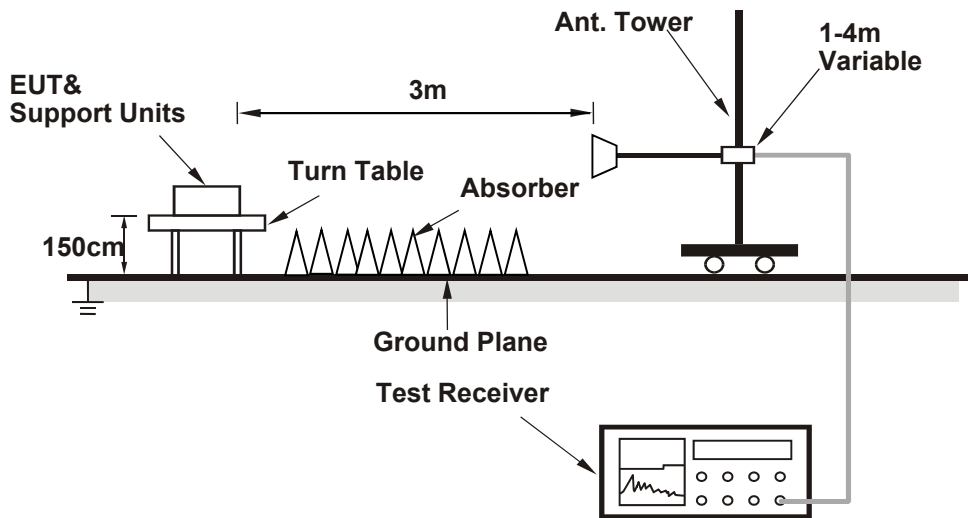

For the actual test configuration, please refer to the attached file (Test Setup Photo).

For conducted configuration:

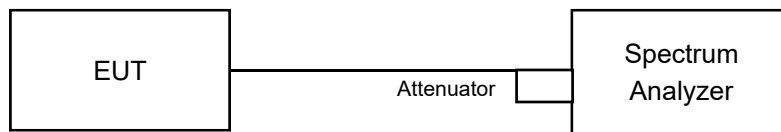

4.1.5 EUT Operating Condition

- a. Placed the EUT on the testing table.
- b. Controlling software (QRCT 4.0.00177.0) has been activated to set the EUT under transmission condition continuously at specific channel frequency.

4.1.6 Test Results (Radiated Measurement)

Radiated versus Conducted Measurement	
<input type="checkbox"/> Conducted measurement	<input checked="" type="checkbox"/> Radiated measurement
<p><u>For Radiated measurement:</u> The level of unwanted emissions was measured when radiated by the cabinet or structure of the equipment with the antenna connector(s) terminated by a specified load (cabinet radiation)</p> <p><u>For Conducted measurement:</u> The level of unwanted emissions was measured as their power in a specified load (conducted spurious emissions).</p>	

Radiated test with 50ohm terminator on antenna port.

Above 1GHz Data:

RF Mode	TX 802.11a 5.9G	Channel	CH 169 : 5845 MHz
Frequency Range	1GHz ~ 40GHz	Detector Function	Peak (PK) Average (AV)

Antenna Polarity & Test Distance : Horizontal at 3 m

No	Frequency (MHz)	Emission Level (dBuV/m)	Limit (dBuV/m)	Margin (dB)	Antenna Height (m)	Table Angle (Degree)	Raw Value (dBuV)	Correction Factor (dB/m)
1	11690.00	48.8 PK	74.0	-25.2	1.63 H	215	37.3	11.5
2	11690.00	37.9 AV	54.0	-16.1	1.63 H	215	26.4	11.5
3	#17535.00	51.9 PK	88.2	-36.3	2.13 H	168	33.5	18.4
4	#17535.00	39.7 AV	68.2	-28.5	2.13 H	168	21.3	18.4

Antenna Polarity & Test Distance : Vertical at 3 m

No	Frequency (MHz)	Emission Level (dBuV/m)	Limit (dBuV/m)	Margin (dB)	Antenna Height (m)	Table Angle (Degree)	Raw Value (dBuV)	Correction Factor (dB/m)
1	11690.00	51.4 PK	74.0	-22.6	3.17 V	283	39.9	11.5
2	11690.00	40.6 AV	54.0	-13.4	3.17 V	283	29.1	11.5
3	#17535.00	49.2 PK	88.2	-39.0	2.45 V	170	30.8	18.4
4	#17535.00	38.3 AV	68.2	-29.9	2.45 V	170	19.9	18.4

Remarks:

1. Emission Level(dBuV/m) = Raw Value(dBuV) + Correction Factor(dB/m)
2. Correction Factor(dB/m) = Antenna Factor(dB/m) + Cable Factor(dB) – Pre-Amplifier Factor(dB)
3. Margin value = Emission Level – Limit value
4. The other emission levels were very low against the limit.
5. " # ": The radiated frequency is out of the restricted band.

RF Mode	TX 802.11a 5.9G	Channel	CH 173 : 5865 MHz
Frequency Range	1GHz ~ 40GHz	Detector Function	Peak (PK) Average (AV)

Antenna Polarity & Test Distance : Horizontal at 3 m

No	Frequency (MHz)	Emission Level (dBuV/m)	Limit (dBuV/m)	Margin (dB)	Antenna Height (m)	Table Angle (Degree)	Raw Value (dBuV)	Correction Factor (dB/m)
1	11730.00	48.5 PK	74.0	-25.5	1.64 H	210	37.0	11.5
2	11730.00	37.5 AV	54.0	-16.5	1.64 H	210	26.0	11.5
3	#17595.00	51.8 PK	88.2	-36.4	2.17 H	164	33.0	18.8
4	#17595.00	39.5 AV	68.2	-28.7	2.17 H	164	20.7	18.8

Antenna Polarity & Test Distance : Vertical at 3 m

No	Frequency (MHz)	Emission Level (dBuV/m)	Limit (dBuV/m)	Margin (dB)	Antenna Height (m)	Table Angle (Degree)	Raw Value (dBuV)	Correction Factor (dB/m)
1	11730.00	51.2 PK	74.0	-22.8	3.11 V	286	39.7	11.5
2	11730.00	40.6 AV	54.0	-13.4	3.11 V	286	29.1	11.5
3	#17595.00	49.6 PK	88.2	-38.6	2.42 V	188	30.8	18.8
4	#17595.00	38.6 AV	68.2	-29.6	2.42 V	188	19.8	18.8

Remarks:

1. Emission Level(dBuV/m) = Raw Value(dBuV) + Correction Factor(dB/m)
2. Correction Factor(dB/m) = Antenna Factor(dB/m) + Cable Factor(dB) – Pre-Amplifier Factor(dB)
3. Margin value = Emission Level – Limit value
4. The other emission levels were very low against the limit.
5. "#": The radiated frequency is out of the restricted band.

RF Mode	TX 802.11a 5.9G	Channel	CH 177 : 5885 MHz
Frequency Range	1GHz ~ 40GHz	Detector Function	Peak (PK) Average (AV)

Antenna Polarity & Test Distance : Horizontal at 3 m

No	Frequency (MHz)	Emission Level (dBuV/m)	Limit (dBuV/m)	Margin (dB)	Antenna Height (m)	Table Angle (Degree)	Raw Value (dBuV)	Correction Factor (dB/m)
1	11770.00	49.4 PK	74.0	-24.6	1.60 H	227	38.1	11.3
2	11770.00	38.3 AV	54.0	-15.7	1.60 H	227	27.0	11.3
3	#17655.00	51.5 PK	88.2	-36.7	2.10 H	155	32.7	18.8
4	#17655.00	39.5 AV	68.2	-28.7	2.10 H	155	20.7	18.8

Antenna Polarity & Test Distance : Vertical at 3 m

No	Frequency (MHz)	Emission Level (dBuV/m)	Limit (dBuV/m)	Margin (dB)	Antenna Height (m)	Table Angle (Degree)	Raw Value (dBuV)	Correction Factor (dB/m)
1	11770.00	51.4 PK	74.0	-22.6	3.13 V	282	40.1	11.3
2	11770.00	40.9 AV	54.0	-13.1	3.13 V	282	29.6	11.3
3	#17655.00	49.1 PK	88.2	-39.1	2.36 V	181	30.3	18.8
4	#17655.00	38.3 AV	68.2	-29.9	2.36 V	181	19.5	18.8

Remarks:

1. Emission Level(dBuV/m) = Raw Value(dBuV) + Correction Factor(dB/m)
2. Correction Factor(dB/m) = Antenna Factor(dB/m) + Cable Factor(dB) – Pre-Amplifier Factor(dB)
3. Margin value = Emission Level – Limit value
4. The other emission levels were very low against the limit.
5. "#": The radiated frequency is out of the restricted band.

RF Mode	TX 802.11ax (HE20)	Channel	CH 169 : 5845 MHz
Frequency Range	1GHz ~ 40GHz	Detector Function	Peak (PK) Average (AV)

Antenna Polarity & Test Distance : Horizontal at 3 m

No	Frequency (MHz)	Emission Level (dBuV/m)	Limit (dBuV/m)	Margin (dB)	Antenna Height (m)	Table Angle (Degree)	Raw Value (dBuV)	Correction Factor (dB/m)
1	11690.00	48.8 PK	74.0	-25.2	1.59 H	210	37.3	11.5
2	11690.00	38.1 AV	54.0	-15.9	1.59 H	210	26.6	11.5
3	#17535.00	51.5 PK	88.2	-36.7	2.14 H	164	33.1	18.4
4	#17535.00	39.6 AV	68.2	-28.6	2.14 H	164	21.2	18.4

Antenna Polarity & Test Distance : Vertical at 3 m

No	Frequency (MHz)	Emission Level (dBuV/m)	Limit (dBuV/m)	Margin (dB)	Antenna Height (m)	Table Angle (Degree)	Raw Value (dBuV)	Correction Factor (dB/m)
1	11690.00	51.1 PK	74.0	-22.9	3.09 V	291	39.6	11.5
2	11690.00	40.6 AV	54.0	-13.4	3.09 V	291	29.1	11.5
3	#17535.00	49.6 PK	88.2	-38.6	2.45 V	177	31.2	18.4
4	#17535.00	38.9 AV	68.2	-29.3	2.45 V	177	20.5	18.4

Remarks:

1. Emission Level(dBuV/m) = Raw Value(dBuV) + Correction Factor(dB/m)
2. Correction Factor(dB/m) = Antenna Factor(dB/m) + Cable Factor(dB) – Pre-Amplifier Factor(dB)
3. Margin value = Emission Level – Limit value
4. The other emission levels were very low against the limit.
5. "#": The radiated frequency is out of the restricted band.

RF Mode	TX 802.11ax (HE20)	Channel	CH 173 : 5865 MHz
Frequency Range	1GHz ~ 40GHz	Detector Function	Peak (PK) Average (AV)

Antenna Polarity & Test Distance : Horizontal at 3 m

No	Frequency (MHz)	Emission Level (dBuV/m)	Limit (dBuV/m)	Margin (dB)	Antenna Height (m)	Table Angle (Degree)	Raw Value (dBuV)	Correction Factor (dB/m)
1	11730.00	49.0 PK	74.0	-25.0	1.61 H	202	37.5	11.5
2	11730.00	38.3 AV	54.0	-15.7	1.61 H	202	26.8	11.5
3	#17595.00	52.1 PK	88.2	-36.1	2.16 H	171	33.3	18.8
4	#17595.00	40.0 AV	68.2	-28.2	2.16 H	171	21.2	18.8

Antenna Polarity & Test Distance : Vertical at 3 m

No	Frequency (MHz)	Emission Level (dBuV/m)	Limit (dBuV/m)	Margin (dB)	Antenna Height (m)	Table Angle (Degree)	Raw Value (dBuV)	Correction Factor (dB/m)
1	11730.00	51.4 PK	74.0	-22.6	3.15 V	278	39.9	11.5
2	11730.00	40.9 AV	54.0	-13.1	3.15 V	278	29.4	11.5
3	#17595.00	49.9 PK	88.2	-38.3	2.39 V	159	31.1	18.8
4	#17595.00	39.1 AV	68.2	-29.1	2.39 V	159	20.3	18.8

Remarks:

1. Emission Level(dBuV/m) = Raw Value(dBuV) + Correction Factor(dB/m)
2. Correction Factor(dB/m) = Antenna Factor(dB/m) + Cable Factor(dB) – Pre-Amplifier Factor(dB)
3. Margin value = Emission Level – Limit value
4. The other emission levels were very low against the limit.
5. "#": The radiated frequency is out of the restricted band.

RF Mode	TX 802.11ax (HE20)	Channel	CH 177 : 5885 MHz
Frequency Range	1GHz ~ 40GHz	Detector Function	Peak (PK) Average (AV)

Antenna Polarity & Test Distance : Horizontal at 3 m

No	Frequency (MHz)	Emission Level (dBuV/m)	Limit (dBuV/m)	Margin (dB)	Antenna Height (m)	Table Angle (Degree)	Raw Value (dBuV)	Correction Factor (dB/m)
1	11770.00	48.7 PK	74.0	-25.3	1.57 H	209	37.4	11.3
2	11770.00	37.6 AV	54.0	-16.4	1.57 H	209	26.3	11.3
3	#17655.00	51.7 PK	88.2	-36.5	2.15 H	178	32.9	18.8
4	#17655.00	39.6 AV	68.2	-28.6	2.15 H	178	20.8	18.8

Antenna Polarity & Test Distance : Vertical at 3 m

No	Frequency (MHz)	Emission Level (dBuV/m)	Limit (dBuV/m)	Margin (dB)	Antenna Height (m)	Table Angle (Degree)	Raw Value (dBuV)	Correction Factor (dB/m)
1	11770.00	51.5 PK	74.0	-22.5	3.19 V	294	40.2	11.3
2	11770.00	41.0 AV	54.0	-13.0	3.19 V	294	29.7	11.3
3	#17655.00	49.0 PK	88.2	-39.2	2.39 V	161	30.2	18.8
4	#17655.00	38.3 AV	68.2	-29.9	2.39 V	161	19.5	18.8

Remarks:

1. Emission Level(dBuV/m) = Raw Value(dBuV) + Correction Factor(dB/m)
2. Correction Factor(dB/m) = Antenna Factor(dB/m) + Cable Factor(dB) – Pre-Amplifier Factor(dB)
3. Margin value = Emission Level – Limit value
4. The other emission levels were very low against the limit.
5. " # ": The radiated frequency is out of the restricted band.

RF Mode	TX 802.11ax (HE40)	Channel	CH 167 : 5835 MHz
Frequency Range	1GHz ~ 40GHz	Detector Function	Peak (PK) Average (AV)

Antenna Polarity & Test Distance : Horizontal at 3 m

No	Frequency (MHz)	Emission Level (dBuV/m)	Limit (dBuV/m)	Margin (dB)	Antenna Height (m)	Table Angle (Degree)	Raw Value (dBuV)	Correction Factor (dB/m)
1	11670.00	48.7 PK	74.0	-25.3	1.67 H	223	37.1	11.6
2	11670.00	37.8 AV	54.0	-16.2	1.67 H	223	26.2	11.6
3	#17505.00	51.7 PK	88.2	-36.5	2.18 H	162	33.5	18.2
4	#17505.00	39.8 AV	68.2	-28.4	2.18 H	162	21.6	18.2

Antenna Polarity & Test Distance : Vertical at 3 m

No	Frequency (MHz)	Emission Level (dBuV/m)	Limit (dBuV/m)	Margin (dB)	Antenna Height (m)	Table Angle (Degree)	Raw Value (dBuV)	Correction Factor (dB/m)
1	11670.00	51.4 PK	74.0	-22.6	3.13 V	303	39.8	11.6
2	11670.00	40.7 AV	54.0	-13.3	3.13 V	303	29.1	11.6
3	#17505.00	48.9 PK	88.2	-39.3	2.39 V	186	30.7	18.2
4	#17505.00	38.3 AV	68.2	-29.9	2.39 V	186	20.1	18.2

Remarks:

1. Emission Level(dBuV/m) = Raw Value(dBuV) + Correction Factor(dB/m)
2. Correction Factor(dB/m) = Antenna Factor(dB/m) + Cable Factor(dB) – Pre-Amplifier Factor(dB)
3. Margin value = Emission Level – Limit value
4. The other emission levels were very low against the limit.
5. "#": The radiated frequency is out of the restricted band.

RF Mode	TX 802.11ax (HE40)	Channel	CH 175 : 5875 MHz
Frequency Range	1GHz ~ 40GHz	Detector Function	Peak (PK) Average (AV)

Antenna Polarity & Test Distance : Horizontal at 3 m

No	Frequency (MHz)	Emission Level (dBuV/m)	Limit (dBuV/m)	Margin (dB)	Antenna Height (m)	Table Angle (Degree)	Raw Value (dBuV)	Correction Factor (dB/m)
1	11750.00	49.0 PK	74.0	-25.0	1.63 H	207	37.7	11.3
2	11750.00	38.3 AV	54.0	-15.7	1.63 H	207	27.0	11.3
3	#17625.00	51.6 PK	88.2	-36.6	2.09 H	165	32.8	18.8
4	#17625.00	39.4 AV	68.2	-28.8	2.09 H	165	20.6	18.8

Antenna Polarity & Test Distance : Vertical at 3 m

No	Frequency (MHz)	Emission Level (dBuV/m)	Limit (dBuV/m)	Margin (dB)	Antenna Height (m)	Table Angle (Degree)	Raw Value (dBuV)	Correction Factor (dB/m)
1	11750.00	51.4 PK	74.0	-22.6	3.09 V	276	40.1	11.3
2	11750.00	40.4 AV	54.0	-13.6	3.09 V	276	29.1	11.3
3	#17625.00	49.6 PK	88.2	-38.6	2.43 V	179	30.8	18.8
4	#17625.00	38.5 AV	68.2	-29.7	2.43 V	179	19.7	18.8

Remarks:

1. Emission Level(dBuV/m) = Raw Value(dBuV) + Correction Factor(dB/m)
2. Correction Factor(dB/m) = Antenna Factor(dB/m) + Cable Factor(dB) – Pre-Amplifier Factor(dB)
3. Margin value = Emission Level – Limit value
4. The other emission levels were very low against the limit.
5. "#": The radiated frequency is out of the restricted band.

RF Mode	TX 802.11ax (HE80)	Channel	CH 171 : 5855 MHz
Frequency Range	1GHz ~ 40GHz	Detector Function	Peak (PK) Average (AV)

Antenna Polarity & Test Distance : Horizontal at 3 m

No	Frequency (MHz)	Emission Level (dBuV/m)	Limit (dBuV/m)	Margin (dB)	Antenna Height (m)	Table Angle (Degree)	Raw Value (dBuV)	Correction Factor (dB/m)
1	11710.00	49.0 PK	74.0	-25.0	1.67 H	202	37.6	11.4
2	11710.00	38.3 AV	54.0	-15.7	1.67 H	202	26.9	11.4
3	#17565.00	51.3 PK	88.2	-36.9	2.08 H	170	32.8	18.5
4	#17565.00	39.3 AV	68.2	-28.9	2.08 H	170	20.8	18.5

Antenna Polarity & Test Distance : Vertical at 3 m

No	Frequency (MHz)	Emission Level (dBuV/m)	Limit (dBuV/m)	Margin (dB)	Antenna Height (m)	Table Angle (Degree)	Raw Value (dBuV)	Correction Factor (dB/m)
1	11710.00	51.6 PK	74.0	-22.4	3.16 V	296	40.2	11.4
2	11710.00	40.8 AV	54.0	-13.2	3.16 V	296	29.4	11.4
3	#17565.00	49.2 PK	88.2	-39.0	2.39 V	184	30.7	18.5
4	#17565.00	38.2 AV	68.2	-30.0	2.39 V	184	19.7	18.5

Remarks:

1. Emission Level(dBuV/m) = Raw Value(dBuV) + Correction Factor(dB/m)
2. Correction Factor(dB/m) = Antenna Factor(dB/m) + Cable Factor(dB) – Pre-Amplifier Factor(dB)
3. Margin value = Emission Level – Limit value
4. The other emission levels were very low against the limit.
5. "#": The radiated frequency is out of the restricted band.

RF Mode	TX 802.11ax (HE160)	Channel	CH 163 : 5815 MHz
Frequency Range	1GHz ~ 40GHz	Detector Function	Peak (PK) Average (AV)

Antenna Polarity & Test Distance : Horizontal at 3 m

No	Frequency (MHz)	Emission Level (dBuV/m)	Limit (dBuV/m)	Margin (dB)	Antenna Height (m)	Table Angle (Degree)	Raw Value (dBuV)	Correction Factor (dB/m)
1	11630.00	49.3 PK	74.0	-24.7	1.69 H	218	37.5	11.8
2	11630.00	38.2 AV	54.0	-15.8	1.69 H	218	26.4	11.8
3	#17445.00	51.6 PK	88.2	-36.6	2.18 H	176	33.9	17.7
4	#17445.00	39.6 AV	68.2	-28.6	2.18 H	176	21.9	17.7

Antenna Polarity & Test Distance : Vertical at 3 m

No	Frequency (MHz)	Emission Level (dBuV/m)	Limit (dBuV/m)	Margin (dB)	Antenna Height (m)	Table Angle (Degree)	Raw Value (dBuV)	Correction Factor (dB/m)
1	11630.00	51.4 PK	74.0	-22.6	3.13 V	290	39.6	11.8
2	11630.00	40.7 AV	54.0	-13.3	3.13 V	290	28.9	11.8
3	#17445.00	49.6 PK	88.2	-38.6	2.42 V	173	31.9	17.7
4	#17445.00	38.7 AV	68.2	-29.5	2.42 V	173	21.0	17.7

Remarks:

1. Emission Level(dBuV/m) = Raw Value(dBuV) + Correction Factor(dB/m)
2. Correction Factor(dB/m) = Antenna Factor(dB/m) + Cable Factor(dB) – Pre-Amplifier Factor(dB)
3. Margin value = Emission Level – Limit value
4. The other emission levels were very low against the limit.
5. "#": The radiated frequency is out of the restricted band.

RF Mode	TX 20MHz Preamble 802.11ax (RU26)	Channel	CH 169 : 5845 MHz
Frequency Range	1GHz ~ 40GHz	Detector Function	Peak (PK) Average (AV)

Antenna Polarity & Test Distance : Horizontal at 3 m

No	Frequency (MHz)	Emission Level (dBuV/m)	Limit (dBuV/m)	Margin (dB)	Antenna Height (m)	Table Angle (Degree)	Raw Value (dBuV)	Correction Factor (dB/m)
1	11690.00	50.2 PK	74.0	-23.8	1.67 H	137	38.7	11.5
2	11690.00	38.7 AV	54.0	-15.3	1.67 H	137	27.2	11.5
3	#17535.00	52.5 PK	88.2	-35.7	2.15 H	198	34.1	18.4
4	#17535.00	41.0 AV	68.2	-27.2	2.15 H	198	22.6	18.4

Antenna Polarity & Test Distance : Vertical at 3 m

No	Frequency (MHz)	Emission Level (dBuV/m)	Limit (dBuV/m)	Margin (dB)	Antenna Height (m)	Table Angle (Degree)	Raw Value (dBuV)	Correction Factor (dB/m)
1	11690.00	51.6 PK	74.0	-22.4	3.26 V	303	40.1	11.5
2	11690.00	41.0 AV	54.0	-13.0	3.26 V	303	29.5	11.5
3	#17535.00	50.4 PK	88.2	-37.8	2.26 V	122	32.0	18.4
4	#17535.00	38.4 AV	68.2	-29.8	2.26 V	122	20.0	18.4

Remarks:

1. Emission Level(dBuV/m) = Raw Value(dBuV) + Correction Factor(dB/m)
2. Correction Factor(dB/m) = Antenna Factor(dB/m) + Cable Factor(dB) – Pre-Amplifier Factor(dB)
3. Margin value = Emission Level – Limit value
4. The other emission levels were very low against the limit.
5. "#": The radiated frequency is out of the restricted band.

RF Mode	TX 20MHz Preamble 802.11ax (RU26)	Channel	CH 173 : 5865 MHz
Frequency Range	1GHz ~ 40GHz	Detector Function	Peak (PK) Average (AV)

Antenna Polarity & Test Distance : Horizontal at 3 m

No	Frequency (MHz)	Emission Level (dBuV/m)	Limit (dBuV/m)	Margin (dB)	Antenna Height (m)	Table Angle (Degree)	Raw Value (dBuV)	Correction Factor (dB/m)
1	11730.00	49.9 PK	74.0	-24.1	1.68 H	111	38.4	11.5
2	11730.00	38.5 AV	54.0	-15.5	1.68 H	111	27.0	11.5
3	#17595.00	52.6 PK	88.2	-35.6	2.21 H	194	33.8	18.8
4	#17595.00	40.8 AV	68.2	-27.4	2.21 H	194	22.0	18.8

Antenna Polarity & Test Distance : Vertical at 3 m

No	Frequency (MHz)	Emission Level (dBuV/m)	Limit (dBuV/m)	Margin (dB)	Antenna Height (m)	Table Angle (Degree)	Raw Value (dBuV)	Correction Factor (dB/m)
1	11730.00	51.3 PK	74.0	-22.7	3.28 V	310	39.8	11.5
2	11730.00	40.8 AV	54.0	-13.2	3.28 V	310	29.3	11.5
3	#17595.00	50.5 PK	88.2	-37.7	2.30 V	109	31.7	18.8
4	#17595.00	38.7 AV	68.2	-29.5	2.30 V	109	19.9	18.8

Remarks:

1. Emission Level(dBuV/m) = Raw Value(dBuV) + Correction Factor(dB/m)
2. Correction Factor(dB/m) = Antenna Factor(dB/m) + Cable Factor(dB) – Pre-Amplifier Factor(dB)
3. Margin value = Emission Level – Limit value
4. The other emission levels were very low against the limit.
5. " # ": The radiated frequency is out of the restricted band.

RF Mode	TX 20MHz Preamble 802.11ax (RU26)	Channel	CH 177 : 5885 MHz
Frequency Range	1GHz ~ 40GHz	Detector Function	Peak (PK) Average (AV)

Antenna Polarity & Test Distance : Horizontal at 3 m

No	Frequency (MHz)	Emission Level (dBuV/m)	Limit (dBuV/m)	Margin (dB)	Antenna Height (m)	Table Angle (Degree)	Raw Value (dBuV)	Correction Factor (dB/m)
1	11770.00	49.3 PK	74.0	-24.7	1.68 H	137	38.0	11.3
2	11770.00	38.3 AV	54.0	-15.7	1.68 H	137	27.0	11.3
3	#17655.00	52.3 PK	88.2	-35.9	2.12 H	209	33.5	18.8
4	#17655.00	40.6 AV	68.2	-27.6	2.12 H	209	21.8	18.8

Antenna Polarity & Test Distance : Vertical at 3 m

No	Frequency (MHz)	Emission Level (dBuV/m)	Limit (dBuV/m)	Margin (dB)	Antenna Height (m)	Table Angle (Degree)	Raw Value (dBuV)	Correction Factor (dB/m)
1	11770.00	51.0 PK	74.0	-23.0	3.27 V	288	39.7	11.3
2	11770.00	40.6 AV	54.0	-13.4	3.27 V	288	29.3	11.3
3	#17655.00	50.8 PK	88.2	-37.4	2.24 V	115	32.0	18.8
4	#17655.00	38.7 AV	68.2	-29.5	2.24 V	115	19.9	18.8

Remarks:

1. Emission Level(dBuV/m) = Raw Value(dBuV) + Correction Factor(dB/m)
2. Correction Factor(dB/m) = Antenna Factor(dB/m) + Cable Factor(dB) – Pre-Amplifier Factor(dB)
3. Margin value = Emission Level – Limit value
4. The other emission levels were very low against the limit.
5. " # ": The radiated frequency is out of the restricted band.

RF Mode	TX 20MHz Preamble 802.11ax (RU242)	Channel	CH 169 : 5845 MHz
Frequency Range	1GHz ~ 40GHz	Detector Function	Peak (PK) Average (AV)

Antenna Polarity & Test Distance : Horizontal at 3 m

No	Frequency (MHz)	Emission Level (dBuV/m)	Limit (dBuV/m)	Margin (dB)	Antenna Height (m)	Table Angle (Degree)	Raw Value (dBuV)	Correction Factor (dB/m)
1	11690.00	50.0 PK	74.0	-24.0	1.66 H	131	38.5	11.5
2	11690.00	38.7 AV	54.0	-15.3	1.66 H	131	27.2	11.5
3	#17535.00	52.3 PK	88.2	-35.9	2.17 H	207	33.9	18.4
4	#17535.00	40.5 AV	68.2	-27.7	2.17 H	207	22.1	18.4

Antenna Polarity & Test Distance : Vertical at 3 m

No	Frequency (MHz)	Emission Level (dBuV/m)	Limit (dBuV/m)	Margin (dB)	Antenna Height (m)	Table Angle (Degree)	Raw Value (dBuV)	Correction Factor (dB/m)
1	11690.00	51.7 PK	74.0	-22.3	3.31 V	318	40.2	11.5
2	11690.00	40.9 AV	54.0	-13.1	3.31 V	318	29.4	11.5
3	#17535.00	50.2 PK	88.2	-38.0	2.29 V	115	31.8	18.4
4	#17535.00	37.9 AV	68.2	-30.3	2.29 V	115	19.5	18.4

Remarks:

1. Emission Level(dBuV/m) = Raw Value(dBuV) + Correction Factor(dB/m)
2. Correction Factor(dB/m) = Antenna Factor(dB/m) + Cable Factor(dB) – Pre-Amplifier Factor(dB)
3. Margin value = Emission Level – Limit value
4. The other emission levels were very low against the limit.
5. " # ": The radiated frequency is out of the restricted band.

RF Mode	TX 20MHz Preamble 802.11ax (RU242)	Channel	CH 173 : 5865 MHz
Frequency Range	1GHz ~ 40GHz	Detector Function	Peak (PK) Average (AV)

Antenna Polarity & Test Distance : Horizontal at 3 m

No	Frequency (MHz)	Emission Level (dBuV/m)	Limit (dBuV/m)	Margin (dB)	Antenna Height (m)	Table Angle (Degree)	Raw Value (dBuV)	Correction Factor (dB/m)
1	11730.00	50.3 PK	74.0	-23.7	1.70 H	116	38.8	11.5
2	11730.00	38.9 AV	54.0	-15.1	1.70 H	116	27.4	11.5
3	#17595.00	52.3 PK	88.2	-35.9	2.15 H	199	33.5	18.8
4	#17595.00	40.4 AV	68.2	-27.8	2.15 H	199	21.6	18.8

Antenna Polarity & Test Distance : Vertical at 3 m

No	Frequency (MHz)	Emission Level (dBuV/m)	Limit (dBuV/m)	Margin (dB)	Antenna Height (m)	Table Angle (Degree)	Raw Value (dBuV)	Correction Factor (dB/m)
1	11730.00	51.3 PK	74.0	-22.7	3.29 V	307	39.8	11.5
2	11730.00	40.9 AV	54.0	-13.1	3.29 V	307	29.4	11.5
3	#17595.00	51.0 PK	88.2	-37.2	2.27 V	117	32.2	18.8
4	#17595.00	38.9 AV	68.2	-29.3	2.27 V	117	20.1	18.8

Remarks:

1. Emission Level(dBuV/m) = Raw Value(dBuV) + Correction Factor(dB/m)
2. Correction Factor(dB/m) = Antenna Factor(dB/m) + Cable Factor(dB) – Pre-Amplifier Factor(dB)
3. Margin value = Emission Level – Limit value
4. The other emission levels were very low against the limit.
5. " # ": The radiated frequency is out of the restricted band.

RF Mode	TX 20MHz Preamble 802.11ax (RU242)	Channel	CH 177 : 5885 MHz
Frequency Range	1GHz ~ 40GHz	Detector Function	Peak (PK) Average (AV)

Antenna Polarity & Test Distance : Horizontal at 3 m

No	Frequency (MHz)	Emission Level (dBuV/m)	Limit (dBuV/m)	Margin (dB)	Antenna Height (m)	Table Angle (Degree)	Raw Value (dBuV)	Correction Factor (dB/m)
1	11770.00	50.0 PK	74.0	-24.0	1.72 H	134	38.7	11.3
2	11770.00	38.6 AV	54.0	-15.4	1.72 H	134	27.3	11.3
3	#17655.00	52.4 PK	88.2	-35.8	2.11 H	204	33.6	18.8
4	#17655.00	40.4 AV	68.2	-27.8	2.11 H	204	21.6	18.8

Antenna Polarity & Test Distance : Vertical at 3 m

No	Frequency (MHz)	Emission Level (dBuV/m)	Limit (dBuV/m)	Margin (dB)	Antenna Height (m)	Table Angle (Degree)	Raw Value (dBuV)	Correction Factor (dB/m)
1	11770.00	51.7 PK	74.0	-22.3	3.26 V	304	40.4	11.3
2	11770.00	41.2 AV	54.0	-12.8	3.26 V	304	29.9	11.3
3	#17655.00	50.9 PK	88.2	-37.3	2.29 V	122	32.1	18.8
4	#17655.00	38.8 AV	68.2	-29.4	2.29 V	122	20.0	18.8

Remarks:

1. Emission Level(dBuV/m) = Raw Value(dBuV) + Correction Factor(dB/m)
2. Correction Factor(dB/m) = Antenna Factor(dB/m) + Cable Factor(dB) – Pre-Amplifier Factor(dB)
3. Margin value = Emission Level – Limit value
4. The other emission levels were very low against the limit.
5. " # ": The radiated frequency is out of the restricted band.

RF Mode	TX 40MHz Preamble 802.11ax (RU484)	Channel	CH 167 : 5835 MHz
Frequency Range	1GHz ~ 40GHz	Detector Function	Peak (PK) Average (AV)

Antenna Polarity & Test Distance : Horizontal at 3 m

No	Frequency (MHz)	Emission Level (dBuV/m)	Limit (dBuV/m)	Margin (dB)	Antenna Height (m)	Table Angle (Degree)	Raw Value (dBuV)	Correction Factor (dB/m)
1	11670.00	50.0 PK	74.0	-24.0	1.76 H	121	38.4	11.6
2	11670.00	38.8 AV	54.0	-15.2	1.76 H	121	27.2	11.6
3	#17505.00	52.7 PK	88.2	-35.5	2.16 H	191	34.5	18.2
4	#17505.00	41.1 AV	68.2	-27.1	2.16 H	191	22.9	18.2

Antenna Polarity & Test Distance : Vertical at 3 m

No	Frequency (MHz)	Emission Level (dBuV/m)	Limit (dBuV/m)	Margin (dB)	Antenna Height (m)	Table Angle (Degree)	Raw Value (dBuV)	Correction Factor (dB/m)
1	11670.00	51.8 PK	74.0	-22.2	3.23 V	304	40.2	11.6
2	11670.00	40.9 AV	54.0	-13.1	3.23 V	304	29.3	11.6
3	#17505.00	50.5 PK	88.2	-37.7	2.26 V	115	32.3	18.2
4	#17505.00	38.5 AV	68.2	-29.7	2.26 V	115	20.3	18.2

Remarks:

1. Emission Level(dBuV/m) = Raw Value(dBuV) + Correction Factor(dB/m)
2. Correction Factor(dB/m) = Antenna Factor(dB/m) + Cable Factor(dB) – Pre-Amplifier Factor(dB)
3. Margin value = Emission Level – Limit value
4. The other emission levels were very low against the limit.
5. " # ": The radiated frequency is out of the restricted band.

RF Mode	TX 40MHz Preamble 802.11ax (RU484)	Channel	CH 175 : 5875 MHz
Frequency Range	1GHz ~ 40GHz	Detector Function	Peak (PK) Average (AV)

Antenna Polarity & Test Distance : Horizontal at 3 m

No	Frequency (MHz)	Emission Level (dBuV/m)	Limit (dBuV/m)	Margin (dB)	Antenna Height (m)	Table Angle (Degree)	Raw Value (dBuV)	Correction Factor (dB/m)
1	11750.00	50.3 PK	74.0	-23.7	1.65 H	135	39.0	11.3
2	11750.00	39.1 AV	54.0	-14.9	1.65 H	135	27.8	11.3
3	#17625.00	52.3 PK	88.2	-35.9	2.20 H	191	33.5	18.8
4	#17625.00	40.8 AV	68.2	-27.4	2.20 H	191	22.0	18.8

Antenna Polarity & Test Distance : Vertical at 3 m

No	Frequency (MHz)	Emission Level (dBuV/m)	Limit (dBuV/m)	Margin (dB)	Antenna Height (m)	Table Angle (Degree)	Raw Value (dBuV)	Correction Factor (dB/m)
1	11750.00	52.1 PK	74.0	-21.9	3.25 V	307	40.8	11.3
2	11750.00	41.4 AV	54.0	-12.6	3.25 V	307	30.1	11.3
3	#17625.00	49.9 PK	88.2	-38.3	2.27 V	125	31.1	18.8
4	#17625.00	38.0 AV	68.2	-30.2	2.27 V	125	19.2	18.8

Remarks:

1. Emission Level(dBuV/m) = Raw Value(dBuV) + Correction Factor(dB/m)
2. Correction Factor(dB/m) = Antenna Factor(dB/m) + Cable Factor(dB) – Pre-Amplifier Factor(dB)
3. Margin value = Emission Level – Limit value
4. The other emission levels were very low against the limit.
5. " # ": The radiated frequency is out of the restricted band.

RF Mode	TX 80MHz Preamble 802.11ax (RU996)	Channel	CH 171 : 5855 MHz
Frequency Range	1GHz ~ 40GHz	Detector Function	Peak (PK) Average (AV)

Antenna Polarity & Test Distance : Horizontal at 3 m

No	Frequency (MHz)	Emission Level (dBuV/m)	Limit (dBuV/m)	Margin (dB)	Antenna Height (m)	Table Angle (Degree)	Raw Value (dBuV)	Correction Factor (dB/m)
1	11710.00	49.2 PK	74.0	-24.8	1.73 H	126	37.8	11.4
2	11710.00	38.2 AV	54.0	-15.8	1.73 H	126	26.8	11.4
3	#17565.00	52.2 PK	88.2	-36.0	2.21 H	196	33.7	18.5
4	#17565.00	40.4 AV	68.2	-27.8	2.21 H	196	21.9	18.5

Antenna Polarity & Test Distance : Vertical at 3 m

No	Frequency (MHz)	Emission Level (dBuV/m)	Limit (dBuV/m)	Margin (dB)	Antenna Height (m)	Table Angle (Degree)	Raw Value (dBuV)	Correction Factor (dB/m)
1	11710.00	51.8 PK	74.0	-22.2	3.26 V	300	40.4	11.4
2	11710.00	40.9 AV	54.0	-13.1	3.26 V	300	29.5	11.4
3	#17565.00	50.9 PK	88.2	-37.3	2.28 V	135	32.4	18.5
4	#17565.00	38.7 AV	68.2	-29.5	2.28 V	135	20.2	18.5

Remarks:

1. Emission Level(dBuV/m) = Raw Value(dBuV) + Correction Factor(dB/m)
2. Correction Factor(dB/m) = Antenna Factor(dB/m) + Cable Factor(dB) – Pre-Amplifier Factor(dB)
3. Margin value = Emission Level – Limit value
4. The other emission levels were very low against the limit.
5. " # ": The radiated frequency is out of the restricted band.

RF Mode	TX 160MHz Preamble 802.11ax (RU1992)	Channel	CH 163 : 5815 MHz
Frequency Range	1GHz ~ 40GHz	Detector Function	Peak (PK) Average (AV)

Antenna Polarity & Test Distance : Horizontal at 3 m

No	Frequency (MHz)	Emission Level (dBuV/m)	Limit (dBuV/m)	Margin (dB)	Antenna Height (m)	Table Angle (Degree)	Raw Value (dBuV)	Correction Factor (dB/m)
1	11630.00	49.9 PK	74.0	-24.1	1.71 H	123	38.1	11.8
2	11630.00	38.7 AV	54.0	-15.3	1.71 H	123	26.9	11.8
3	#17445.00	52.4 PK	88.2	-35.8	2.17 H	197	34.7	17.7
4	#17445.00	40.7 AV	68.2	-27.5	2.17 H	197	23.0	17.7

Antenna Polarity & Test Distance : Vertical at 3 m

No	Frequency (MHz)	Emission Level (dBuV/m)	Limit (dBuV/m)	Margin (dB)	Antenna Height (m)	Table Angle (Degree)	Raw Value (dBuV)	Correction Factor (dB/m)
1	11630.00	51.7 PK	74.0	-22.3	3.24 V	319	39.9	11.8
2	11630.00	41.4 AV	54.0	-12.6	3.24 V	319	29.6	11.8
3	#17445.00	50.2 PK	88.2	-38.0	2.22 V	135	32.5	17.7
4	#17445.00	38.3 AV	68.2	-29.9	2.22 V	135	20.6	17.7

Remarks:

1. Emission Level(dBuV/m) = Raw Value(dBuV) + Correction Factor(dB/m)
2. Correction Factor(dB/m) = Antenna Factor(dB/m) + Cable Factor(dB) – Pre-Amplifier Factor(dB)
3. Margin value = Emission Level – Limit value
4. The other emission levels were very low against the limit.
5. " # ": The radiated frequency is out of the restricted band.

Below 1GHz Data:

RF Mode	TX 802.11ax (HE40)	Channel	CH 175 : 5875 MHz
Frequency Range	30MHz ~ 1GHz	Detector Function	Quasi-Peak (QP)

Antenna Polarity & Test Distance : Horizontal at 3 m								
No	Frequency (MHz)	Emission Level (dBuV/m)	Limit (dBuV/m)	Margin (dB)	Antenna Height (m)	Table Angle (Degree)	Raw Value (dBuV)	Correction Factor (dB/m)
1	36.21	26.9 QP	40.0	-13.1	2.00 H	147	40.3	-13.4
2	110.58	27.4 QP	43.5	-16.1	3.00 H	10	42.9	-15.5
3	256.67	24.0 QP	46.0	-22.0	1.00 H	168	37.6	-13.6
4	363.19	29.1 QP	46.0	-16.9	1.00 H	99	39.4	-10.3
5	500.09	24.8 QP	46.0	-21.2	1.00 H	229	31.8	-7.0
6	678.93	27.8 QP	46.0	-18.2	1.50 H	349	31.5	-3.7

Remarks:

1. Emission Level(dBuV/m) = Raw Value(dBuV) + Correction Factor(dB/m)
2. Correction Factor(dB/m) = Antenna Factor(dB/m) + Cable Factor(dB) – Pre-Amplifier Factor(dB)
3. Margin value = Emission Level – Limit value
4. The other emission levels were very low against the limit of frequency range 30MHz~1000MHz.
5. The emission levels were very low against the limit of frequency range 9kHz~30MHz: the amplitude of spurious emissions attenuated more than 20 dB below the permissible value to be report.

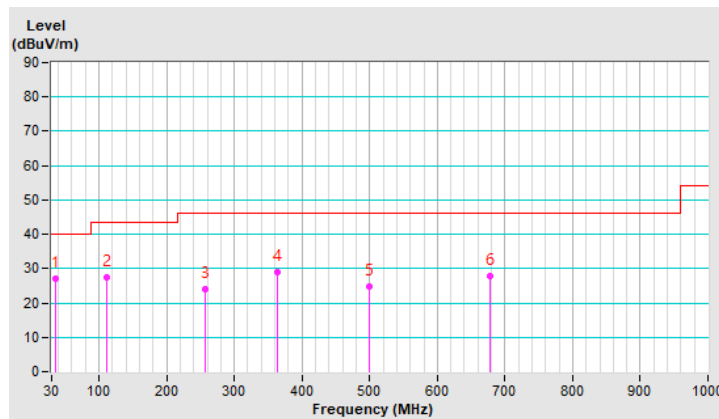

RF Mode	TX 802.11ax (HE40)	Channel	CH 175 : 5875 MHz
Frequency Range	30MHz ~ 1GHz	Detector Function	Quasi-Peak (QP)

Antenna Polarity & Test Distance : Vertical at 3 m								
No	Frequency (MHz)	Emission Level (dBuV/m)	Limit (dBuV/m)	Margin (dB)	Antenna Height (m)	Table Angle (Degree)	Raw Value (dBuV)	Correction Factor (dB/m)
1	36.08	34.5 QP	40.0	-5.5	1.00 V	350	47.9	-13.4
2	122.87	25.1 QP	43.5	-18.4	1.50 V	170	39.5	-14.4
3	235.87	19.8 QP	46.0	-26.2	1.50 V	345	34.2	-14.4
4	315.97	25.8 QP	46.0	-20.2	2.00 V	111	37.2	-11.4
5	390.31	24.2 QP	46.0	-21.8	2.00 V	139	33.9	-9.7
6	506.97	26.2 QP	46.0	-19.8	1.50 V	247	32.9	-6.7

Remarks:

1. Emission Level(dBuV/m) = Raw Value(dBuV) + Correction Factor(dB/m)
2. Correction Factor(dB/m) = Antenna Factor(dB/m) + Cable Factor(dB) – Pre-Amplifier Factor(dB)
3. Margin value = Emission Level – Limit value
4. The other emission levels were very low against the limit of frequency range 30MHz~1000MHz.
5. The emission levels were very low against the limit of frequency range 9kHz~30MHz: the amplitude of spurious emissions attenuated more than 20 dB below the permissible value to be report.

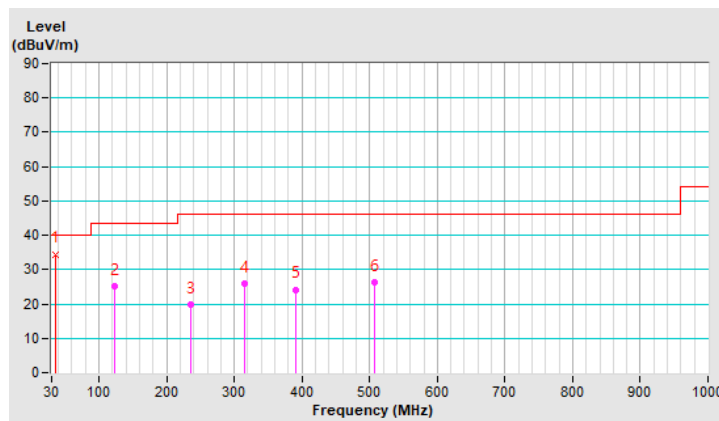

4.1.7 Test Results (Conducted Measurement)

Radiated versus Conducted Measurement	
<input checked="" type="checkbox"/> Conducted measurement	<input type="checkbox"/> Radiated measurement
<p><u>For Radiated measurement:</u> The level of unwanted emissions was measured when radiated by the cabinet or structure of the equipment with the antenna connector(s) terminated by a specified load (cabinet radiation)</p> <p><u>For Conducted measurement:</u> The level of unwanted emissions was measured as their power in a specified load (conducted spurious emissions).</p>	

Conducted Emission Convert Formula
<p>a. Emission Level (dBuV/m) = EIRP Level (dBm) – 20log(d) + 104.8 d = measurement distance in 3 meters.</p> <p>b. EIRP Level (dBm) = Raw Value(dBm) + Correction Factor(dB)</p> <p>c. Correction Factor is directional gain, and the composite gain will be used when signal support the correlated signal.</p> <p style="padding-left: 40px;">For the out of band spurious the gain for the specific band may have been used rather than the highest gain across all bands.</p> <p style="padding-left: 40px;">➤ Directional gain = 5.16 + 10log(2) = 8.17 dBi (Antenna Model: 260-25083)</p> <p style="padding-left: 40px;">For the band edge the gain for the specific band may have been used.</p> <p style="padding-left: 40px;">➤ Directional gain = 5.09 + 10log(2) = 8.1 dBi (Antenna Model: 260-25083)</p> <p style="padding-left: 40px;">➤ Directional gain = 4.71 + 10log(2) = 7.72 dBi (Antenna Model: 260-25084)</p> <p>Notes:</p> <p style="padding-left: 20px;">1. In restricted bands below 1000 MHz, add upper bound on ground plane reflection: For f = 30 – 1000 MHz, add 4.7 dB.</p> <p style="padding-left: 20px;">2. The conducted emission test was considered some factor to compute test result.</p>

Above 1GHz Data:
802.11a - Channel 169

Conducted spurious emission table

No.	Frequency (MHz)	Emission Level (dBuV/m)	Limit (dBuV/m)	Margin (dB)	Raw Value (dBm)		Correction Factor (dB)	EIRP Level (dBm)
					Chain0	Chain1		
1	3884.37	60.56 PK	74	-13.44	-46	-45.77	8.17	-34.70
2	3893.75	48.79 AV	54	-5.21	-57.62	-57.69	8.17	-46.47
3	#7784.37	61.76 PK	68.2	-6.44	-43.81	-45.76	8.17	-33.50
4	11687.5	63.26 PK	74	-10.74	-41.82	-45.18	8.17	-32.00
5	11690.62	51.79 AV	54	-2.21	-54.97	-54.35	8.17	-43.47
6	#17553.75	55.45 PK	68.2	-12.75	-50.52	-51.52	8.17	-39.81

Remarks:

1. Margin value = Emission Level – Limit value
2. The other emission levels were very low against the limit.
3. " # " : The frequency is out of the restricted band.

Chain 0

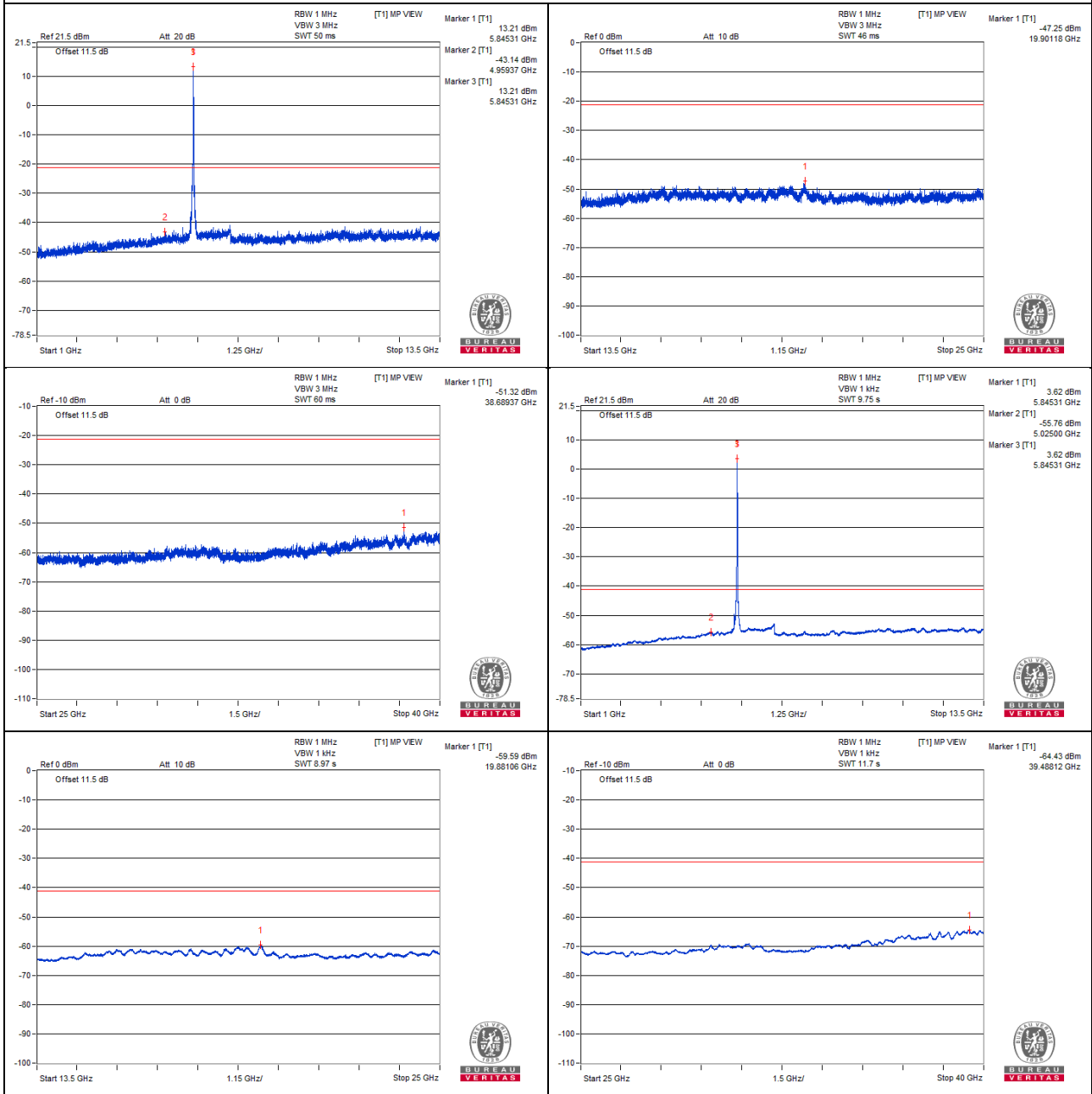

Chain 1

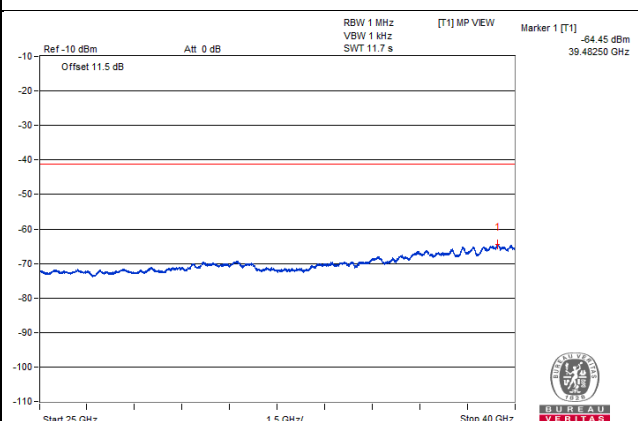
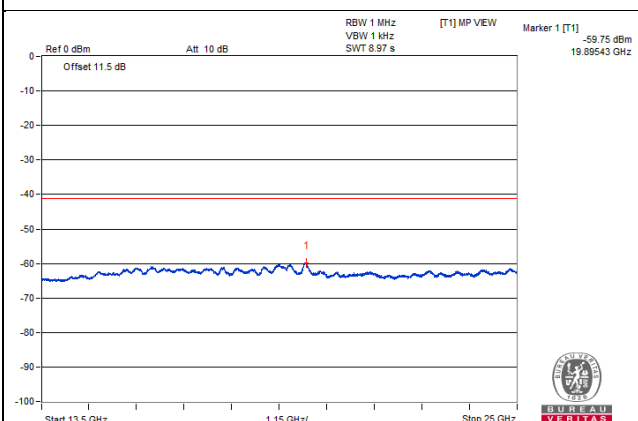
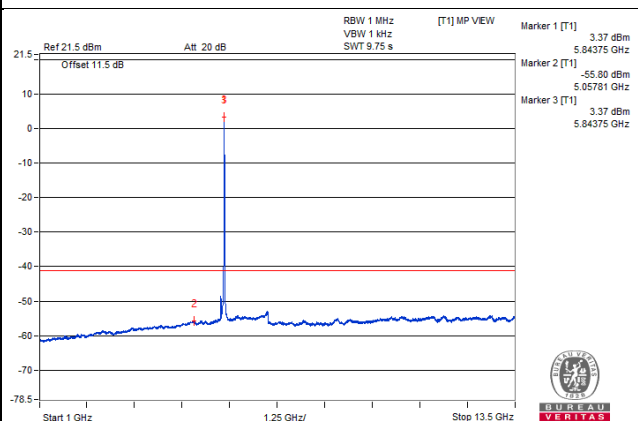
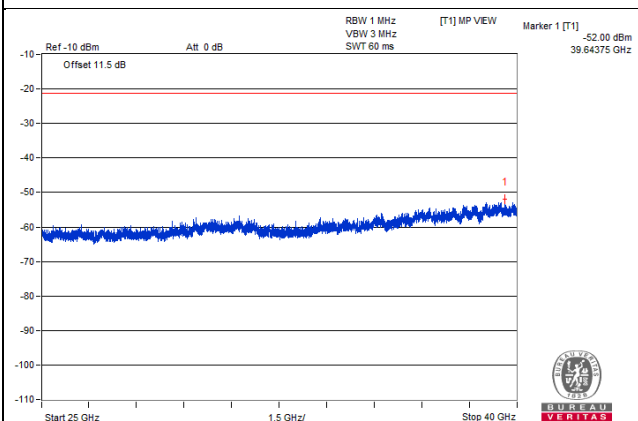
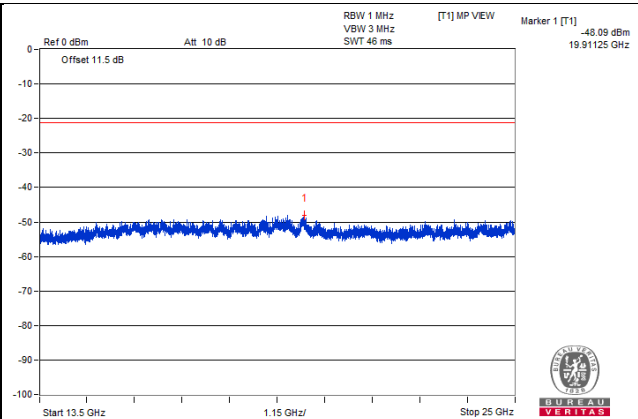
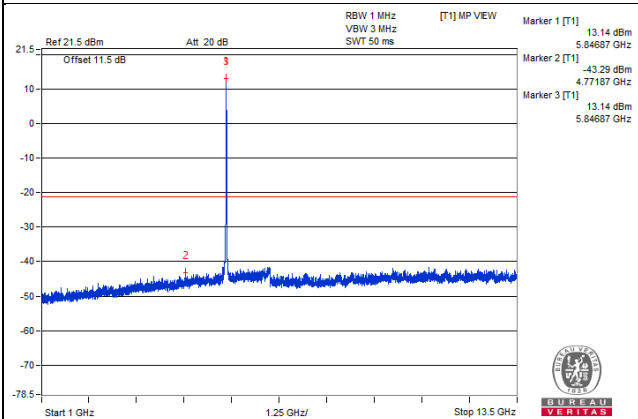

Bandedge

Chain 0_Peak

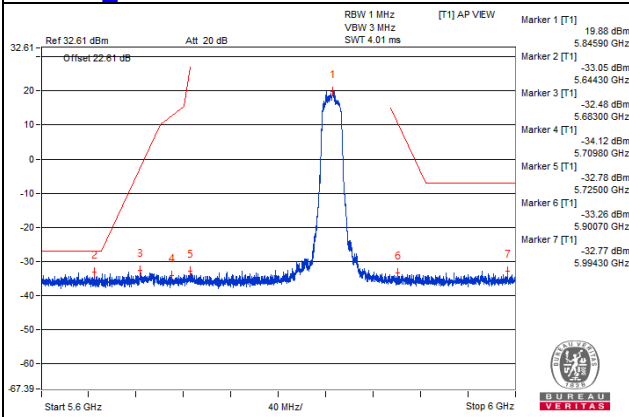

Chain 0_Average

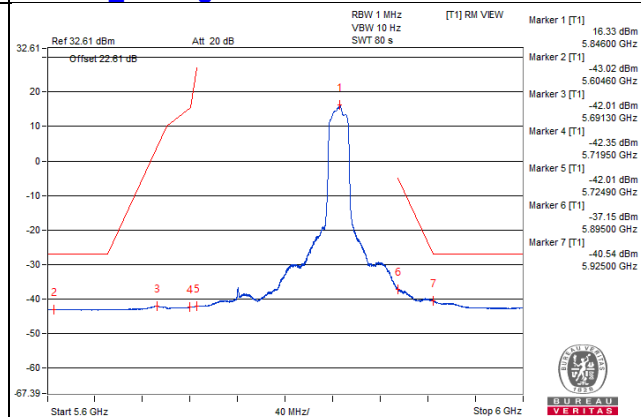

Chain 1_Peak

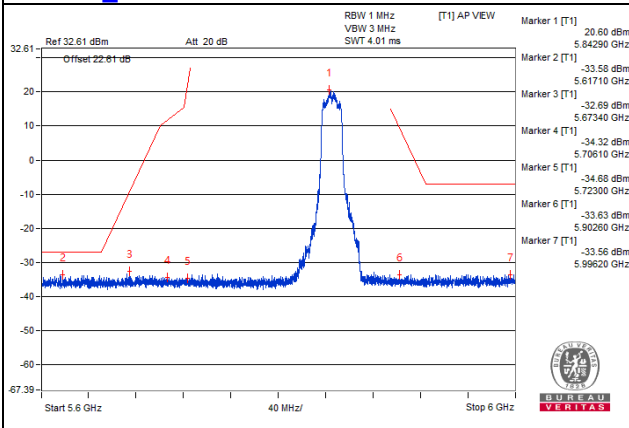

Chain 1_Average

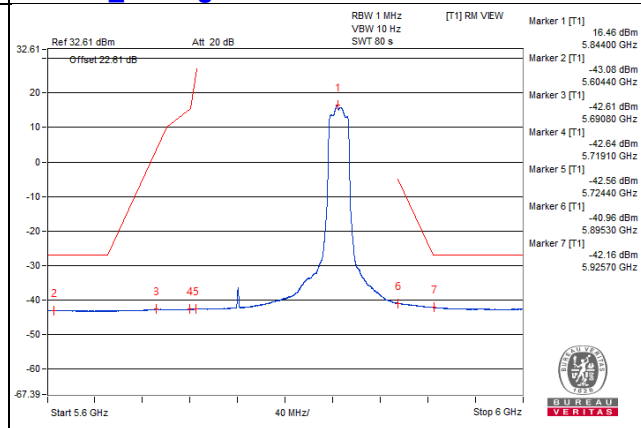

Note:

1. The offset including attenuator (10 dB), cable loss (1.5 dB), directional gain (8.1 dBi) and number of outputs ($10 \log(2)=3.01$ dB).
2. The test results were EIRP.

802.11a - Channel 173

Conducted spurious emission table

No.	Frequency (MHz)	Emission Level (dBuV/m)	Limit (dBuV/m)	Margin (dB)	Raw Value (dBm)		Correction Factor (dB)	EIRP Level (dBm)
					Chain0	Chain1		
1	3904.68	59.96 PK	74	-14.04	-47.29	-45.8	8.17	-35.30
2	3914.06	48.76 AV	54	-5.24	-57.73	-57.63	8.17	-46.50
3	#7839.06	61.46 PK	68.2	-6.74	-45.29	-44.69	8.17	-33.80
4	11737.5	62.72 PK	74	-11.28	-45.64	-42.39	8.17	-32.54
5	11731.25	51.15 AV	54	-2.85	-55.38	-55.21	8.17	-44.11
6	#17598.31	56.01 PK	68.2	-12.19	-49.58	-51.48	8.17	-39.25

Remarks:

1. Margin value = Emission Level – Limit value
2. The other emission levels were very low against the limit.
3. " # " : The frequency is out of the restricted band.

Chain 0

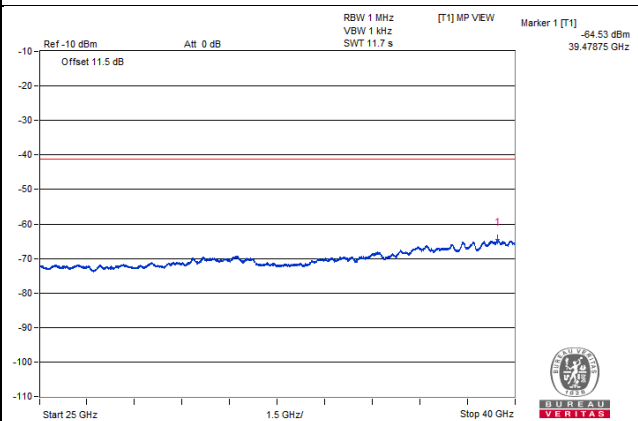
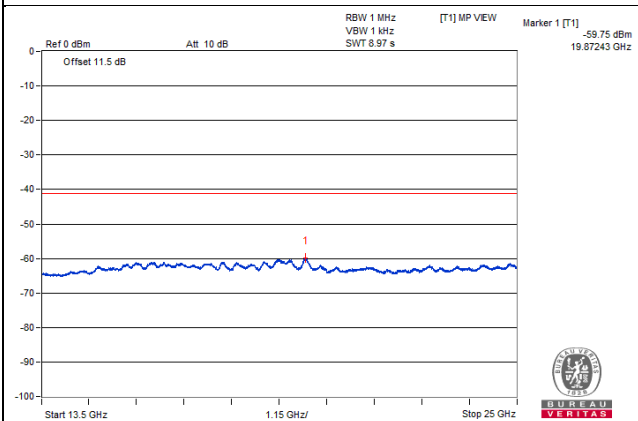
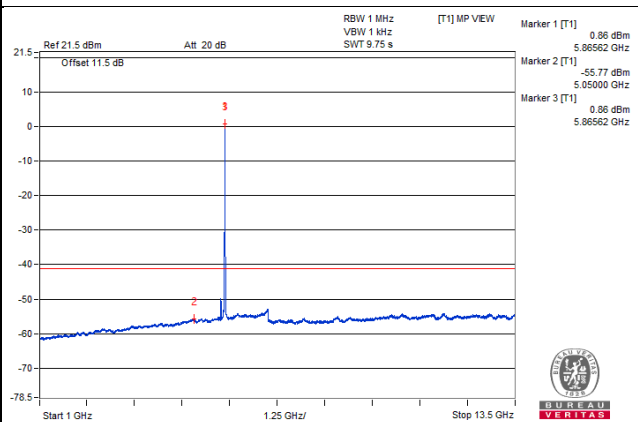
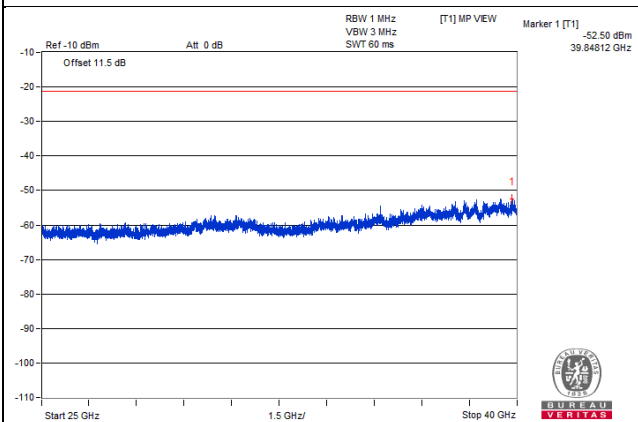
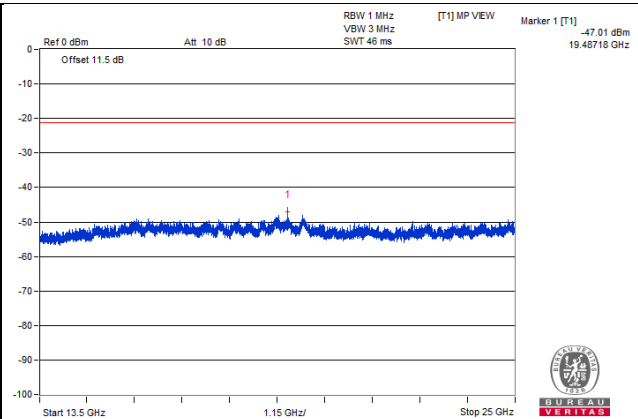
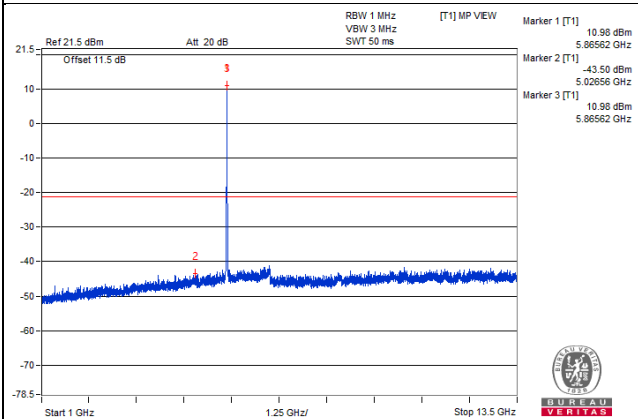

Chain 1

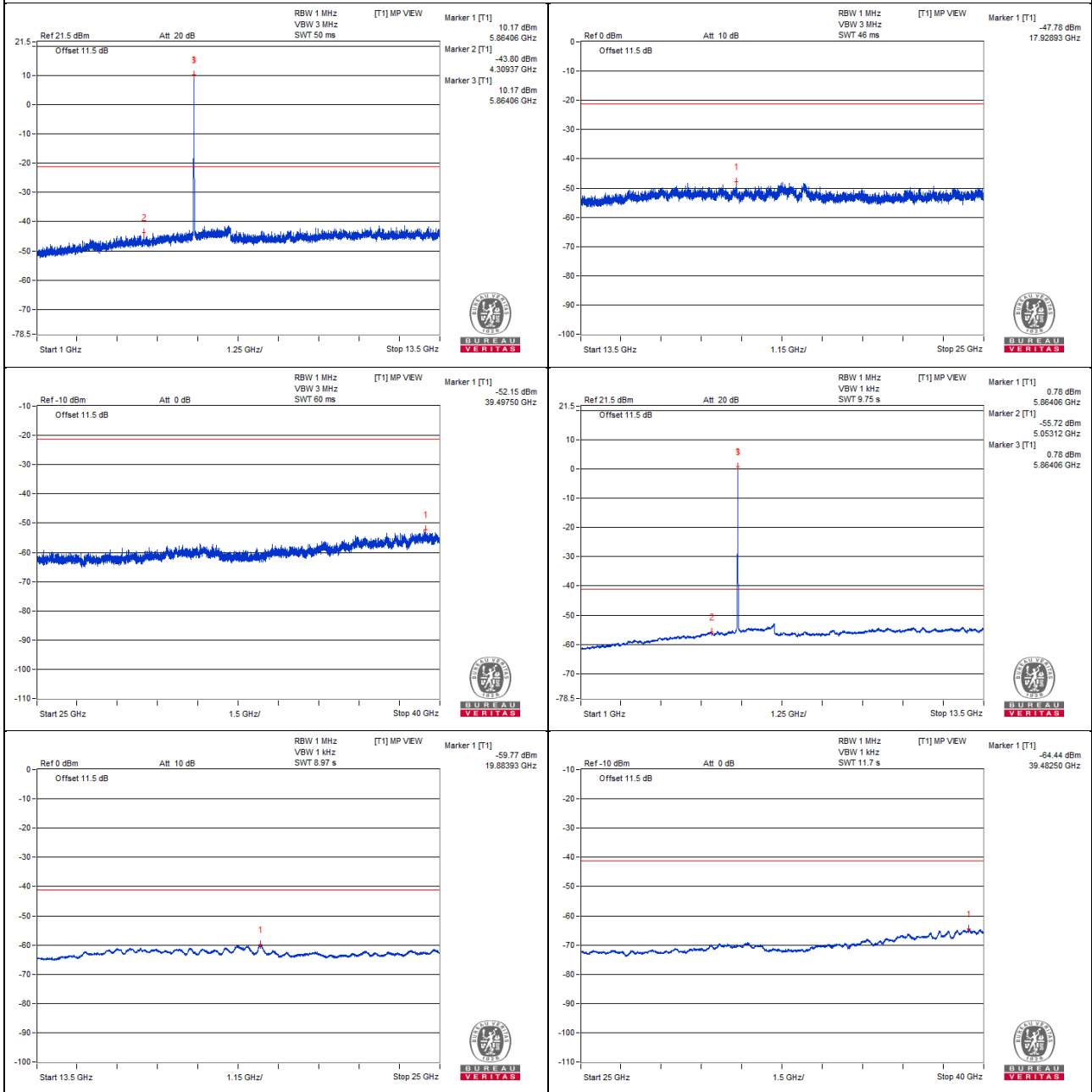

Bandedge

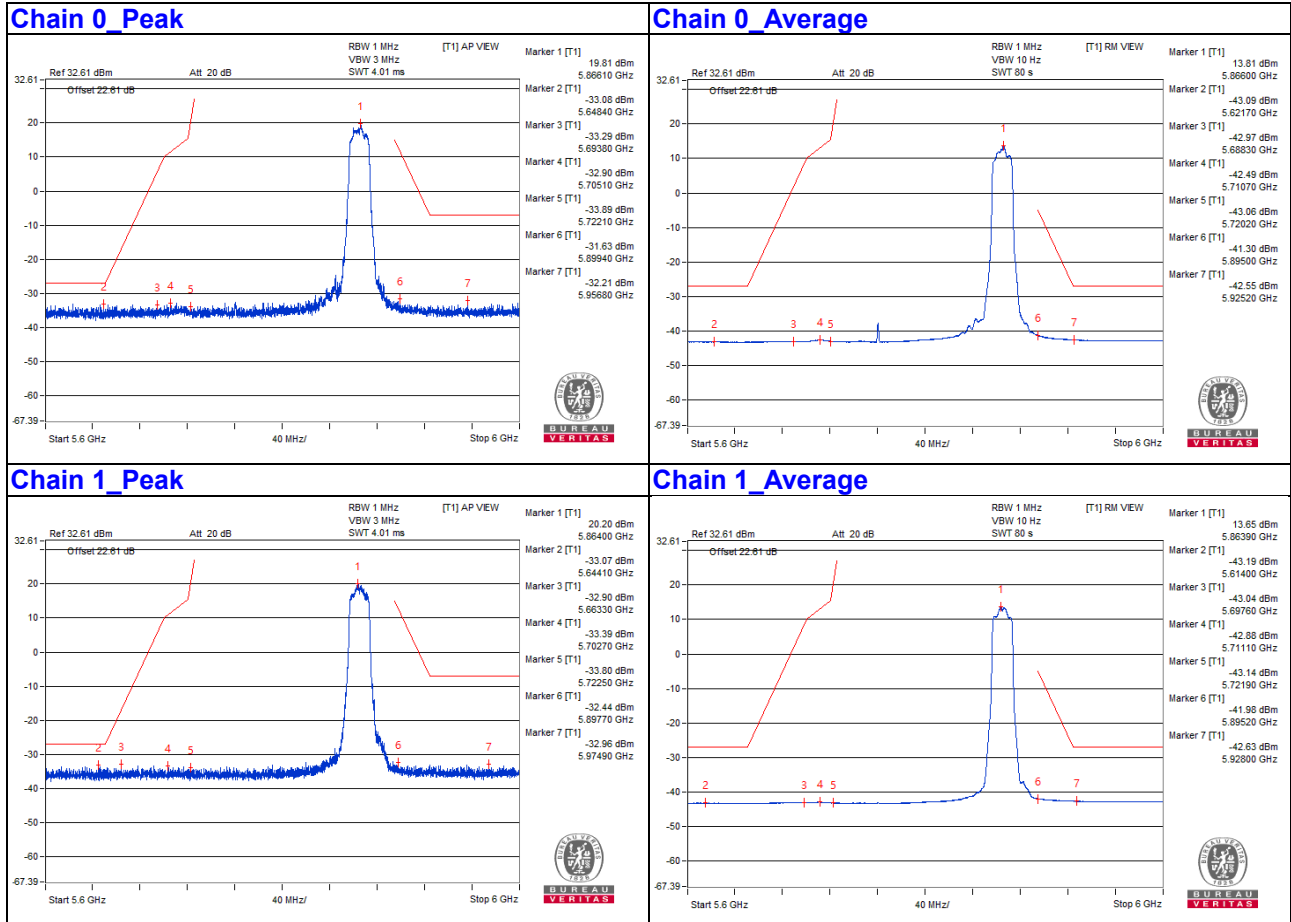

Note:

1. The offset including attenuator (10 dB), cable loss (1.5 dB), directional gain (8.1 dBi) and number of outputs (10 log (2)=3.01 dB).
2. The test results were EIRP.

802.11a - Channel 177

Conducted spurious emission table

No.	Frequency (MHz)	Emission Level (dBuV/m)	Limit (dBuV/m)	Margin (dB)	Raw Value (dBm)		Correction Factor (dB)	EIRP Level (dBm)
					Chain0	Chain1		
1	3940.62	60.35 PK	74	-13.65	-45.65	-46.58	8.17	-34.91
2	3907.81	48.93 AV	54	-5.07	-57.44	-57.58	8.17	-46.33
3	#7851.56	61.5 PK	68.2	-6.7	-46.08	-44.04	8.17	-33.76
4	11750	63.15 PK	74	-10.85	-44.29	-42.48	8.17	-32.11
5	11765.62	51.02 AV	54	-2.98	-55.44	-55.41	8.17	-44.24
6	#17648.62	55.49 PK	68.2	-12.71	-51.19	-50.73	8.17	-39.77

Remarks:

1. Margin value = Emission Level – Limit value
2. The other emission levels were very low against the limit.
3. " # " : The frequency is out of the restricted band.

Chain 0

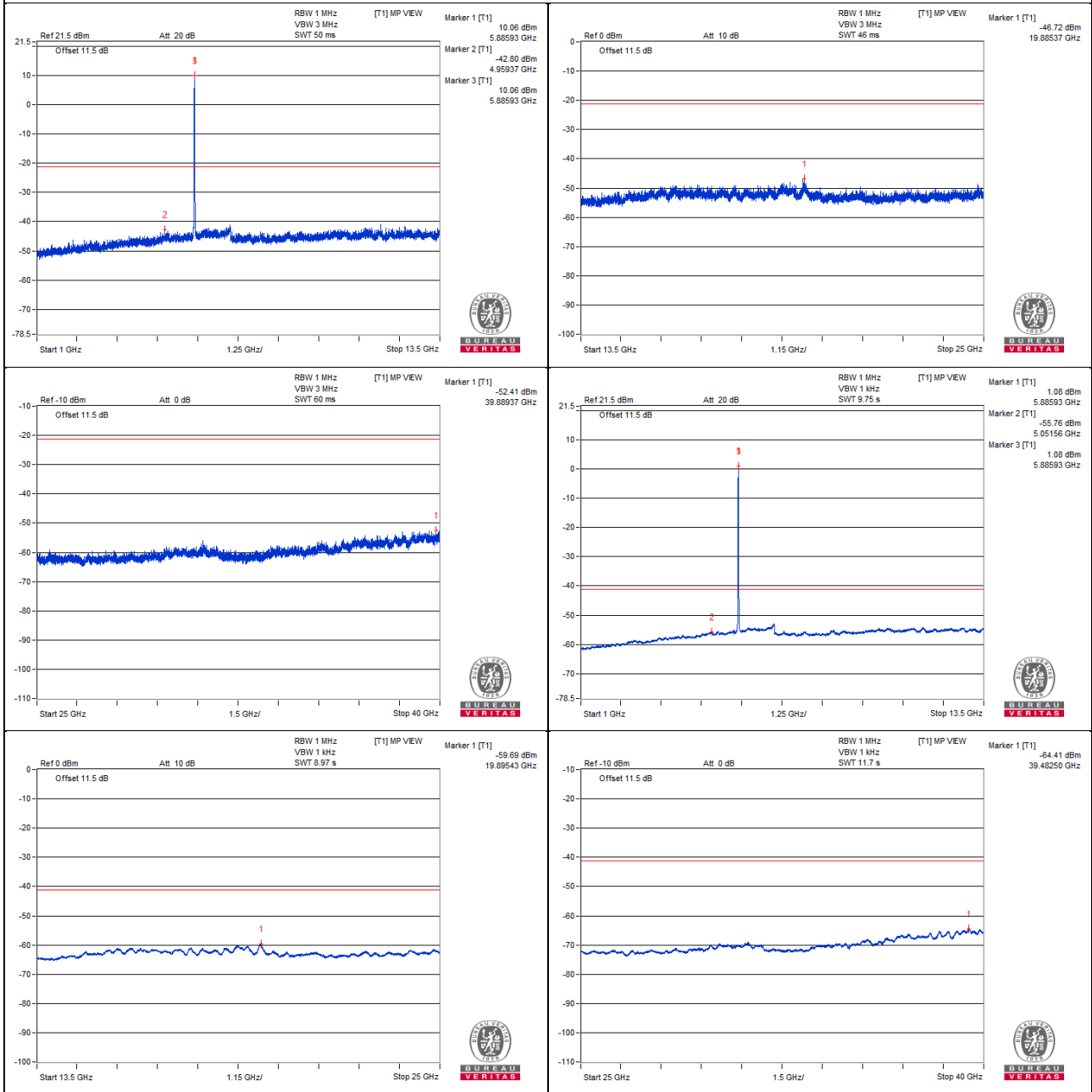

Chain 1

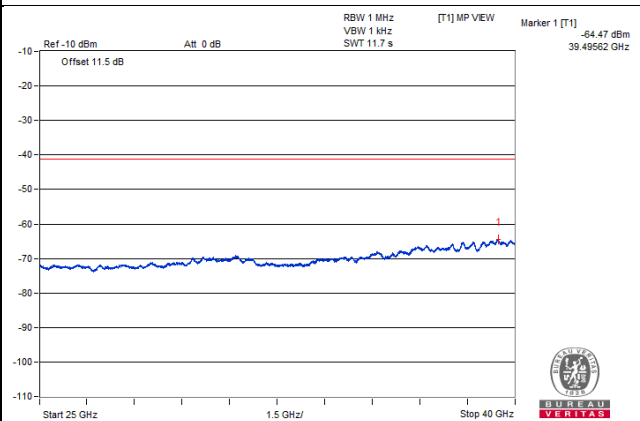
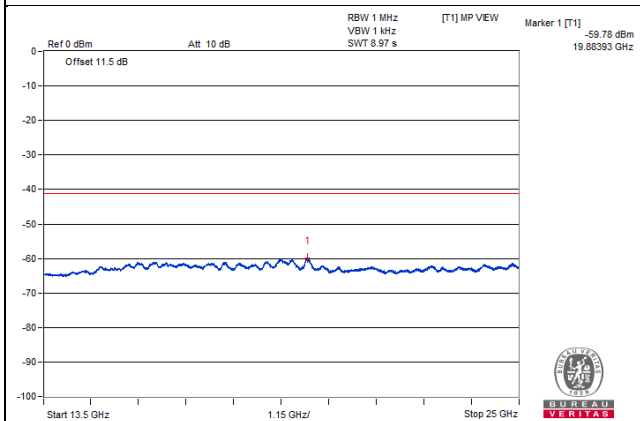
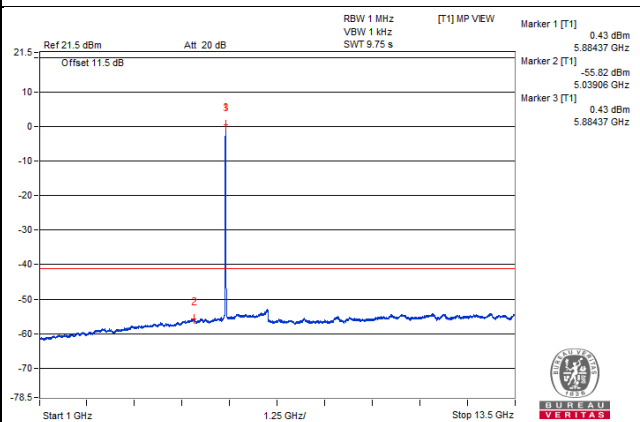
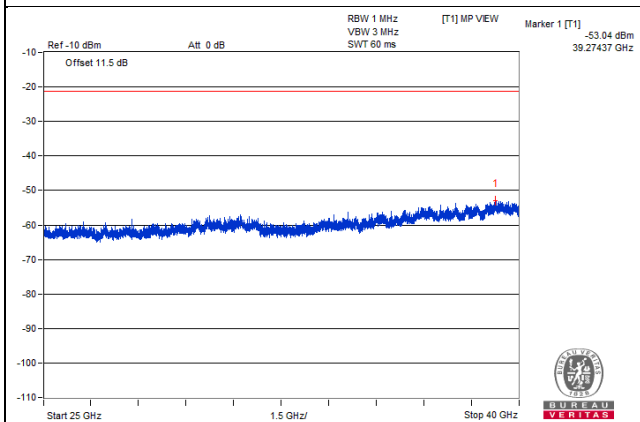
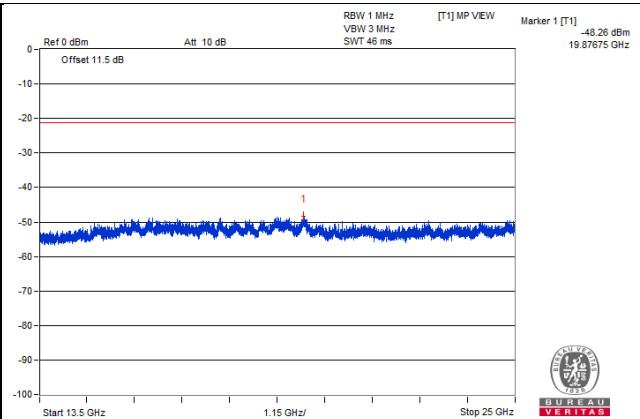
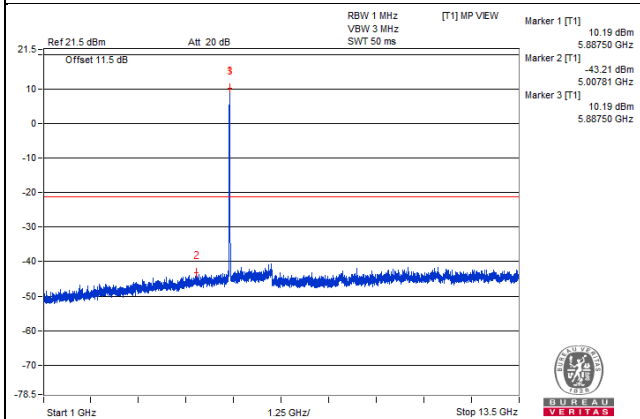

Bandedge

Chain 0_Peak

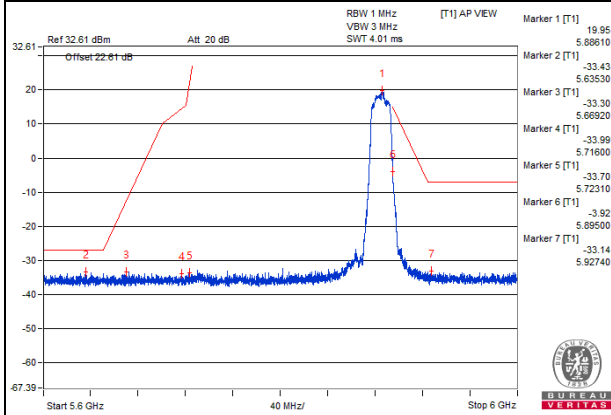

Chain 0_Average

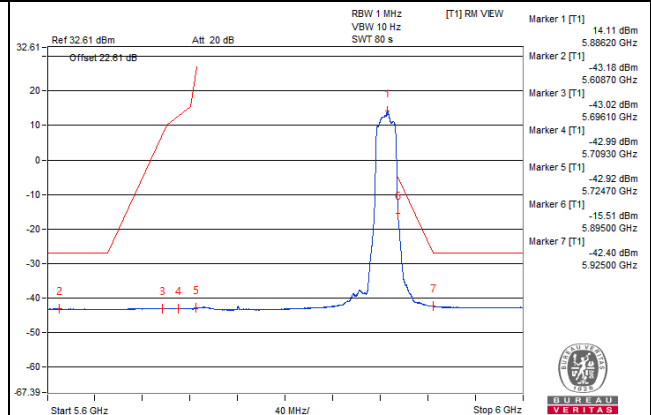

Chain 1_Peak

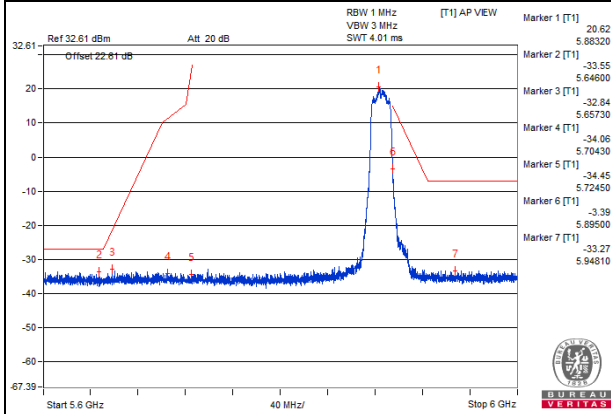

Chain 1_Average

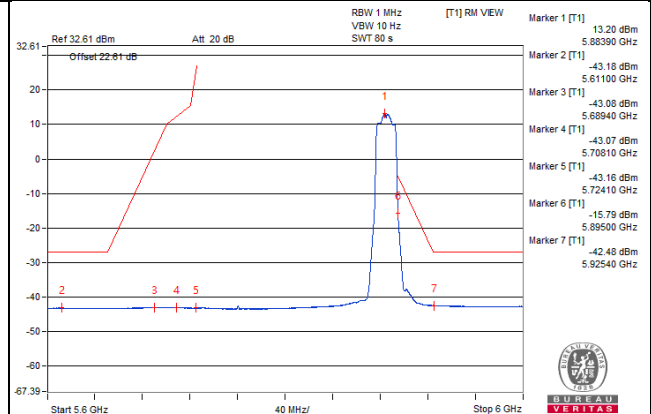

Note:

1. The offset including attenuator (10 dB), cable loss (1.5 dB), directional gain (8.1 dBi) and number of outputs ($10 \log(2) = 3.01$ dB).
2. The test results were EIRP.

802.11ax (HE20) - Channel 169

Conducted spurious emission table

No.	Frequency (MHz)	Emission Level (dBuV/m)	Limit (dBuV/m)	Margin (dB)	Raw Value (dBm)		Correction Factor (dB)	EIRP Level (dBm)
					Chain0	Chain1		
1	3889.06	59.91 PK	74	-14.09	-47.34	-45.85	8.17	-35.35
2	3903.12	48.71 AV	54	-5.29	-57.86	-57.61	8.17	-46.55
3	#7790.62	61.46 PK	68.2	-6.74	-44.03	-46.21	8.17	-33.80
4	11704.68	63.17 PK	74	-10.83	-43.62	-42.94	8.17	-32.09
5	11679.68	51.84 AV	54	-2.16	-54.81	-54.4	8.17	-43.42
6	#17525	55.93 PK	68.2	-12.27	-49.82	-51.33	8.17	-39.33

Remarks:

1. Margin value = Emission Level – Limit value
2. The other emission levels were very low against the limit.
3. " # " : The frequency is out of the restricted band.

Chain 0

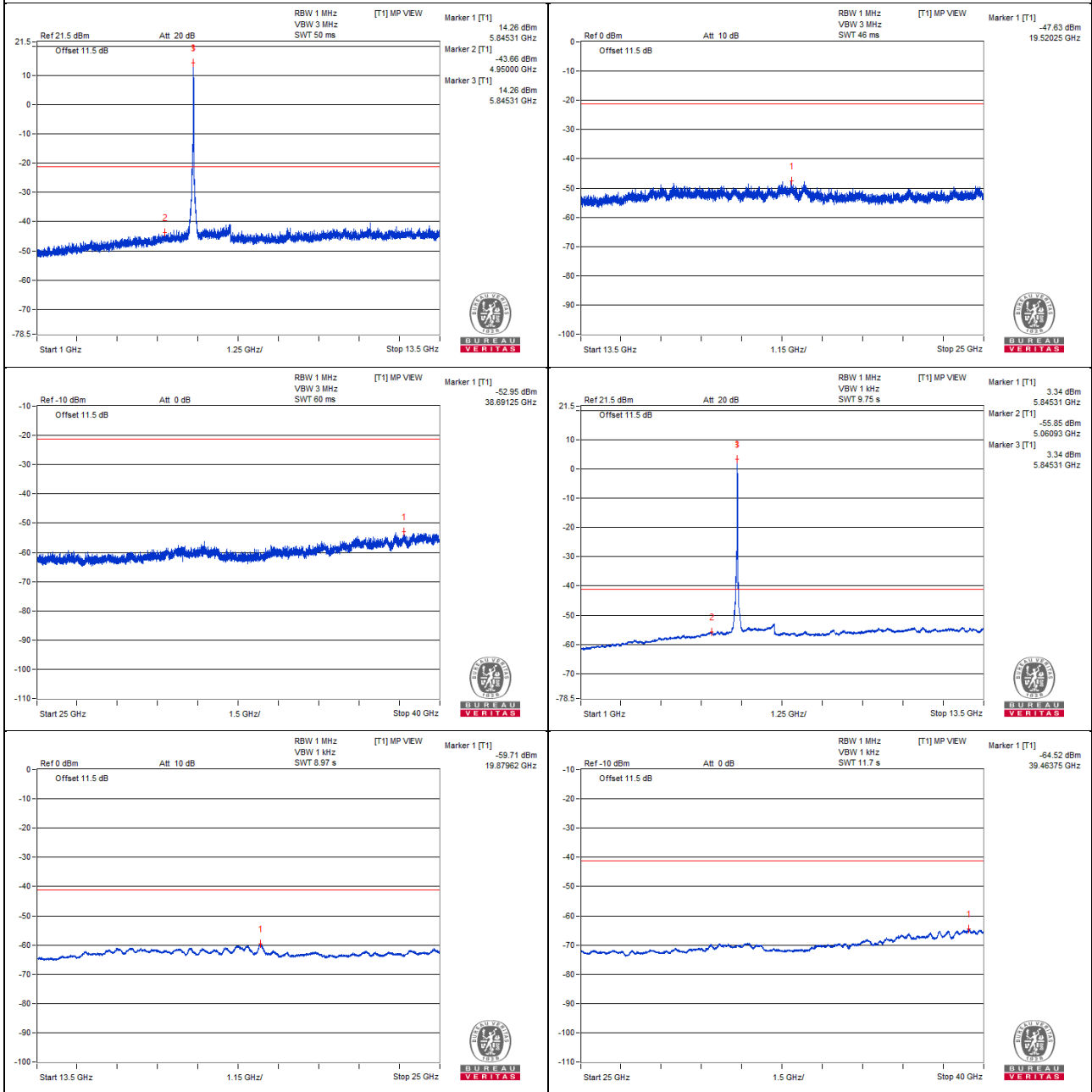

Chain 1

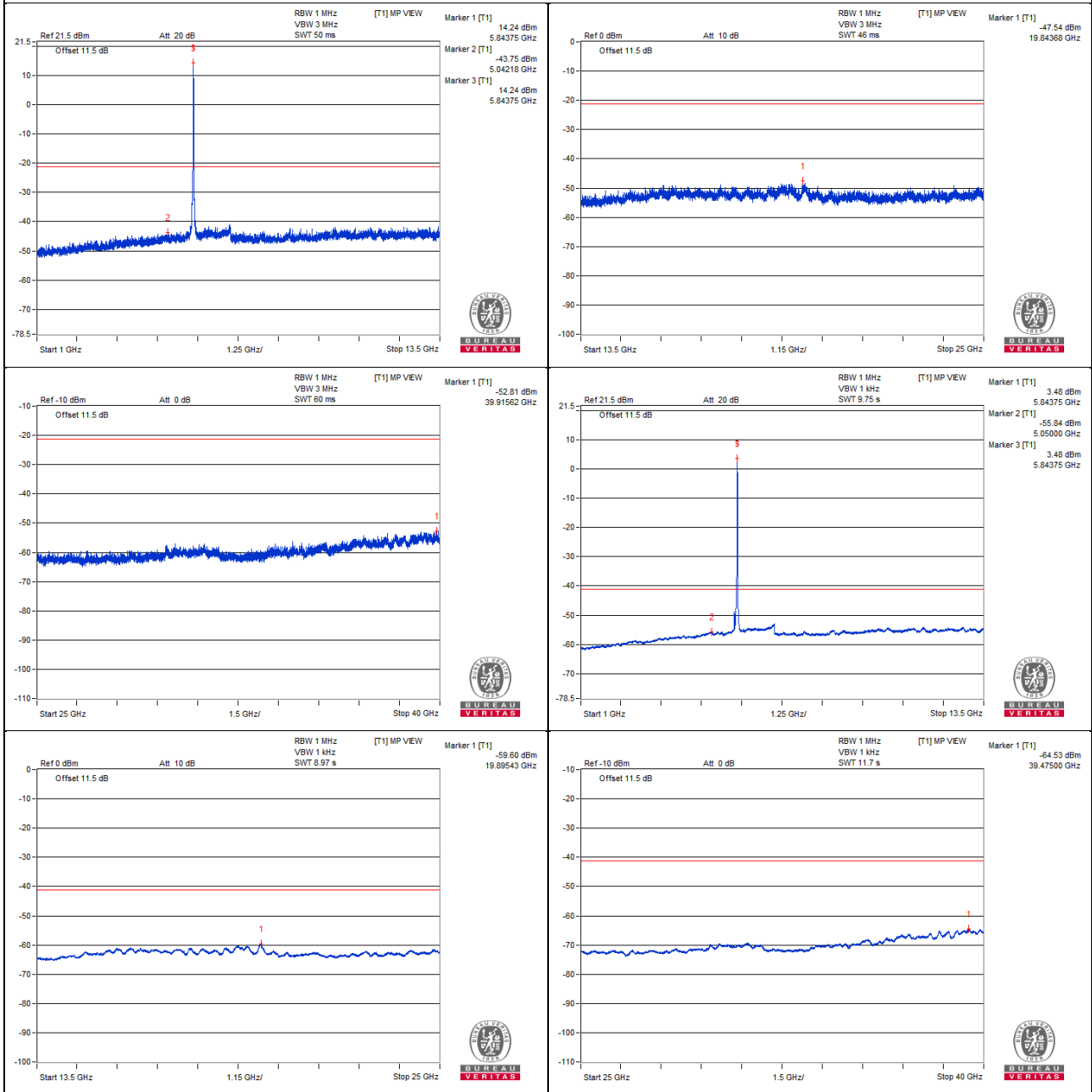

Bandedge

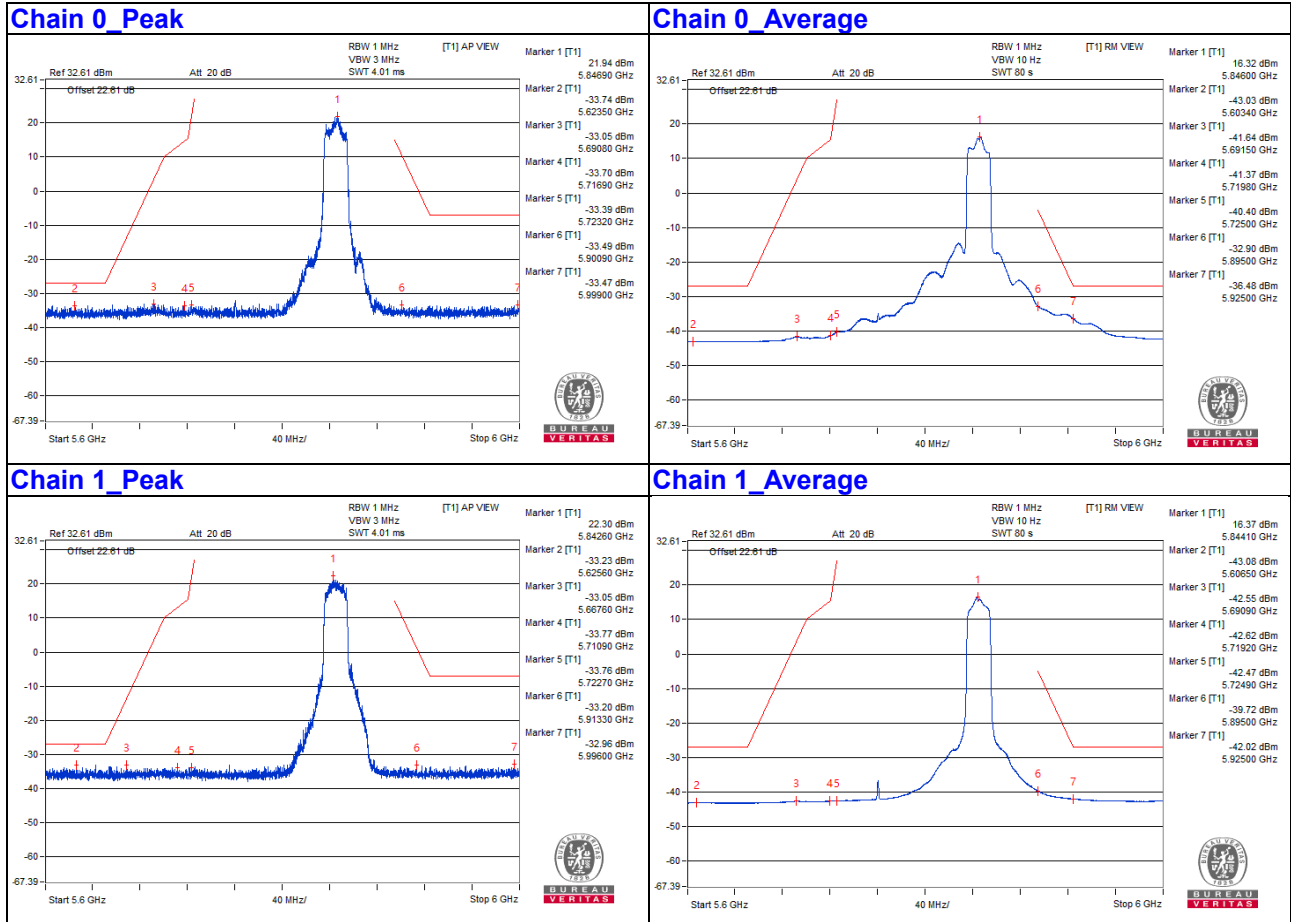

Note:

1. The offset including attenuator (10 dB), cable loss (1.5 dB), directional gain (8.1 dBi) and number of outputs (10 log (2)=3.01 dB).
2. The test results were EIRP.

802.11ax (HE20) - Channel 173

Conducted spurious emission table

No.	Frequency (MHz)	Emission Level (dBuV/m)	Limit (dBuV/m)	Margin (dB)	Raw Value (dBm)		Correction Factor (dB)	EIRP Level (dBm)
					Chain0	Chain1		
1	3928.12	60.45 PK	74	-13.55	-46.07	-45.92	8.17	-34.81
2	3896.87	48.72 AV	54	-5.28	-57.75	-57.7	8.17	-46.54
3	#7826.56	61.22 PK	68.2	-6.98	-46.16	-44.45	8.17	-34.04
4	11750	62.95 PK	74	-11.05	-42.94	-44.13	8.17	-32.31
5	11729.68	51.16 AV	54	-2.84	-55.6	-54.99	8.17	-44.10
6	#17583.93	55.15 PK	68.2	-13.05	-51.96	-50.71	8.17	-40.11

Remarks:

1. Margin value = Emission Level – Limit value
2. The other emission levels were very low against the limit.
3. " # " : The frequency is out of the restricted band.

Chain 0

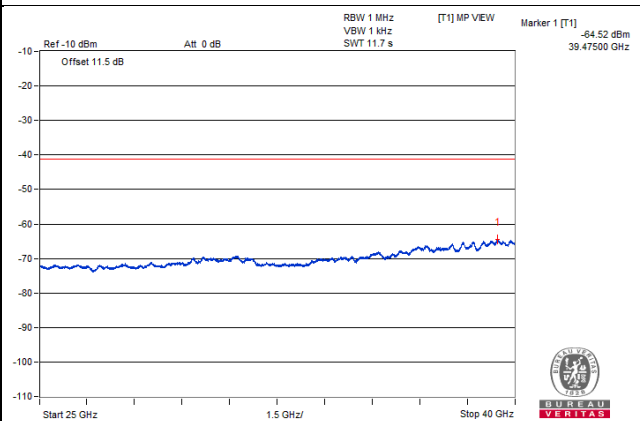
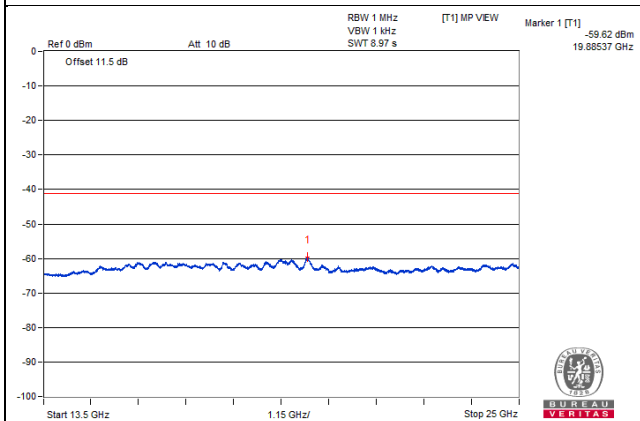
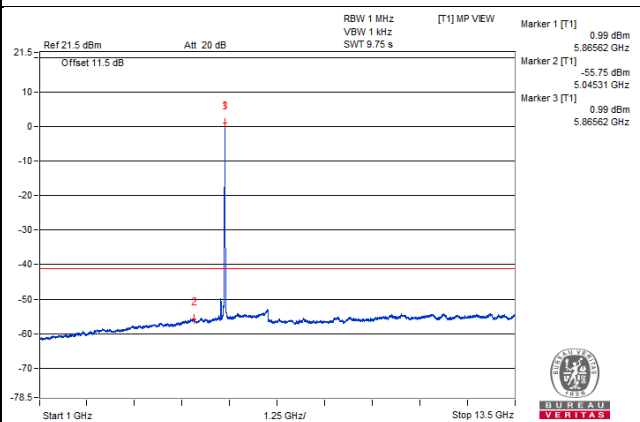
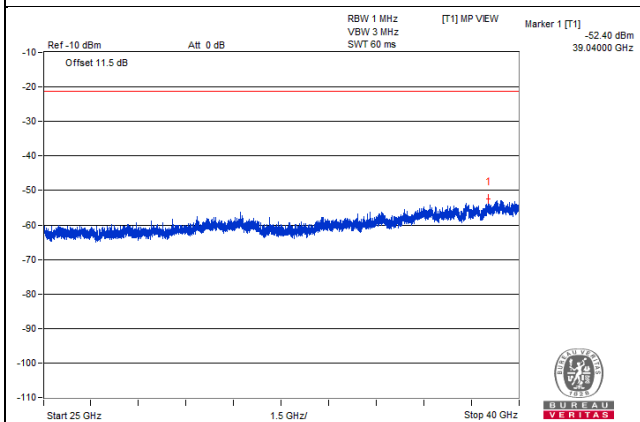
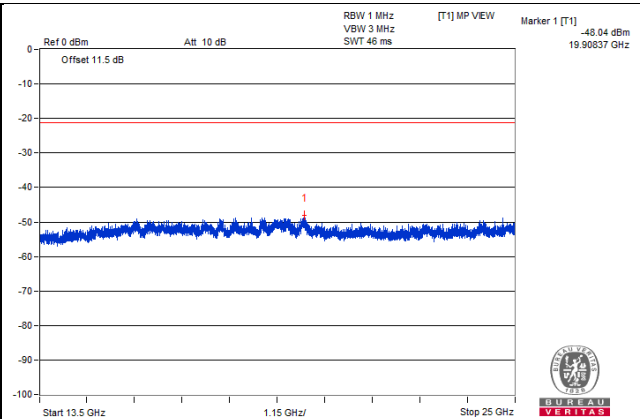
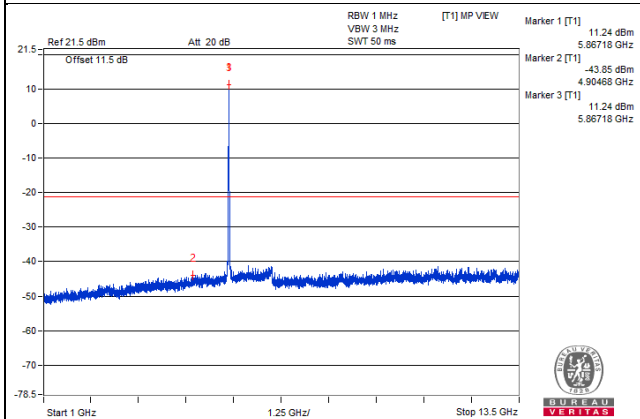

Chain 1

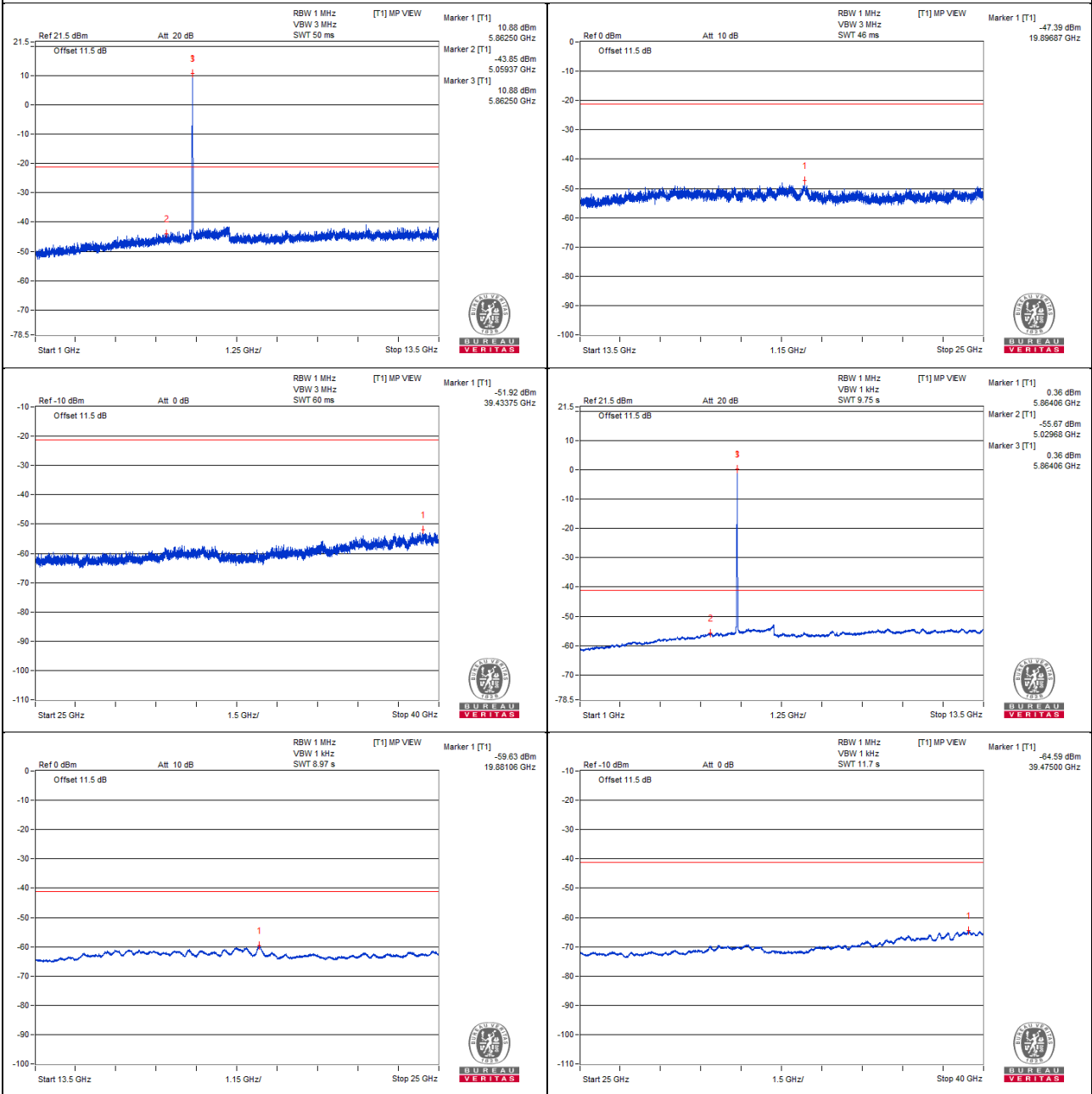

Bandedge

Chain 0_Peak

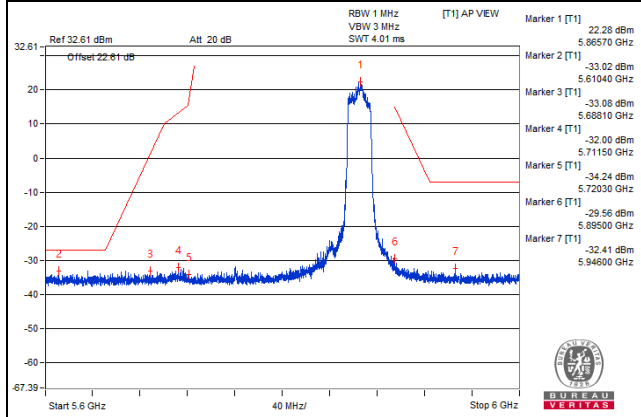

Chain 0_Average

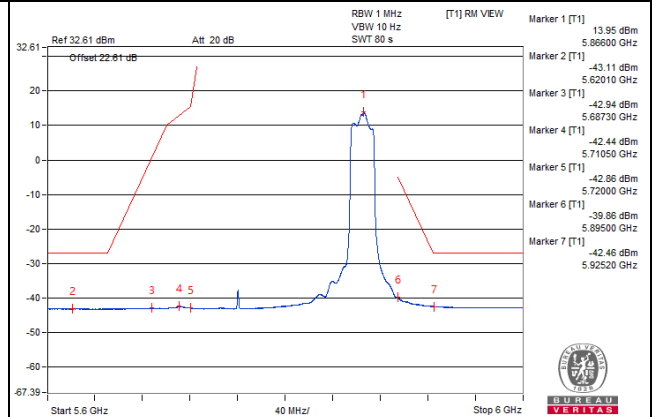

Chain 1_Peak

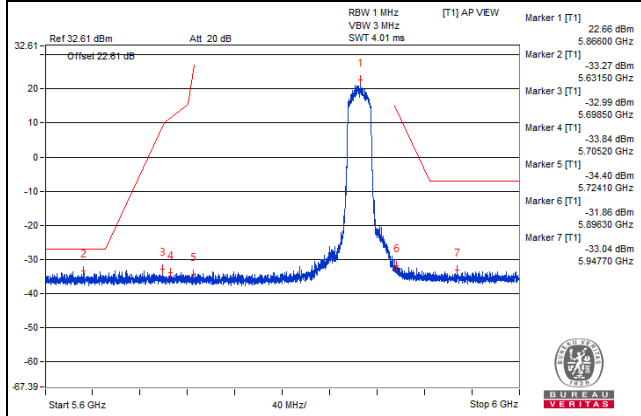

Chain 1_Average

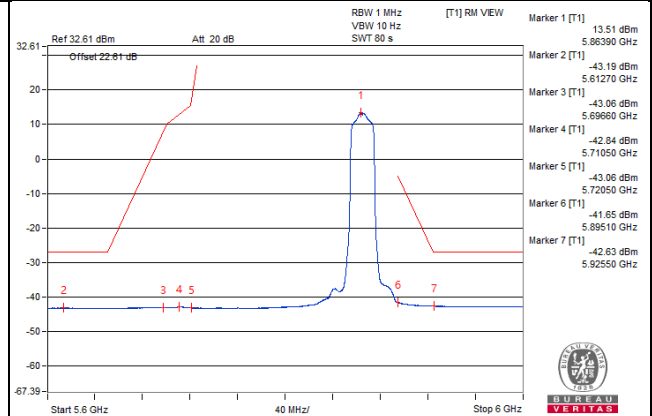

Note:

1. The offset including attenuator (10 dB), cable loss (1.5 dB), directional gain (8.1 dBi) and number of outputs ($10 \log(2) = 3.01$ dB).
2. The test results were EIRP.

802.11ax (HE20) - Channel 177

Conducted spurious emission table

No.	Frequency (MHz)	Emission Level (dBuV/m)	Limit (dBuV/m)	Margin (dB)	Raw Value (dBm)		Correction Factor (dB)	EIRP Level (dBm)
					Chain0	Chain1		
1	3918.75	60.64 PK	74	-13.36	-44.46	-47.76	8.17	-34.62
2	3940.62	48.78 AV	54	-5.22	-57.61	-57.71	8.17	-46.48
3	#7854.68	61.54 PK	68.2	-6.66	-44.64	-45.18	8.17	-33.72
4	11753.12	62.25 PK	74	-11.75	-43.66	-44.8	8.17	-33.01
5	11771.87	51.01 AV	54	-2.99	-55.27	-55.6	8.17	-44.25
6	#17661.56	55.33 PK	68.2	-12.87	-51.13	-51.1	8.17	-39.93

Remarks:

1. Margin value = Emission Level – Limit value
2. The other emission levels were very low against the limit.
3. " # " : The frequency is out of the restricted band.

Chain 0

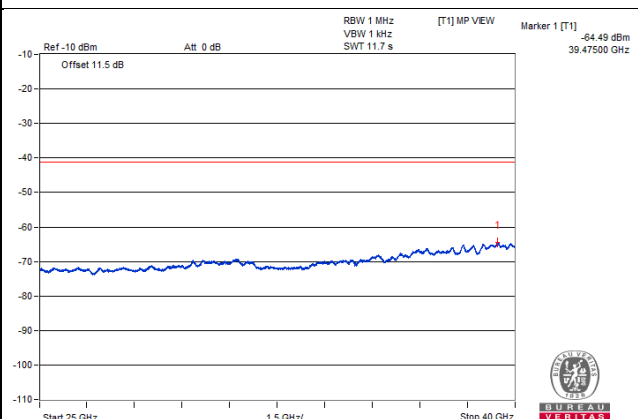
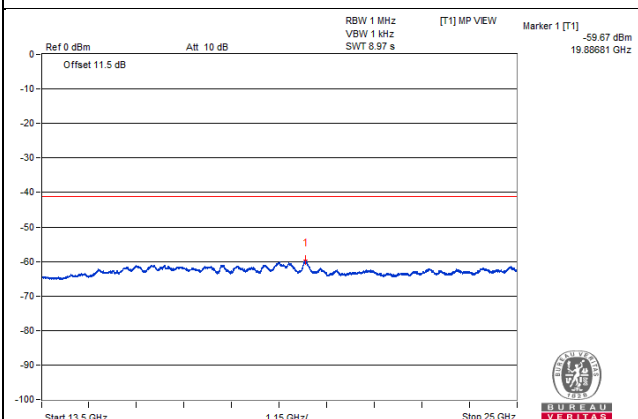
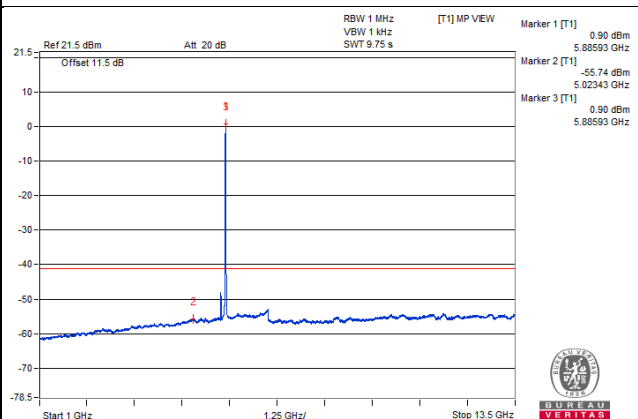
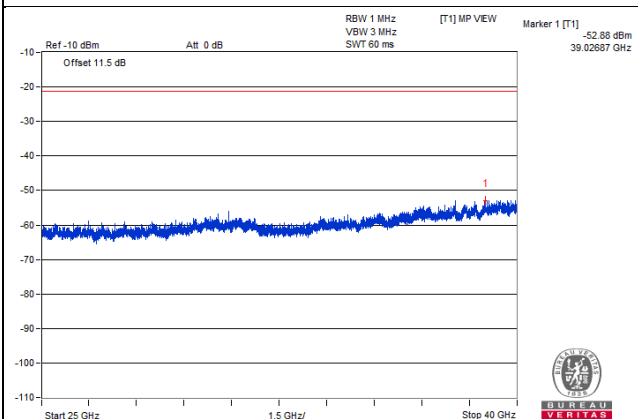
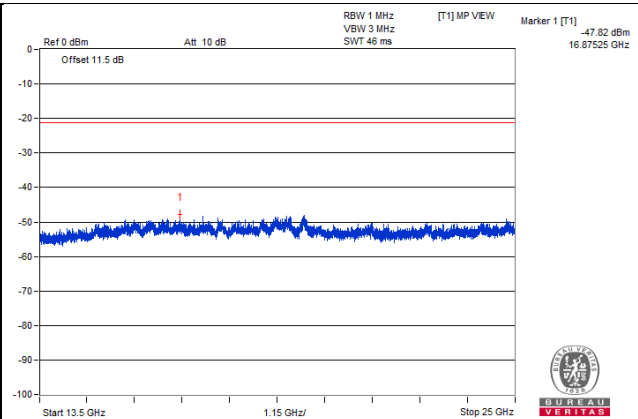
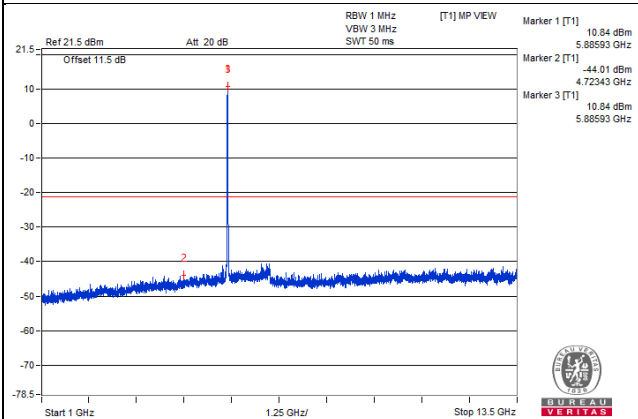

Chain 1

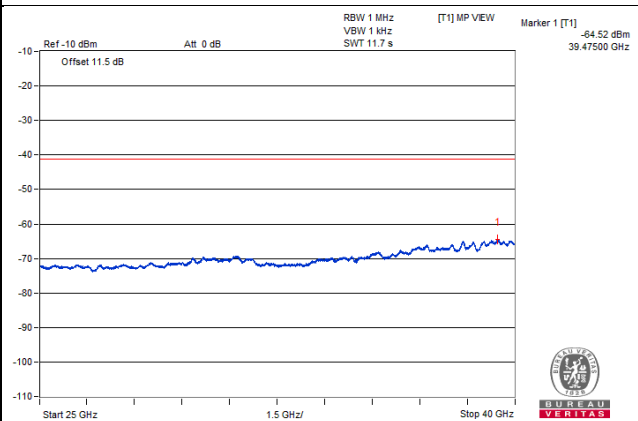
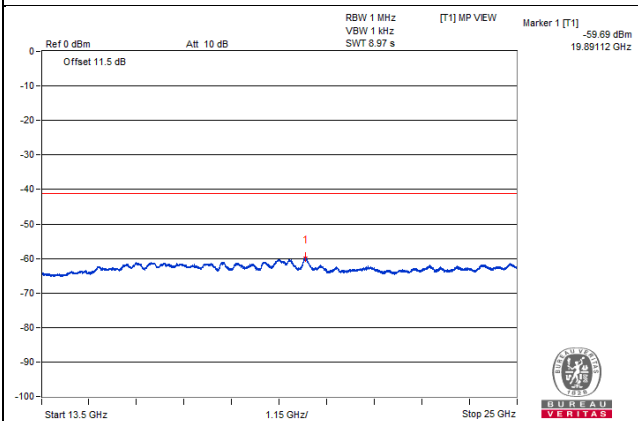
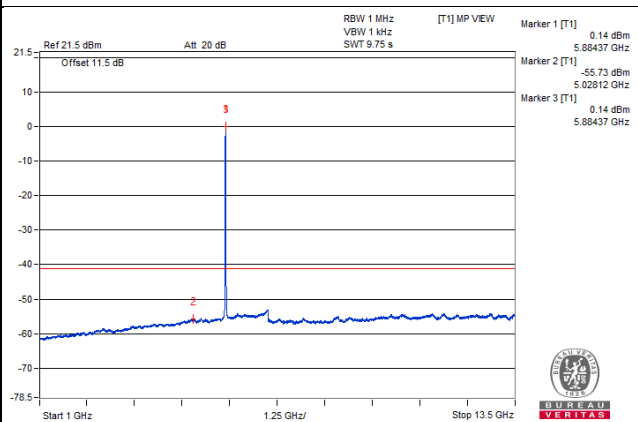
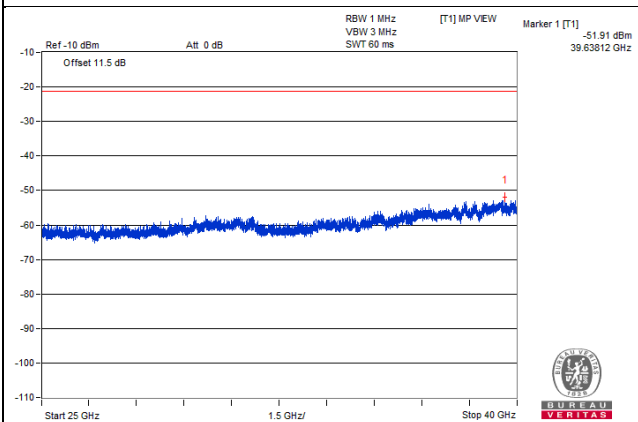
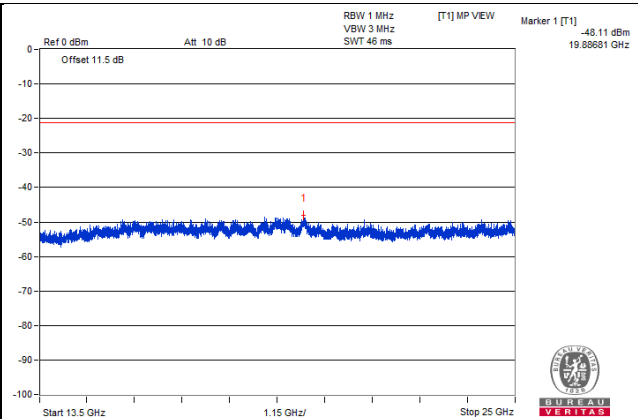
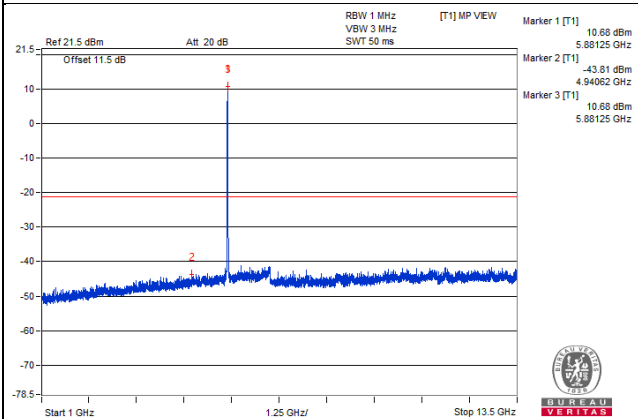

Bandedge

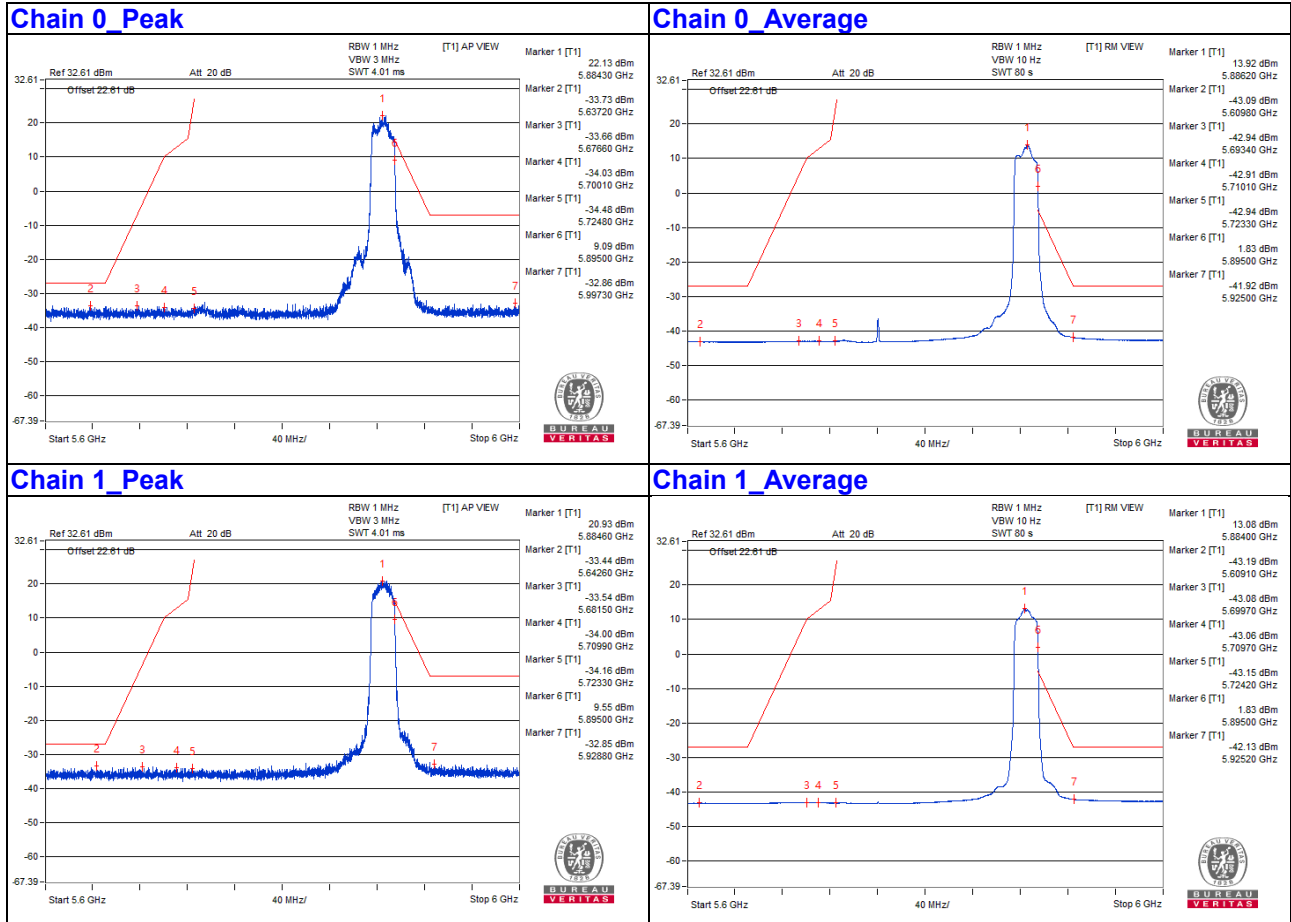

Note:

1. The offset including attenuator (10 dB), cable loss (1.5 dB), directional gain (8.1 dBi) and number of outputs (10 log (2))=3.01 dB).
2. The test results were EIRP.
3. The emission was verified and the test result was passed by radiated measurement. (Please refer Appendix A)

802.11ax (HE40) - Channel 167

Conducted spurious emission table

No.	Frequency (MHz)	Emission Level (dBuV/m)	Limit (dBuV/m)	Margin (dB)	Raw Value (dBm)		Correction Factor (dB)	EIRP Level (dBm)
					Chain0	Chain1		
1	3876.56	60.32 PK	74	-13.68	-44.95	-47.73	8.17	-34.94
2	3875	48.68 AV	54	-5.32	-57.73	-57.79	8.17	-46.58
3	#7760.93	61.16 PK	68.2	-7.04	-45	-45.57	8.17	-34.10
4	11653.12	63.63 PK	74	-10.37	-42.66	-42.96	8.17	-31.63
5	11660.93	52.11 AV	54	-1.89	-54.56	-54.11	8.17	-43.15
6	#17504.87	56.26 PK	68.2	-11.94	-51.93	-48.93	8.17	-39.00

Remarks:

1. Margin value = Emission Level – Limit value
2. The other emission levels were very low against the limit.
3. " # " : The frequency is out of the restricted band.

Chain 0

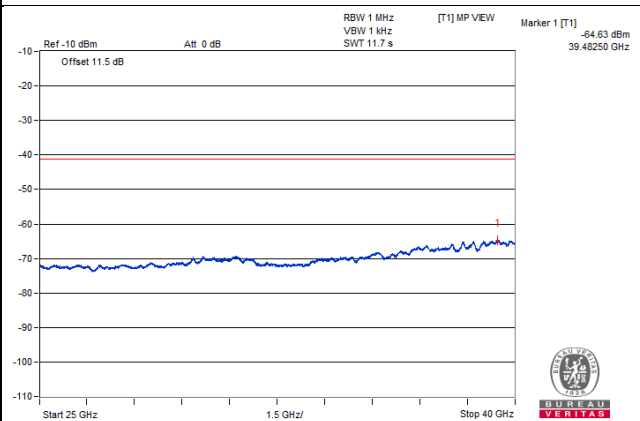
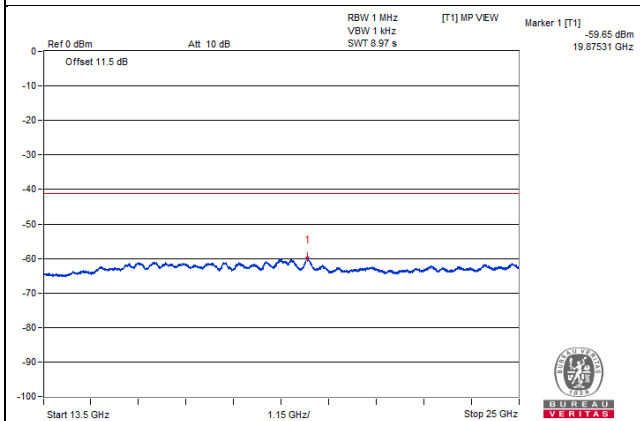
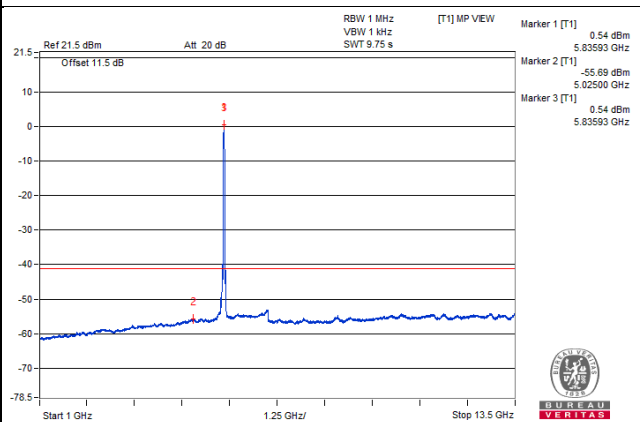
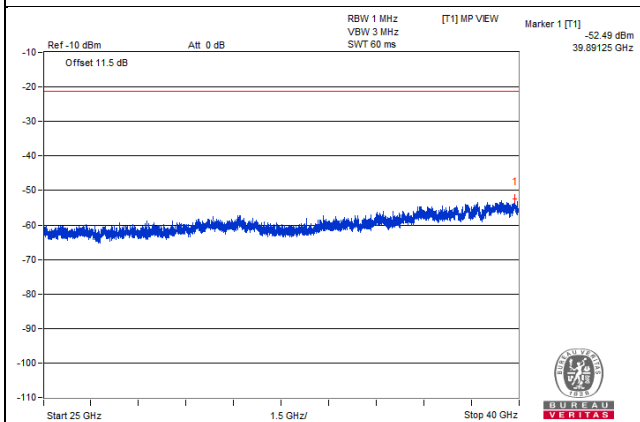
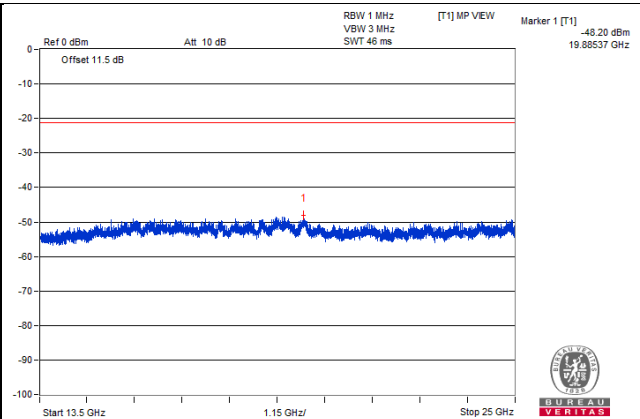
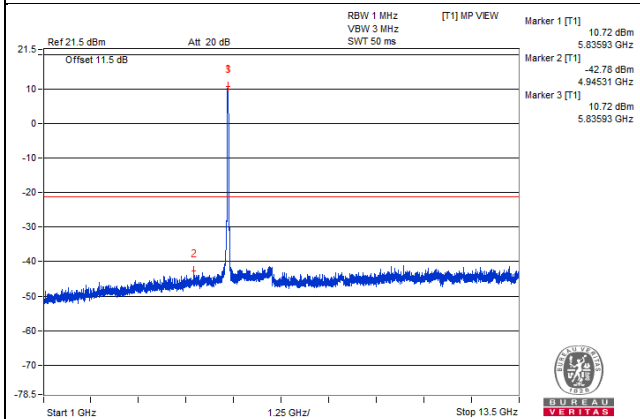

Chain 1

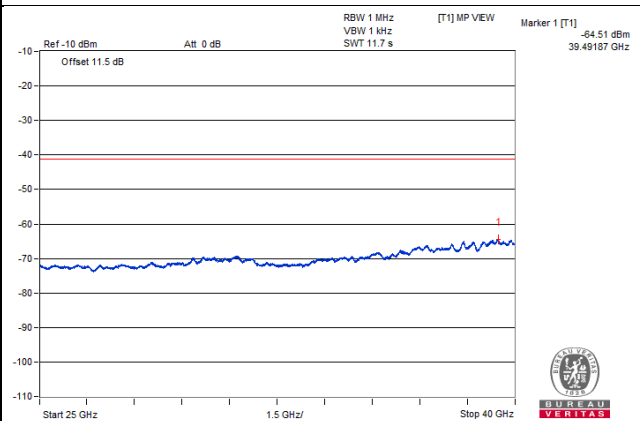
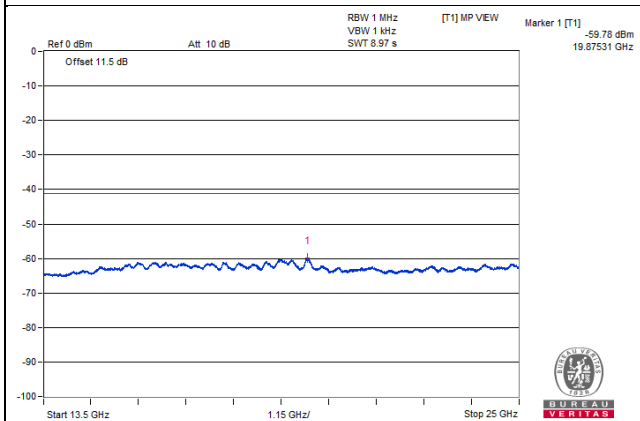
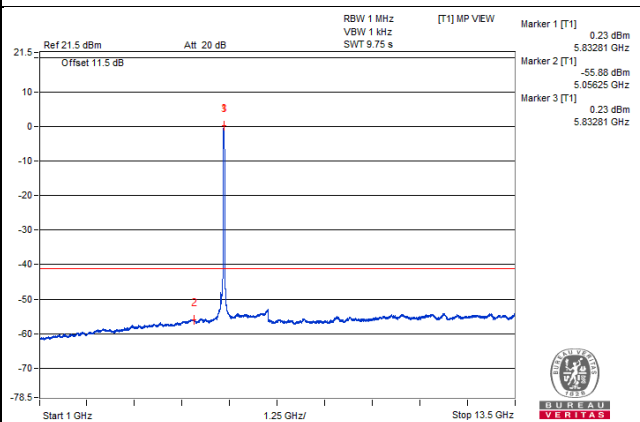
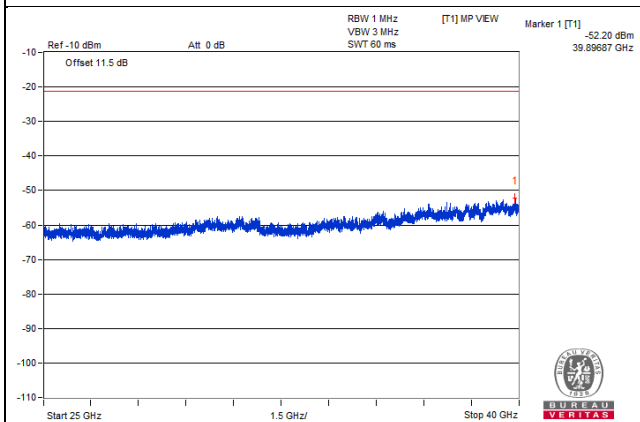
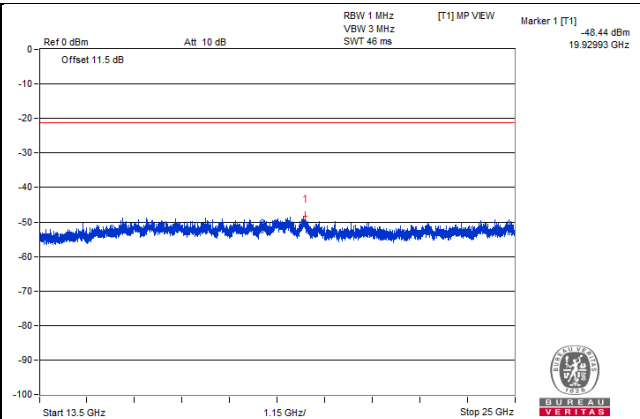
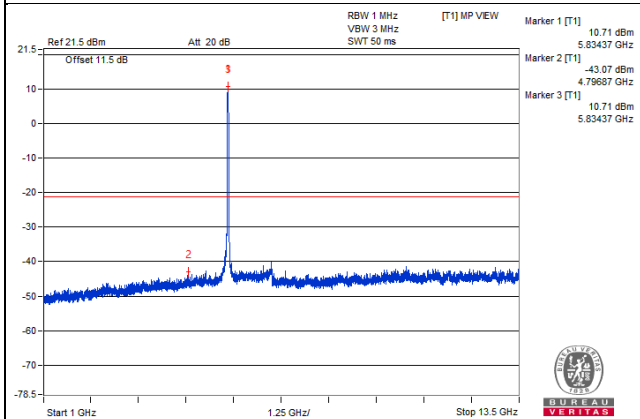

Bandedge

Chain 0_Peak

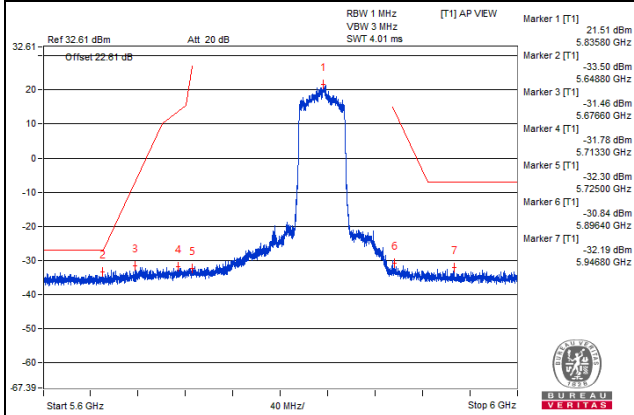

Chain 0_Average

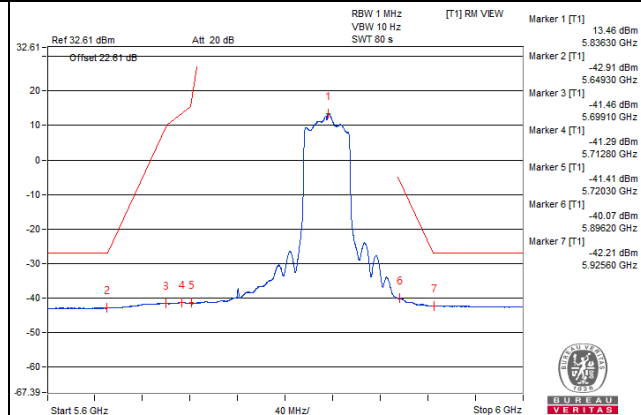

Chain 1_Peak

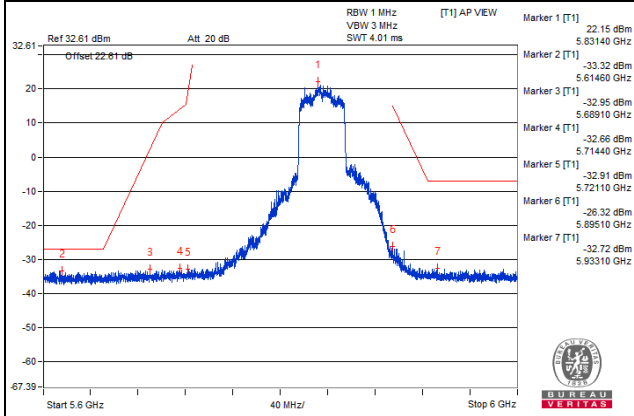

Chain 1_Average

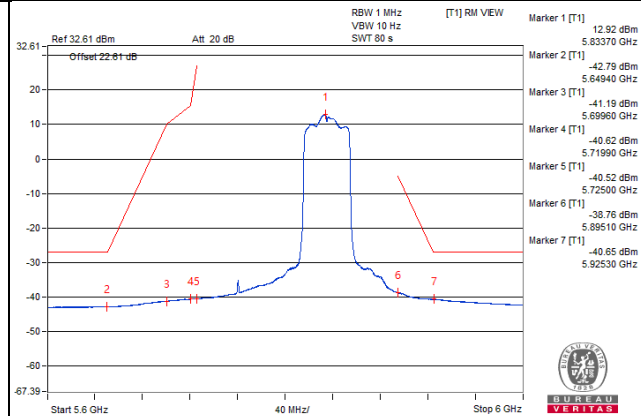

Note:

1. The offset including attenuator (10 dB), cable loss (1.5 dB), directional gain (8.1 dBi) and number of outputs ($10 \log(2) = 3.01$ dB).
2. The test results were EIRP.

802.11ax (HE40) - Channel 175

Conducted spurious emission table

No.	Frequency (MHz)	Emission Level (dBuV/m)	Limit (dBuV/m)	Margin (dB)	Raw Value (dBm)		Correction Factor (dB)	EIRP Level (dBm)
					Chain0	Chain1		
1	3925	60.23 PK	74	-13.77	-47.35	-45.31	8.17	-35.03
2	3915.62	48.87 AV	54	-5.13	-57.69	-57.46	8.17	-46.39
3	#7846.87	61.13 PK	68.2	-7.07	-46.08	-44.66	8.17	-34.13
4	11757.81	62.27 PK	74	-11.73	-44.4	-43.95	8.17	-32.99
5	11739.06	51.03 AV	54	-2.97	-55.42	-55.41	8.17	-44.23
6	#17642.87	55.27 PK	68.2	-12.93	-50.32	-52.23	8.17	-39.99

Remarks:

1. Margin value = Emission Level – Limit value
2. The other emission levels were very low against the limit.
3. " # " : The frequency is out of the restricted band.

Chain 0

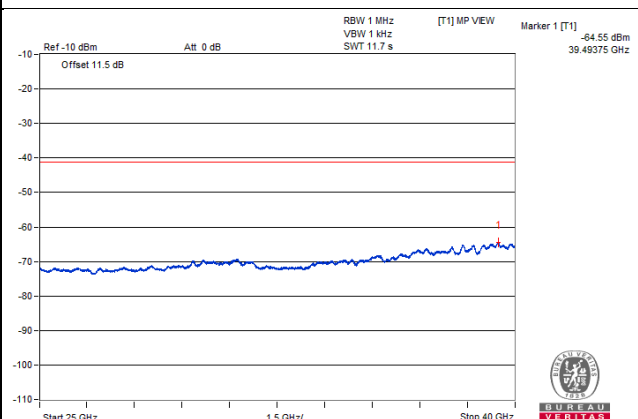
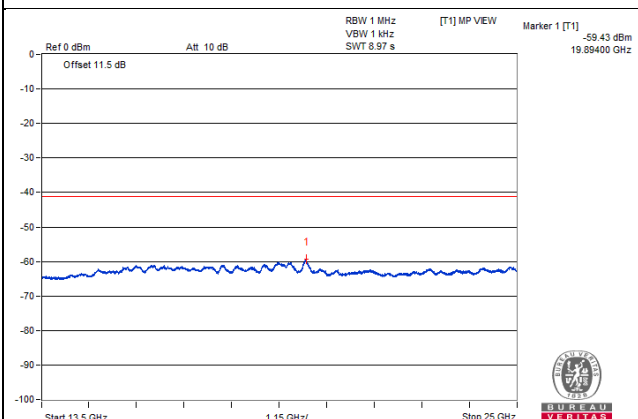
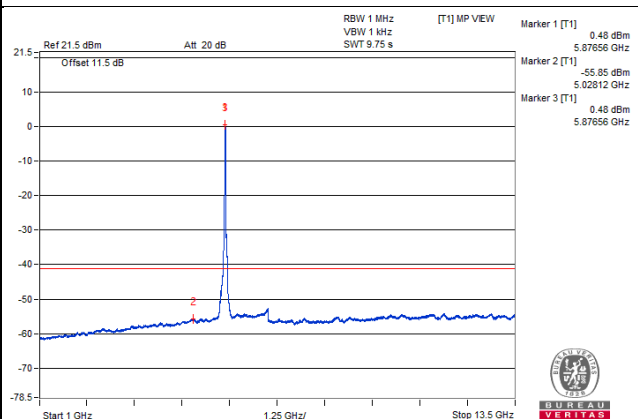
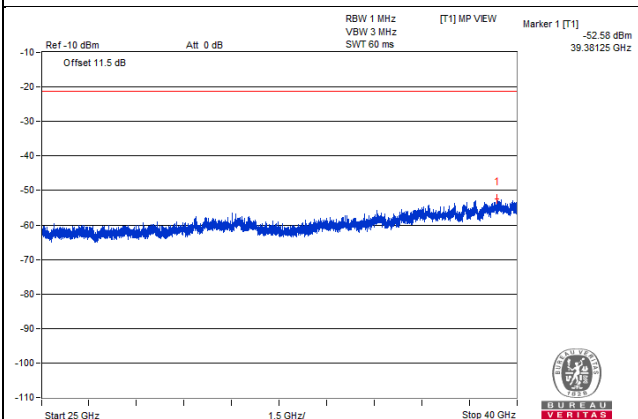
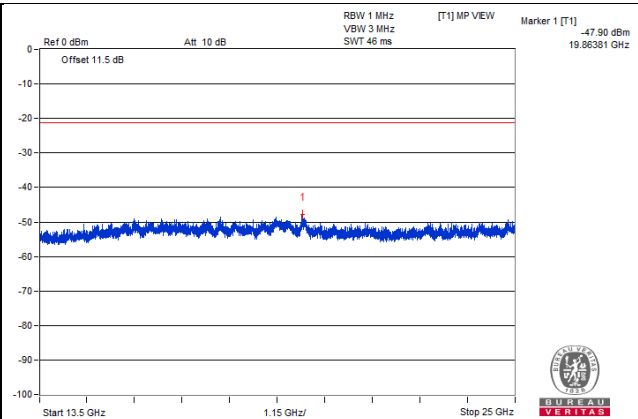
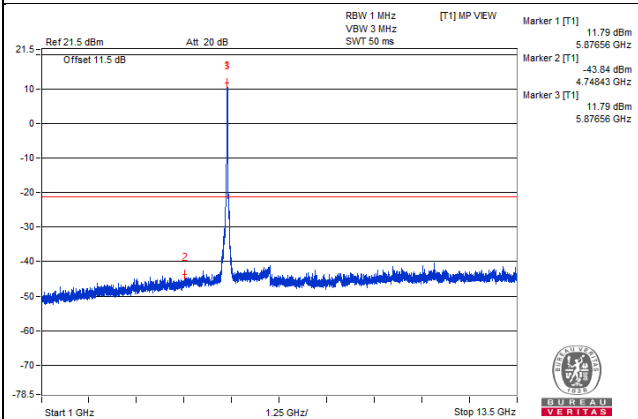

Chain 1

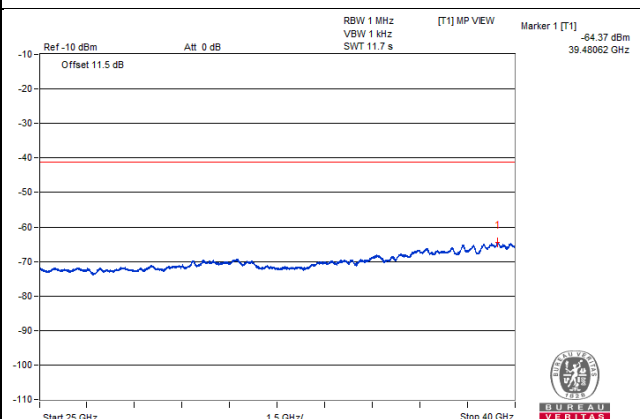
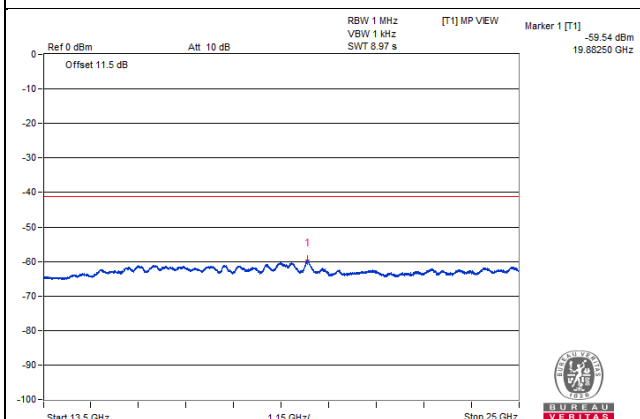
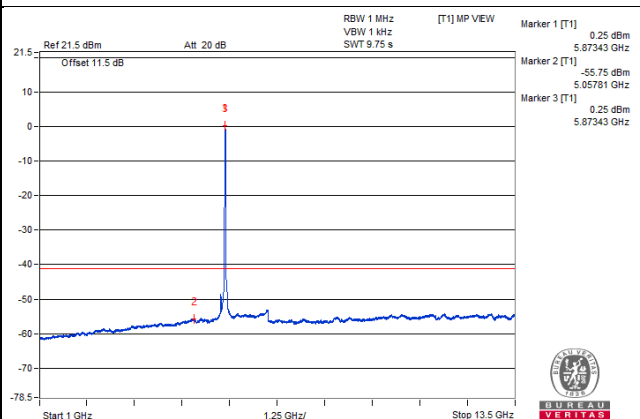
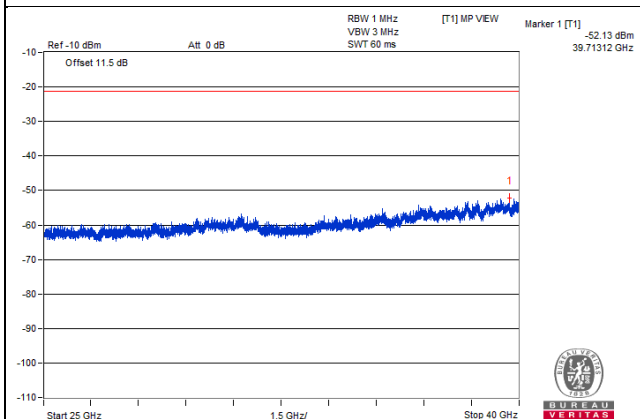
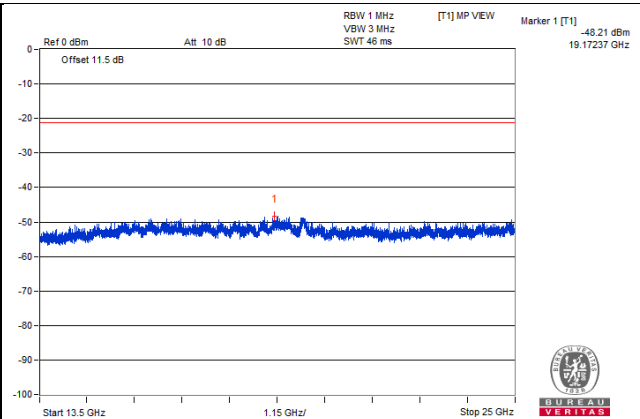
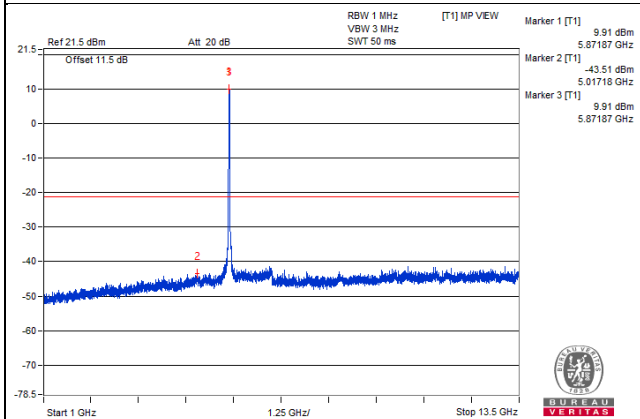

Bandedge

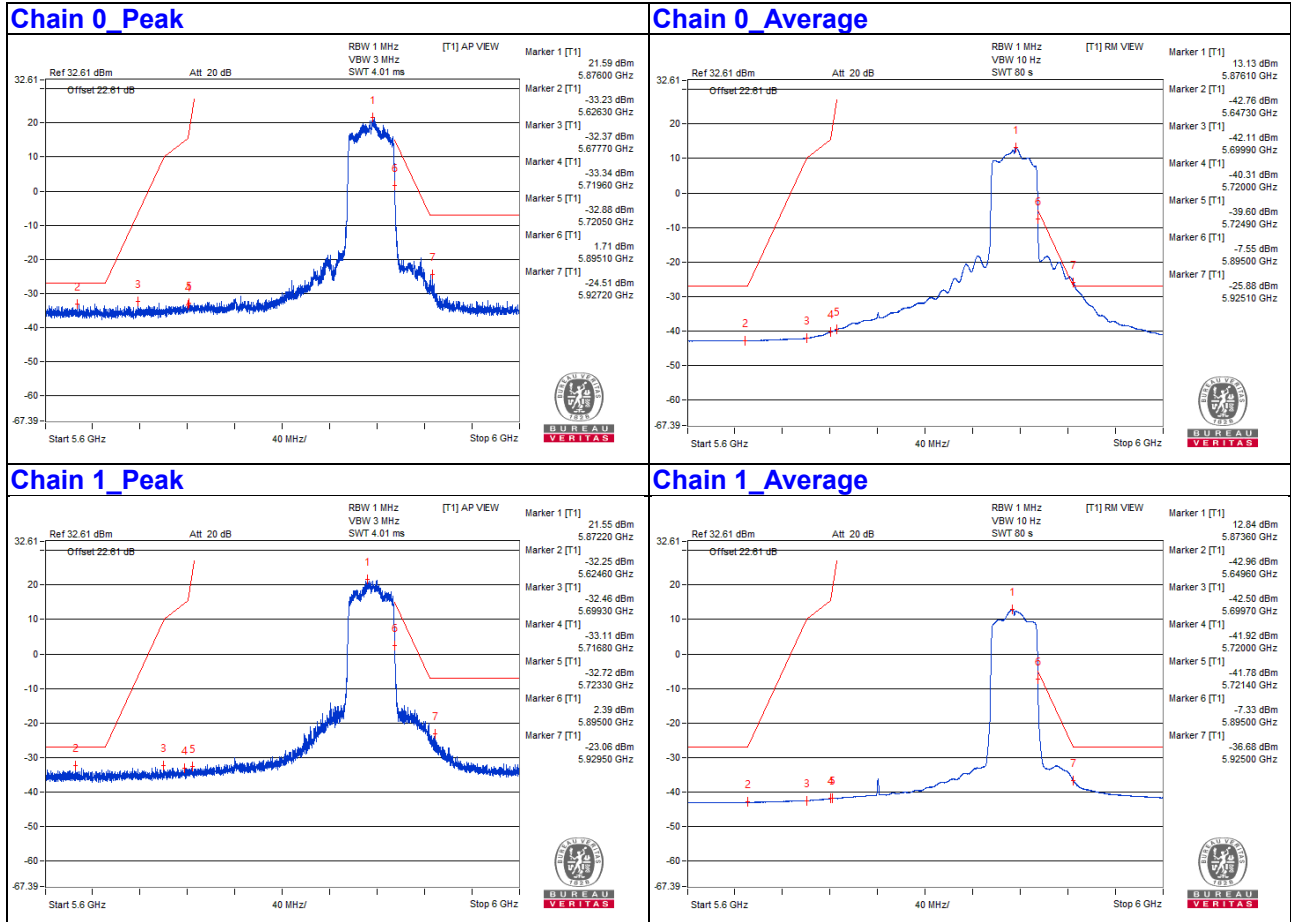

Note:

1. The offset including attenuator (10 dB), cable loss (1.5 dB), directional gain (8.1 dBi) and number of outputs (10 log (2)=3.01 dB).
2. The test results were EIRP.
3. The emission was verified and the test result was passed by radiated measurement. (Please refer Appendix A)

802.11ax (HE80) - Channel 171

Conducted spurious emission table

No.	Frequency (MHz)	Emission Level (dBuV/m)	Limit (dBuV/m)	Margin (dB)	Raw Value (dBm)		Correction Factor (dB)	EIRP Level (dBm)
					Chain0	Chain1		
1	3917.18	60.49 PK	74	-13.51	-46.59	-45.39	8.17	-34.77
2	3910.93	48.8 AV	54	-5.2	-57.54	-57.74	8.17	-46.46
3	#7807.81	61.86 PK	68.2	-6.34	-44.65	-44.51	8.17	-33.40
4	11693.75	63.63 PK	74	-10.37	-43.42	-42.28	8.17	-31.63
5	11692.18	51.65 AV	54	-2.35	-54.57	-55.02	8.17	-43.61
6	#17552.31	56.57 PK	68.2	-11.63	-49.7	-50.05	8.17	-38.69

Remarks:

1. Margin value = Emission Level – Limit value
2. The other emission levels were very low against the limit.
3. " # " : The frequency is out of the restricted band.

Chain 0

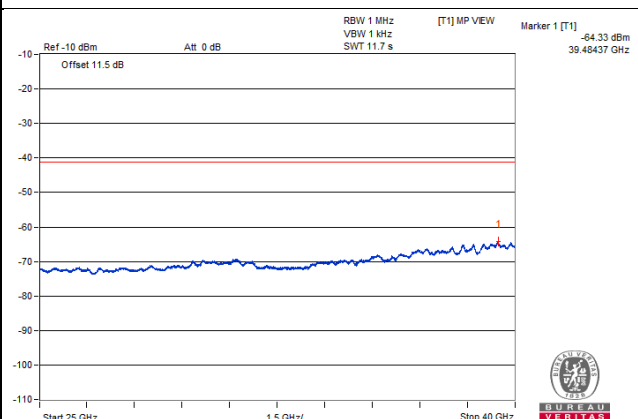
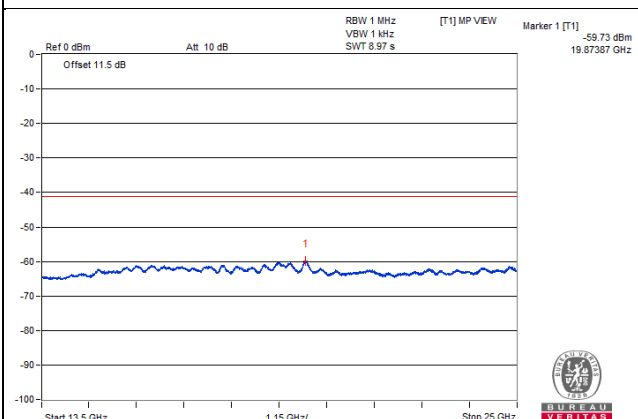
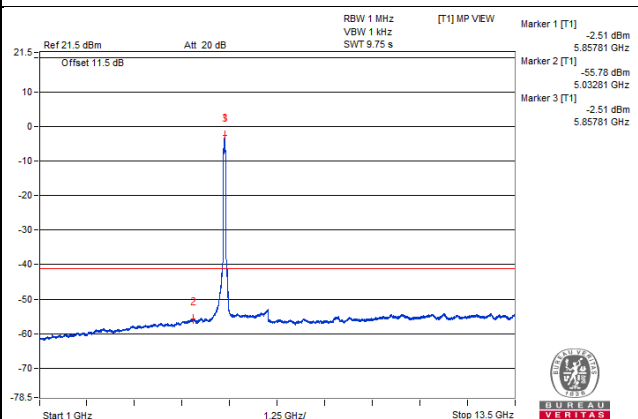
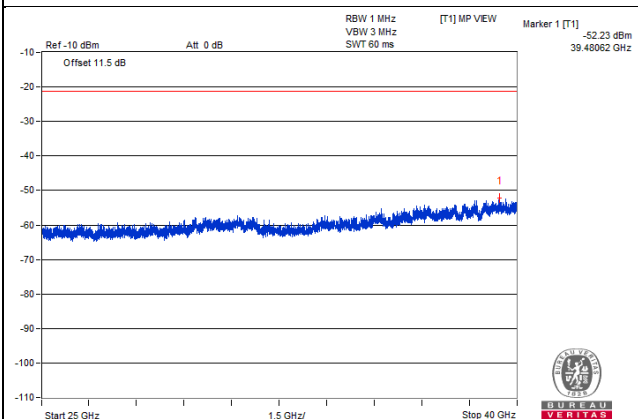
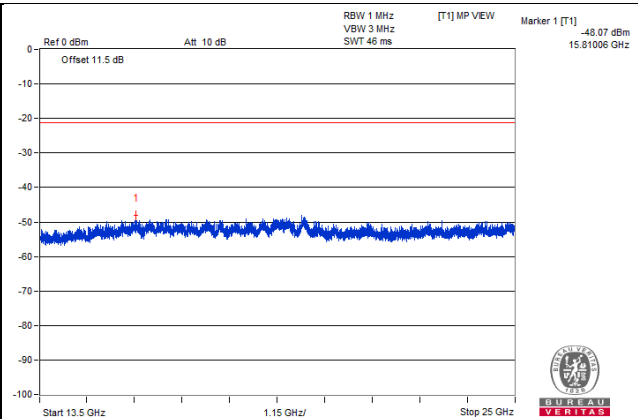
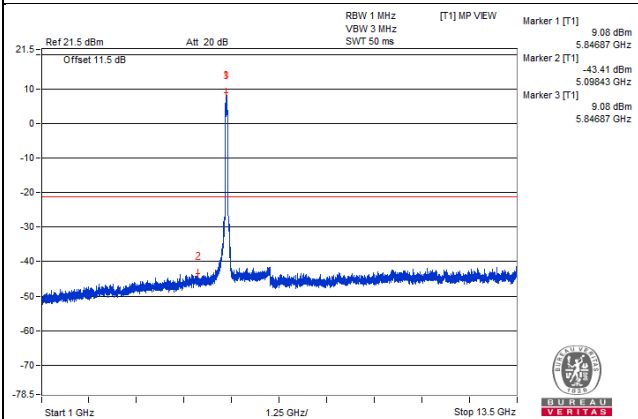

Chain 1

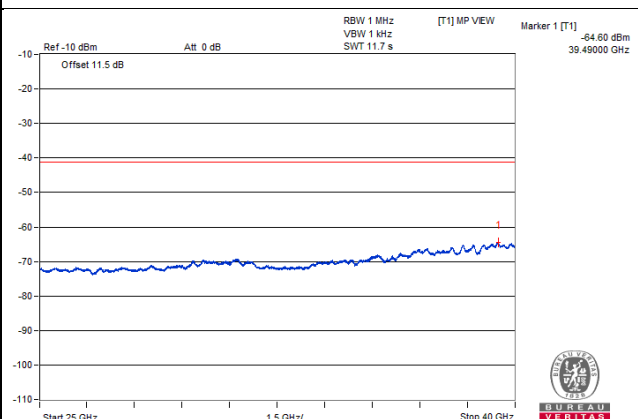
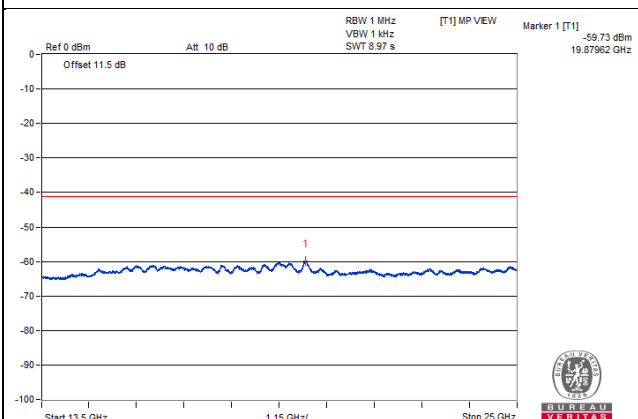
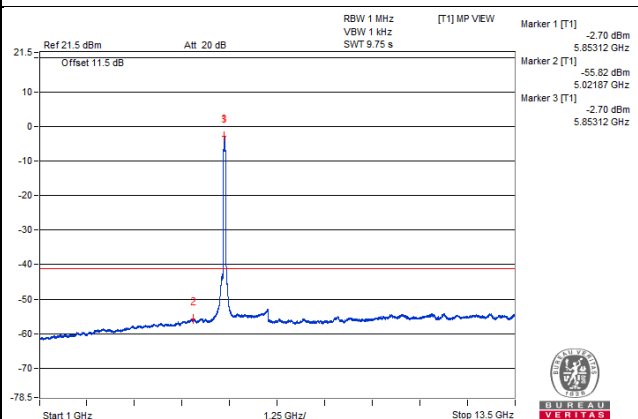
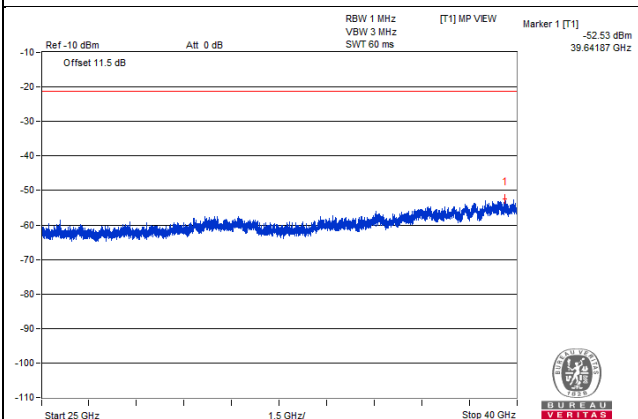
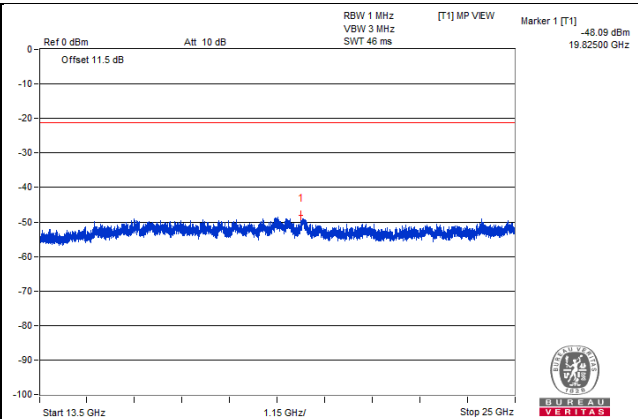
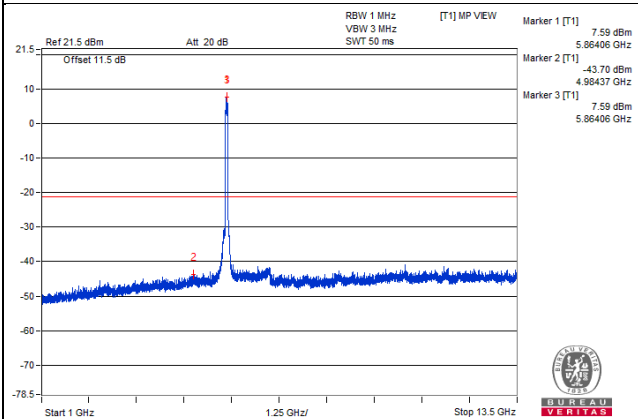

Bandedge

Chain 0_Peak

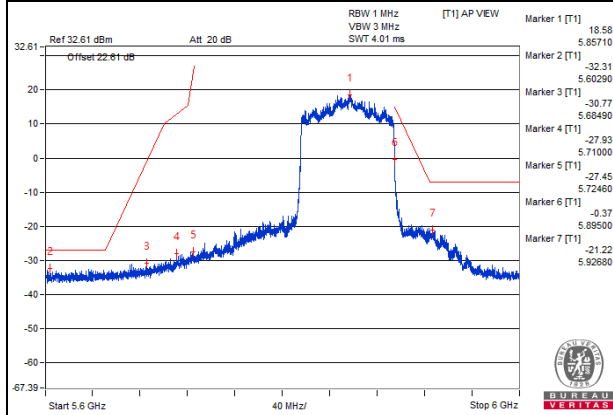

Chain 0_Average

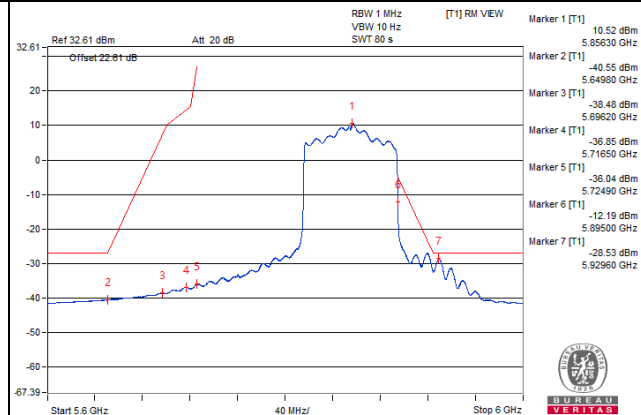

Chain 1_Peak

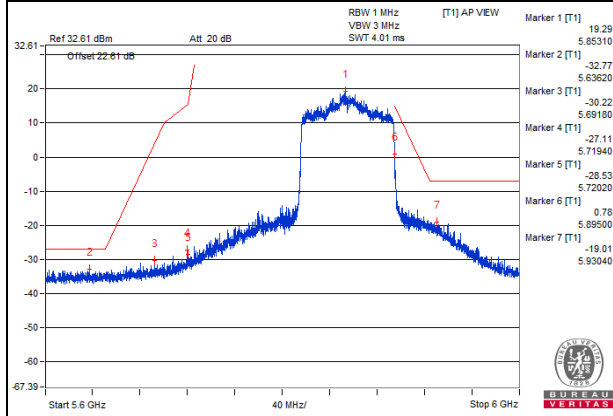

Chain 1_Average

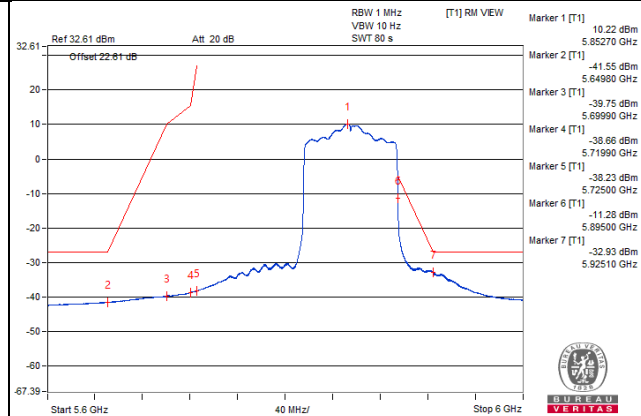

Note:

1. The offset including attenuator (10 dB), cable loss (1.5 dB), directional gain (8.1 dBi) and number of outputs ($10 \log(2)=3.01$ dB).
2. The test results were EIRP.

802.11ax (HE160) - Channel 163

Conducted spurious emission table

No.	Frequency (MHz)	Emission Level (dBuV/m)	Limit (dBuV/m)	Margin (dB)	Raw Value (dBm)		Correction Factor (dB)	EIRP Level (dBm)
					Chain0	Chain1		
1	3865.62	60.44 PK	74	-13.56	-46.01	-46	8.17	-34.82
2	3860.93	48.74 AV	54	-5.26	-57.53	-57.87	8.17	-46.52
3	#7759.37	61.28 PK	68.2	-6.92	-44.88	-45.46	8.17	-33.98
4	11645.31	63.58 PK	74	-10.42	-42.18	-43.67	8.17	-31.68
5	11640.62	52.11 AV	54	-1.89	-54.38	-54.29	8.17	-43.15
6	#17441.62	56.13 PK	68.2	-12.07	-48.85	-52.52	8.17	-39.13

Remarks:

1. Margin value = Emission Level – Limit value
2. The other emission levels were very low against the limit.
3. " # " : The frequency is out of the restricted band.

Chain 0

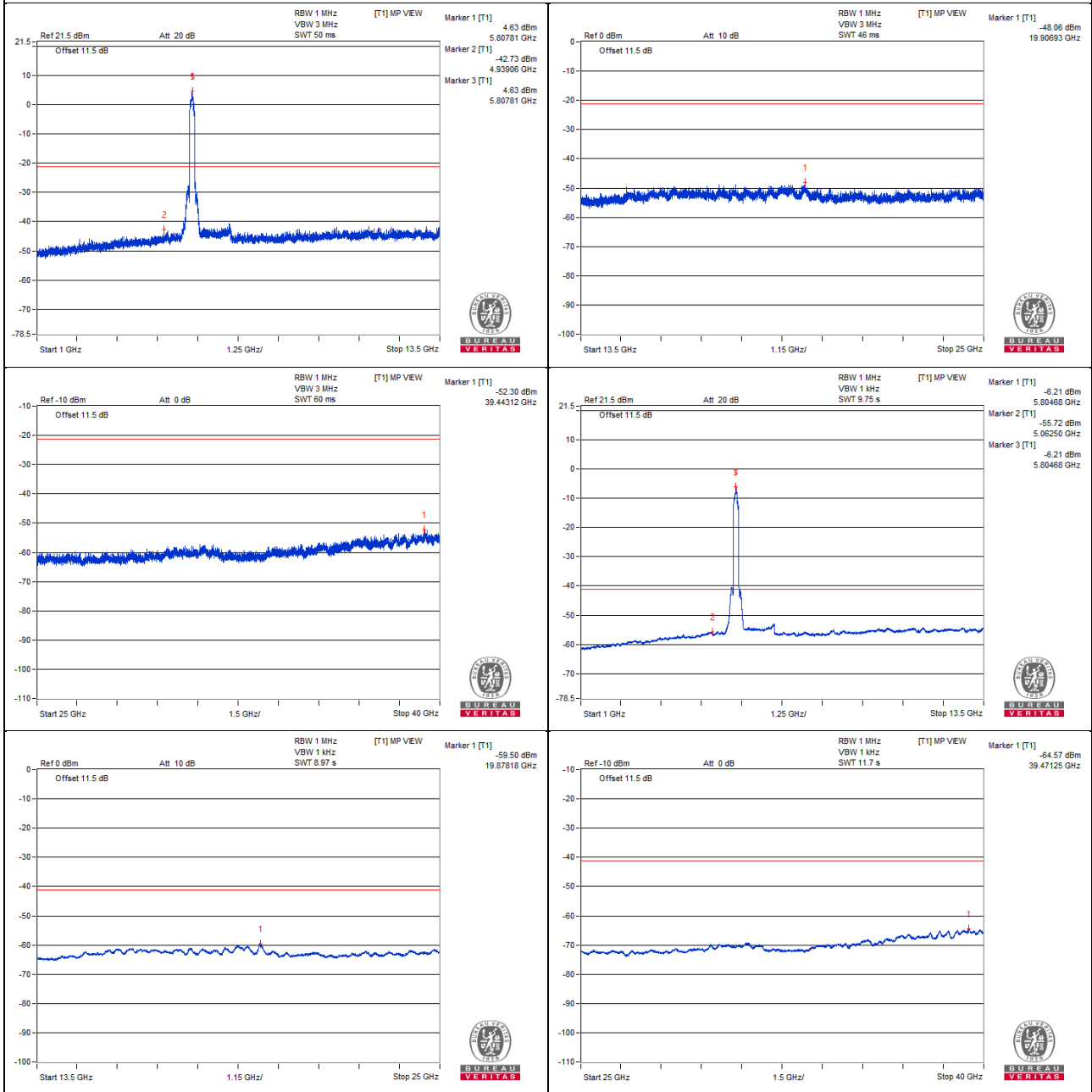

Chain 1

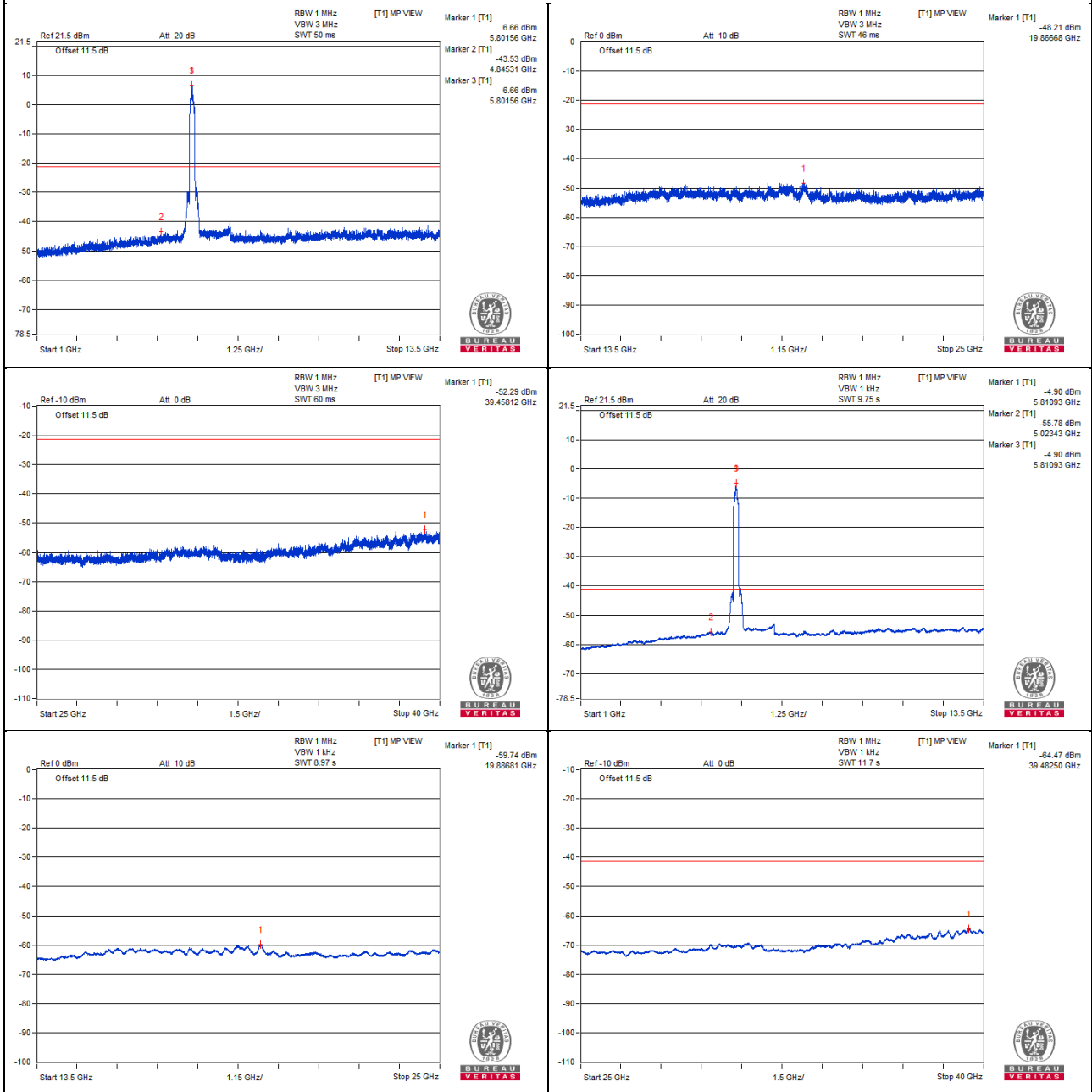

Bandedge

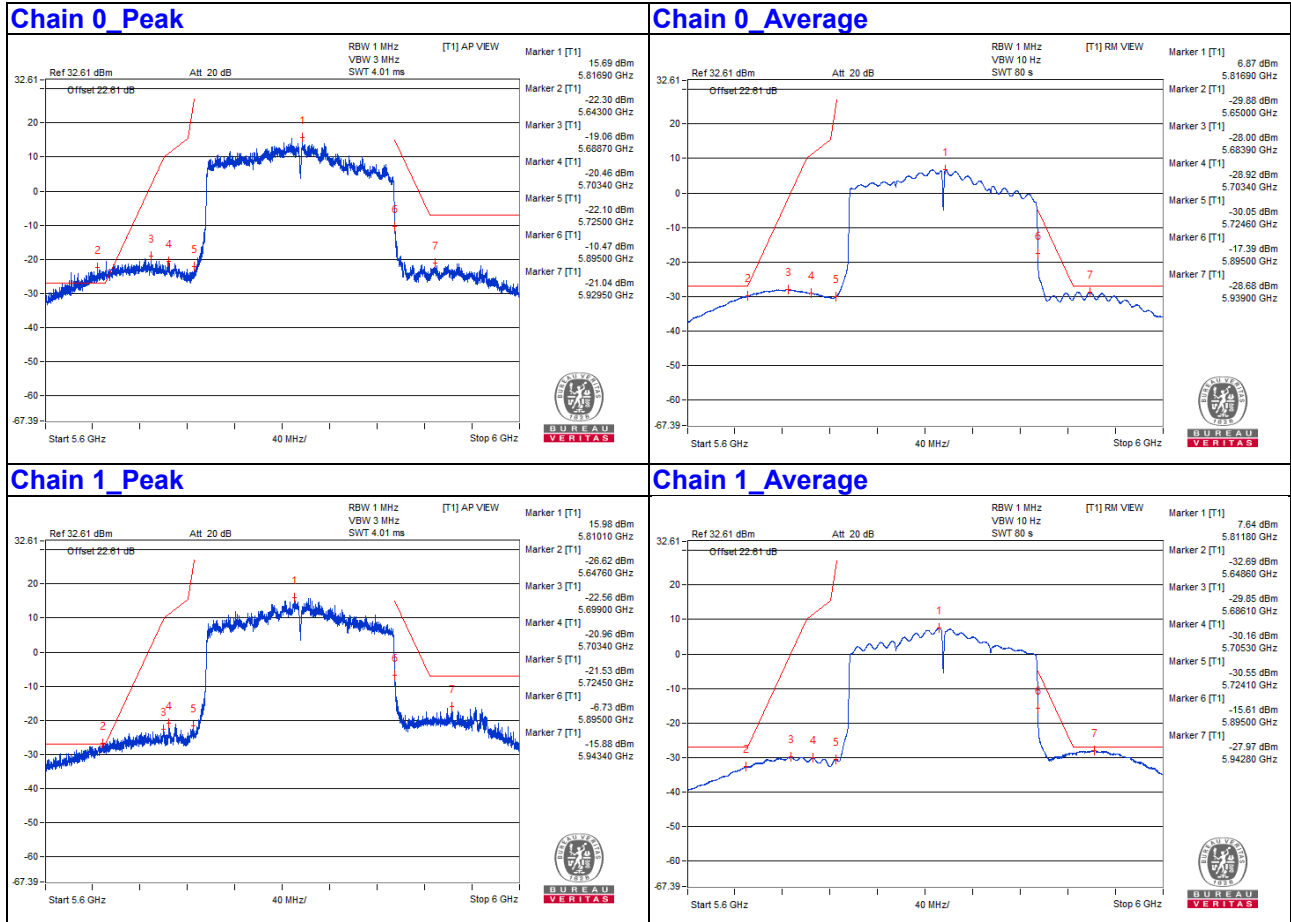

Note:

1. The offset including attenuator (10 dB), cable loss (1.5 dB), directional gain (8.1 dBi) and number of outputs (10 log (2))=3.01 dB).
2. The test results were EIRP.
3. The emission was verified and the test result was passed by radiated measurement. (Please refer Appendix A)

802.11ax (RU26)

Channel 169

Conducted spurious emission table

No.	Frequency (MHz)	Emission Level (dBuV/m)	Limit (dBuV/m)	Margin (dB)	Raw Value (dBm)		Correction Factor (dB)	EIRP Level (dBm)
					Chain0	Chain1		
1	3903.12	60.45 PK	74	-13.55	-44.89	-47.48	8.17	-34.81
2	3893.75	49.02 AV	54	-4.98	-57.57	-57.27	8.17	-46.24
3	#7800	61.47 PK	68.2	-6.73	-45.42	-44.56	8.17	-33.79
4	11695.31	63 PK	74	-11	-44.16	-42.83	8.17	-32.26
5	11670.31	52.03 AV	54	-1.97	-54.48	-54.35	8.17	-43.23
6	#17526.43	56.01 PK	68.2	-12.19	-49.42	-51.76	8.17	-39.25

Remarks:

1. Margin value = Emission Level – Limit value
2. The other emission levels were very low against the limit.
3. " # " : The frequency is out of the restricted band.

Chain 0

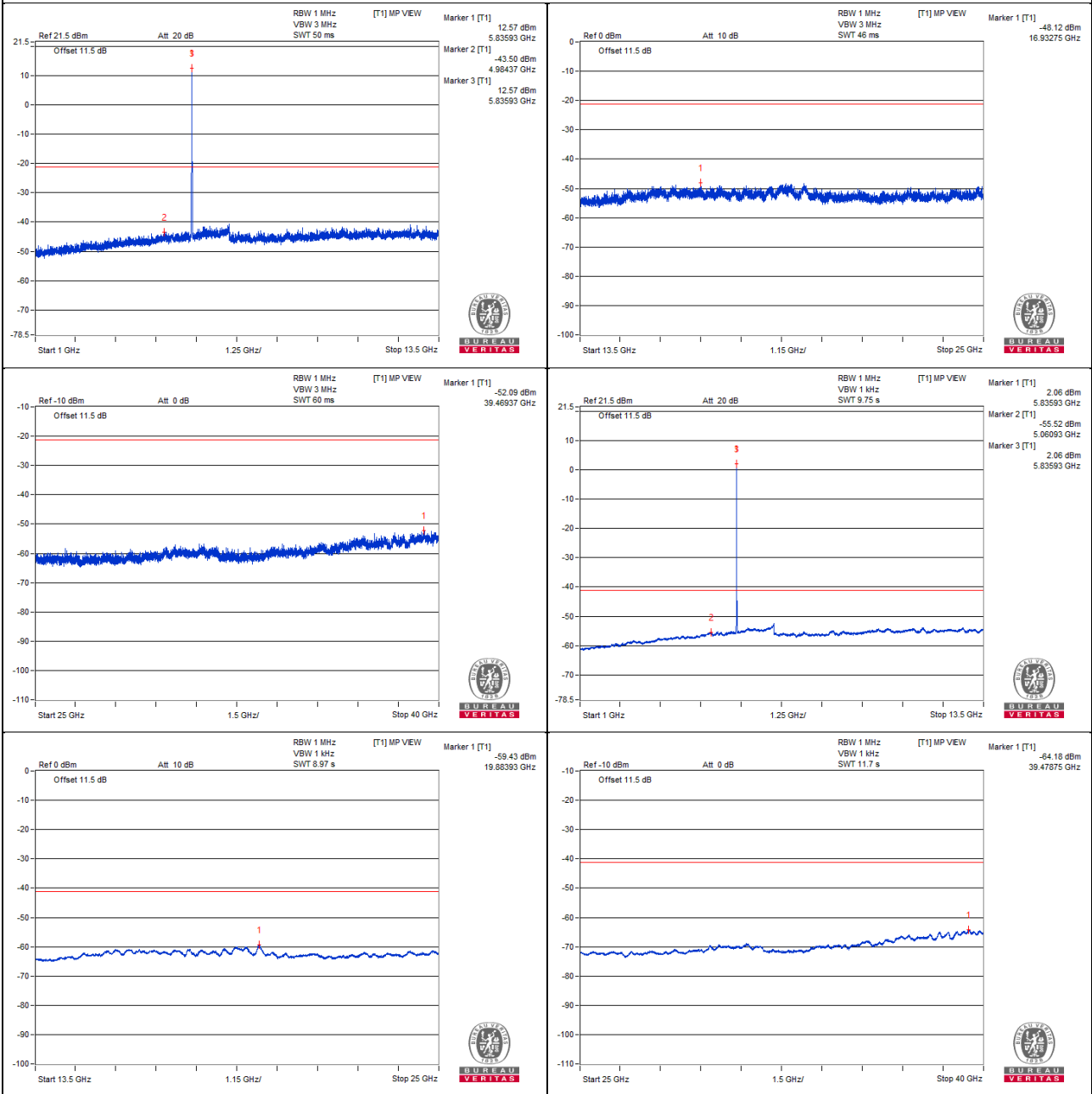

Chain 1

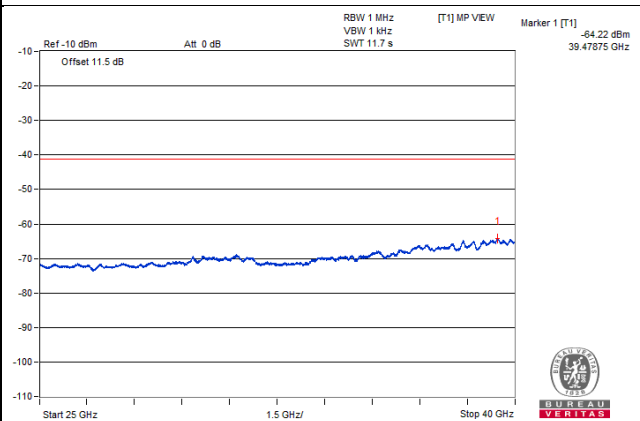
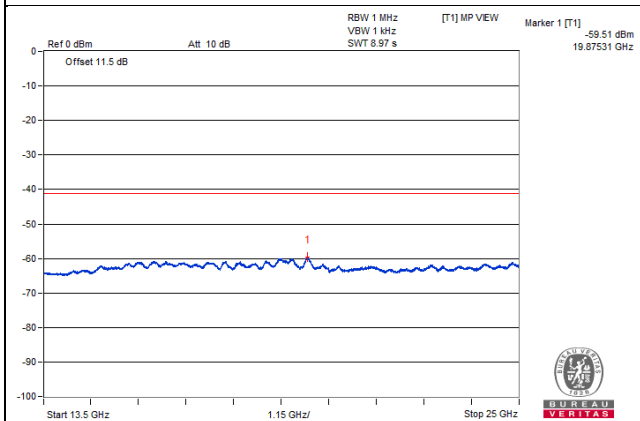
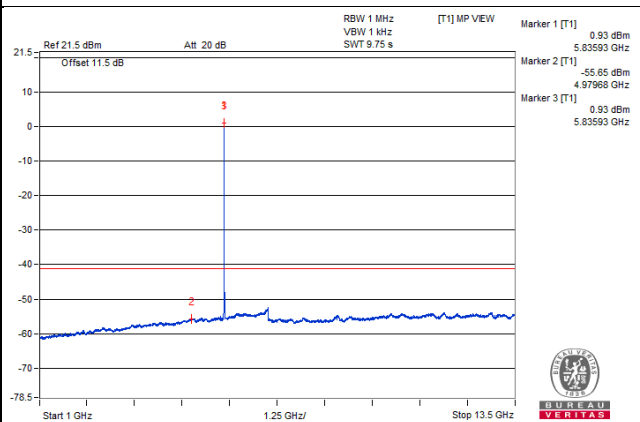
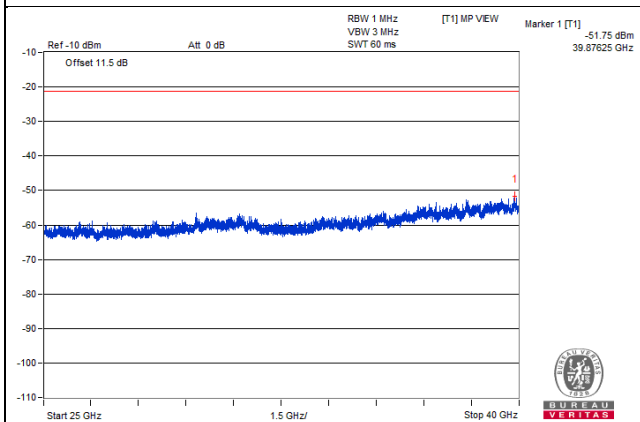
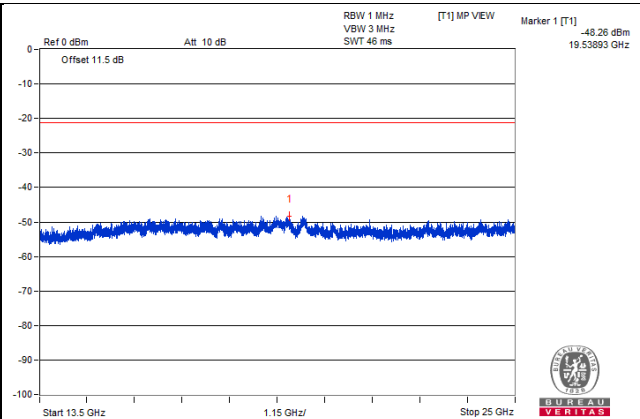
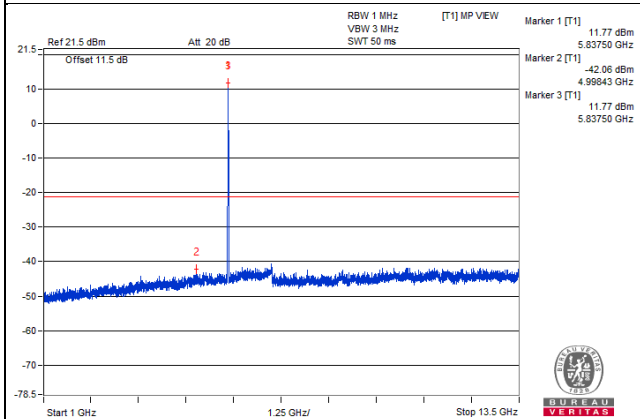

Channel 173

Conducted spurious emission table

No.	Frequency (MHz)	Emission Level (dBuV/m)	Limit (dBuV/m)	Margin (dB)	Raw Value (dBm)		Correction Factor (dB)	EIRP Level (dBm)
					Chain0	Chain1		
1	3923.43	60.87 PK	74	-13.13	-45.46	-45.69	8.17	-34.39
2	3917.18	49.19 AV	54	-4.81	-57.56	-56.96	8.17	-46.07
3	#7820.31	62.49 PK	68.2	-5.71	-44.56	-43.41	8.17	-32.77
4	11720.31	63.38 PK	74	-10.62	-44.85	-41.79	8.17	-31.88
5	11715.62	51.64 AV	54	-2.36	-54.94	-54.67	8.17	-43.62
6	#17612.68	56.11 PK	68.2	-12.09	-48.98	-52.29	8.17	-39.15

Remarks:

1. Margin value = Emission Level – Limit value
2. The other emission levels were very low against the limit.
3. " # " : The frequency is out of the restricted band.

Chain 0

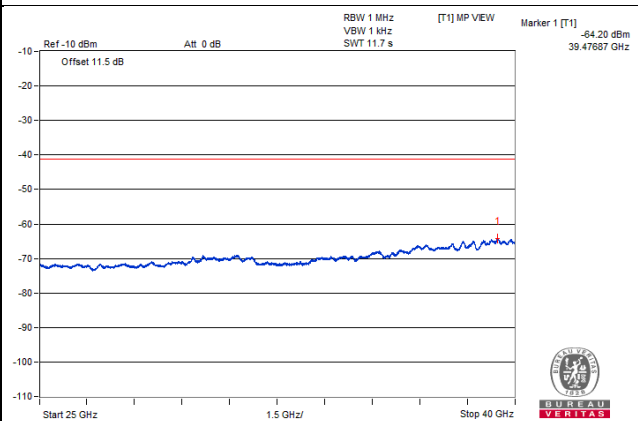
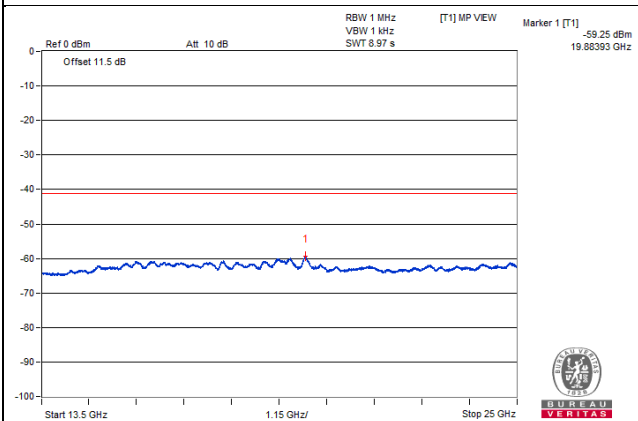
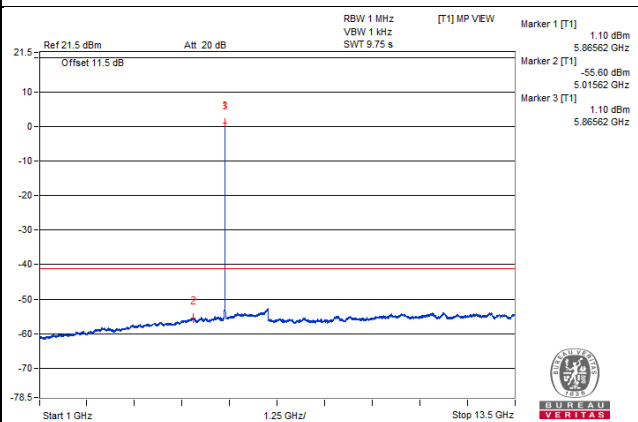
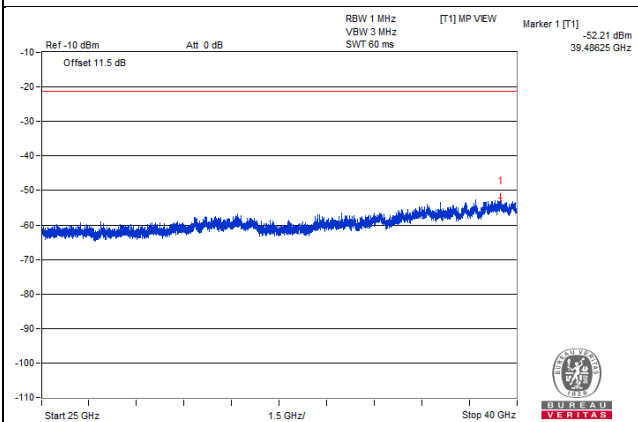
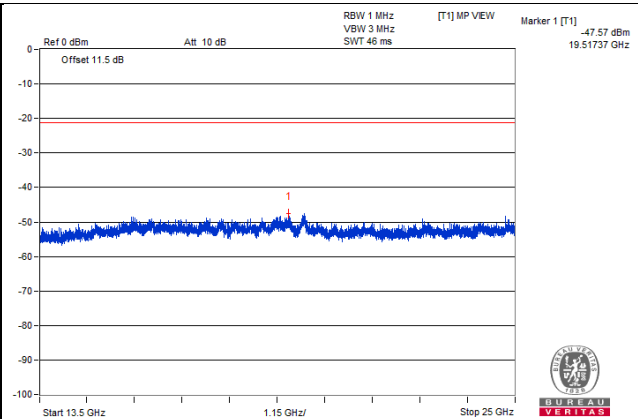
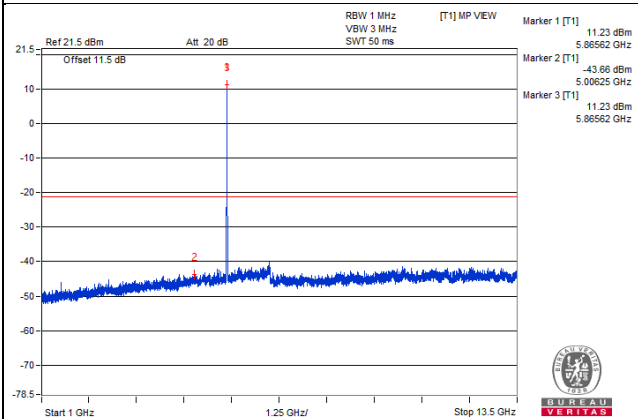

Chain 1

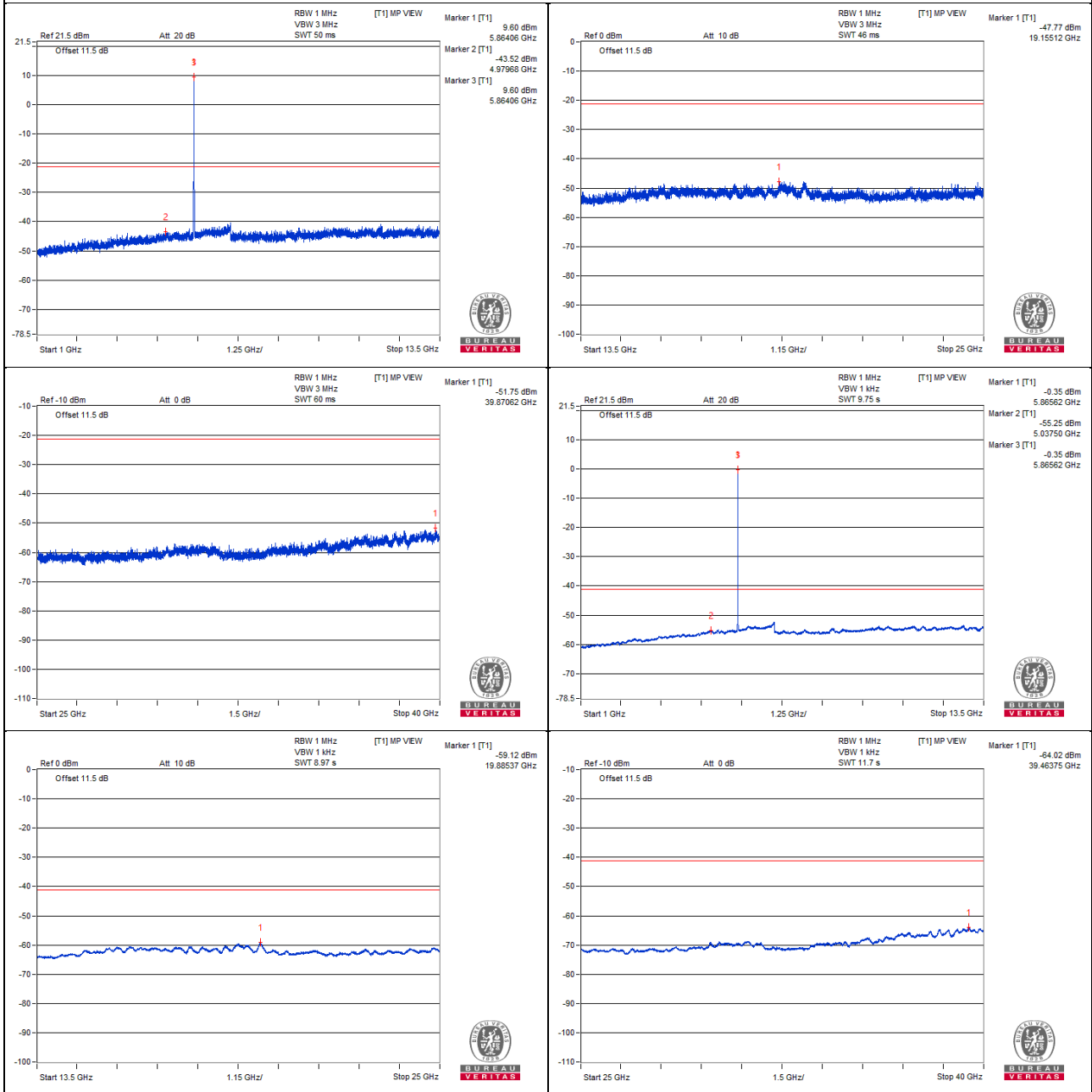

Channel 177

Conducted spurious emission table

No.	Frequency (MHz)	Emission Level (dBuV/m)	Limit (dBuV/m)	Margin (dB)	Raw Value (dBm)		Correction Factor (dB)	EIRP Level (dBm)
					Chain0	Chain1		
1	3939.06	60.54 PK	74	-13.46	-46.11	-45.7	8.17	-34.72
2	3910.93	49.27 AV	54	-4.73	-57.31	-57.04	8.17	-45.99
3	#7854.68	61.94 PK	68.2	-6.26	-45.26	-43.86	8.17	-33.32
4	11771.87	63.53 PK	74	-10.47	-42.23	-43.72	8.17	-31.73
5	11765.62	51.31 AV	54	-2.69	-55.32	-54.94	8.17	-43.95
6	#17644.31	55.87 PK	68.2	-12.33	-50.12	-51.07	8.17	-39.39

Remarks:

1. Margin value = Emission Level – Limit value
2. The other emission levels were very low against the limit.
3. " # " : The frequency is out of the restricted band.

Chain 0

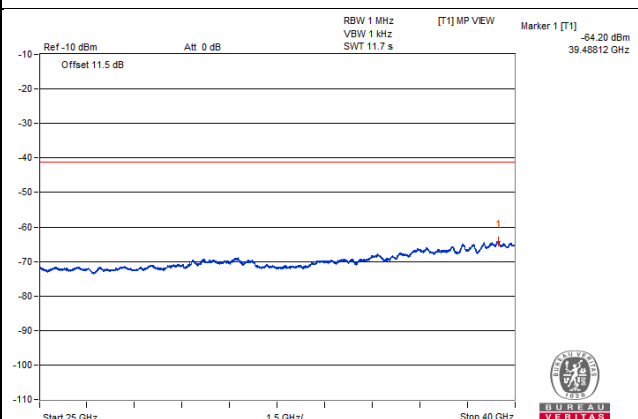
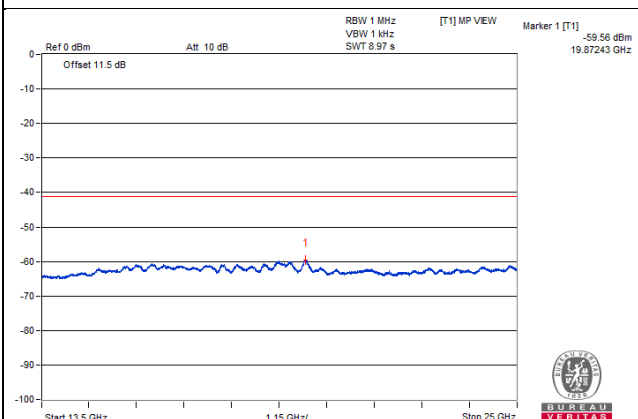
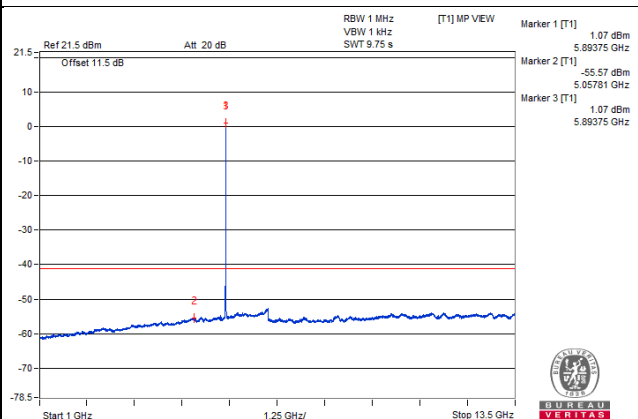
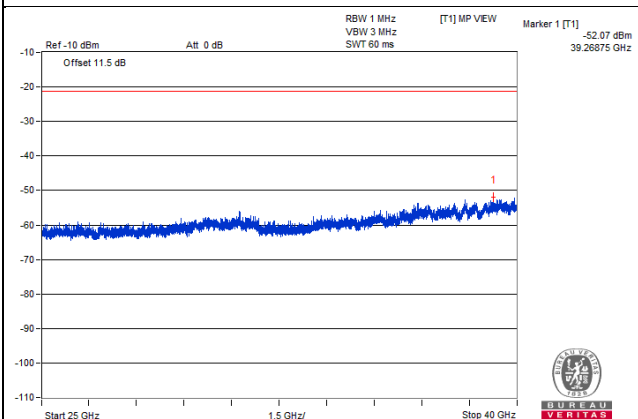
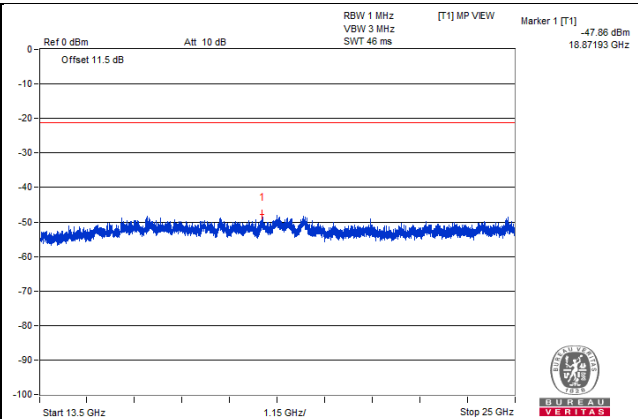
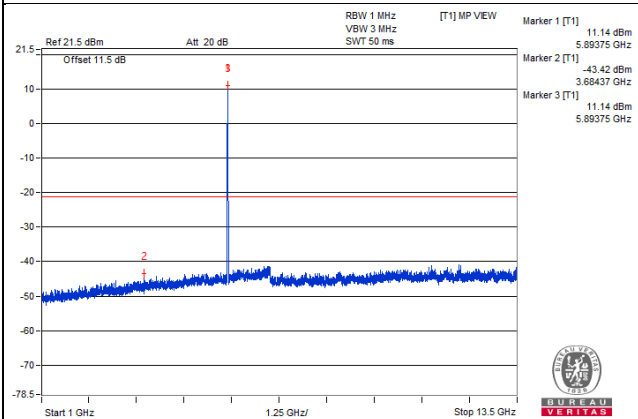

Chain 1

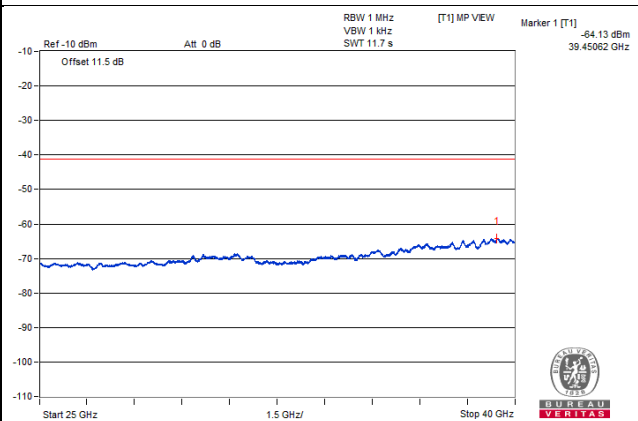
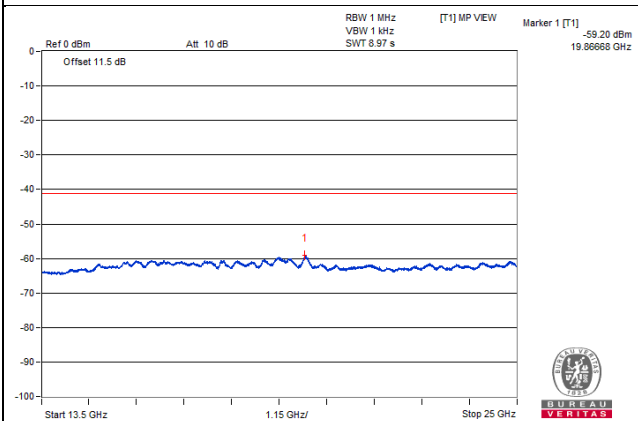
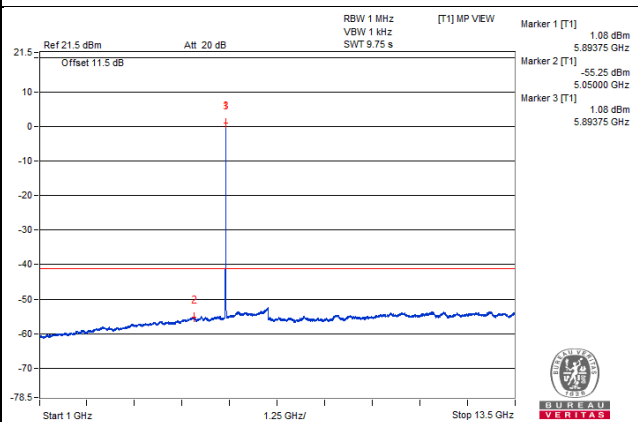
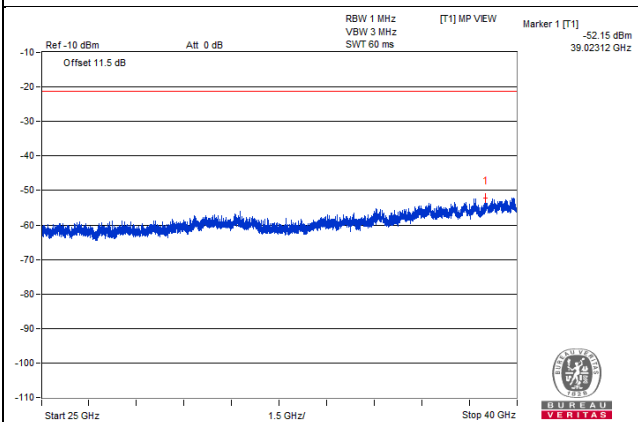
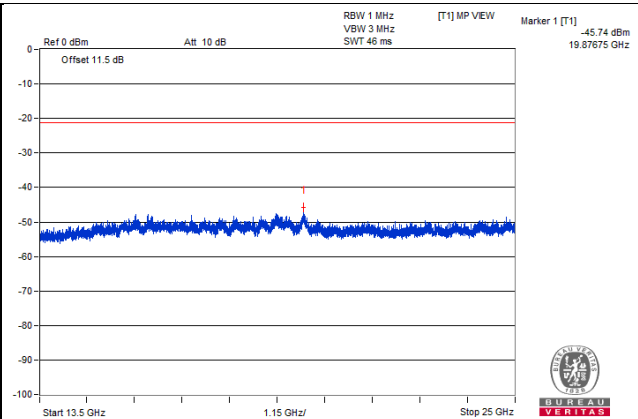
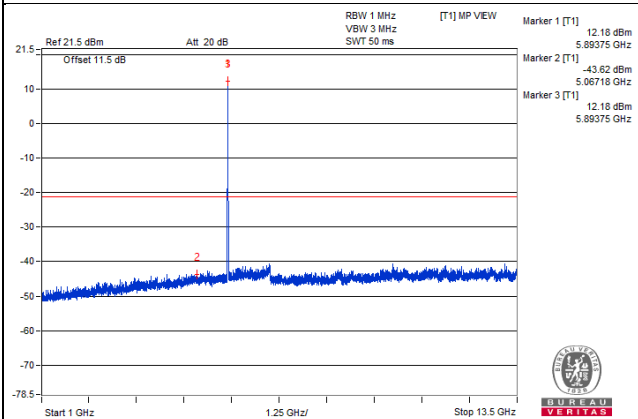

802.11ax (RU106)

Channel 169

Bandedge

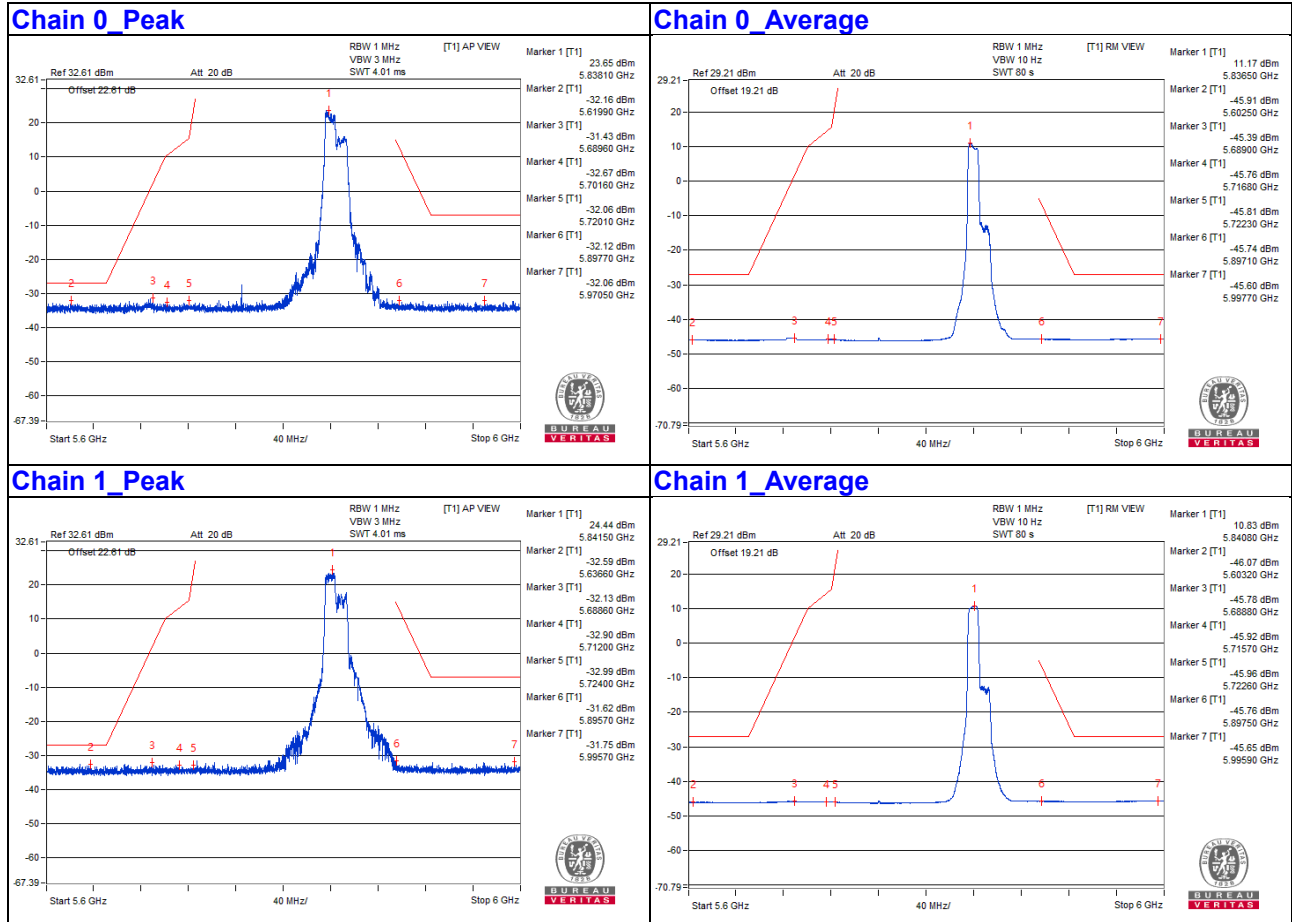

Note:

1. The offset including attenuator (10 dB), cable loss (1.5 dB), directional gain (8.1 dBi) and number of outputs (10 log (2)=3.01 dB).
2. The test results were EIRP.

Channel 173

Bandedge

Chain 0_Peak

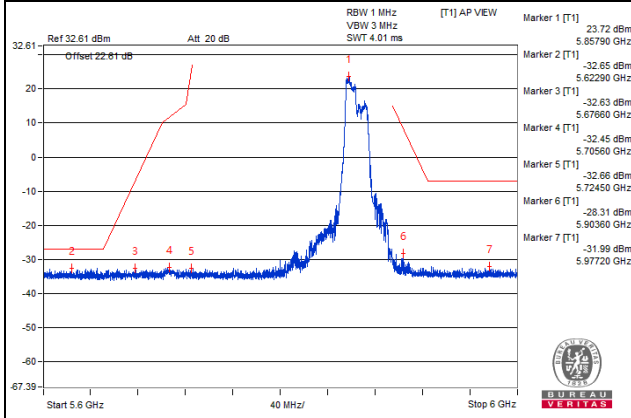

Chain 0_Average

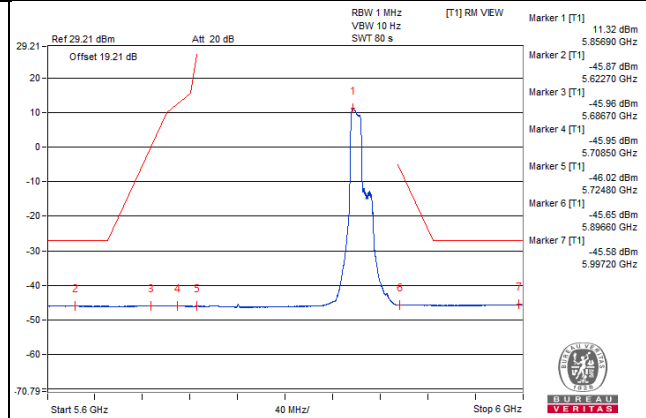

Chain 1_Peak

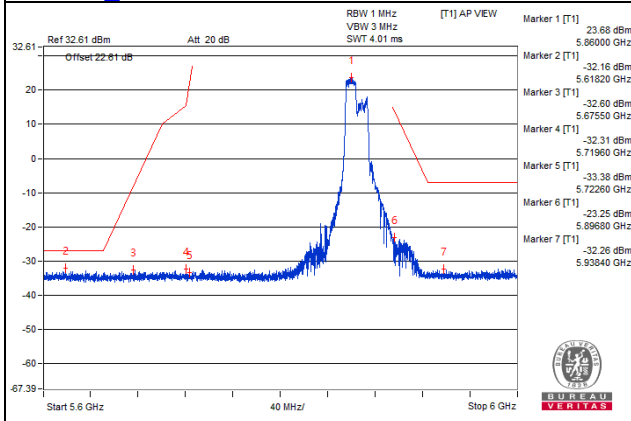

Chain 1_Average

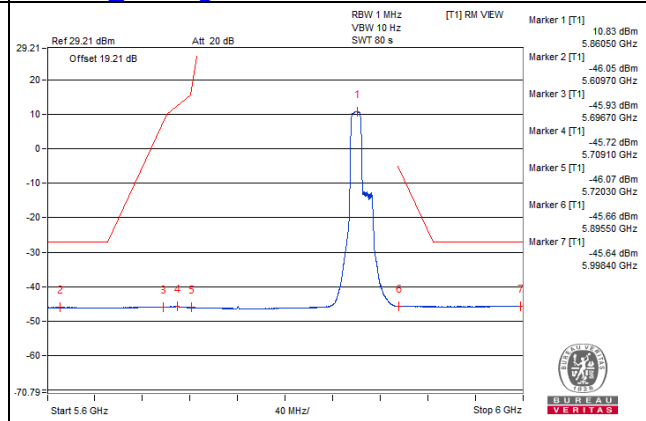

Note:

1. The offset including attenuator (10 dB), cable loss (1.5 dB), directional gain (8.1 dBi) and number of outputs ($10 \log(2)=3.01$ dB).
2. The test results were EIRP.

Channel 177

Bandedge

Chain 0_Peak

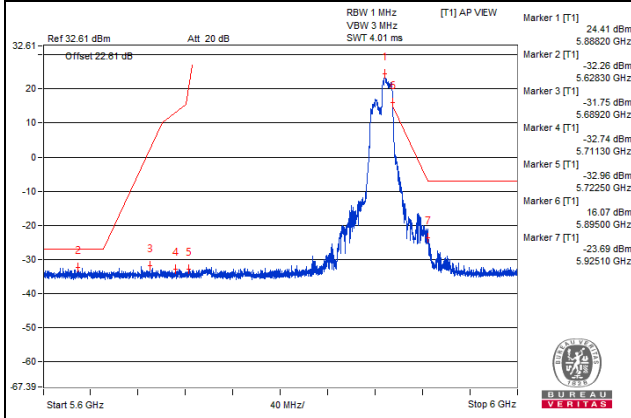

Chain 0_Average

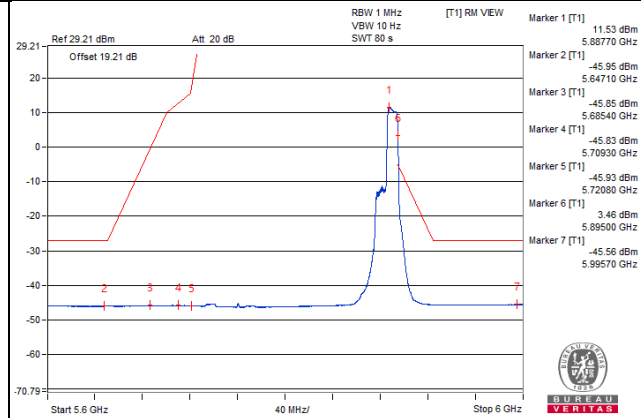

Chain 1_Peak

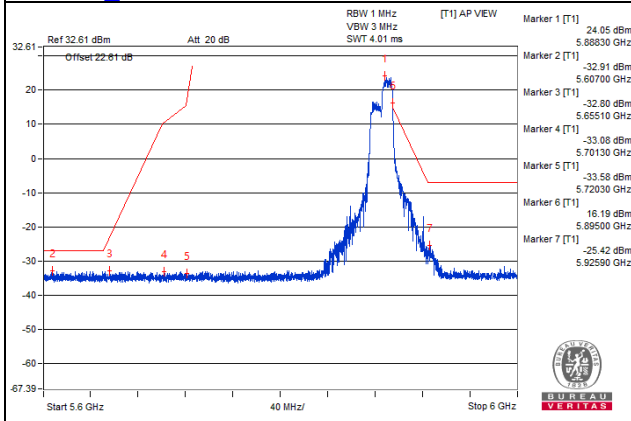

Chain 1_Average

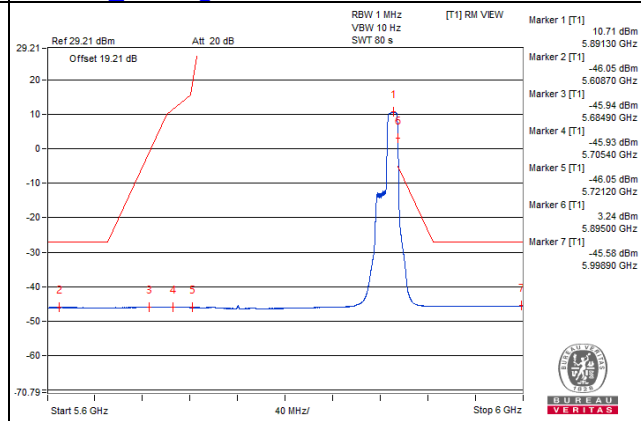

Note:

1. The offset including attenuator (10 dB), cable loss (1.5 dB), directional gain (8.1 dBi) and number of outputs (10 log (2)=3.01 dB).
2. The test results were EIRP.
3. The emission was verified and the test result was passed by radiated measurement. (Please refer Appendix A)

802.11ax (RU242)
Channel 169
Conducted spurious emission table

No.	Frequency (MHz)	Emission Level (dBuV/m)	Limit (dBuV/m)	Margin (dB)	Raw Value (dBm)		Correction Factor (dB)	EIRP Level (dBm)
					Chain0	Chain1		
1	3904.68	61.87 PK	74	-12.13	-44.33	-44.82	8.17	-33.39
2	3909.37	49.34 AV	54	-4.66	-57.25	-56.95	8.17	-45.92
3	#7806.25	62.04 PK	68.2	-6.16	-44.2	-44.61	8.17	-33.22
4	11701.56	63.36 PK	74	-10.64	-42.52	-43.73	8.17	-31.90
5	11690.62	52.38 AV	54	-1.62	-54.33	-53.81	8.17	-42.88
6	#17527.87	56.61 PK	68.2	-11.59	-49.58	-50.09	8.17	-38.65

Remarks:

1. Margin value = Emission Level – Limit value
2. The other emission levels were very low against the limit.
3. " # " : The frequency is out of the restricted band.

Chain 0

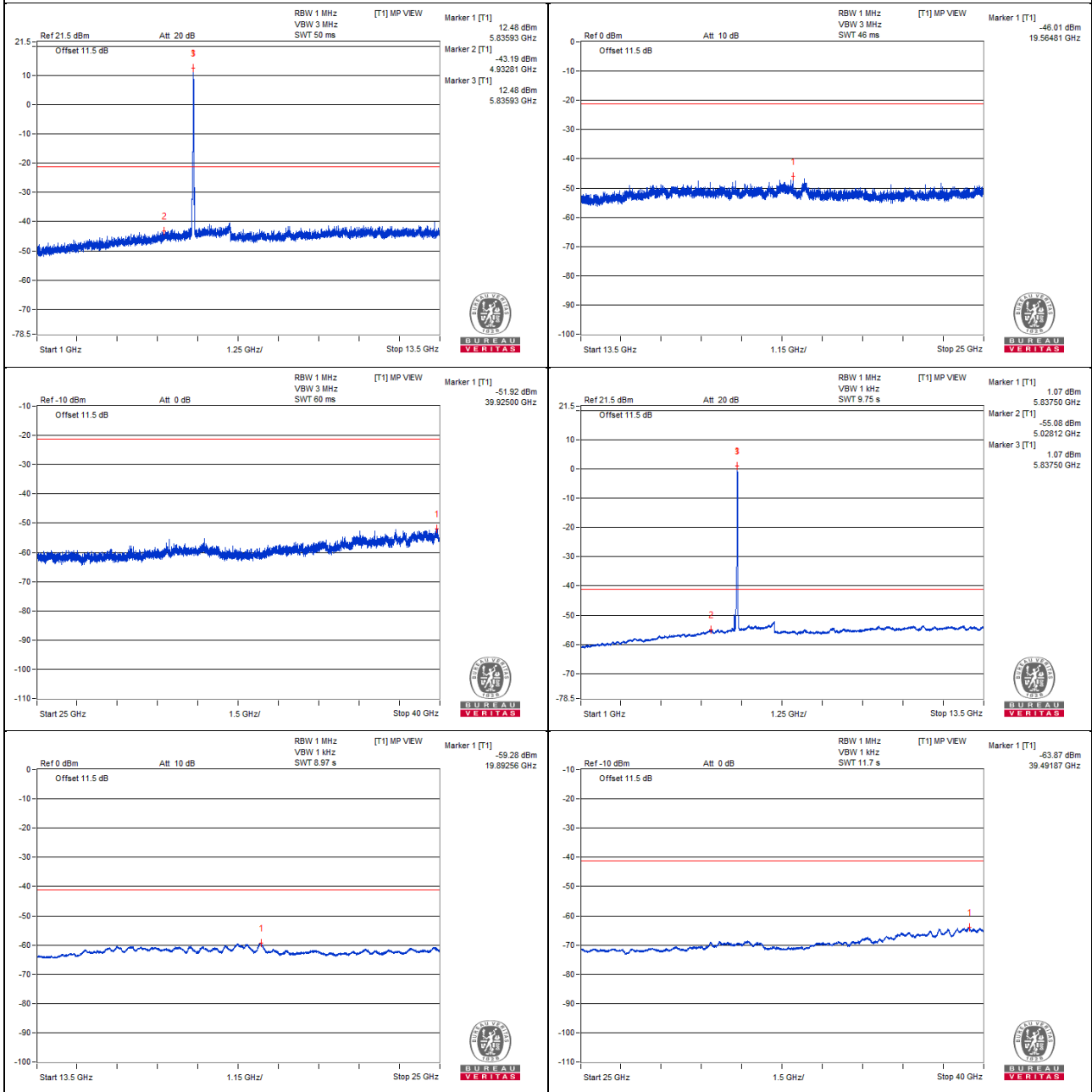

Chain 1

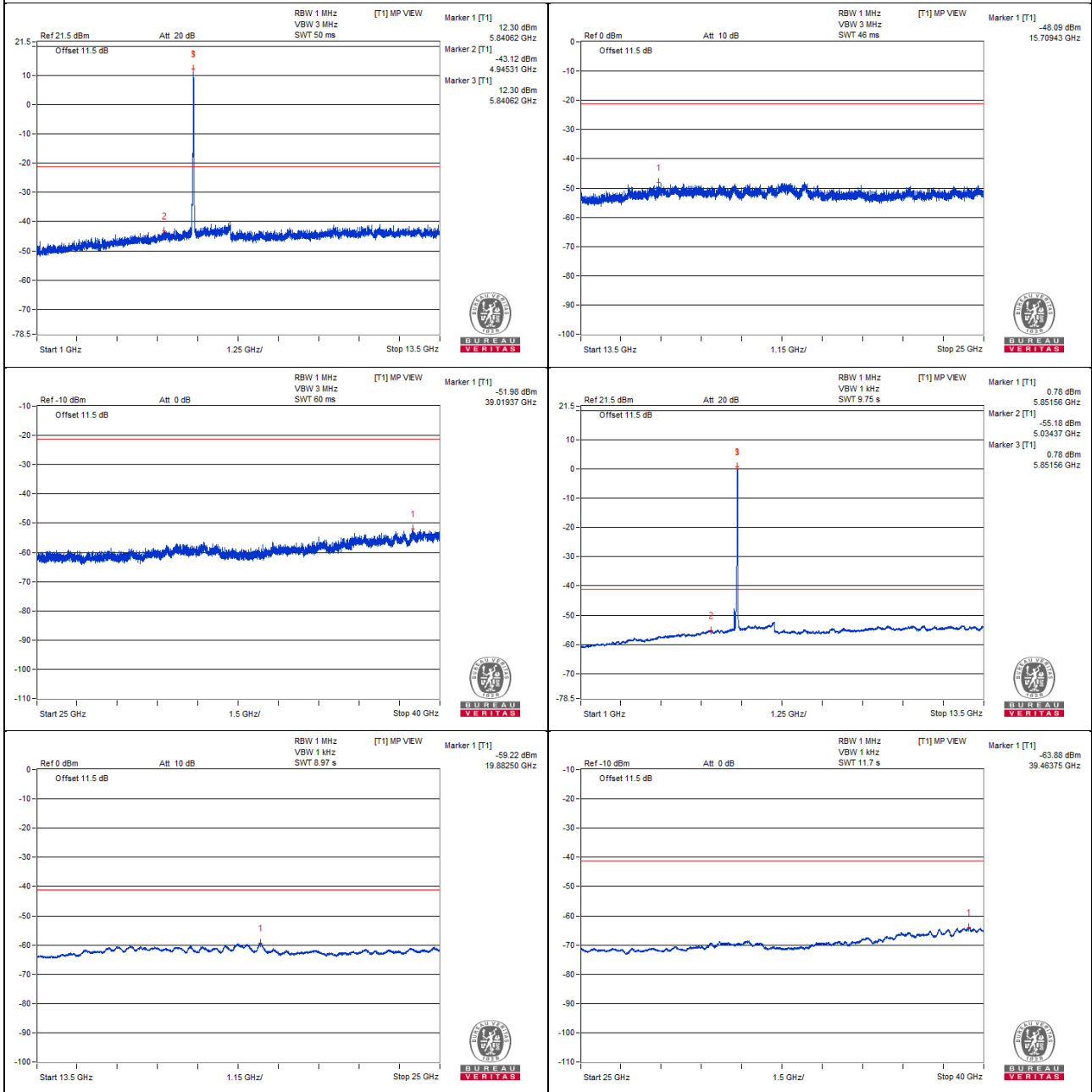

Bandedge

Chain 0_Peak

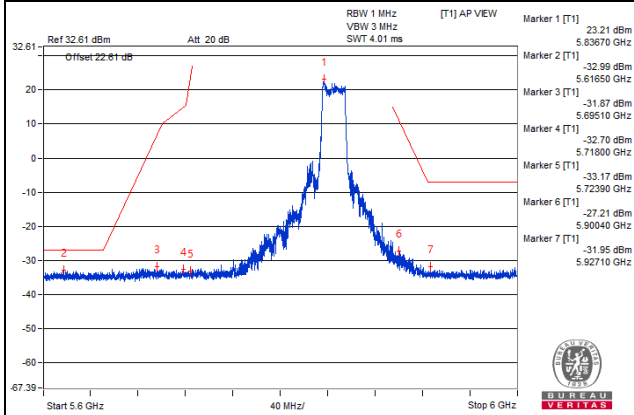

Chain 0_Average

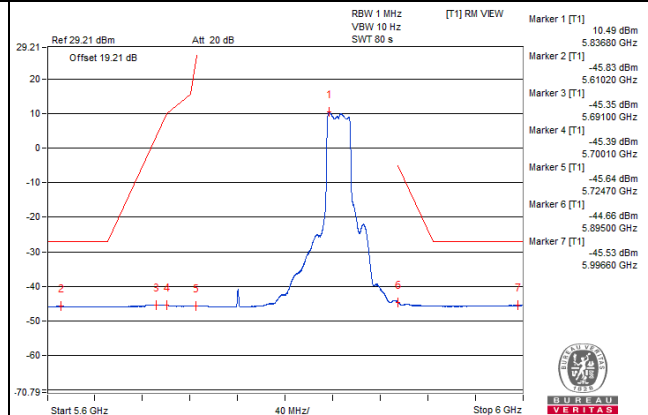

Chain 1_Peak

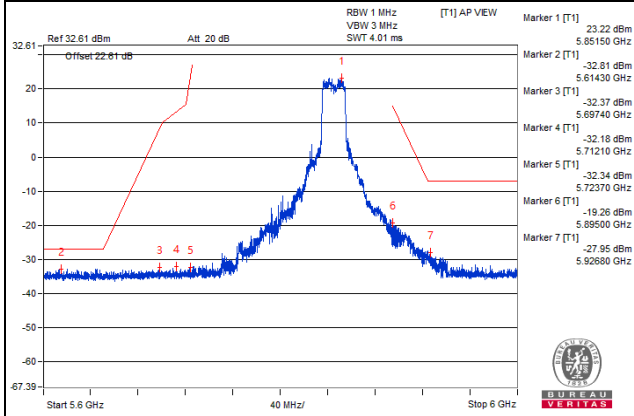

Chain 1_Average

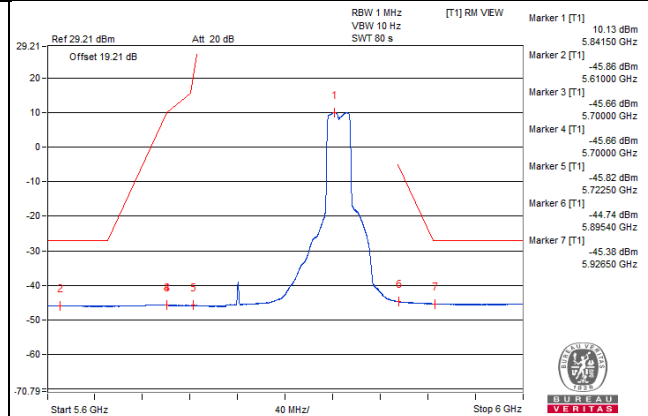

Note:

1. The offset including attenuator (10 dB), cable loss (1.5 dB), directional gain (8.1 dBi) and number of outputs ($10 \log(2) = 3.01$ dB).
2. The test results were EIRP.

Channel 173

Conducted spurious emission table

No.	Frequency (MHz)	Emission Level (dBuV/m)	Limit (dBuV/m)	Margin (dB)	Raw Value (dBm)		Correction Factor (dB)	EIRP Level (dBm)
					Chain0	Chain1		
1	3923.43	60.57 PK	74	-13.43	-45.33	-46.49	8.17	-34.69
2	3926.56	49.41 AV	54	-4.59	-56.95	-57.11	8.17	-45.85
3	#7839.06	61.69 PK	68.2	-6.51	-43.9	-45.81	8.17	-33.57
4	11714.06	63.56 PK	74	-10.44	-42.81	-42.95	8.17	-31.70
5	11729.68	51.91 AV	54	-2.09	-54.84	-54.25	8.17	-43.35
6	#17601.18	55.88 PK	68.2	-12.32	-51.43	-49.83	8.17	-39.38

Remarks:

1. Margin value = Emission Level – Limit value
2. The other emission levels were very low against the limit.
3. " # " : The frequency is out of the restricted band.

Chain 0

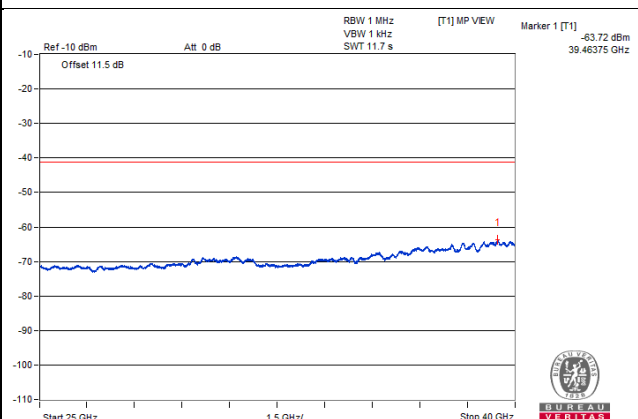
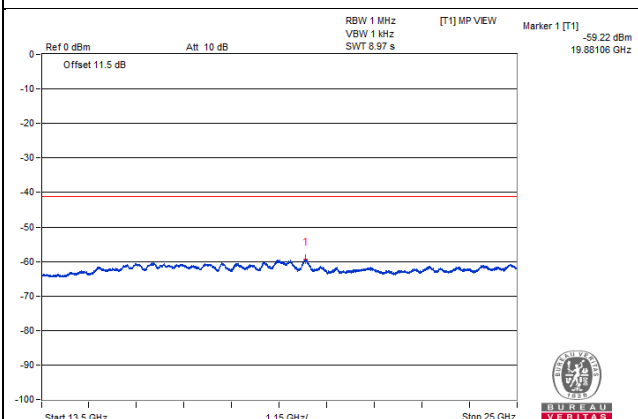
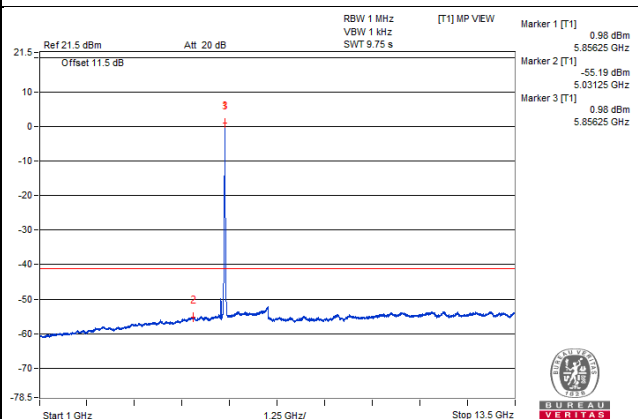
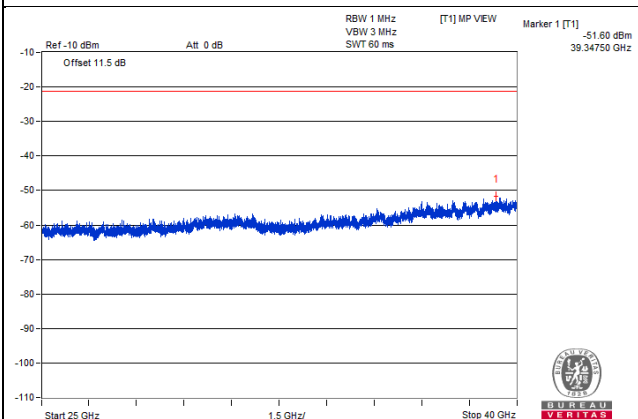
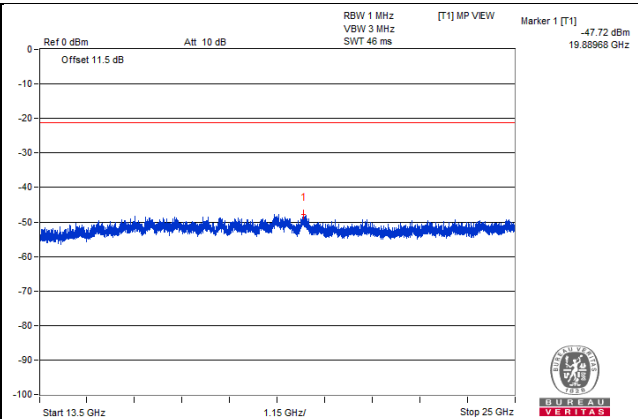
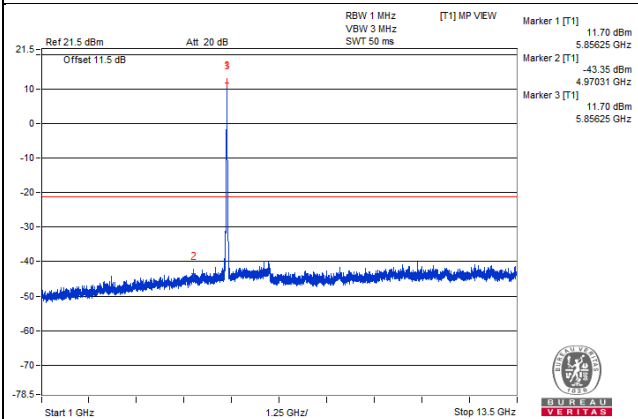

Chain 1

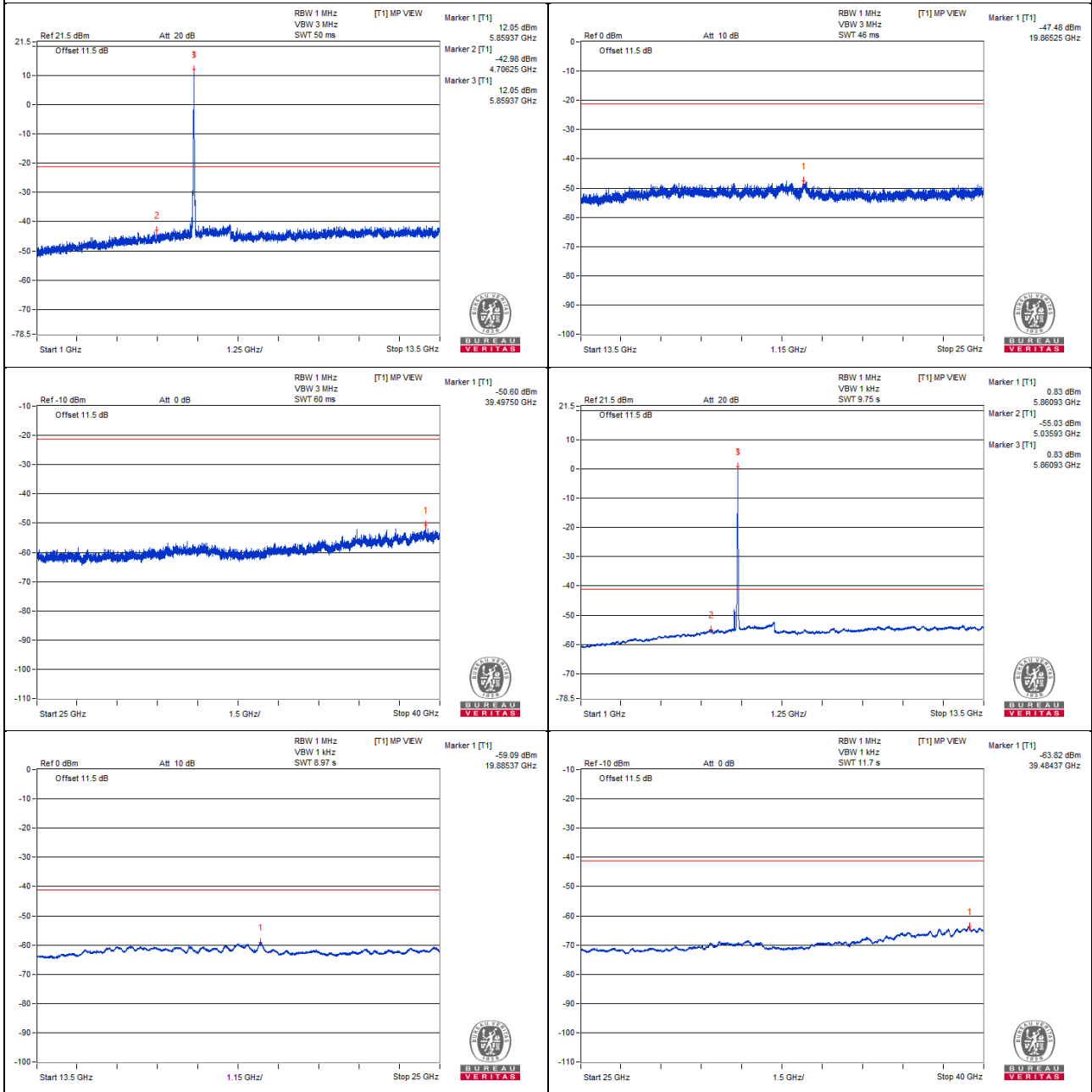

Bandedge

Chain 0_Peak

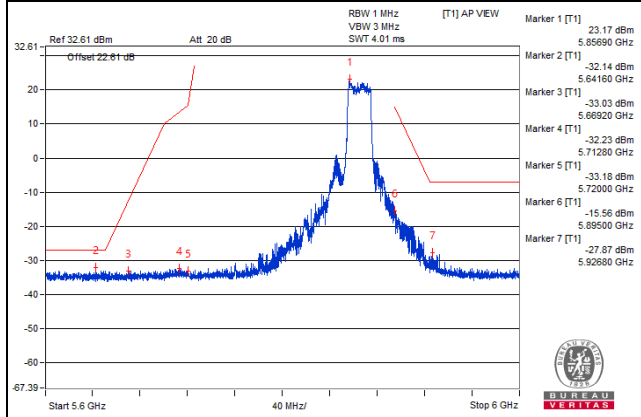

Chain 0_Average

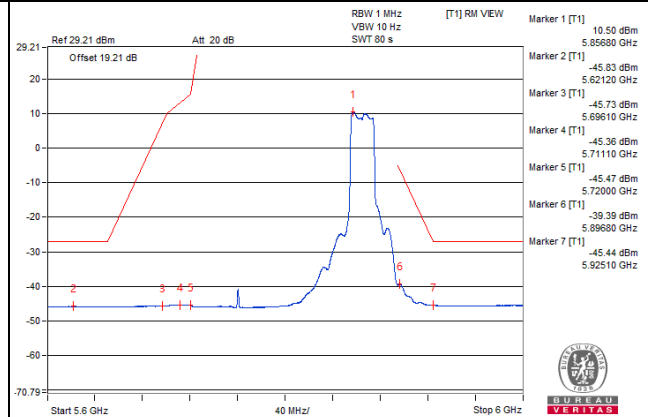

Chain 1_Peak

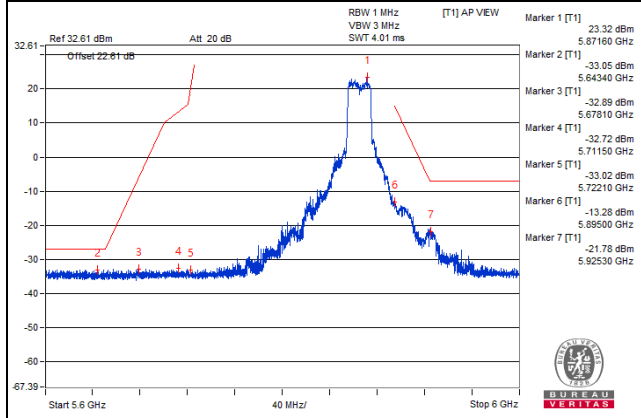

Chain 1_Average

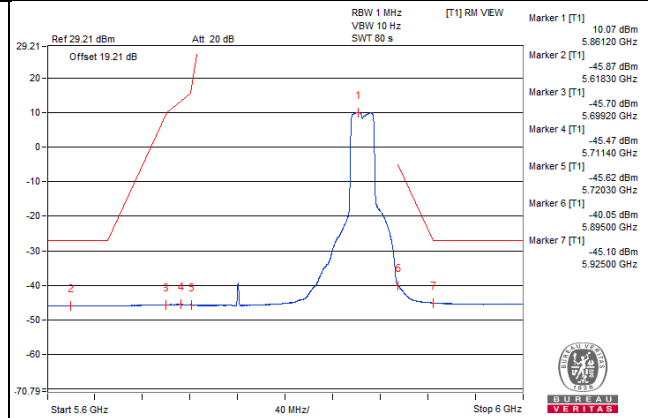

Note:

1. The offset including attenuator (10 dB), cable loss (1.5 dB), directional gain (8.1 dBi) and number of outputs ($10 \log(2) = 3.01$ dB).
2. The test results were EIRP.

Channel 177

Conducted spurious emission table

No.	Frequency (MHz)	Emission Level (dBuV/m)	Limit (dBuV/m)	Margin (dB)	Raw Value (dBm)		Correction Factor (dB)	EIRP Level (dBm)
					Chain0	Chain1		
1	3934.37	60.78 PK	74	-13.22	-46.58	-44.91	8.17	-34.48
2	3923.43	49.44 AV	54	-4.56	-56.89	-57.11	8.17	-45.82
3	#7843.75	61.63 PK	68.2	-6.57	-45.17	-44.48	8.17	-33.63
4	11770.31	63.12 PK	74	-10.88	-43.37	-43.27	8.17	-32.14
5	11759.37	51.72 AV	54	-2.28	-54.75	-54.7	8.17	-43.54
6	#17635.68	55.37 PK	68.2	-12.83	-50.63	-51.55	8.17	-39.89

Remarks:

1. Margin value = Emission Level – Limit value
2. The other emission levels were very low against the limit.
3. " # " : The frequency is out of the restricted band.

Chain 0

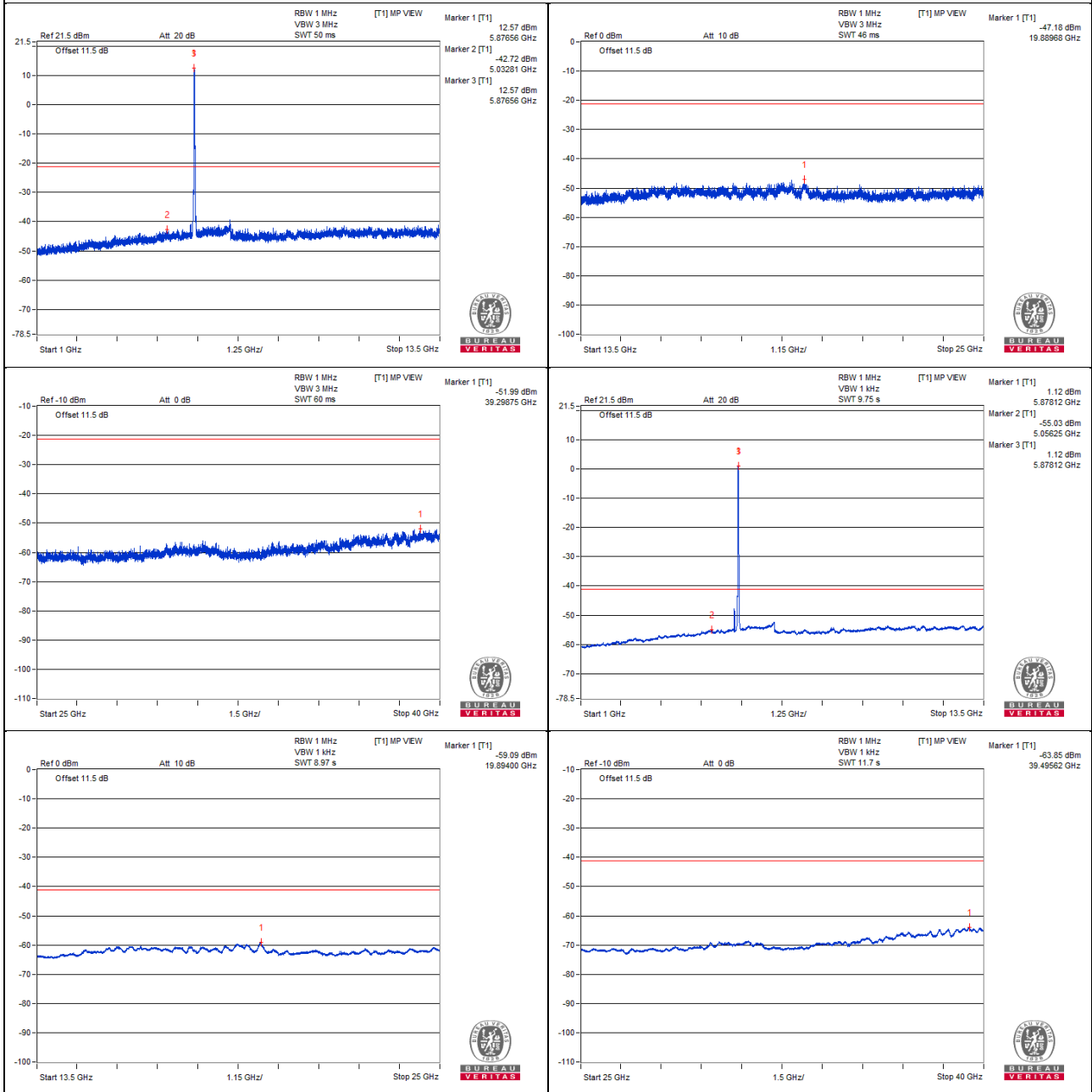

Chain 1

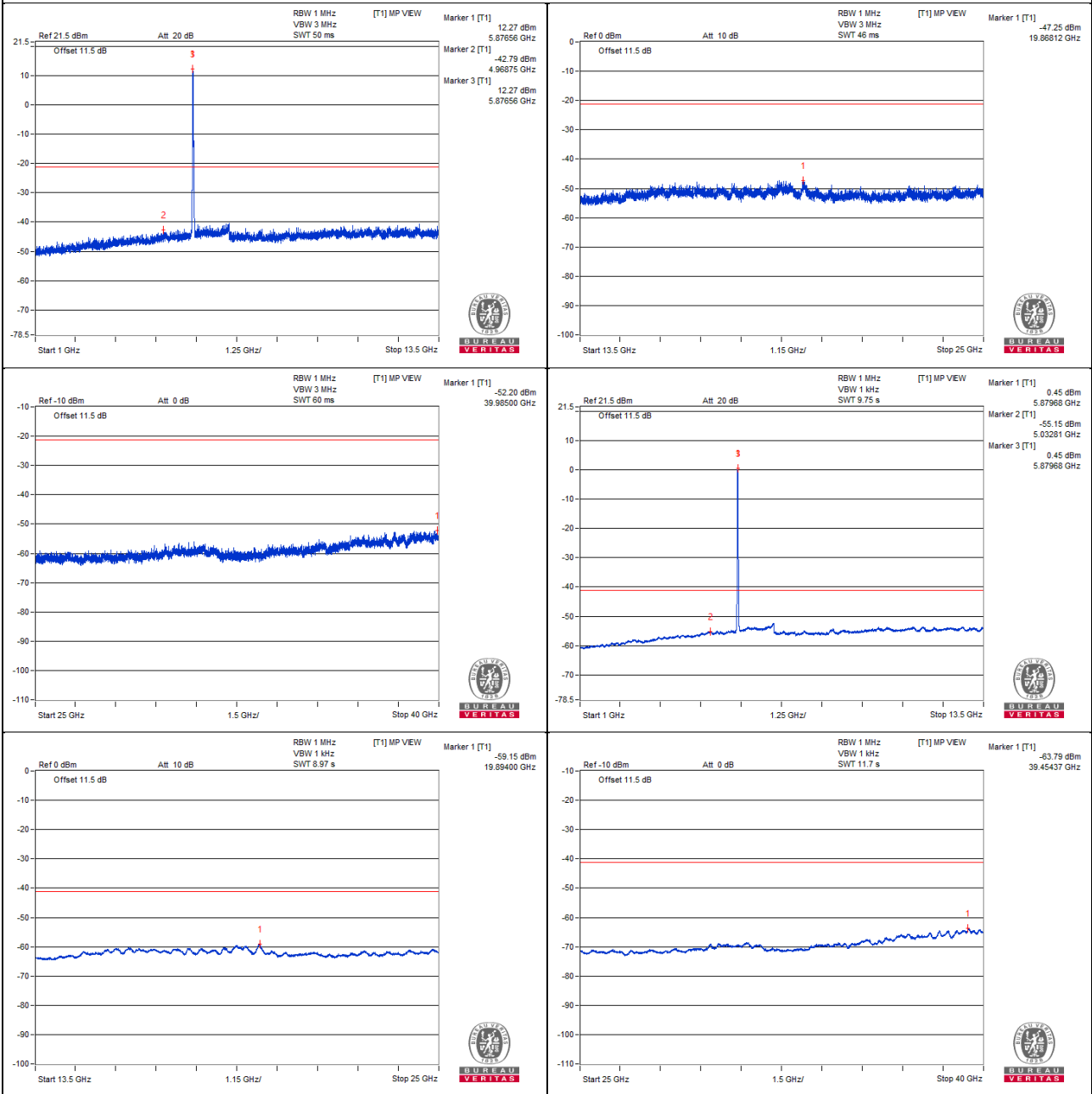

Bandedge

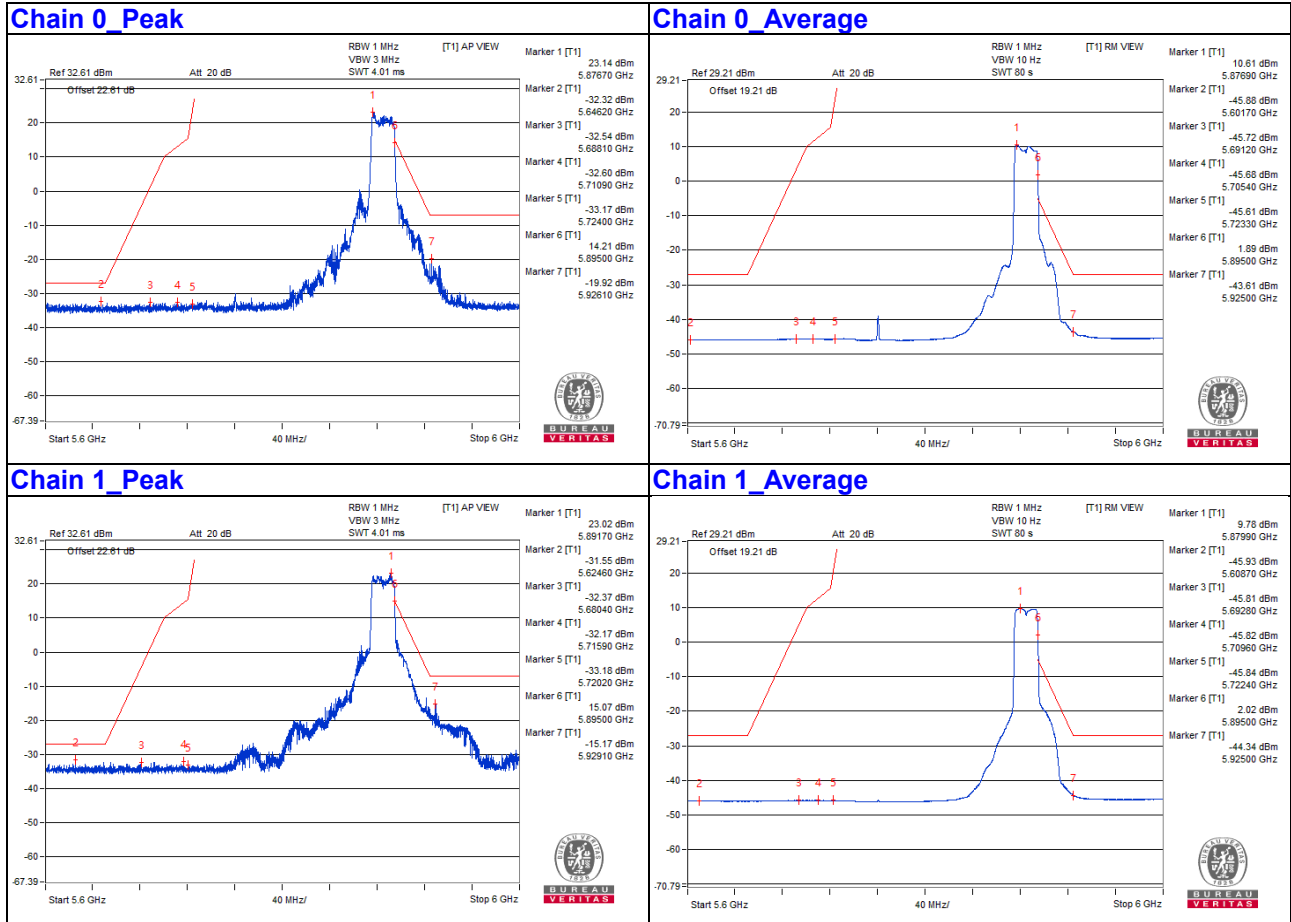

Note:

1. The offset including attenuator (10 dB), cable loss (1.5 dB), directional gain (8.1 dBi) and number of outputs (10 log (2))=3.01 dB).
2. The test results were EIRP.
3. The emission was verified and the test result was passed by radiated measurement. (Please refer Appendix A)

802.11ax (RU484)

Channel 167

Conducted spurious emission table

No.	Frequency (MHz)	Emission Level (dBuV/m)	Limit (dBuV/m)	Margin (dB)	Raw Value (dBm)		Correction Factor (dB)	EIRP Level (dBm)
					Chain0	Chain1		
1	3875	60.61 PK	74	-13.39	-45.51	-46.17	8.17	-34.65
2	3892.18	49.38 AV	54	-4.62	-56.93	-57.2	8.17	-45.88
3	#7770.31	61.54 PK	68.2	-6.66	-44.92	-44.88	8.17	-33.72
4	11662.5	64.26 PK	74	-9.74	-43.54	-41.14	8.17	-31.00
5	11650	52.73 AV	54	-1.27	-53.72	-53.71	8.17	-42.53
6	#17517.81	56.39 PK	68.2	-11.81	-49.85	-50.25	8.17	-38.87

Remarks:

1. Margin value = Emission Level – Limit value
2. The other emission levels were very low against the limit.
3. " # " : The frequency is out of the restricted band.

Chain 0

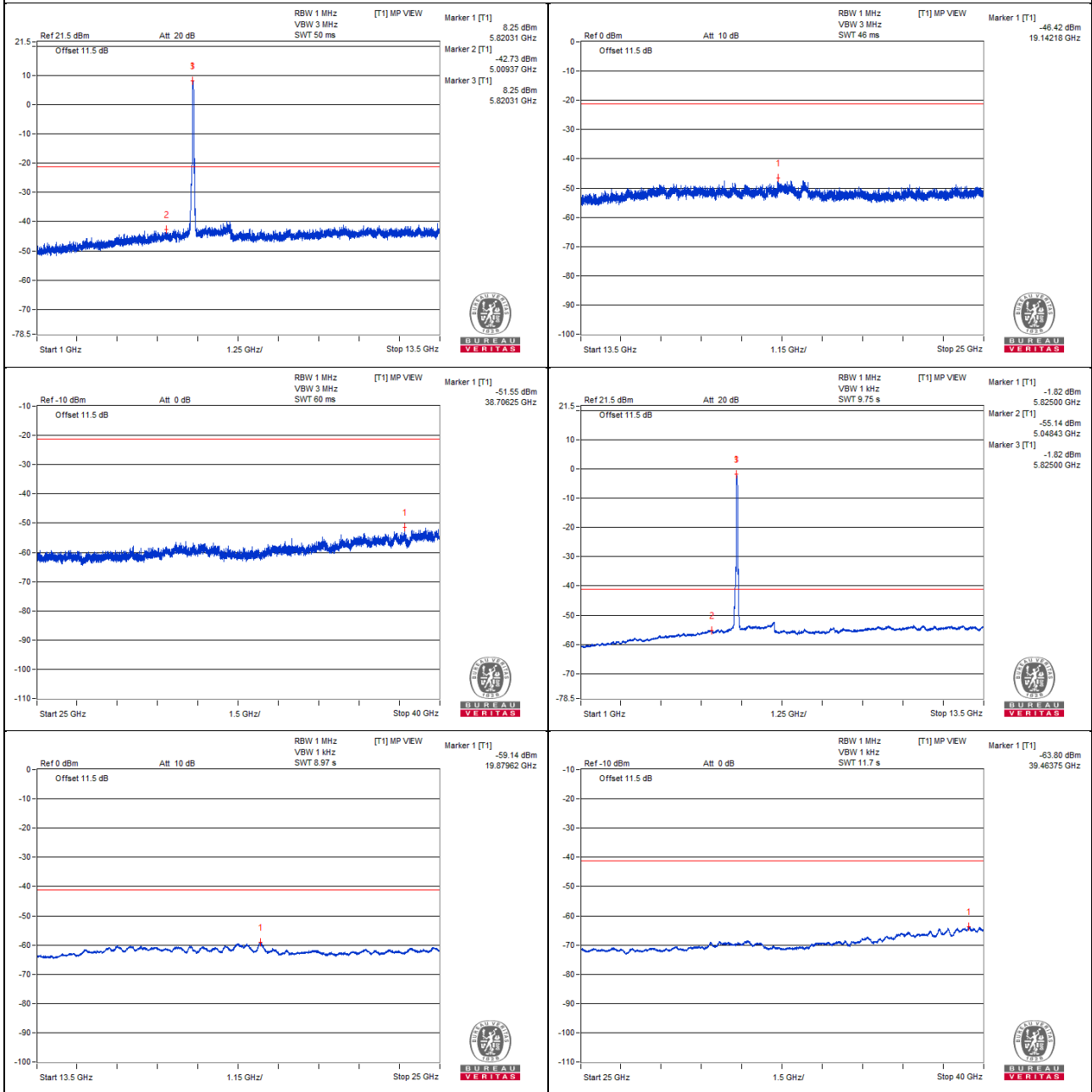

Chain 1

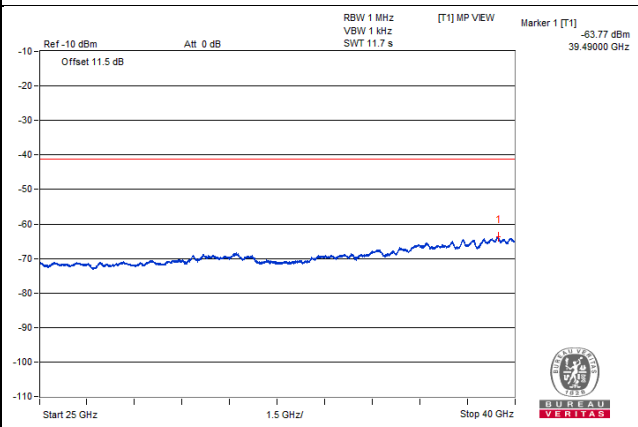
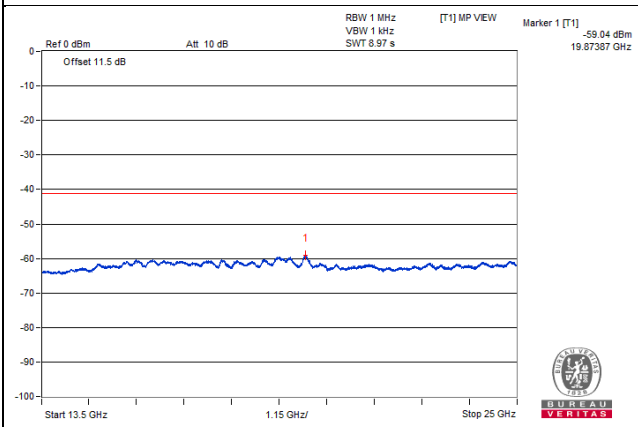
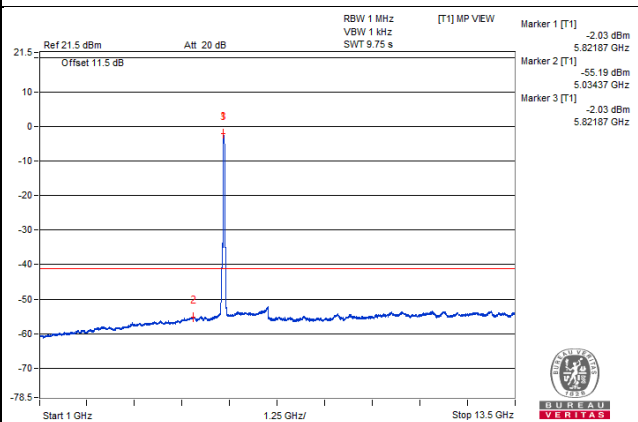
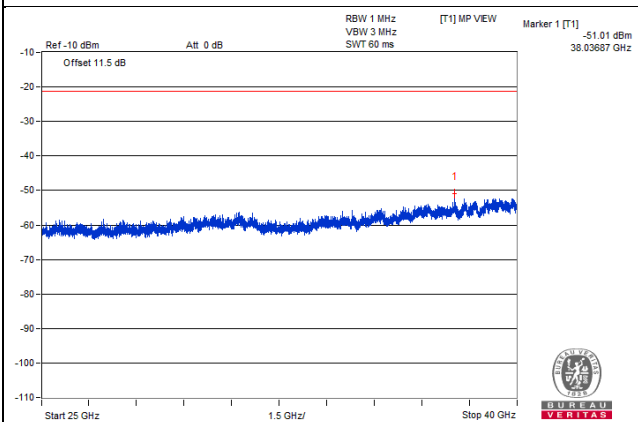
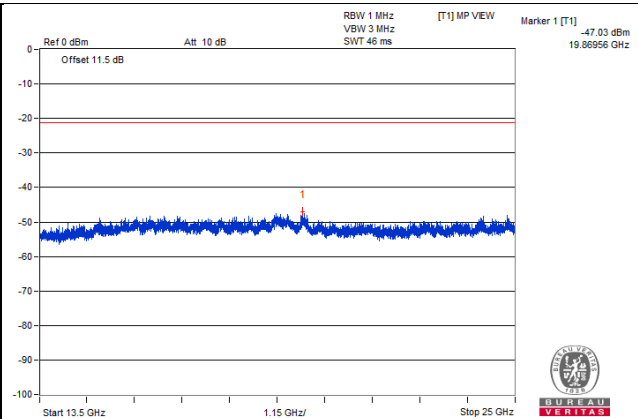
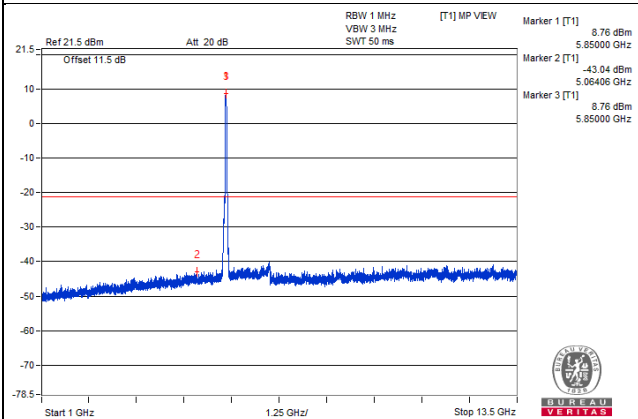

Bandedge

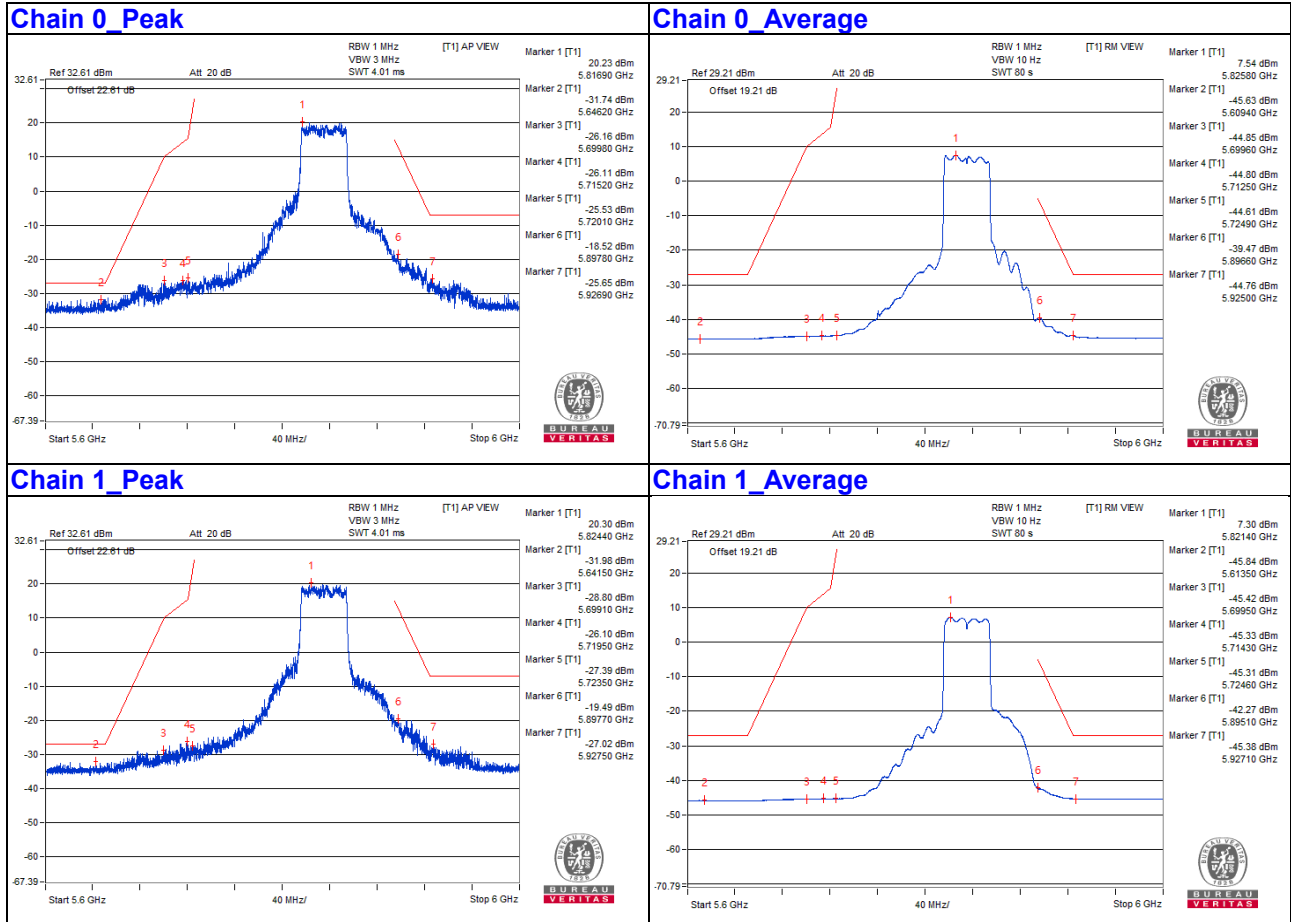

Note:

1. The offset including attenuator (10 dB), cable loss (1.5 dB), directional gain (8.1 dBi) and number of outputs (10 log (2)=3.01 dB).
2. The test results were EIRP.

Channel 175

Conducted spurious emission table

No.	Frequency (MHz)	Emission Level (dBuV/m)	Limit (dBuV/m)	Margin (dB)	Raw Value (dBm)		Correction Factor (dB)	EIRP Level (dBm)
					Chain0	Chain1		
1	3926.56	61.19 PK	74	-12.81	-45.31	-45.19	8.17	-34.07
2	3929.68	49.38 AV	54	-4.62	-57.17	-56.95	8.17	-45.88
3	#7834.37	61.98 PK	68.2	-6.22	-44.21	-44.73	8.17	-33.28
4	11732.81	63.18 PK	74	-10.82	-43.42	-43.1	8.17	-32.08
5	11742.18	51.64 AV	54	-2.36	-54.89	-54.71	8.17	-43.62
6	#17609.81	56.62 PK	68.2	-11.58	-50	-49.64	8.17	-38.64

Remarks:

1. Margin value = Emission Level – Limit value
2. The other emission levels were very low against the limit.
3. " # " : The frequency is out of the restricted band.

Chain 0

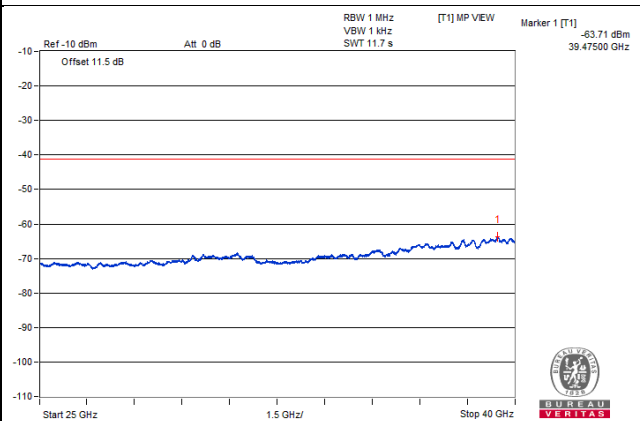
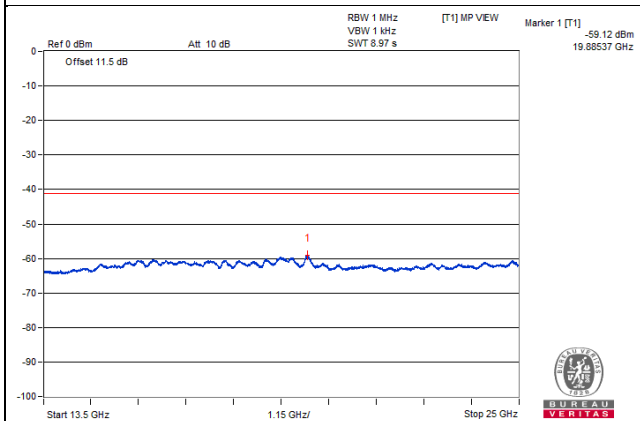
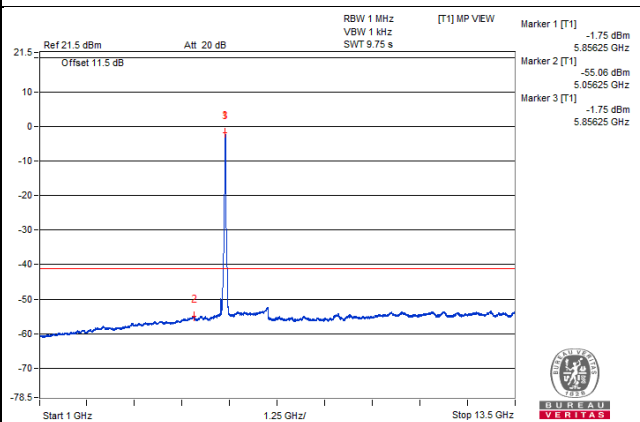
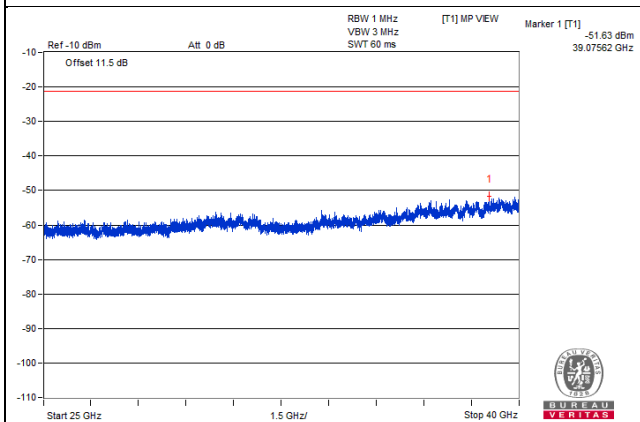
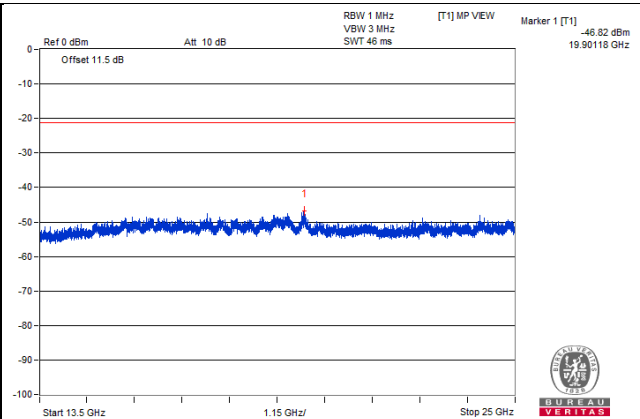
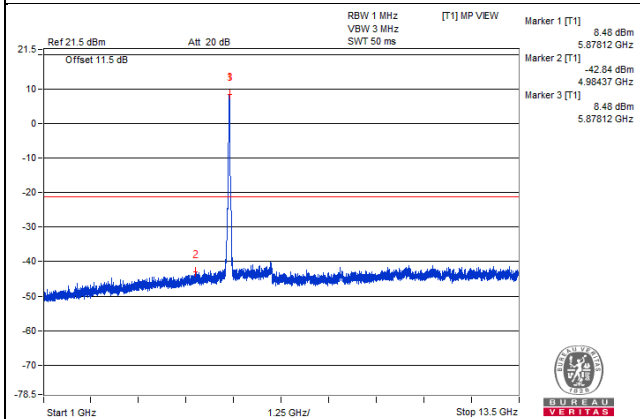

Chain 1

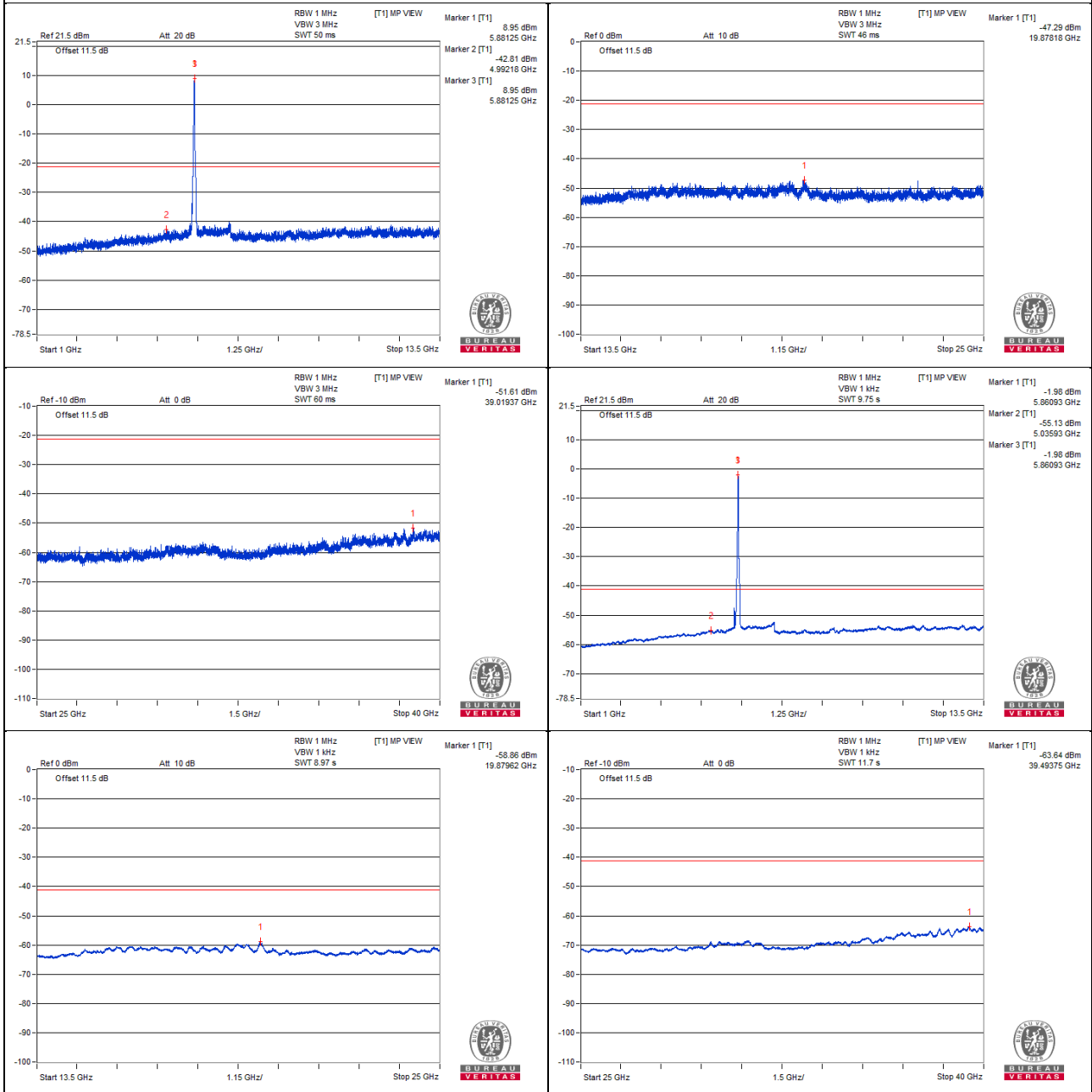

Bandedge

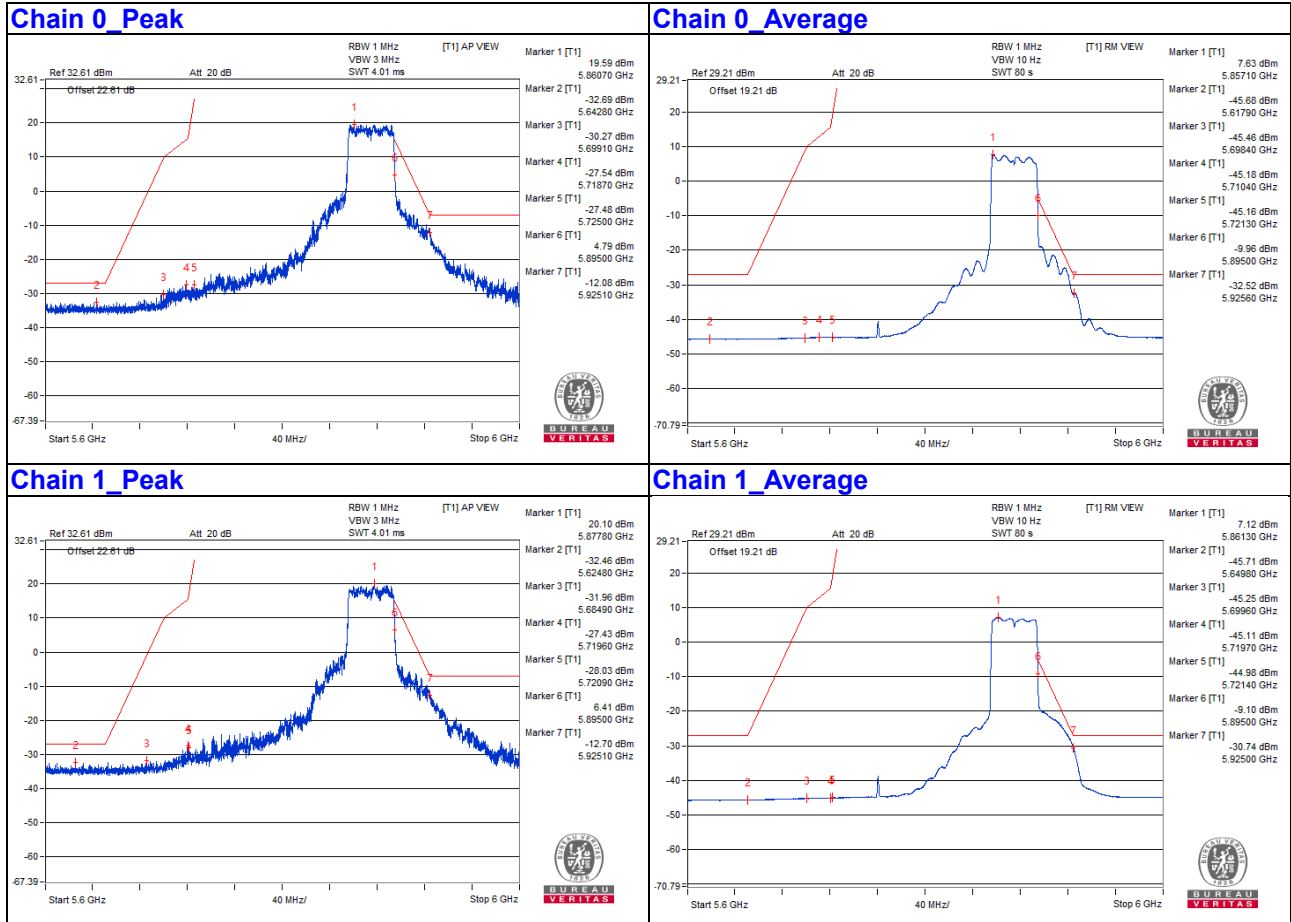

Note:

1. The offset including attenuator (10 dB), cable loss (1.5 dB), directional gain (8.1 dBi) and number of outputs (10 log (2)=3.01 dB).
2. The test results were EIRP.

802.11ax (RU996)

Channel 171

Conducted spurious emission table

No.	Frequency (MHz)	Emission Level (dBuV/m)	Limit (dBuV/m)	Margin (dB)	Raw Value (dBm)		Correction Factor (dB)	EIRP Level (dBm)
					Chain0	Chain1		
1	3917.18	60.65 PK	74	-13.35	-46.24	-45.38	8.17	-34.61
2	3917.18	49.47 AV	54	-4.53	-57.2	-56.76	8.17	-45.79
3	#7790.62	62.15 PK	68.2	-6.05	-44	-44.6	8.17	-33.11
4	11690.62	63.49 PK	74	-10.51	-43.2	-42.72	8.17	-31.77
5	11690.62	52.29 AV	54	-1.71	-53.99	-54.32	8.17	-42.97
6	#17575.31	56.3 PK	68.2	-11.9	-49.34	-51.12	8.17	-38.96

Remarks:

1. Margin value = Emission Level – Limit value
2. The other emission levels were very low against the limit.
3. " # " : The frequency is out of the restricted band.

Chain 0

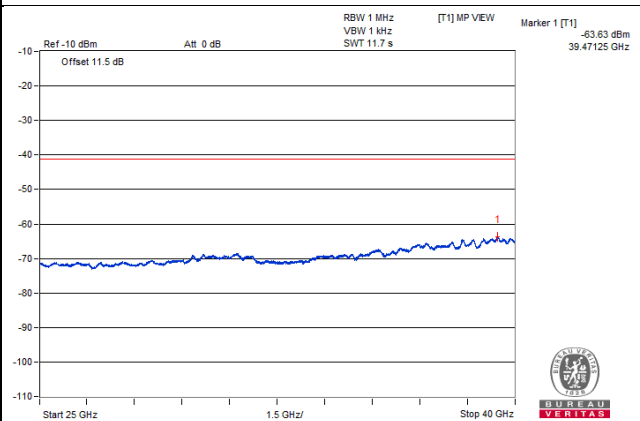
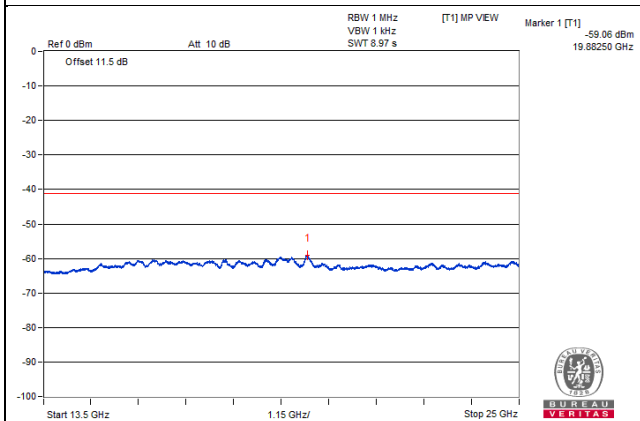
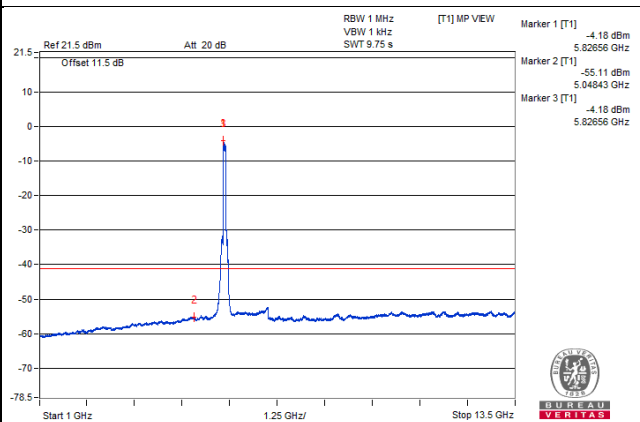
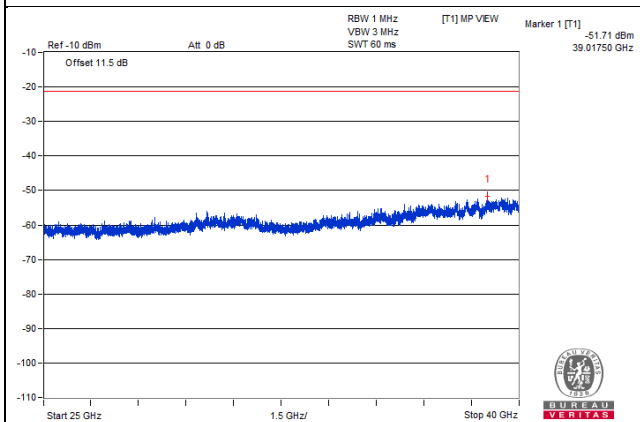
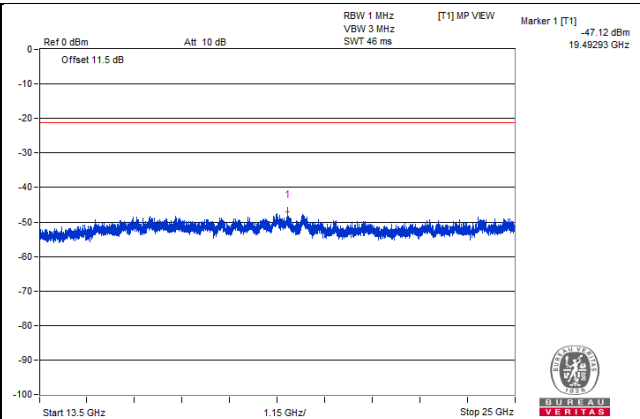
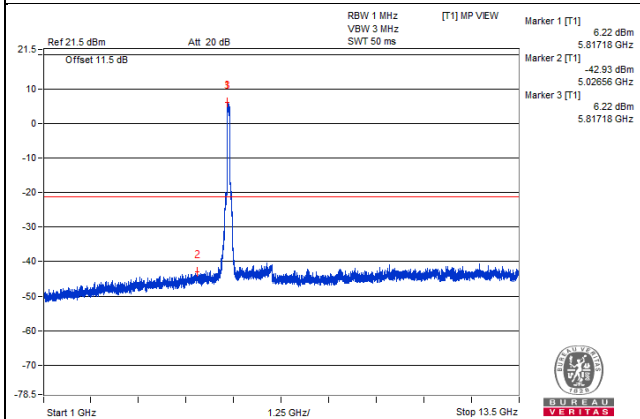

Chain 1

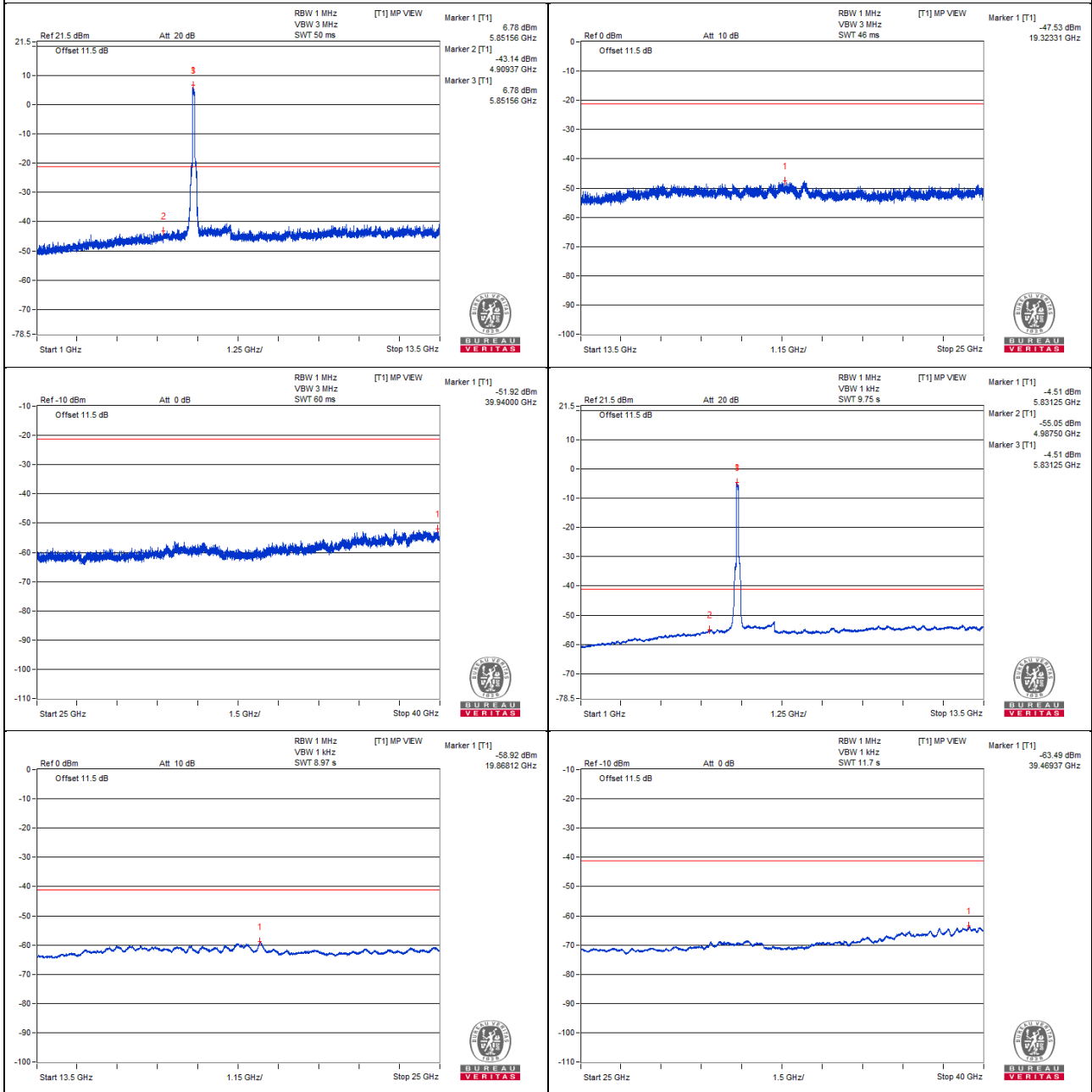

Bandedge

Chain 0_Peak

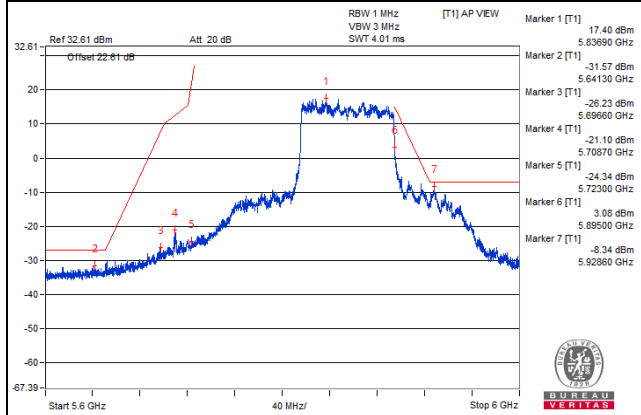

Chain 0_Average

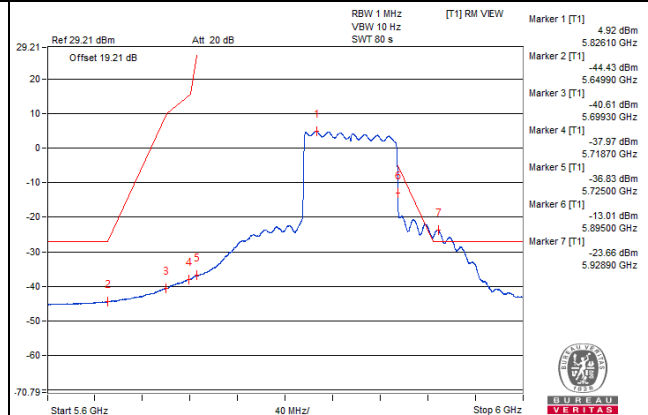

Chain 1_Peak

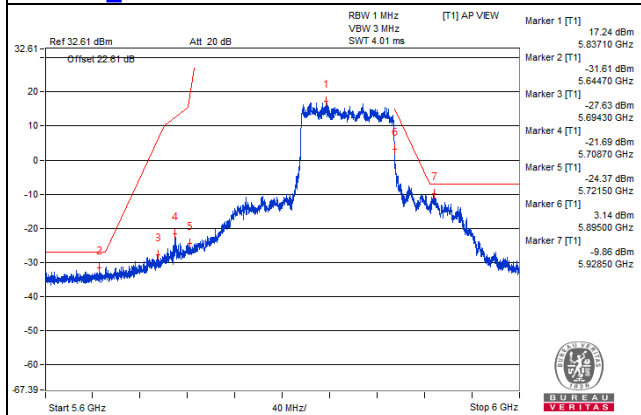

Chain 1_Average

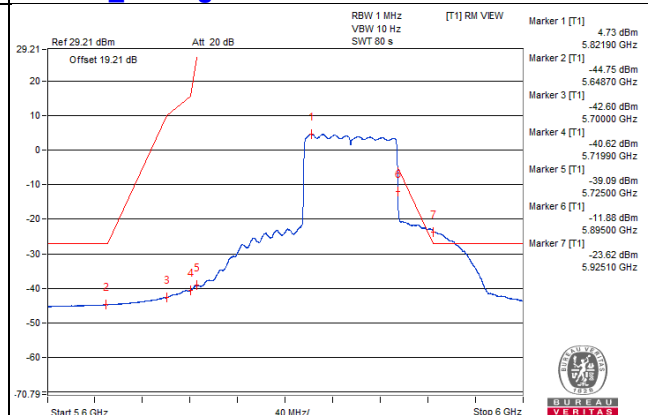

Note:

1. The offset including attenuator (10 dB), cable loss (1.5 dB), directional gain (8.1 dBi) and number of outputs ($10 \log(2) = 3.01$ dB).
2. The test results were EIRP.
3. The emission was verified and the test result was passed by radiated measurement. (Please refer Appendix A)

802.11ax (RU1992)

Channel 163

Conducted spurious emission table

No.	Frequency (MHz)	Emission Level (dBuV/m)	Limit (dBuV/m)	Margin (dB)	Raw Value (dBm)		Correction Factor (dB)	EIRP Level (dBm)
					Chain0	Chain1		
1	3864.06	60.49 PK	74	-13.51	-45.42	-46.55	8.17	-34.77
2	3889.06	49.47 AV	54	-4.53	-57.01	-56.93	8.17	-45.79
3	#7771.87	62.78 PK	68.2	-5.42	-43.77	-43.56	8.17	-32.48
4	11635.93	64.55 PK	74	-9.45	-41.66	-42.13	8.17	-30.71
5	11628.12	52.95 AV	54	-1.05	-53.58	-53.41	8.17	-42.31
6	#17441.62	56.63 PK	68.2	-11.57	-51.28	-48.72	8.17	-38.63

Remarks:

1. Margin value = Emission Level – Limit value
2. The other emission levels were very low against the limit.
3. " # " : The frequency is out of the restricted band.

Chain 0

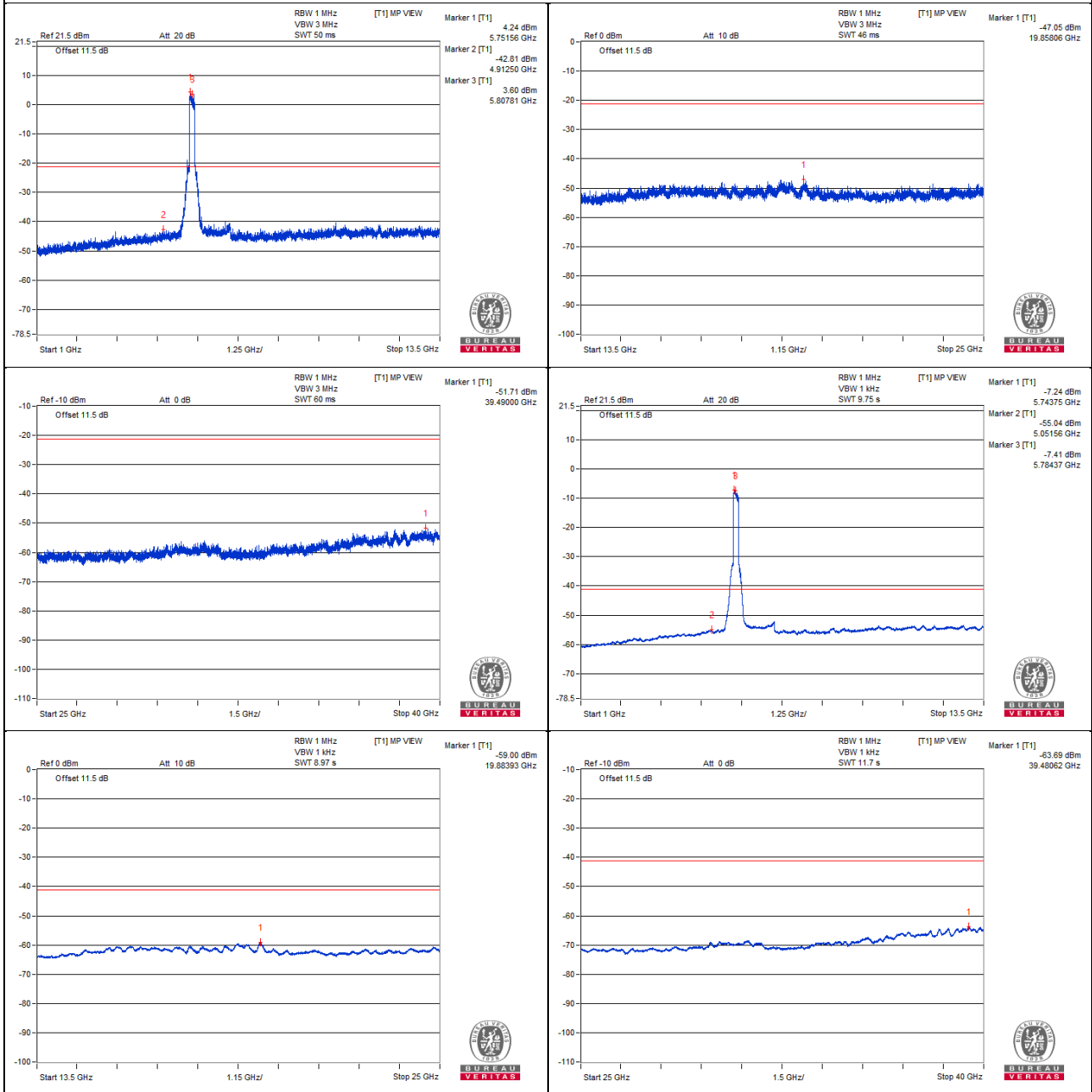

Chain 1

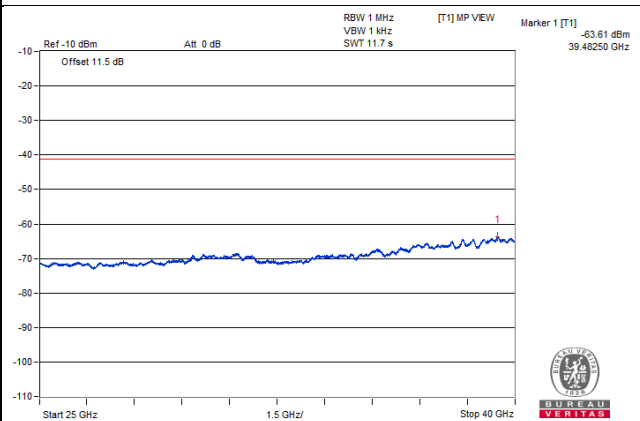
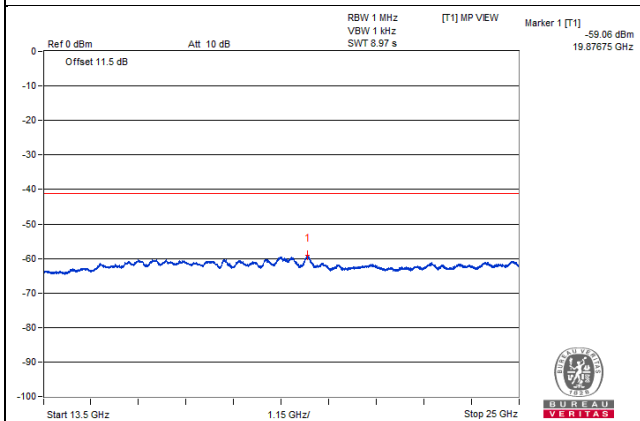
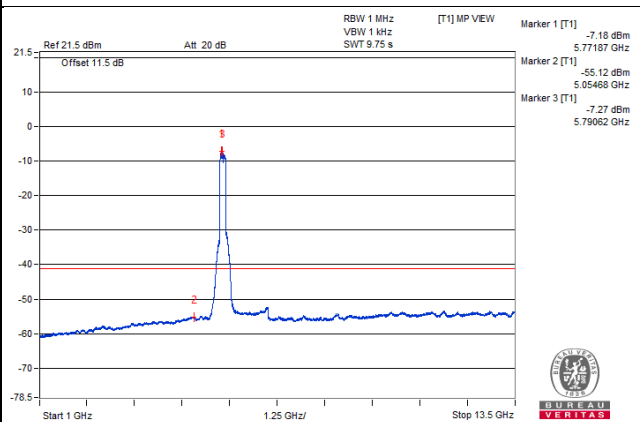
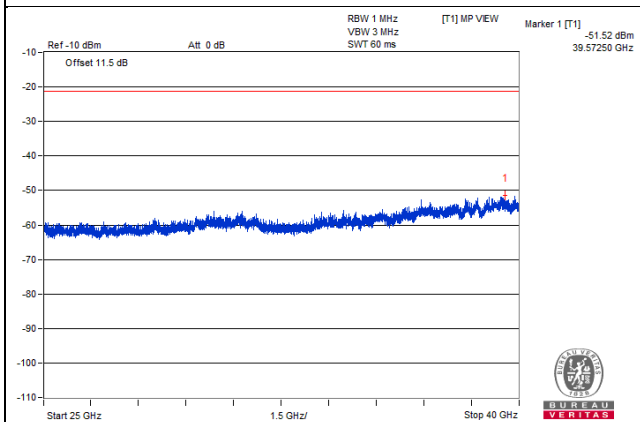
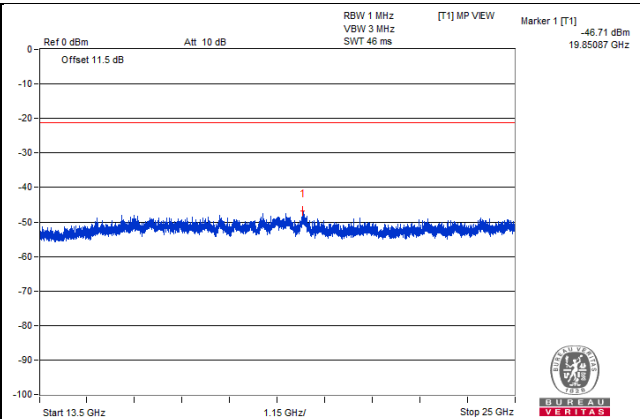
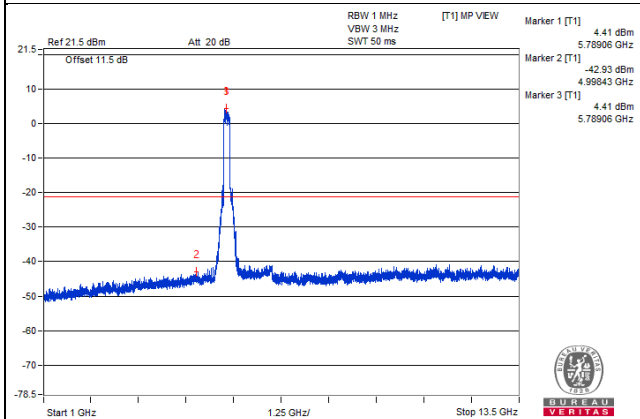

Bandedge

Chain 0_Peak

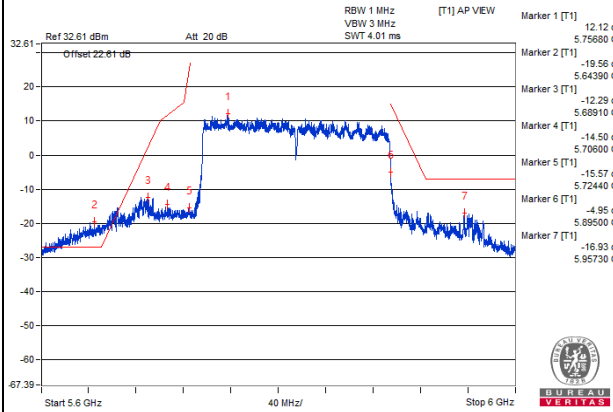

Chain 0_Average

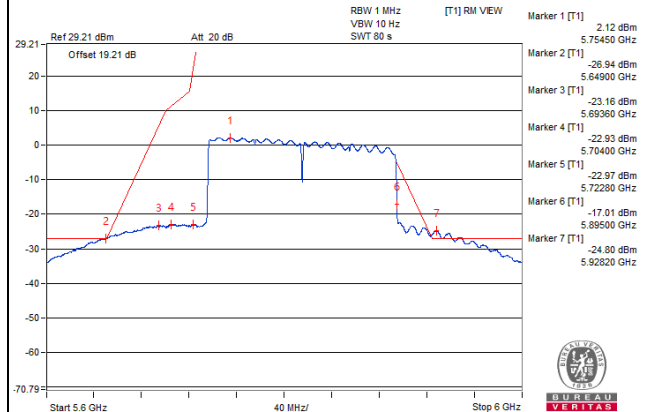

Chain 1_Peak

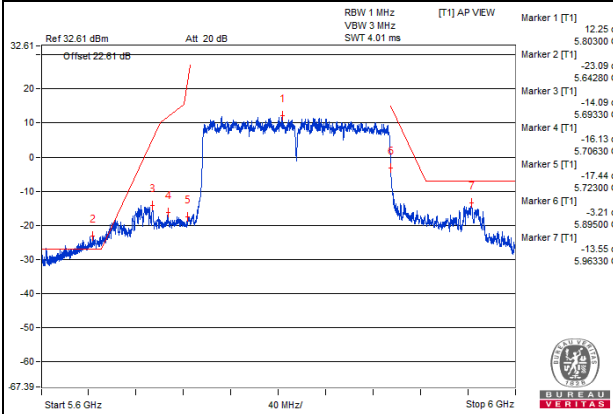

Chain 1_Average

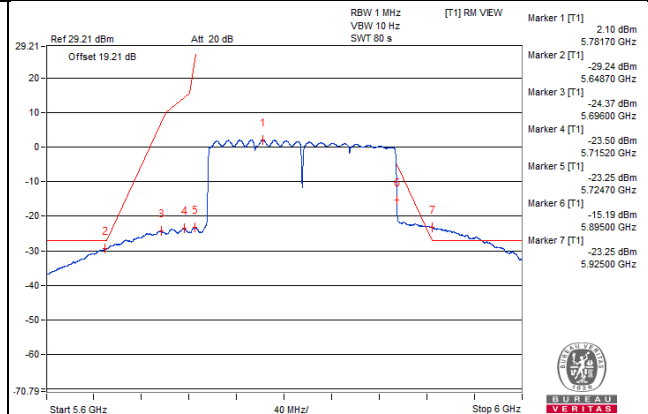

Note:

1. The offset including attenuator (10 dB), cable loss (1.5 dB), directional gain (8.1 dBi) and number of outputs (10 log (2))=3.01 dB).
2. The test results were EIRP.
3. The emission was verified and the test result was passed by radiated measurement. (Please refer Appendix A)

Below 1GHz Data:

802.11ax (HE40) - Channel 175

No.	Frequency (MHz)	Emission Level (dBuV/m)	Limit (dBuV/m)	Margin (dB)	Raw Value (dBm)		Correction Factor (dB)	EIRP Level (dBm)
					Chain0	Chain1		
1	51.94	31.34	40	-8.66	-74.67	-75.57	8.17	-63.92
2	188.35	32.17	43.5	-11.33	-74.78	-73.81	8.17	-63.09
3	356.28	32.27	46	-13.73	-73.14	-75.52	8.17	-62.99
4	557.68	32.8	46	-13.2	-72.86	-74.6	8.17	-62.46
5	798.36	33.66	46	-12.34	-72.25	-73.39	8.17	-61.60
6	928.58	33.7	46	-12.3	-72.01	-73.61	8.17	-61.56

Remarks:

1. Margin value = Emission Level – Limit value
2. The other emission levels were very low against the limit.

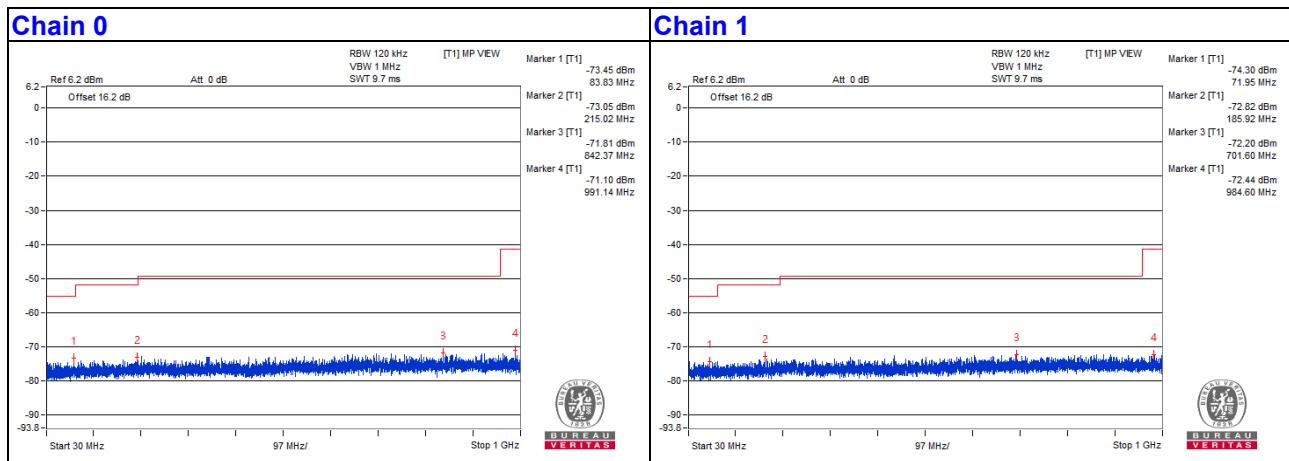

4.2 Conducted Emission Measurement

4.2.1 Limits of Conducted Emission Measurement

Frequency (MHz)	Conducted Limit (dBuV)	
	Quasi-peak	Average
0.15 - 0.5	66 - 56	56 - 46
0.50 - 5.0	56	46
5.0 - 30.0	60	50

Note: 1. The lower limit shall apply at the transition frequencies.

2. The limit decreases in line with the logarithm of the frequency in the range of 0.15 to 0.50MHz.

4.2.2 Test Instruments

DESCRIPTION & MANUFACTURER	MODEL NO.	SERIAL NO.	CALIBRATED DATE	CALIBRATED UNTIL
Test Receiver R&S	ESCS 30	847124/029	Oct. 20, 2020	Oct. 19, 2021
Line-Impedance Stabilization Network (for EUT) R&S	ESH3-Z5	848773/004	Oct. 27, 2020	Oct. 26, 2021
Line-Impedance Stabilization Network (for Peripheral) R&S	ESH3-Z5	835239/001	Mar. 26, 2021	Mar. 25, 2022
50 ohms Terminator	50	3	Oct. 26, 2020	Oct. 25, 2021
RF Cable	5D-FB	COCCAB-001	Sep. 26, 2020	Sep. 25, 2021
Fixed attenuator EMCI	STI02-2200-10	005	Aug. 29, 2020	Aug. 28, 2021
Software BVADT	BVADT_Cond_V7.3.7.4	NA	NA	NA

Note:

1. The calibration interval of the above test instruments are 12 months and the calibrations are traceable to NML/ROC and NIST/USA.
2. The test was performed in Conduction 1.
- 3 Tested Date: Aug. 04, 2021

4.2.3 Test Procedure

- The EUT was placed 0.4 meters from the conducting wall of the shielded room with EUT being connected to the power mains through a line impedance stabilization network (LISN). Other support units were connected to the power mains through another LISN. The two LISNs provide 50 ohm/ 50uH of coupling impedance for the measuring instrument.
- Both lines of the power mains connected to the EUT were checked for maximum conducted interference.
- The frequency range from 150kHz to 30MHz was searched. Emission levels under (Limit - 20dB) was not recorded.

Note: All modes of operation were investigated and the worst-case emissions are reported.

4.2.4 Test Setup

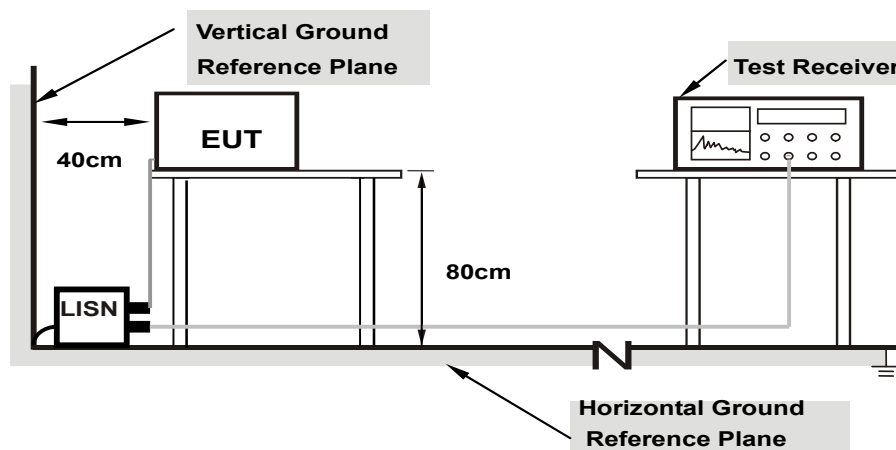

Note: 1.Support units were connected to second LISN.

For the actual test configuration, please refer to the attached file (Test Setup Photo).

4.2.5 EUT Operating Condition

Same as 4.1.5.

4.2.6 Test Results

RF Mode	TX 802.11ax (HE40)	Channel	CH 175 : 5875 MHz
Frequency Range	150kHz ~ 30MHz	Detector Function & Resolution Bandwidth	Quasi-Peak (QP) / Average (AV), 9kHz

Phase Of Power : Line (L)										
No	Frequency (MHz)	Correction Factor (dB)	Reading Value (dBuV)		Emission Level (dBuV)		Limit (dBuV)		Margin (dB)	
			Q.P.	AV.	Q.P.	AV.	Q.P.	AV.	Q.P.	AV.
1	0.15048	9.95	39.54	25.49	49.49	35.44	65.97	55.97	-16.48	-20.53
2	0.21464	9.97	30.24	15.71	40.21	25.68	63.02	53.02	-22.81	-27.34
3	0.38140	9.99	24.50	8.71	34.49	18.70	58.25	48.25	-23.76	-29.55
4	0.58547	10.00	32.48	24.36	42.48	34.36	56.00	46.00	-13.52	-11.64
5	0.91980	10.02	18.54	14.27	28.56	24.29	56.00	46.00	-27.44	-21.71
6	15.20527	10.84	26.26	20.71	37.10	31.55	60.00	50.00	-22.90	-18.45

Remarks:

1. Q.P. and AV. are abbreviations of quasi-peak and average individually.
2. The emission levels of other frequencies were very low against the limit.
3. Margin value = Emission level – Limit value
4. Correction factor = Insertion loss + Cable loss
5. Emission Level = Correction Factor + Reading Value

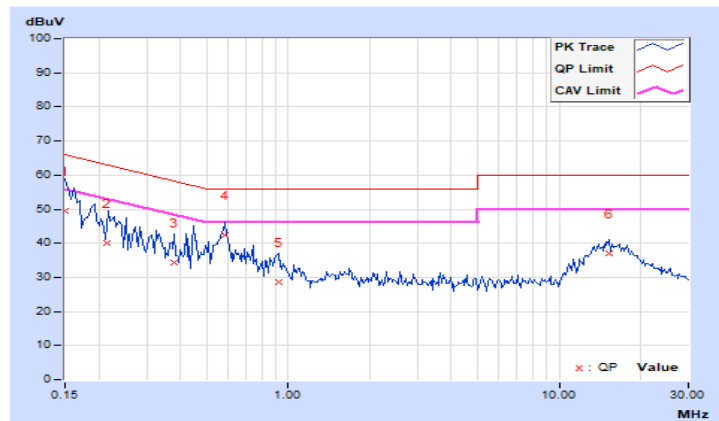

RF Mode	TX 802.11ax (HE40)	Channel	CH 175 : 5875 MHz
Frequency Range	150kHz ~ 30MHz	Detector Function & Resolution Bandwidth	Quasi-Peak (QP) / Average (AV), 9kHz

Phase Of Power : Neutral (N)										
No	Frequency (MHz)	Correction Factor (dB)	Reading Value (dBuV)		Emission Level (dBuV)		Limit (dBuV)		Margin (dB)	
			Q.P.	AV.	Q.P.	AV.	Q.P.	AV.	Q.P.	AV.
1	0.18147	9.94	33.28	18.28	43.22	28.22	64.42	54.42	-21.20	-26.20
2	0.27526	9.95	28.01	10.29	37.96	20.24	60.96	50.96	-23.00	-30.72
3	0.54018	9.97	22.23	12.72	32.20	22.69	56.00	46.00	-23.80	-23.31
4	1.16039	10.01	13.29	4.30	23.30	14.31	56.00	46.00	-32.70	-31.69
5	3.05884	10.08	12.24	1.75	22.32	11.83	56.00	46.00	-33.68	-34.17
6	17.05442	10.72	20.01	13.31	30.73	24.03	60.00	50.00	-29.27	-25.97

Remarks:

1. Q.P. and AV. are abbreviations of quasi-peak and average individually.
2. The emission levels of other frequencies were very low against the limit.
3. Margin value = Emission level – Limit value
4. Correction factor = Insertion loss + Cable loss
5. Emission Level = Correction Factor + Reading Value

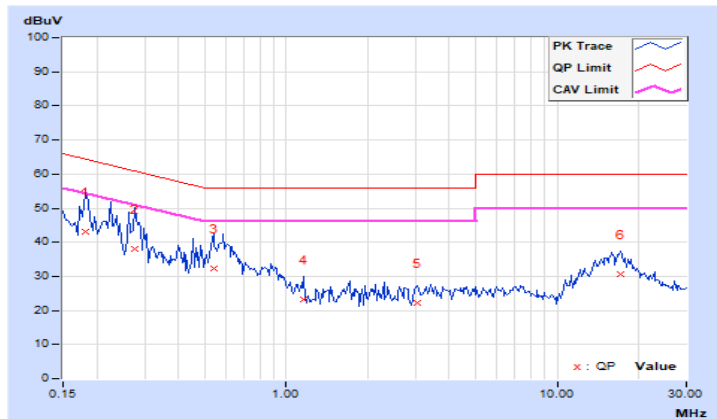

4.3 Transmit Power Measurement

4.3.1 Limits of Transmit Power Measurement

Device Category		Limit (Max Average Power)
<input type="checkbox"/>	Indoor access point	EIRP 36 dBm
<input type="checkbox"/>	Subordinate device	EIRP 36 dBm
<input checked="" type="checkbox"/>	Client device	EIRP 30 dBm

Note: For all U-NII-4 and U-NII-3 & -4 span channels shall met above EIRP values.

Per KDB 662911 Method of conducted output power measurement on IEEE 802.11 devices,

Array Gain = 0 dB (i.e., no array gain) for $N_{ANT} \leq 4$;

Array Gain = 0 dB (i.e., no array gain) for channel widths ≥ 40 MHz for any N_{ANT} ;

Array Gain = $5 \log(N_{ANT}/N_{SS})$ dB or 3 dB, whichever is less for 20-MHz channel widths with $N_{ANT} \geq 5$.

For power measurements on all other devices: Array Gain = $10 \log(N_{ANT}/N_{SS})$ dB.

4.3.2 Test Setup

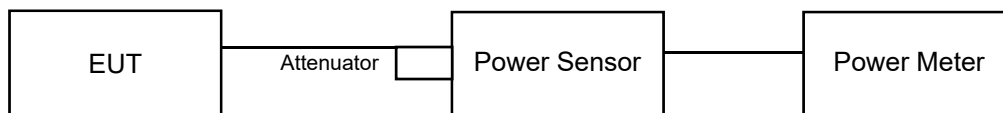

4.3.3 Test Instruments

Refer to section 4.1.2 to get information of above instrument.

4.3.4 Test Procedure

Method PM is used to perform output power measurement, trigger and gating function of wide band power meter is enabled to measure max output power of TX on burst. Duty factor is not added to measured value.

4.3.5 EUT Operating Condition

The software provided by client to enable the EUT under transmission condition continuously at lowest, middle and highest channel frequencies individually.

4.3.6 Test Result

Directional Gain Calculation

Directional gain = 5.09 dBi + 10log(2) = 8.1 dBi (Antenna Model: 260-25083)

Directional gain = 4.71 dBi + 10log(2) = 7.72 dBi (Antenna Model: 260-25084)

The highest directional gain used for EIRP calculation.

802.11a

Conducted Power:

Chan.	Chan. Freq. (MHz)	Average Power (dBm)		Total Power (mW)	Total Power (dBm)
		Chain 0	Chain 1		
169	5845	12.68	12.91	38.079	15.81
173	5865	12.56	12.97	37.845	15.78
177	5885	12.96	12.54	37.717	15.77

EIRP:

Chan.	Chan. Freq. (MHz)	Total Power (dBm)	Directional Gain (dBi)	EIRP (mW)	EIRP (dBm)	EIRP Limit (dBm)	Pass / Fail
169	5845	15.81	8.1	246.037	23.91	30	Pass
173	5865	15.78	8.1	244.343	23.88	30	Pass
177	5885	15.77	8.1	243.781	23.87	30	Pass

802.11ac (VHT20)

Conducted Power:

Chan.	Chan. Freq. (MHz)	Average Power (dBm)		Total Power (mW)	Total Power (dBm)
		Chain 0	Chain 1		
169	5845	13.01	13.15	40.652	16.09
173	5865	12.84	13.14	39.837	16.00
177	5885	13.01	12.73	38.749	15.88

EIRP:

Chan.	Chan. Freq. (MHz)	Total Power (dBm)	Directional Gain (dBi)	EIRP (mW)	EIRP (dBm)	EIRP Limit (dBm)	Pass / Fail
169	5845	16.09	8.1	262.422	24.19	30	Pass
173	5865	16.00	8.1	257.04	24.10	30	Pass
177	5885	15.88	8.1	250.035	23.98	30	Pass

802.11ac (VHT40)

Conducted Power:

Chan.	Chan. Freq. (MHz)	Average Power (dBm)		Total Power (mW)	Total Power (dBm)
		Chain 0	Chain 1		
167	5835	15.08	15.41	66.964	18.26
175	5875	15.19	15.31	66.999	18.26

EIRP:

Chan.	Chan. Freq. (MHz)	Total Power (dBm)	Directional Gain (dBi)	EIRP (mW)	EIRP (dBm)	EIRP Limit (dBm)	Pass / Fail
167	5835	18.26	8.1	432.514	26.36	30	Pass
175	5875	18.26	8.1	432.514	26.36	30	Pass

802.11ac (VHT80)

Conducted Power:

Chan.	Chan. Freq. (MHz)	Average Power (dBm)		Total Power (mW)	Total Power (dBm)
		Chain 0	Chain 1		
171	5855	14.62	14.88	59.734	17.76

EIRP:

Chan.	Chan. Freq. (MHz)	Total Power (dBm)	Directional Gain (dBi)	EIRP (mW)	EIRP (dBm)	EIRP Limit (dBm)	Pass / Fail
171	5855	17.76	8.1	385.478	25.86	30	Pass

802.11ac (VHT160)

Conducted Power:

Chan.	Chan. Freq. (MHz)	Average Power (dBm)		Total Power (mW)	Total Power (dBm)
		Chain 0	Chain 1		
163	5815	13.28	13.97	46.227	16.65

EIRP:

Chan.	Chan. Freq. (MHz)	Total Power (dBm)	Directional Gain (dBi)	EIRP (mW)	EIRP (dBm)	EIRP Limit (dBm)	Pass / Fail
163	5815	16.65	8.1	298.538	24.75	30	Pass

802.11ax (HE20)

Conducted Power:

Chan.	Chan. Freq. (MHz)	Average Power (dBm)		Total Power (mW)	Total Power (dBm)
		Chain 0	Chain 1		
169	5845	13.08	13.37	42.051	16.24
173	5865	13.06	13.38	42.007	16.23
177	5885	13.24	12.96	40.856	16.11

EIRP:

Chan.	Chan. Freq. (MHz)	Total Power (dBm)	Directional Gain (dBi)	EIRP (mW)	EIRP (dBm)	EIRP Limit (dBm)	Pass / Fail
169	5845	16.24	8.1	271.644	24.34	30	Pass
173	5865	16.23	8.1	271.019	24.33	30	Pass
177	5885	16.11	8.1	263.633	24.21	30	Pass

802.11ax (HE40)

Conducted Power:

Chan.	Chan. Freq. (MHz)	Average Power (dBm)		Total Power (mW)	Total Power (dBm)
		Chain 0	Chain 1		
167	5835	15.17	15.45	67.96	18.32
175	5875	15.29	15.39	68.4	18.35

EIRP:

Chan.	Chan. Freq. (MHz)	Total Power (dBm)	Directional Gain (dBi)	EIRP (mW)	EIRP (dBm)	EIRP Limit (dBm)	Pass / Fail
167	5835	18.32	8.1	438.531	26.42	30	Pass
175	5875	18.35	8.1	441.57	26.45	30	Pass

802.11ax (HE80)

Conducted Power:

Chan.	Chan. Freq. (MHz)	Average Power (dBm)		Total Power (mW)	Total Power (dBm)
		Chain 0	Chain 1		
171	5855	14.69	14.94	60.633	17.83

EIRP:

Chan.	Chan. Freq. (MHz)	Total Power (dBm)	Directional Gain (dBi)	EIRP (mW)	EIRP (dBm)	EIRP Limit (dBm)	Pass / Fail
171	5855	17.83	8.1	391.742	25.93	30	Pass

802.11ax (HE160)

Conducted Power:

Chan.	Chan. Freq. (MHz)	Average Power (dBm)		Total Power (mW)	Total Power (dBm)
		Chain 0	Chain 1		
163	5815	13.33	14.06	46.996	16.72

EIRP:

Chan.	Chan. Freq. (MHz)	Total Power (dBm)	Directional Gain (dBi)	EIRP (mW)	EIRP (dBm)	EIRP Limit (dBm)	Pass / Fail
163	5815	16.72	8.1	303.389	24.82	30	Pass

802.11ax (RU26)

Conducted Power:

RU Configuration	Chan.	Chan. Freq. (MHz)	Average Power (dBm)		Total Power (mW)	Total Power (dBm)
			Chain 0	Chain 1		
26/0	169	5845	6.45	5.53	7.988	9.02
26/4	173	5865	6.30	6.09	8.33	9.21
26/8	177	5885	5.72	6.23	7.93	8.99

EIRP:

RU Configuration	Chan.	Chan. Freq. (MHz)	Total Power (dBm)	Directional Gain (dBi)	EIRP (mW)	EIRP (dBm)	EIRP Limit (dBm)	Pass / Fail
26/0	169	5845	9.02	8.1	51.523	17.12	30	Pass
26/4	173	5865	9.21	8.1	53.827	17.31	30	Pass
26/8	177	5885	8.99	8.1	51.168	17.09	30	Pass

802.11ax (RU52)

Conducted Power:

RU Configuration	Chan.	Chan. Freq. (MHz)	Average Power (dBm)		Total Power (mW)	Total Power (dBm)
			Chain 0	Chain 1		
52/37	169	5845	9.02	9.14	16.183	12.09
52/38	173	5865	8.15	9.98	16.485	12.17
52/40	177	5885	8.26	9.43	15.469	11.89

EIRP:

RU Configuration	Chan.	Chan. Freq. (MHz)	Total Power (dBm)	Directional Gain (dBi)	EIRP (mW)	EIRP (dBm)	EIRP Limit (dBm)	Pass / Fail
52/37	169	5845	12.09	8.1	104.472	20.19	30	Pass
52/38	173	5865	12.17	8.1	106.414	20.27	30	Pass
52/40	177	5885	11.89	8.1	99.77	19.99	30	Pass

802.11ax (RU106)

Conducted Power:

RU Configuration	Chan.	Chan. Freq. (MHz)	Average Power (dBm)		Total Power (mW)	Total Power (dBm)
			Chain 0	Chain 1		
106/53	169	5845	11.68	12.29	31.667	15.01
106/53	173	5865	11.72	12.14	31.228	14.95
106/54	177	5885	12.21	12.10	32.852	15.17

EIRP:

RU Configuration	Chan.	Chan. Freq. (MHz)	Total Power (dBm)	Directional Gain (dBi)	EIRP (mW)	EIRP (dBm)	EIRP Limit (dBm)	Pass / Fail
106/53	169	5845	15.01	8.1	204.644	23.11	30	Pass
106/53	173	5865	14.95	8.1	201.837	23.05	30	Pass
106/54	177	5885	15.17	8.1	212.324	23.27	30	Pass

802.11ax (RU242)

Conducted Power:

RU Configuration	Chan.	Chan. Freq. (MHz)	Average Power (dBm)		Total Power (mW)	Total Power (dBm)
			Chain 0	Chain 1		
242/61	169	5845	14.35	14.60	56.067	17.49
242/61	173	5865	14.26	14.65	55.843	17.47
242/61	177	5885	14.48	14.28	54.846	17.39

EIRP:

RU Configuration	Chan.	Chan. Freq. (MHz)	Total Power (dBm)	Directional Gain (dBi)	EIRP (mW)	EIRP (dBm)	EIRP Limit (dBm)	Pass / Fail
242/61	169	5845	17.49	8.1	362.243	25.59	30	Pass
242/61	173	5865	17.47	8.1	360.579	25.57	30	Pass
242/61	177	5885	17.39	8.1	353.997	25.49	30	Pass

802.11ax (RU484)

Conducted Power:

RU Configuration	Chan.	Chan. Freq. (MHz)	Average Power (dBm)		Total Power (mW)	Total Power (dBm)
			Chain 0	Chain 1		
484/65	167	5835	14.68	14.58	58.084	17.64
484/65	175	5875	14.59	14.77	58.766	17.69

EIRP:

RU Configuration	Chan.	Chan. Freq. (MHz)	Total Power (dBm)	Directional Gain (dBi)	EIRP (mW)	EIRP (dBm)	EIRP Limit (dBm)	Pass / Fail
484/65	167	5835	17.64	8.1	374.973	25.74	30	Pass
484/65	175	5875	17.69	8.1	379.315	25.79	30	Pass

802.11ax (RU996)

Conducted Power:

RU Configuration	Chan.	Chan. Freq. (MHz)	Average Power (dBm)		Total Power (mW)	Total Power (dBm)
			Chain 0	Chain 1		
996/67	171	5855	14.39	14.41	55.085	17.41

EIRP:

RU Configuration	Chan.	Chan. Freq. (MHz)	Total Power (dBm)	Directional Gain (dBi)	EIRP (mW)	EIRP (dBm)	EIRP Limit (dBm)	Pass / Fail
996/67	171	5855	17.41	8.1	355.631	25.51	30	Pass

802.11ax (RU1992)

Conducted Power:

RU Configuration	Chan.	Chan. Freq. (MHz)	Average Power (dBm)		Total Power (mW)	Total Power (dBm)
			Chain 0	Chain 1		
1992/68	163	5815	11.69	11.74	29.685	14.73

EIRP:

RU Configuration	Chan.	Chan. Freq. (MHz)	Total Power (dBm)	Directional Gain (dBi)	EIRP (mW)	EIRP (dBm)	EIRP Limit (dBm)	Pass / Fail
1992/68	163	5815	14.73	8.1	191.867	22.83	30	Pass

4.4 6dB Bandwidth Measurement

4.4.1 Limits of Emission Bandwidth Measurement

Within the 5.725-5.850 GHz and 5.850-5.895 GHz bands, the minimum 6 dB bandwidth of U-NII devices shall be at least 500 kHz.

4.4.2 Test Setup

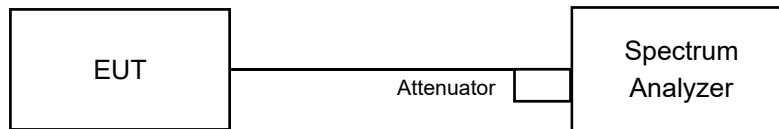

4.4.3 Test Instruments

Refer to section 4.1.2 to get information of above instrument.

4.4.4 Test Procedure

- a. Set resolution bandwidth (RBW) = 100kHz
- b. Set the video bandwidth (VBW) $\geq 3 \times$ RBW, Detector = Peak.
- c. Trace mode = max hold.
- d. Sweep = auto couple.
- e. Measure the maximum width of the emission that is constrained by the frequencies associated with the two amplitude points (upper and lower) that are attenuated by 6 dB relative to the maximum level measured in the fundamental emission

4.4.5 EUT Operating Condition

Same as Item 4.3.5.

4.4.6 Test Results

802.11a

Channel	Frequency (MHz)	6dB Bandwidth (MHz)		Minimum Limit (MHz)	Pass / Fail
		Chain 0	Chain 1		
169	5845	15.14	15.18	0.5	Pass
173	5865	15.14	15.17	0.5	Pass
177	5885	15.17	15.16	0.5	Pass

802.11ax (HE20)

Channel	Frequency (MHz)	6dB Bandwidth (MHz)		Minimum Limit (MHz)	Pass / Fail
		Chain 0	Chain 1		
169	5845	15.34	15.23	0.5	Pass
173	5865	16.07	15.81	0.5	Pass
177	5885	16.11	16.16	0.5	Pass

802.11ax (HE40)

Channel	Frequency (MHz)	6dB Bandwidth (MHz)		Minimum Limit (MHz)	Pass / Fail
		Chain 0	Chain 1		
167	5835	35.62	35.25	0.5	Pass
175	5875	34.31	36.14	0.5	Pass

802.11ax (HE80)

Channel	Frequency (MHz)	6dB Bandwidth (MHz)		Minimum Limit (MHz)	Pass / Fail
		Chain 0	Chain 1		
171	5855	67.81	74.05	0.5	Pass

802.11ax (HE160)

Channel	Frequency (MHz)	6dB Bandwidth (MHz)		Minimum Limit (MHz)	Pass / Fail
		Chain 0	Chain 1		
163	5815	130.54	109.18	0.5	Pass

802.11ax (RU26)

RU Configuration	Channel	Frequency (MHz)	6dB Bandwidth (MHz)		Minimum Limit (MHz)	Pass / Fail
			Chain 0	Chain 1		
26/0	169	5845	2.1	17.06	0.5	Pass
26/4	173	5865	2.67	15.01	0.5	Pass
26/8	177	5885	14.57	2.12	0.5	Pass

802.11ax (RU52)

RU Configuration	Channel	Frequency (MHz)	6dB Bandwidth (MHz)		Minimum Limit (MHz)	Pass / Fail
			Chain 0	Chain 1		
52/37	169	5845	15.86	17.12	0.5	Pass
52/38	173	5865	15.1	15.15	0.5	Pass
52/40	177	5885	17.15	17.13	0.5	Pass

802.11ax (RU106)

RU Configuration	Channel	Frequency (MHz)	6dB Bandwidth (MHz)		Minimum Limit (MHz)	Pass / Fail
			Chain 0	Chain 1		
106/53	169	5845	17.21	18.11	0.5	Pass
106/53	173	5865	17.22	18.18	0.5	Pass
106/54	177	5885	17.17	17.41	0.5	Pass

802.11ax (RU242)

RU Configuration	Channel	Frequency (MHz)	6dB Bandwidth (MHz)		Minimum Limit (MHz)	Pass / Fail
			Chain 0	Chain 1		
242/61	169	5845	19.08	19.04	0.5	Pass
242/61	173	5865	19.14	19.11	0.5	Pass
242/61	177	5885	19.13	19.12	0.5	Pass

802.11ax (RU484)

RU Configuration	Channel	Frequency (MHz)	6dB Bandwidth (MHz)		Minimum Limit (MHz)	Pass / Fail
			Chain 0	Chain 1		
484/65	167	5835	38.18	38.28	0.5	Pass
484/65	175	5875	38.18	38.33	0.5	Pass

802.11ax (RU996)

RU Configuration	Channel	Frequency (MHz)	6dB Bandwidth (MHz)		Minimum Limit (MHz)	Pass / Fail
			Chain 0	Chain 1		
996/67	171	5855	76.92	78.07	0.5	Pass

802.11ax (RU1992)

RU Configuration	Channel	Frequency (MHz)	6dB Bandwidth (MHz)		Minimum Limit (MHz)	Pass / Fail
			Chain 0	Chain 1		
1992/68	163	5815	157.07	158.29	0.5	Pass

Spectrum Plot of Worst Value

802.11a_Chain 0 / CH169

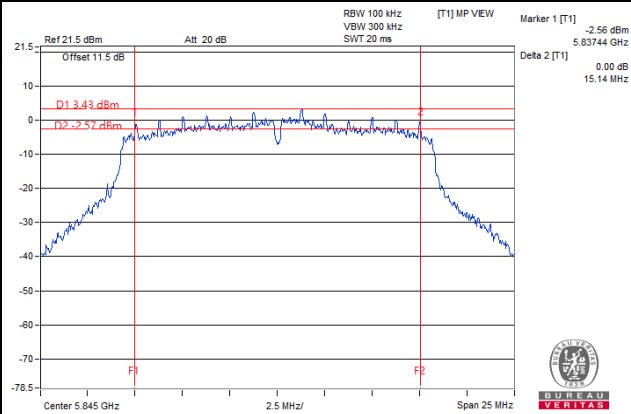

802.11ax (HE20)_Chain 1 / CH169

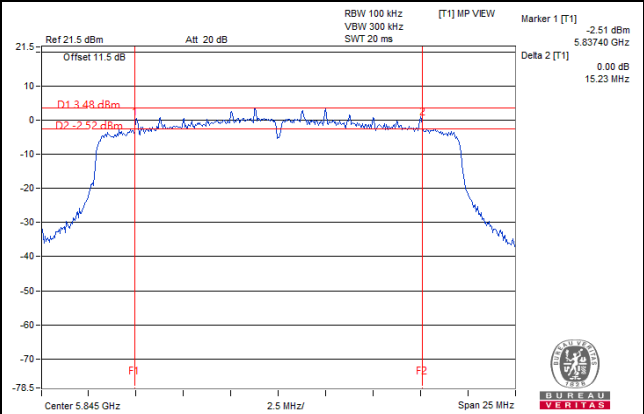

802.11ax (HE40)_Chain 0 / CH175

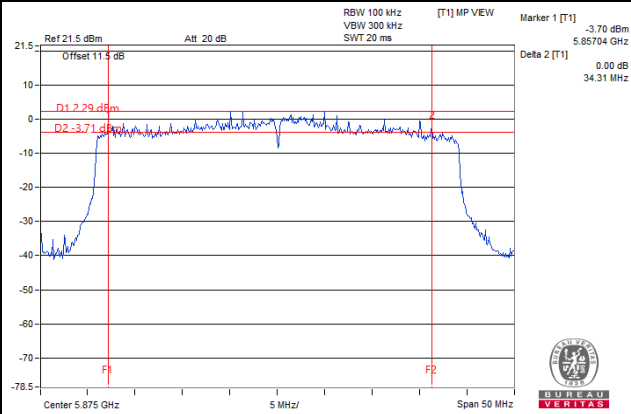

802.11ax (HE80)_Chain 0 / CH171

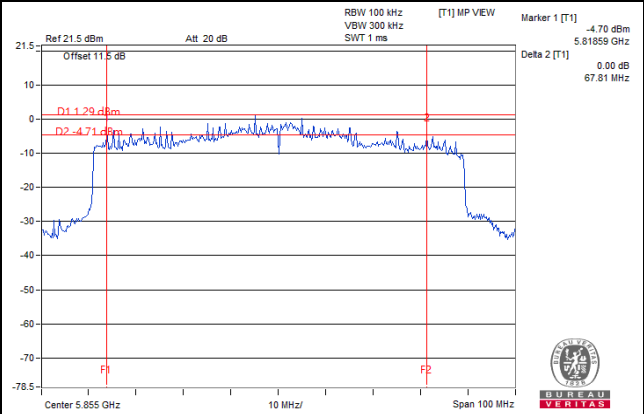

802.11ax (HE160)_Chain 1 / CH163

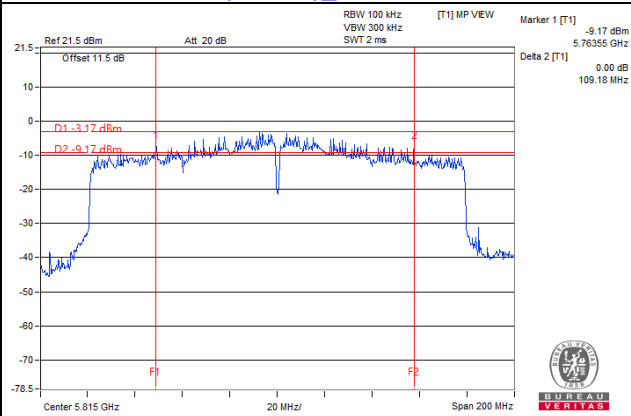

Spectrum Plot of Worst Value

802.11ax (RU26)_Chain 0 / CH169

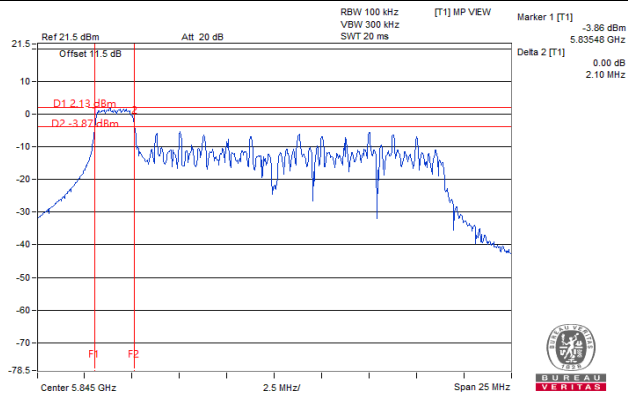

802.11ax (RU52)_Chain 0 / CH173

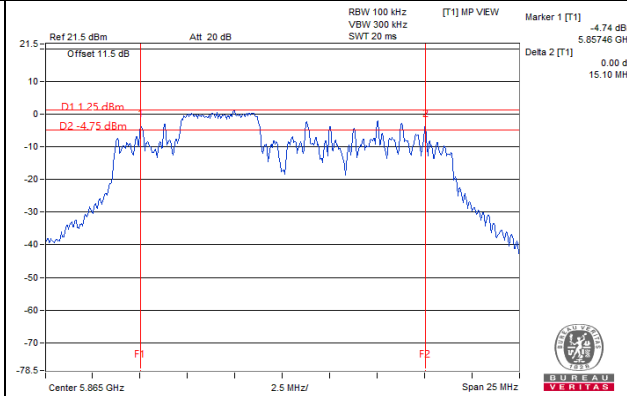

802.11ax (RU106)_Chain 0 / CH177

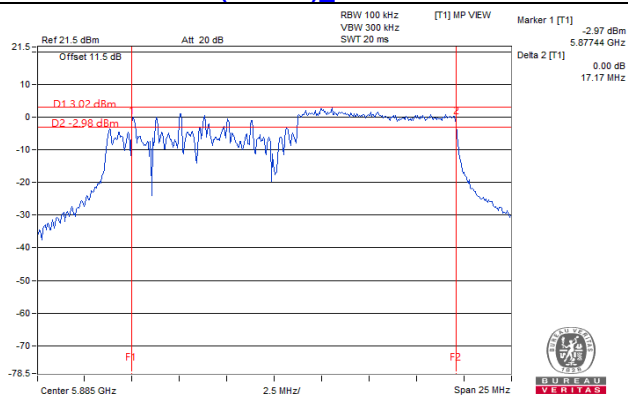

802.11ax (RU242)_Chain 1 / CH169

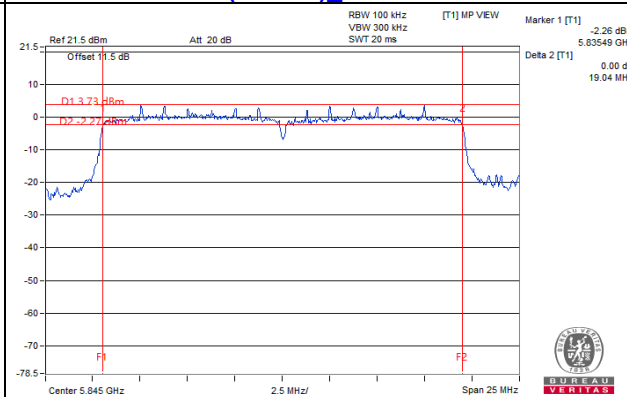

802.11ax (RU484)_Chain 0 / CH167

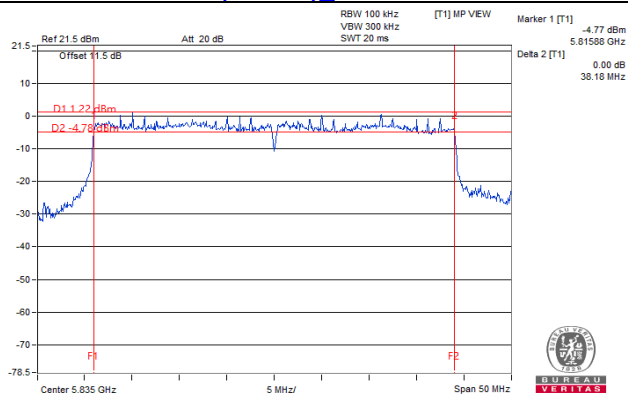

802.11ax (RU996)_Chain 0 / CH171

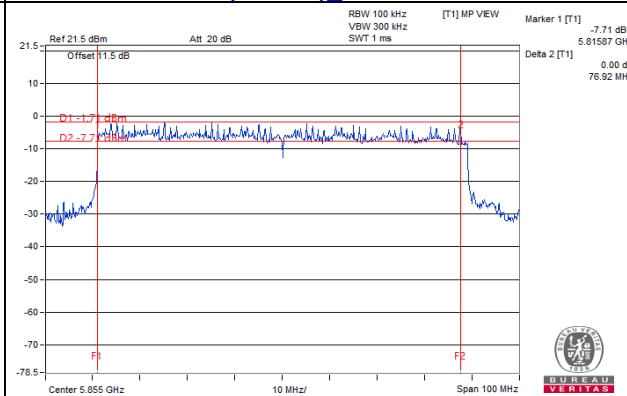

802.11ax (RU1992)_Chain 0 / CH163

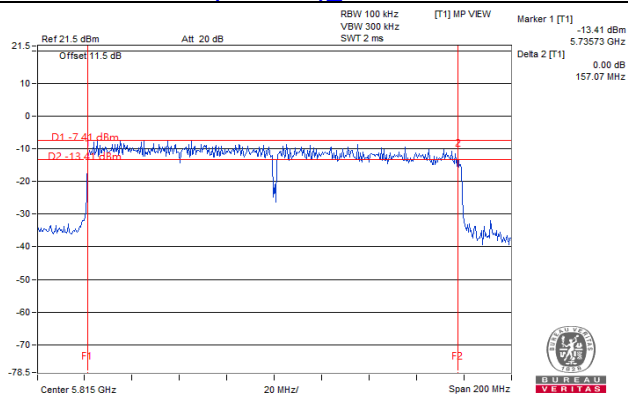

4.5 Peak Power Spectral Density Measurement

4.5.1 Limits of Peak Power Spectral Density Measurement

Device Category		Limit
<input type="checkbox"/>	Indoor access point	EIRP 20 dBm/MHz
<input type="checkbox"/>	Subordinate device	EIRP 20 dBm/MHz
<input checked="" type="checkbox"/>	Client device	EIRP 14 dBm/MHz
Note: For all U-NII-4 and U-NII-3 & -4 span channels shall met above EIRP values.		

4.5.2 Test Setup

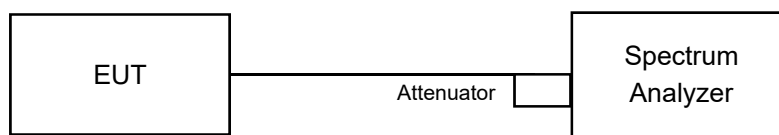

4.5.3 Test Instruments

Refer to section 4.1.2 to get information of above instrument.

4.5.4 Test Procedure

For U-NII-3 & -4 span channels:

1. Set span to encompass the entire emission bandwidth (EBW) of the signal.
2. Set RBW = 300 kHz, Set VBW \geq 1 MHz, Detector = RMS
3. Use the peak marker function to determine the maximum power level in any 300 kHz band segment within the fundamental EBW.
4. Scale the observed power level to an equivalent value in 1 MHz by adjusting (increasing) the measured power by a bandwidth correction factor (BWCF) where $BWCF = 10\log(1 \text{ MHz}/300\text{kHz})$
5. Sweep time = auto, trigger set to "free run".

For fall within U-NII-4 channels:

Using method SA-1

1. Set span to encompass the entire emission bandwidth (EBW) of the signal.
2. Set RBW = 1 MHz, Set VBW \geq 3 MHz, Detector = RMS
3. Sweep time = auto, trigger set to "free run".
4. Trace average at least 100 traces in power averaging mode.
5. Record the max value.

4.5.5 EUT Operating Condition

Same as Item 4.3.5.

4.5.6 Test Results

Directional Gain Calculation									
Directional gain = 5.09 dBi + 10log(2) = 8.1 dBi (Antenna Model: 260-25083)									
Directional gain = 4.71 dBi + 10log(2) = 7.72 dBi (Antenna Model: 260-25084)									
The highest directional gain used for EIRP PSD calculation.									

802.11a

Chan.	Chan. Freq. (MHz)	PSD (dBm/300kHz)		Total PSD (dBm/300kHz)	Total PSD (dBm/MHz)	Directional Gain (dBi)	EIRP PSD (dBm/MHz)	EIRP PSD Limit (dBm/MHz)	Pass / Fail
		Chain 0	Chain 1						
169	5845	-2.19	-2.73	0.56	5.79	8.10	13.89	14.00	Pass

Note: Method b) Measure and sum spectral maxima across the outputs of KDB 662911 is using for calculating total power density.

Chan.	Chan. Freq. (MHz)	PSD (dBm/MHz)		Total PSD (dBm/MHz)	Directional Gain (dBi)	EIRP PSD (dBm/MHz)	EIRP PSD Limit (dBm/MHz)	Pass / Fail
		Chain 0	Chain 1					
173	5865	3.09	2.46	5.80	8.10	13.90	14.00	Pass
177	5885	3.40	2.00	5.77	8.10	13.87	14.00	Pass

Note: Method a) of power density measurement of KDB 662911 is using for calculating total power density. Total power density is summing entire spectra across corresponding frequency bins on the various outputs by computer.

802.11ax (HE20)

Chan.	Chan. Freq. (MHz)	PSD (dBm/300kHz)		Total PSD (dBm/300kHz)	Total PSD (dBm/MHz)	Directional Gain (dBi)	EIRP PSD (dBm/MHz)	EIRP PSD Limit (dBm/MHz)	Pass / Fail
		Chain 0	Chain 1						
169	5845	-2.31	-2.93	0.40	5.63	8.10	13.73	14.00	Pass

Note: Method b) Measure and sum spectral maxima across the outputs of KDB 662911 is using for calculating total power density.

Chan.	Chan. Freq. (MHz)	PSD (dBm/MHz)		Total PSD (dBm/MHz)	Directional Gain (dBi)	EIRP PSD (dBm/MHz)	EIRP PSD Limit (dBm/MHz)	Pass / Fail
		Chain 0	Chain 1					
173	5865	3.16	2.42	5.82	8.10	13.92	14.00	Pass
177	5885	3.13	2.06	5.64	8.10	13.74	14.00	Pass

Note: Method a) of power density measurement of KDB 662911 is using for calculating total power density. Total power density is summing entire spectra across corresponding frequency bins on the various outputs by computer.

802.11ax (HE40)

Chan.	Chan. Freq. (MHz)	PSD (dBm/300kHz)		Total PSD (dBm/300kHz)	Total PSD (dBm/MHz)	Directional Gain (dBi)	EIRP PSD (dBm/MHz)	EIRP PSD Limit (dBm/MHz)	Pass / Fail
		Chain 0	Chain 1						
167	5835	-2.63	-3.19	0.11	5.34	8.10	13.44	14.00	Pass

Note: Method b) Measure and sum spectral maxima across the outputs of KDB 662911 is using for calculating total power density.

Chan.	Chan. Freq. (MHz)	PSD (dBm/MHz)		Total PSD (dBm/MHz)	Directional Gain (dBi)	EIRP PSD (dBm/MHz)	EIRP PSD Limit (dBm/MHz)	Pass / Fail
		Chain 0	Chain 1					
175	5875	2.51	1.69	5.13	8.10	13.23	14.00	Pass

Note: Method a) of power density measurement of KDB 662911 is using for calculating total power density. Total power density is summing entire spectra across corresponding frequency bins on the various outputs by computer.

802.11ax (HE80)

Chan.	Chan. Freq. (MHz)	PSD (dBm/300kHz)		Total PSD (dBm/300kHz)	Total PSD (dBm/MHz)	Directional Gain (dBi)	EIRP PSD (dBm/MHz)	EIRP PSD Limit (dBm/MHz)	Pass / Fail
		Chain 0	Chain 1						
171	5855	-5.50	-5.71	-2.59	2.64	8.10	10.74	14.00	Pass

Note: Method b) Measure and sum spectral maxima across the outputs of KDB 662911 is using for calculating total power density.

802.11ax (HE160)

Chan.	Chan. Freq. (MHz)	PSD (dBm/300kHz)		Total PSD (dBm/300kHz)	Total PSD (dBm/MHz)	Directional Gain (dBi)	EIRP PSD (dBm/MHz)	EIRP PSD Limit (dBm/MHz)	Pass / Fail
		Chain 0	Chain 1						
163	5815	-9.85	-9.28	-6.55	-1.32	8.10	6.78	14.00	Pass

Note: Method b) Measure and sum spectral maxima across the outputs of KDB 662911 is using for calculating total power density.

802.11ax (RU26)

RU Configuration	Chan.	Chan. Freq. (MHz)	PSD (dBm/300kHz)		Total PSD (dBm/300kHz)	Total PSD (dBm/MHz)	Directional Gain (dBi)	EIRP PSD (dBm/MHz)	EIRP PSD Limit (dBm/MHz)	Pass / Fail
			Chain 0	Chain 1						
26/0	169	5845	-2.69	-2.19	0.58	5.81	8.10	13.91	14.00	Pass

Note: Method b) Measure and sum spectral maxima across the outputs of KDB 662911 is using for calculating total power density.

RU Configuration	Chan.	Chan. Freq. (MHz)	PSD (dBm/MHz)		Total PSD (dBm/MHz)	Directional Gain (dBi)	EIRP PSD (dBm/MHz)	EIRP PSD Limit (dBm/MHz)	Pass / Fail
			Chain 0	Chain 1					
26/4	173	5865	2.67	2.79	5.74	8.10	13.84	14.00	Pass
26/8	177	5885	2.60	2.88	5.75	8.10	13.85	14.00	Pass

Note: Method a) of power density measurement of KDB 662911 is using for calculating total power density. Total power density is summing entire spectra across corresponding frequency bins on the various outputs by computer.

802.11ax (RU52)

RU Configuration	Chan.	Chan. Freq. (MHz)	PSD (dBm/300kHz)		Total PSD (dBm/300kHz)	Total PSD (dBm/MHz)	Directional Gain (dBi)	EIRP PSD (dBm/MHz)	EIRP PSD Limit (dBm/MHz)	Pass / Fail
			Chain 0	Chain 1						
52/37	169	5845	-2.49	-2.47	0.53	5.76	8.10	13.86	14.00	Pass

Note: Method b) Measure and sum spectral maxima across the outputs of KDB 662911 is using for calculating total power density.

RU Configuration	Chan.	Chan. Freq. (MHz)	PSD (dBm/MHz)		Total PSD (dBm/MHz)	Directional Gain (dBi)	EIRP PSD (dBm/MHz)	EIRP PSD Limit (dBm/MHz)	Pass / Fail
			Chain 0	Chain 1					
52/38	173	5865	1.39	3.70	5.71	8.10	13.81	14.00	Pass
52/40	177	5885	2.05	3.58	5.89	8.10	13.99	14.00	Pass

Note: Method a) of power density measurement of KDB 662911 is using for calculating total power density. Total power density is summing entire spectra across corresponding frequency bins on the various outputs by computer.

802.11ax (RU106)

RU Configuration	Chan.	Chan. Freq. (MHz)	PSD (dBm/300kHz)		Total PSD (dBm/300kHz)	Total PSD (dBm/MHz)	Directional Gain (dBi)	EIRP PSD (dBm/MHz)	EIRP PSD Limit (dBm/MHz)	Pass / Fail
			Chain 0	Chain 1						
106/53	169	5845	-2.70	-2.50	0.41	5.64	8.10	13.74	14.00	Pass

Note: Method b) Measure and sum spectral maxima across the outputs of KDB 662911 is using for calculating total power density.

RU Configuration	Chan.	Chan. Freq. (MHz)	PSD (dBm/MHz)		Total PSD (dBm/MHz)	Directional Gain (dBi)	EIRP PSD (dBm/MHz)	EIRP PSD Limit (dBm/MHz)	Pass / Fail
			Chain 0	Chain 1					
106/53	173	5865	3.03	2.48	5.77	8.10	13.87	14.00	Pass
106/54	177	5885	3.09	2.34	5.74	8.10	13.84	14.00	Pass

Note: Method a) of power density measurement of KDB 662911 is using for calculating total power density. Total power density is summing entire spectra across corresponding frequency bins on the various outputs by computer.

802.11ax (RU242)

RU Configuration	Chan.	Chan. Freq. (MHz)	PSD (dBm/300kHz)		Total PSD (dBm/300kHz)	Total PSD (dBm/MHz)	Directional Gain (dBi)	EIRP PSD (dBm/MHz)	EIRP PSD Limit (dBm/MHz)	Pass / Fail
			Chain 0	Chain 1						
242/61	169	5845	-2.30	-2.45	0.64	5.87	8.10	13.97	14.00	Pass

Note: Method b) Measure and sum spectral maxima across the outputs of KDB 662911 is using for calculating total power density.

RU Configuration	Chan.	Chan. Freq. (MHz)	PSD (dBm/MHz)		Total PSD (dBm/MHz)	Directional Gain (dBi)	EIRP PSD (dBm/MHz)	EIRP PSD Limit (dBm/MHz)	Pass / Fail
			Chain 0	Chain 1					
242/61	173	5865	2.79	1.93	5.39	8.10	13.49	14.00	Pass
242/61	177	5885	2.94	1.69	5.37	8.10	13.47	14.00	Pass

Note: Method a) of power density measurement of KDB 662911 is using for calculating total power density. Total power density is summing entire spectra across corresponding frequency bins on the various outputs by computer.

802.11ax (RU484)

RU Configuration	Chan.	Chan. Freq. (MHz)	PSD (dBm/300kHz)		Total PSD (dBm/300kHz)	Total PSD (dBm/MHz)	Directional Gain (dBi)	EIRP PSD (dBm/MHz)	EIRP PSD Limit (dBm/MHz)	Pass / Fail
			Chain 0	Chain 1						
484/65	167	5835	-4.87	-5.01	-1.93	3.30	8.10	11.40	14.00	Pass

Note: Method b) Measure and sum spectral maxima across the outputs of KDB 662911 is using for calculating total power density.

RU Configuration	Chan.	Chan. Freq. (MHz)	PSD (dBm/MHz)		Total PSD (dBm/MHz)	Directional Gain (dBi)	EIRP PSD (dBm/MHz)	EIRP PSD Limit (dBm/MHz)	Pass / Fail
			Chain 0	Chain 1					
484/65	175	5875	0.11	-0.94	2.63	8.10	10.73	14.00	Pass

Note: Method a) of power density measurement of KDB 662911 is using for calculating total power density. Total power density is summing entire spectra across corresponding frequency bins on the various outputs by computer.

802.11ax (RU996)

RU Configuration	Chan.	Chan. Freq. (MHz)	PSD (dBm/300kHz)		Total PSD (dBm/300kHz)	Total PSD (dBm/MHz)	Directional Gain (dBi)	EIRP PSD (dBm/MHz)	EIRP PSD Limit (dBm/MHz)	Pass / Fail
			Chain 0	Chain 1						
996/67	171	5855	-8.02	-8.22	-5.11	0.12	8.10	8.22	14.00	Pass

Note: Method b) Measure and sum spectral maxima across the outputs of KDB 662911 is using for calculating total power density.

802.11ax (RU1992)

RU Configuration	Chan.	Chan. Freq. (MHz)	PSD (dBm/300kHz)		Total PSD (dBm/300kHz)	Total PSD (dBm/MHz)	Directional Gain (dBi)	EIRP PSD (dBm/MHz)	EIRP PSD Limit (dBm/MHz)	Pass / Fail
			Chain 0	Chain 1						
1992/68	163	5815	-13.64	-13.80	-10.71	-5.48	8.10	2.62	14.00	Pass

Note: Method b) Measure and sum spectral maxima across the outputs of KDB 662911 is using for calculating total power density.

Spectrum Plot of Worst Value

802.11a_Chain 0 / CH177

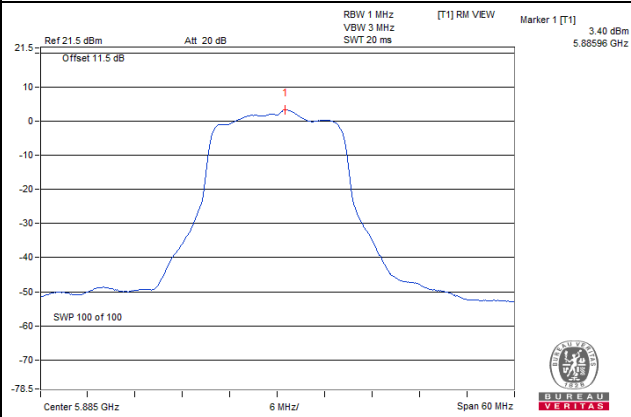

802.11ax (HE20)_Chain 0 / CH173

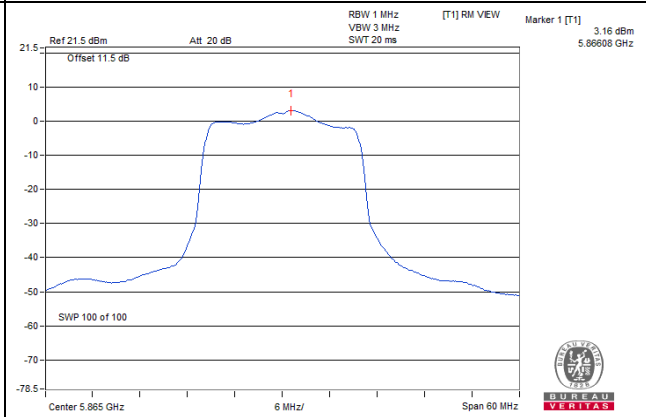

802.11ax (HE40)_Chain 0 / CH175

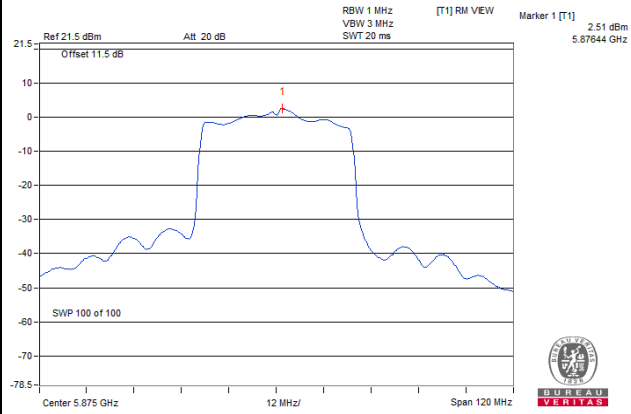

802.11ax (HE80)_Chain 0 / CH171

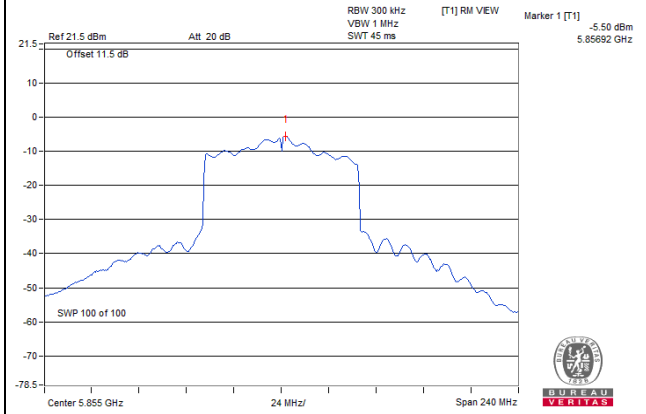

802.11ax (HE160)_Chain 1 / CH163

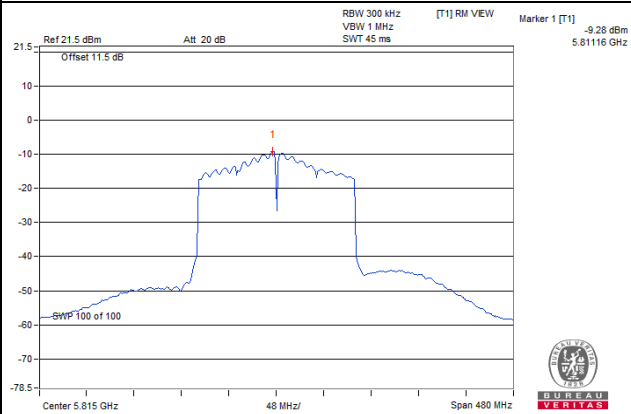

Spectrum Plot of Worst Value

802.11ax (RU26)_Chain 1 / CH177

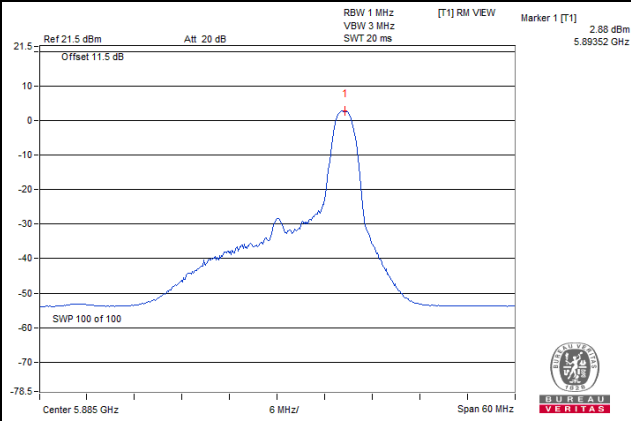

802.11ax (RU52)_Chain 1 / CH173

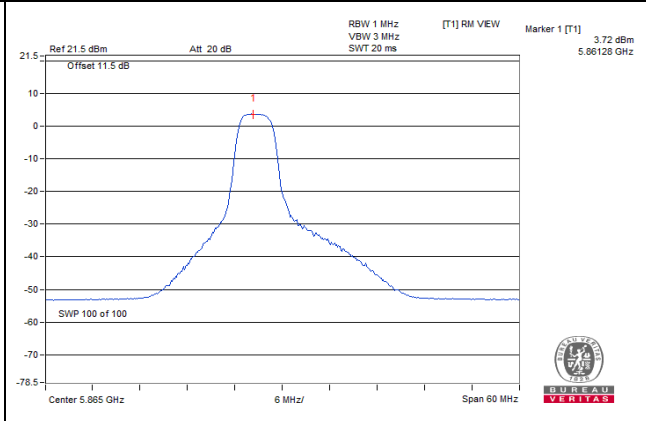

802.11ax (RU106)_Chain 0 / CH177

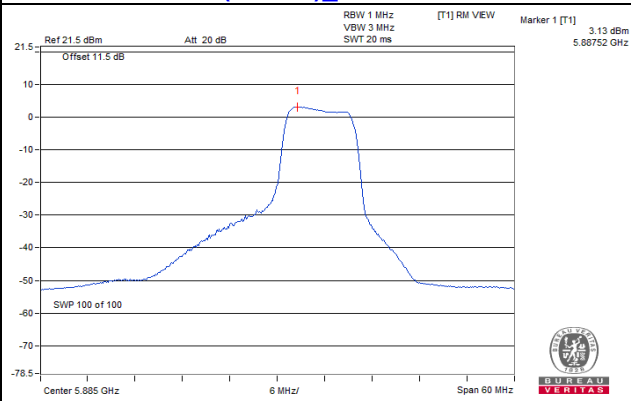

802.11ax (RU242)_Chain 0 / CH177

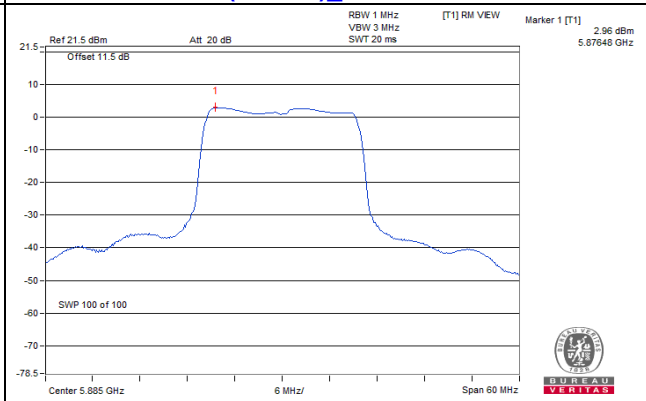

802.11ax (RU484)_Chain 0 / CH175

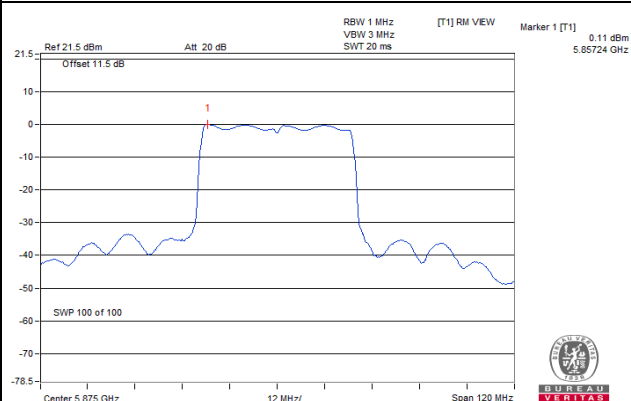

802.11ax (RU996)_Chain 0 / CH171

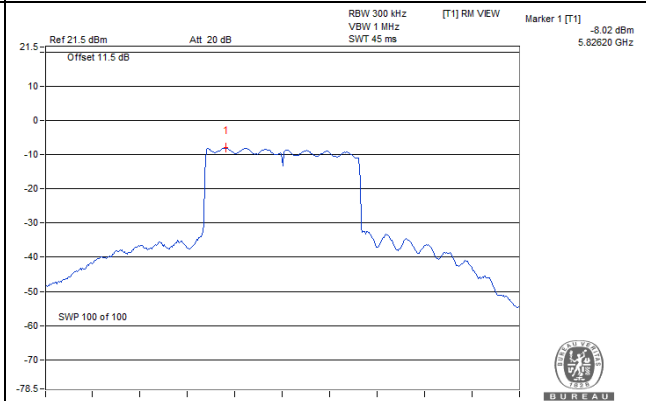

802.11ax (RU1992)_Chain 0 / CH163

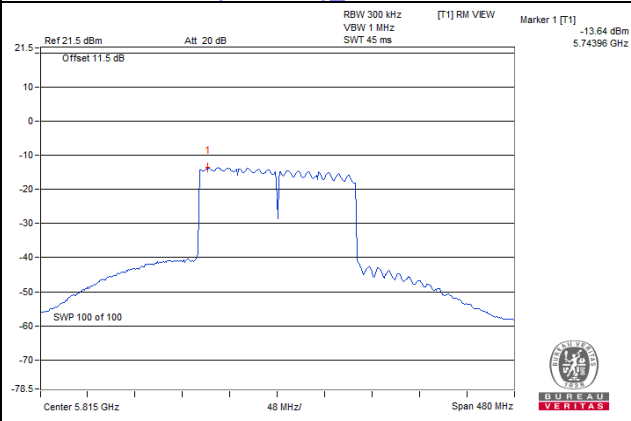

4.6 Frequency Stability Measurement

4.6.1 Limits of Frequency Stability Measurement

The frequency of the carrier signal shall be maintained within band of operation

4.6.2 Test Setup

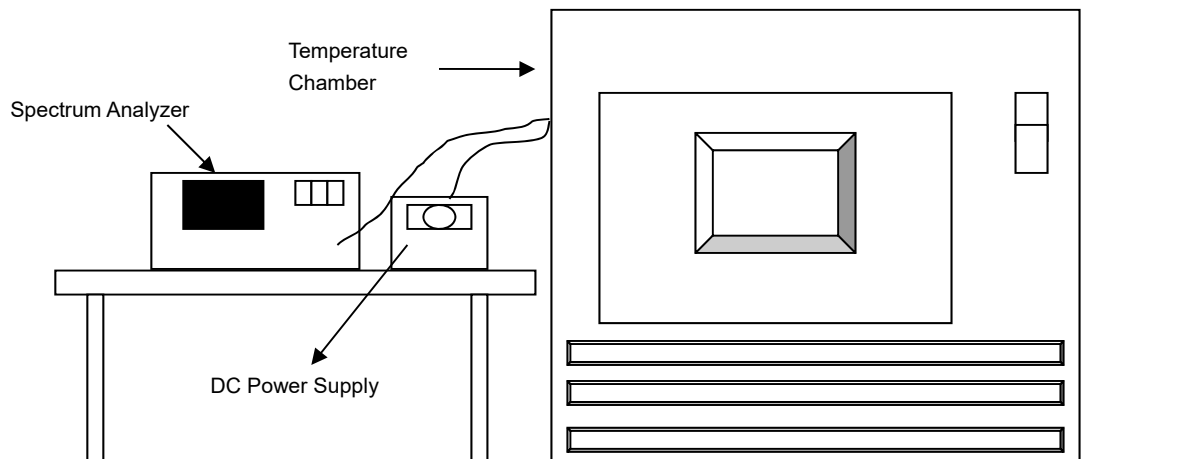

4.6.3 Test Instruments

Refer to section 4.1.2 to get information of above instrument.

4.6.4 Test Procedure

- The EUT was placed inside the environmental test chamber and powered by nominal DC voltage.
- Turn the EUT on and couple its output to a spectrum analyzer.
- Turn the EUT off and set the chamber to the highest temperature specified.
- Allow sufficient time (approximately 30 min) for the temperature of the chamber to stabilize, turn the EUT on and measure the operating frequency after 2, 5, and 10 Minutes.
- Repeat step (d) with the temperature chamber set to the next desired temperature until measurements down to the lowest specified temperature have been completed.
- The test chamber was allowed to stabilize at +20 degree C for a minimum of 30 Minutes. The supply voltage was then adjusted on the EUT from 85% to 115% and the frequency record.

4.6.5 EUT Operating Condition

Set the EUT transmit at un-modulation mode to test frequency stability.

4.6.6 Test Results

Frequency Stability Versus Temp.									
Operating Frequency: 5885MHz									
TEMP. (°C)	Power Supply (Vdc)	0 Minute		2 Minutes		5 Minutes		10 Minutes	
		Measured Frequency (MHz)	Pass/Fail	Measured Frequency (MHz)	Pass/Fail	Measured Frequency (MHz)	Pass/Fail	Measured Frequency (MHz)	Pass/Fail
70	3.3	5885.0095	Pass	5885.0079	Pass	5885.0114	Pass	5885.0086	Pass
60	3.3	5885.015	Pass	5885.0125	Pass	5885.0111	Pass	5885.0123	Pass
50	3.3	5885.0076	Pass	5885.0051	Pass	5885.0049	Pass	5885.0058	Pass
40	3.3	5884.9815	Pass	5884.9815	Pass	5884.9824	Pass	5884.9799	Pass
30	3.3	5884.9842	Pass	5884.9832	Pass	5884.9822	Pass	5884.9833	Pass
20	3.3	5884.9709	Pass	5884.973	Pass	5884.9718	Pass	5884.9713	Pass
10	3.3	5884.9755	Pass	5884.9802	Pass	5884.9788	Pass	5884.9759	Pass
0	3.3	5885.0157	Pass	5885.0152	Pass	5885.0156	Pass	5885.0144	Pass
-10	3.3	5885.0175	Pass	5885.0179	Pass	5885.0184	Pass	5885.0215	Pass

Frequency Stability Versus Voltage									
Operating Frequency: 5885MHz									
TEMP. (°C)	Power Supply (Vdc)	0 Minute		2 Minutes		5 Minutes		10 Minutes	
		Measured Frequency (MHz)	Pass/Fail	Measured Frequency (MHz)	Pass/Fail	Measured Frequency (MHz)	Pass/Fail	Measured Frequency (MHz)	Pass/Fail
20	3.795	5884.9718	Pass	5884.9726	Pass	5884.9718	Pass	5884.9712	Pass
	3.3	5884.9709	Pass	5884.973	Pass	5884.9718	Pass	5884.9713	Pass
	2.805	5884.9721	Pass	5884.972	Pass	5884.9716	Pass	5884.9717	Pass

4.7 Operational Restrictions for U-NII 4 Devices

4.7.1 Limits of Operational Restrictions for U-NII 4 Devices

(1) *Indoor Access Point.*

An access point that operates in the 5.850-5.895 GHz, is supplied power from a wired connection, has an integrated antenna, is not battery powered, and does not have a weatherized enclosure. Indoor access point devices must bear the following statement in a conspicuous location on the device and in the user's manual: FCC regulations restrict operation of this device to indoor use only.

(2) *Subordinate Device.*

A subordinate device that operates in the 5.850-5.895 GHz band under the control of an Indoor Access Point, is supplied power from a wired connection, has an integrated antenna, is not battery powered, does not have a weatherized enclosure, and does not have a direct connection to the internet. Subordinate devices must not be used to connect devices between separate buildings or structures. Subordinate devices must be authorized under certification procedures in part 2 of this chapter. Modules may not be certified as subordinate devices.

(3) *Client Device.*

A client device whose transmissions are generally under the control of an access point and is not capable of initiating a network

4.7.2 Test Setup

N/A

4.7.3 Test Instruments

N/A

4.7.4 Test Procedure

N/A.

4.7.5 Test Results

Device is a client device, all restrictions are meet the §15.403 requirements. Please refer to the Attestation letter exhibit supplied within this application.

5 Pictures of Test Arrangements

Please refer to the attached file (Test Setup Photo).

6 Appendix A – Radiated Emission Measurement

6.1.1 Limits of Radiated Emission and Bandedge Measurement

Radiated emissions which fall in the restricted bands must comply with the radiated emission limits specified as below table.

Frequencies (MHz)	Field Strength (microvolts/meter)	Measurement Distance (meters)
0.009 ~ 0.490	2400/F(kHz)	300
0.490 ~ 1.705	24000/F(kHz)	30
1.705 ~ 30.0	30	30
30 ~ 88	100	3
88 ~ 216	150	3
216 ~ 960	200	3
Above 960	500	3

NOTE:

1. The lower limit shall apply at the transition frequencies.
2. Emission level (dBuV/m) = 20 log Emission level (uV/m).
3. For frequencies above 1000MHz, the field strength limits are based on average detector, however, the peak field strength of any emission shall not exceed the maximum permitted average limits, specified above by more than 20dB under any condition of modulation.

Limits of unwanted emission out of the restricted bands

- (i) For an indoor access point or subordinate device, all emissions at or above 5.895 GHz shall not exceed an e.i.r.p. of 15 dBm/MHz and shall decrease linearly to an e.i.r.p. of -7 dBm/MHz at or above 5.925 GHz.
- (ii) For a client device, all emissions at or above 5.895 GHz shall not exceed an e.i.r.p. of -5 dBm/MHz and shall decrease linearly to an e.i.r.p. of -27 dBm/MHz at or above 5.925 GHz.
- (iii) For a client device or indoor access point or subordinate device, all emissions below 5.725 GHz shall not exceed an e.i.r.p. of -27 dBm/MHz at 5.65 GHz increasing linearly to 10 dBm/MHz at 5.7 GHz, and from 5.7 GHz increasing linearly to a level of 15.6 dBm/MHz at 5.72 GHz, and from 5.72 GHz increasing linearly to a level of 27 dBm/MHz at 5.725 GHz.

Note:

The following formula is used to convert the equipment isotropic radiated power (eirp) to field strength:

$$E = \frac{1000000\sqrt{30P}}{3} \mu\text{V/m, where } P \text{ is the eirp (Watts).}$$

6.1.2 Test Instruments

Description & Manufacturer	Model No.	Serial No.	Calibrated Date	Calibrated Until
Test Receiver Agilent	N9038A	MY51210202	Dec. 1, 2020	Nov. 30, 2021
Software	ADT_Radiated_V8.7.08	NA	NA	NA
Boresight Antenna Tower & Turn Table Max-Full	MF-7802BS	MF780208530	NA	NA
Horn Antenna SCHWARZBECK	BBHA 9120D	9120D-783	Nov. 22, 2020	Nov. 21, 2021
Pre_Amplifier EMCI	EMC 12630 SE	980638	Apr. 7, 2021	Apr. 6, 2022
RF Cable-Frequency Range : 1-26.5GHz EMCI	EMC104-SM-SM-1200	160922	Dec. 25, 2020	Dec. 24, 2021
RF Coaxial Cable EMCI	EMC104-SM-SM-2000	180502	Apr. 26, 2021	Apr. 25, 2022
RF Coaxial Cable EMCI	EMC104-SM-SM-6000	180418	Apr. 26, 2021	Apr. 25, 2022
Pre_Amplifier EMCI	EMC184045SE	980387	Jan. 11, 2021	Jan. 10, 2022
Horn Antenna Schwarzbeck	BBHA 9170	BBHA9170519	Nov. 22, 2020	Nov. 21, 2021
RF Cable-Frequency range: 1-40GHz EMCI	EMC102-KM-KM-1200	160924	Jan. 11, 2021	Jan. 10, 2022
RF cable (40GHz) EMCI	EMC-KM-KM-4000	200214	Mar. 10, 2021	Mar. 9, 2022

Note:

1. The calibration interval of the above test instruments is 12 months and the calibrations are traceable to NML/ROC and NIST/USA.
2. The test was performed in 966 Chamber No. 4.
3. Tested Date: Sep. 22 to 27, 2021

6.1.3 Test Procedure

- a. The EUT was placed on the top of a rotating table 1.5 meters above the ground at 3 meter chamber room for test. The table was rotated 360 degrees to determine the position of the highest radiation.
- b. The EUT was set 3 meters away from the interference-receiving antenna, which was mounted on the top of a variable-height antenna tower.
- c. The height of antenna is varied from one meter to four meters above the ground to determine the maximum value of the field strength. Both horizontal and vertical polarizations of the antenna are set to make the measurement.
- d. For each suspected emission, the EUT was arranged to its worst case and then the antenna was tuned to heights from 1 meter to 4 meters and the rotatable table was turned from 0 degrees to 360 degrees to find the maximum reading.
- e. The test-receiver system was set to peak and average detects function and specified bandwidth with maximum hold mode when the test frequency is above 1 GHz. If the peak reading value also meets average limit, measurement with the average detector is unnecessary.

Note:

1. The resolution bandwidth of test receiver/spectrum analyzer is 1 MHz and the video bandwidth is 3 MHz for Peak detection (PK) at frequency above 1GHz.
2. The resolution bandwidth of test receiver/spectrum analyzer is 1MHz and the video bandwidth is $\geq 1/T$ (Duty cycle $< 98\%$) or 10Hz (Duty cycle $\geq 98\%$) for Average detection (AV) at frequency above 1GHz.
3. All modes of operation were investigated and the worst-case emissions are reported.

6.1.4 Test Setup

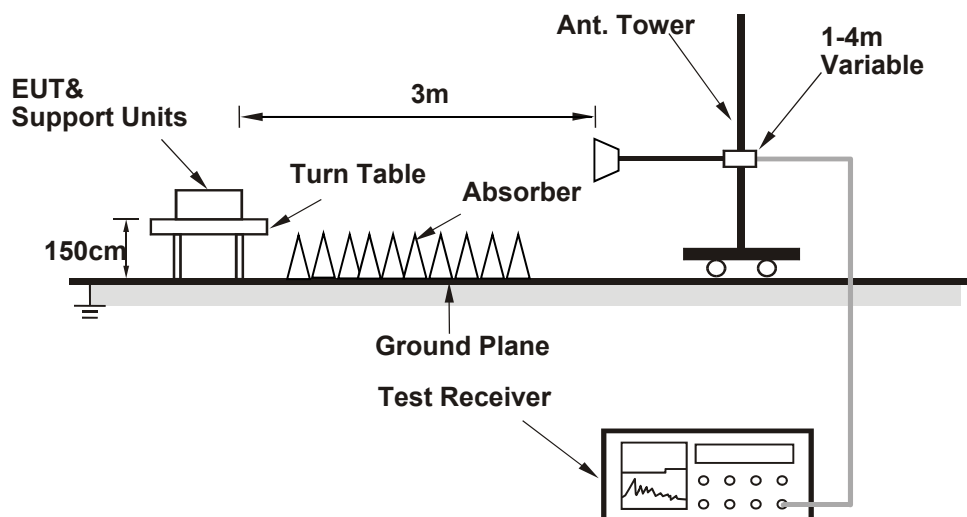

For the actual test configuration, please refer to the attached file (Test Setup Photo).

6.1.5 EUT Operating Condition

Same as 4.1.5.

6.1.6 Test Results

Radiated test with Antenna Set 2 (Model: 260-25083)

The EUT's antenna had been pre-tested on the positioned of each 3 axis. The worst case was found when positioned on **X-plane**.

RF Mode	TX 802.11ax (HE20)	Channel	CH 177 : 5885 MHz
Frequency Range	5550MHz ~ 6025MHz	Detector Function	Peak (PK) Average (AV)

Antenna Polarity & Test Distance : Horizontal at 3 m								
No	Frequency (MHz)	Emission Level (dBuV/m)	Limit (dBuV/m)	Margin (dB)	Antenna Height (m)	Table Angle (Degree)	Raw Value (dBuV)	Correction Factor (dB/m)
PK.1	#5625.79	47.3 PK	68.2	-20.9	4.00 H	213	45.6	1.7
PK.2	#5895.00	87.4 PK	110.2	-22.8	4.00 H	213	85.2	2.2
AV.1	#5895.00	83.2 AV	90.2	-7.0	4.00 H	213	81.0	2.2

Remarks:

1. Emission Level(dBuV/m) = Raw Value(dBuV) + Correction Factor(dB/m)
2. Correction Factor(dB/m) = Antenna Factor(dB/m) + Cable Factor(dB) – Pre-Amplifier Factor(dB)
3. Margin value = Emission Level – Limit value
4. The other emission levels were very low against the limit.
5. " # ": The radiated frequency is out of the restricted band.

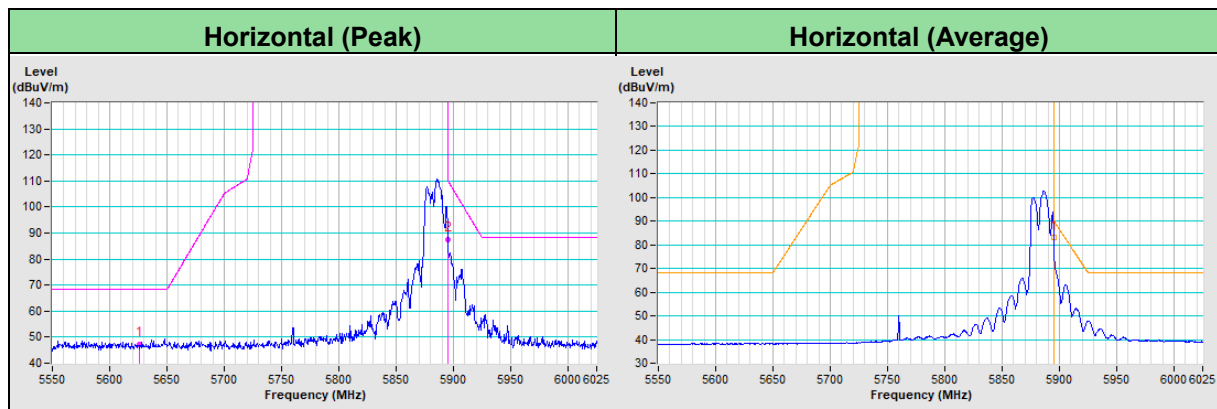

RF Mode	TX 802.11ax (HE20)	Channel	CH 177 : 5885 MHz
Frequency Range	5550MHz ~ 6025MHz	Detector Function	Peak (PK) Average (AV)

Antenna Polarity & Test Distance : Vertical at 3m								
No	Frequency (MHz)	Emission Level (dBuV/m)	Limit (dBuV/m)	Margin (dB)	Antenna Height (m)	Table Angle (Degree)	Raw Value (dBuV)	Correction Factor (dB/m)
PK.1	#5588.87	50.5 PK	68.2	-17.7	2.45 V	223	48.8	1.7
PK.2	#5895.00	91.0 PK	110.2	-19.2	2.45 V	223	88.8	2.2
AV.1	#5895.00	83.3 AV	90.2	-6.9	2.45 V	223	81.1	2.2

Remarks:

1. Emission Level(dBuV/m) = Raw Value(dBuV) + Correction Factor(dB/m)
2. Correction Factor(dB/m) = Antenna Factor(dB/m) + Cable Factor(dB) – Pre-Amplifier Factor(dB)
3. Margin value = Emission Level – Limit value
4. The other emission levels were very low against the limit.
5. "#": The radiated frequency is out of the restricted band.

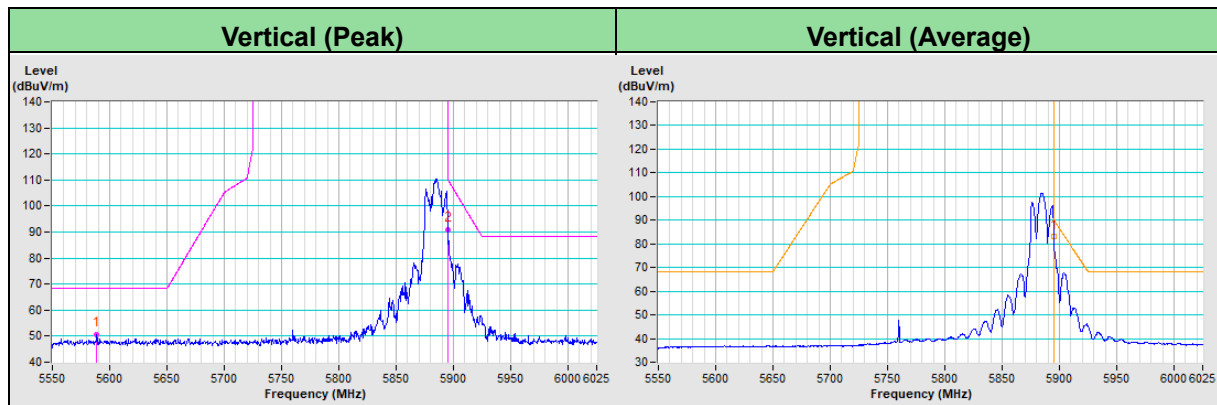

RF Mode	TX 802.11ax (HE40)	Channel	CH 175 : 5875 MHz
Frequency Range	5550MHz ~ 6025MHz	Detector Function	Peak (PK) Average (AV)

Antenna Polarity & Test Distance : Horizontal at 3 m								
No	Frequency (MHz)	Emission Level (dBuV/m)	Limit (dBuV/m)	Margin (dB)	Antenna Height (m)	Table Angle (Degree)	Raw Value (dBuV)	Correction Factor (dB/m)
PK.1	#5648.36	55.8 PK	68.2	-12.4	4.00 H	226	54.0	1.8
PK.2	#5925.00	76.0 PK	88.2	-12.2	4.00 H	226	73.8	2.2
AV.1	#5925.00	65.8 AV	68.2	-2.4	4.00 H	226	63.6	2.2

Remarks:

1. Emission Level(dBuV/m) = Raw Value(dBuV) + Correction Factor(dB/m)
2. Correction Factor(dB/m) = Antenna Factor(dB/m) + Cable Factor(dB) – Pre-Amplifier Factor(dB)
3. Margin value = Emission Level – Limit value
4. The other emission levels were very low against the limit.
5. "# #": The radiated frequency is out of the restricted band.

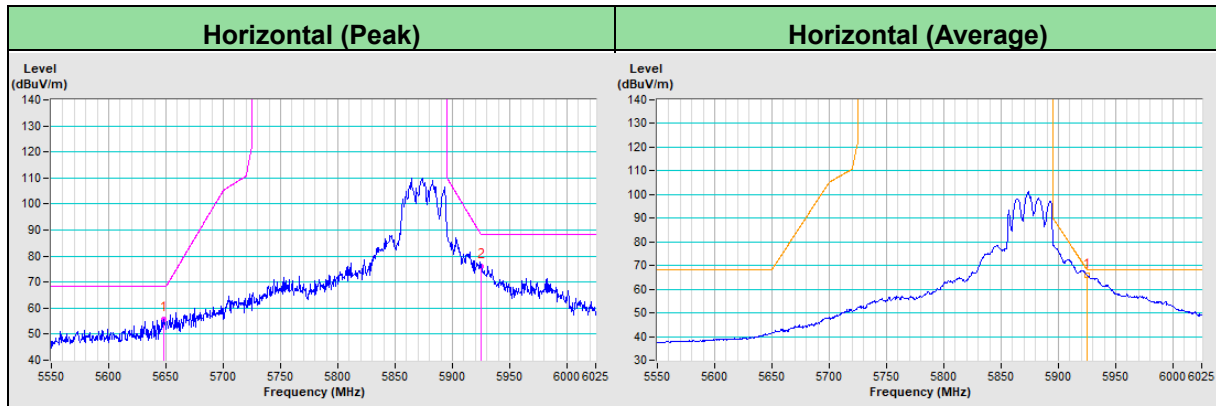

RF Mode	TX 802.11ax (HE40)	Channel	CH 175 : 5875 MHz
Frequency Range	5550MHz ~ 6025MHz	Detector Function	Peak (PK) Average (AV)

Antenna Polarity & Test Distance : Vertical at 3m								
No	Frequency (MHz)	Emission Level (dBuV/m)	Limit (dBuV/m)	Margin (dB)	Antenna Height (m)	Table Angle (Degree)	Raw Value (dBuV)	Correction Factor (dB/m)
PK.1	#5576.33	49.0 PK	68.2	-19.2	2.42 V	213	47.3	1.7
PK.2	#5925.00	65.0 PK	88.2	-23.2	2.42 V	213	62.8	2.2
AV.1	#5925.00	54.3 AV	68.2	-13.9	2.42 V	213	52.1	2.2

Remarks:

1. Emission Level(dBuV/m) = Raw Value(dBuV) + Correction Factor(dB/m)
2. Correction Factor(dB/m) = Antenna Factor(dB/m) + Cable Factor(dB) – Pre-Amplifier Factor(dB)
3. Margin value = Emission Level – Limit value
4. The other emission levels were very low against the limit.

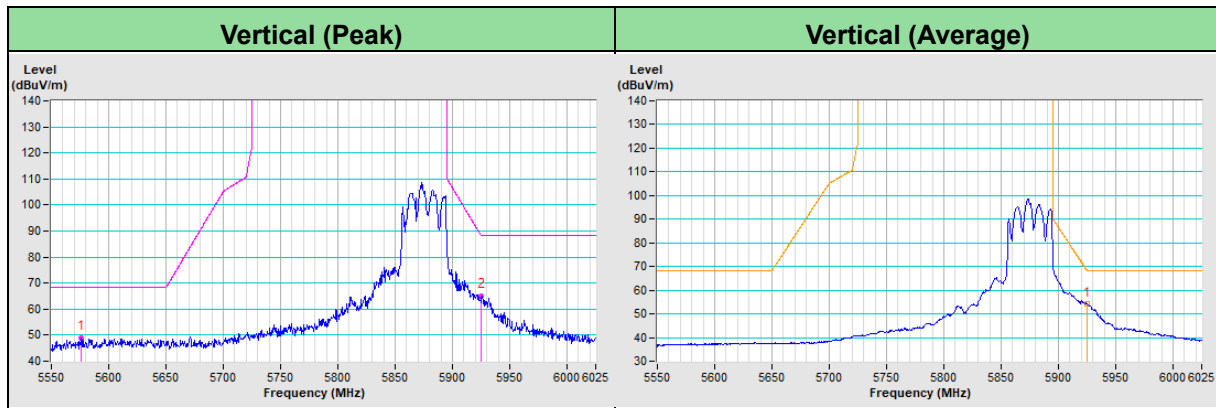

RF Mode	TX 802.11ax (HE160)	Channel	CH 163 : 5815 MHz
Frequency Range	5550MHz ~ 6025MHz	Detector Function	Peak (PK) Average (AV)

Antenna Polarity & Test Distance : Horizontal at 3 m								
No	Frequency (MHz)	Emission Level (dBuV/m)	Limit (dBuV/m)	Margin (dB)	Antenna Height (m)	Table Angle (Degree)	Raw Value (dBuV)	Correction Factor (dB/m)
PK.1	#5637.44	67.8 PK	68.2	-0.4	1.86 H	220	66.0	1.8

Remarks:

1. Emission Level(dBuV/m) = Raw Value(dBuV) + Correction Factor(dB/m)
2. Correction Factor(dB/m) = Antenna Factor(dB/m) + Cable Factor(dB) – Pre-Amplifier Factor(dB)
3. Margin value = Emission Level – Limit value
4. The other emission levels were very low against the limit.
5. " # ": The radiated frequency is out of the restricted band.

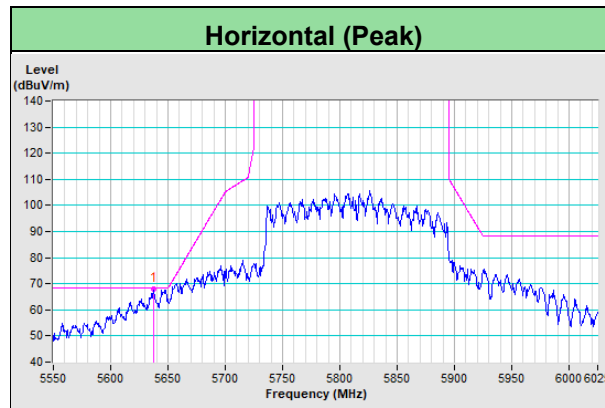

RF Mode	TX 802.11ax (HE160)	Channel	CH 163 : 5815 MHz
Frequency Range	5550MHz ~ 6025MHz	Detector Function	Peak (PK) Average (AV)

Antenna Polarity & Test Distance : Vertical at 3m								
No	Frequency (MHz)	Emission Level (dBuV/m)	Limit (dBuV/m)	Margin (dB)	Antenna Height (m)	Table Angle (Degree)	Raw Value (dBuV)	Correction Factor (dB/m)
PK.1	#5647.54	67.3 PK	68.2	-0.9	2.06 V	223	65.5	1.8

Remarks:

1. Emission Level(dBuV/m) = Raw Value(dBuV) + Correction Factor(dB/m)
2. Correction Factor(dB/m) = Antenna Factor(dB/m) + Cable Factor(dB) – Pre-Amplifier Factor(dB)
3. Margin value = Emission Level – Limit value
4. The other emission levels were very low against the limit.
5. "#": The radiated frequency is out of the restricted band.

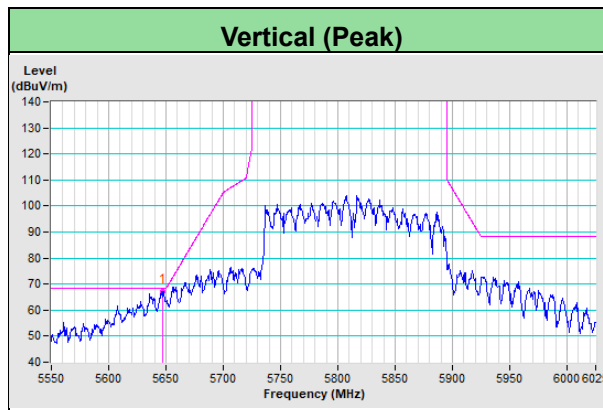

RF Mode	TX 20MHz Preamble 802.11ax (RU106)	Channel	CH 177 : 5885 MHz
Frequency Range	5550MHz ~ 6025MHz	Detector Function	Peak (PK) Average (AV)

Antenna Polarity & Test Distance : Horizontal at 3 m								
No	Frequency (MHz)	Emission Level (dBuV/m)	Limit (dBuV/m)	Margin (dB)	Antenna Height (m)	Table Angle (Degree)	Raw Value (dBuV)	Correction Factor (dB/m)
PK.1	#5604.08	48.6 PK	68.2	-19.6	3.86 H	65	46.9	1.7
PK.2	#5895.00	92.7 PK	110.2	-17.5	3.86 H	65	90.5	2.2
AV.1	#5895.00	87.4 AV	90.2	-2.8	3.86 H	65	85.2	2.2

Remarks:

1. Emission Level(dBuV/m) = Raw Value(dBuV) + Correction Factor(dB/m)
2. Correction Factor(dB/m) = Antenna Factor(dB/m) + Cable Factor(dB) – Pre-Amplifier Factor(dB)
3. Margin value = Emission Level – Limit value
4. The other emission levels were very low against the limit.
5. " # ": The radiated frequency is out of the restricted band.

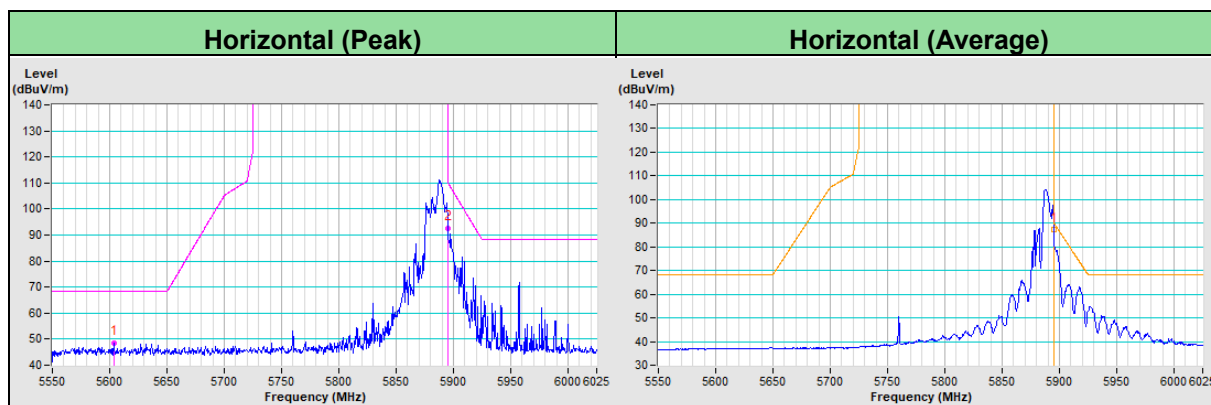

RF Mode	TX 20MHz Preamble 802.11ax (RU106)	Channel	CH 177 : 5885 MHz
Frequency Range	5550MHz ~ 6025MHz	Detector Function	Peak (PK) Average (AV)

Antenna Polarity & Test Distance : Vertical at 3m								
No	Frequency (MHz)	Emission Level (dBuV/m)	Limit (dBuV/m)	Margin (dB)	Antenna Height (m)	Table Angle (Degree)	Raw Value (dBuV)	Correction Factor (dB/m)
PK.1	#5621.15	49.0 PK	68.2	-19.2	3.18 V	184	47.2	1.8
PK.2	#5895.00	93.4 PK	110.2	-16.8	3.18 V	184	91.2	2.2
AV.1	#5895.00	84.5 AV	90.2	-5.7	3.18 V	184	82.3	2.2

Remarks:

1. Emission Level(dBuV/m) = Raw Value(dBuV) + Correction Factor(dB/m)
2. Correction Factor(dB/m) = Antenna Factor(dB/m) + Cable Factor(dB) – Pre-Amplifier Factor(dB)
3. Margin value = Emission Level – Limit value
4. The other emission levels were very low against the limit.
5. " # ": The radiated frequency is out of the restricted band.

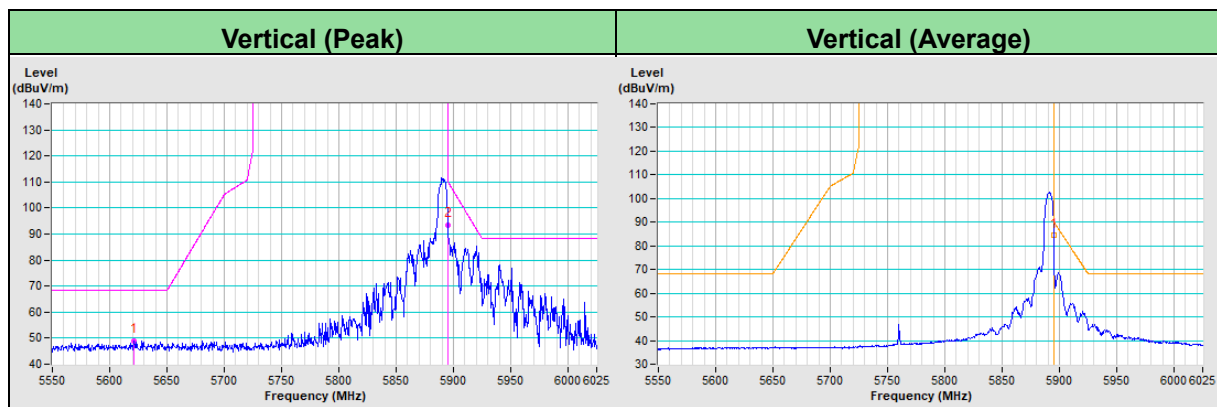

RF Mode	TX 20MHz Preamble 802.11ax (RU242)	Channel	CH 177 : 5885 MHz
Frequency Range	5550MHz ~ 6025MHz	Detector Function	Peak (PK) Average (AV)

Antenna Polarity & Test Distance : Horizontal at 3 m								
No	Frequency (MHz)	Emission Level (dBuV/m)	Limit (dBuV/m)	Margin (dB)	Antenna Height (m)	Table Angle (Degree)	Raw Value (dBuV)	Correction Factor (dB/m)
PK.1	#5588.66	49.8 PK	68.2	-18.4	3.89 H	72	48.1	1.7
PK.2	#5895.00	91.9 PK	110.2	-18.3	3.89 H	72	89.7	2.2
AV.1	#5895.00	85.2 AV	90.2	-5.0	3.89 H	72	83.0	2.2

Remarks:

1. Emission Level(dBuV/m) = Raw Value(dBuV) + Correction Factor(dB/m)
2. Correction Factor(dB/m) = Antenna Factor(dB/m) + Cable Factor(dB) – Pre-Amplifier Factor(dB)
3. Margin value = Emission Level – Limit value
4. The other emission levels were very low against the limit.
5. " # ": The radiated frequency is out of the restricted band.

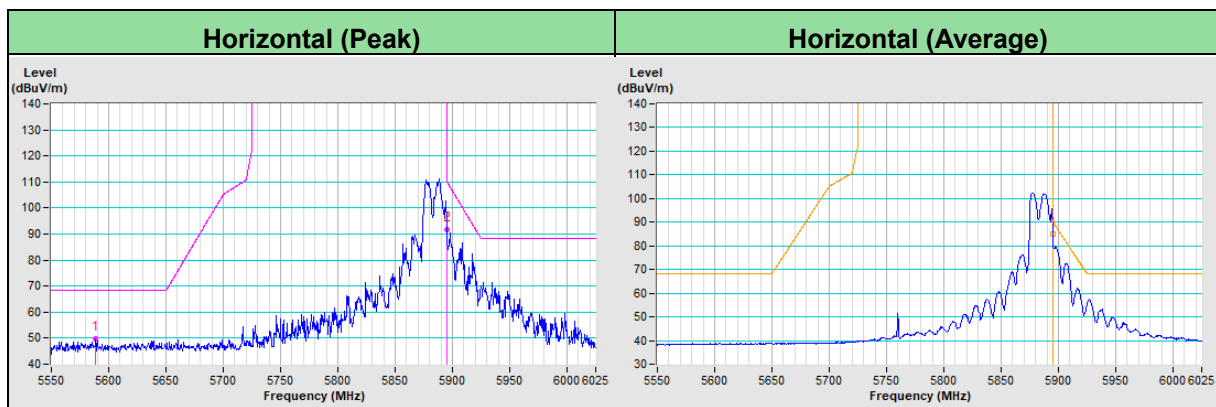

RF Mode	TX 20MHz Preamble 802.11ax (RU242)	Channel	CH 177 : 5885 MHz
Frequency Range	5550MHz ~ 6025MHz	Detector Function	Peak (PK) Average (AV)

Antenna Polarity & Test Distance : Vertical at 3m								
No	Frequency (MHz)	Emission Level (dBuV/m)	Limit (dBuV/m)	Margin (dB)	Antenna Height (m)	Table Angle (Degree)	Raw Value (dBuV)	Correction Factor (dB/m)
PK.1	#5575.73	48.8 PK	68.2	-19.4	3.14 V	197	47.1	1.7
PK.2	#5895.00	90.4 PK	110.2	-19.8	3.14 V	197	88.2	2.2
AV.1	#5895.00	80.4 AV	90.2	-9.8	3.14 V	197	78.2	2.2

Remarks:

1. Emission Level(dBuV/m) = Raw Value(dBuV) + Correction Factor(dB/m)
2. Correction Factor(dB/m) = Antenna Factor(dB/m) + Cable Factor(dB) – Pre-Amplifier Factor(dB)
3. Margin value = Emission Level – Limit value
4. The other emission levels were very low against the limit.
5. " # ": The radiated frequency is out of the restricted band.

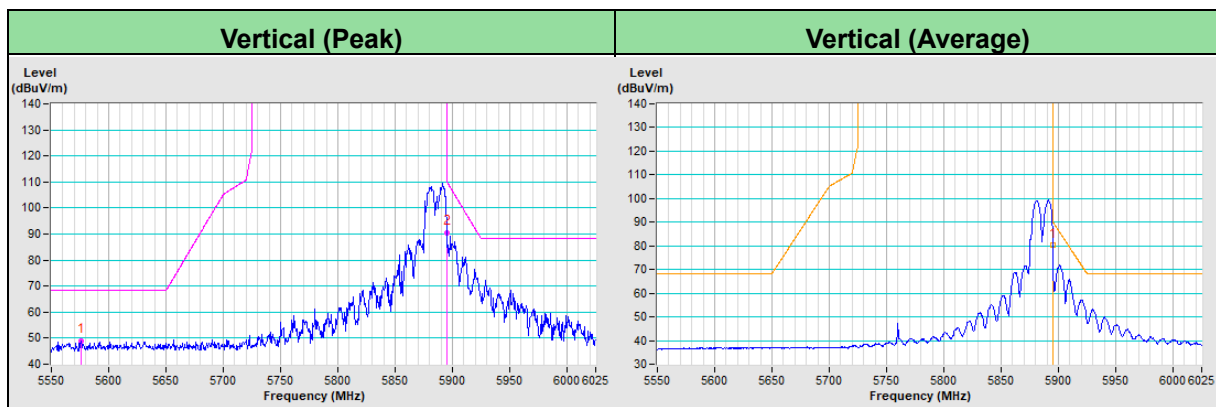

RF Mode	TX 80MHz Preamble 802.11ax (RU996)	Channel	CH 171 : 5855 MHz
Frequency Range	5550MHz ~ 6025MHz	Detector Function	Peak (PK) Average (AV)

Antenna Polarity & Test Distance : Horizontal at 3 m								
No	Frequency (MHz)	Emission Level (dBuV/m)	Limit (dBuV/m)	Margin (dB)	Antenna Height (m)	Table Angle (Degree)	Raw Value (dBuV)	Correction Factor (dB/m)
PK.1	#5643.42	61.8 PK	68.2	-6.4	3.93 H	64	60.0	1.8
PK.2	#5931.09	77.6 PK	88.2	-10.6	3.93 H	64	75.4	2.2
AV.1	#5931.09	65.8 AV	68.2	-2.4	3.93 H	64	63.6	2.2

Remarks:

1. Emission Level(dBuV/m) = Raw Value(dBuV) + Correction Factor(dB/m)
2. Correction Factor(dB/m) = Antenna Factor(dB/m) + Cable Factor(dB) – Pre-Amplifier Factor(dB)
3. Margin value = Emission Level – Limit value
4. The other emission levels were very low against the limit.
5. " # ": The radiated frequency is out of the restricted band.

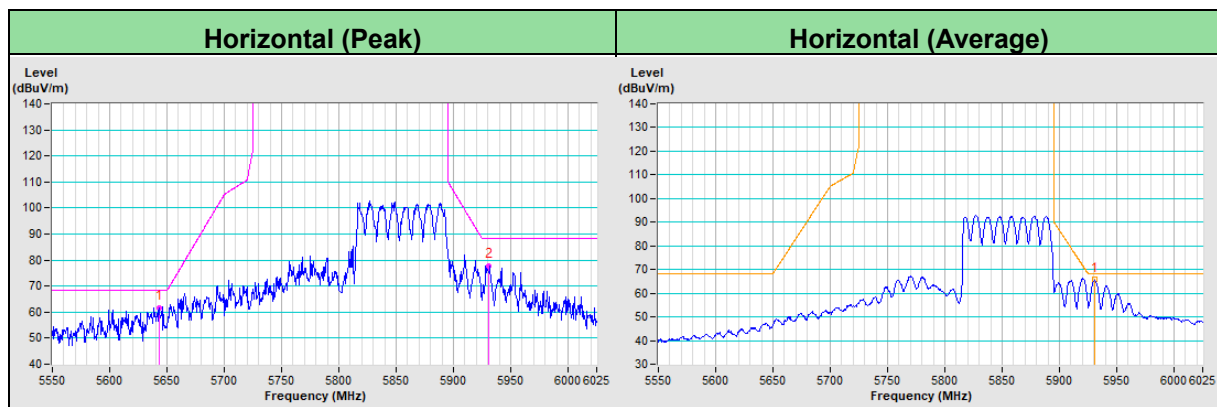

RF Mode	TX 80MHz Preamble 802.11ax (RU996)	Channel	CH 171 : 5855 MHz
Frequency Range	5550MHz ~ 6025MHz	Detector Function	Peak (PK) Average (AV)

Antenna Polarity & Test Distance : Vertical at 3m								
No	Frequency (MHz)	Emission Level (dBuV/m)	Limit (dBuV/m)	Margin (dB)	Antenna Height (m)	Table Angle (Degree)	Raw Value (dBuV)	Correction Factor (dB/m)
PK.1	#5648.23	58.8 PK	68.2	-9.4	3.18 V	194	57.0	1.8
PK.2	#5933.46	75.6 PK	88.2	-12.6	3.18 V	194	73.4	2.2
AV.1	#5933.46	63.8 AV	68.2	-4.4	3.18 V	194	61.6	2.2

Remarks:

1. Emission Level(dBuV/m) = Raw Value(dBuV) + Correction Factor(dB/m)
2. Correction Factor(dB/m) = Antenna Factor(dB/m) + Cable Factor(dB) – Pre-Amplifier Factor(dB)
3. Margin value = Emission Level – Limit value
4. The other emission levels were very low against the limit.
5. " # ": The radiated frequency is out of the restricted band.

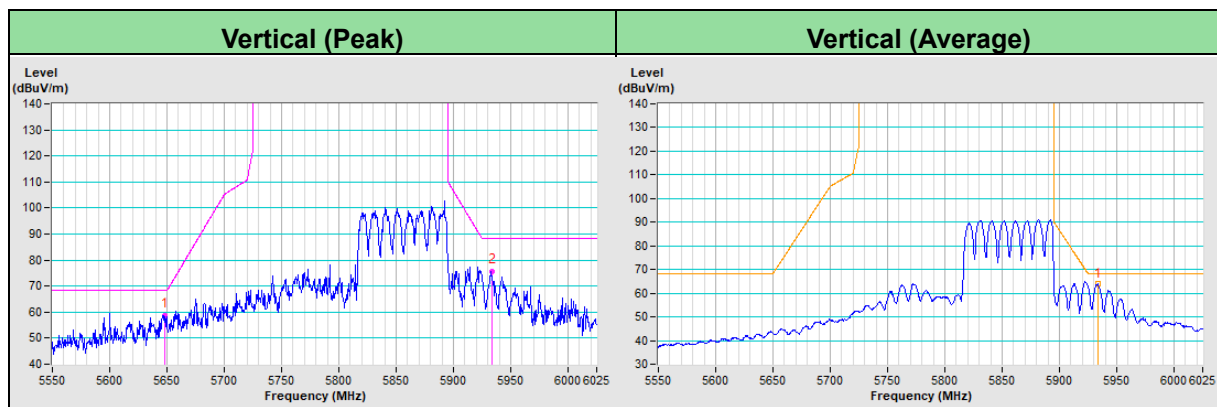

RF Mode	TX 160MHz Preamble 802.11ax (RU1992)	Channel	CH 163 : 5815 MHz
Frequency Range	5550MHz ~ 6025MHz	Detector Function	Peak (PK) Average (AV)

Antenna Polarity & Test Distance : Horizontal at 3 m								
No	Frequency (MHz)	Emission Level (dBuV/m)	Limit (dBuV/m)	Margin (dB)	Antenna Height (m)	Table Angle (Degree)	Raw Value (dBuV)	Correction Factor (dB/m)
PK.1	#5643.97	67.8 PK	68.2	-0.4	1.91 H	223	66.0	1.8
AV.1	#5928.05	68.0 AV	68.2	-0.2	3.94 H	91	65.8	2.2

Remarks:

1. Emission Level(dBuV/m) = Raw Value(dBuV) + Correction Factor(dB/m)
2. Correction Factor(dB/m) = Antenna Factor(dB/m) + Cable Factor(dB) – Pre-Amplifier Factor(dB)
3. Margin value = Emission Level – Limit value
4. The other emission levels were very low against the limit.
5. "#": The radiated frequency is out of the restricted band.

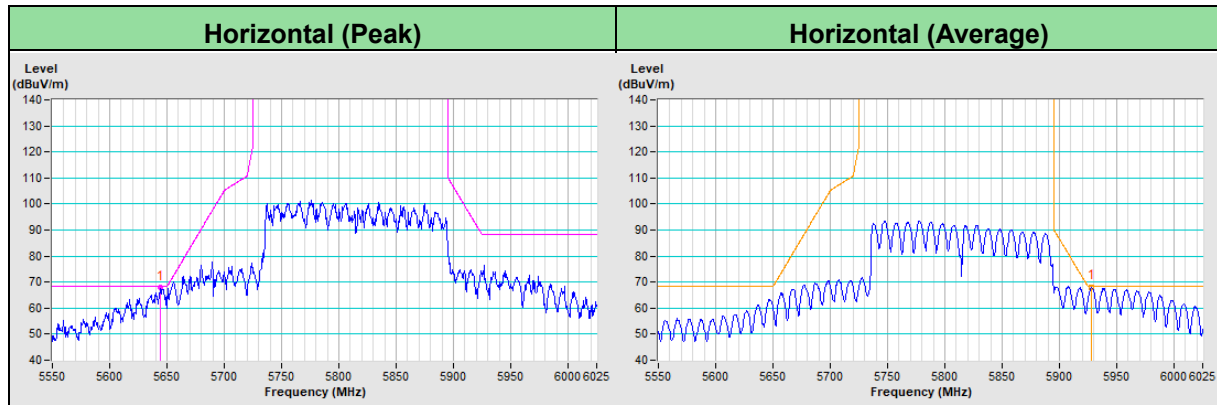

RF Mode	TX 160MHz Preamble 802.11ax (RU1992)	Channel	CH 163 : 5815 MHz
Frequency Range	5550MHz ~ 6025MHz	Detector Function	Peak (PK) Average (AV)

Antenna Polarity & Test Distance : Vertical at 3m

No	Frequency (MHz)	Emission Level (dBuV/m)	Limit (dBuV/m)	Margin (dB)	Antenna Height (m)	Table Angle (Degree)	Raw Value (dBuV)	Correction Factor (dB/m)
PK.1	#5649.26	66.9 PK	68.2	-1.3	3.19 V	199	65.1	1.8
AV.1	#5931.51	65.4 AV	68.2	-2.8	3.10 V	192	63.2	2.2

Remarks:

1. Emission Level(dBuV/m) = Raw Value(dBuV) + Correction Factor(dB/m)
2. Correction Factor(dB/m) = Antenna Factor(dB/m) + Cable Factor(dB) – Pre-Amplifier Factor(dB)
3. Margin value = Emission Level – Limit value
4. The other emission levels were very low against the limit.
5. " # ": The radiated frequency is out of the restricted band.

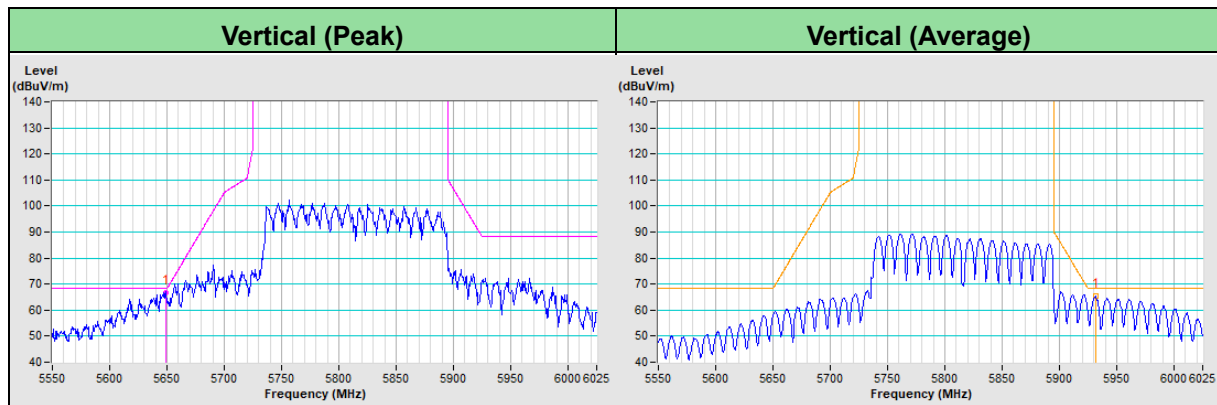

Radiated test with Antenna Set 3 (Model: 260-25084)

The EUT's antenna had been pre-tested on the positioned of each 3 axis. The worst case was found when positioned on **X-plane**.

RF Mode	TX 802.11ax (HE20)	Channel	CH 177 : 5885 MHz
Frequency Range	5550MHz ~ 6025MHz	Detector Function	Peak (PK) Average (AV)

Antenna Polarity & Test Distance : Horizontal at 3 m								
No	Frequency (MHz)	Emission Level (dBuV/m)	Limit (dBuV/m)	Margin (dB)	Antenna Height (m)	Table Angle (Degree)	Raw Value (dBuV)	Correction Factor (dB/m)
PK.1	#5590.54	48.4 PK	68.2	-19.8	1.26 H	134	46.7	1.7
PK.2	#5895.00	82.1 PK	110.2	-28.1	1.26 H	134	79.9	2.2
AV.1	#5895.00	78.4 AV	90.2	-11.8	1.26 H	134	76.2	2.2

Remarks:

1. Emission Level(dBuV/m) = Raw Value(dBuV) + Correction Factor(dB/m)
2. Correction Factor(dB/m) = Antenna Factor(dB/m) + Cable Factor(dB) – Pre-Amplifier Factor(dB)
3. Margin value = Emission Level – Limit value
4. The other emission levels were very low against the limit.
5. "#": The radiated frequency is out of the restricted band.

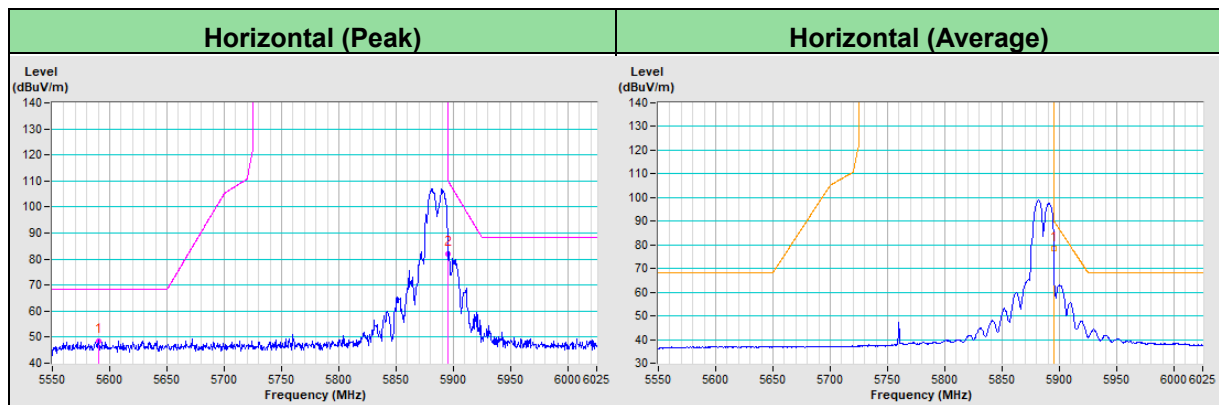

RF Mode	TX 802.11ax (HE20)	Channel	CH 177 : 5885 MHz
Frequency Range	5550MHz ~ 6025MHz	Detector Function	Peak (PK) Average (AV)

Antenna Polarity & Test Distance : Vertical at 3m								
No	Frequency (MHz)	Emission Level (dBuV/m)	Limit (dBuV/m)	Margin (dB)	Antenna Height (m)	Table Angle (Degree)	Raw Value (dBuV)	Correction Factor (dB/m)
PK.1	#5628.13	50.9 PK	68.2	-17.3	1.50 V	171	49.1	1.8
PK.2	#5895.00	88.9 PK	110.2	-21.3	1.50 V	171	86.7	2.2
AV.1	#5895.00	81.5 AV	90.2	-8.7	1.50 V	171	79.3	2.2

Remarks:

1. Emission Level(dBuV/m) = Raw Value(dBuV) + Correction Factor(dB/m)
2. Correction Factor(dB/m) = Antenna Factor(dB/m) + Cable Factor(dB) – Pre-Amplifier Factor(dB)
3. Margin value = Emission Level – Limit value
4. The other emission levels were very low against the limit.
5. "#": The radiated frequency is out of the restricted band.

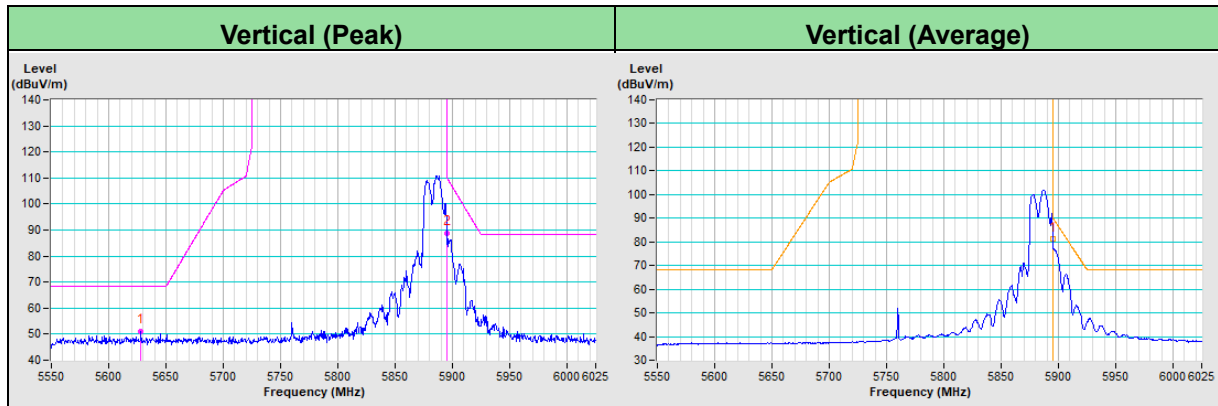

RF Mode	TX 802.11ax (HE40)	Channel	CH 175 : 5875 MHz
Frequency Range	5550MHz ~ 6025MHz	Detector Function	Peak (PK) Average (AV)

Antenna Polarity & Test Distance : Horizontal at 3 m								
No	Frequency (MHz)	Emission Level (dBuV/m)	Limit (dBuV/m)	Margin (dB)	Antenna Height (m)	Table Angle (Degree)	Raw Value (dBuV)	Correction Factor (dB/m)
PK.1	#5633.01	49.1 PK	68.2	-19.1	1.27 H	146	47.3	1.8
PK.2	#5925.00	65.4 PK	88.2	-22.8	1.27 H	146	63.2	2.2
AV.1	#5925.00	53.0 AV	68.2	-15.2	1.27 H	146	50.8	2.2

Remarks:

1. Emission Level(dBuV/m) = Raw Value(dBuV) + Correction Factor(dB/m)
2. Correction Factor(dB/m) = Antenna Factor(dB/m) + Cable Factor(dB) – Pre-Amplifier Factor(dB)
3. Margin value = Emission Level – Limit value
4. The other emission levels were very low against the limit.
5. "# #": The radiated frequency is out of the restricted band.

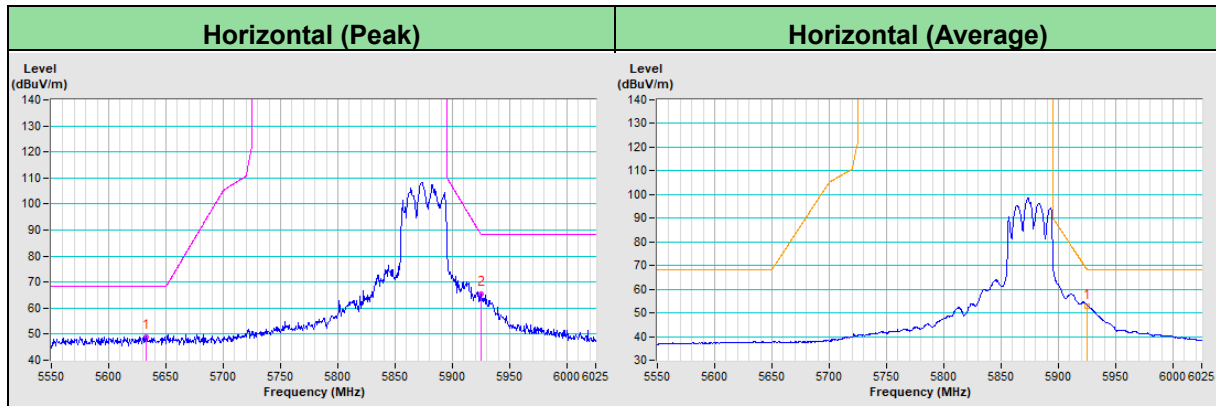

RF Mode	TX 802.11ax (HE40)	Channel	CH 175 : 5875 MHz
Frequency Range	5550MHz ~ 6025MHz	Detector Function	Peak (PK) Average (AV)

Antenna Polarity & Test Distance : Vertical at 3m								
No	Frequency (MHz)	Emission Level (dBuV/m)	Limit (dBuV/m)	Margin (dB)	Antenna Height (m)	Table Angle (Degree)	Raw Value (dBuV)	Correction Factor (dB/m)
PK.1	#5650.00	52.8 PK	68.2	-15.4	1.47 V	179	51.0	1.8
PK.2	#5925.00	71.5 PK	88.2	-16.7	1.47 V	179	69.3	2.2
AV.1	#5925.00	59.0 AV	68.2	-9.2	1.47 V	179	56.8	2.2

Remarks:

1. Emission Level(dBuV/m) = Raw Value(dBuV) + Correction Factor(dB/m)
2. Correction Factor(dB/m) = Antenna Factor(dB/m) + Cable Factor(dB) – Pre-Amplifier Factor(dB)
3. Margin value = Emission Level – Limit value
4. The other emission levels were very low against the limit.
5. "#": The radiated frequency is out of the restricted band.

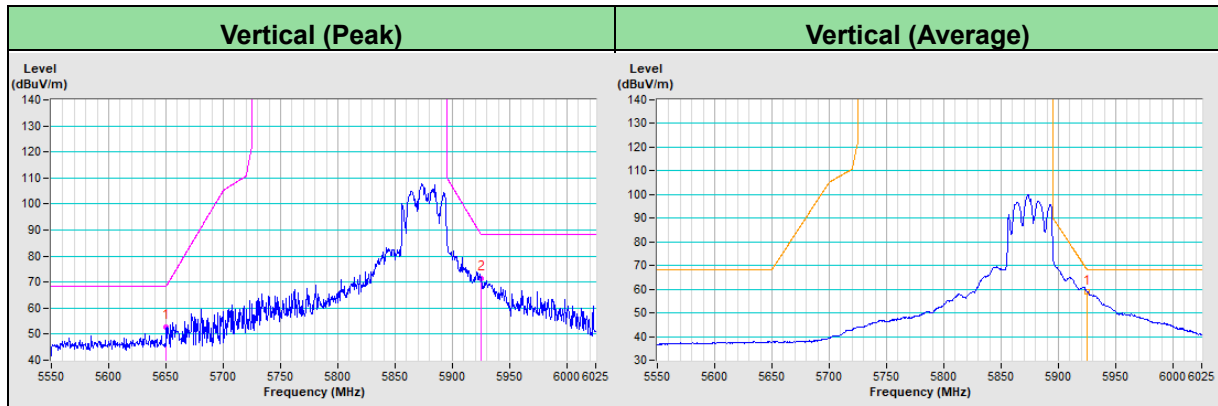

RF Mode	TX 802.11ax (HE160)	Channel	CH 163 : 5815 MHz
Frequency Range	5550MHz ~ 6025MHz	Detector Function	Peak (PK) Average (AV)

Antenna Polarity & Test Distance : Horizontal at 3 m

No	Frequency (MHz)	Emission Level (dBuV/m)	Limit (dBuV/m)	Margin (dB)	Antenna Height (m)	Table Angle (Degree)	Raw Value (dBuV)	Correction Factor (dB/m)
PK.1	#5646.70	66.4 PK	68.2	-1.8	1.31 H	140	64.6	1.8

Remarks:

1. Emission Level(dBuV/m) = Raw Value(dBuV) + Correction Factor(dB/m)
2. Correction Factor(dB/m) = Antenna Factor(dB/m) + Cable Factor(dB) – Pre-Amplifier Factor(dB)
3. Margin value = Emission Level – Limit value
4. The other emission levels were very low against the limit.
5. " # ": The radiated frequency is out of the restricted band.

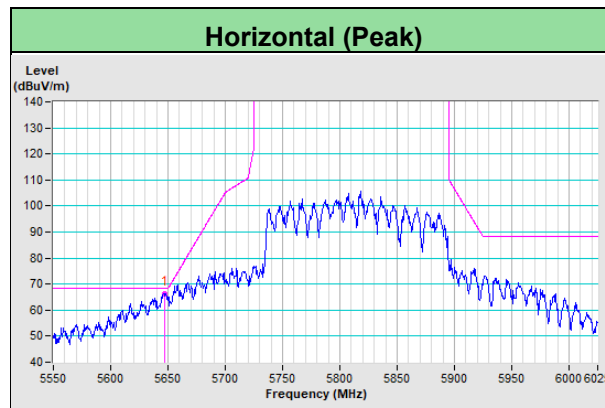

RF Mode	TX 802.11ax (HE160)	Channel	CH 163 : 5815 MHz
Frequency Range	5550MHz ~ 6025MHz	Detector Function	Peak (PK) Average (AV)

Antenna Polarity & Test Distance : Vertical at 3m								
No	Frequency (MHz)	Emission Level (dBuV/m)	Limit (dBuV/m)	Margin (dB)	Antenna Height (m)	Table Angle (Degree)	Raw Value (dBuV)	Correction Factor (dB/m)
PK.1	#5647.47	67.3 PK	68.2	-0.9	1.48 V	177	65.5	1.8

Remarks:

1. Emission Level(dBuV/m) = Raw Value(dBuV) + Correction Factor(dB/m)
2. Correction Factor(dB/m) = Antenna Factor(dB/m) + Cable Factor(dB) – Pre-Amplifier Factor(dB)
3. Margin value = Emission Level – Limit value
4. The other emission levels were very low against the limit.
5. " # ": The radiated frequency is out of the restricted band.

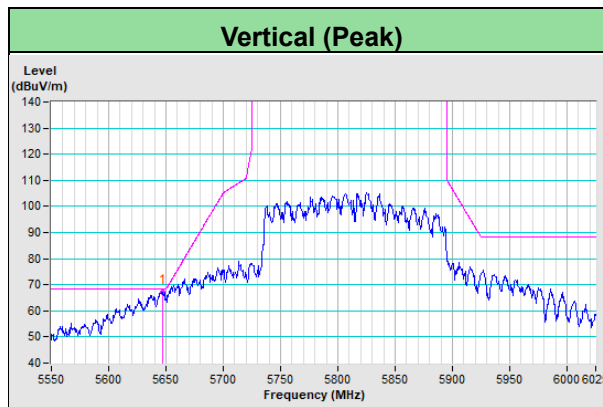

RF Mode	TX 20MHz Preamble 802.11ax (RU106)	Channel	CH 177 : 5885 MHz
Frequency Range	5550MHz ~ 6025MHz	Detector Function	Peak (PK) Average (AV)

Antenna Polarity & Test Distance : Horizontal at 3 m								
No	Frequency (MHz)	Emission Level (dBuV/m)	Limit (dBuV/m)	Margin (dB)	Antenna Height (m)	Table Angle (Degree)	Raw Value (dBuV)	Correction Factor (dB/m)
PK.1	#5601.68	48.4 PK	68.2	-19.8	1.19 H	185	46.7	1.7
PK.2	#5895.00	93.5 PK	110.2	-16.7	1.19 H	185	91.3	2.2
AV.1	#5895.00	84.6 AV	90.2	-5.6	1.19 H	185	82.4	2.2

Remarks:

1. Emission Level(dBuV/m) = Raw Value(dBuV) + Correction Factor(dB/m)
2. Correction Factor(dB/m) = Antenna Factor(dB/m) + Cable Factor(dB) – Pre-Amplifier Factor(dB)
3. Margin value = Emission Level – Limit value
4. The other emission levels were very low against the limit.
5. " # ": The radiated frequency is out of the restricted band.

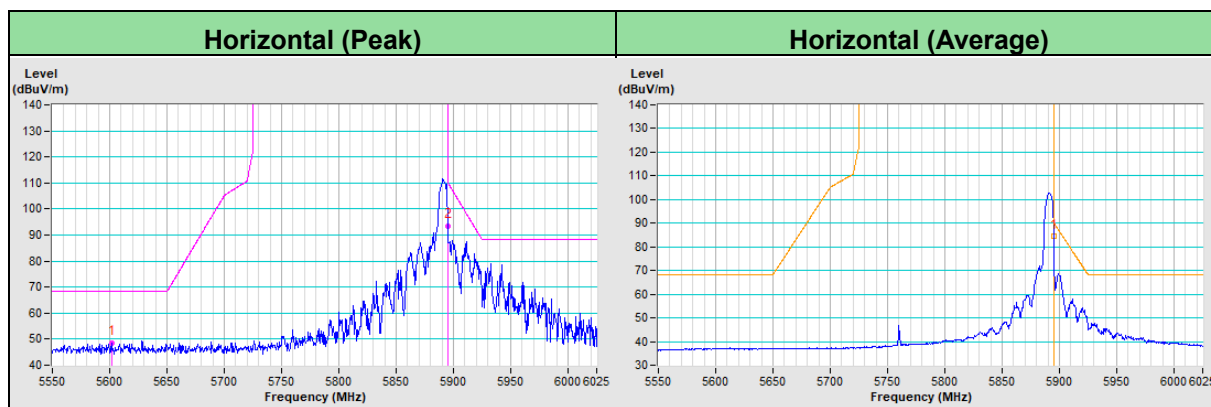

RF Mode	TX 20MHz Preamble 802.11ax (RU106)	Channel	CH 177 : 5885 MHz
Frequency Range	5550MHz ~ 6025MHz	Detector Function	Peak (PK) Average (AV)

Antenna Polarity & Test Distance : Vertical at 3m								
No	Frequency (MHz)	Emission Level (dBuV/m)	Limit (dBuV/m)	Margin (dB)	Antenna Height (m)	Table Angle (Degree)	Raw Value (dBuV)	Correction Factor (dB/m)
PK.1	#5582.28	49.3 PK	68.2	-18.9	2.25 V	240	47.6	1.7
PK.2	#5895.00	92.3 PK	110.2	-17.9	2.25 V	240	90.1	2.2
AV.1	#5895.00	86.1 AV	90.2	-4.1	2.25 V	240	83.9	2.2

Remarks:

1. Emission Level(dBuV/m) = Raw Value(dBuV) + Correction Factor(dB/m)
2. Correction Factor(dB/m) = Antenna Factor(dB/m) + Cable Factor(dB) – Pre-Amplifier Factor(dB)
3. Margin value = Emission Level – Limit value
4. The other emission levels were very low against the limit.
5. " # ": The radiated frequency is out of the restricted band.

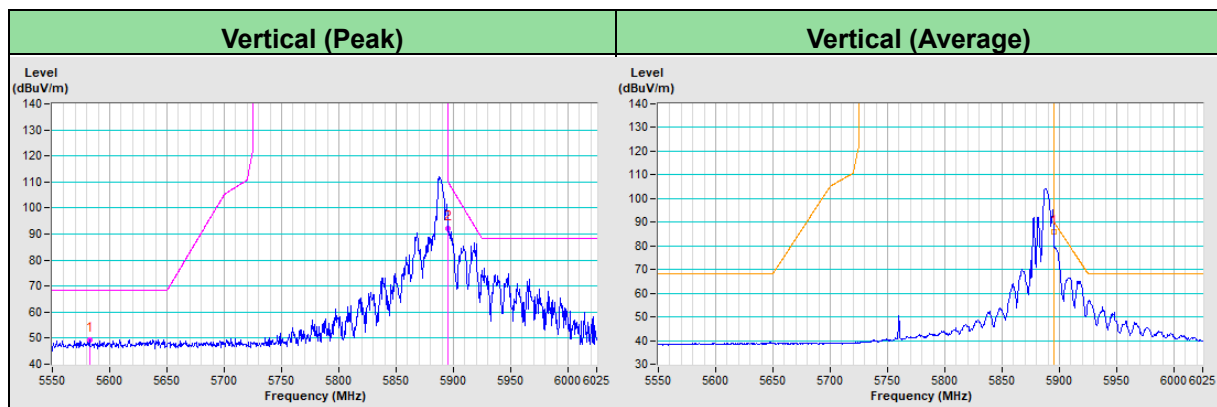

RF Mode	TX 20MHz Preamble 802.11ax (RU242)	Channel	CH 177 : 5885 MHz
Frequency Range	5550MHz ~ 6025MHz	Detector Function	Peak (PK) Average (AV)

Antenna Polarity & Test Distance : Horizontal at 3 m								
No	Frequency (MHz)	Emission Level (dBuV/m)	Limit (dBuV/m)	Margin (dB)	Antenna Height (m)	Table Angle (Degree)	Raw Value (dBuV)	Correction Factor (dB/m)
PK.1	#5625.93	49.3 PK	68.2	-18.9	1.20 H	189	47.6	1.7
PK.2	#5895.00	94.2 PK	110.2	-16.0	1.20 H	189	92.0	2.2
AV.1	#5895.00	80.5 AV	90.2	-9.7	1.20 H	189	78.3	2.2

Remarks:

1. Emission Level(dBuV/m) = Raw Value(dBuV) + Correction Factor(dB/m)
2. Correction Factor(dB/m) = Antenna Factor(dB/m) + Cable Factor(dB) – Pre-Amplifier Factor(dB)
3. Margin value = Emission Level – Limit value
4. The other emission levels were very low against the limit.
5. " # ": The radiated frequency is out of the restricted band.

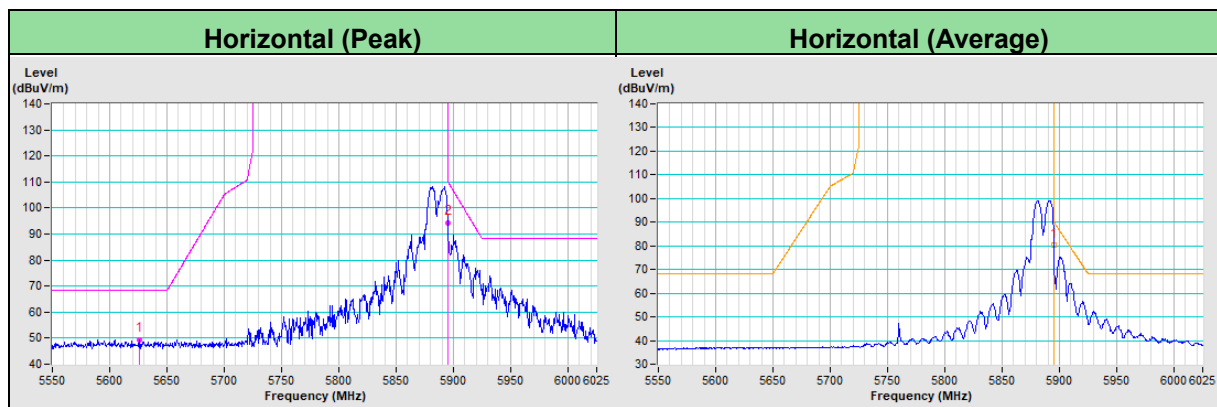

RF Mode	TX 20MHz Preamble 802.11ax (RU242)	Channel	CH 177 : 5885 MHz
Frequency Range	5550MHz ~ 6025MHz	Detector Function	Peak (PK) Average (AV)

Antenna Polarity & Test Distance : Vertical at 3m								
No	Frequency (MHz)	Emission Level (dBuV/m)	Limit (dBuV/m)	Margin (dB)	Antenna Height (m)	Table Angle (Degree)	Raw Value (dBuV)	Correction Factor (dB/m)
PK.1	#5596.45	49.7 PK	68.2	-18.5	2.25 V	237	48.0	1.7
PK.2	#5895.00	88.5 PK	110.2	-21.7	2.25 V	237	86.3	2.2
AV.1	#5895.00	82.6 AV	90.2	-7.6	2.25 V	237	80.4	2.2

Remarks:

1. Emission Level(dBuV/m) = Raw Value(dBuV) + Correction Factor(dB/m)
2. Correction Factor(dB/m) = Antenna Factor(dB/m) + Cable Factor(dB) – Pre-Amplifier Factor(dB)
3. Margin value = Emission Level – Limit value
4. The other emission levels were very low against the limit.
5. " # ": The radiated frequency is out of the restricted band.

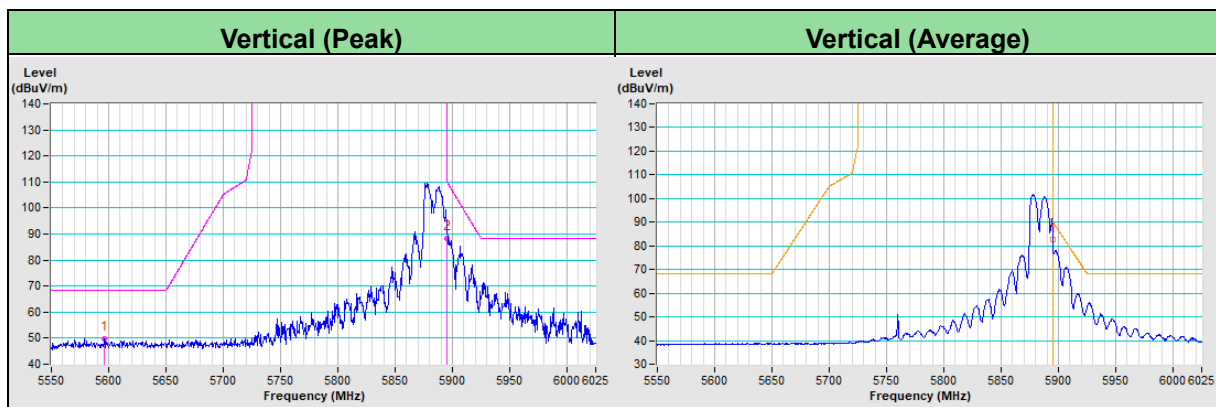

RF Mode	TX 80MHz Preamble 802.11ax (RU996)	Channel	CH 171 : 5855 MHz
Frequency Range	5550MHz ~ 6025MHz	Detector Function	Peak (PK) Average (AV)

Antenna Polarity & Test Distance : Horizontal at 3 m								
No	Frequency (MHz)	Emission Level (dBuV/m)	Limit (dBuV/m)	Margin (dB)	Antenna Height (m)	Table Angle (Degree)	Raw Value (dBuV)	Correction Factor (dB/m)
PK.1	#5648.02	48.9 PK	68.2	-19.3	1.18 H	181	47.1	1.8
PK.2	#5932.73	73.6 PK	88.2	-14.6	1.18 H	181	71.4	2.2
AV.1	#5932.73	64.0 AV	68.2	-4.2	1.18 H	181	61.8	2.2

Remarks:

1. Emission Level(dBuV/m) = Raw Value(dBuV) + Correction Factor(dB/m)
2. Correction Factor(dB/m) = Antenna Factor(dB/m) + Cable Factor(dB) – Pre-Amplifier Factor(dB)
3. Margin value = Emission Level – Limit value
4. The other emission levels were very low against the limit.
5. " # ": The radiated frequency is out of the restricted band.

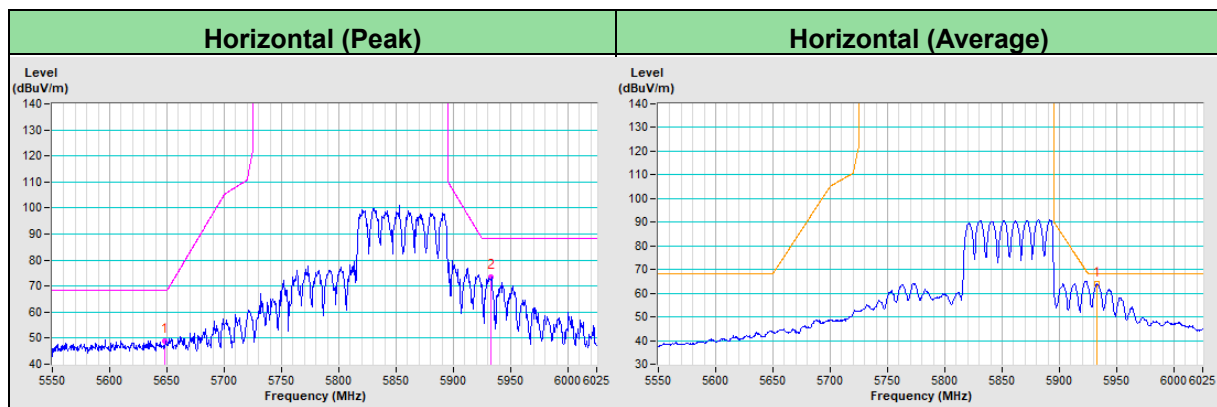

RF Mode	TX 80MHz Preamble 802.11ax (RU996)	Channel	CH 171 : 5855 MHz
Frequency Range	5550MHz ~ 6025MHz	Detector Function	Peak (PK) Average (AV)

Antenna Polarity & Test Distance : Vertical at 3m								
No	Frequency (MHz)	Emission Level (dBuV/m)	Limit (dBuV/m)	Margin (dB)	Antenna Height (m)	Table Angle (Degree)	Raw Value (dBuV)	Correction Factor (dB/m)
PK.1	#5644.53	62.2 PK	68.2	-6.0	2.22 V	238	60.4	1.8
PK.2	#5929.07	76.1 PK	88.2	-12.1	2.22 V	238	73.9	2.2
AV.1	#5929.07	65.7 AV	68.2	-2.5	2.22 V	238	63.5	2.2

Remarks:

1. Emission Level(dBuV/m) = Raw Value(dBuV) + Correction Factor(dB/m)
2. Correction Factor(dB/m) = Antenna Factor(dB/m) + Cable Factor(dB) – Pre-Amplifier Factor(dB)
3. Margin value = Emission Level – Limit value
4. The other emission levels were very low against the limit.
5. " # ": The radiated frequency is out of the restricted band.

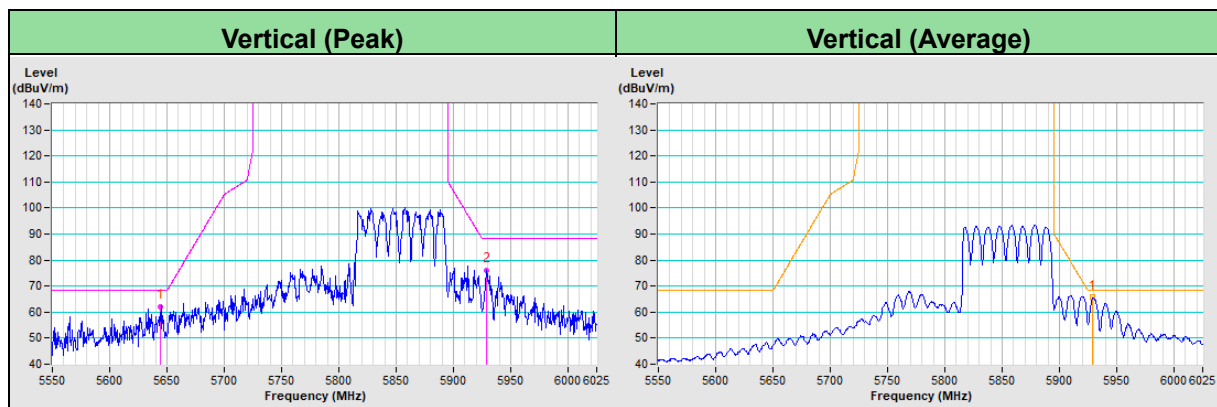

RF Mode	TX 160MHz Preamble 802.11ax (RU1992)	Channel	CH 163 : 5815 MHz
Frequency Range	5550MHz ~ 6025MHz	Detector Function	Peak (PK) Average (AV)

Antenna Polarity & Test Distance : Horizontal at 3 m								
No	Frequency (MHz)	Emission Level (dBuV/m)	Limit (dBuV/m)	Margin (dB)	Antenna Height (m)	Table Angle (Degree)	Raw Value (dBuV)	Correction Factor (dB/m)
PK.1	#5646.13	65.0 PK	68.2	-3.2	1.31 H	173	63.2	1.8
AV.1	#5931.47	64.8 AV	68.2	-3.4	1.31 H	173	62.6	2.2

Remarks:

1. Emission Level(dBuV/m) = Raw Value(dBuV) + Correction Factor(dB/m)
2. Correction Factor(dB/m) = Antenna Factor(dB/m) + Cable Factor(dB) – Pre-Amplifier Factor(dB)
3. Margin value = Emission Level – Limit value
4. The other emission levels were very low against the limit.
5. "#": The radiated frequency is out of the restricted band.

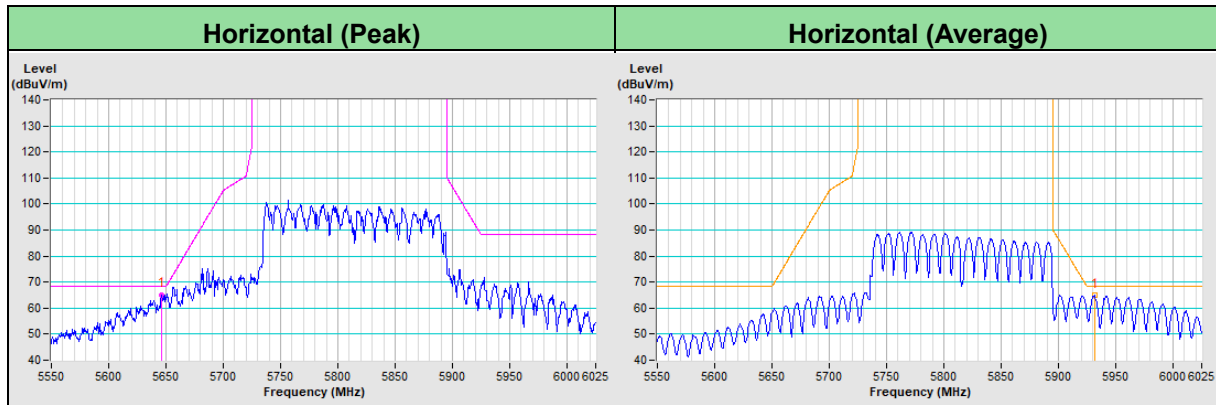

RF Mode	TX 160MHz Preamble 802.11ax (RU1992)	Channel	CH 163 : 5815 MHz
Frequency Range	5550MHz ~ 6025MHz	Detector Function	Peak (PK) Average (AV)

Antenna Polarity & Test Distance : Vertical at 3m								
No	Frequency (MHz)	Emission Level (dBuV/m)	Limit (dBuV/m)	Margin (dB)	Antenna Height (m)	Table Angle (Degree)	Raw Value (dBuV)	Correction Factor (dB/m)
PK.1	#5646.25	67.0 PK	68.2	-1.2	2.31 V	244	65.2	1.8
AV.1	#5927.33	67.3 AV	68.2	-0.9	2.31 V	244	65.1	2.2

Remarks:

1. Emission Level(dBuV/m) = Raw Value(dBuV) + Correction Factor(dB/m)
2. Correction Factor(dB/m) = Antenna Factor(dB/m) + Cable Factor(dB) – Pre-Amplifier Factor(dB)
3. Margin value = Emission Level – Limit value
4. The other emission levels were very low against the limit.
5. " # ": The radiated frequency is out of the restricted band.

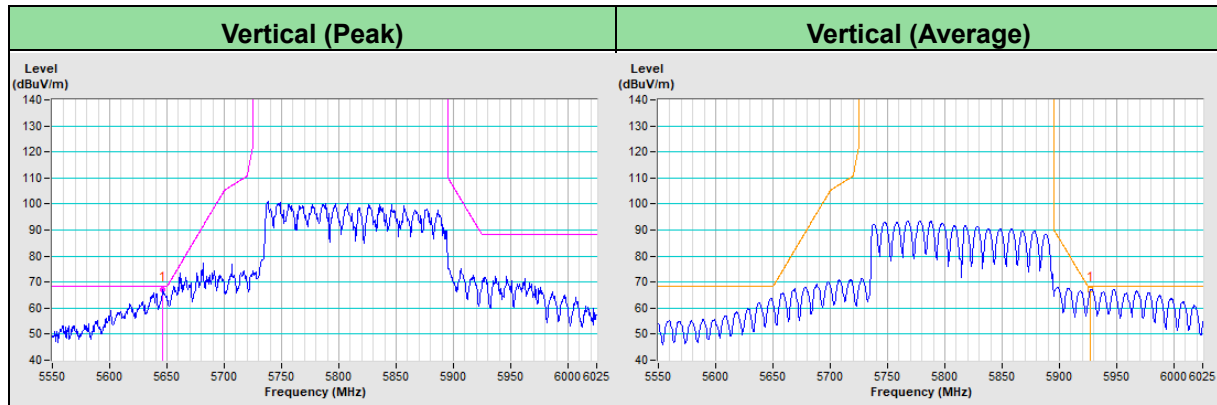

Appendix – Information of the Testing Laboratories

We, Bureau Veritas Consumer Products Services (H.K.) Ltd., Taoyuan Branch, were founded in 1988 to provide our best service in EMC, Radio, Telecom and Safety consultation. Our laboratories are FCC recognized accredited test firms and accredited according to ISO/IEC 17025.

If you have any comments, please feel free to contact us at the following:

Lin Kou EMC/RF Lab

Tel: 886-2-26052180

Fax: 886-2-26051924

Hsin Chu EMC/RF/Telecom Lab

Tel: 886-3-6668565

Fax: 886-3-6668323

Hwa Ya EMC/RF/Safety Lab

Tel: 886-3-3183232

Fax: 886-3-3270892

Email: service.adt@tw.bureauveritas.com

Web Site: www.bureauveritas-adt.com

The address and road map of all our labs can be found in our web site also.

--- END ---