

FCC Radio Test Report

FCC ID: RWO-RZ090368

This report concerns: Original Grant

Project No. : 2011C212C
Equipment : Notebook PC
Brand Name : RAZER
Test Model : RZ09-0368
Series Model : N/A
Applicant : Razer Inc.
Address : 9 Pasteur, Suite 100, Irvine, CA92618, USA.
Manufacturer : Razer Inc.
Address : 9 Pasteur, Suite 100, Irvine, CA92618, USA.
Date of Receipt : May 10, 2021
Date of Test : May 12, 2021 ~ Jun. 18, 2021
Issued Date : Nov. 01, 2021
Report Version : R00
Test Sample : Sample No.: DG2021051161
Standard(s) : FCC CFR Title 47, Part 15, Subpart C
FCC KDB 558074 D01 15.247 Meas Guidance v05r02
FCC KDB 662911 D01 Multiple Transmitter Output v02r01
ANSI C63.10-2013

The above equipment has been tested and found compliance with the requirement of the relative standards by BTL Inc.

Vincent Tan

Prepared by : Vincent Tan

Ethan Ma

Approved by : Ethan Ma



TESTING CERT #5123.02

Add: No.3, Jinshagang 1st Road, Shixia, Dalang Town, Dongguan, Guangdong, China.

Tel: +86-769-8318-3000

Web: www.newbtl.com

Declaration

BTL represents to the client that testing is done in accordance with standard procedures as applicable and that test instruments used has been calibrated with standards traceable to international standard(s) and/or national standard(s).

BTL's reports apply only to the specific samples tested under conditions. It is manufacture's responsibility to ensure that additional production units of this model are manufactured with the identical electrical and mechanical components. **BTL** shall have no liability for any declarations, inferences or generalizations drawn by the client or others from **BTL** issued reports.

The report must not be used by the client to claim product certification, approval, or endorsement by NVLAP, NIST, A2LA, or any agency of the U.S. Government.

This report is the confidential property of the client. As a mutual protection to the clients, the public and ourselves, the test report shall not be reproduced, except in full, without our written approval.

BTL's laboratory quality assurance procedures are in compliance with the **ISO/IEC 17025** requirements, and accredited by the conformity assessment authorities listed in this test report.

BTL is not responsible for the sampling stage, so the results only apply to the sample as received.

The information, data and test plan are provided by manufacturer which may affect the validity of results, so it is manufacturer's responsibility to ensure that the apparatus meets the essential requirements of applied standards and in all the possible configurations as representative of its intended use.

Limitation

For the use of the authority's logo is limited unless the Test Standard(s)/Scope(s)/Item(s) mentioned in this test report is (are) included in the conformity assessment authorities acceptance respective.

Please note that the measurement uncertainty is provided for informational purpose only and are not use in determining the Pass/Fail results.

Table of Contents	Page
REPORT ISSUED HISTORY	4
1 . SUMMARY OF TEST RESULTS	5
1.1 TEST FACILITY	6
1.2 MEASUREMENT UNCERTAINTY	6
1.3 TEST ENVIRONMENT CONDITIONS	6
2 . GENERAL INFORMATION	7
2.1 GENERAL DESCRIPTION OF EUT	7
2.2 DESCRIPTION OF TEST MODES	9
2.3 BLOCK DIAGRAM SHOWING THE CONFIGURATION OF SYSTEM TESTED	10
2.4 SUPPORT UNITS	10
3 . RADIATED EMISSIONS	11
3.1 LIMIT	11
3.2 TEST PROCEDURE	11
3.3 DEVIATION FROM TEST STANDARD	12
3.4 TEST SETUP	12
3.5 EUT OPERATION CONDITIONS	13
3.6 TEST RESULTS - 30 MHZ TO 1000 MHZ	13
3.7 TEST RESULTS - ABOVE 1000 MHZ	13
4 . MEASUREMENT INSTRUMENTS LIST	14
5 . EUT TEST PHOTO	15
APPENDIX A - RADIATED EMISSION - 30 MHZ TO 1000 MHZ	17
APPENDIX B - RADIATED EMISSION- ABOVE 1000 MHZ	20

REPORT ISSUED HISTORY

Report Version	Description	Issued Date
R00	Original Issue.	Nov. 01, 2021

1. SUMMARY OF TEST RESULTS

Test procedures according to the technical standard(s):

FCC CFR Title 47, Part 15, Subpart C				
Standard(s) Section	Test Item	Test Result	Judgment	Remark
15.207	AC Power Line Conducted Emissions	-----	PASS	-----
15.247(d) 15.205(a) 15.209(a)	Radiated Emissions	Appendix A Appendix B	PASS	-----
15.247(a)(2)	Bandwidth	-----	PASS	-----
15.247(b)(3)	Maximum Output Power	-----	PASS	-----
15.247(d)	Conducted Spurious Emissions	-----	PASS	-----
15.247(e)	Power Spectral Density	-----	PASS	-----
15.203	Antenna Requirement	-----	PASS	Note(2)

Note:

- (1) "N/A" denotes test is not applicable in this test report.
- (2) The device what use a permanently attached antenna were considered sufficient to comply with the provisions of 15.203.
- (3) In this report only the radiated spurious emissions were evaluated and recorded. For the test results of all other test items please refer to module test report.

1.1 TEST FACILITY

The test facilities used to collect the test data in this report is at the location of No.3, Jinshagang 1st Road, Shixia, Dalang Town, Dongguan, Guangdong, China
 BTL's Test Firm Registration Number for FCC: 357015
 BTL's Designation Number for FCC: CN1240

1.2 MEASUREMENT UNCERTAINTY

ISO/IEC 17025 requires that an estimate of the measurement uncertainties associated with the emissions test results be included in the report. The measurement uncertainties given below are based on a 95% confidence level (based on a coverage factor (k=2))
 The BTL measurement uncertainty as below table:

A. Radiated emissions test:

Test Site	Method	Measurement Frequency Range	Ant. H / V	U, (dB)
DG-CB03	CISPR	9kHz ~ 30MHz	-	3.02
		30MHz ~ 200MHz	V	4.26
		30MHz ~ 200MHz	H	3.38
		200MHz ~ 1,000MHz	V	3.98
		200MHz ~ 1,000MHz	H	3.94
		1GHz ~ 6GHz	-	3.96
		6GHz ~ 18GHz	-	5.24
		18GHz ~ 26.5GHz	-	3.62
		26.5GHz ~ 40GHz	-	4.00

Note: Unless specifically mentioned, the uncertainty of measurement has not been taken into account to declare the compliance or non-compliance to the specification.

1.3 TEST ENVIRONMENT CONDITIONS

Test Item	Temperature	Humidity	Test Voltage	Tested By
Radiated Emissions-30MHz to 1000MHz	26°C	52%	AC 120V/60Hz	Hayden Chen
Radiated Emissions-Above 1000MHz	26°C	52%	AC 120V/60Hz	Berton Luo

2. GENERAL INFORMATION

2.1 GENERAL DESCRIPTION OF EUT

Equipment	Notebook PC
Brand Name	RAZER
Test Model	RZ09-0368
Series Model	N/A
Model Difference(s)	N/A
Software Version	DA760_MB
Hardware Version	Windows 10 Home
Power Source	1# DC Voltage supplied from AC adapter. Brand / Model: RAZER / RC30-024801 2# Supplied from Li-ion battery Brand / Model: RAZER / RC30-0287
Power Rating	1# I/P: 100-240V~ 3.6A 50/60Hz O/P: 19.5V --- 11.8A 2# DC 15.4V, 4583mAh, 70.5Wh
Operation Frequency	2412 MHz ~ 2462 MHz
Modulation Type	IEEE 802.11b: DSSS IEEE 802.11g: OFDM IEEE 802.11n: OFDM IEEE 802.11ax: OFDMA
Bit Rate of Transmitter	IEEE 802.11b: 11/5.5/2/1 Mbps IEEE 802.11g: 54/48/36/24/18/12/9/6 Mbps IEEE 802.11n: up to 300 Mbps IEEE 802.11ax: up to 573.6 Mbps

Note:

1. For a more detailed features description, please refer to the manufacturer's specifications or the user's manual.

2. Channel List:

CH01 - CH11 for IEEE 802.11b, IEEE 802.11g, IEEE 802.11n(HT20), IEEE 802.11ax(HE20) CH03 - CH09 for IEEE 802.11n(HT40), IEEE 802.11ax(HE40)							
Channel	Frequency (MHz)	Channel	Frequency (MHz)	Channel	Frequency (MHz)	Channel	Frequency (MHz)
01	2412	04	2427	07	2442	10	2457
02	2417	05	2432	08	2447	11	2462
03	2422	06	2437	09	2452		

3. Table for Filed Antenna:

Ant.	Brand	P/N	Antenna Type	Connector	Gain (dBi)
1	molex	2170830101	PIFA	N/A	2.58
2	molex	2170830201	PIFA	N/A	3.09

Note:

- (1) The EUT incorporates a MIMO function. Physically, the EUT provides two completed transmitters and receivers (2T2R).
- (2) The antenna gain is provided by the manufacturer.

4. The worst case for 2TX as follow:

Operating Mode	TX Mode	2TX
IEEE 802.11b		V (Ant. 1+Ant. 2)
IEEE 802.11g		V (Ant. 1+Ant. 2)
IEEE 802.11n(HT20)		V (Ant. 1+Ant. 2)
IEEE 802.11n(HT40)		V (Ant. 1+Ant. 2)
IEEE 802.11ax(HE20)		V (Ant. 1+Ant. 2)
IEEE 802.11ax(HE40)		V (Ant. 1+Ant. 2)

2.2 DESCRIPTION OF TEST MODES

The test system was pre-tested based on the consideration of all possible combinations of EUT operation mode.

Pretest Mode	Description
Mode 1	TX B Mode Channel 01/06/11
Mode 2	TX G Mode Channel 01/06/11
Mode 3	TX N(HT20) Mode Channel 01/06/11
Mode 4	TX N(HT40) Mode Channel 03/06/09
Mode 5	TX AX(HE20) Mode Channel 01/06/11
Mode 6	TX AX(HE40) Mode Channel 03/06/09
Mode 7	TX AX(HE20) Mode Channel 01

Following mode(s) was (were) found to be the worst case(s) and selected for the final test.

Radiated emissions test - Below 1GHz	
Final Test Mode	Description
Mode 7	TX AX(HE20) Mode Channel 01

Radiated emissions test- Above 1GHz	
Final Test Mode	Description
Mode 1	TX B Mode Channel 01/06/11
Mode 2	TX G Mode Channel 01/06/11
Mode 3	TX N(HT20) Mode Channel 01/06/11
Mode 4	TX N(HT40) Mode Channel 03/06/09
Mode 5	TX AX(HE20) Mode Channel 01/06/11
Mode 6	TX AX(HE40) Mode Channel 03/06/09

NOTE:

- (1) For radiated emission below 1 GHz test, the TX AX(HE20) Mode Channel 01 is found to be the worst case and recorded.
- (2) IEEE 802.11ax mode only supports full RU, so only the full RU is evaluated and measured inside report.

2.3 BLOCK DIAGRAM SHOWING THE CONFIGURATION OF SYSTEM TESTED

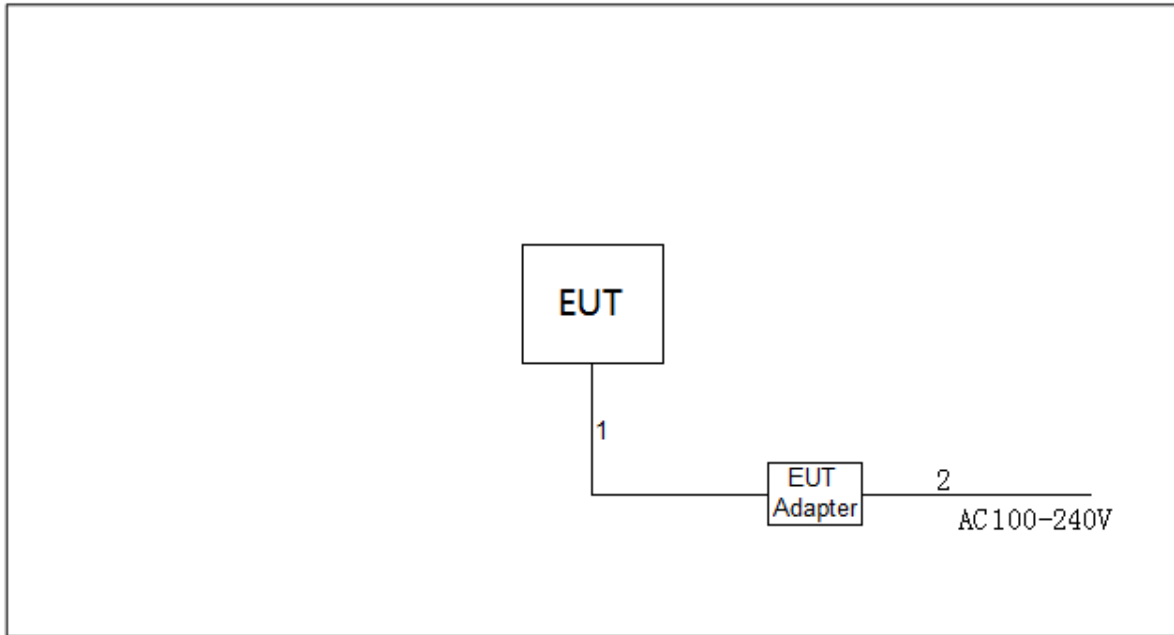

2.4 SUPPORT UNITS

Item	Equipment	Brand	Model No.	Series No.
-	-	-	-	-

Item	Cable Type	Shielded Type	Ferrite Core	Length
1	DC Cable	NO	NO	2m
2	AC Cable	NO	NO	1m

3. RADIATED EMISSIONS

3.1 LIMIT

In case the emission fall within the restricted band specified on 15.205(a) , then the 15.209(a) limit in the table below has to be followed.

LIMITS OF RADIATED EMISSION MEASUREMENT (30 MHz -1000 MHz)

Frequency (MHz)	Field Strength (microvolts/meter)	Measurement Distance (meters)
30-88	100	3
88-216	150	3
216-960	200	3
Above 960	500	3

LIMITS OF RADIATED EMISSION MEASUREMENT (Above 1000 MHz)

Frequency (MHz)	(dBuV/m at 3 m)	
	Peak	Average
Above 1000	74	54

NOTE:

- (1) The limit for radiated test was performed according to FCC CFR Title 47, Part 15, Subpart C.
- (2) The tighter limit applies at the band edges.
- (3) Emission level (dBuV/m)=20log Emission level (uV/m).

3.2 TEST PROCEDURE

- a. The measuring distance of 3 m shall be used for measurements. The EUT was placed on the top of a rotating table 0.8 meter above the ground at a 3 meter semi-anechoic chamber. The table was rotated 360 degrees to determine the position of the highest radiation.(below 1 GHz)
- b. The measuring distance of 3 m shall be used for measurements. The EUT was placed on the top of a rotating table 1.5 meter above the ground at a 3 meter semi-anechoic chamber. The table was rotated 360 degrees to determine the position of the highest radiation.(above 1 GHz)
- c. The height of the equipment or of the substitution antenna shall be 0.8m or 1.5m; the height of the test antenna shall vary between 1 m to 4 m. Both horizontal and vertical polarizations of the antenna are set to make the measurement.
- d. For each suspected emission, the EUT was arranged to its worst case and then the antenna was tuned to heights find the maximum reading (used Bore sight function).
- e. The receiver system was set to peak and average detect function and specified bandwidth with maximum hold mode when the test frequency is above 1 GHz.
- f. The initial step in collecting radiated emission data is a receiver peak detector mode pre-scanning the measurement frequency range. Significant peaks are then marked and then Quasi Peak detector mode re-measured.
- g. All readings are Peak unless otherwise stated QP in column of Note. Peak denotes that the Peak reading compliance with the QP Limits and then QP Mode measurement didn't perform. (below 1 GHz)
- h. All readings are Peak Mode value unless otherwise stated AVG in column of Note. If the Peak Mode Measured value compliance with the Peak Limits and lower than AVG Limits, the EUT shall be deemed to meet both Peak & AVG Limits and then only Peak Mode was measured, but AVG Mode didn't perform. (above 1 GHz)
- i. For the actual test configuration, please refer to the related Item -EUT Test Photos.

The following table is the setting of the receiver:

Spectrum Parameters	Setting
Start ~ Stop Frequency	9 kHz~150 kHz for RBW 200 Hz
Start ~ Stop Frequency	0.15 MHz~30 MHz for RBW 9 kHz
Start ~ Stop Frequency	30 MHz~1000 MHz for RBW 100 kHz

Spectrum Parameters	Setting
Start Frequency	1000 MHz
Stop Frequency	10th carrier harmonic
RBW / VBW (Emission in restricted band)	1 MHz / 3 MHz for PK value 1 MHz / 1/T Hz for AVG value

Receiver Parameters	Setting
Start ~ Stop Frequency	9 kHz~90 kHz for PK/AVG detector
Start ~ Stop Frequency	90 kHz~110 kHz for QP detector
Start ~ Stop Frequency	110 kHz~490 kHz for PK/AVG detector
Start ~ Stop Frequency	490 kHz~30 MHz for QP detector
Start ~ Stop Frequency	30 MHz~1000 MHz for QP detector
Start ~ Stop Frequency	1 GHz~26.5 GHz for PK/AVG detector

3.3 DEVIATION FROM TEST STANDARD

No deviation.

3.4 TEST SETUP

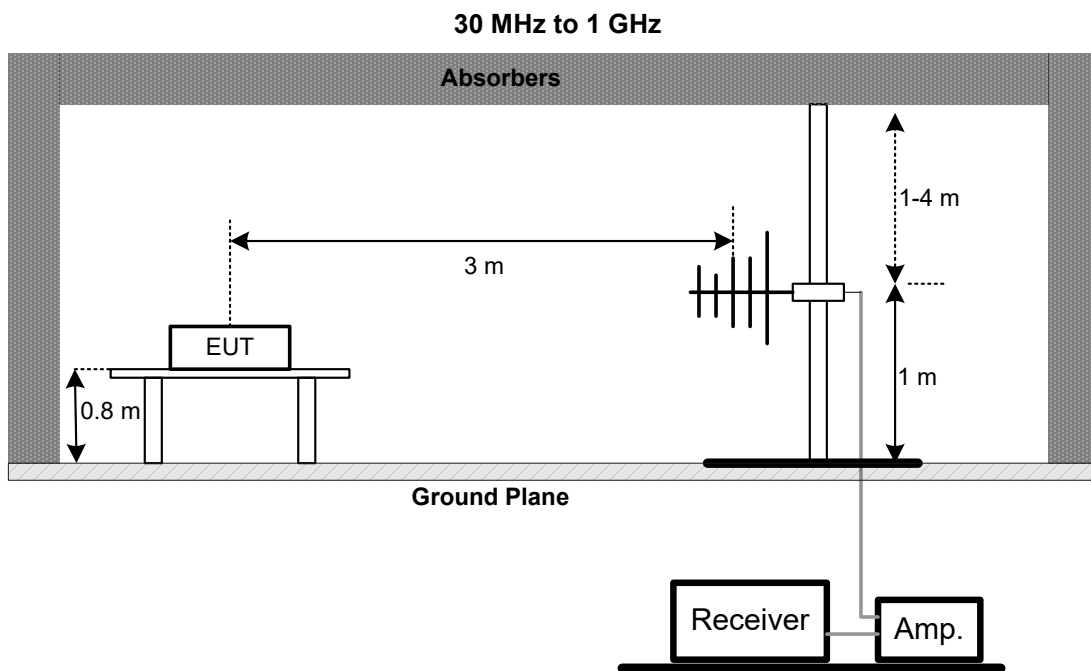

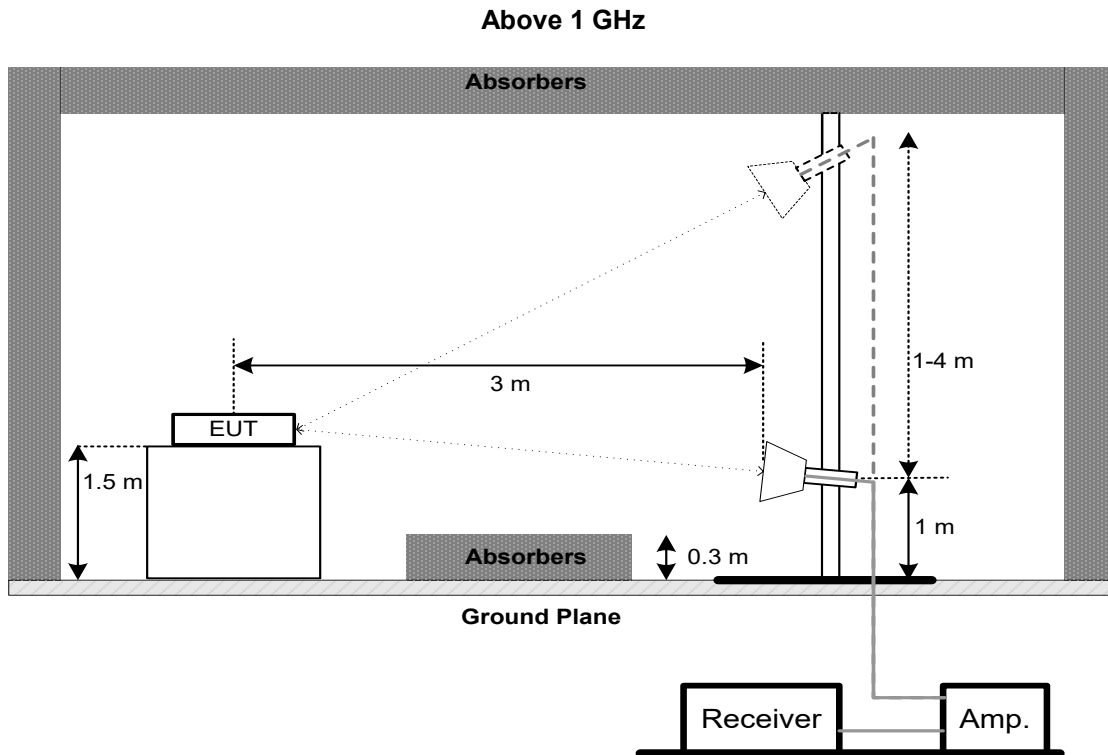

3.5 EUT OPERATION CONDITIONS

The EUT was programmed to be in continuously transmitting mode.

3.6 TEST RESULTS - 30 MHZ TO 1000 MHZ

Please refer to the APPENDIX A.

3.7 TEST RESULTS - ABOVE 1000 MHZ

Please refer to the APPENDIX B.

Remark:

- (1) No limit: This is fundamental signal, the judgment is not applicable.
For fundamental signal judgment was referred to Peak output test.

4. MEASUREMENT INSTRUMENTS LIST

Radiated Emissions - 30 MHz to 1 GHz					
Item	Kind of Equipment	Manufacturer	Type No.	Serial No.	Calibrated until
1	Antenna	Schwarzbeck	VULB9160	9160-3232	Mar. 15, 2022
2	Amplifier	HP	8447D	2944A08742	Feb. 28, 2022
3	Receiver	Agilent	N9038A	MY52130039	Jul. 25, 2021
4	Cable	emci	LMR-400(30MHz-1 GHz)(8m+5m)	N/A	May 20, 2022
5	Controller	CT	SC100	N/A	N/A
6	Controller	MF	MF-7802	MF780208416	N/A
7	Measurement Software	Farad	EZ-EMC Ver.NB-03A1-01	N/A	N/A
8	966 Chambe Room	RM	9*6*6m	N/A	Jul. 25, 2021

Radiated Emissions - Above 1 GHz					
Item	Kind of Equipment	Manufacturer	Type No.	Serial No.	Calibrated until
1	Double Ridged Guide Antenna	ETS	3115	75789	May 10, 2022
2	Broad-Band Horn Antenna	Schwarzbeck	BBHA 9170	9170319	Jul. 07, 2021
3	Amplifier	Agilent	8449B	3008A02584	Jul. 25, 2021
4	Microwave Preamplifier With Adaptor	EMC INSTRUMENT	EMC2654045	980039 & HA01	Feb. 28, 2022
5	Receiver	Agilent	N9038A	MY52130039	Jul. 25, 2021
6	Controller	CT	SC100	N/A	N/A
7	Controller	MF	MF-7802	MF780208416	N/A
8	Cable	N/A	EMC104-SM-SM-6000	N/A	Oct. 16, 2021
9	Measurement Software	Farad	EZ-EMC Ver.NB-03A1-01	N/A	N/A
10	Filter	STI	STI15-9912	N/A	Jul. 25, 2021
11	966 Chambe Room	RM	9*6*6m	N/A	Jul. 25, 2021

Remark: "N/A" denotes no model name, serial no. or calibration specified.

All calibration period of equipment list is one year.

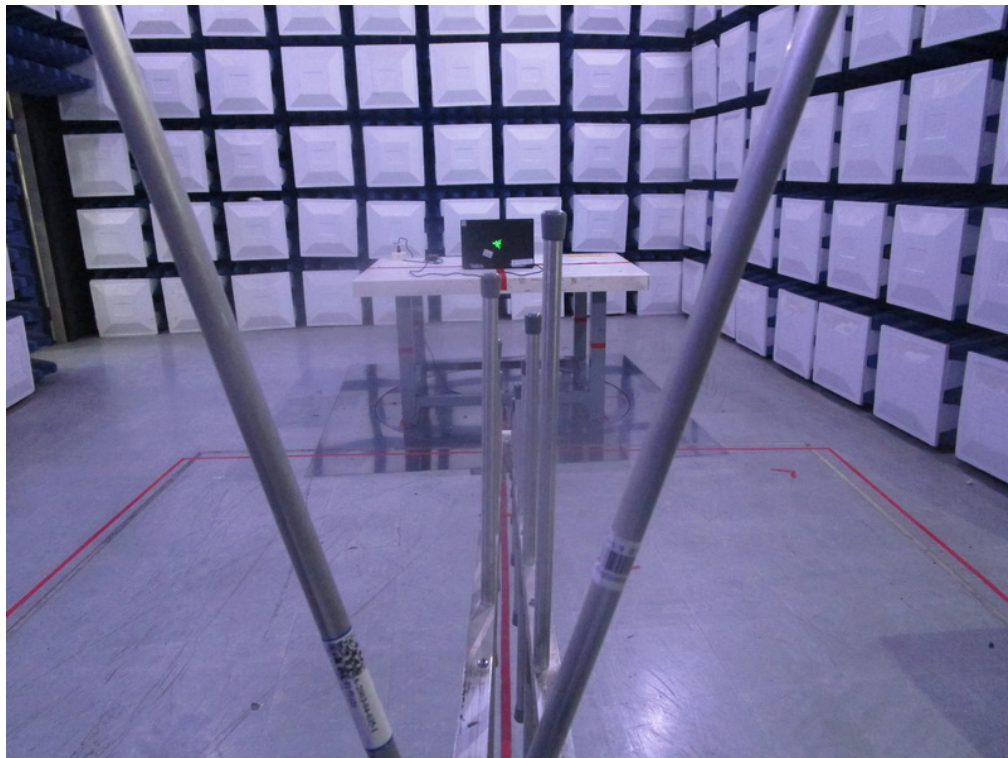
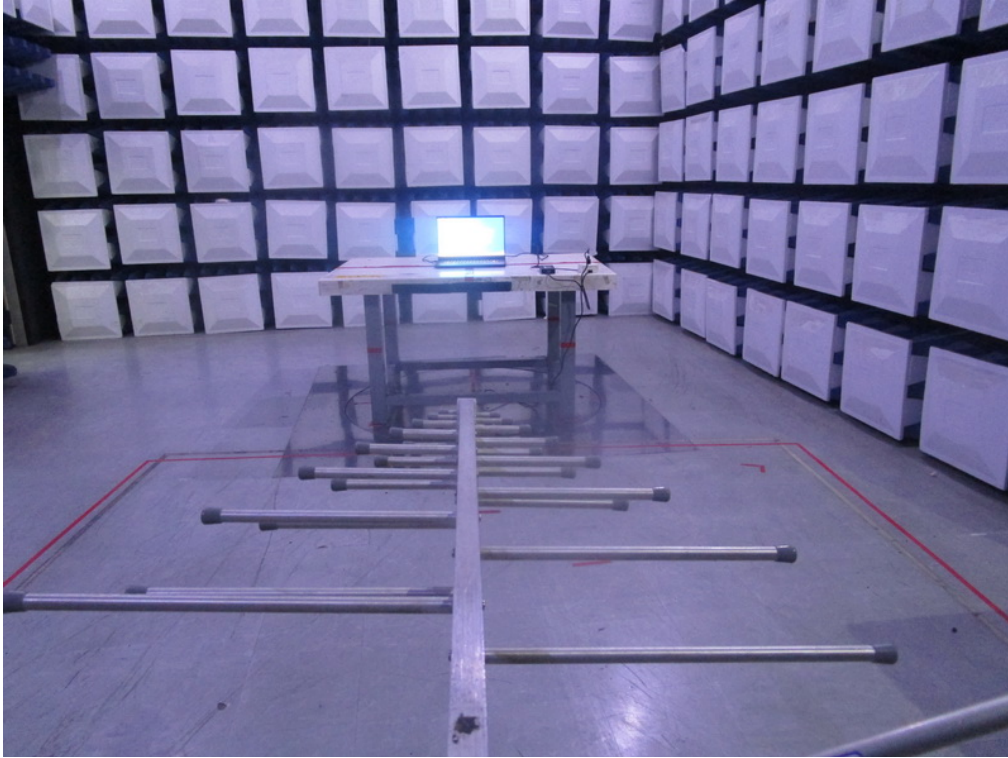
5. EUT TEST PHOTO**Radiated Emissions Test Photos****30 MHz to 1000 MHz**

Radiated Emissions Test Photos

Above 1 GHz

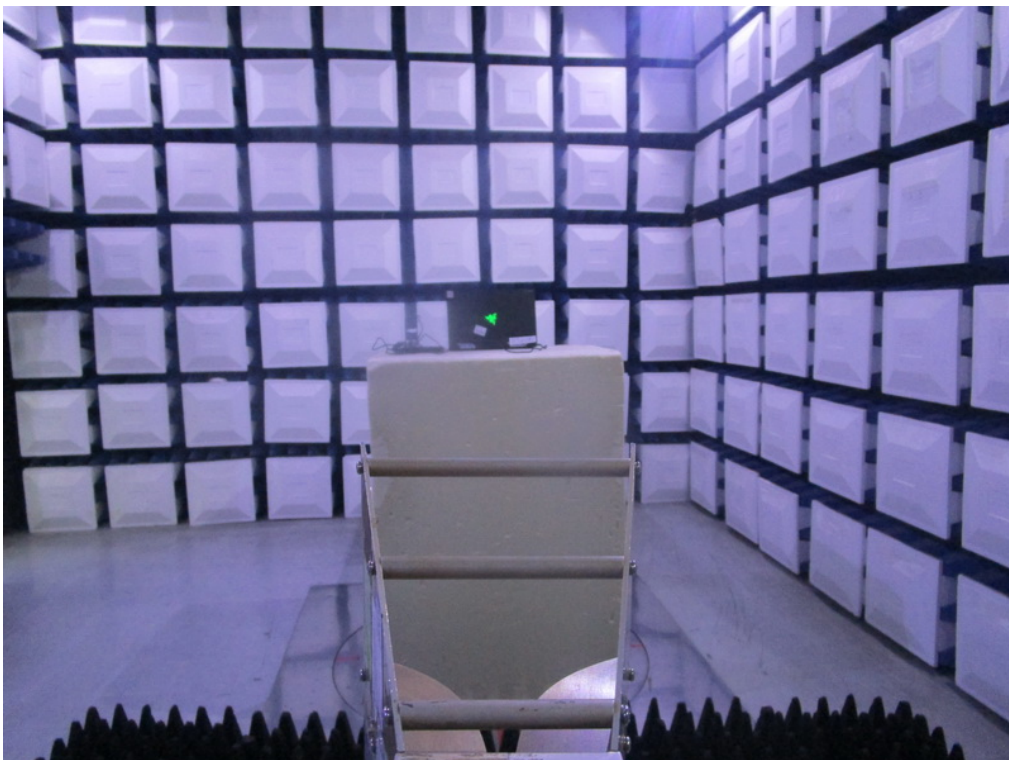

APPENDIX A - RADIATED EMISSION - 30 MHZ TO 1000 MHZ

Test Mode	TX AX(HE20) Mode Channel 01	Polarization	Vertical
-----------	-----------------------------	--------------	----------

80 dBuV/m

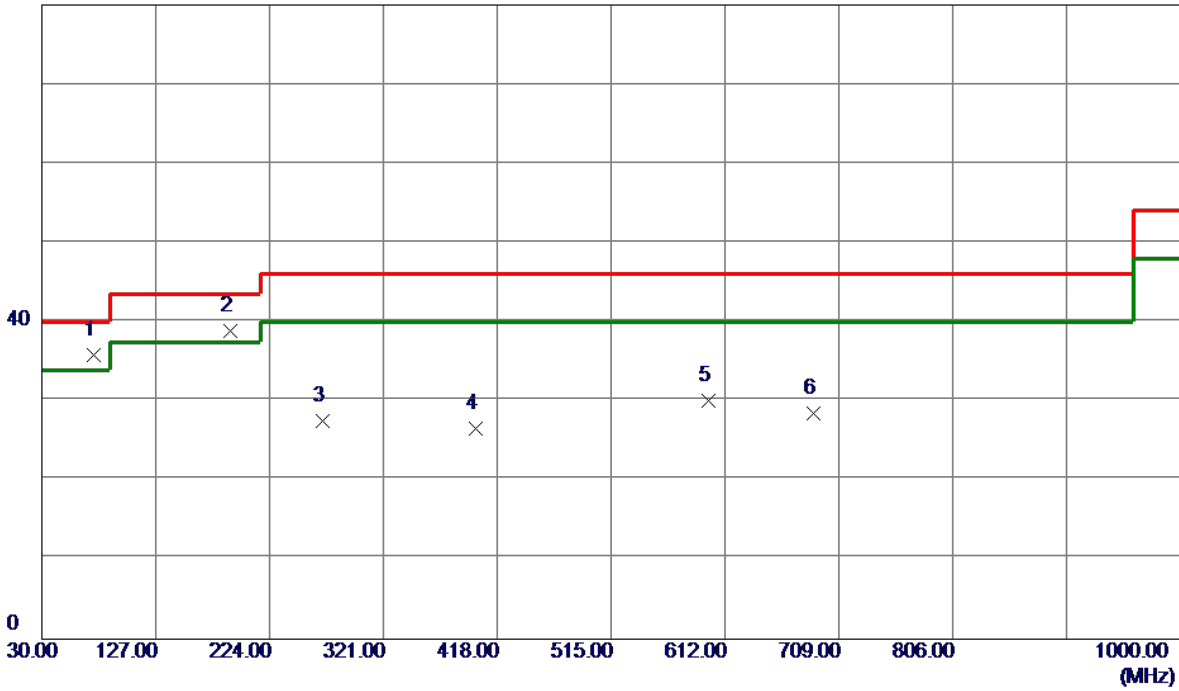

No.	Freq. MHz	Reading Level dBuV/m	Correct Factor dB	Measure ment dBuV/m	Limit dBuV/m	Margin dB	Detector	Comment
1 *	74.6200	53.01	-17.24	35.77	40.00	-4.23	QP	
2	191.0200	53.91	-14.99	38.92	43.50	-4.58	Peak	
3	269.5900	39.71	-12.19	27.52	46.00	-18.48	Peak	
4	399.5700	35.39	-8.79	26.60	46.00	-19.40	Peak	
5	598.4200	34.60	-4.59	30.01	46.00	-15.99	Peak	
6	687.6599	31.68	-3.23	28.45	46.00	-17.55	Peak	

REMARKS:

- (1) Measurement Value = Reading Level + Correct Factor.
- (2) Margin Level = Measurement Value - Limit Value.

Test Mode	TX AX(HE20) Mode Channel 01	Polarization	Horizontal
-----------	-----------------------------	--------------	------------

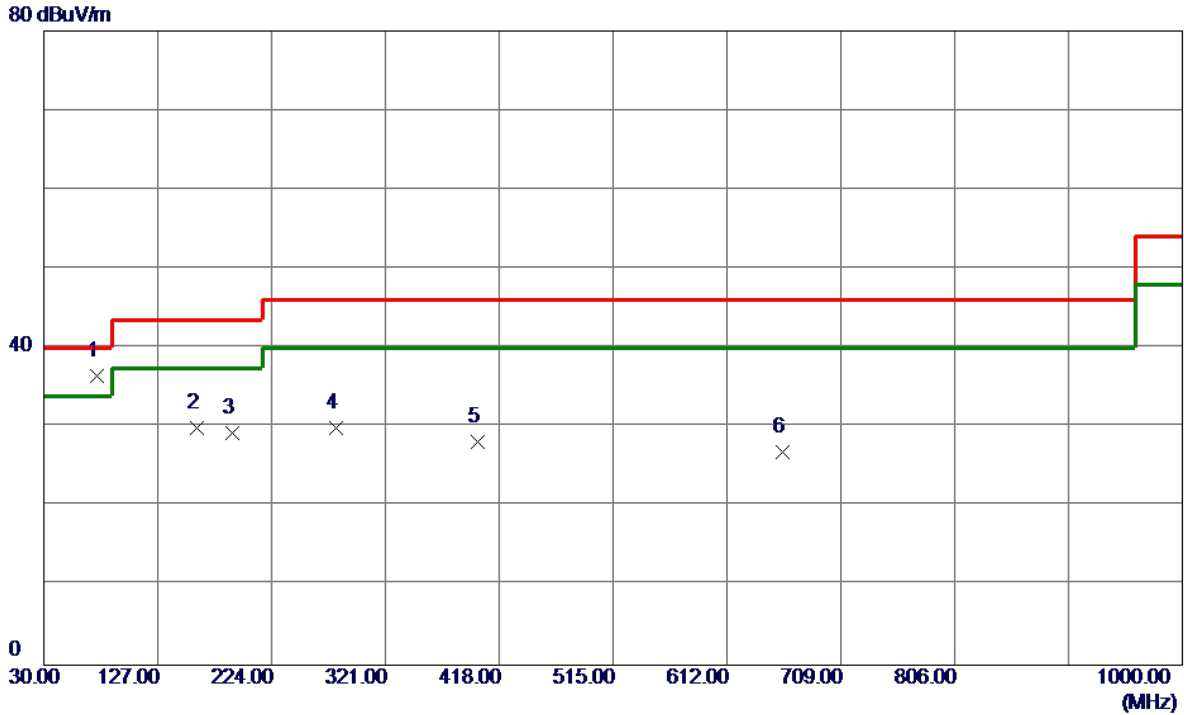

No.	Freq. MHz	Reading Level dBuV/m	Correct Factor dB	Measure ment dBuV/m	Limit dBuV/m	Margin dB	Detector	Comment
1 *	75.5899	53.87	-17.45	36.42	40.00	-3.58	Peak	
2	159.9800	42.35	-12.37	29.98	43.50	-13.52	Peak	
3	191.0200	44.33	-14.99	29.34	43.50	-14.16	Peak	
4	279.2900	41.54	-11.61	29.93	46.00	-16.07	Peak	
5	399.5700	36.96	-8.79	28.17	46.00	-17.83	Peak	
6	659.5300	30.49	-3.61	26.88	46.00	-19.12	Peak	

REMARKS:

- (1) Measurement Value = Reading Level + Correct Factor.
- (2) Margin Level = Measurement Value - Limit Value.

APPENDIX B - RADIATED EMISSION- ABOVE 1000 MHZ

Test Mode	TX B Mode 2412 MHz	Polarization	Vertical
-----------	--------------------	--------------	----------

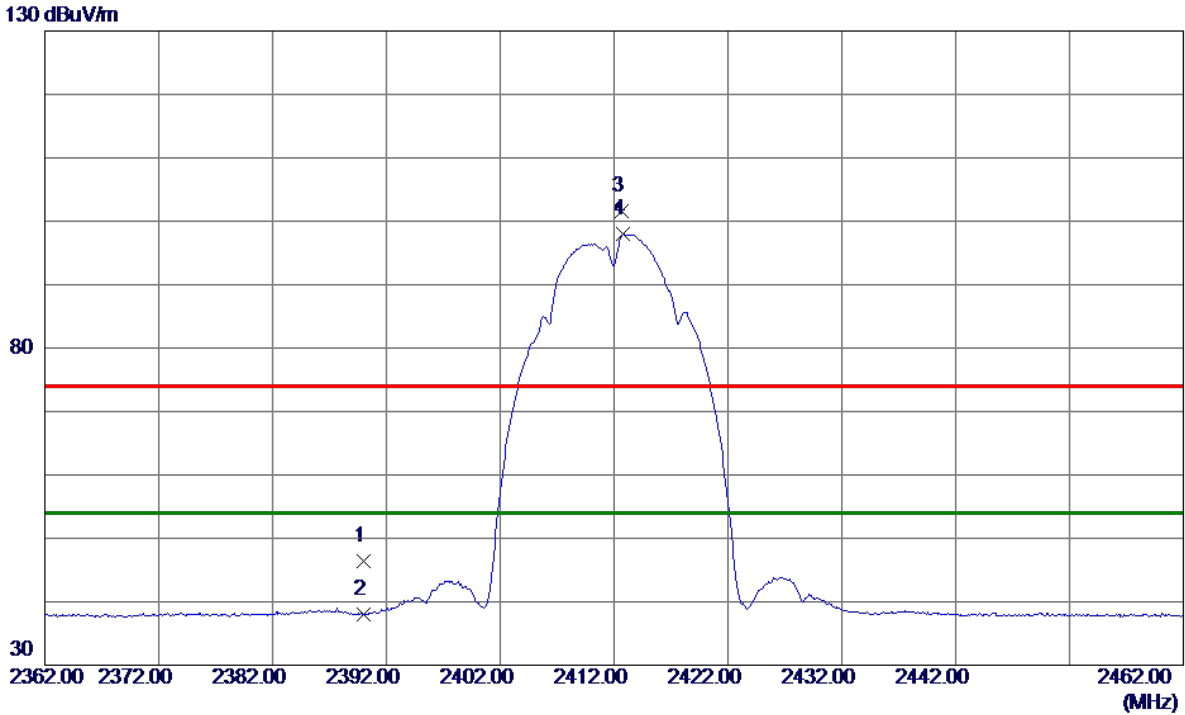

No.	Freq. MHz	Reading Level dBuV/m	Correct Factor dB	Measure ment dBuV/m	Limit dBuV/m	Margin dB	Detector	Comment
1	2390.0000	39.12	7.26	46.38	74.00	-27.62	Peak	
2	2390.0000	30.69	7.26	37.95	54.00	-16.05	AVG	
3	2412.7000	94.38	7.26	101.64	74.00	27.64	Peak	No Limit
4 *	2412.8000	97.73	7.26	97.99	54.00	43.99	AVG	No Limit

REMARKS:

- (1) Measurement Value = Reading Level + Correct Factor.
- (2) Margin Level = Measurement Value - Limit Value.

Test Mode	TX B Mode 2412 MHz	Polarization	Vertical
-----------	--------------------	--------------	----------

80 dBuV/m

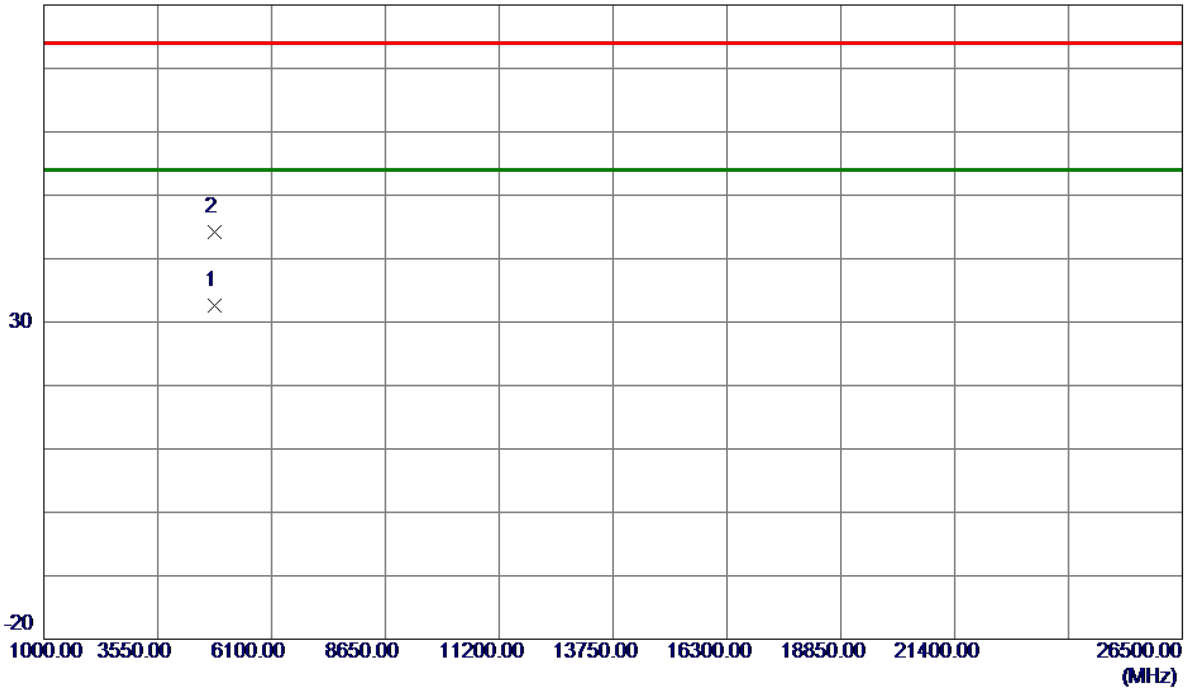

No.	Freq. MHz	Reading Level dBuV/m	Correct Factor dB	Measure ment dBuV/m	Limit dBuV/m	Margin dB	Detector	Comment
1 *	4823.1380	28.18	4.45	32.63	54.00	-21.37	AVG	
2	4824.2360	39.75	4.45	44.20	74.00	-29.80	Peak	

REMARKS:

- (1) Measurement Value = Reading Level + Correct Factor.
- (2) Margin Level = Measurement Value - Limit Value.

Test Mode	TX B Mode 2412 MHz	Polarization	Horizontal
-----------	--------------------	--------------	------------

130 dBuV/m

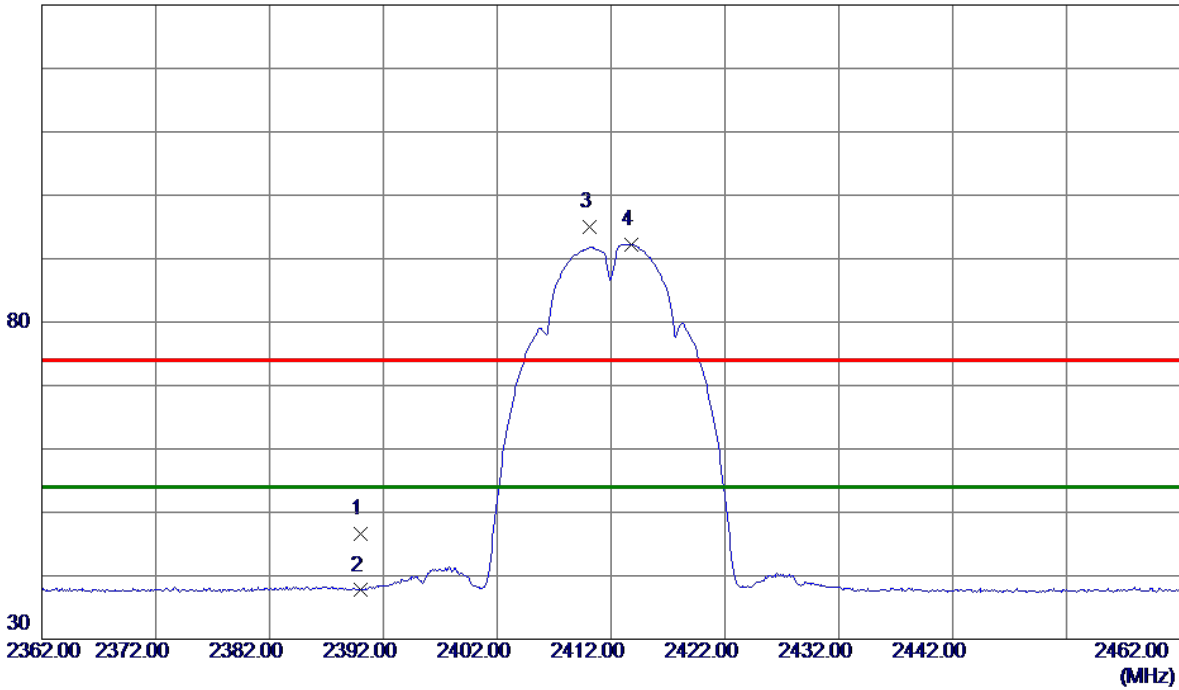

No.	Freq. MHz	Reading Level dBuV/m	Correct Factor dB	Measure ment dBuV/m	Limit dBuV/m	Margin dB	Detector	Comment
1	2390.0000	39.30	7.26	46.56	74.00	-27.44	Peak	
2	2390.0000	30.44	7.26	37.70	54.00	-16.30	AVG	
3	2410.1000	87.68	7.26	94.94	74.00	20.94	Peak	No Limit
4 *	2413.8000	85.03	7.26	92.29	54.00	38.29	AVG	No Limit

REMARKS:

- (1) Measurement Value = Reading Level + Correct Factor.
- (2) Margin Level = Measurement Value - Limit Value.

Test Mode	TX B Mode 2412 MHz	Polarization	Horizontal
-----------	--------------------	--------------	------------

80 dBuV/m

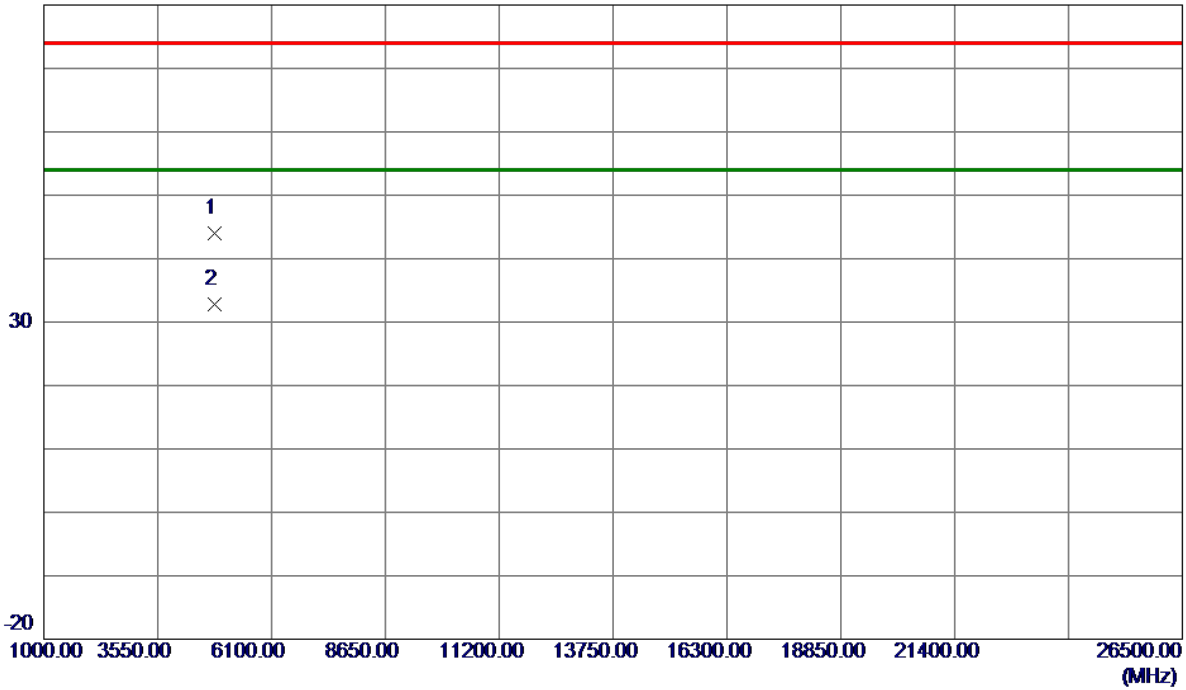

No.	Freq. MHz	Reading Level dBuV/m	Correct Factor dB	Measure ment dBuV/m	Limit dBuV/m	Margin dB	Detector	Comment
1	4824.6669	39.62	4.45	44.07	74.00	-29.93	Peak	
2 *	4824.7540	28.41	4.45	32.86	54.00	-21.14	AVG	

REMARKS:

- (1) Measurement Value = Reading Level + Correct Factor.
- (2) Margin Level = Measurement Value - Limit Value.

Test Mode	TX B Mode 2437 MHz	Polarization	Vertical
-----------	--------------------	--------------	----------

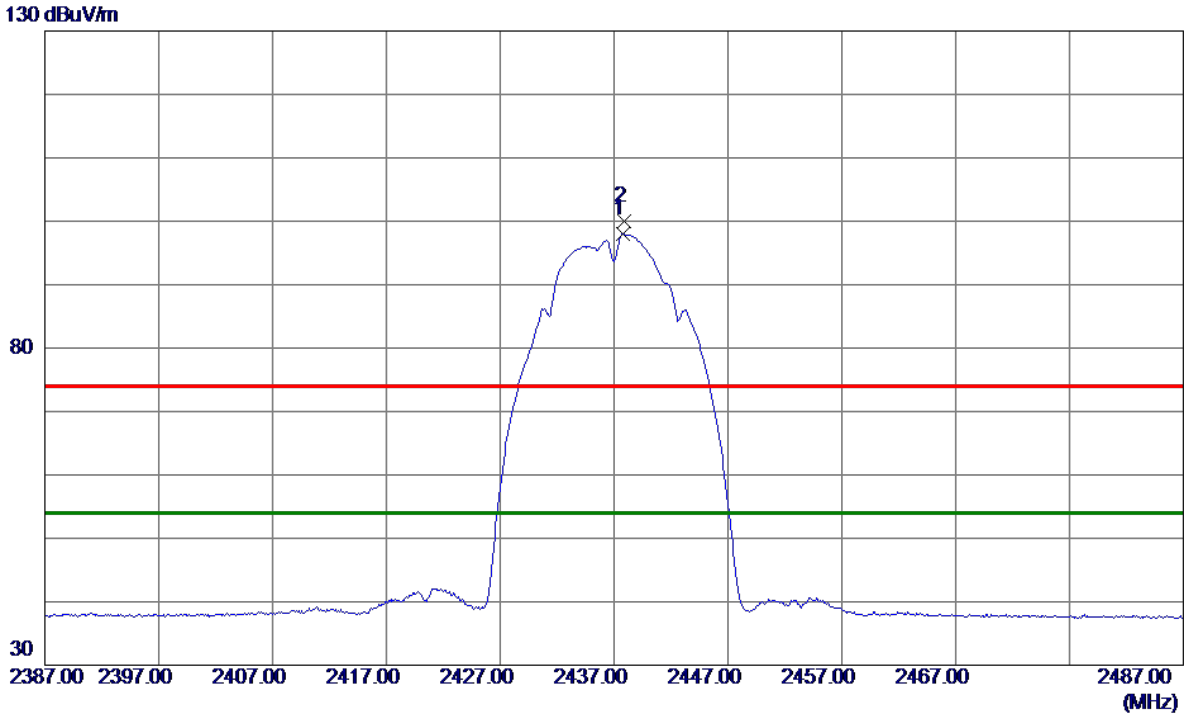

No.	Freq. MHz	Reading Level dBuV/m	Correct Factor dB	Measure ment dBuV/m	Limit dBuV/m	Margin dB	Detector	Comment
1 *	2437.8000	90.85	7.25	98.10	54.00	44.10	AVG	No Limit
2	2437.9000	92.70	7.25	99.95	74.00	25.95	Peak	No Limit

REMARKS:

- (1) Measurement Value = Reading Level + Correct Factor.
- (2) Margin Level = Measurement Value - Limit Value.

Test Mode	TX B Mode 2437 MHz	Polarization	Vertical
-----------	--------------------	--------------	----------

80 dBuV/m

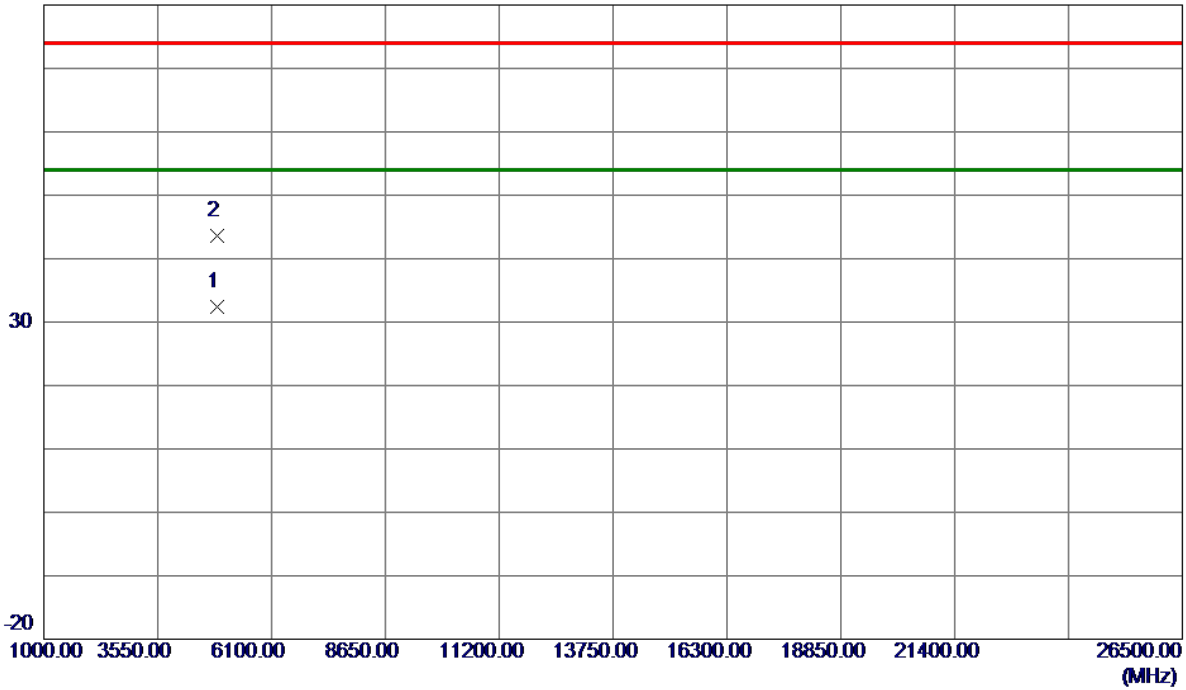

No.	Freq. MHz	Reading Level dBuV/m	Correct Factor dB	Measure ment dBuV/m	Limit dBuV/m	Margin dB	Detector	Comment
1 *	4873.1389	27.87	4.58	32.45	54.00	-21.55	AVG	
2	4873.7730	38.99	4.58	43.57	74.00	-30.43	Peak	

REMARKS:

- (1) Measurement Value = Reading Level + Correct Factor.
- (2) Margin Level = Measurement Value - Limit Value.

Test Mode	TX B Mode 2437 MHz	Polarization	Horizontal
-----------	--------------------	--------------	------------

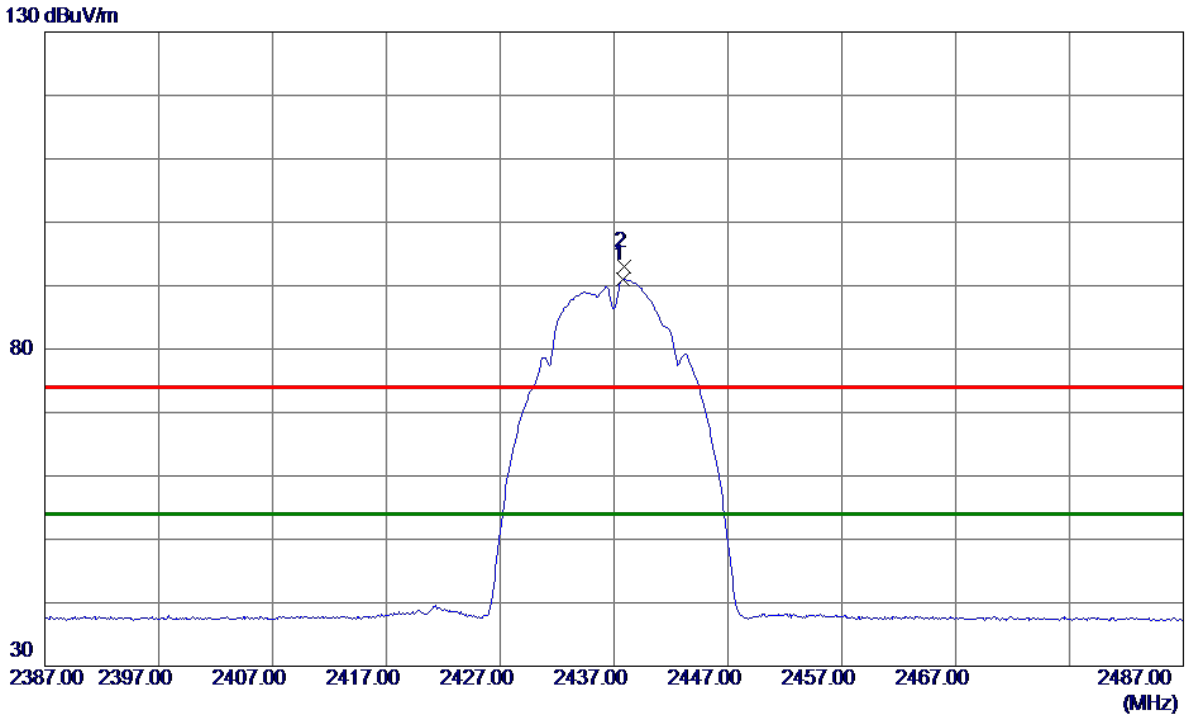

No.	Freq. MHz	Reading Level dBuV/m	Correct Factor dB	Measure ment dBuV/m	Limit dBuV/m	Margin dB	Detector	Comment
1 *	2437.8000	83.83	7.25	91.08	54.00	37.08	AVG	No Limit
2	2437.9000	85.74	7.25	92.99	74.00	18.99	Peak	No Limit

REMARKS:

- (1) Measurement Value = Reading Level + Correct Factor.
- (2) Margin Level = Measurement Value - Limit Value.

Test Mode	TX B Mode 2437 MHz	Polarization	Horizontal
-----------	--------------------	--------------	------------

80 dBuV/m

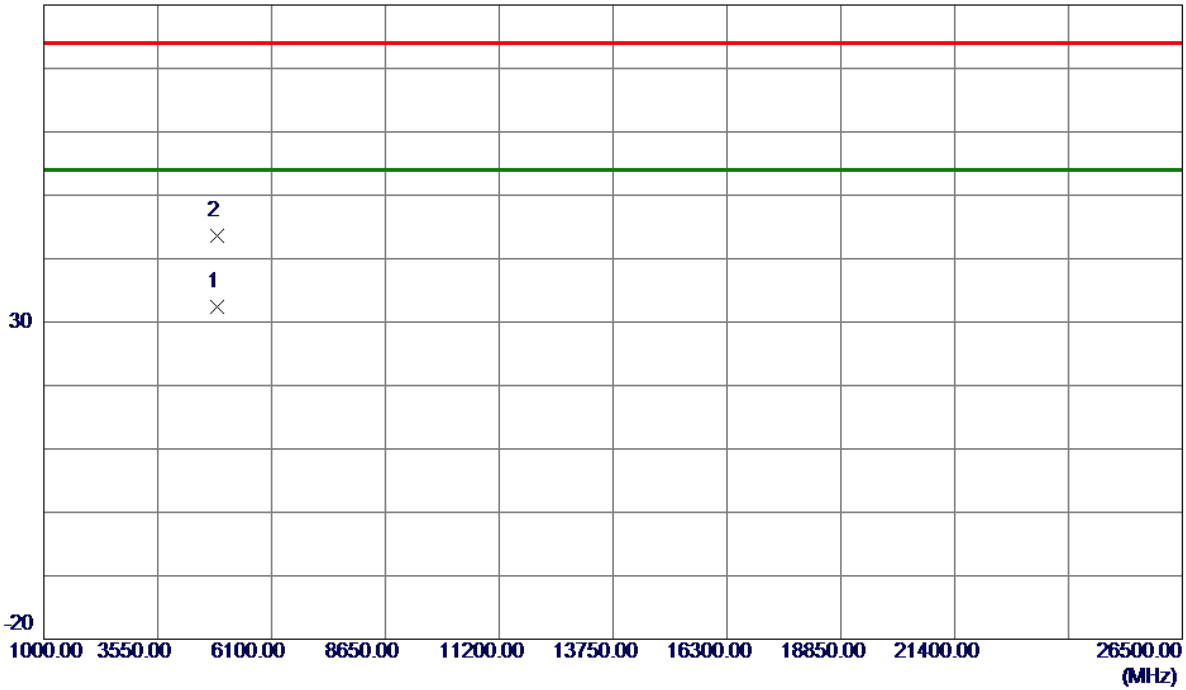

No.	Freq. MHz	Reading Level dBuV/m	Correct Factor dB	Measure ment dBuV/m	Limit dBuV/m	Margin dB	Detector	Comment
1 *	4874.4910	27.89	4.58	32.47	54.00	-21.53	AVG	
2	4874.6250	39.08	4.59	43.67	74.00	-30.33	Peak	

REMARKS:

- (1) Measurement Value = Reading Level + Correct Factor.
- (2) Margin Level = Measurement Value - Limit Value.

Test Mode	TX B Mode 2462 MHz	Polarization	Vertical
-----------	--------------------	--------------	----------

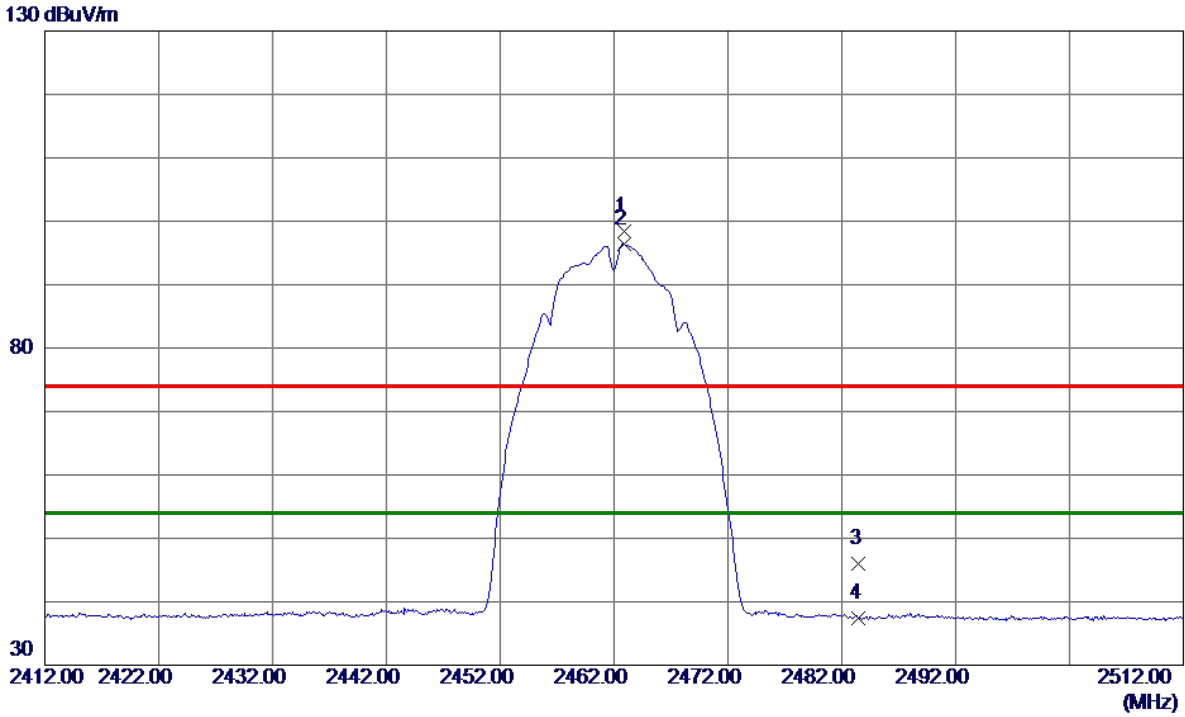

No.	Freq. MHz	Reading Level dBuV/m	Correct Factor dB	Measure ment dBuV/m	Limit dBuV/m	Margin dB	Detector	Comment
1	2462.9000	91.06	7.25	98.31	74.00	24.31	Peak	No Limit
2 *	2462.9000	89.15	7.25	96.40	54.00	42.40	AVG	No Limit
3	2483.5000	38.80	7.25	46.05	74.00	-27.95	Peak	
4	2483.5000	30.12	7.25	37.37	54.00	-16.63	AVG	

REMARKS:

- (1) Measurement Value = Reading Level + Correct Factor.
- (2) Margin Level = Measurement Value - Limit Value.

Test Mode	TX B Mode 2462 MHz	Polarization	Vertical
-----------	--------------------	--------------	----------

80 dBuV/m

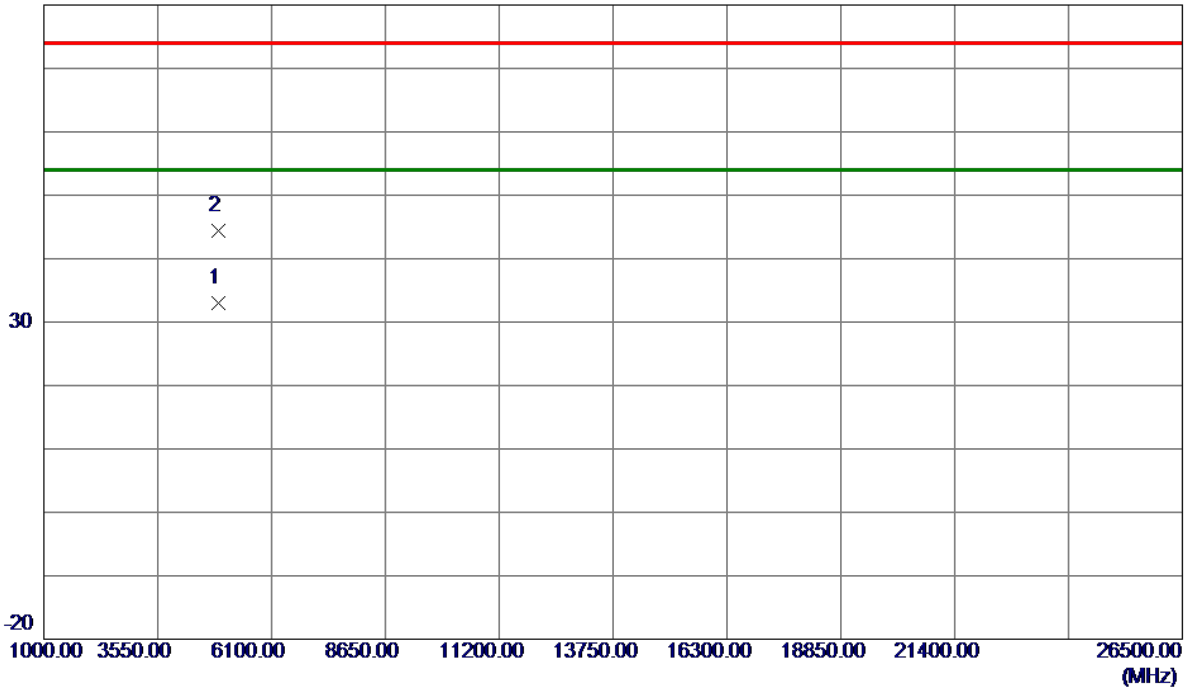

No.	Freq. MHz	Reading Level dBuV/m	Correct Factor dB	Measure ment dBuV/m	Limit dBuV/m	Margin dB	Detector	Comment
1 *	4923.6400	28.37	4.72	33.09	54.00	-20.91	AVG	
2	4923.7580	39.76	4.72	44.48	74.00	-29.52	Peak	

REMARKS:

- (1) Measurement Value = Reading Level + Correct Factor.
- (2) Margin Level = Measurement Value - Limit Value.

Test Mode	TX B Mode 2462 MHz	Polarization	Horizontal
-----------	--------------------	--------------	------------

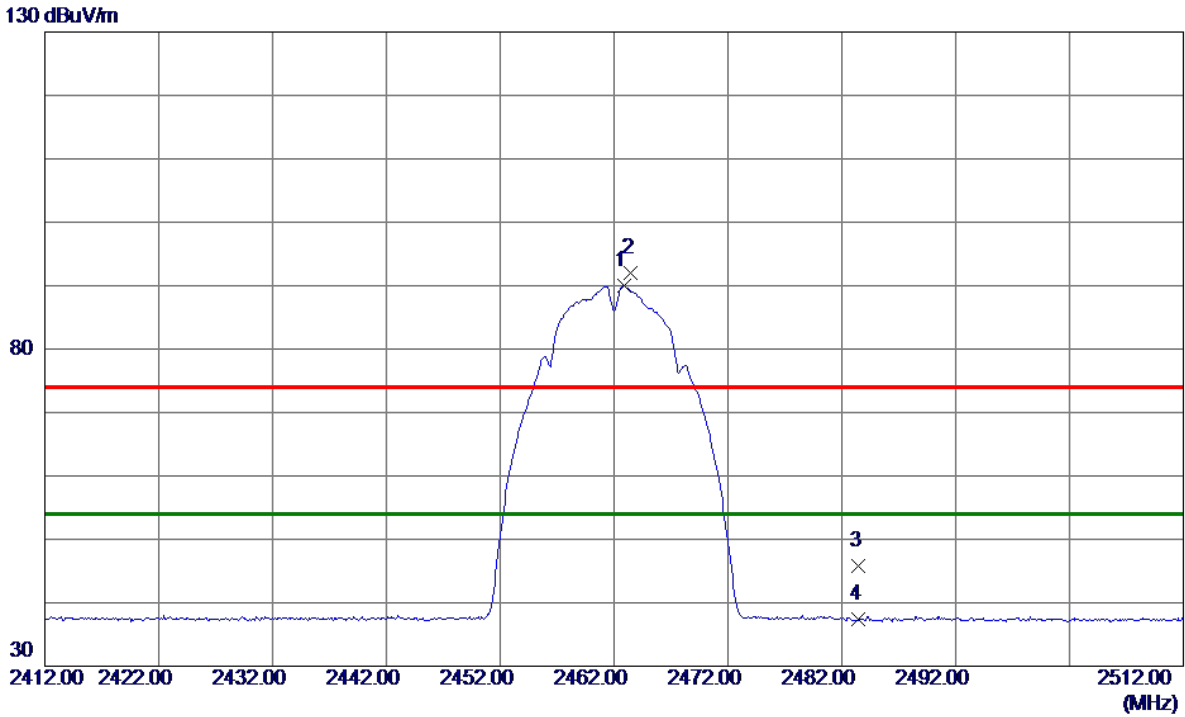

No.	Freq. MHz	Reading Level dBuV/m	Correct Factor dB	Measure ment dBuV/m	Limit dBuV/m	Margin dB	Detector	Comment
1 *	2462.9000	82.75	7.25	90.00	54.00	36.00	AVG	No Limit
2	2463.5000	84.71	7.25	91.96	74.00	17.96	Peak	No Limit
3	2483.5000	38.50	7.25	45.75	74.00	-28.25	Peak	
4	2483.5000	30.19	7.25	37.44	54.00	-16.56	AVG	

REMARKS:

- (1) Measurement Value = Reading Level + Correct Factor.
- (2) Margin Level = Measurement Value - Limit Value.

Test Mode	TX B Mode 2462 MHz	Polarization	Horizontal
-----------	--------------------	--------------	------------

80 dBuV/m

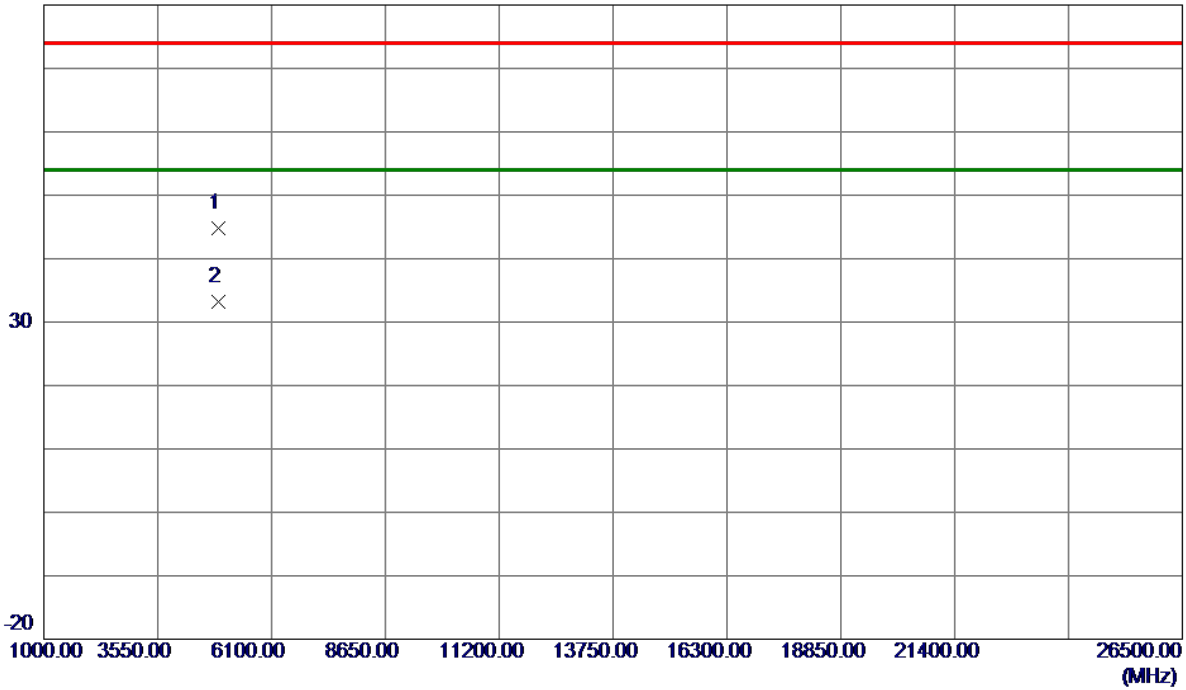

No.	Freq. MHz	Reading Level dBuV/m	Correct Factor dB	Measure ment dBuV/m	Limit dBuV/m	Margin dB	Detector	Comment
1	4923.4420	40.11	4.72	44.83	74.00	-29.17	Peak	
2 *	4924.1030	28.41	4.72	33.13	54.00	-20.87	AVG	

REMARKS:

- (1) Measurement Value = Reading Level + Correct Factor.
- (2) Margin Level = Measurement Value - Limit Value.

Test Mode	TX G Mode 2412 MHz	Polarization	Vertical
-----------	--------------------	--------------	----------

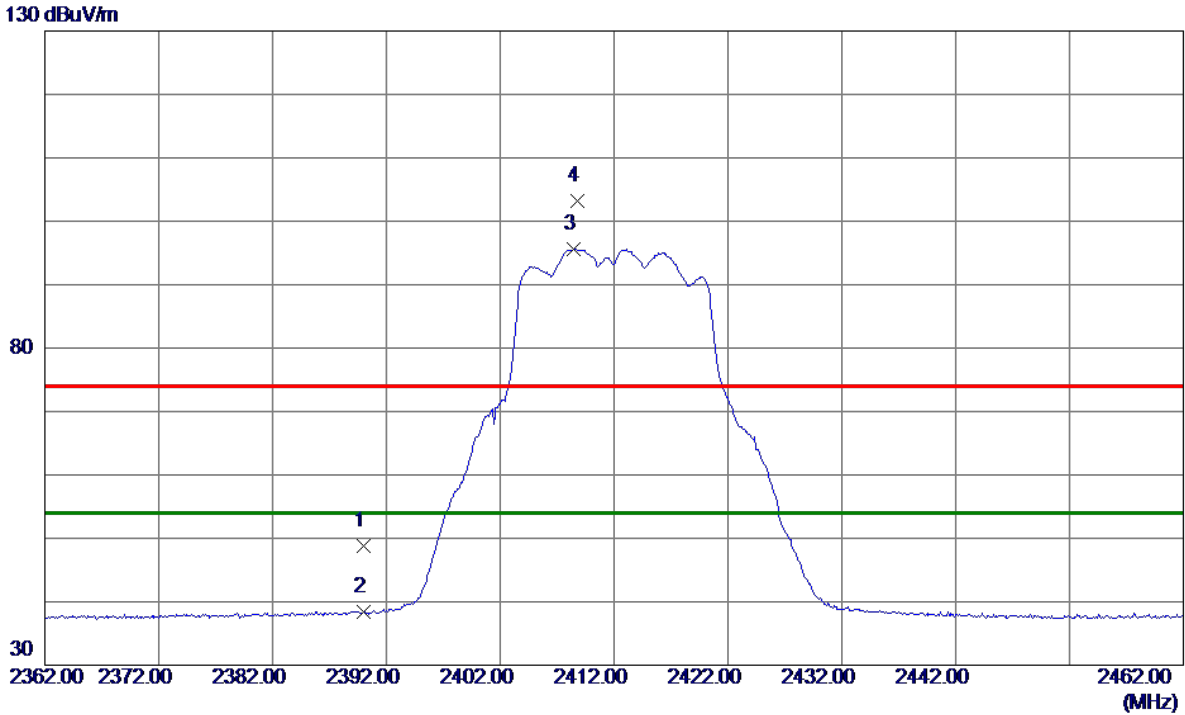

No.	Freq. MHz	Reading Level dBuV/m	Correct Factor dB	Measure ment dBuV/m	Limit dBuV/m	Margin dB	Detector	Comment
1	2390.0000	41.59	7.26	48.85	74.00	-25.15	Peak	
2	2390.0000	31.09	7.26	38.35	54.00	-15.65	AVG	
3 *	2408.4000	88.40	7.26	95.66	54.00	41.66	AVG	No Limit
4	2408.8000	95.92	7.26	103.18	74.00	29.18	Peak	No Limit

REMARKS:

- (1) Measurement Value = Reading Level + Correct Factor.
- (2) Margin Level = Measurement Value - Limit Value.

Test Mode	TX G Mode 2412 MHz	Polarization	Vertical
-----------	--------------------	--------------	----------

80 dBuV/m

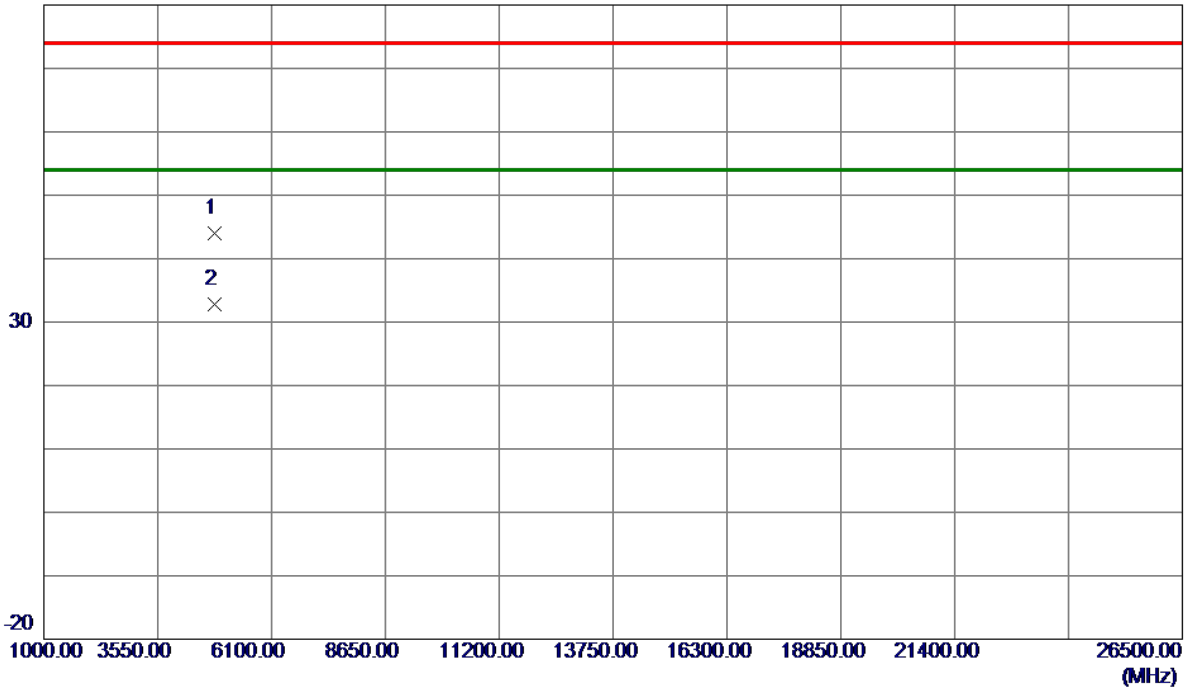

No.	Freq. MHz	Reading Level dBuV/m	Correct Factor dB	Measure ment dBuV/m	Limit dBuV/m	Margin dB	Detector	Comment
1	4824.3700	39.53	4.45	43.98	74.00	-30.02	Peak	
2 *	4824.7070	28.37	4.45	32.82	54.00	-21.18	AVG	

REMARKS:

- (1) Measurement Value = Reading Level + Correct Factor.
- (2) Margin Level = Measurement Value - Limit Value.

Test Mode	TX G Mode 2412 MHz	Polarization	Horizontal
-----------	--------------------	--------------	------------

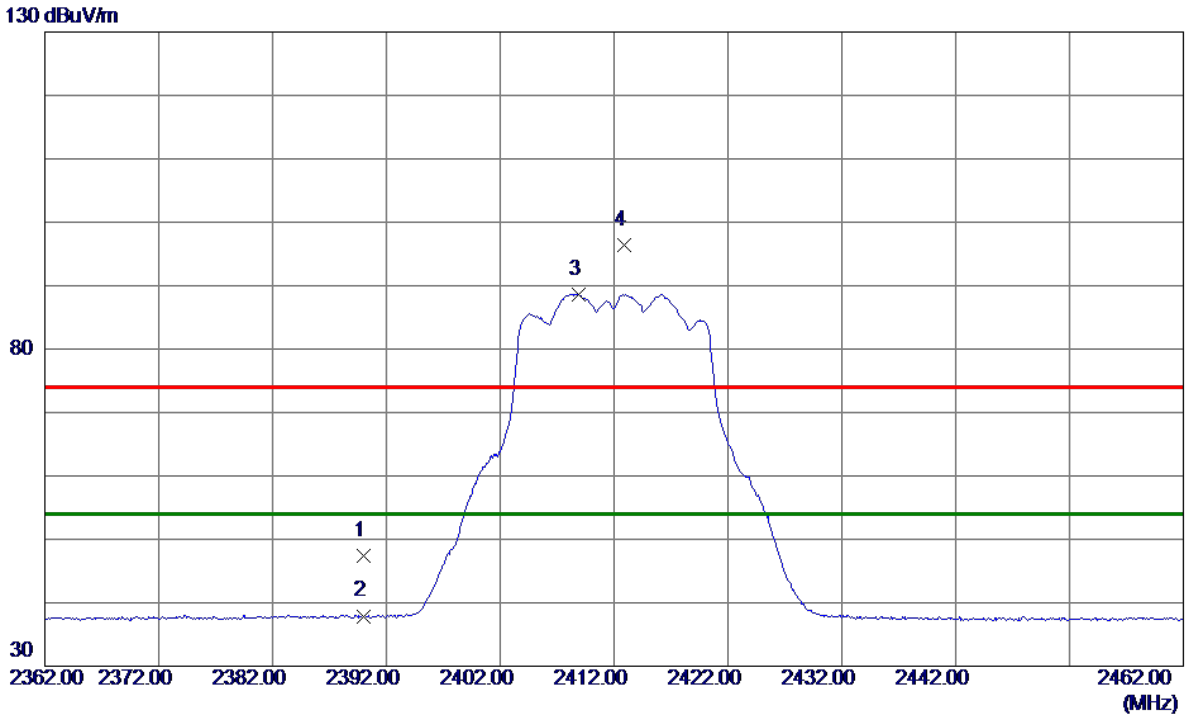

No.	Freq. MHz	Reading Level dBuV/m	Correct Factor dB	Measure ment dBuV/m	Limit dBuV/m	Margin dB	Detector	Comment
1	2390.0000	40.09	7.26	47.35	74.00	-26.65	Peak	
2	2390.0000	30.64	7.26	37.90	54.00	-16.10	AVG	
3 *	2408.9000	81.40	7.26	88.66	54.00	34.66	AVG	No Limit
4	2412.9000	89.11	7.26	96.37	74.00	22.37	Peak	No Limit

REMARKS:

- (1) Measurement Value = Reading Level + Correct Factor.
- (2) Margin Level = Measurement Value - Limit Value.

Test Mode	TX G Mode 2412 MHz	Polarization	Horizontal
-----------	--------------------	--------------	------------

80 dBuV/m

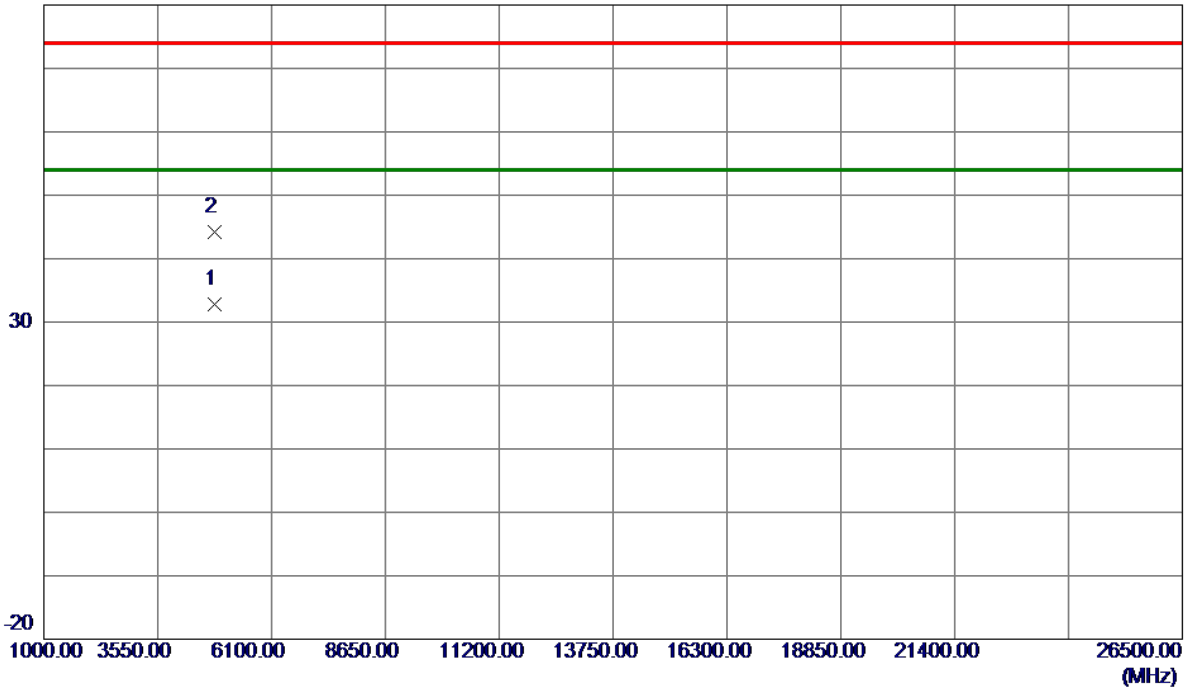

No.	Freq. MHz	Reading Level dBuV/m	Correct Factor dB	Measure ment dBuV/m	Limit dBuV/m	Margin dB	Detector	Comment
1 *	4823.8680	28.27	4.45	32.72	54.00	-21.28	AVG	
2	4824.3849	39.67	4.45	44.12	74.00	-29.88	Peak	

REMARKS:

- (1) Measurement Value = Reading Level + Correct Factor.
- (2) Margin Level = Measurement Value - Limit Value.

Test Mode	TX G Mode 2437 MHz	Polarization	Vertical
-----------	--------------------	--------------	----------

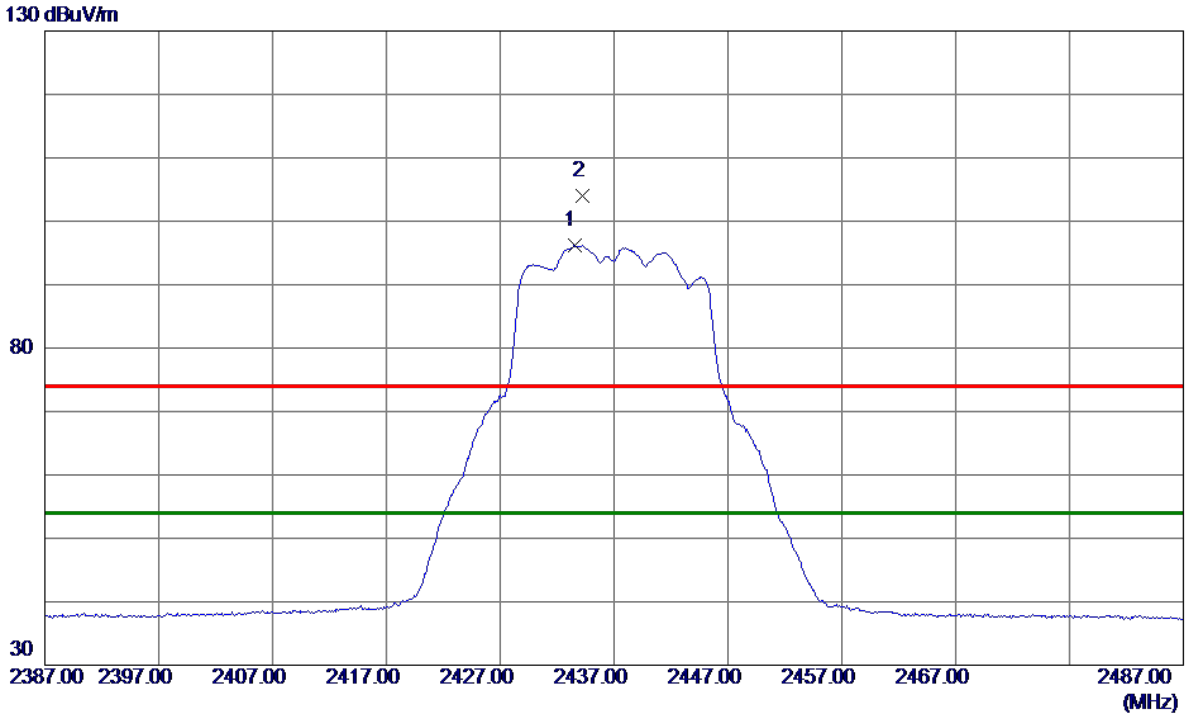

No.	Freq. MHz	Reading Level dBuV/m	Correct Factor dB	Measure ment dBuV/m	Limit dBuV/m	Margin dB	Detector	Comment
1 *	2433.5000	88.92	7.25	96.17	54.00	42.17	AVG	No Limit
2	2434.2000	96.78	7.25	104.03	74.00	30.03	Peak	No Limit

REMARKS:

- (1) Measurement Value = Reading Level + Correct Factor.
- (2) Margin Level = Measurement Value - Limit Value.

Test Mode	TX G Mode 2437 MHz	Polarization	Vertical
-----------	--------------------	--------------	----------

80 dBuV/m

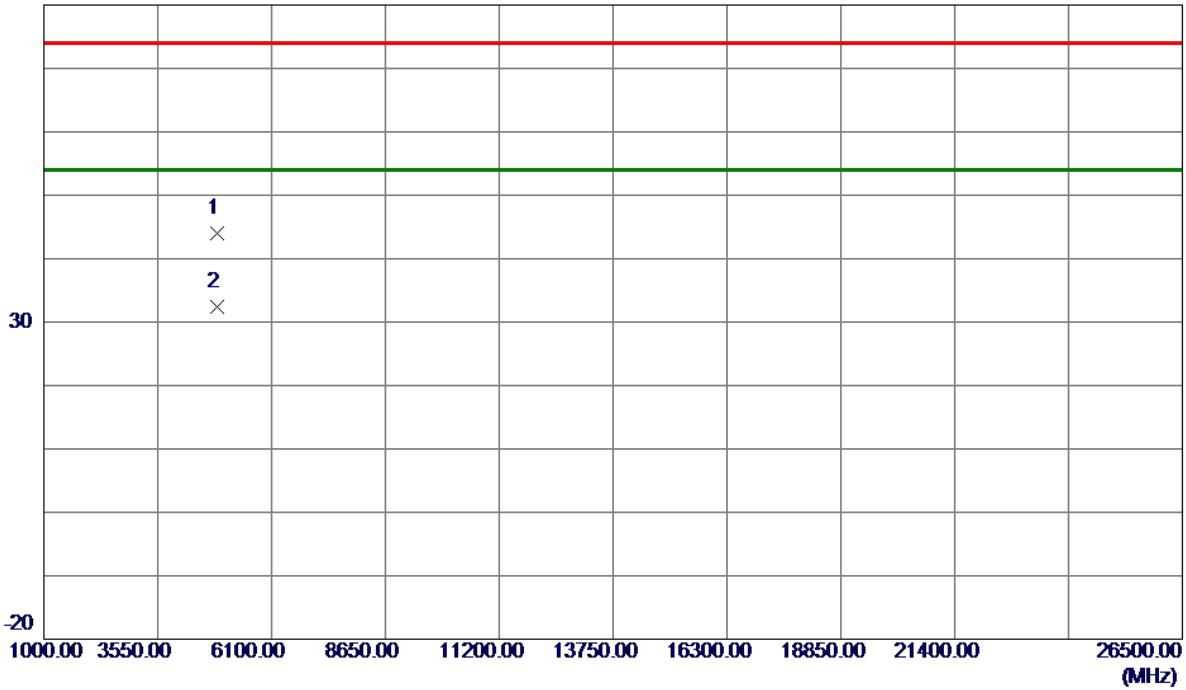

No.	Freq. MHz	Reading Level dBuV/m	Correct Factor dB	Measure ment dBuV/m	Limit dBuV/m	Margin dB	Detector	Comment
1	4874.1260	39.45	4.58	44.03	74.00	-29.97	Peak	
2 *	4874.1320	27.85	4.58	32.43	54.00	-21.57	AVG	

REMARKS:

- (1) Measurement Value = Reading Level + Correct Factor.
- (2) Margin Level = Measurement Value - Limit Value.

Test Mode	TX G Mode 2437 MHz	Polarization	Horizontal
-----------	--------------------	--------------	------------

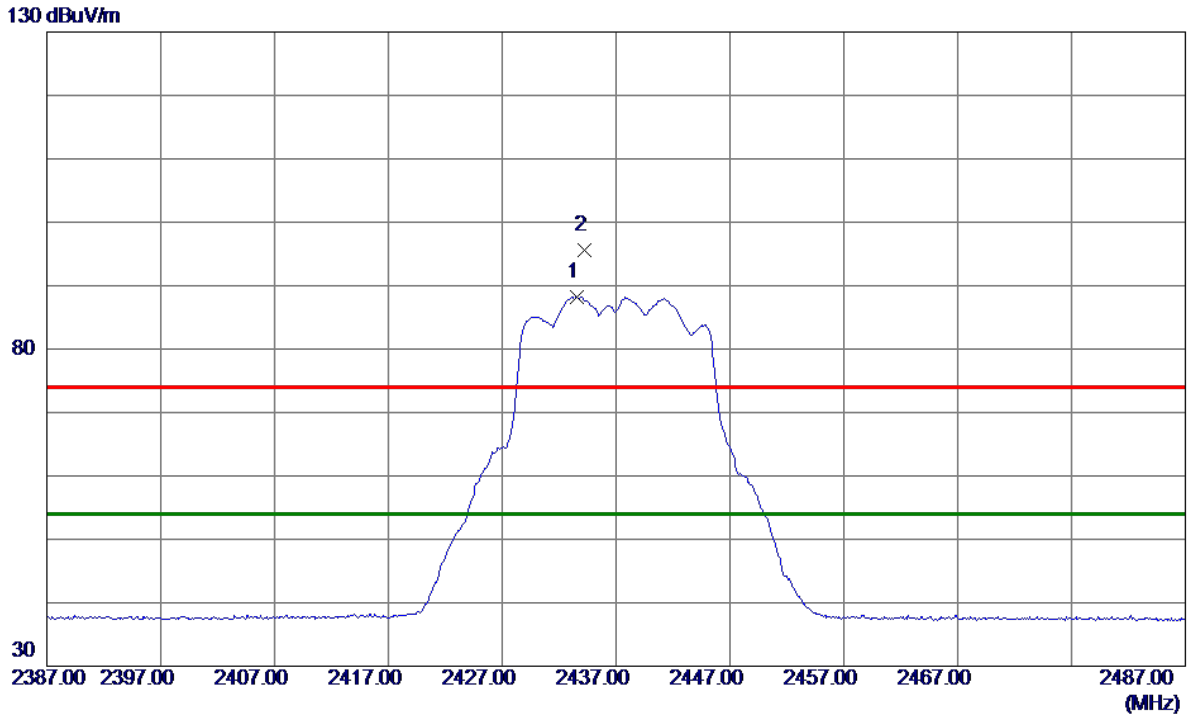

No.	Freq. MHz	Reading Level dBuV/m	Correct Factor dB	Measure ment dBuV/m	Limit dBuV/m	Margin dB	Detector	Comment
1 *	2433.6000	80.96	7.25	88.21	54.00	34.21	AVG	No Limit
2	2434.2000	88.31	7.25	95.56	74.00	21.56	Peak	No Limit

REMARKS:

- (1) Measurement Value = Reading Level + Correct Factor.
- (2) Margin Level = Measurement Value - Limit Value.

Test Mode	TX G Mode 2437 MHz	Polarization	Horizontal
-----------	--------------------	--------------	------------

80 dBuV/m

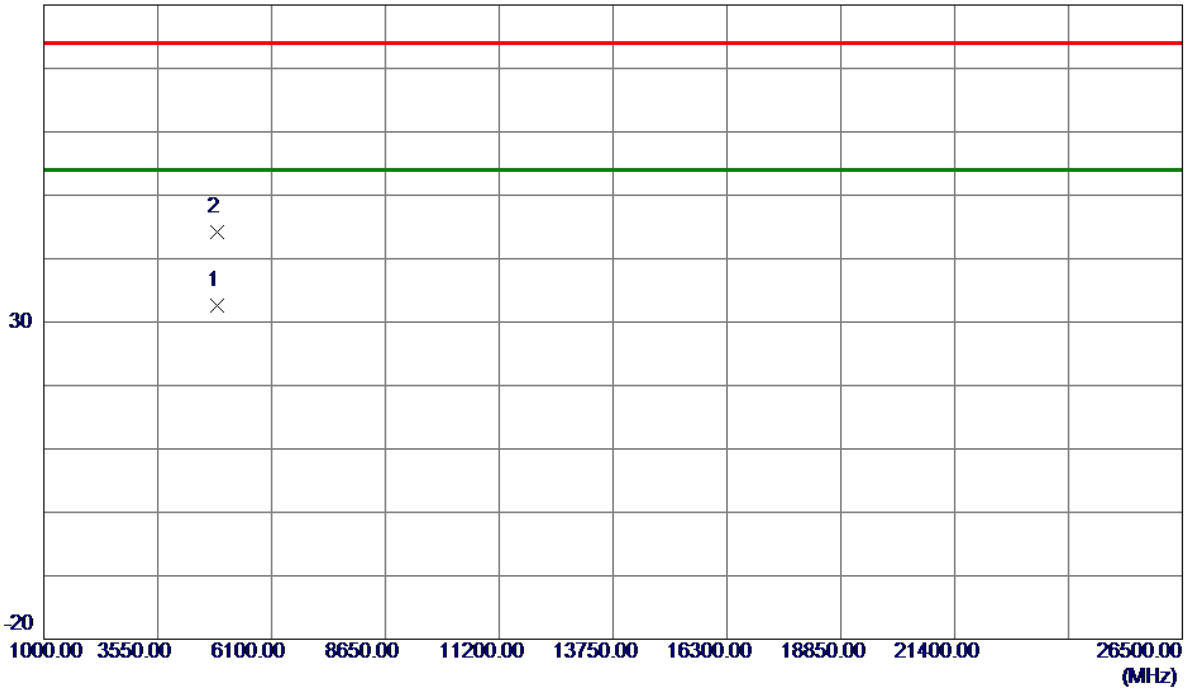

No.	Freq. MHz	Reading Level dBuV/m	Correct Factor dB	Measure ment dBuV/m	Limit dBuV/m	Margin dB	Detector	Comment
1 *	4873.1840	27.93	4.58	32.51	54.00	-21.49	AVG	
2	4873.7430	39.65	4.58	44.23	74.00	-29.77	Peak	

REMARKS:

- (1) Measurement Value = Reading Level + Correct Factor.
- (2) Margin Level = Measurement Value - Limit Value.

Test Mode	TX G Mode 2462 MHz	Polarization	Vertical
-----------	--------------------	--------------	----------

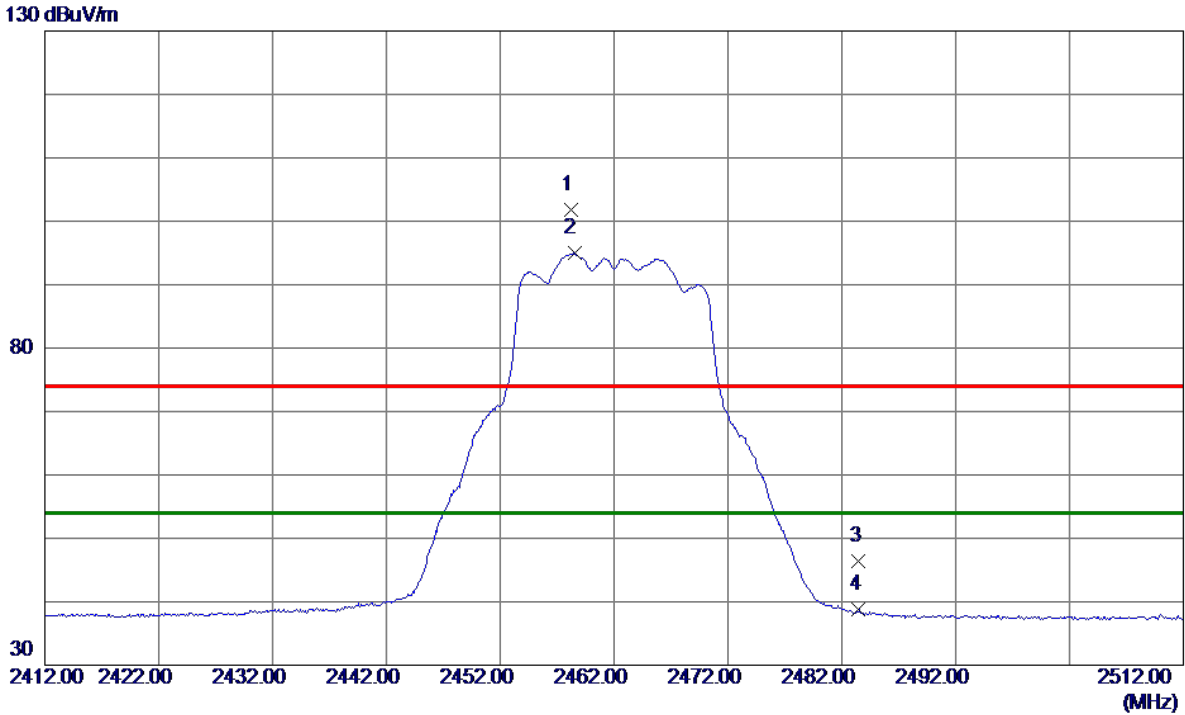

No.	Freq. MHz	Reading Level dBuV/m	Correct Factor dB	Measure ment dBuV/m	Limit dBuV/m	Margin dB	Detector	Comment
1	2458.2000	94.61	7.25	101.86	74.00	27.86	Peak	No Limit
2 *	2458.5000	87.70	7.25	94.95	54.00	40.95	AVG	No Limit
3	2483.5000	39.13	7.25	46.38	74.00	-27.62	Peak	
4	2483.5000	31.59	7.25	38.84	54.00	-15.16	AVG	

REMARKS:

- (1) Measurement Value = Reading Level + Correct Factor.
- (2) Margin Level = Measurement Value - Limit Value.

Test Mode	TX G Mode 2462 MHz	Polarization	Vertical
-----------	--------------------	--------------	----------

80 dBuV/m

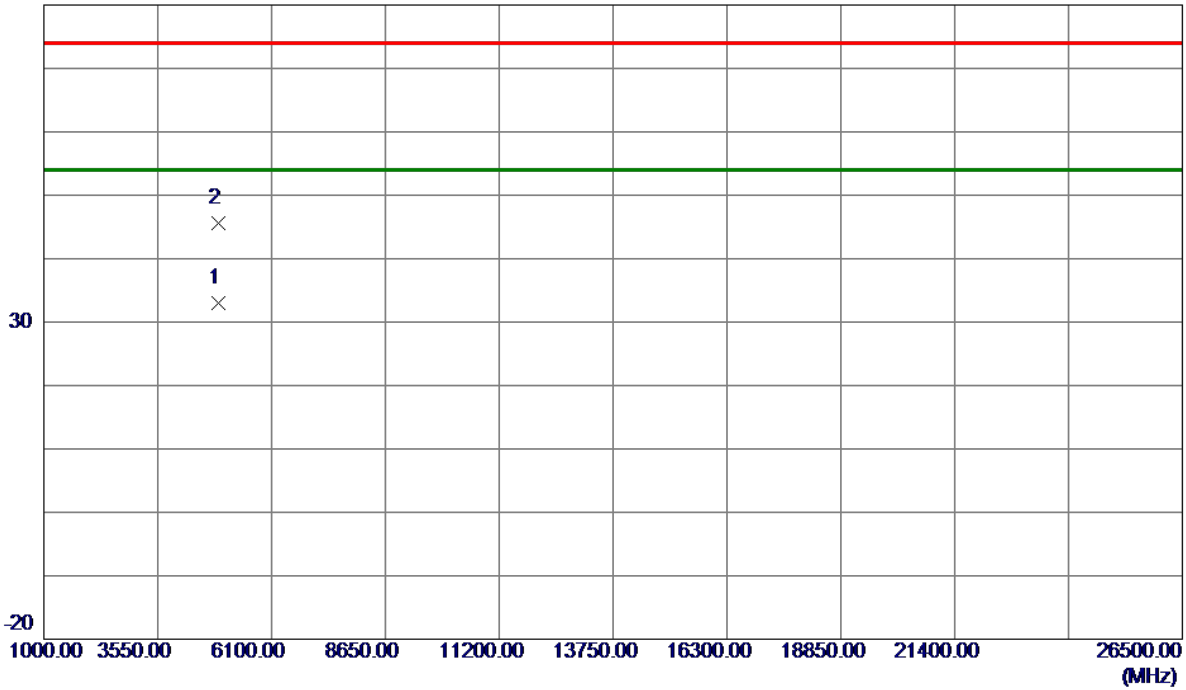

No.	Freq. MHz	Reading Level dBuV/m	Correct Factor dB	Measure ment dBuV/m	Limit dBuV/m	Margin dB	Detector	Comment
1 *	4923.4760	28.36	4.72	33.08	54.00	-20.92	AVG	
2	4923.4790	40.80	4.72	45.52	74.00	-28.48	Peak	

REMARKS:

- (1) Measurement Value = Reading Level + Correct Factor.
- (2) Margin Level = Measurement Value - Limit Value.

Test Mode	TX G Mode 2462 MHz	Polarization	Horizontal
-----------	--------------------	--------------	------------

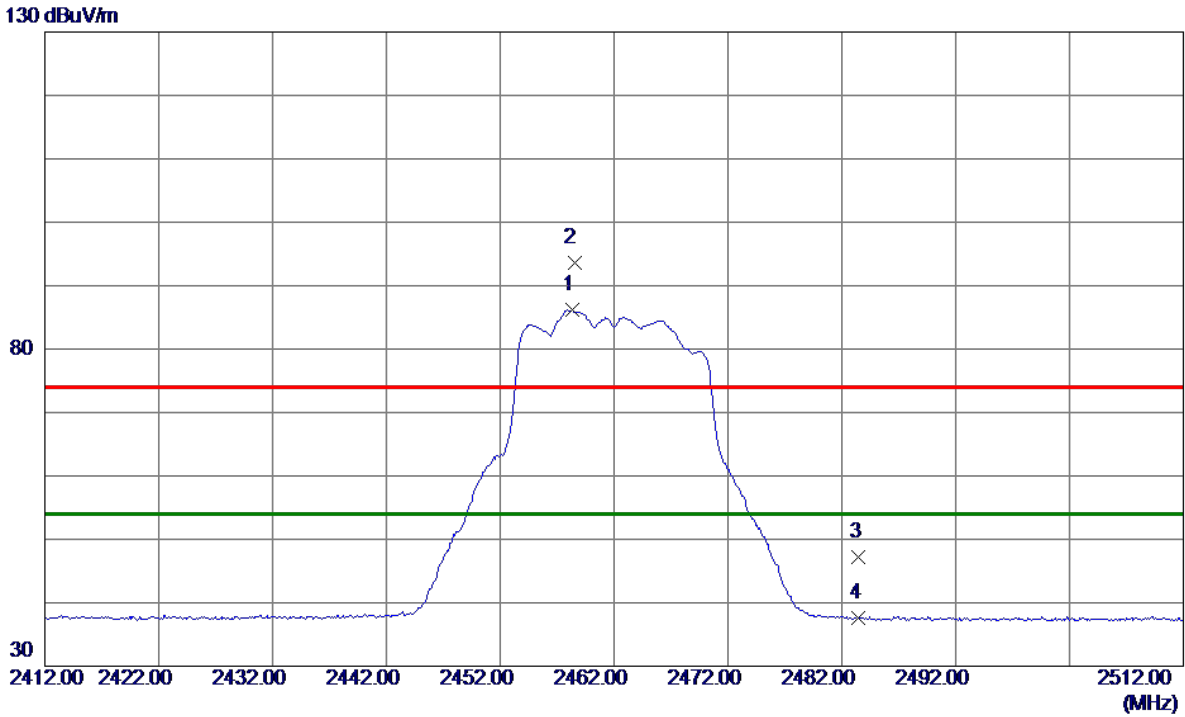

No.	Freq. MHz	Reading Level dBuV/m	Correct Factor dB	Measure ment dBuV/m	Limit dBuV/m	Margin dB	Detector	Comment
1 *	2458.3000	78.90	7.25	86.15	54.00	32.15	AVG	No Limit
2	2458.5000	86.31	7.25	93.56	74.00	19.56	Peak	No Limit
3	2483.5000	39.86	7.25	47.11	74.00	-26.89	Peak	
4	2483.5000	30.36	7.25	37.61	54.00	-16.39	AVG	

REMARKS:

- (1) Measurement Value = Reading Level + Correct Factor.
- (2) Margin Level = Measurement Value - Limit Value.

Test Mode	TX G Mode 2462 MHz	Polarization	Horizontal
-----------	--------------------	--------------	------------

80 dBuV/m

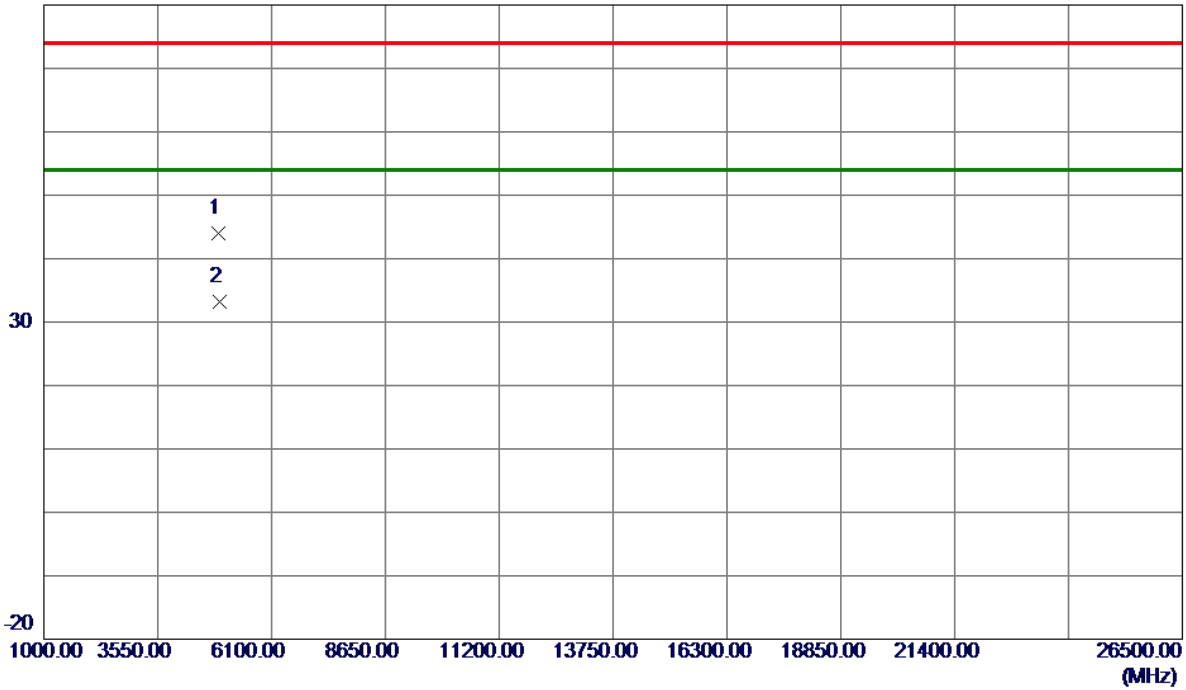

No.	Freq. MHz	Reading Level dBuV/m	Correct Factor dB	Measure ment dBuV/m	Limit dBuV/m	Margin dB	Detector	Comment
1	4923.1400	39.38	4.71	44.09	74.00	-29.91	Peak	
2 *	4924.5019	28.40	4.72	33.12	54.00	-20.88	AVG	

REMARKS:

- (1) Measurement Value = Reading Level + Correct Factor.
- (2) Margin Level = Measurement Value - Limit Value.

Test Mode	TX N(HT20) Mode 2412 MHz	Polarization	Vertical
-----------	--------------------------	--------------	----------

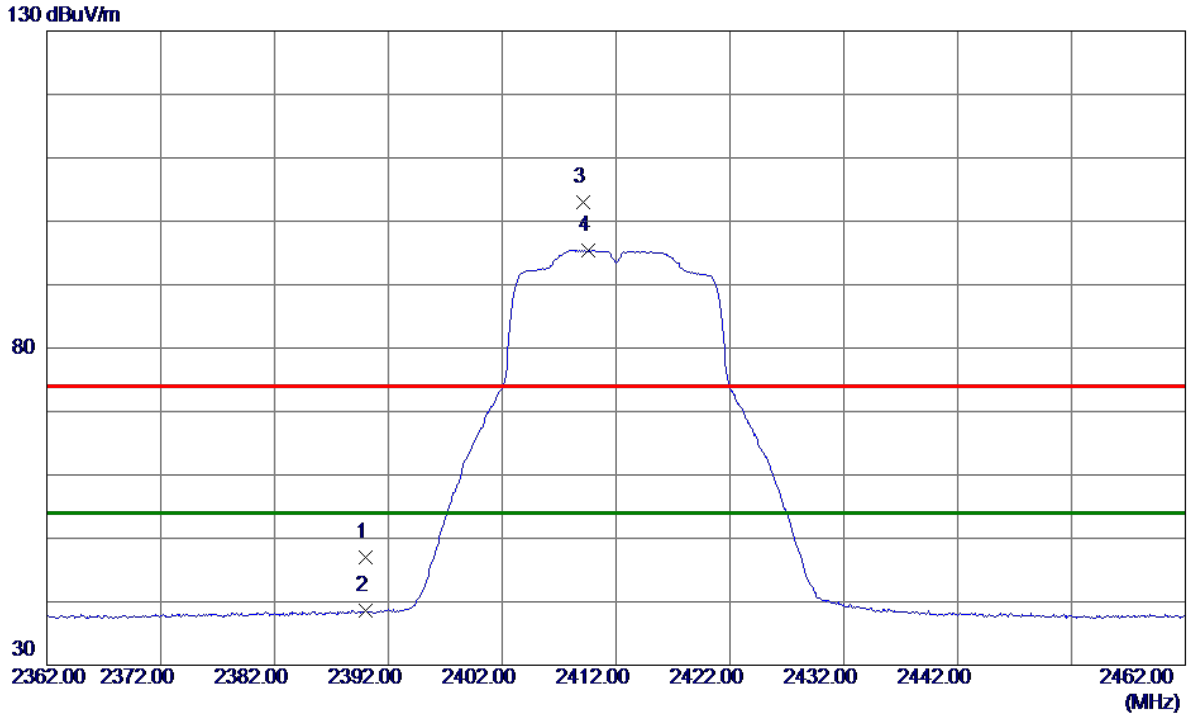

No.	Freq. MHz	Reading Level dBuV/m	Correct Factor dB	Measure ment dBuV/m	Limit dBuV/m	Margin dB	Detector	Comment
1	2390.0000	39.77	7.26	47.03	74.00	-26.97	Peak	
2	2390.0000	31.28	7.26	38.54	54.00	-15.46	AVG	
3	2409.1000	95.80	7.26	103.06	74.00	29.06	Peak	No Limit
4 *	2409.6000	88.11	7.26	95.37	54.00	41.37	AVG	No Limit

REMARKS:

- (1) Measurement Value = Reading Level + Correct Factor.
- (2) Margin Level = Measurement Value - Limit Value.

Test Mode	TX N(HT20) Mode 2412 MHz	Polarization	Vertical
-----------	--------------------------	--------------	----------

80 dBuV/m

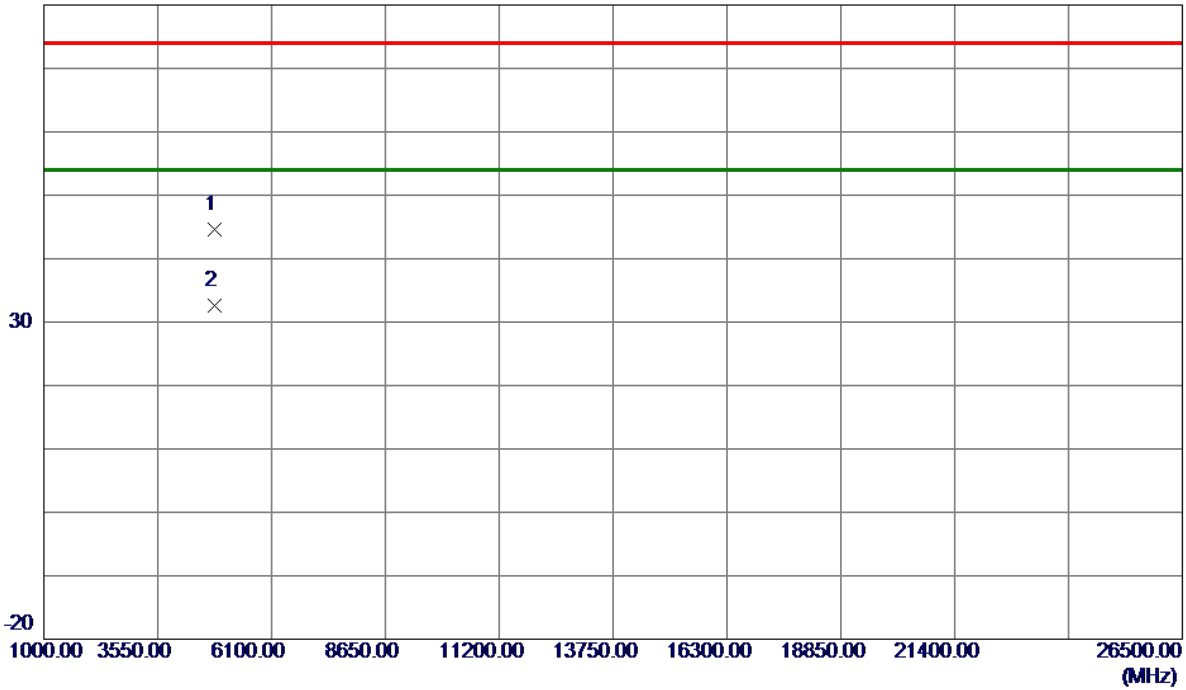

No.	Freq. MHz	Reading Level dBuV/m	Correct Factor dB	Measure ment dBuV/m	Limit dBuV/m	Margin dB	Detector	Comment
1	4823.1250	40.13	4.45	44.58	74.00	-29.42	Peak	
2 *	4824.6000	28.24	4.45	32.69	54.00	-21.31	AVG	

REMARKS:

- (1) Measurement Value = Reading Level + Correct Factor.
- (2) Margin Level = Measurement Value - Limit Value.

Test Mode	TX N(HT20) Mode 2412 MHz	Polarization	Horizontal
-----------	--------------------------	--------------	------------

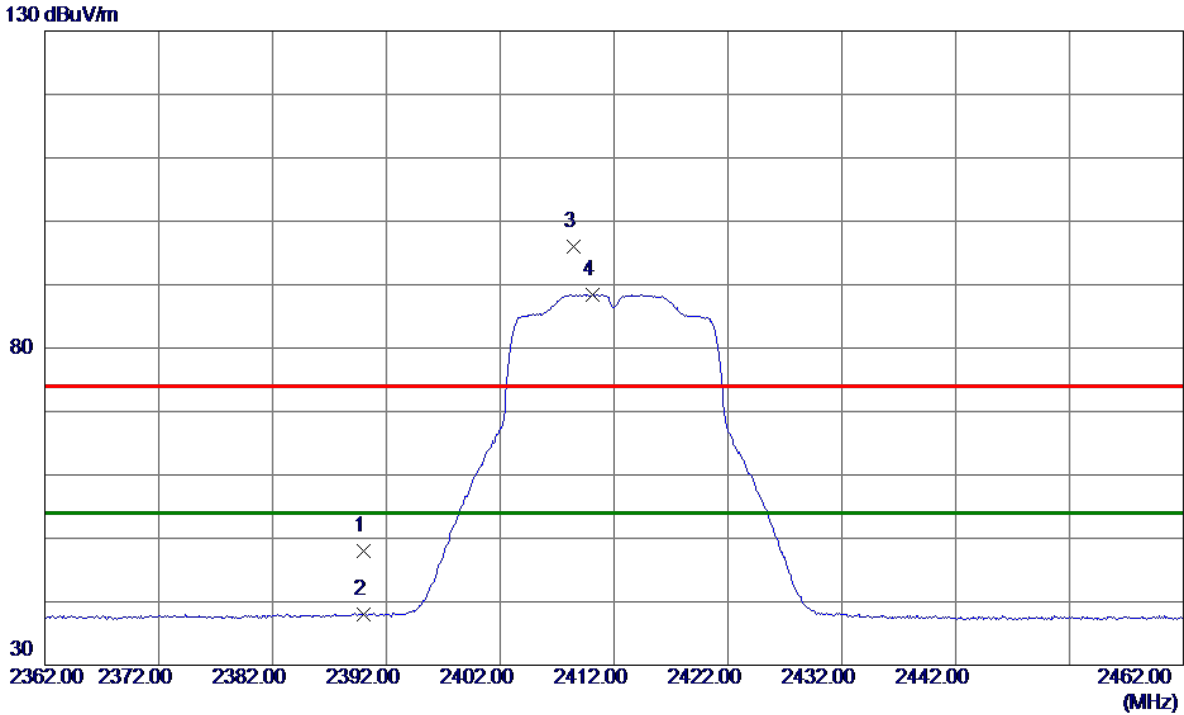

No.	Freq. MHz	Reading Level dBuV/m	Correct Factor dB	Measure ment dBuV/m	Limit dBuV/m	Margin dB	Detector	Comment
1	2390.0000	40.74	7.26	48.00	74.00	-26.00	Peak	
2	2390.0000	30.79	7.26	38.05	54.00	-15.95	AVG	
3	2408.4000	88.78	7.26	96.04	74.00	22.04	Peak	No Limit
4 *	2410.1000	81.15	7.26	88.41	54.00	34.41	AVG	No Limit

REMARKS:

- (1) Measurement Value = Reading Level + Correct Factor.
- (2) Margin Level = Measurement Value - Limit Value.

Test Mode	TX N(HT20) Mode 2412 MHz	Polarization	Horizontal
-----------	--------------------------	--------------	------------

80 dBuV/m

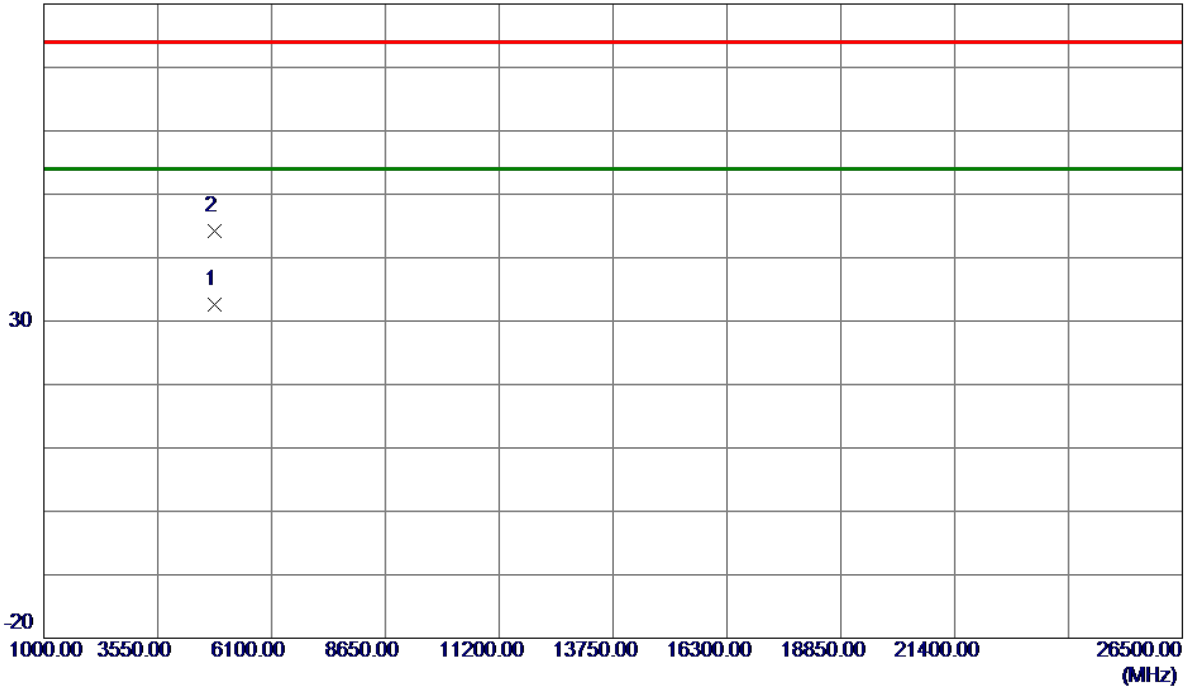

No.	Freq. MHz	Reading Level dBuV/m	Correct Factor dB	Measure ment dBuV/m	Limit dBuV/m	Margin dB	Detector	Comment
1 *	4823.7000	28.24	4.45	32.69	54.00	-21.31	AVG	
2	4824.9129	39.75	4.45	44.20	74.00	-29.80	Peak	

REMARKS:

- (1) Measurement Value = Reading Level + Correct Factor.
- (2) Margin Level = Measurement Value - Limit Value.

Test Mode	TX N(HT20) Mode 2437 MHz	Polarization	Vertical
-----------	--------------------------	--------------	----------

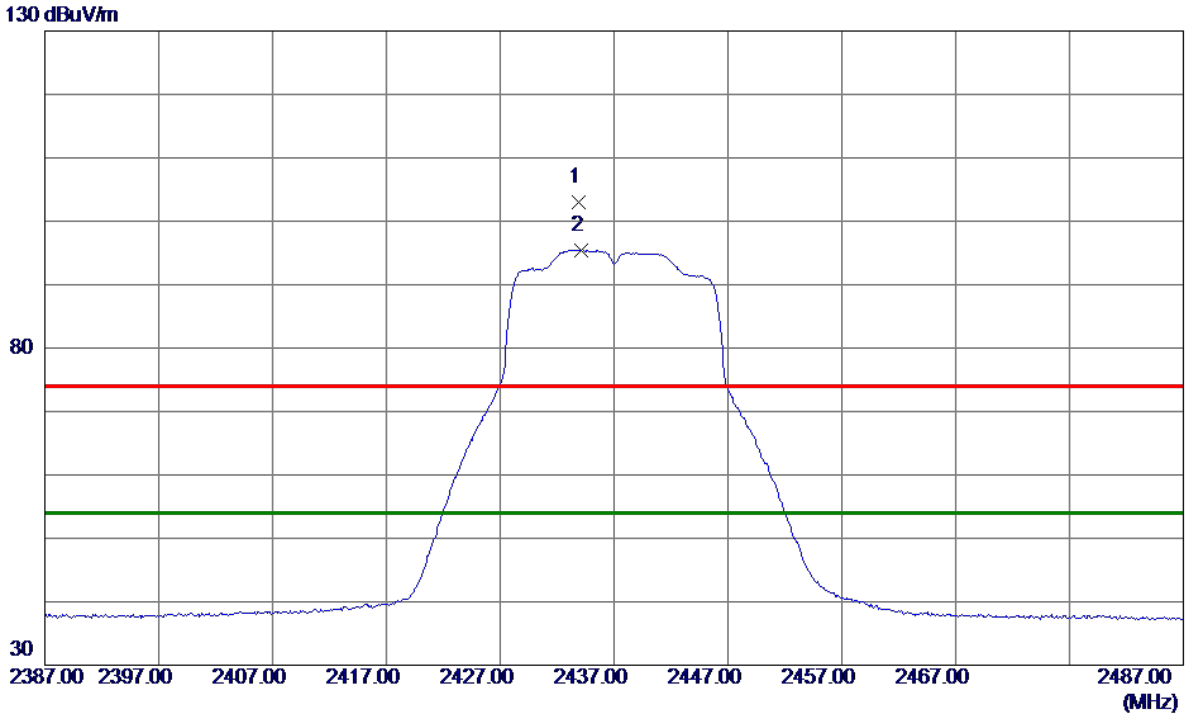

No.	Freq. MHz	Reading Level dBuV/m	Correct Factor dB	Measure ment dBuV/m	Limit dBuV/m	Margin dB	Detector	Comment
1	2433.9000	95.79	7.25	103.04	74.00	29.04	Peak	No Limit
2 *	2434.1000	88.24	7.25	95.49	54.00	41.49	AVG	No Limit

REMARKS:

- (1) Measurement Value = Reading Level + Correct Factor.
- (2) Margin Level = Measurement Value - Limit Value.

Test Mode	TX N(HT20) Mode 2437 MHz	Polarization	Vertical
-----------	--------------------------	--------------	----------

80 dBuV/m

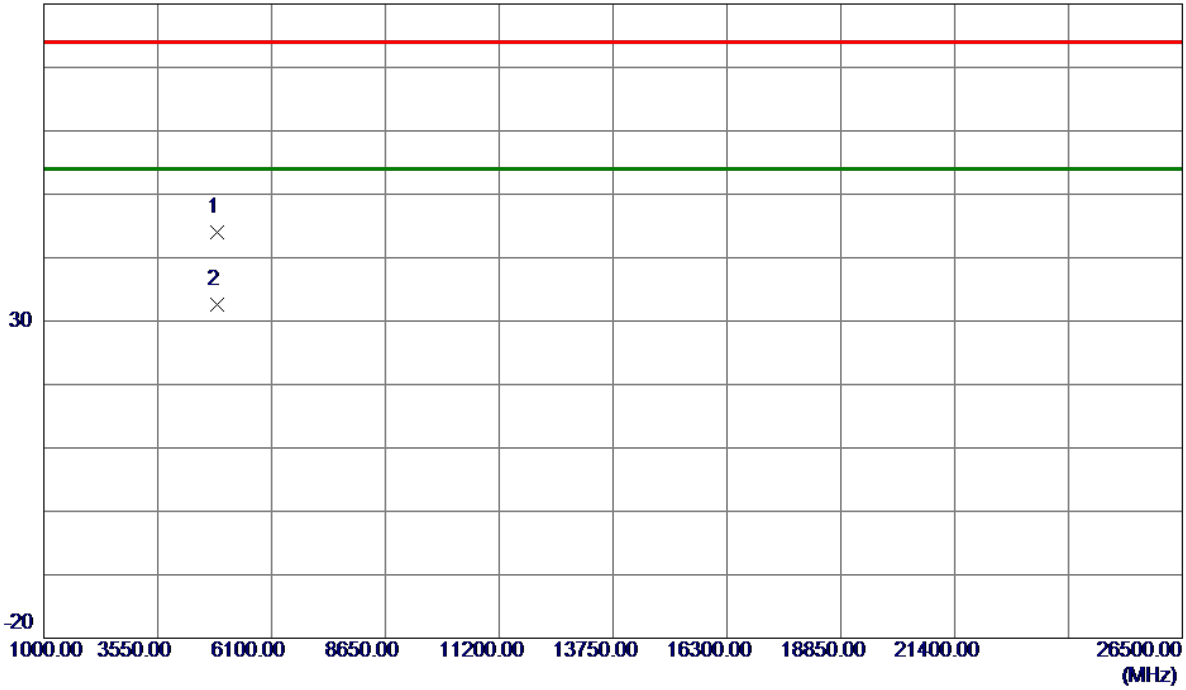

No.	Freq. MHz	Reading Level dBuV/m	Correct Factor dB	Measure ment dBuV/m	Limit dBuV/m	Margin dB	Detector	Comment
1	4873.2370	39.48	4.58	44.06	74.00	-29.94	Peak	
2 *	4874.2060	27.96	4.58	32.54	54.00	-21.46	AVG	

REMARKS:

- (1) Measurement Value = Reading Level + Correct Factor.
- (2) Margin Level = Measurement Value - Limit Value.

Test Mode	TX N(HT20) Mode 2437 MHz	Polarization	Horizontal
-----------	--------------------------	--------------	------------

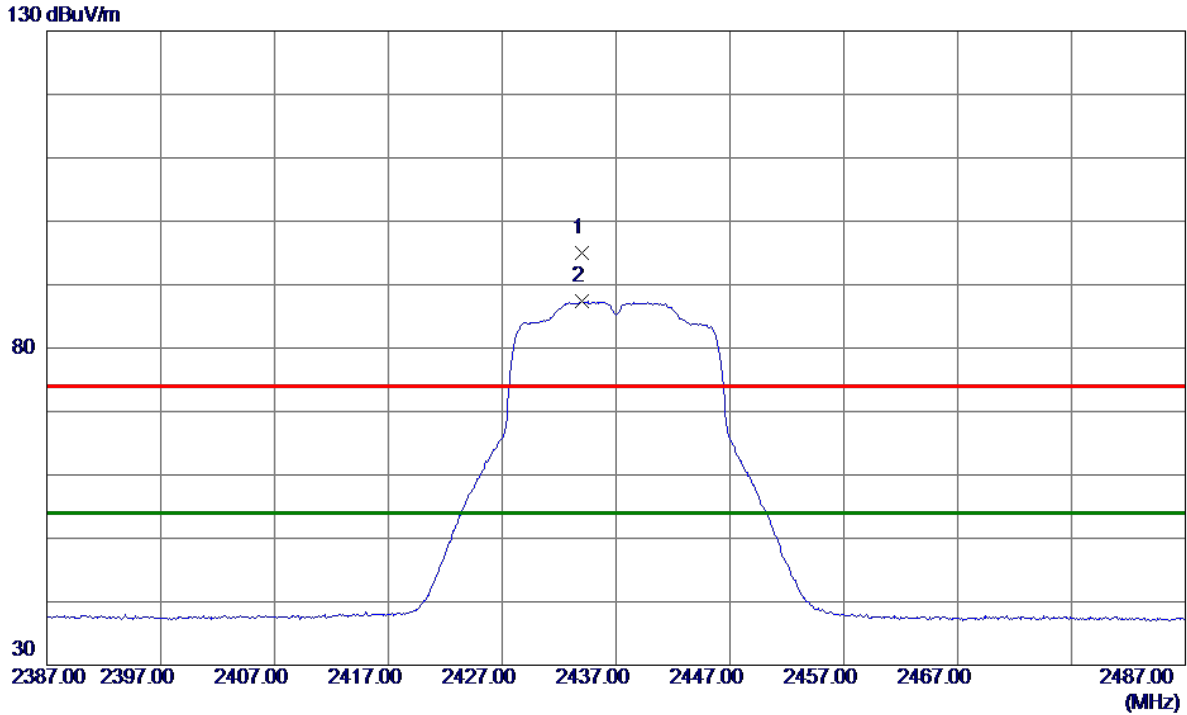

No.	Freq. MHz	Reading Level dBuV/m	Correct Factor dB	Measure ment dBuV/m	Limit dBuV/m	Margin dB	Detector	Comment
1	2434.0000	87.71	7.25	94.96	74.00	20.96	Peak	No Limit
2 *	2434.0000	80.09	7.25	87.34	54.00	33.34	AVG	No Limit

REMARKS:

- (1) Measurement Value = Reading Level + Correct Factor.
- (2) Margin Level = Measurement Value - Limit Value.

Test Mode	TX N(HT20) Mode 2437 MHz	Polarization	Horizontal
-----------	--------------------------	--------------	------------

80 dBuV/m

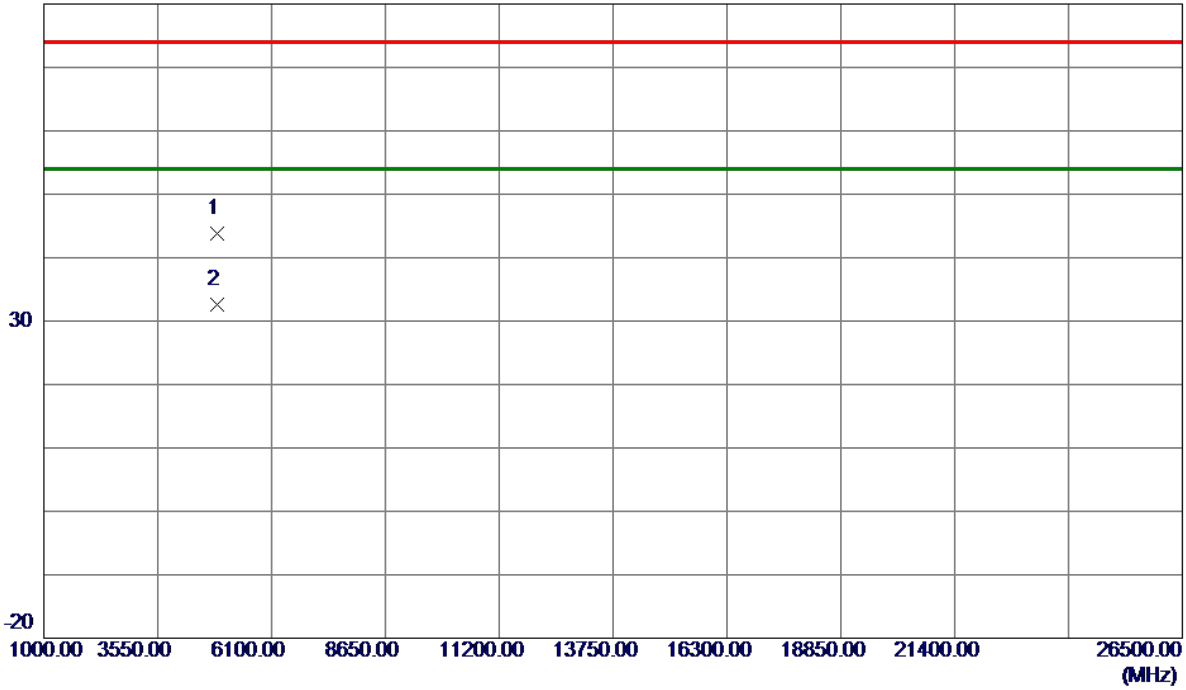

No.	Freq. MHz	Reading Level dBuV/m	Correct Factor dB	Measure ment dBuV/m	Limit dBuV/m	Margin dB	Detector	Comment
1	4873.8310	39.17	4.58	43.75	74.00	-30.25	Peak	
2 *	4874.8950	27.98	4.59	32.57	54.00	-21.43	AVG	

REMARKS:

- (1) Measurement Value = Reading Level + Correct Factor.
- (2) Margin Level = Measurement Value - Limit Value.

Test Mode	TX N(HT20) Mode 2462 MHz	Polarization	Vertical
-----------	--------------------------	--------------	----------

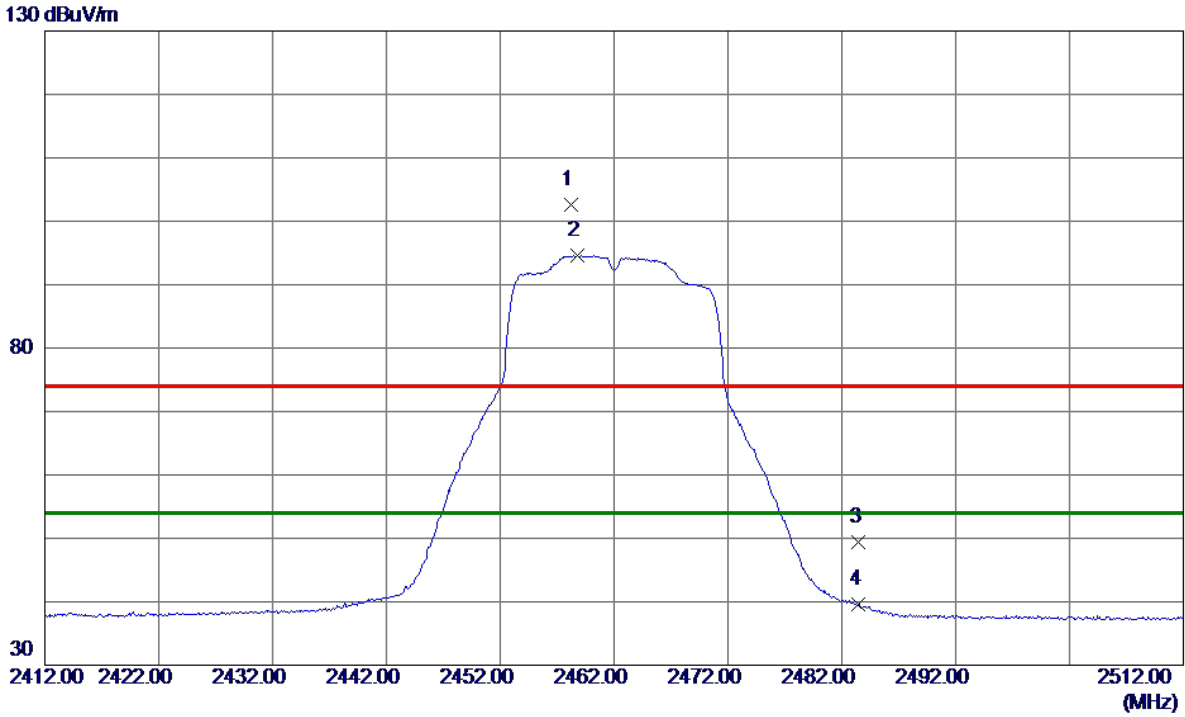

No.	Freq. MHz	Reading Level dBuV/m	Correct Factor dB	Measure ment dBuV/m	Limit dBuV/m	Margin dB	Detector	Comment
1	2458.2000	95.43	7.25	102.68	74.00	28.68	Peak	No Limit
2 *	2458.8000	87.33	7.25	94.58	54.00	40.58	AVG	No Limit
3	2483.5000	42.08	7.25	49.33	74.00	-24.67	Peak	
4	2483.5000	32.30	7.25	39.55	54.00	-14.45	AVG	

REMARKS:

- (1) Measurement Value = Reading Level + Correct Factor.
- (2) Margin Level = Measurement Value - Limit Value.

Test Mode	TX N(HT20) Mode 2462 MHz	Polarization	Vertical
-----------	--------------------------	--------------	----------

80 dBuV/m

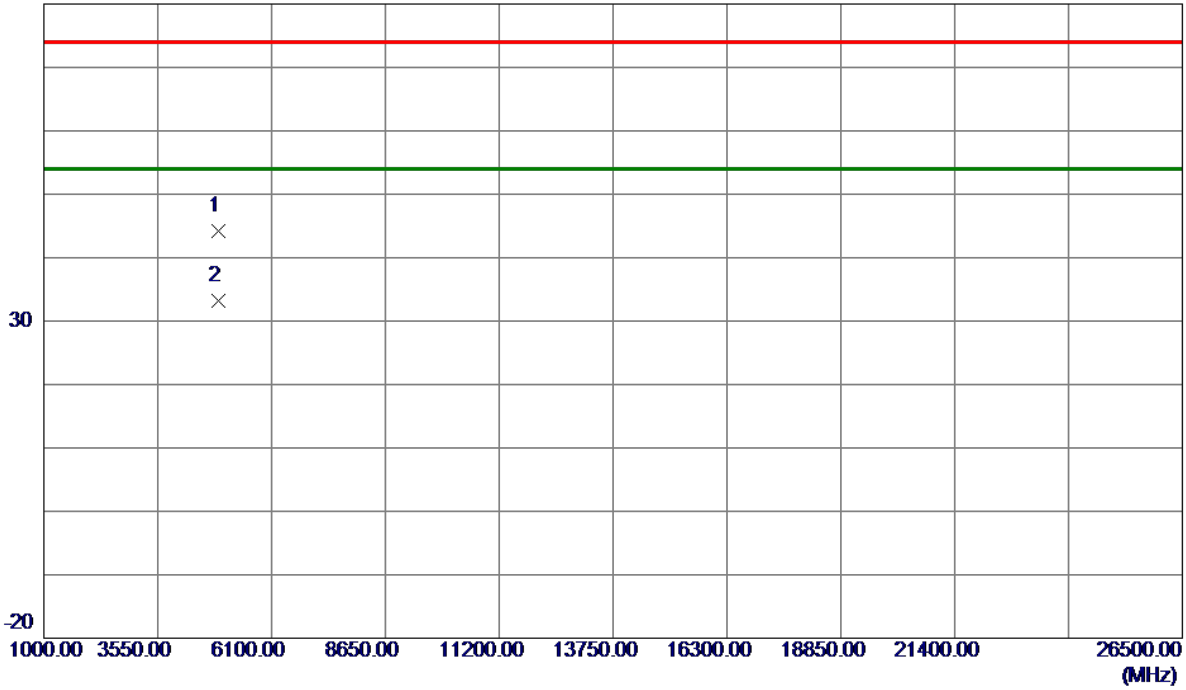

No.	Freq. MHz	Reading Level dBuV/m	Correct Factor dB	Measure ment dBuV/m	Limit dBuV/m	Margin dB	Detector	Comment
1	4923.6130	39.57	4.72	44.29	74.00	-29.71	Peak	
2 *	4923.9270	28.52	4.72	33.24	54.00	-20.76	AVG	

REMARKS:

- (1) Measurement Value = Reading Level + Correct Factor.
- (2) Margin Level = Measurement Value - Limit Value.

Test Mode	TX N(HT20) Mode 2462 MHz	Polarization	Horizontal
-----------	--------------------------	--------------	------------

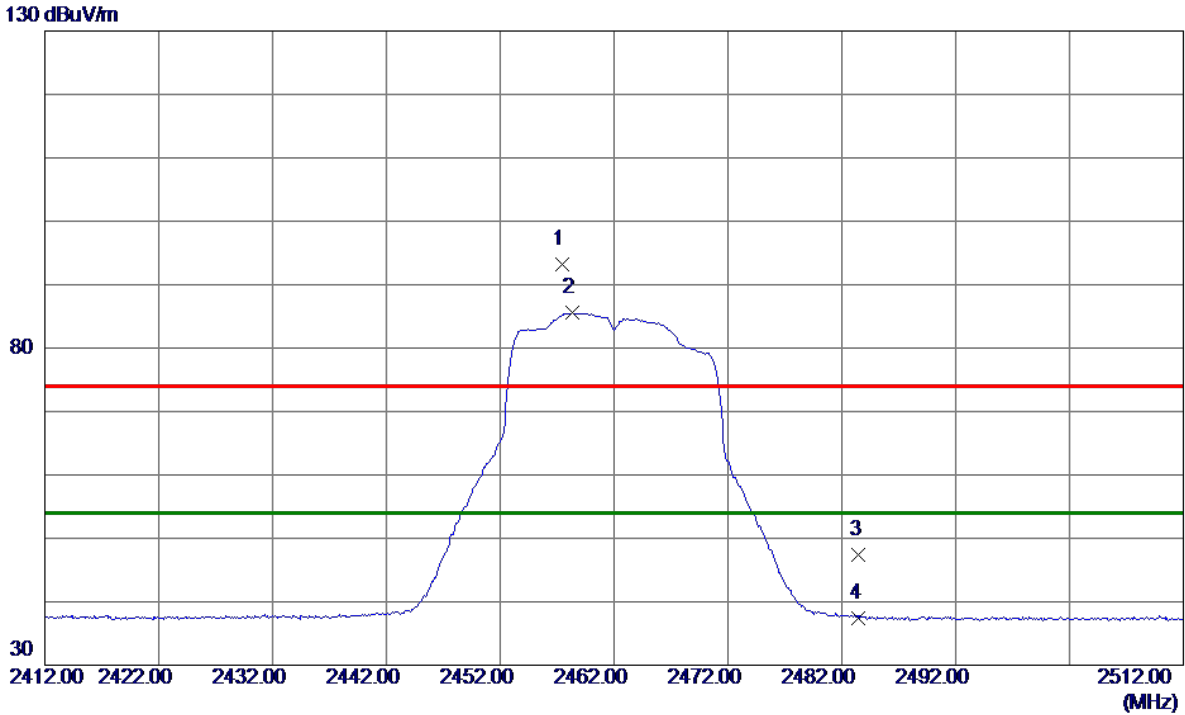

No.	Freq. MHz	Reading Level dBuV/m	Correct Factor dB	Measure ment dBuV/m	Limit dBuV/m	Margin dB	Detector	Comment
1	2457.4000	85.91	7.25	93.16	74.00	19.16	Peak	No Limit
2 *	2458.3000	78.31	7.25	85.56	54.00	31.56	AVG	No Limit
3	2483.5000	40.15	7.25	47.40	74.00	-26.60	Peak	
4	2483.5000	30.22	7.25	37.47	54.00	-16.53	AVG	

REMARKS:

- (1) Measurement Value = Reading Level + Correct Factor.
- (2) Margin Level = Measurement Value - Limit Value.

Test Mode	TX N(HT20) Mode 2462 MHz	Polarization	Horizontal
-----------	--------------------------	--------------	------------

80 dBuV/m

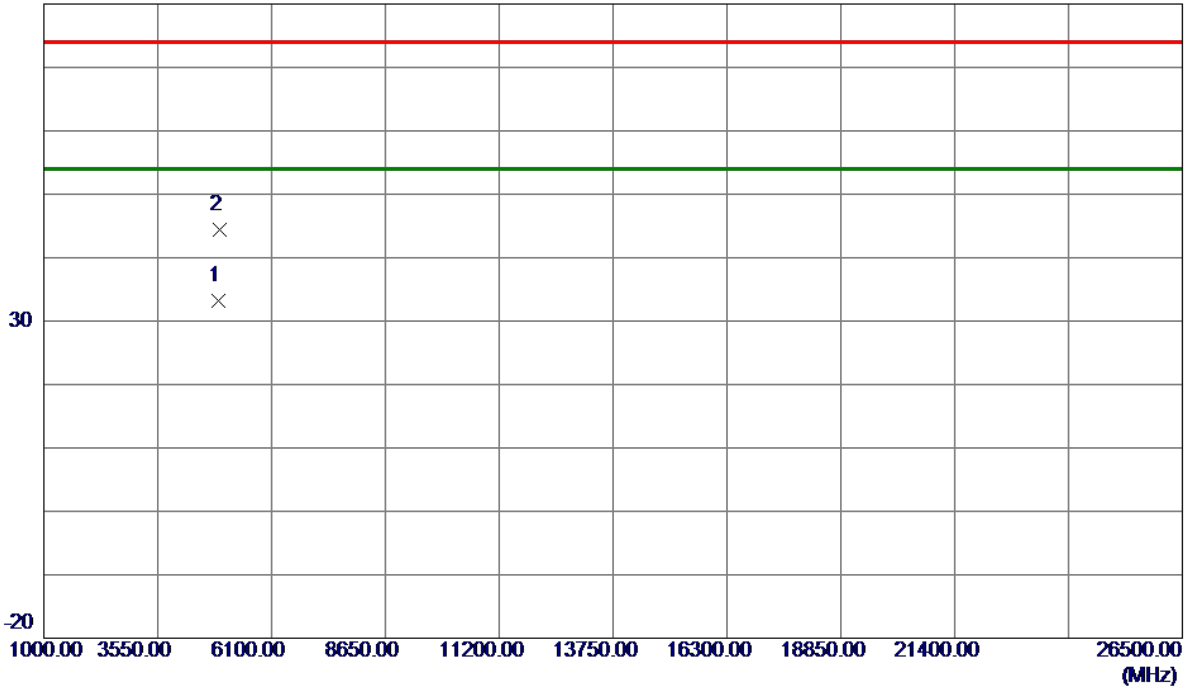

No.	Freq. MHz	Reading Level dBuV/m	Correct Factor dB	Measure ment dBuV/m	Limit dBuV/m	Margin dB	Detector	Comment
1 *	4924.0830	28.45	4.72	33.17	54.00	-20.83	AVG	
2	4924.5670	39.72	4.72	44.44	74.00	-29.56	Peak	

REMARKS:

- (1) Measurement Value = Reading Level + Correct Factor.
- (2) Margin Level = Measurement Value - Limit Value.

Test Mode	TX N(HT40) Mode 2422 MHz	Polarization	Vertical
-----------	--------------------------	--------------	----------

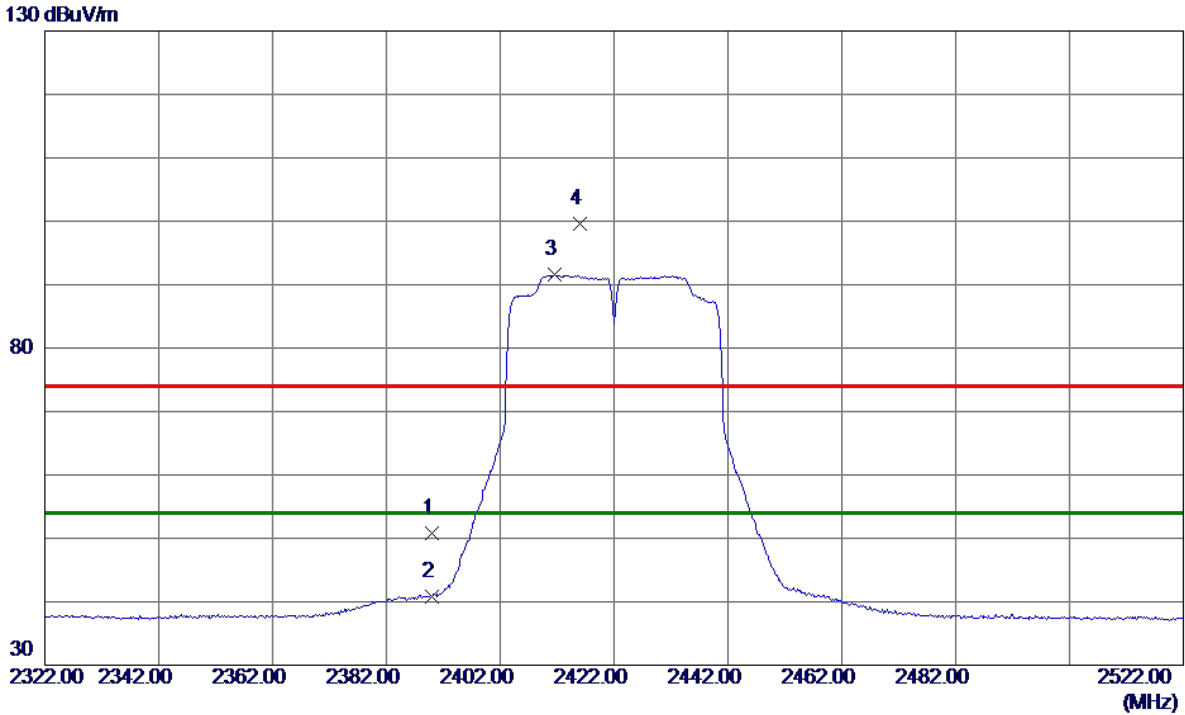

No.	Freq. MHz	Reading Level dBuV/m	Correct Factor dB	Measure ment dBuV/m	Limit dBuV/m	Margin dB	Detector	Comment
1	2390.0000	43.58	7.26	50.84	74.00	-23.16	Peak	
2	2390.0000	33.62	7.26	40.88	54.00	-13.12	AVG	
3 *	2411.6000	84.27	7.26	91.53	54.00	37.53	AVG	No Limit
4	2416.0000	92.31	7.26	99.57	74.00	25.57	Peak	No Limit

REMARKS:

- (1) Measurement Value = Reading Level + Correct Factor.
- (2) Margin Level = Measurement Value - Limit Value.

Test Mode	TX N(HT40) Mode 2422 MHz	Polarization	Vertical
-----------	--------------------------	--------------	----------

80 dBuV/m

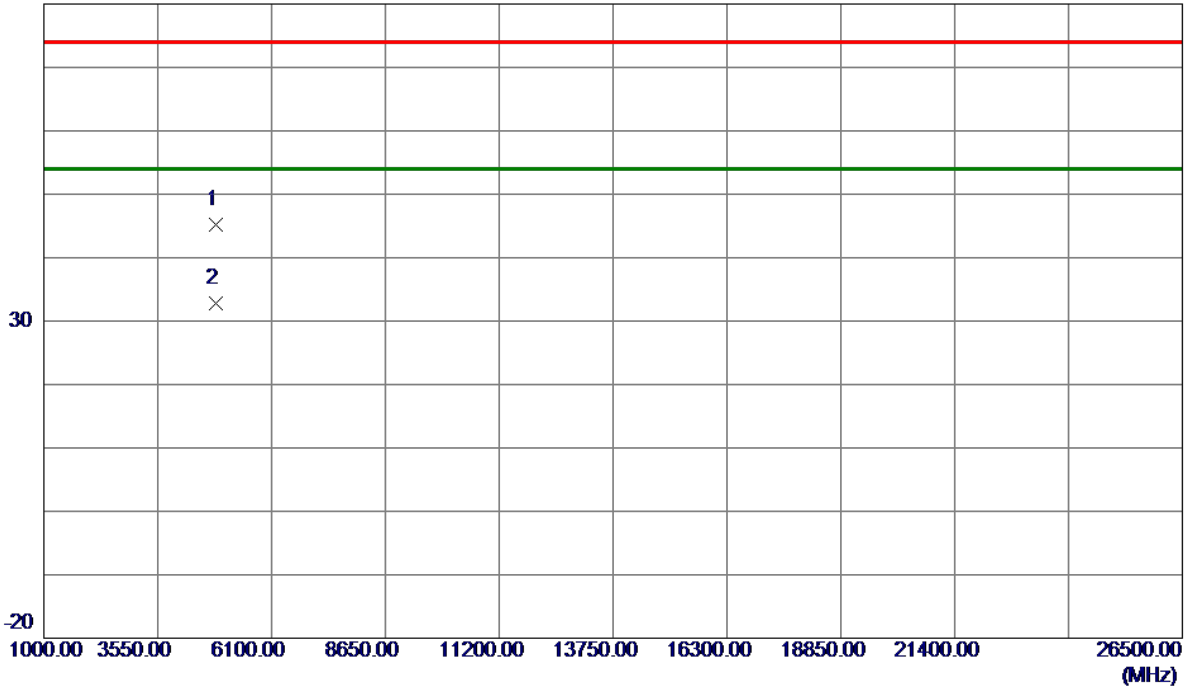

No.	Freq. MHz	Reading Level dBuV/m	Correct Factor dB	Measure ment dBuV/m	Limit dBuV/m	Margin dB	Detector	Comment
1	4843.9770	40.78	4.50	45.28	74.00	-28.72	Peak	
2 *	4844.1150	28.28	4.50	32.78	54.00	-21.22	AVG	

REMARKS:

- (1) Measurement Value = Reading Level + Correct Factor.
- (2) Margin Level = Measurement Value - Limit Value.

Test Mode	TX N(HT40) Mode 2422 MHz	Polarization	Horizontal
-----------	--------------------------	--------------	------------

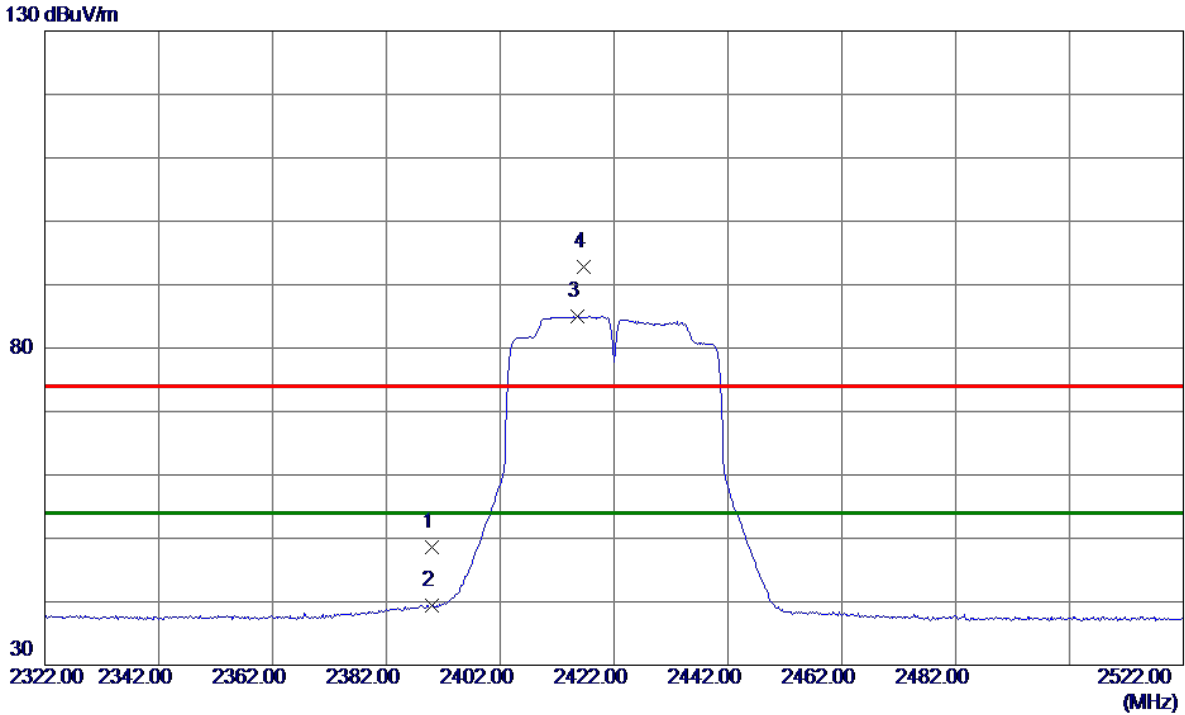

No.	Freq. MHz	Reading Level dBuV/m	Correct Factor dB	Measurement dBuV/m	Limit dBuV/m	Margin dB	Detector	Comment
1	2390.0000	41.33	7.26	48.59	74.00	-25.41	Peak	
2	2390.0000	32.12	7.26	39.38	54.00	-14.62	AVG	
3 *	2415.6000	77.80	7.26	85.06	54.00	31.06	AVG	No Limit
4	2416.6000	85.54	7.26	92.80	74.00	18.80	Peak	No Limit

REMARKS:

- (1) Measurement Value = Reading Level + Correct Factor.
- (2) Margin Level = Measurement Value - Limit Value.

Test Mode	TX N(HT40) Mode 2422 MHz	Polarization	Horizontal
-----------	--------------------------	--------------	------------

80 dBuV/m

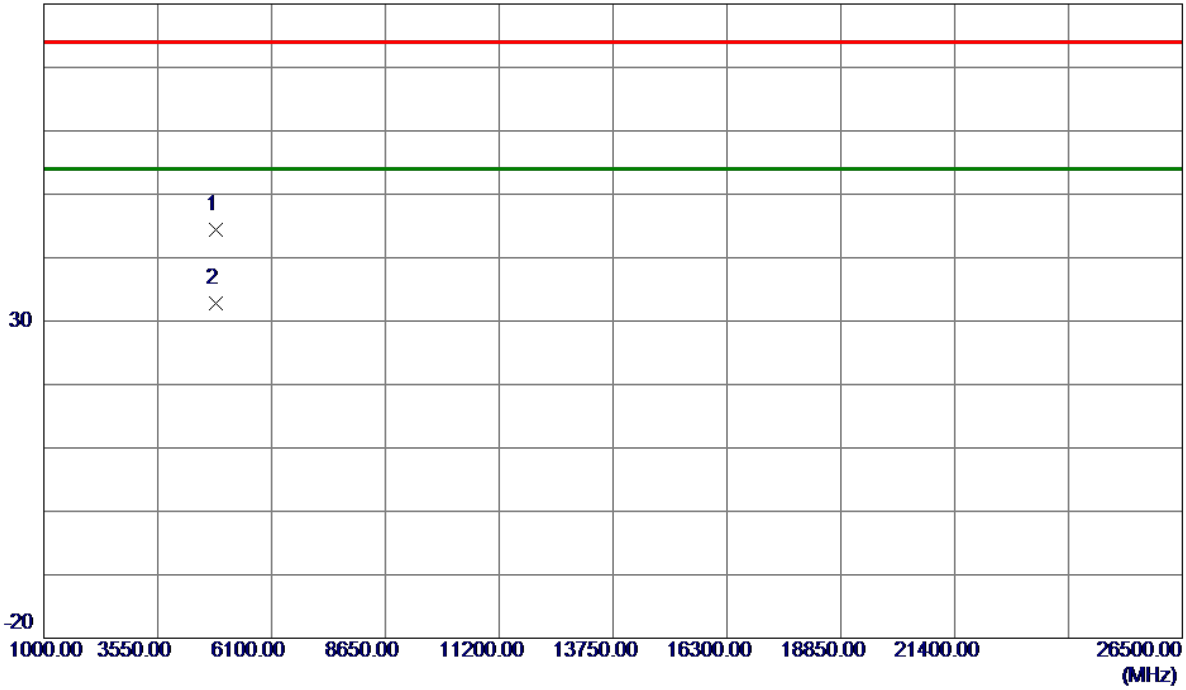

No.	Freq. MHz	Reading Level dBuV/m	Correct Factor dB	Measure ment dBuV/m	Limit dBuV/m	Margin dB	Detector	Comment
1	4844.1790	39.92	4.50	44.42	74.00	-29.58	Peak	
2 *	4844.6960	28.33	4.51	32.84	54.00	-21.16	AVG	

REMARKS:

- (1) Measurement Value = Reading Level + Correct Factor.
- (2) Margin Level = Measurement Value - Limit Value.

Test Mode	TX N(HT40) Mode 2437 MHz	Polarization	Vertical
-----------	--------------------------	--------------	----------

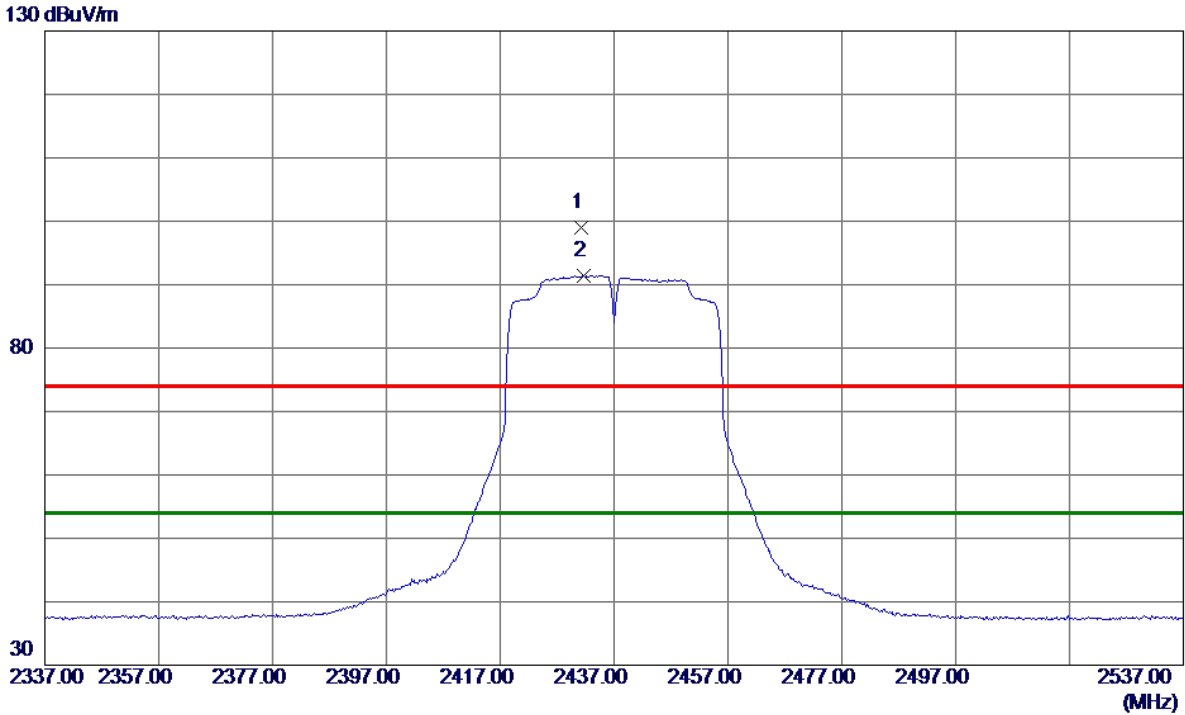

No.	Freq. MHz	Reading Level dBuV/m	Correct Factor dB	Measure ment dBuV/m	Limit dBuV/m	Margin dB	Detector	Comment
1	2431.2000	91.71	7.25	98.96	74.00	24.96	Peak	No Limit
2 *	2431.6000	84.23	7.25	91.48	54.00	37.48	AVG	No Limit

REMARKS:

- (1) Measurement Value = Reading Level + Correct Factor.
- (2) Margin Level = Measurement Value - Limit Value.

Test Mode	TX N(HT40) Mode 2437 MHz	Polarization	Vertical
-----------	--------------------------	--------------	----------

80 dBuV/m

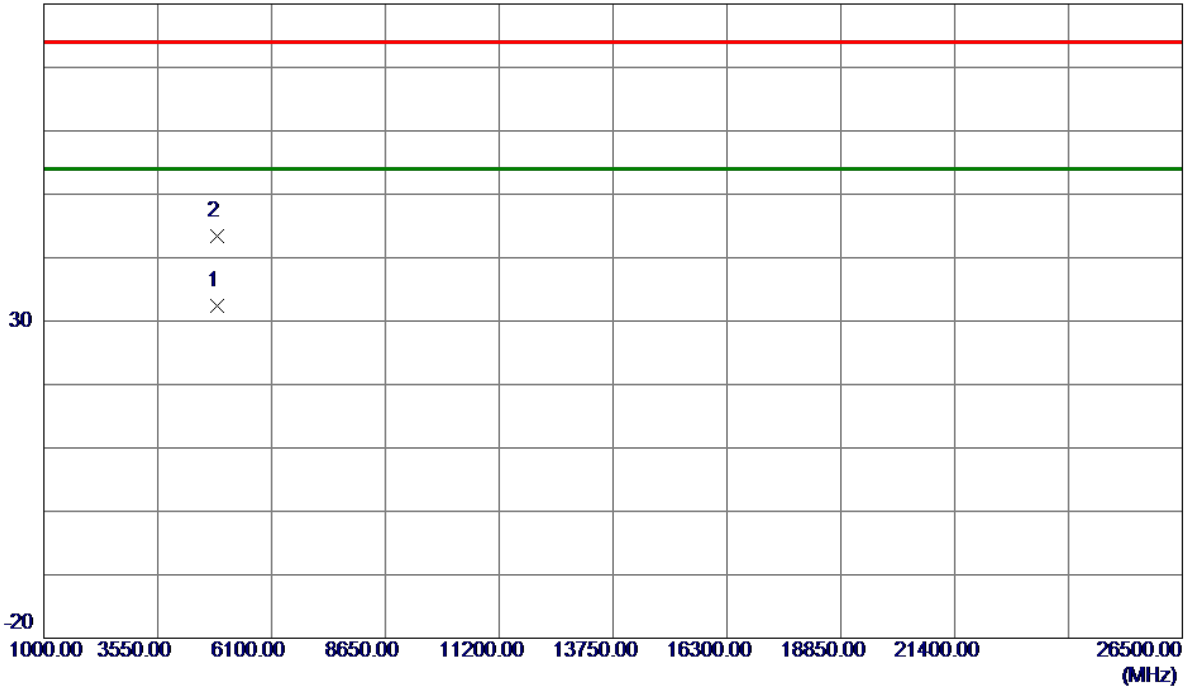

No.	Freq. MHz	Reading Level dBuV/m	Correct Factor dB	Measure ment dBuV/m	Limit dBuV/m	Margin dB	Detector	Comment
1 *	4874.0170	27.86	4.58	32.44	54.00	-21.56	AVG	
2	4874.8440	38.82	4.59	43.41	74.00	-30.59	Peak	

REMARKS:

- (1) Measurement Value = Reading Level + Correct Factor.
 (2) Margin Level = Measurement Value - Limit Value.

Test Mode	TX N(HT40) Mode 2437 MHz	Polarization	Horizontal
-----------	--------------------------	--------------	------------

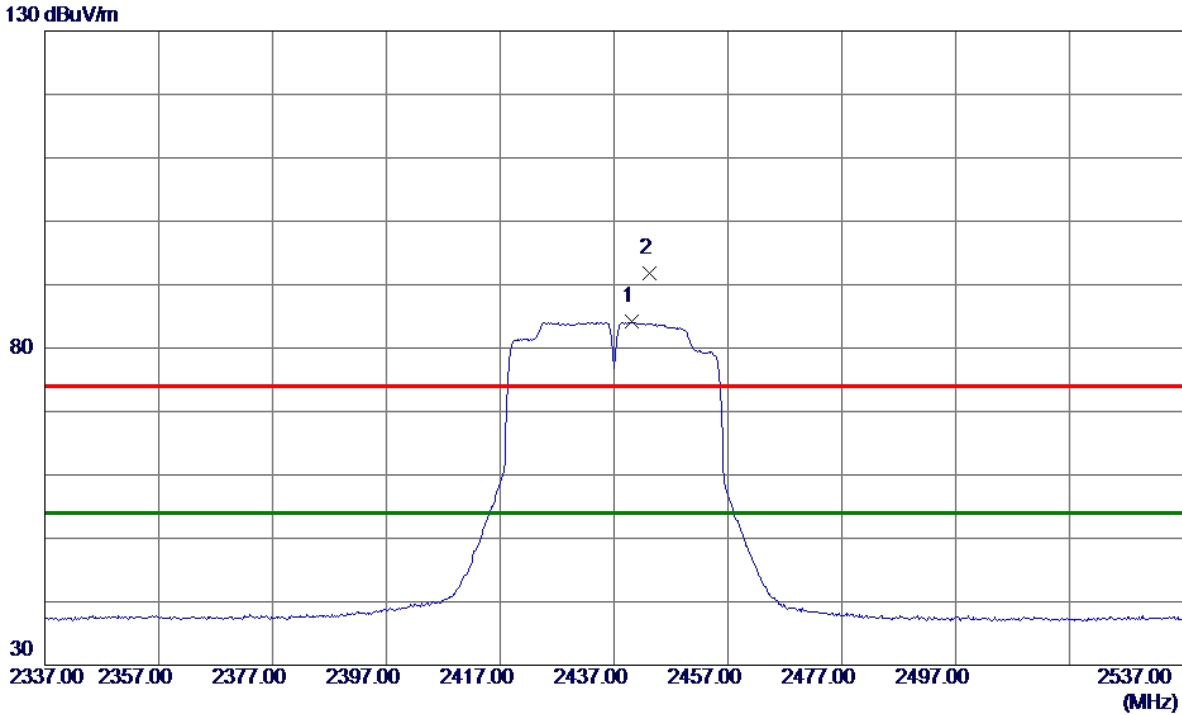

No.	Freq. MHz	Reading Level dBuV/m	Correct Factor dB	Measure ment dBuV/m	Limit dBuV/m	Margin dB	Detector	Comment
1 *	2440.2000	76.90	7.25	84.15	54.00	30.15	AVG	No Limit
2	2443.2000	84.58	7.25	91.83	74.00	17.83	Peak	No Limit

REMARKS:

- (1) Measurement Value = Reading Level + Correct Factor.
- (2) Margin Level = Measurement Value - Limit Value.

Test Mode	TX N(HT40) Mode 2437 MHz	Polarization	Horizontal
-----------	--------------------------	--------------	------------

80 dBuV/m

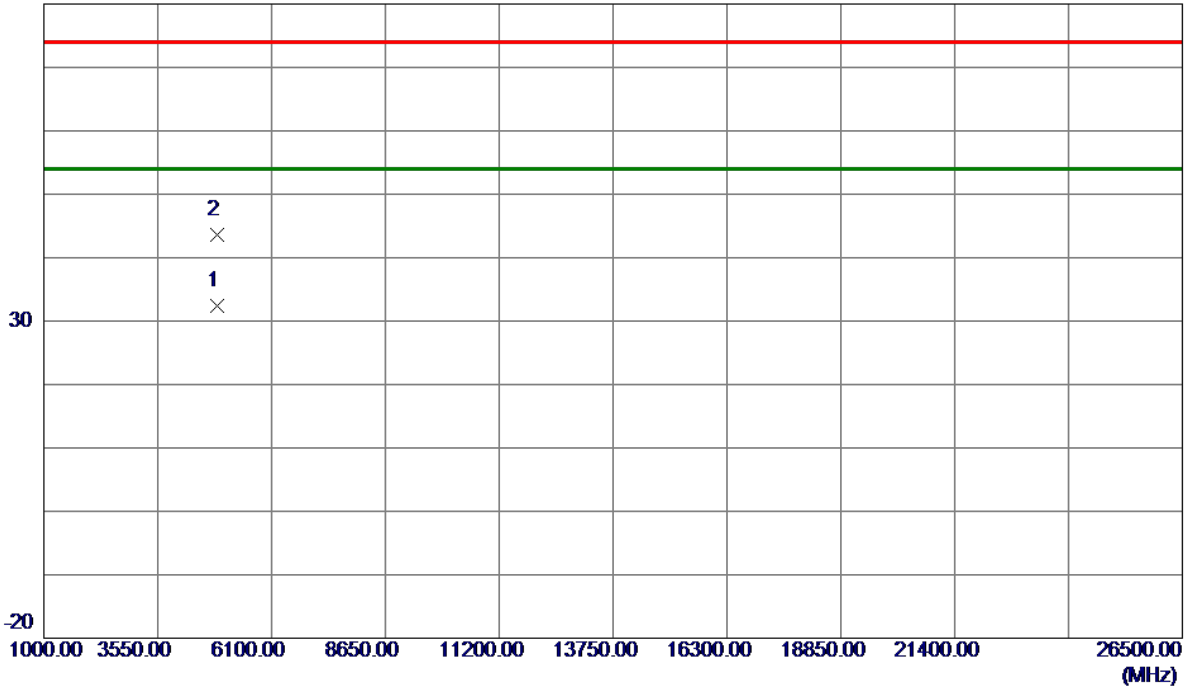

No.	Freq. MHz	Reading Level dBuV/m	Correct Factor dB	Measure ment dBuV/m	Limit dBuV/m	Margin dB	Detector	Comment
1 *	4874.8670	27.74	4.59	32.33	54.00	-21.67	AVG	
2	4874.9169	39.03	4.59	43.62	74.00	-30.38	Peak	

REMARKS:

- (1) Measurement Value = Reading Level + Correct Factor.
- (2) Margin Level = Measurement Value - Limit Value.

Test Mode	TX N(HT40) Mode 2452 MHz	Polarization	Vertical
-----------	--------------------------	--------------	----------

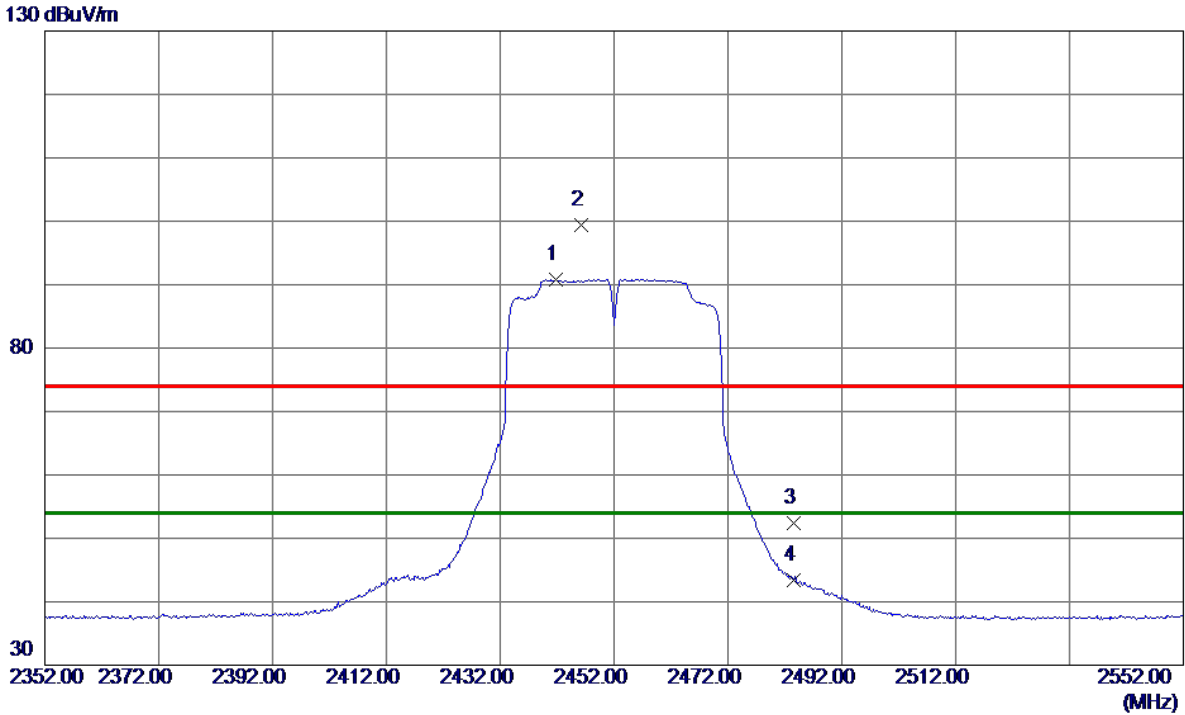

No.	Freq. MHz	Reading Level dBuV/m	Correct Factor dB	Measure ment dBuV/m	Limit dBuV/m	Margin dB	Detector	Comment
1 *	2441.8000	83.60	7.25	90.85	54.00	36.85	AVG	No Limit
2	2446.2000	92.10	7.25	99.35	74.00	25.35	Peak	No Limit
3	2483.5000	45.19	7.25	52.44	74.00	-21.56	Peak	
4	2483.5000	36.13	7.25	43.38	54.00	-10.62	AVG	

REMARKS:

- (1) Measurement Value = Reading Level + Correct Factor.
- (2) Margin Level = Measurement Value - Limit Value.

Test Mode	TX N(HT40) Mode 2452 MHz	Polarization	Vertical
-----------	--------------------------	--------------	----------

80 dBuV/m

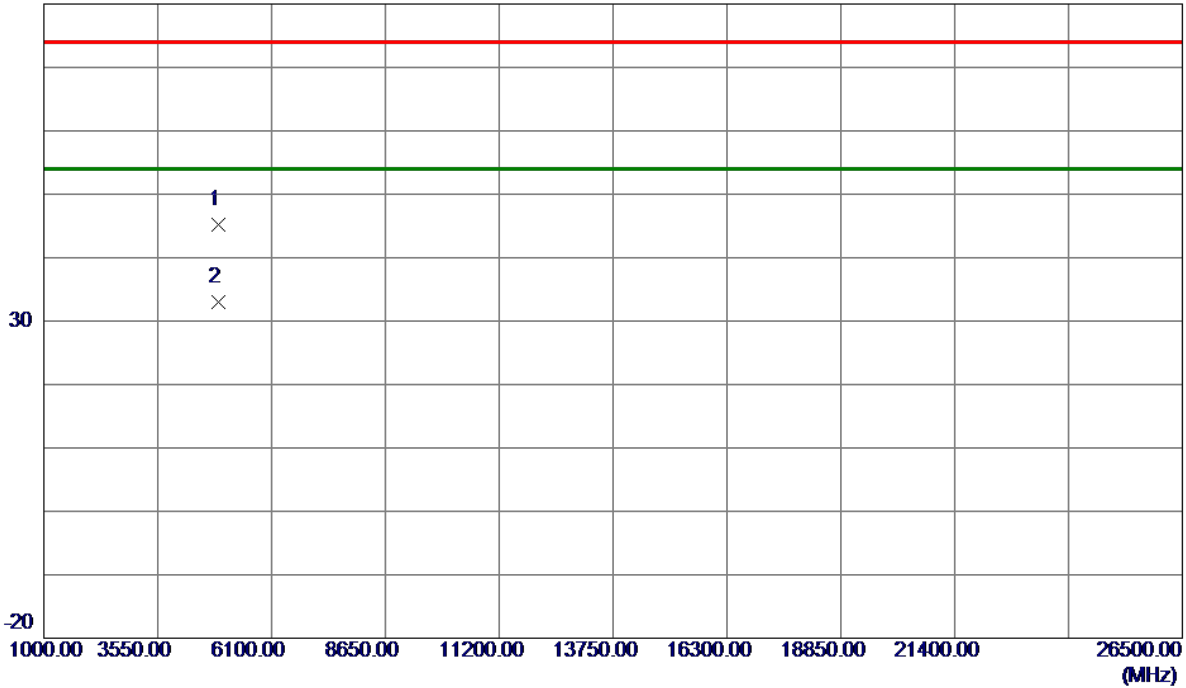

No.	Freq. MHz	Reading Level dBuV/m	Correct Factor dB	Measure ment dBuV/m	Limit dBuV/m	Margin dB	Detector	Comment
1	4903.8430	40.47	4.66	45.13	74.00	-28.87	Peak	
2 *	4904.7930	28.31	4.67	32.98	54.00	-21.02	AVG	

REMARKS:

- (1) Measurement Value = Reading Level + Correct Factor.
- (2) Margin Level = Measurement Value - Limit Value.

Test Mode	TX N(HT40) Mode 2452 MHz	Polarization	Horizontal
-----------	--------------------------	--------------	------------

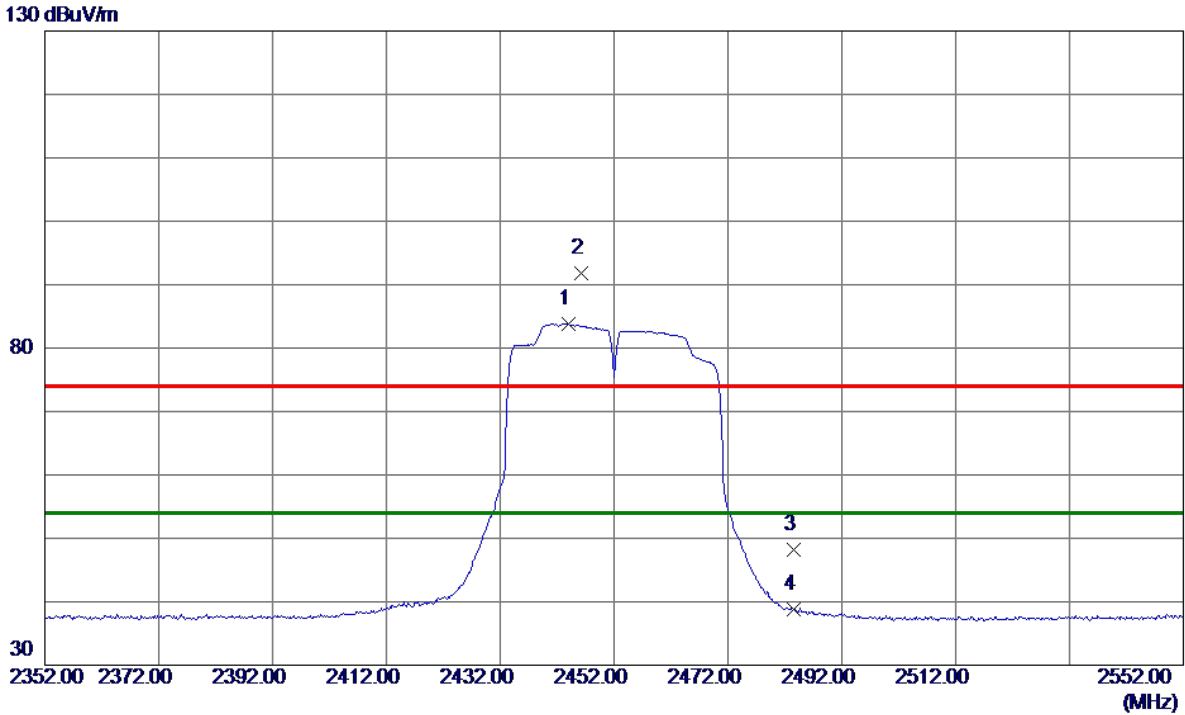

No.	Freq. MHz	Reading Level dBuV/m	Correct Factor dB	Measure ment dBuV/m	Limit dBuV/m	Margin dB	Detector	Comment
1 *	2444.0000	76.62	7.25	83.87	54.00	29.87	AVG	No Limit
2	2446.2000	84.51	7.25	91.76	74.00	17.76	Peak	No Limit
3	2483.5000	40.91	7.25	48.16	74.00	-25.84	Peak	
4	2483.5000	31.53	7.25	38.78	54.00	-15.22	AVG	

REMARKS:

- (1) Measurement Value = Reading Level + Correct Factor.
- (2) Margin Level = Measurement Value - Limit Value.

Test Mode	TX N(HT40) Mode 2452 MHz	Polarization	Horizontal
-----------	--------------------------	--------------	------------

80 dBuV/m

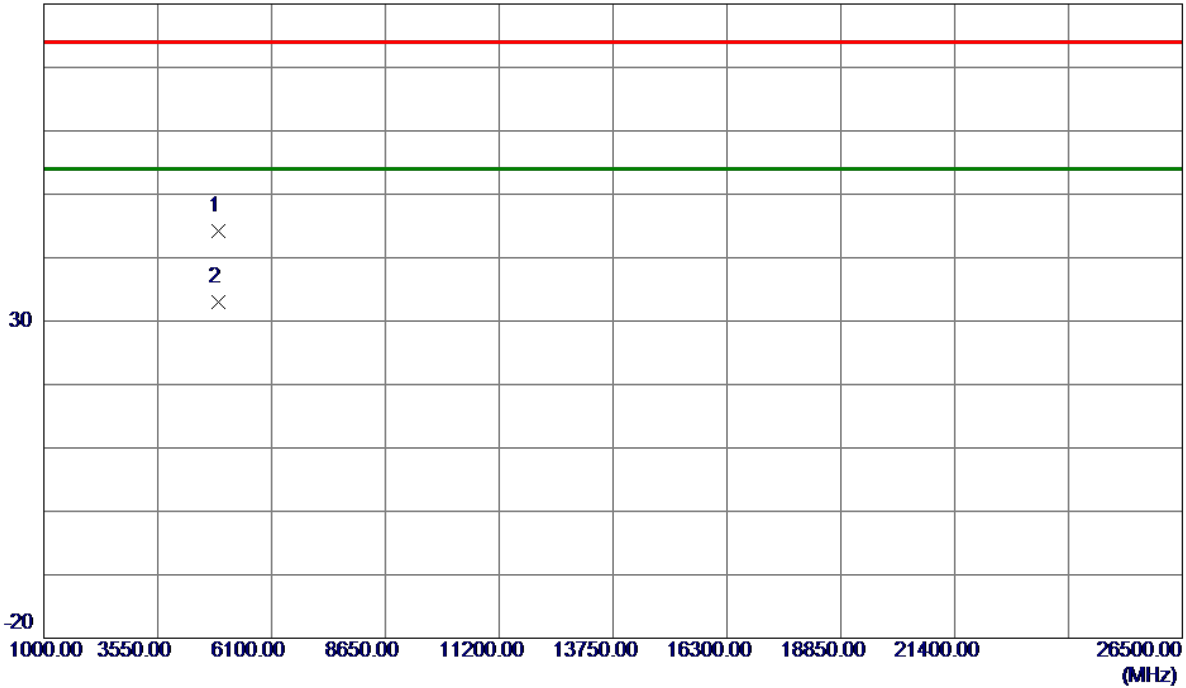

No.	Freq. MHz	Reading Level dBuV/m	Correct Factor dB	Measure ment dBuV/m	Limit dBuV/m	Margin dB	Detector	Comment
1	4903.2010	39.63	4.66	44.29	74.00	-29.71	Peak	
2 *	4904.4900	28.28	4.67	32.95	54.00	-21.05	AVG	

REMARKS:

- (1) Measurement Value = Reading Level + Correct Factor.
- (2) Margin Level = Measurement Value - Limit Value.

Test Mode	TX AX(HE20) Mode 2412 MHz	Polarization	Vertical
-----------	---------------------------	--------------	----------

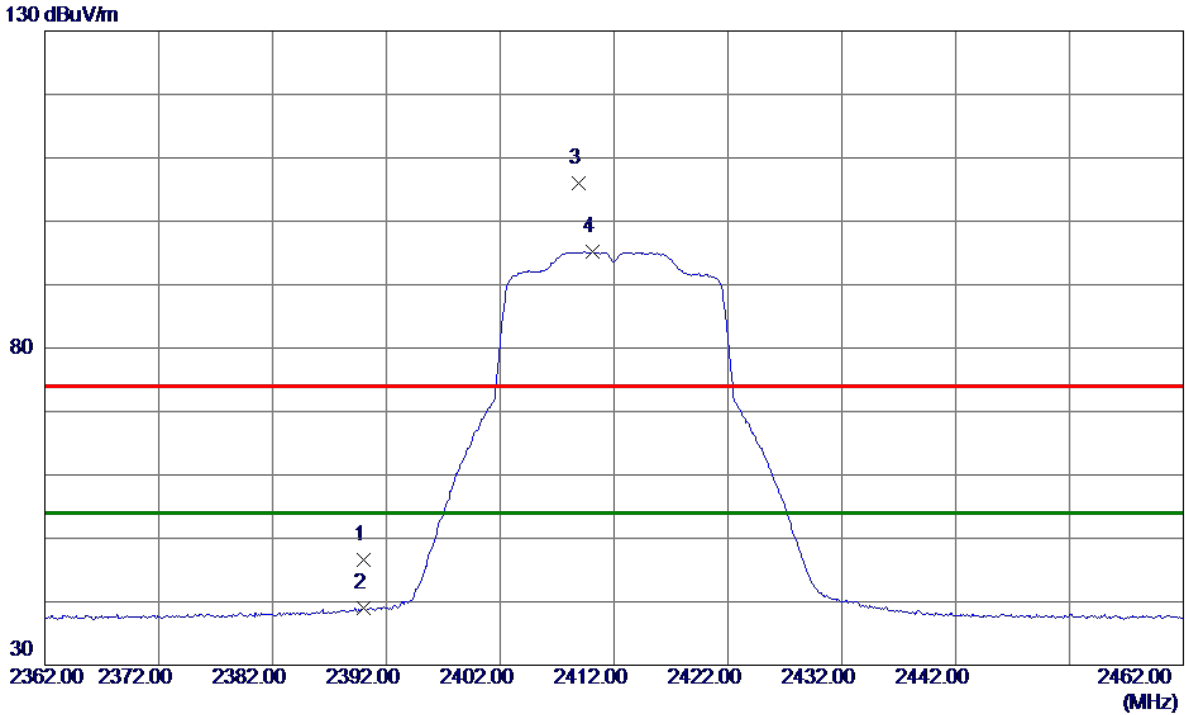

No.	Freq. MHz	Reading Level dBuV/m	Correct Factor dB	Measure ment dBuV/m	Limit dBuV/m	Margin dB	Detector	Comment
1	2390.0000	39.25	7.26	46.51	74.00	-27.49	Peak	
2	2390.0000	31.65	7.26	38.91	54.00	-15.09	AVG	
3	2408.9000	98.72	7.26	105.98	74.00	31.98	Peak	No Limit
4 *	2410.1000	87.92	7.26	95.18	54.00	41.18	AVG	No Limit

REMARKS:

- (1) Measurement Value = Reading Level + Correct Factor.
- (2) Margin Level = Measurement Value - Limit Value.

Test Mode	TX AX(HE20) Mode 2412 MHz	Polarization	Vertical
-----------	---------------------------	--------------	----------

80 dBuV/m

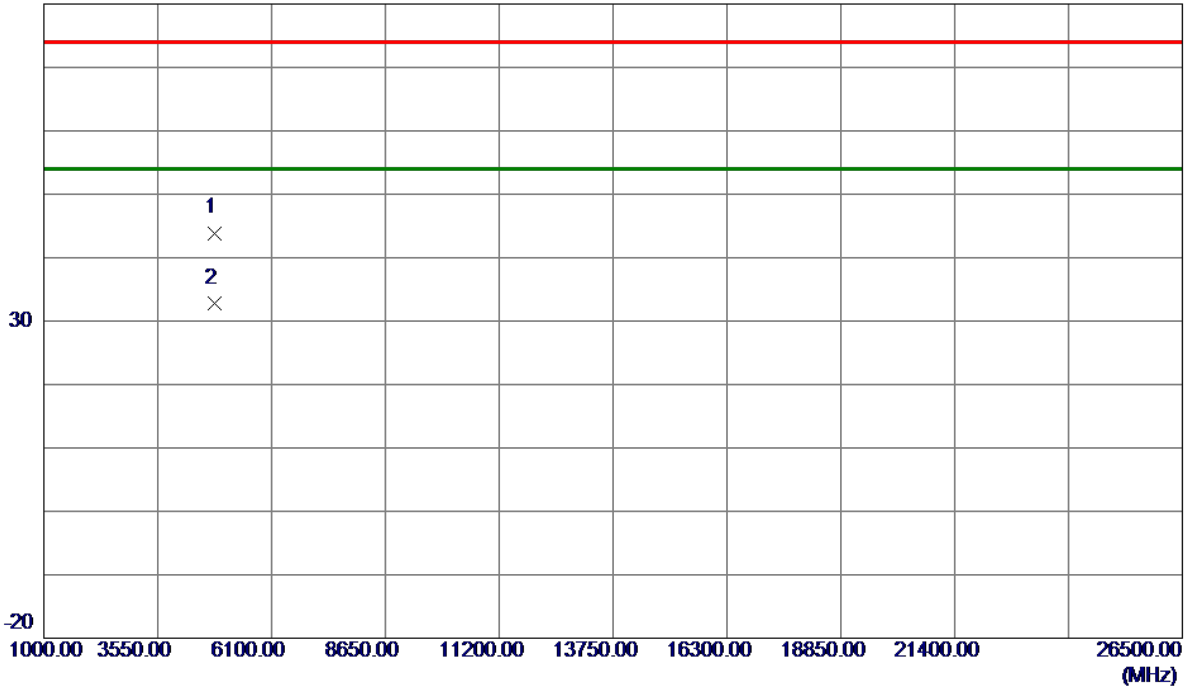

No.	Freq. MHz	Reading Level dBuV/m	Correct Factor dB	Measure ment dBuV/m	Limit dBuV/m	Margin dB	Detector	Comment
1	4823.2960	39.45	4.45	43.90	74.00	-30.10	Peak	
2 *	4824.2599	28.28	4.45	32.73	54.00	-21.27	AVG	

REMARKS:

- (1) Measurement Value = Reading Level + Correct Factor.
- (2) Margin Level = Measurement Value - Limit Value.

Test Mode	TX AX(HE20) Mode 2412 MHz	Polarization	Horizontal
-----------	---------------------------	--------------	------------

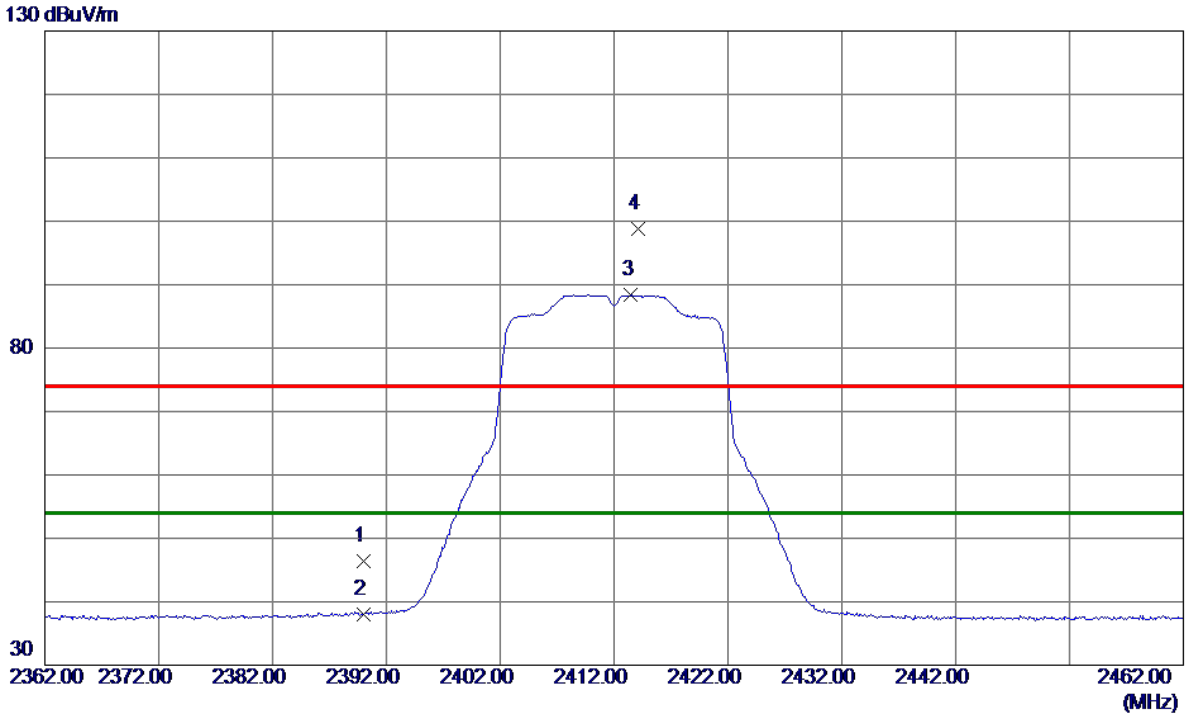

No.	Freq. MHz	Reading Level dBuV/m	Correct Factor dB	Measure ment dBuV/m	Limit dBuV/m	Margin dB	Detector	Comment
1	2390.0000	39.20	7.26	46.46	74.00	-27.54	Peak	
2	2390.0000	30.74	7.26	38.00	54.00	-16.00	AVG	
3 *	2413.5000	81.11	7.26	88.37	54.00	34.37	AVG	No Limit
4	2414.1000	91.56	7.26	98.82	74.00	24.82	Peak	No Limit

REMARKS:

- (1) Measurement Value = Reading Level + Correct Factor.
- (2) Margin Level = Measurement Value - Limit Value.

Test Mode	TX AX(HE20) Mode 2412 MHz	Polarization	Horizontal
-----------	---------------------------	--------------	------------

80 dBuV/m

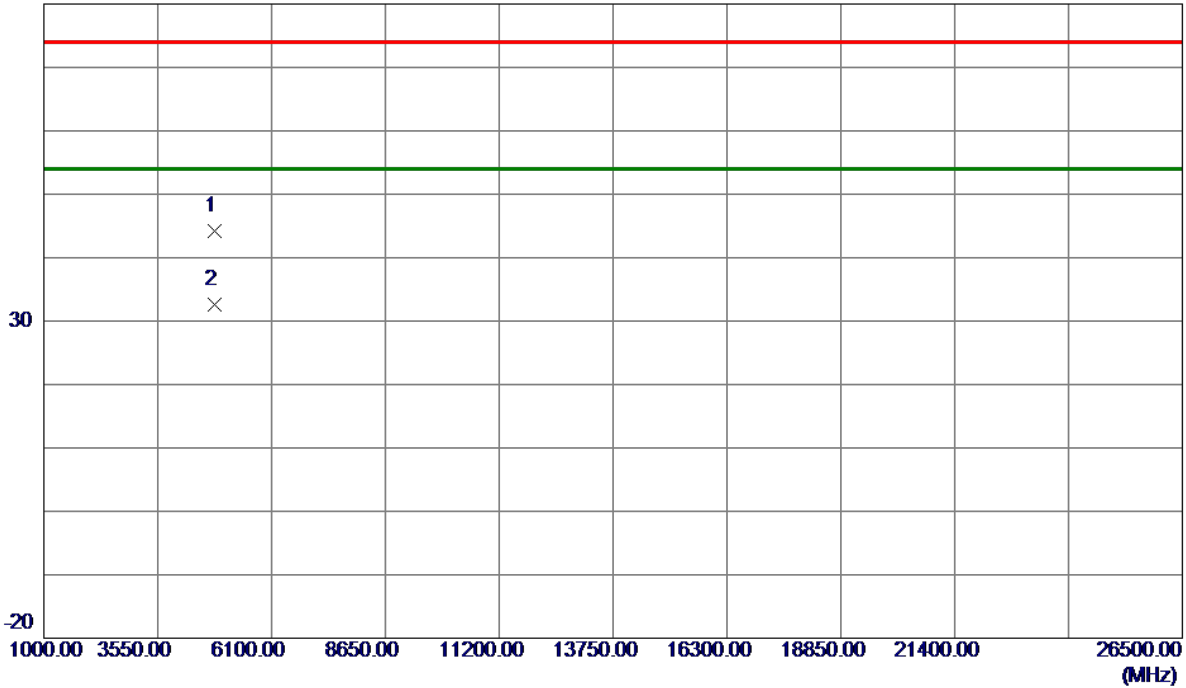

No.	Freq. MHz	Reading Level dBuV/m	Correct Factor dB	Measure ment dBuV/m	Limit dBuV/m	Margin dB	Detector	Comment
1	4823.6680	39.82	4.45	44.27	74.00	-29.73	Peak	
2 *	4824.4250	28.21	4.45	32.66	54.00	-21.34	AVG	

REMARKS:

- (1) Measurement Value = Reading Level + Correct Factor.
- (2) Margin Level = Measurement Value - Limit Value.

Test Mode	TX AX(HE20) Mode 2437 MHz	Polarization	Vertical
-----------	---------------------------	--------------	----------

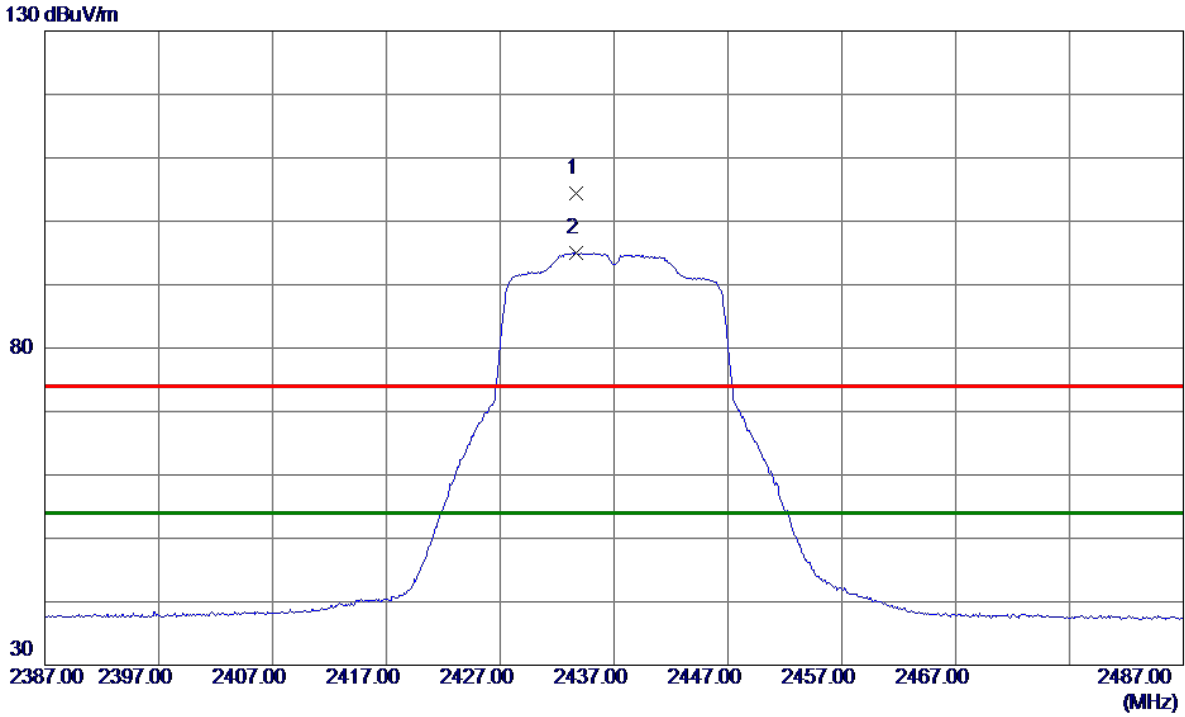

No.	Freq. MHz	Reading Level dBuV/m	Correct Factor dB	Measure ment dBuV/m	Limit dBuV/m	Margin dB	Detector	Comment
1	2433.7000	97.10	7.25	104.35	74.00	30.35	Peak	No Limit
2 *	2433.7000	87.81	7.25	95.06	54.00	41.06	AVG	No Limit

REMARKS:

- (1) Measurement Value = Reading Level + Correct Factor.
- (2) Margin Level = Measurement Value - Limit Value.

Test Mode	TX AX(HE20) Mode 2437 MHz	Polarization	Vertical
-----------	---------------------------	--------------	----------

80 dBuV/m

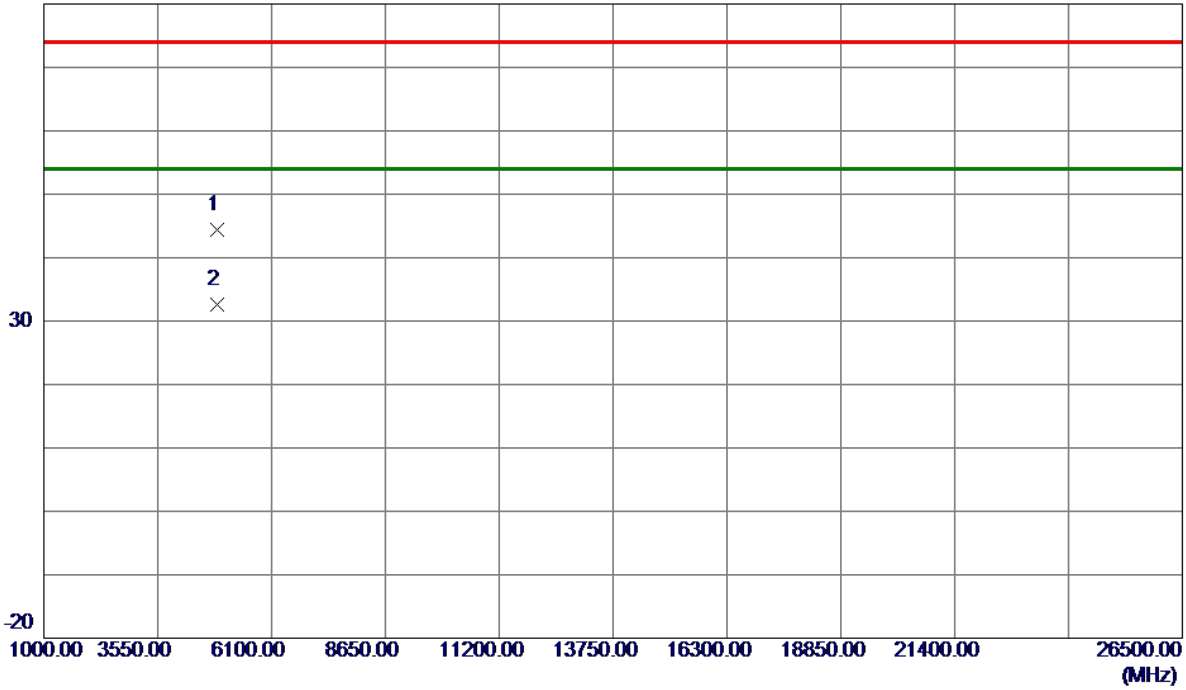

No.	Freq. MHz	Reading Level dBuV/m	Correct Factor dB	Measure ment dBuV/m	Limit dBuV/m	Margin dB	Detector	Comment
1	4873.8580	39.76	4.58	44.34	74.00	-29.66	Peak	
2 *	4874.9169	28.03	4.59	32.62	54.00	-21.38	AVG	

REMARKS:

- (1) Measurement Value = Reading Level + Correct Factor.
- (2) Margin Level = Measurement Value - Limit Value.

Test Mode	TX AX(HE20) Mode 2437 MHz	Polarization	Horizontal
-----------	---------------------------	--------------	------------

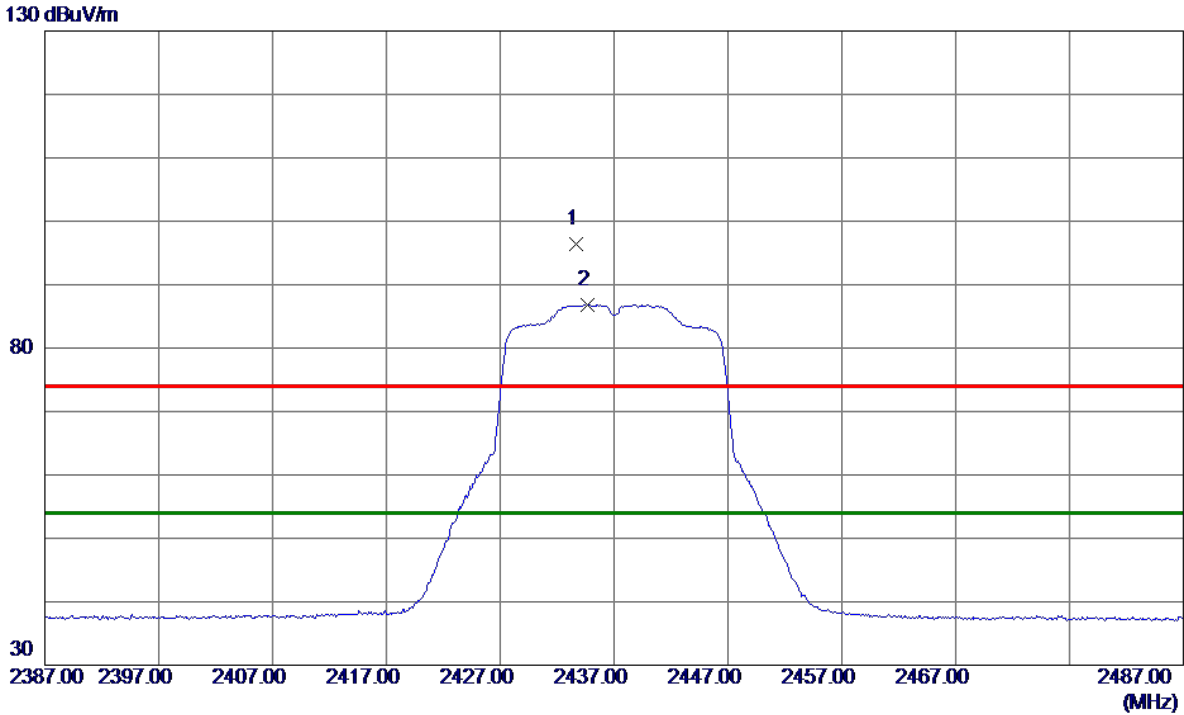

No.	Freq. MHz	Reading Level dBuV/m	Correct Factor dB	Measure ment dBuV/m	Limit dBuV/m	Margin dB	Detector	Comment
1	2433.7000	89.18	7.25	96.43	74.00	22.43	Peak	No Limit
2 *	2434.7000	79.60	7.25	86.85	54.00	32.85	AVG	No Limit

REMARKS:

- (1) Measurement Value = Reading Level + Correct Factor.
- (2) Margin Level = Measurement Value - Limit Value.

Test Mode	TX AX(HE20) Mode 2437 MHz	Polarization	Horizontal
-----------	---------------------------	--------------	------------

80 dBuV/m

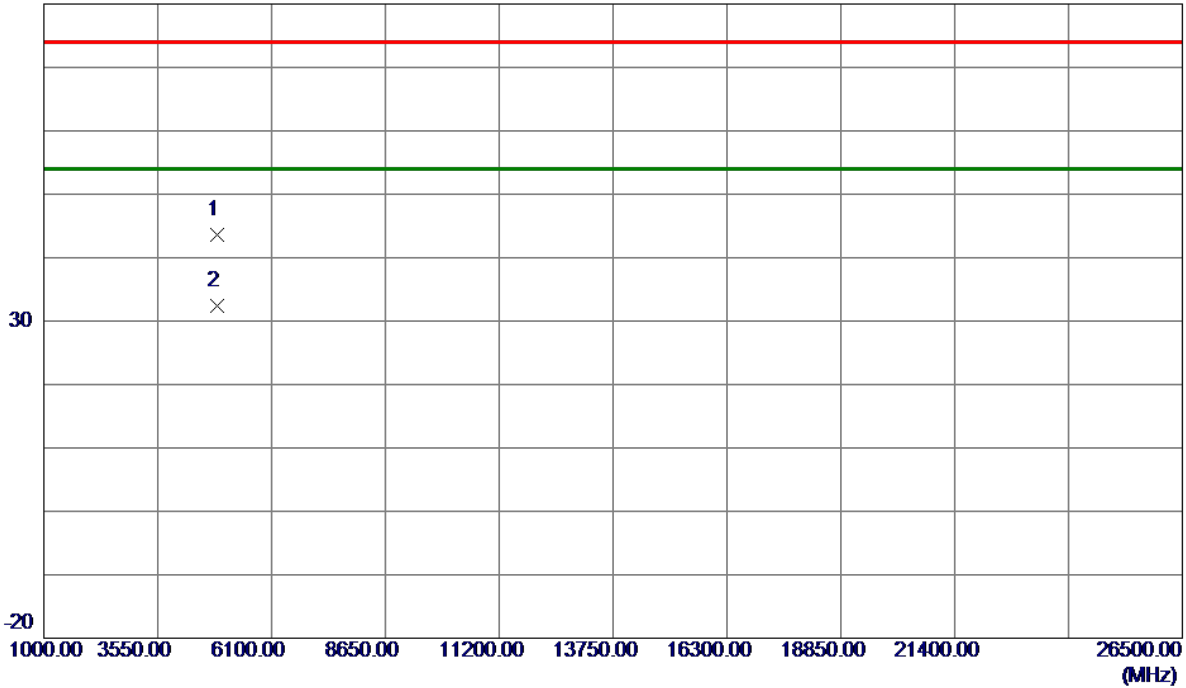

No.	Freq. MHz	Reading Level dBuV/m	Correct Factor dB	Measure ment dBuV/m	Limit dBuV/m	Margin dB	Detector	Comment
1	4873.6840	39.05	4.58	43.63	74.00	-30.37	Peak	
2 *	4874.7990	27.80	4.59	32.39	54.00	-21.61	AVG	

REMARKS:

- (1) Measurement Value = Reading Level + Correct Factor.
- (2) Margin Level = Measurement Value - Limit Value.

Test Mode	TX AX(HE20) Mode 2462 MHz	Polarization	Vertical
-----------	---------------------------	--------------	----------

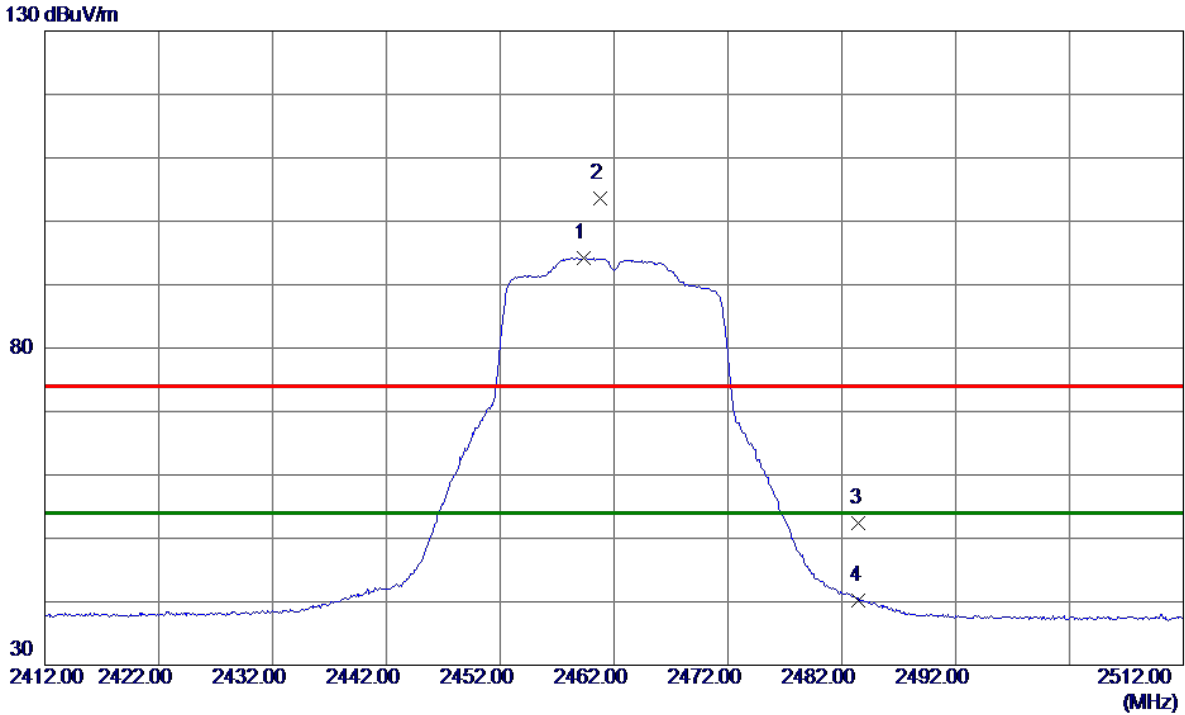

No.	Freq. MHz	Reading Level dBuV/m	Correct Factor dB	Measure ment dBuV/m	Limit dBuV/m	Margin dB	Detector	Comment
1 *	2459.3000	86.96	7.25	94.21	54.00	40.21	AVG	No Limit
2	2460.8000	96.29	7.25	103.54	74.00	29.54	Peak	No Limit
3	2483.5000	45.16	7.25	52.41	74.00	-21.59	Peak	
4	2483.5000	32.97	7.25	40.22	54.00	-13.78	AVG	

REMARKS:

- (1) Measurement Value = Reading Level + Correct Factor.
- (2) Margin Level = Measurement Value - Limit Value.

Test Mode	TX AX(HE20) Mode 2462 MHz	Polarization	Vertical
-----------	---------------------------	--------------	----------

80 dBuV/m

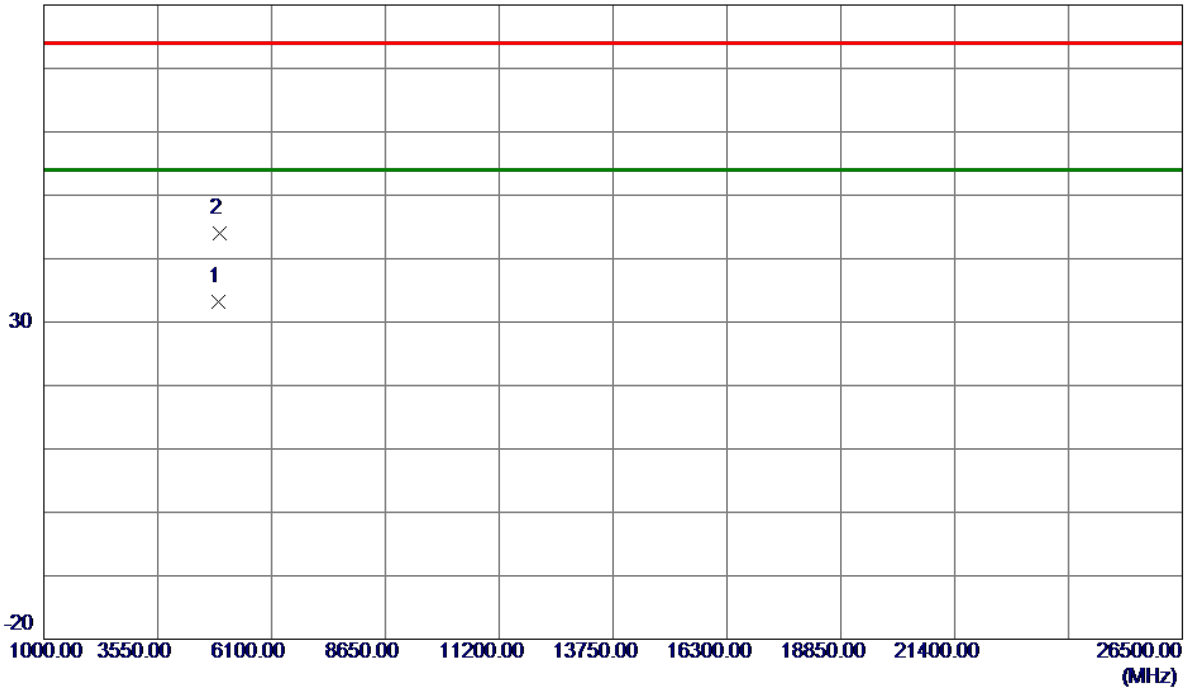

No.	Freq. MHz	Reading Level dBuV/m	Correct Factor dB	Measure ment dBuV/m	Limit dBuV/m	Margin dB	Detector	Comment
1 *	4923.4540	28.54	4.72	33.26	54.00	-20.74	AVG	
2	4924.7839	39.22	4.72	43.94	74.00	-30.06	Peak	

REMARKS:

- (1) Measurement Value = Reading Level + Correct Factor.
- (2) Margin Level = Measurement Value - Limit Value.

Test Mode	TX AX(HE20) Mode 2462 MHz	Polarization	Horizontal
-----------	---------------------------	--------------	------------

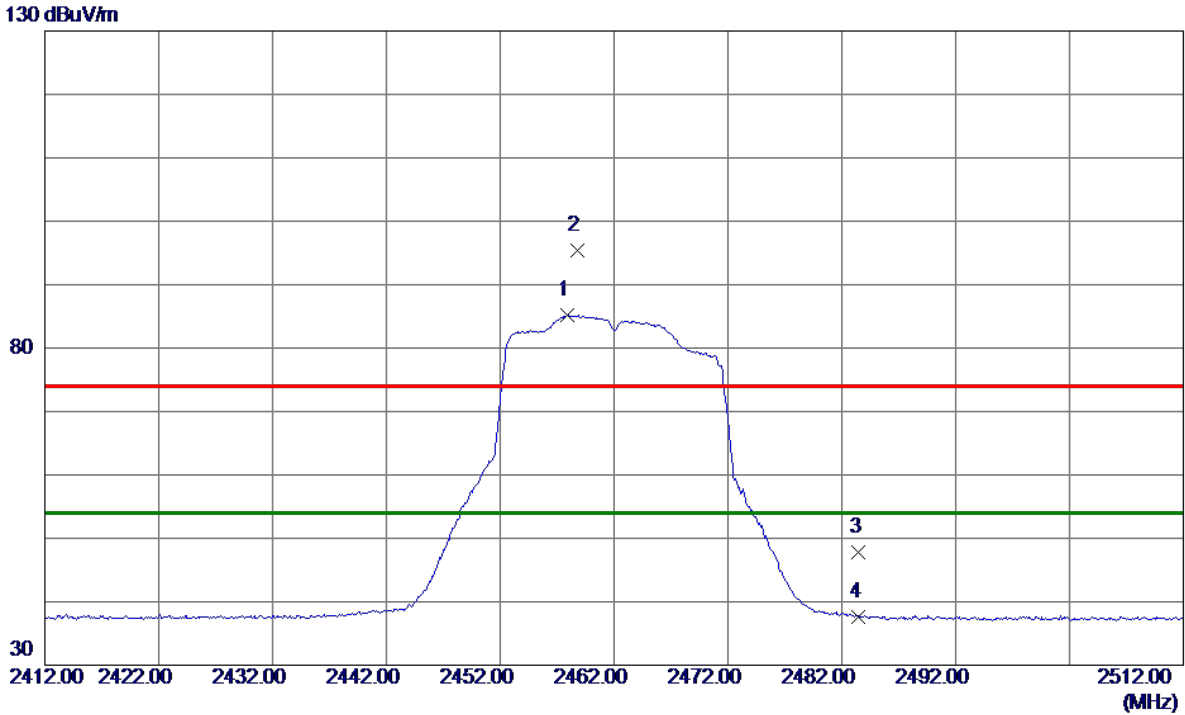

No.	Freq. MHz	Reading Level dBuV/m	Correct Factor dB	Measure ment dBuV/m	Limit dBuV/m	Margin dB	Detector	Comment
1 *	2457.9000	77.94	7.25	85.19	54.00	31.19	AVG	No Limit
2	2458.8000	88.09	7.25	95.34	74.00	21.34	Peak	No Limit
3	2483.5000	40.60	7.25	47.85	74.00	-26.15	Peak	
4	2483.5000	30.39	7.25	37.64	54.00	-16.36	AVG	

REMARKS:

- (1) Measurement Value = Reading Level + Correct Factor.
- (2) Margin Level = Measurement Value - Limit Value.

Test Mode	TX AX(HE20) Mode 2462 MHz	Polarization	Horizontal
-----------	---------------------------	--------------	------------

80 dBuV/m

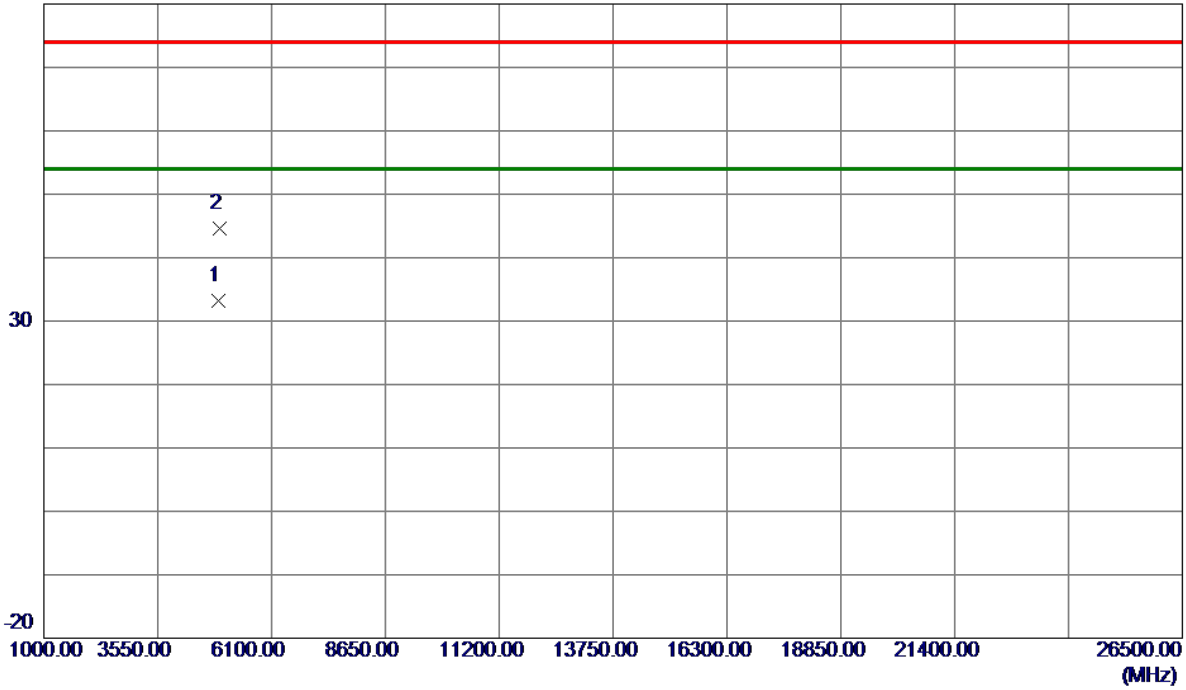

No.	Freq. MHz	Reading Level dBuV/m	Correct Factor dB	Measure ment dBuV/m	Limit dBuV/m	Margin dB	Detector	Comment
1 *	4923.2360	28.48	4.72	33.20	54.00	-20.80	AVG	
2	4924.9650	39.96	4.72	44.68	74.00	-29.32	Peak	

REMARKS:

- (1) Measurement Value = Reading Level + Correct Factor.
- (2) Margin Level = Measurement Value - Limit Value.

Test Mode	TX AX(HE40) Mode 2422 MHz	Polarization	Vertical
-----------	---------------------------	--------------	----------

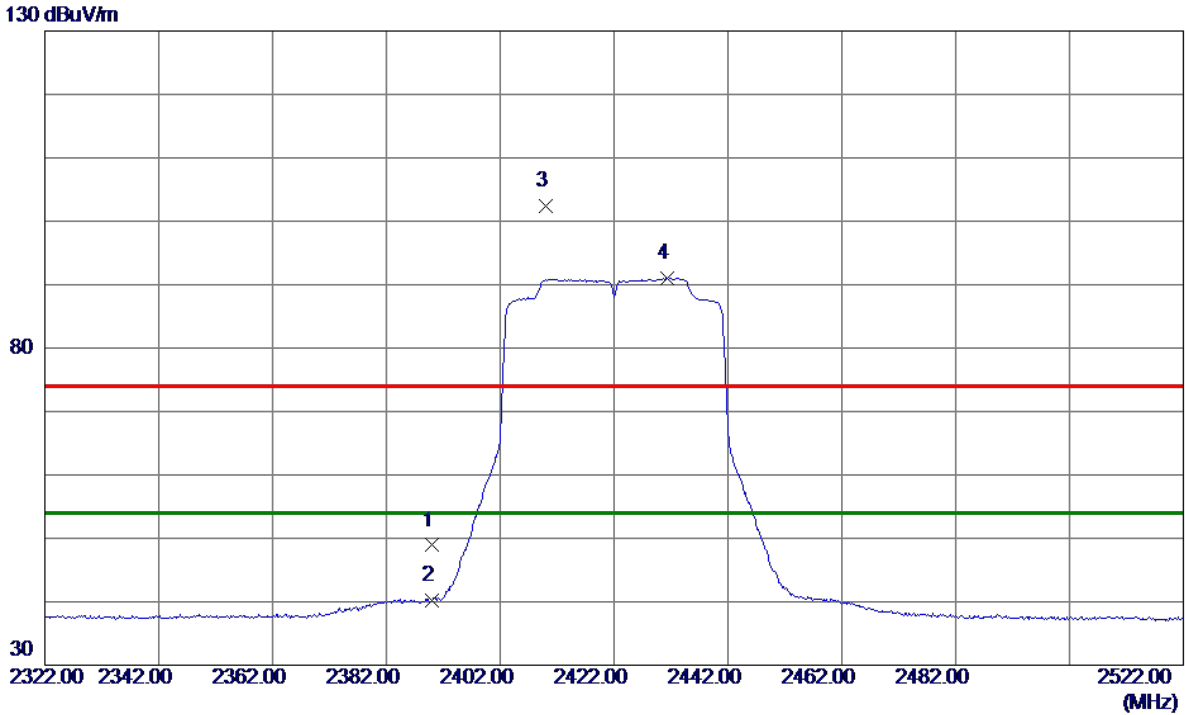

No.	Freq. MHz	Reading Level dBuV/m	Correct Factor dB	Measure ment dBuV/m	Limit dBuV/m	Margin dB	Detector	Comment
1	2390.0000	41.64	7.26	48.90	74.00	-25.10	Peak	
2	2390.0000	33.00	7.26	40.26	54.00	-13.74	AVG	
3	2410.0000	95.16	7.26	102.42	74.00	28.42	Peak	No Limit
4 *	2431.4000	83.76	7.25	91.01	54.00	37.01	AVG	No Limit

REMARKS:

- (1) Measurement Value = Reading Level + Correct Factor.
- (2) Margin Level = Measurement Value - Limit Value.

Test Mode	TX AX(HE40) Mode 2422 MHz	Polarization	Vertical
-----------	---------------------------	--------------	----------

80 dBuV/m

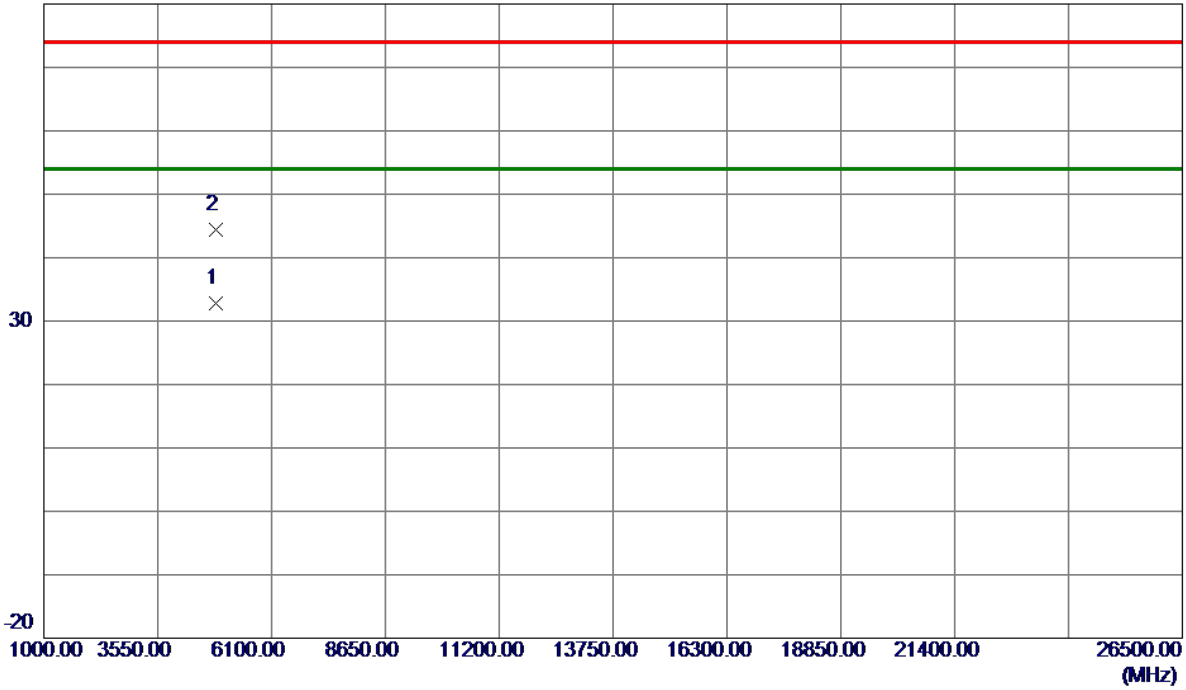

No.	Freq. MHz	Reading Level dBuV/m	Correct Factor dB	Measure ment dBuV/m	Limit dBuV/m	Margin dB	Detector	Comment
1 *	4843.0170	28.34	4.50	32.84	54.00	-21.16	AVG	
2	4844.6840	39.88	4.51	44.39	74.00	-29.61	Peak	

REMARKS:

- (1) Measurement Value = Reading Level + Correct Factor.
- (2) Margin Level = Measurement Value - Limit Value.

Test Mode	TX AX(HE40) Mode 2422 MHz	Polarization	Horizontal
-----------	---------------------------	--------------	------------

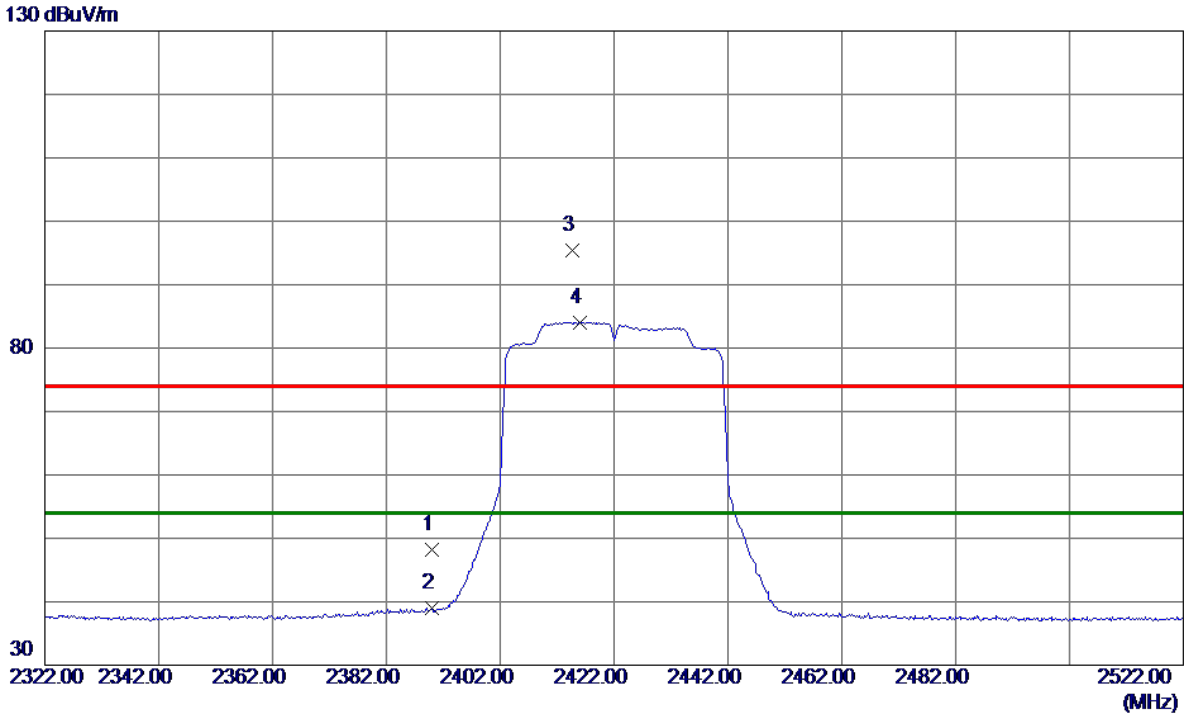

No.	Freq. MHz	Reading Level dBuV/m	Correct Factor dB	Measure ment dBuV/m	Limit dBuV/m	Margin dB	Detector	Comment
1	2390.0000	40.97	7.26	48.23	74.00	-25.77	Peak	
2	2390.0000	31.67	7.26	38.93	54.00	-15.07	AVG	
3	2414.6000	88.17	7.26	95.43	74.00	21.43	Peak	No Limit
4 *	2416.0000	76.82	7.26	84.08	54.00	30.08	AVG	No Limit

REMARKS:

- (1) Measurement Value = Reading Level + Correct Factor.
- (2) Margin Level = Measurement Value - Limit Value.

Test Mode	TX AX(HE40) Mode 2422 MHz	Polarization	Horizontal
-----------	---------------------------	--------------	------------

80 dBuV/m

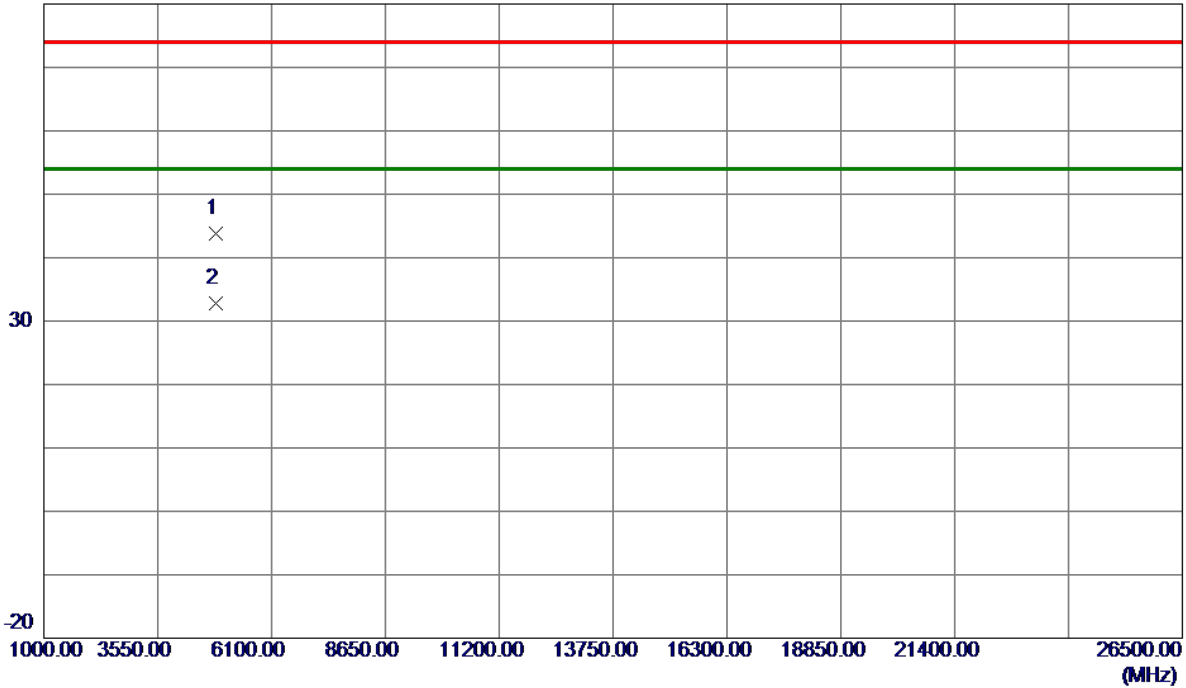

No.	Freq. MHz	Reading Level dBuV/m	Correct Factor dB	Measure ment dBuV/m	Limit dBuV/m	Margin dB	Detector	Comment
1	4843.2910	39.33	4.50	43.83	74.00	-30.17	Peak	
2 *	4844.9190	28.29	4.51	32.80	54.00	-21.20	AVG	

REMARKS:

- (1) Measurement Value = Reading Level + Correct Factor.
- (2) Margin Level = Measurement Value - Limit Value.

Test Mode	TX AX(HE40) Mode 2437 MHz	Polarization	Vertical
-----------	---------------------------	--------------	----------

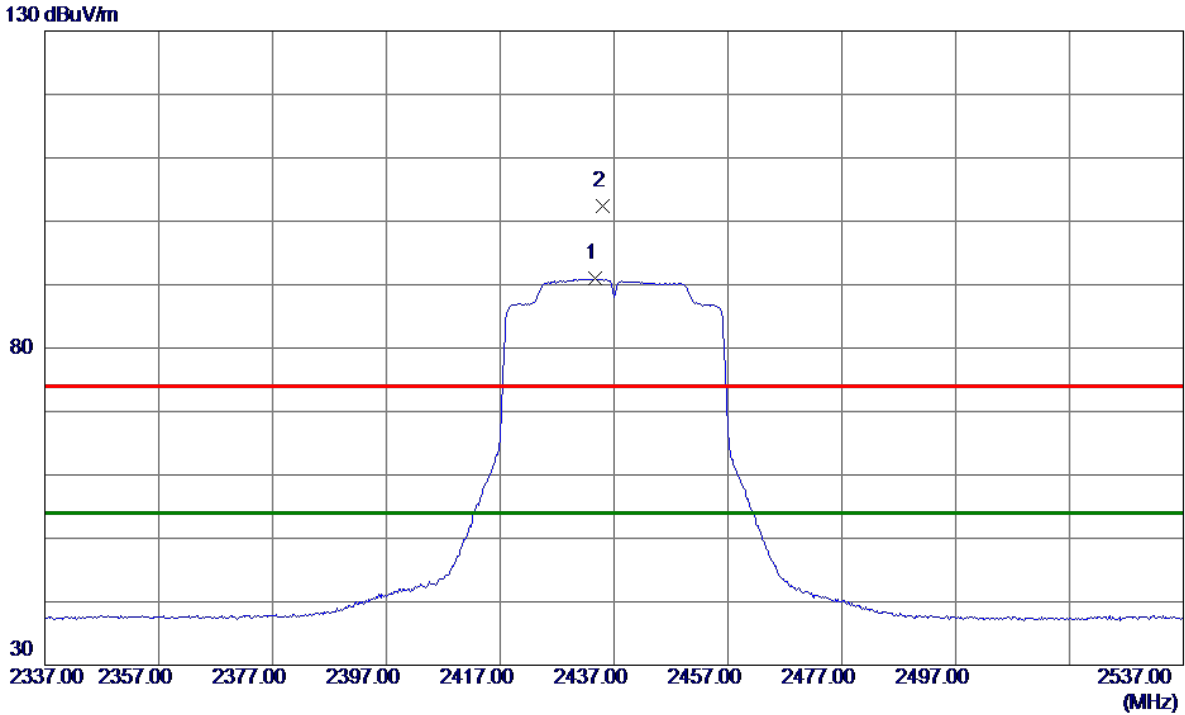

No.	Freq. MHz	Reading Level dBuV/m	Correct Factor dB	Measure ment dBuV/m	Limit dBuV/m	Margin dB	Detector	Comment
1 *	2433.6000	83.67	7.25	90.92	54.00	36.92	AVG	No Limit
2	2435.0000	95.07	7.25	102.32	74.00	28.32	Peak	No Limit

REMARKS:

- (1) Measurement Value = Reading Level + Correct Factor.
- (2) Margin Level = Measurement Value - Limit Value.

Test Mode	TX AX(HE40) Mode 2437 MHz	Polarization	Vertical
-----------	---------------------------	--------------	----------

80 dBuV/m

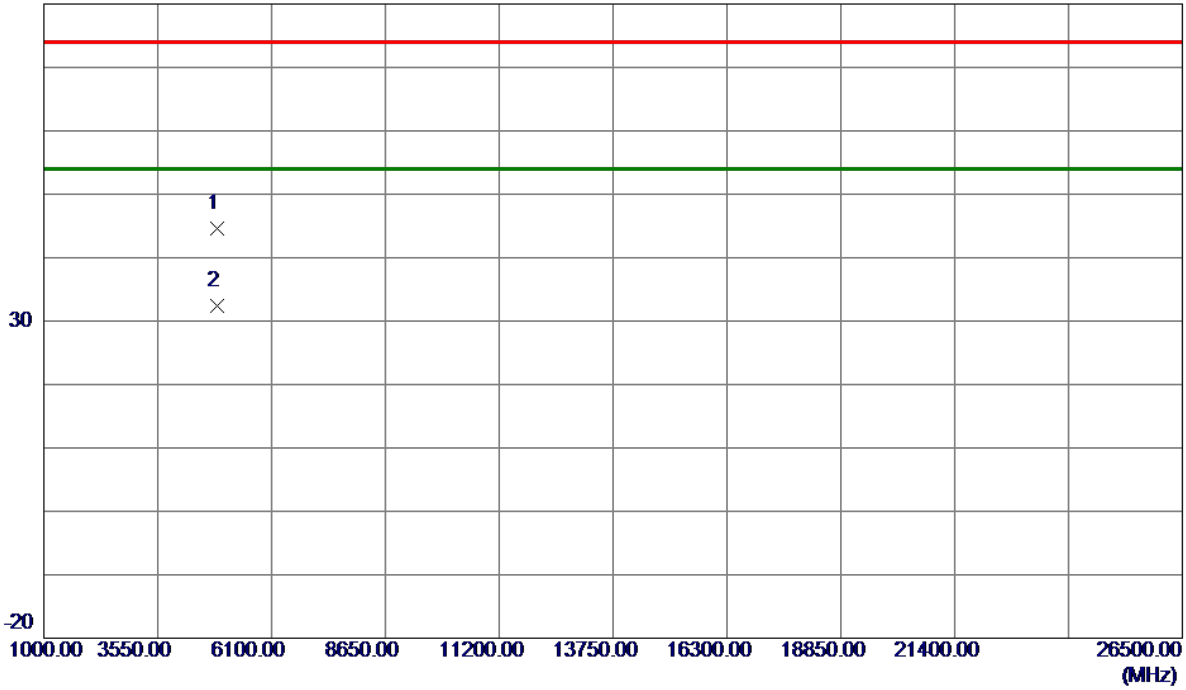

No.	Freq. MHz	Reading Level dBuV/m	Correct Factor dB	Measure ment dBuV/m	Limit dBuV/m	Margin dB	Detector	Comment
1	4874.2050	39.95	4.58	44.53	74.00	-29.47	Peak	
2 *	4874.8340	27.83	4.59	32.42	54.00	-21.58	AVG	

REMARKS:

- (1) Measurement Value = Reading Level + Correct Factor.
- (2) Margin Level = Measurement Value - Limit Value.

Test Mode	TX AX(HE40) Mode 2437 MHz	Polarization	Horizontal
-----------	---------------------------	--------------	------------

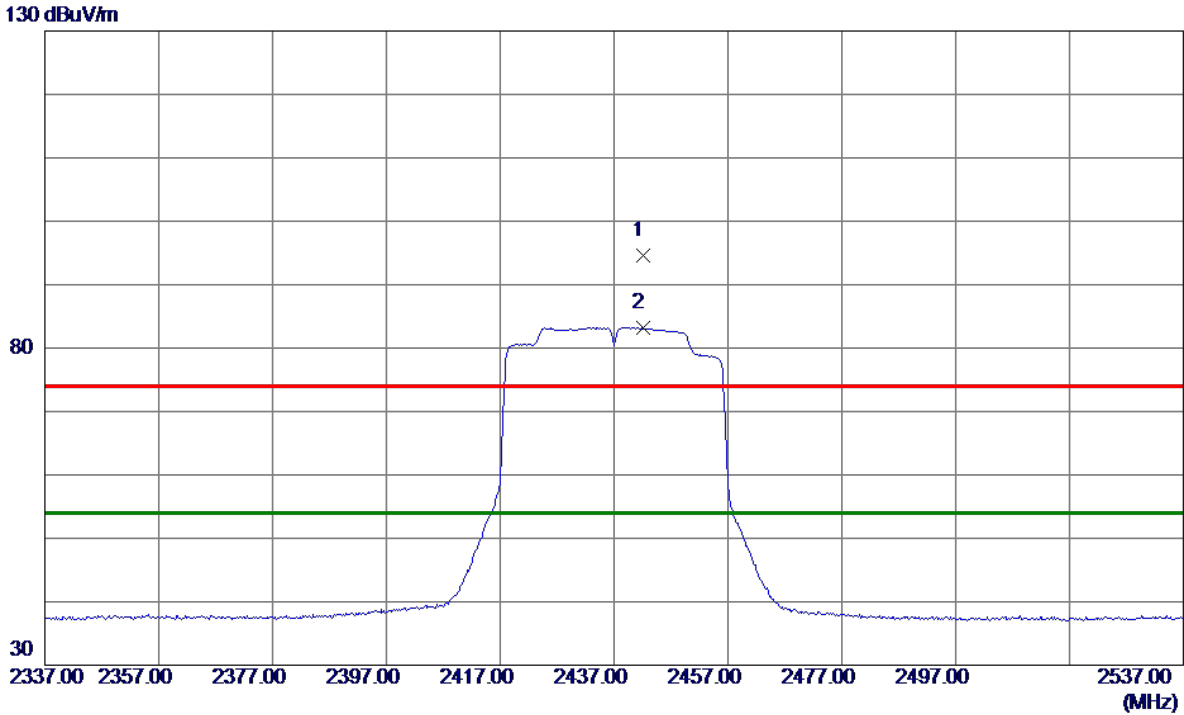

No.	Freq. MHz	Reading Level dBuV/m	Correct Factor dB	Measure ment dBuV/m	Limit dBuV/m	Margin dB	Detector	Comment
1	2442.0000	87.27	7.25	94.52	74.00	20.52	Peak	No Limit
2 *	2442.0000	75.97	7.25	83.22	54.00	29.22	AVG	No Limit

REMARKS:

- (1) Measurement Value = Reading Level + Correct Factor.
- (2) Margin Level = Measurement Value - Limit Value.

Test Mode	TX AX(HE40) Mode 2437 MHz	Polarization	Horizontal
-----------	---------------------------	--------------	------------

80 dBuV/m

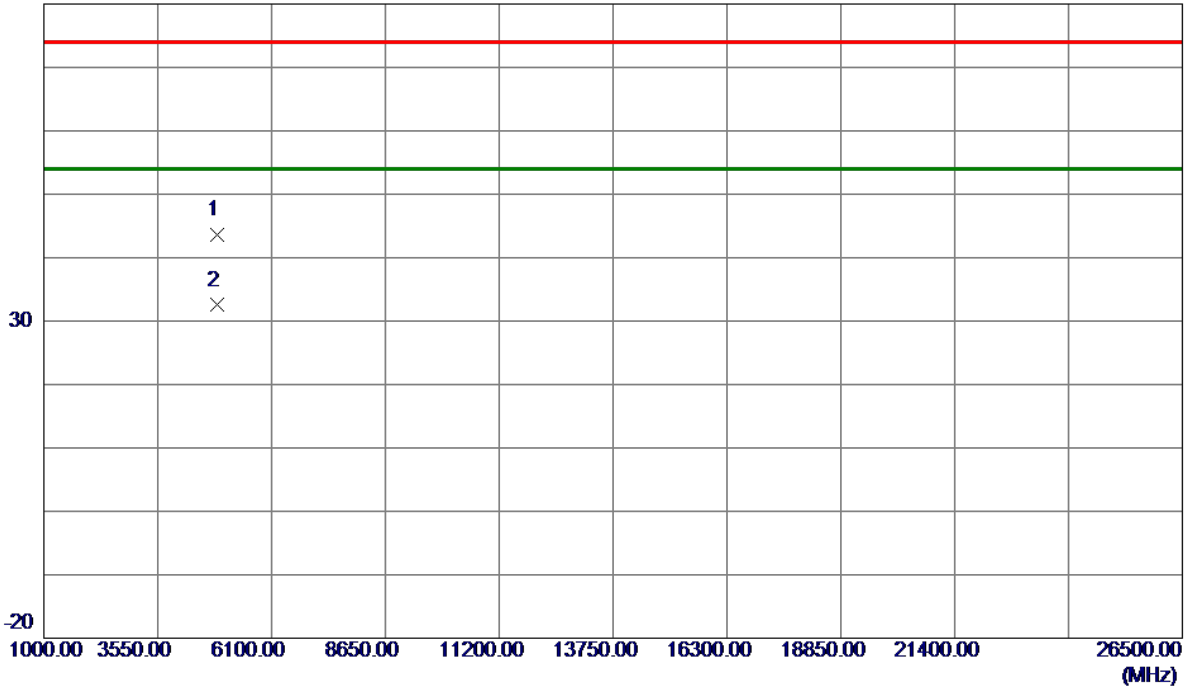

No.	Freq. MHz	Reading Level dBuV/m	Correct Factor dB	Measure ment dBuV/m	Limit dBuV/m	Margin dB	Detector	Comment
1	4873.5160	38.98	4.58	43.56	74.00	-30.44	Peak	
2 *	4874.6150	27.91	4.59	32.50	54.00	-21.50	AVG	

REMARKS:

- (1) Measurement Value = Reading Level + Correct Factor.
- (2) Margin Level = Measurement Value - Limit Value.

Test Mode	TX AX(HE40) Mode 2452 MHz	Polarization	Vertical
-----------	---------------------------	--------------	----------

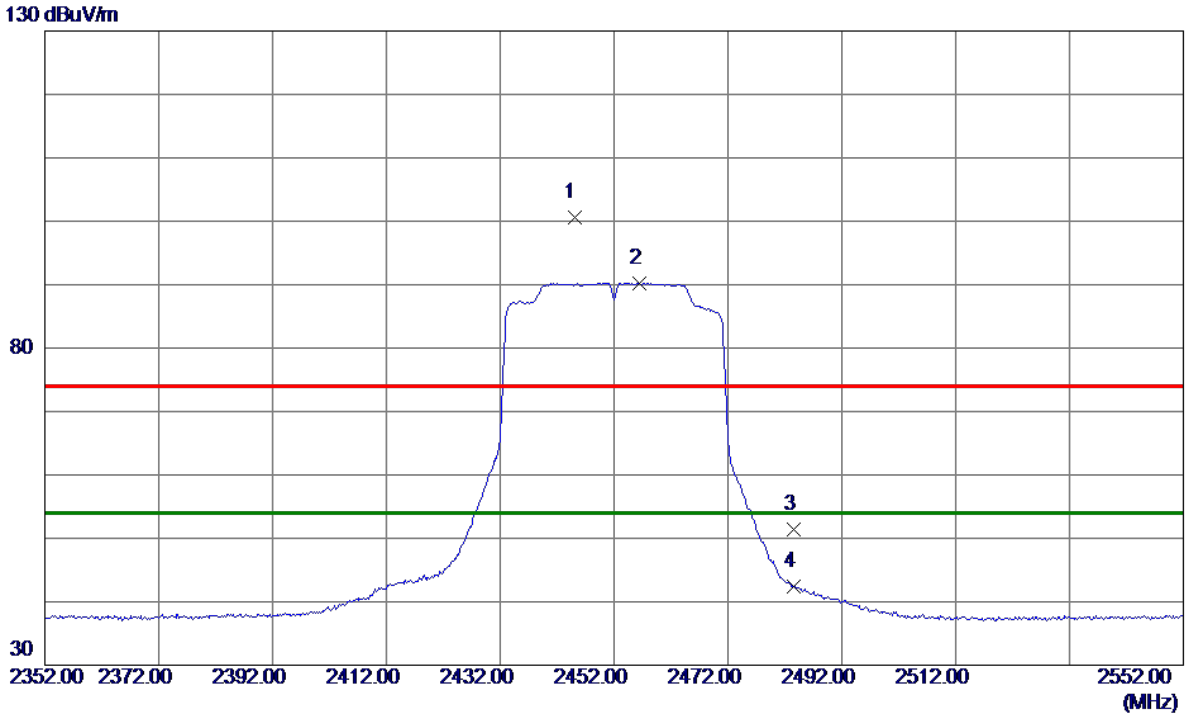

No.	Freq. MHz	Reading Level dBuV/m	Correct Factor dB	Measure ment dBuV/m	Limit dBuV/m	Margin dB	Detector	Comment
1	2445.0000	93.39	7.25	100.64	74.00	26.64	Peak	No Limit
2 *	2456.4000	83.03	7.25	90.28	54.00	36.28	AVG	No Limit
3	2483.5000	44.22	7.25	51.47	74.00	-22.53	Peak	
4	2483.5000	35.09	7.25	42.34	54.00	-11.66	AVG	

REMARKS:

- (1) Measurement Value = Reading Level + Correct Factor.
- (2) Margin Level = Measurement Value - Limit Value.

Test Mode	TX AX(HE40) Mode 2452 MHz	Polarization	Vertical
-----------	---------------------------	--------------	----------

80 dBuV/m

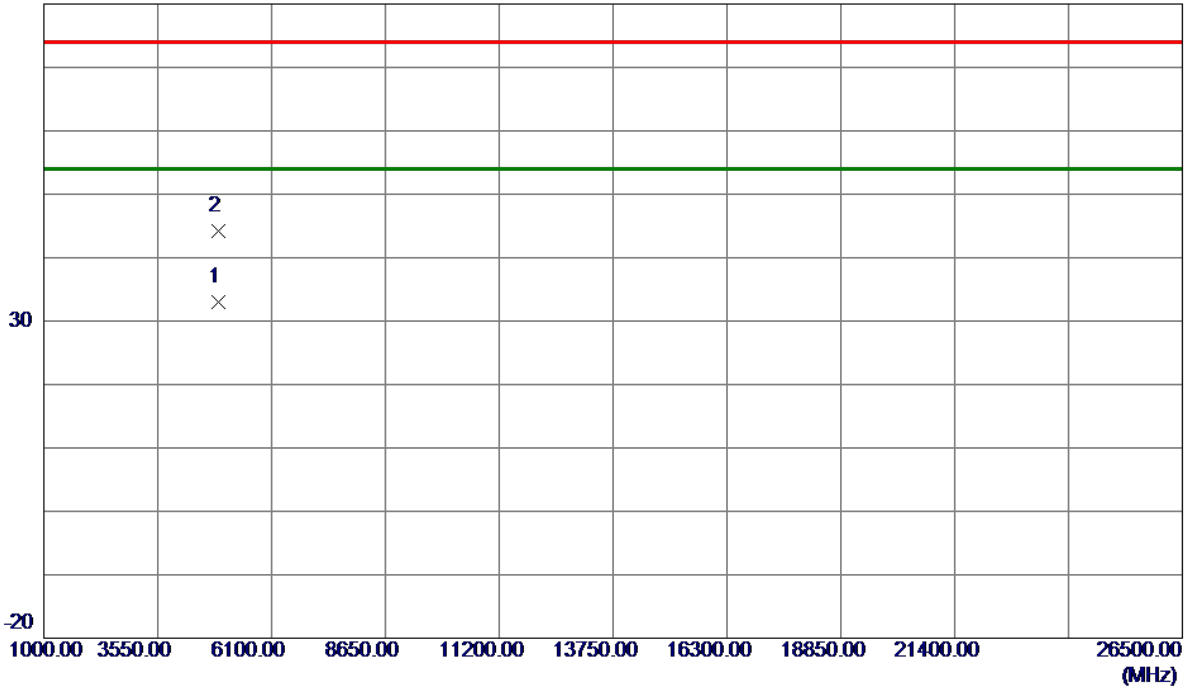

No.	Freq. MHz	Reading Level dBuV/m	Correct Factor dB	Measure ment dBuV/m	Limit dBuV/m	Margin dB	Detector	Comment
1 *	4904.6600	28.33	4.67	33.00	54.00	-21.00	AVG	
2	4904.6780	39.45	4.67	44.12	74.00	-29.88	Peak	

REMARKS:

- (1) Measurement Value = Reading Level + Correct Factor.
- (2) Margin Level = Measurement Value - Limit Value.

Test Mode	TX AX(HE40) Mode 2452 MHz	Polarization	Horizontal
-----------	---------------------------	--------------	------------

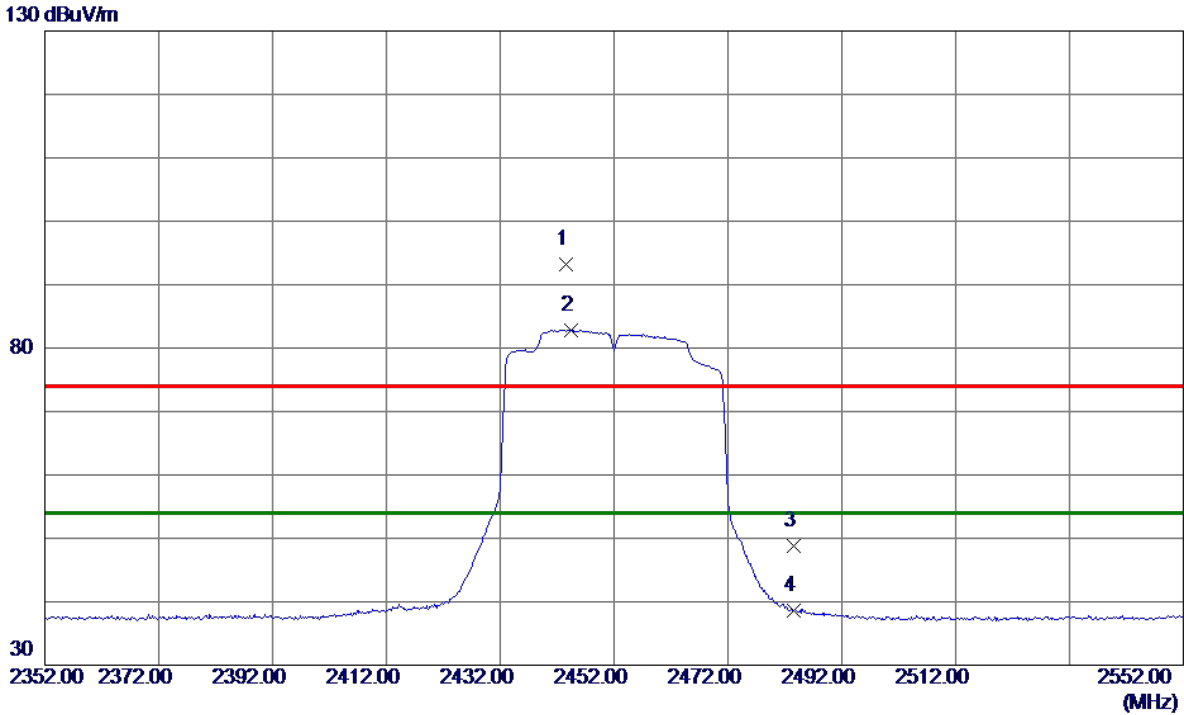

No.	Freq. MHz	Reading Level dBuV/m	Correct Factor dB	Measure ment dBuV/m	Limit dBuV/m	Margin dB	Detector	Comment
1	2443.6000	85.95	7.25	93.20	74.00	19.20	Peak	No Limit
2 *	2444.4000	75.61	7.25	82.86	54.00	28.86	AVG	No Limit
3	2483.5000	41.63	7.25	48.88	74.00	-25.12	Peak	
4	2483.5000	31.37	7.25	38.62	54.00	-15.38	AVG	

REMARKS:

- (1) Measurement Value = Reading Level + Correct Factor.
- (2) Margin Level = Measurement Value - Limit Value.

Test Mode	TX AX(HE40) Mode 2452 MHz	Polarization	Horizontal
-----------	---------------------------	--------------	------------

80 dBuV/m

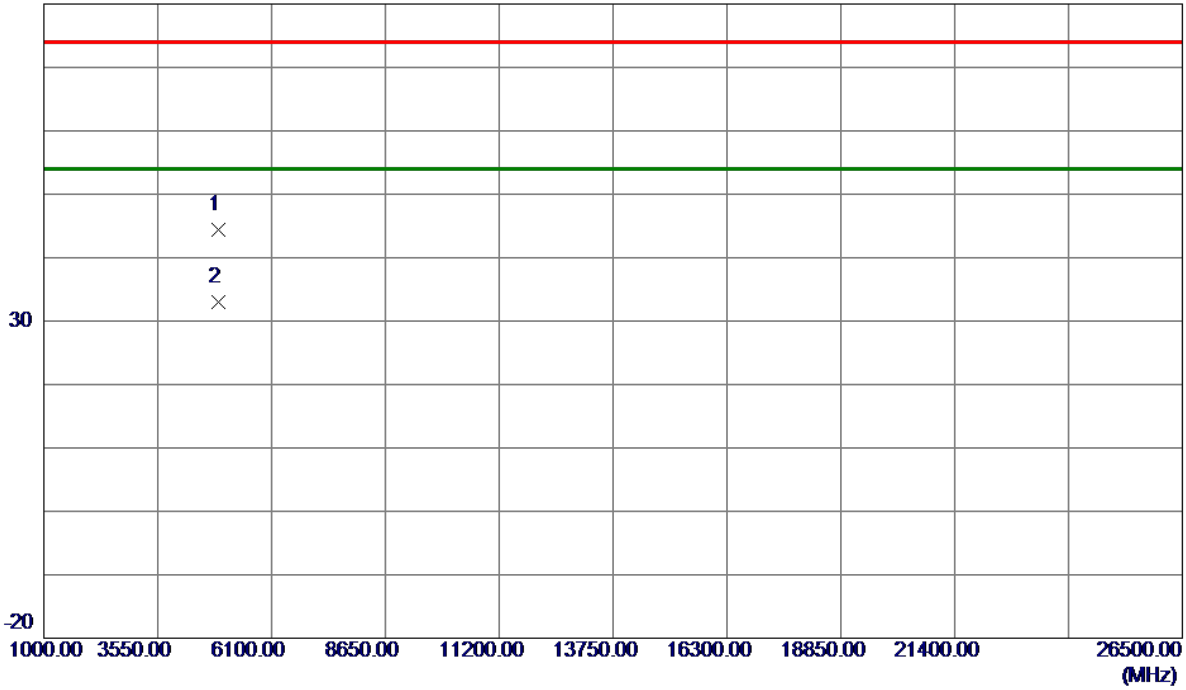

No.	Freq. MHz	Reading Level dBuV/m	Correct Factor dB	Measure ment dBuV/m	Limit dBuV/m	Margin dB	Detector	Comment
1	4903.4680	39.75	4.66	44.41	74.00	-29.59	Peak	
2 *	4903.6200	28.42	4.66	33.08	54.00	-20.92	AVG	

REMARKS:

- (1) Measurement Value = Reading Level + Correct Factor.
- (2) Margin Level = Measurement Value - Limit Value.

End of Test Report