

# FCC Radio Test Report

## FCC ID: RWO-RZ090281

This report concerns (check one):  Original Grant  Class I Change  Class II Change

**Project No.** : 1809C163  
**Equipment** : Notebook  
**Test Model** : RZ09-0281  
**Series Model** : RZ09-028  
**Applicant** : Razer Inc.  
**Address** : 201 3rd Street, Suite 900, San Francisco, CA 94103,  
USA

**Date of Receipt** : Sep. 26, 2018  
**Date of Test** : Sep. 29, 2018 ~ Oct. 26, 2018  
**Issued Date** : Nov. 21, 2018  
**Tested by** : BTL Inc.

**Testing Engineer** : Welly Zhou  
(Welly Zhou)

**Technical Manager** : Shawn Xiao  
(Shawn Xiao)

**Authorized Signatory** : Steven Lu  
(Steven Lu)

# **B T L I N C .**

No.3, Jinshagang 1st Road, Shixia, Dalang Town, Dongguan,  
Guangdong, China.

TEL: +86-769-8318-3000 FAX: +86-769-8319-6000



Certificate #5123.02

### **Declaration**

**BTL** represents to the client that testing is done in accordance with standard procedures as applicable and that test instruments used has been calibrated with standards traceable to international standard(s) and/or national standard(s).

**BTL's** reports apply only to the specific samples tested under conditions. It is manufacture's responsibility to ensure that additional production units of this model are manufactured with the identical electrical and mechanical components. **BTL** shall have no liability for any declarations, inferences or generalizations drawn by the client or others from **BTL** issued reports.

The report must not be used by the client to claim product certification, approval, or endorsement by NVLAP, NIST, or any agency of the U.S. Government.

This report is the confidential property of the client. As a mutual protection to the clients, the public and ourselves, the test report shall not be reproduced, except in full, without our written approval.

**BTL's** laboratory quality assurance procedures are in compliance with the **ISO Guide 17025** requirements, and accredited by the conformity assessment authorities listed in this test report.

**BTL** is not responsible for the sampling stage, so the results only apply to the sample as received.

The information, data and test plan are provided by manufacturer, so it is manufacturer's responsibility to ensure that the apparatus meets the essential requirements in all the possible configurations as representative of its intended use.

### **Limitation**

For the use of the authority's logo is limited unless the Test Standard(s)/Scope(s)/Item(s) mentioned in this test report is (are) included in the conformity assessment authorities acceptance respective.

**Table of Contents****Page**

<b>1 . CERTIFICATION</b>	<b>5</b>
<b>2 . EUT INFORMATION</b>	<b>6</b>
2.1 EUT SPECIFICATION TABLE	6
2.2 CONDUCTED OUTPUT POWER AND EIRP	8
<b>3 . U-NII DFS RULE REQUIREMENTS</b>	<b>9</b>
3.1 WORKING MODES AND REQUIRED TEST ITEMS	9
3.2 TEST FACILITY	9
3.3 TEST LIMITS AND RADAR SIGNAL PARAMETERS	10
<b>4 . TEST INSTRUMENTS</b>	<b>13</b>
<b>5 . EMC EMISSION TEST</b>	<b>14</b>
5.1 DFS MEASUREMENT SYSTEM:	14
5.2 CALIBRATION OF DFS DETECTION THRESHOLD LEVEL:	19
5.3 DEVIATION FROM TEST STANDARD	19
<b>6 . TEST RESULTS</b>	<b>20</b>
6.1 SUMMARY OF TEST RESULT	20
6.2 DFS DETECTION THRESHOLD	20
6.3 CHANNEL CLOSING TRANSMISSION AND CHANNEL MOVE TIME WLAN TRAFFIC	21
6.4 NON- OCCUPANCY PERIOD	26

### REPORT ISSUED HISTORY

Report Version	Description	Issued Date
R00	Original Issue.	Nov. 21, 2018

## 1. CERTIFICATION

Equipment : Notebook  
Brand Name : RAZER  
Test Model : RZ09-0281  
Series Model : RZ09-028  
Applicant : Razer Inc.  
Manufacturer : Razer Inc.  
Address : 201 3rd Street, Suite 900, San Francisco, CA 94103, USA  
Date of Test : Sep. 29, 2018 ~ Oct. 26, 2018  
Test Sample : Engineering Sample No.: D180908791  
Standard(s) : FCC Part 15, Subpart E (Section 15.407) / FCC 06-96  
FCC KDB 789033 D02 General U-NII Test Procedures New Rules v02r01  
FCC KDB 905462 D02 UNII DFS Compliance Procedures New Rules v02  
FCC KDB 905462 D03 UNII Clients Without Radar Detection New Rules  
v01r02

The above equipment has been tested and found compliance with the requirement of the relative standards by BTL Inc.

The test data, data evaluation, and equipment configuration contained in our test report (Ref No. BTL-FCCP-5-1809C163) were obtained utilizing the test procedures, test instruments, test sites that has been accredited by the Authority of A2LA according to the ISO-17025 quality assessment standard and technical standard(s).

**Test results included in this report is only for the DFS part.**

## 2. EUT INFORMATION

### 2.1 EUT SPECIFICATION TABLE

Table 1: Specification of EUT

<b>Equipment</b>	Notebook
<b>Brand Name</b>	RAZER
<b>Test Model</b>	RZ09-0281
<b>Series Model</b>	RZ09-028
<b>Model Difference(s)</b>	RZ09-0281 uses an independent graphics card and RZ09-028 uses an integrated graphics card.
<b>Software Version</b>	Windows 10
<b>Hardware Version</b>	N13RW2_MB
<b>Operational Mode</b>	Slave
<b>Operating Frequency Range</b>	5250MHz~5350MHz&5470MHz~5725MHz
<b>Modulation</b>	OFDM

**Note:** This device was functioned as a

Master    Slave Without Radar Detection    slave with rada detection

Note:

1. For a more detailed features description, please refer to the manufacturer's specifications or the user's manual.

802.11a 802.11n 20 MHz 802.11ac 20 MHz		802.11n 40 MHz 802.11ac 40 MHz		802.11ac 80 MHz	
UNII-2A		UNII-2A		UNII-2A	
Channel	Frequency (MHz)	Channel	Frequency (MHz)	Channel	Frequency (MHz)
52	5260	54	5270	58	5290
56	5280	62	5310		
60	5300				
64	5320				

802.11a 802.11n 20 MHz 802.11ac 20 MHz		802.11n 40 MHz 802.11ac 40 MHz		802.11ac 80 MHz	
UNII-2C		UNII-2C		UNII-2C	
Channel	Frequency (MHz)	Channel	Frequency (MHz)	Channel	Frequency (MHz)
100	5500	102	5510	106	5530
104	5520	110	5550	122	5610
108	5540	118	5590		
112	5560	126	5630		
116	5580	134	5670		
132	5660				
136	5680				
140	5700				

802.11ac (160 MHz)	
Channel	Frequency (MHz)
114	5570

2. Antenna Specification:

Ant.	Brand	P/N	Antenna Type	Connector	Gain (dBi)
1	ATC	BY5780-16-002-C	PIFA	IPEX	4.99
2	ATC	BY5780-16-001-C	PIFA	IPEX	4.60

Note:

(1) EUT incorporates a MIMO function. Physically, the EUT provides two completed transmitters and receivers (2T2R), all transmit signals are completely correlated, so Directional gain =  $10\log[(10^{G1/20} + 10^{G2/20} + \dots + 10^{GN/20})^2 / N]$  dBi, that is

$$\text{Directional gain} = 10\log[(10^{4.99/20} + 10^{4.60/20})^2 / 2] \text{ dBi} = 7.81.$$

So, the UNII-1, UNII-2A, UNII-2C out power limit is  $24 - 7.81 + 6 = 22.19$ , the UNII-3 out power limit is  $30 - 7.81 + 6 = 28.19$ . the UNII-1, UNII-2A, UNII-2C power density limit is  $11 - 7.81 + 6 = 9.19$ , the UNII-3 power density limit is  $30 - 7.81 + 6 = 28.19$ .

## 2.2 CONDUCTED OUTPUT POWER AND EIRP

Table 2: The Conducted Output Power and EIRP List

Mode: TX (11 ac 20MHz)				
Frequency Band (MHz)	Max Couducted Output Power (dBm)	Directional Gain	Max EIRP (dBm)	Max EIRP (mW)
5250~5350	19.11	7.81	26.92	492.040
5470~5725	18.99	7.81	26.80	478.630

Mode: TX (11ac 40MHz)				
Frequency Band (MHz)	Max Couducted Output Power (dBm)	Directional Gain	Max EIRP (dBm)	Max EIRP (mW)
5250~5350	18.33	7.81	26.14	411.150
5470~5725	18.39	7.81	26.20	416.869

Mode: TX (11ac 80MHz)				
Frequency Band (MHz)	Max Couducted Output Power (dBm)	Directional Gain	Max EIRP (dBm)	Max EIRP (mW)
5250~5350	16.98	7.81	24.79	301.300
5470~5725	17.13	7.81	24.94	311.889

Mode: TX (11ac 160MHz)				
Frequency Band (MHz)	Max Couducted Output Power (dBm)	Directional Gain	Max EIRP (dBm)	Max EIRP (mW)
5470~5725	16.82	7.81	24.63	290.402



### 3. U-NII DFS RULE REQUIREMENTS

#### 3.1 WORKING MODES AND REQUIRED TEST ITEMS

The manufacturer shall state whether the EUT is capable of operating as a Master and/or a Client. If the EUT is capable of operating in more than one operating mode then each operating mode shall be tested separately. See tables 3 and 4 for the applicability of DFS requirements for each of the operational modes.

Table 3: Applicability of DFS requirements prior to use a channel

Requirement	Operational Mode		
	Master	Client without radar detection	Client with radar detection
Non-Occupancy Period	✓	✓	✓
DFS Detection Threshold	✓	Not required	✓
Channel Availability Check Time	✓	Not required	Not required
Uniform Spreading	✓	Not required	Not required
U-NII Detection Bandwidth	✓	Not required	✓

Table 4: Applicability of DFS requirements during normal operation.

Requirement	Operational Mode		
	Master	Client without radar detection	Client with radar detection
DFS Detection Threshold	✓	Not required	✓
Channel Closing Transmission Time	✓	✓	✓
Channel Move Time	✓	✓	✓
U-NII Detection Bandwidth	✓	Not required	✓

#### 3.2 TEST FACILITY

The test facilities used to collect the test data in this report is at the location of No.3, Jinshagang 1st Road, Shixia, Dalang Town, Dongguan, Guangdong, China.

BTL's test firm number for FCC: 854385

BTL's designation number for FCC: CN5020

### 3.3 TEST LIMITS AND RADAR SIGNAL PARAMETERS

#### DETECTION THRESHOLD VALUES

Table 5: DFS Detection Thresholds for Master Devices and Client Devices With Radar Detection.

Maximum Transmit Power	Value (See Notes 1 and 2)
EIRP $\geq$ 200 milliwatt	-64 dBm
EIRP < 200 milliwatt and Power spectral density < 10 dB/MHz	-62 dBm
EIRP < 200 milliwatt that do not meet the power spectral density requirement	-64 dBm

**Note 1:** This is the level at the input of the receiver assuming a 0 dBi receive antenna.

**Note 2:** Throughout these test procedures an additional 1 dB has been added to the amplitude of the test transmission waveforms to account for variations in measurement equipment. This will ensure that the test signal is at or above the detection threshold level to trigger a DFS response.

**Note3:** EIRP is based on the highest antenna gain. For MIMO devices refer to KDB Publication 662911 D01.

Table 6: DFS Response Requirement Values

Parameter	Value
Non-occupancy period	Minimum 30 minutes
Channel Availability Check Time	60 seconds
Channel Move Time	10 seconds See Note 1.
Channel Closing Transmission Time	200 milliseconds + an aggregate of 60 milliseconds over remaining 10 second period. See Notes 1 and 2.
U-NII Detection Bandwidth	Minimum 100% of the UNII 99% transmission power bandwidth. See Note 3.

**Note 1:** Channel Move Time and the Channel Closing Transmission Time should be performed with Radar Type 0. The measurement timing begins at the end of the Radar Type 0 burst.

**Note 2:** The Channel Closing Transmission Time is comprised of 200 milliseconds starting at the beginning of the Channel Move Time plus any additional intermittent control signals required to facilitate a Channel move (an aggregate of 60 milliseconds) during the remainder of the 10 second period. The aggregate duration of control signals will not count quiet periods in between transmissions.

**Note 3:** During the U-NII Detection Bandwidth detection test, radar type 0 should be used. For each frequency step the minimum percentage of detection is 90 percent. Measurements are performed with no data traffic.

## PARAMETERS OF DFS TEST SIGNALS

Step intervals of 0.1 microsecond for Pulse Width, 1 microsecond for PRI, 1 MHz for chirp width and 1 for the number of pulses will be utilized for the random determination of specific test waveforms.

Table 7: Short Pulse Radar Test Waveforms.

Radar Type	Pulse Width (μsec)	PRI (μsec)	Number of Pulses	Minimum Percentage of Successful Detection	Minimum Number of Trials
0	1	1428	18	See Note 1	See Note 1
1	1	Test A: 15 unique PRI values randomly selected from the list of 23 PRI values in Table 5a	Roundup $\left\{ \begin{array}{l} \left( \frac{1}{360} \right) \cdot \\ \left( \frac{19 \cdot 10^6}{\text{PRI}_{\mu\text{sec}}} \right) \end{array} \right\}$	60%	30
		Test B: 15 unique PRI values randomly selected within the range of 518-3066 μsec, with a minimum increment of 1 μsec, excluding PRI values selected in Test A			
2	1-5	150-230	23-29	60%	30
3	6-10	200-500	16-18	60%	30
4	11-20	200-500	12-16	60%	30
Aggregate (Radar Types 1-4)				80%	120
<b>Note 1:</b> Short Pulse Radar Type 0 should be used for the detection bandwidth test, channel move time, and channel closing time tests.					

A minimum of 30 unique waveforms are required for each of the Short Pulse Radar Types 2 through 4. If more than 30 waveforms are used for Short Pulse Radar Types 2 through 4, then each additional waveform must also be unique and not repeated from the previous waveforms. If more than 30 waveforms are used for Short Pulse Radar Type 1, then each additional waveform is generated with Test B and must also be unique and not repeated from the previous waveforms in Tests A or B.

Table 8: Long Pulse Radar Test Waveform

Radar Type	Pulse Width (μsec)	Chirp Width (MHz)	PRI (μsec)	Number of Pulses per Burst	Number of Bursts	Minimum Percentage of Successful Detection	Minimum Number of Trials
5	50-100	5-20	1000-2000	1-3	8-20	80%	30

The parameters for this waveform are randomly chosen (The center frequency for each of the 30 trials of the Bin 5 radar shall be randomly selected within 80% of the Occupied Bandwidth.) Thirty unique waveforms are required for the Long Pulse Radar Type waveforms. If more than 30 waveforms are used for the Long Pulse Radar Type waveforms, then each additional waveform must also be unique and not repeated from the previous waveforms.

Table 9: Frequency Hopping Radar Test Waveform

Radar Type	Pulse Width (μsec)	Chirp Width (MHz)	PRI (μsec)	Number of Pulses per Burst	Number of Bursts	Minimum Percentage of Successful Detection	Minimum Number of Trials
6	1	333	9	0.333	300	70%	30

#### 4. TEST INSTRUMENTS

Table 10: Test instruments list.

DESCRIPTION	MANUFACTURER	MODEL NO.	Serial No	Calibration Until
EXA Spectrum Analyzer	Agilent	N9010A	MY50520044	Mar. 11, 2019
Signal Generator	Agilent	E4438C	MY49071316	Mar. 11, 2019
POWER SPLITTER	Mini-Circuits	ZFRSC-123-S+	331000910-1	Mar. 11, 2019
POWER SPLITTER	Mini-Circuits	ZN4PD1-63-S+	SF9335D1045-1	Mar. 11, 2019
Attenuator	WOKEN	6SM3502	VAS1214NL	Feb. 14, 2019
Master Device	HUAWEI	AP6150DN	N/A	N/A

Note:

- (1) Calibration interval of instruments listed above is one year.
- (2) Master device's FCC ID: QISAP6050DN6150DN

## 5. EMC EMISSION TEST

### 5.1 DFS MEASUREMENT SYSTEM:

#### Test Procedure

1. Master device and client device are set up by conduction method as the following configuration.
2. The client device is connected to notebook and to access a IP address on wireless connection with the master device.
3. Then the master device is connected to another notebook to access a IP address.
4. Finally, let the two IP addresses run traffic with each other through the Run flow software “Lan test” to reach 17% channel loading as below

#### Setup

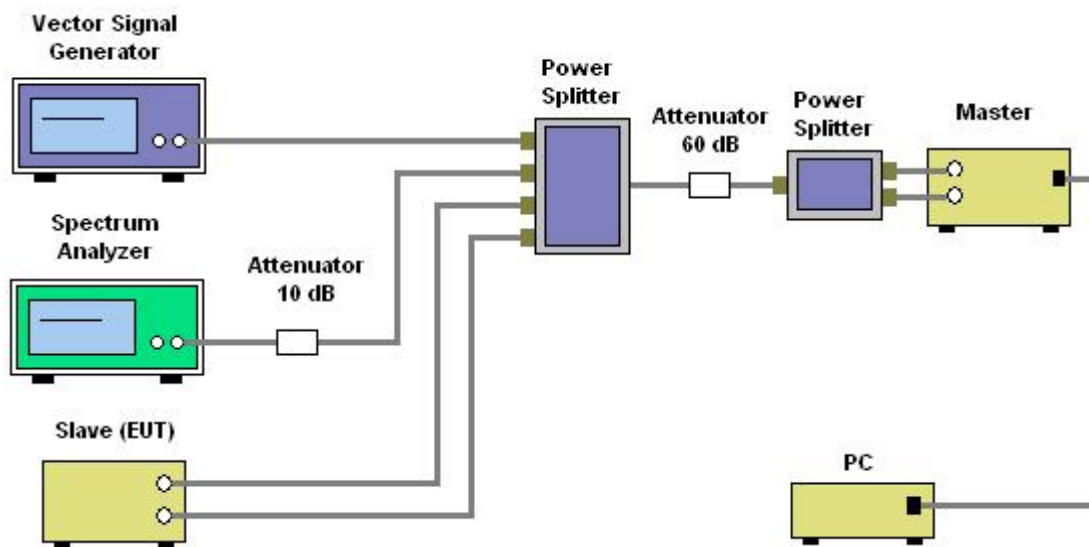

**Channel Loading**

**11ac 20Mode**

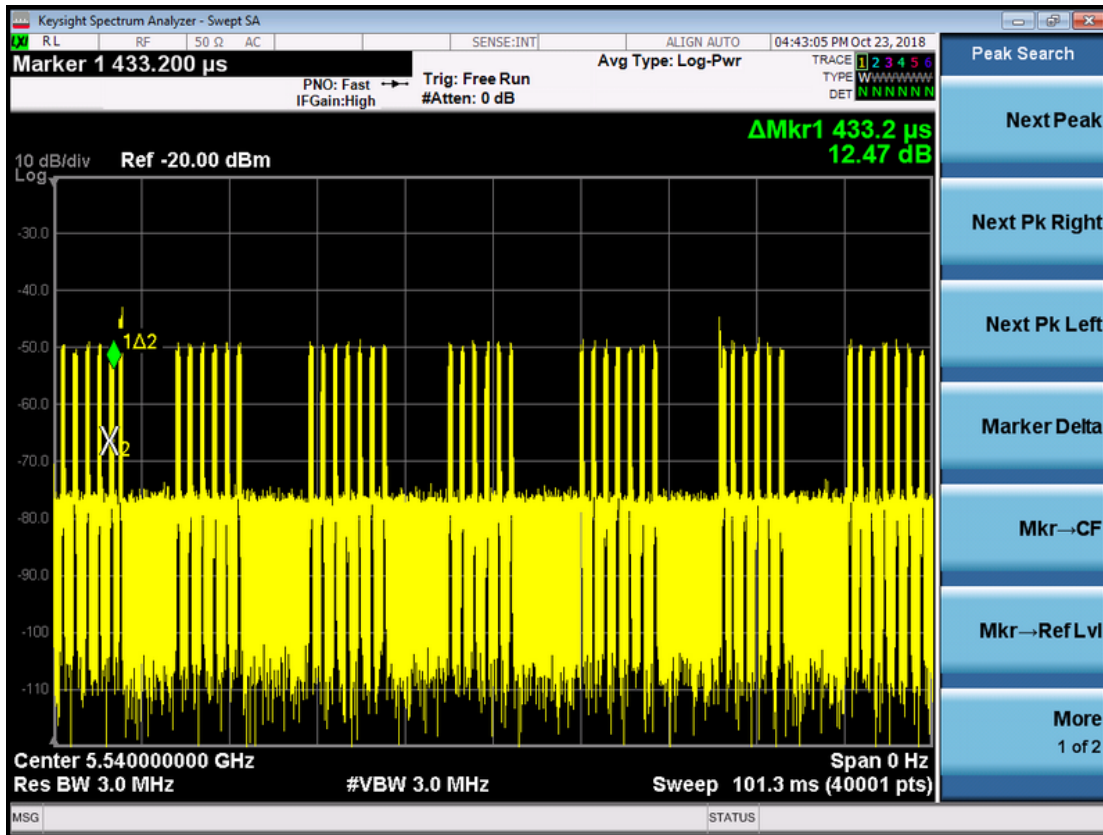

**11ac 40MHz Mode**

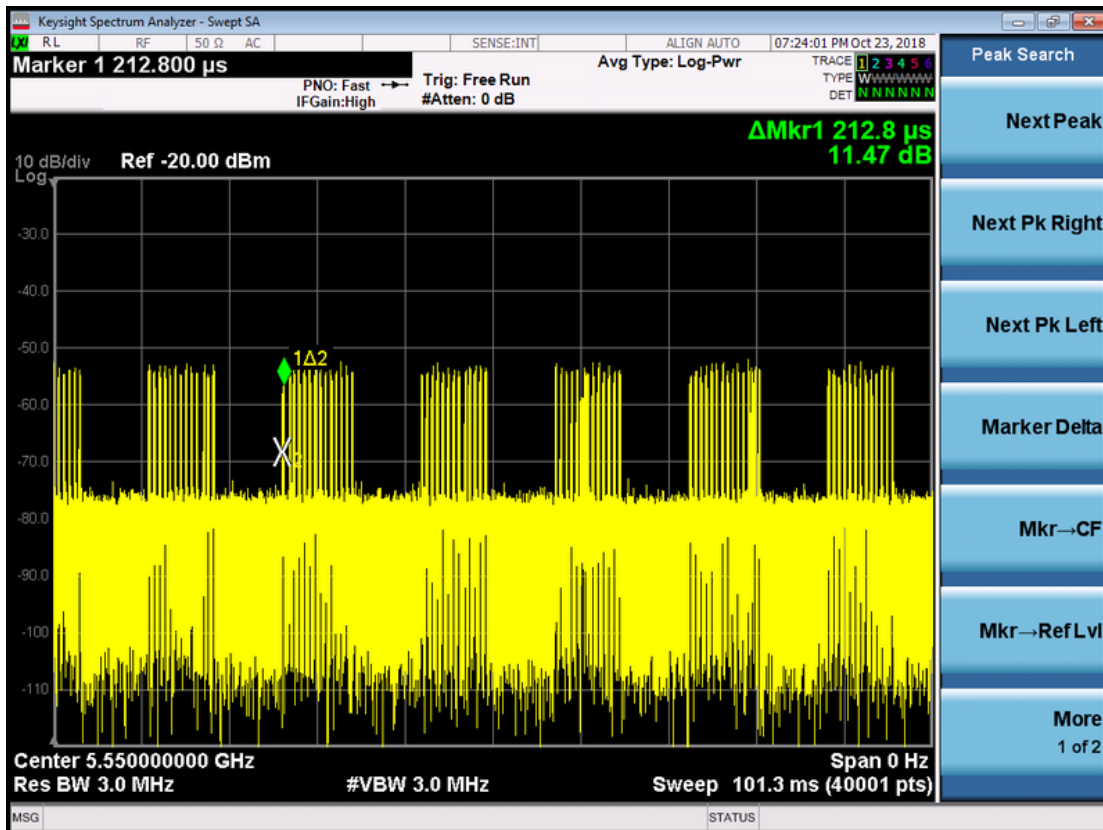

### 11ac 80MHz Mode

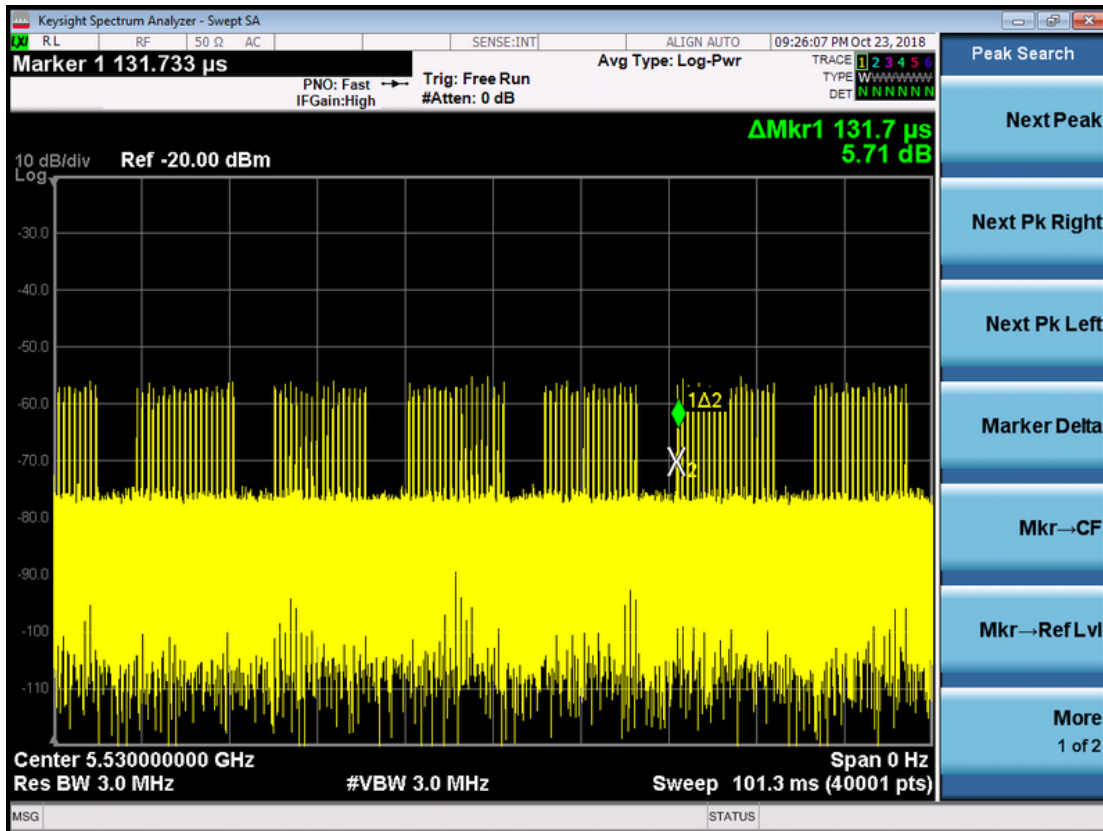

### 11ac 160MHz Mode

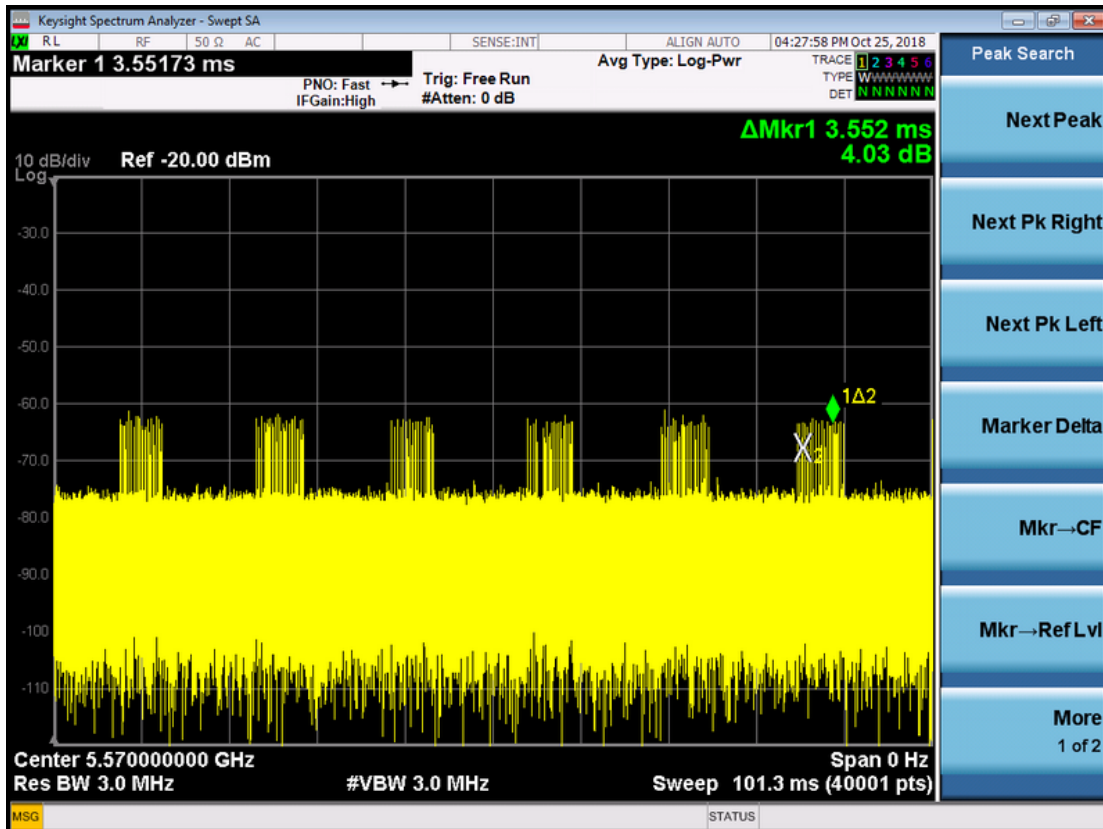



Channel	Marker Delta	Number	On Time	Total Time	Dutycycle (%)	Limit (%)
5540	0.4332	40	17.328	101.3	17.11	17.00
5550	0.2128	90	19.152	101.3	18.91	17.00
5530	0.1317	135	17.7795	101.3	17.55	17.00
5570	3.5520	6	21.312	101.3	21.04	17.00

The hopping type 6 pulse parameters are fixed while the hopping sequence is based on the August 2005 NTIA Hopping Frequency List. The initial starting point randomized at run-time and each subsequent starting point is incremented by 475. Each frequency in the 100-length segment is compared to the boundaries of the EUT Detection Bandwidth and the software creates a hopping burst pattern in accordance with Section 7.4.1.3 Method #2 Simulated Frequency Hopping Radar Waveform Generating Subsystem of FCC 06-96. The frequency of the signal generator is incremented in 1 MHz steps from FL to FH for each successive trial. This incremental sequence is repeated as required to generate a minimum of 30 total trials and to maintain a uniform frequency distribution over the entire Detection Bandwidth.

The signal monitoring equipment consists of a spectrum analyzer set to display 8001 bins on the horizontal axis. The time-domain resolution is 2 msec / bin with a 16 second sweep time, meeting the 10 second short pulse reporting criteria. The aggregate ON time is calculated by multiplying the number of bins above a threshold during a particular observation period by the dwell time per bin, with the analyzer set to peak detection and max hold.

Should multiple RF ports be utilized for the Master and/or Slave devices (for example, for diversity or MIMO implementations), additional combiner/dividers are inserted between the Master Combiner/Divider and the pad connected to the Master Device (and/or between the Slave Combiner/Divider and the pad connected to the Slave Device). Additional pads are utilized such that there is one pad at each RF port on each EUT.

**5.2 CALIBRATION OF DFS DETECTION THRESHOLD LEVEL:**

A 50 ohm load is connected in place of the spectrum analyzer, and the spectrum analyzer is connected in place of the master device and the signal generator is set to CW mode. The amplitude of the signal generator is adjusted to yield a level of -62 dBm as measured on the spectrum analyzer.

Without changing any of the instrument settings, the spectrum analyzer is reconnected to the Common port of the Spectrum Analyzer Combiner/Divider. Measure the amplitude and calculate the difference from -62 dBm. Adjust the Reference Level Offset of the spectrum analyzer to this difference.

The spectrum analyzer displays the level of the signal generator as received at the antenna ports of the Master Device. The interference detection threshold may be varied from the calibrated value of -62 dBm and the spectrum analyzer will still indicate the level as received by the Master Device.

Set the signal generator to produce a radar waveform, trigger a burst manually and measure the level on the spectrum analyzer. Readjust the amplitude of the signal generator as required so that the peak level of the waveform is at a displayed level equal to the required or desired interference detection threshold. Separate signal generator amplitude settings are determined as required for each radar type.

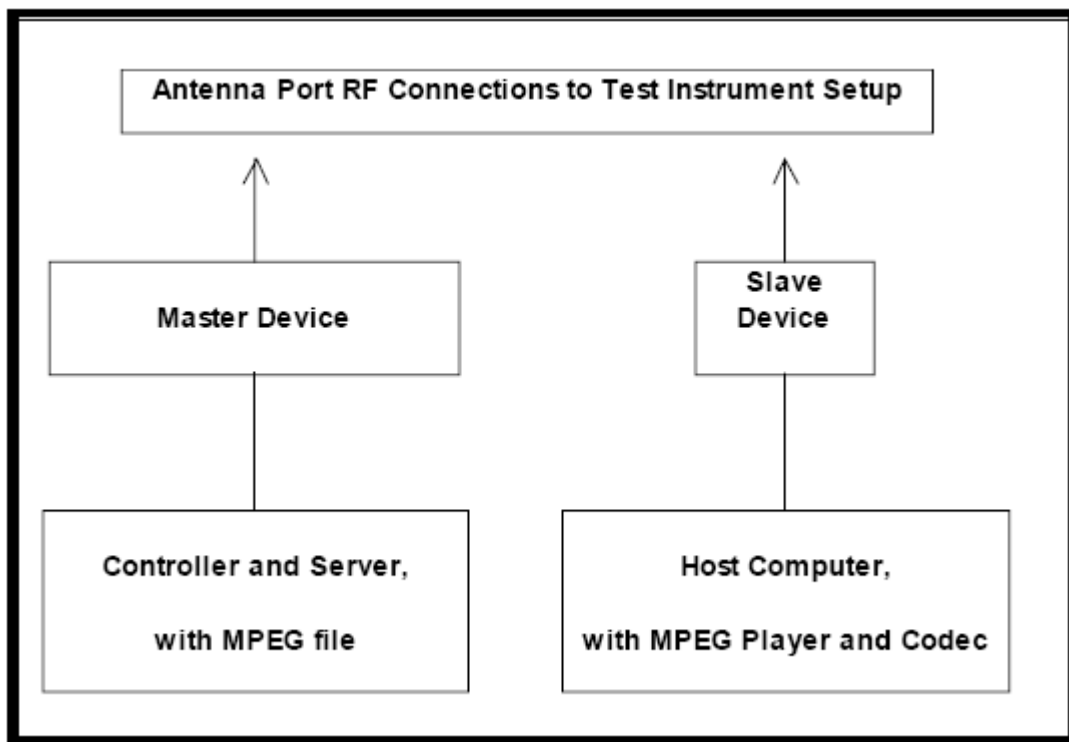

**5.3 DEVIATION FROM TEST STANDARD**

No deviation.

## 6. TEST RESULTS

### 6.1 SUMMARY OF TEST RESULT

Clause	Test Parameter	Test Mode and Channel	Remarks	Pass/Fail
15.407	DFS Detection Threshold	-	No Applicable	N/A
15.407	Channel Availability Check Time	-	Not Applicable	N/A
15.407	Channel Move Time	11ac 20MHz 5540 MHz	Applicable	Pass
		11ac 40MHz 5550 MHz		
		11ac 80MHz 5530 MHz		
		11ac 160MHz 5570 MHz		
15.407	Channel Closing Transmission Time	11ac 20MHz 5540 MHz	Applicable	Pass
		11ac 40MHz 5550 MHz		
		11ac 80MHz 5530 MHz		
		11ac 160MHz 5570 MHz		
15.407	Non- Occupancy Period	11ac 20MHz 5540 MHz	Applicable	Pass
		11ac 40MHz 5550 MHz		
		11ac 80MHz 5530 MHz		
		11ac 160MHz 5570 MHz		
15.407	Uniform Spreading	-	Not Applicable	N/A
15.407	U-NII Detection Bandwidth	-	Not Applicable	N/A

### 6.2 DFS DETECTION THRESHOLD

Calibration:

The EUT is slave equipment and it with a max gain is 4.99 dBi.  
 For a detection threshold level of -62dBm and the master antenna gain is 4.99 dBi, required detection threshold is -57.01 dBm (= -62+4.99).

Note: Maximum Transmit Power is less than 200 milliwatt in this report, so detection threshold level is -62dBm.

### 6.3 CHANNEL CLOSING TRANSMISSION AND CHANNEL MOVE TIME WLAN TRAFFIC

TX (11ac 20Mode)

Radar signal 0

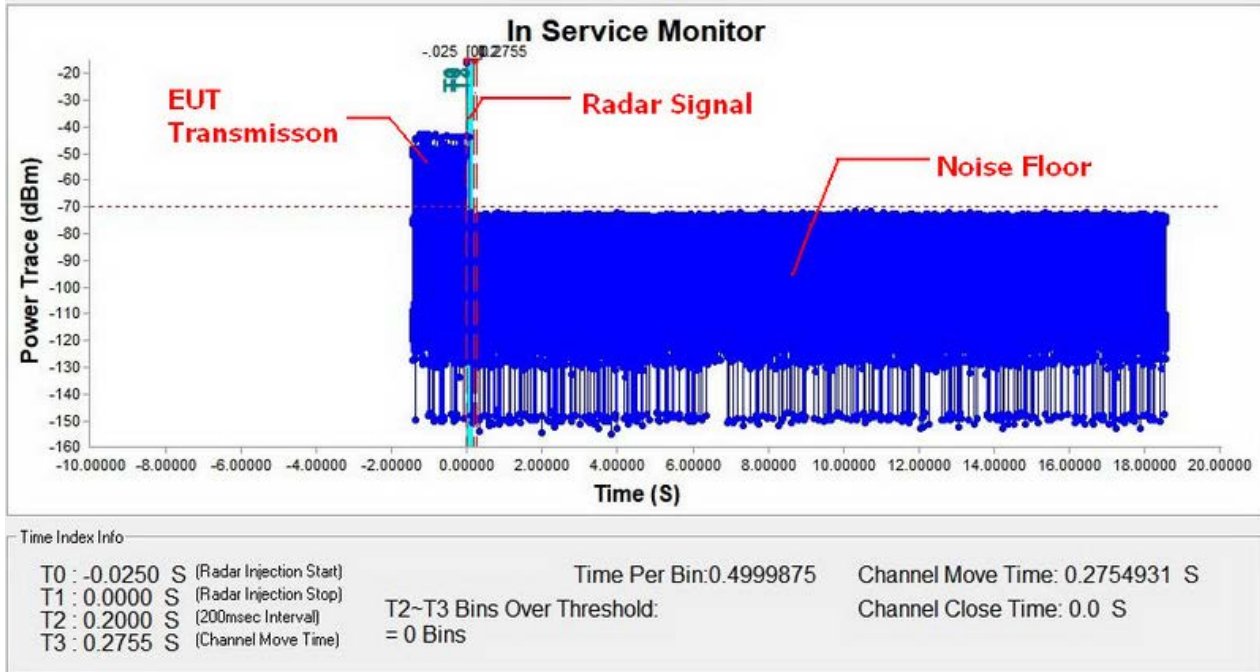

**Note:** T0 denotes the start of Channel Move Time upon the end of the last Radar burst.  
 T1 denotes the data transmission time of 200ms from T1.  
 T2 denotes the end of Channel Move Time.  
 T3 denotes the 10 second from T0 to observe the aggregate duration of transmissions.

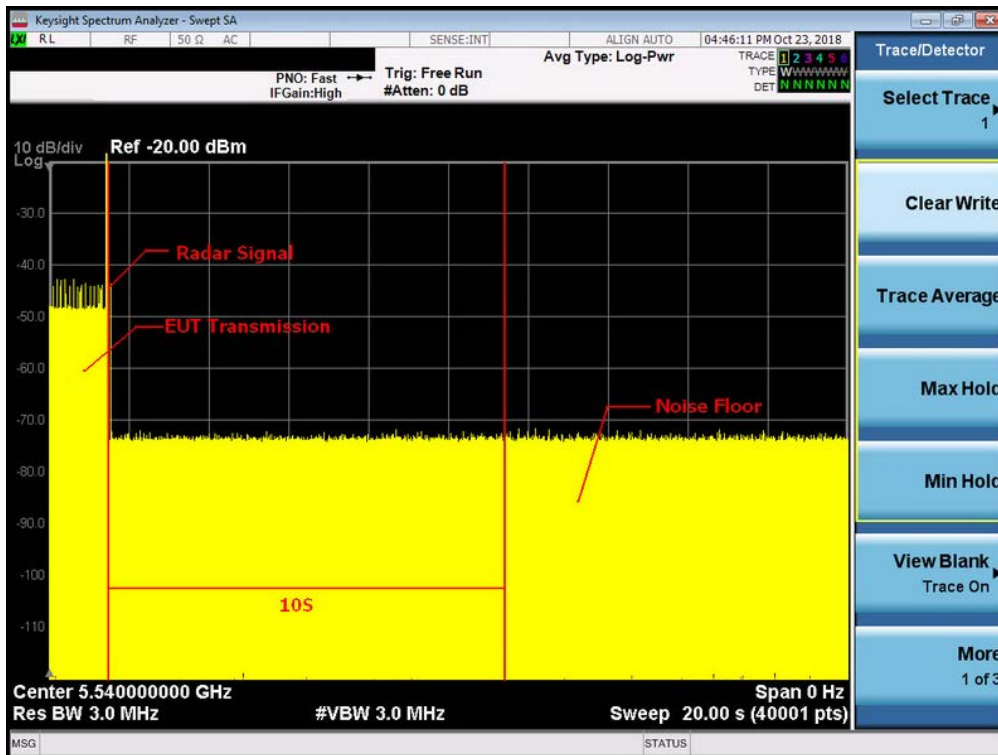

**Note:** An expanded plot for the device vacates the channel in the required 500ms

TX (11ac 40MHz Mode)

Radar signal 0

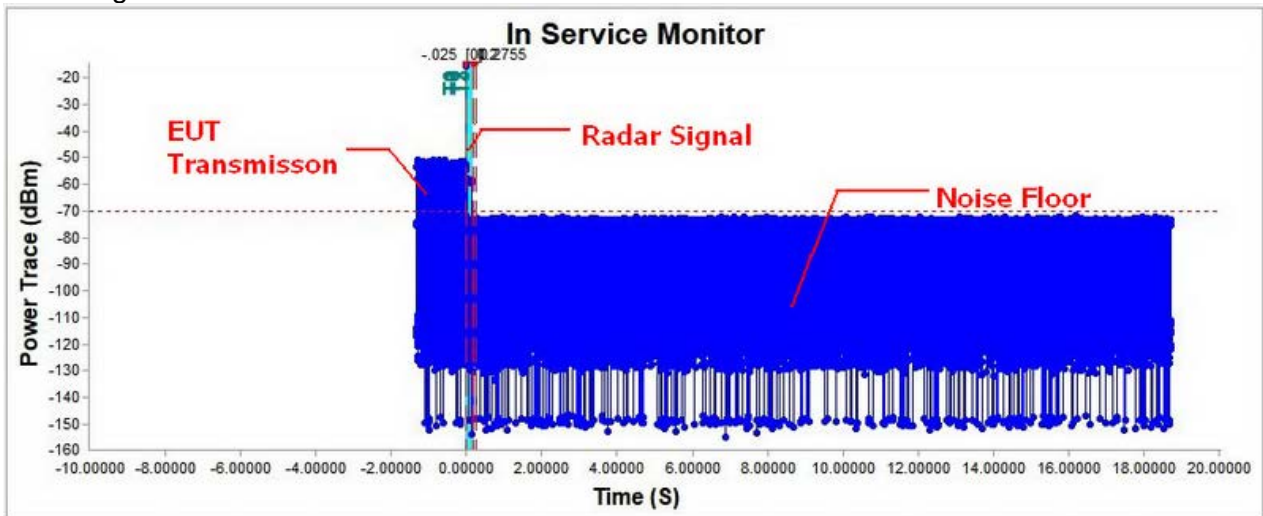

Time Index Info

T0 : -0.0250 S (Radar Injection Start)	Time Per Bin: 0.4999875	Channel Move Time: 0.2754931 S
T1 : 0.0000 S (Radar Injection Stop)	T2~T3 Bins Over Threshold:	Channel Close Time: 0.0 S
T2 : 0.2000 S (200msec Interval)	= 0 Bins	
T3 : 0.2755 S (Channel Move Time)		

**Note:** T0 denotes the start of Channel Move Time upon the end of the last Radar burst.  
 T1 denotes the data transmission time of 200ms from T1.  
 T2 denotes the end of Channel Move Time.  
 T3 denotes the 10 second from T0 to observe the aggregate duration of transmissions.

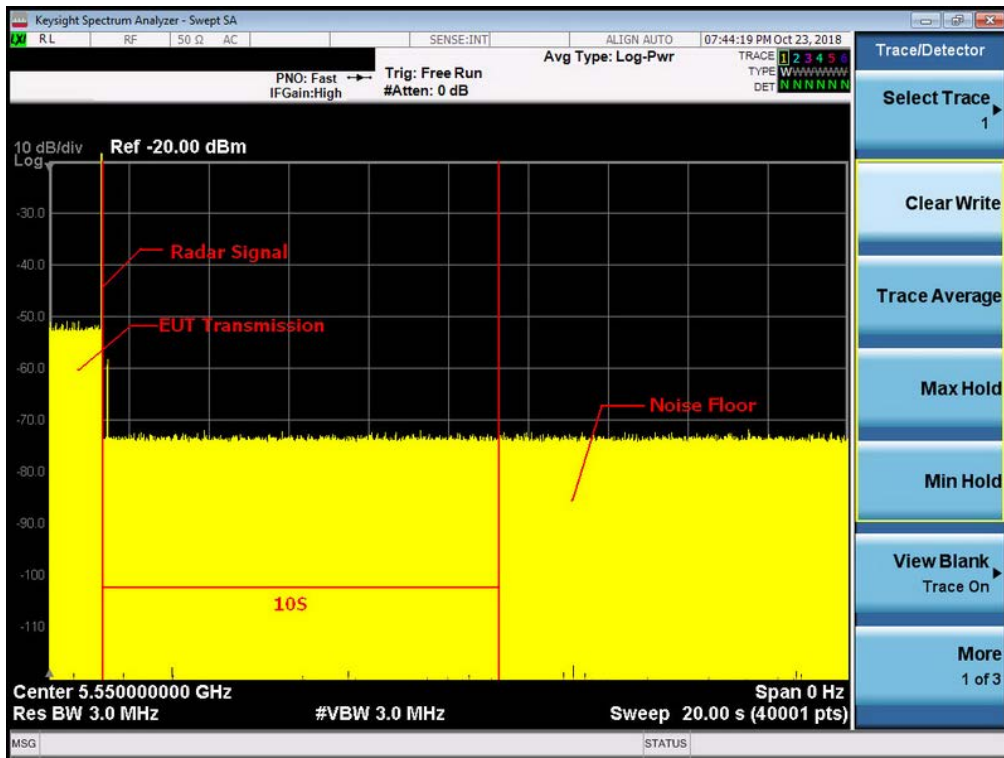

**Note:** An expanded plot for the device vacates the channel in the required 500ms



TX (11ac 80MHz Mode)

Radar signal 0

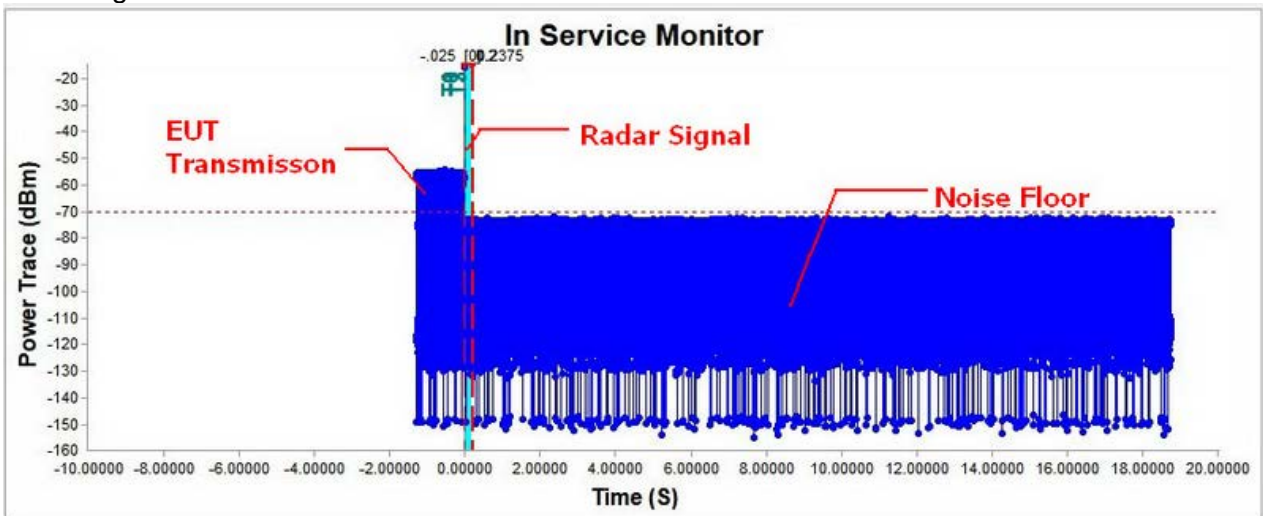

Time Index Info

T0 : -0.0250 S (Radar Injection Start)	Time Per Bin: 0.4999875	Channel Move Time: 0.2374941 S
T1 : 0.0000 S (Radar Injection Stop)	T2~T3 Bins Over Threshold: = 0 Bins	Channel Close Time: 0.0 S
T2 : 0.2000 S (200msec Interval)		
T3 : 0.2375 S (Channel Move Time)		

**Note:** T0 denotes the start of Channel Move Time upon the end of the last Radar burst.  
 T1 denotes the data transmission time of 200ms from T1.  
 T2 denotes the end of Channel Move Time.  
 T3 denotes the 10 second from T0 to observe the aggregate duration of transmissions.

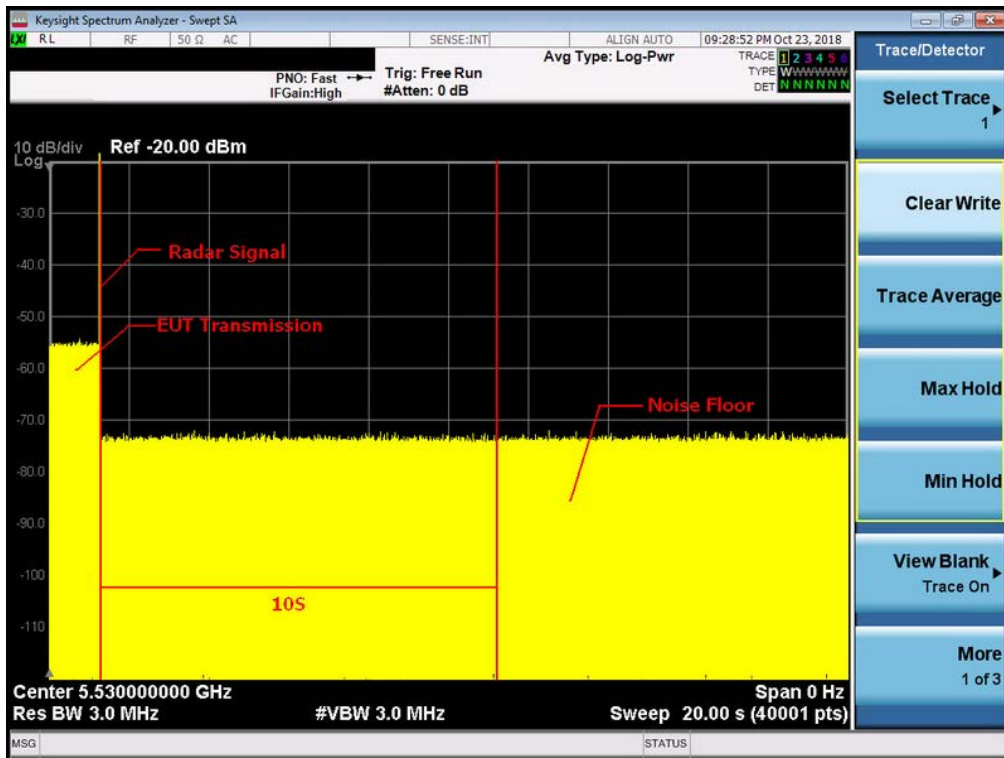

**Note:** An expanded plot for the device vacates the channel in the required 500ms

TX (11ac 160MHz Mode)

Radar signal 0

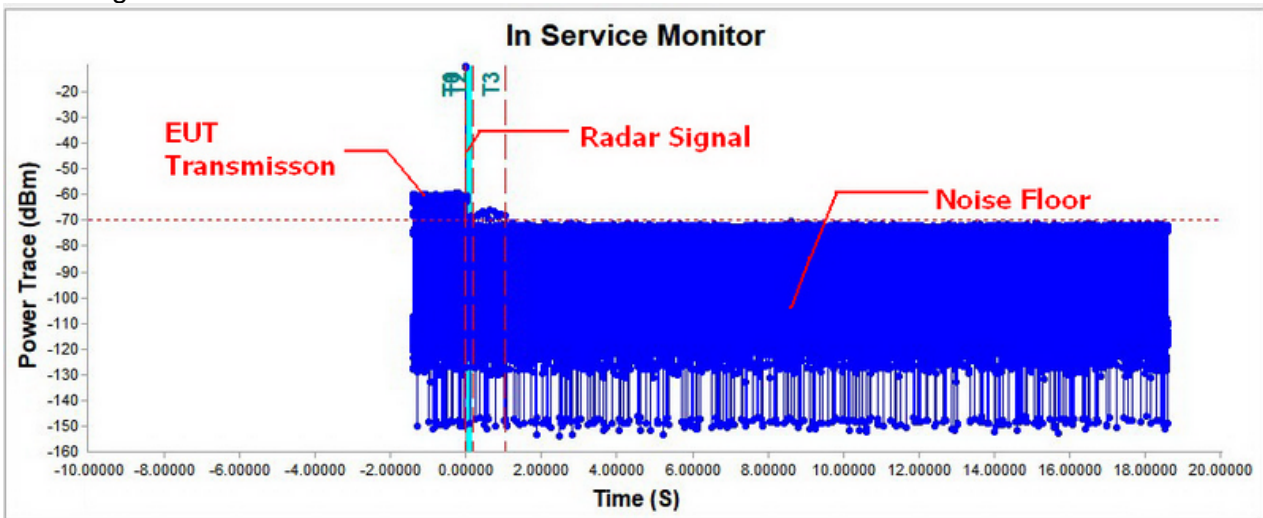

Time Index Info

T0 : -0.0240 S (Radar Injection Start)	Time Per Bin: 0.4999875	Channel Move Time: 1.0469738 S
T1 : 0.0000 S (Radar Injection Stop)	T2~T3 Bins Over Threshold: = 12 Bins	Channel Close Time: 0.0059999 S
T2 : 0.2000 S (200msec Interval)		
T3 : 1.0470 S (Channel Move Time)		

**Note:** T0 denotes the start of Channel Move Time upon the end of the last Radar burst.  
 T1 denotes the data transmission time of 200ms from T1.  
 T2 denotes the end of Channel Move Time.  
 T3 denotes the 10 second from T0 to observe the aggregate duration of transmissions.

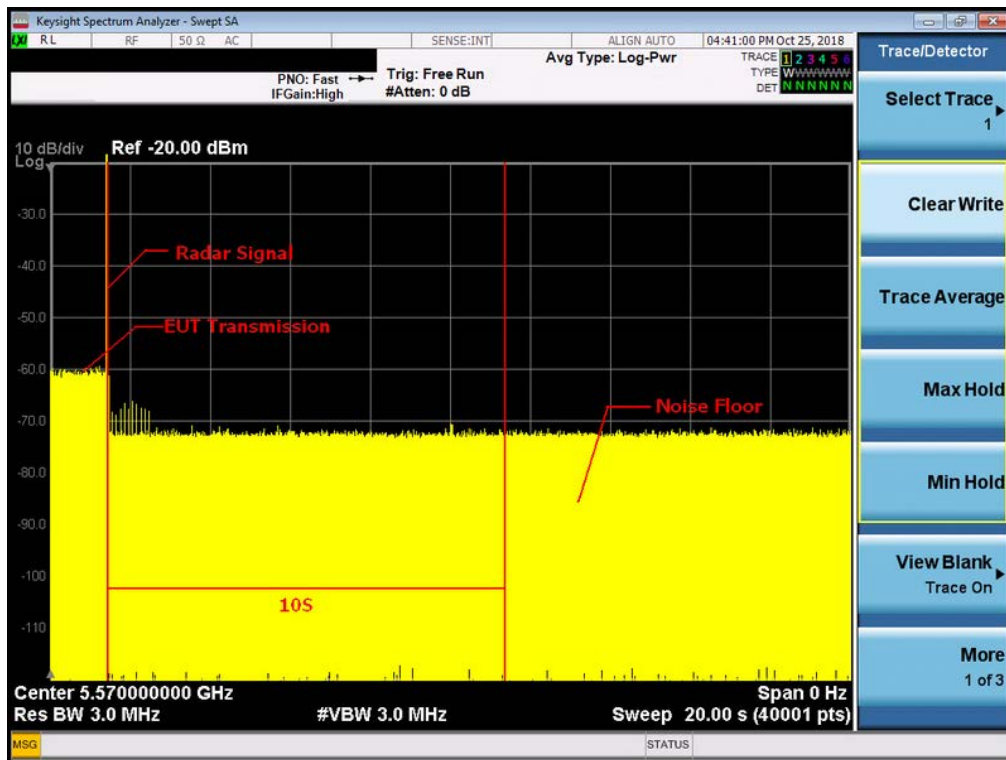

**Note:** An expanded plot for the device vacates the channel in the required 500ms



11ac 20Mode		
Item	Measured Value(s)	Limit(s)
Channel Move Time	0.2754931	10
Channel Close Time	0.0	200 milliseconds + an aggregate of 60 milliseconds over remaining 10 second period

11ac 40MHz Mode		
Item	Measured Value(s)	Limit(s)
Channel Move Time	0.2754931	10
Channel Close Time	0.00	200 milliseconds + an aggregate of 60 milliseconds over remaining 10 second period

11ac 80MHz Mode		
Item	Measured Value(s)	Limit(s)
Channel Move Time	0.2374941	10
Channel Close Time	0.0	200 milliseconds + an aggregate of 60 milliseconds over remaining 10 second period

11ac 160MHz Mode		
Item	Measured Value(s)	Limit(s)
Channel Move Time	1.0469738	10
Channel Close Time	0.0059999	200 milliseconds + an aggregate of 60 milliseconds over remaining 10 second period

### 6.4 NON- OCCUPANCY PERIOD

During the 30 minutes observation time, UUT did not make any transmissions on a channel after a radar signal was detected on that channel by either the Channel Availability Check or the In-Service Monitoring.

TX (11ac 20Mode)

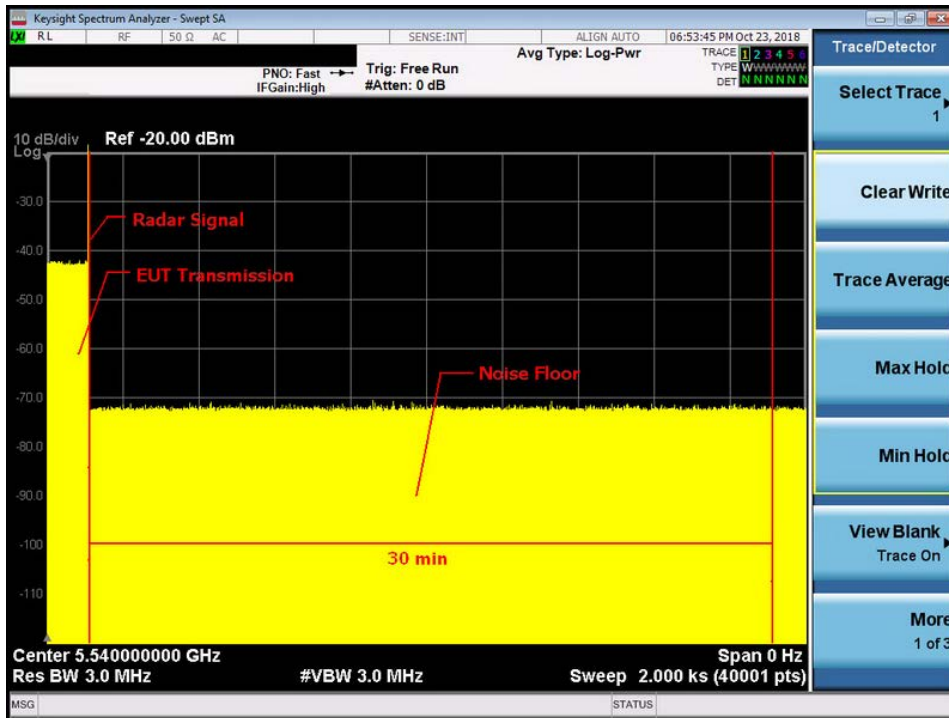

TX (11ac 40MHz Mode)

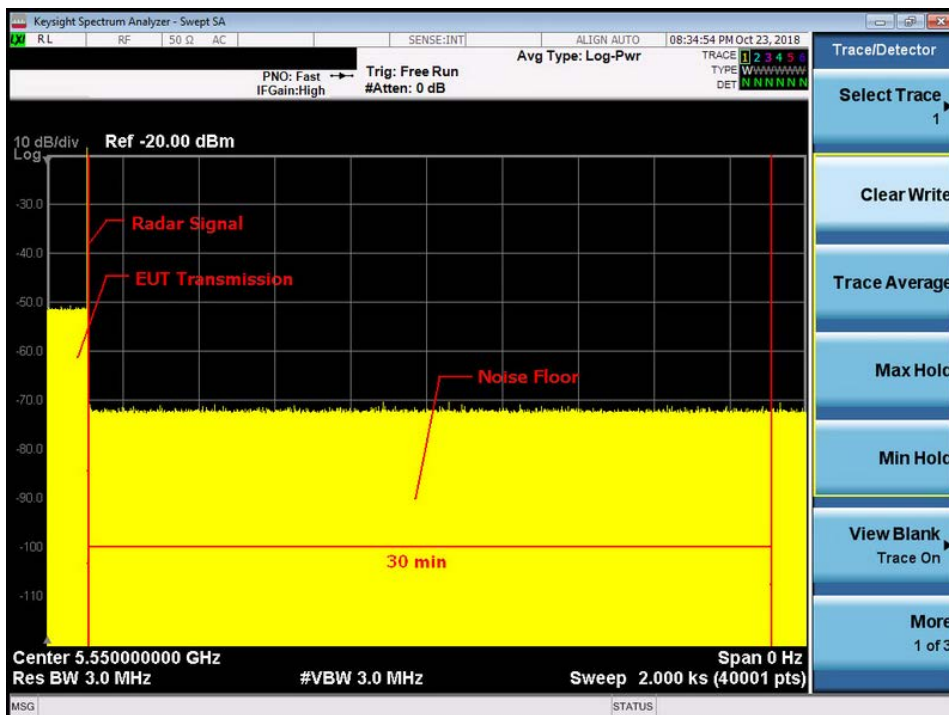

### TX (11ac 80MHz Mode)

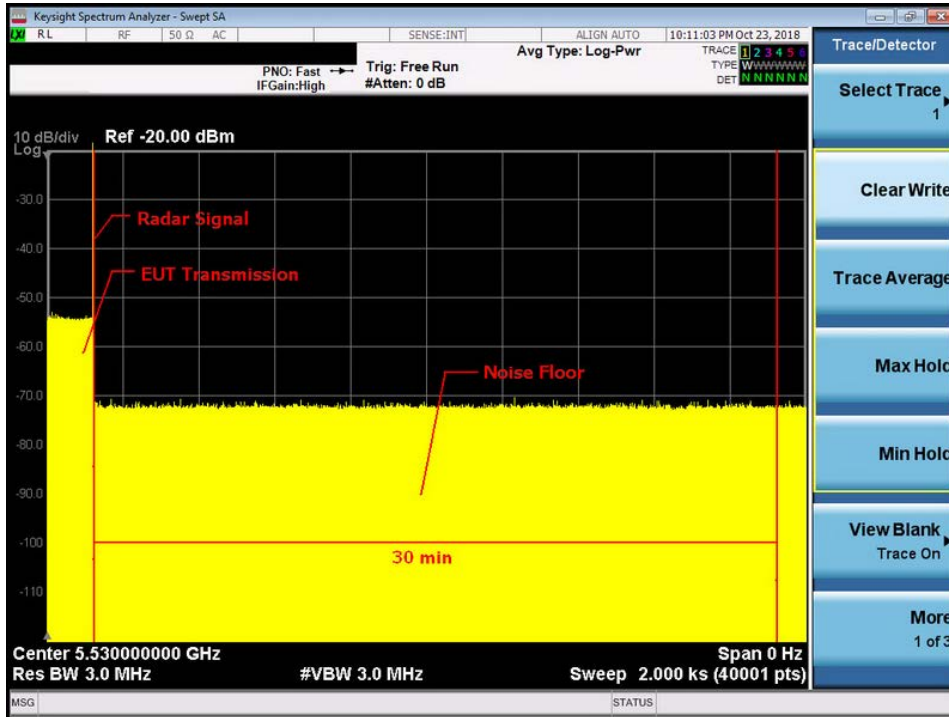

### TX (11ac 160MHz Mode)

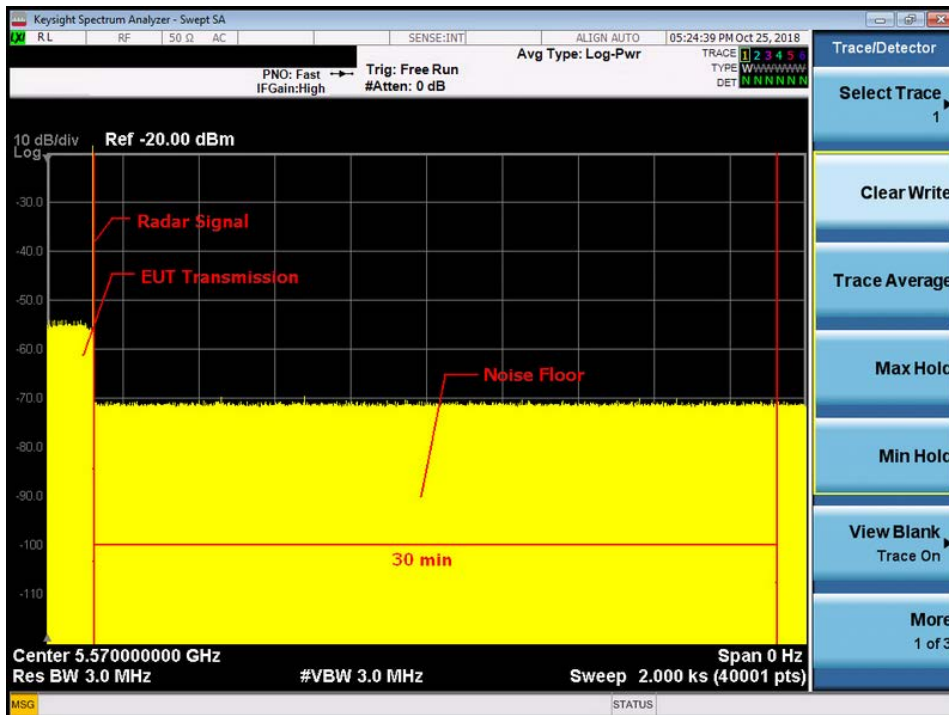

End of Test Report