



FCC PART 15C TEST REPORT FOR CERTIFICATION
On Behalf of

Razer Inc.

Notebook

Model Number: RZ09-0184

FCC ID: RWO-RZ090168IN

Prepared for : Razer Inc.
9 Pasteur, Suite 100 Irvine, California 92618, United States

Prepared By : Audix Technology (Shenzhen) Co., Ltd.
No. 6, Ke Feng Rd., 52 Block,
Shenzhen Science & Industrial Park,
Nantou, Shenzhen, Guangdong, China

Tel: (0755) 26639496

Report Number : ACS-F16043
Date of Test : Jan.12~29, 2016
Date of Report : Mar.11, 2016

TABLE OF CONTENTS

Description	Page
1. SUMMARY OF STANDARDS AND RESULTS	1-1
1.1. Description of Standards and Results	1-1
2. GENERAL INFORMATION	2-1
2.1. Description of Device (EUT)	2-1
2.2. Test Information	2-2
2.1. Tested Supporting System Details	2-3
2.2. Block diagram of connection between the EUT and simulators	2-3
2.3. Test Facility	2-4
2.4. Measurement Uncertainty (95% confidence levels, k=2).....	2-4
3. POWER LINE CONDUCTED EMISSION TEST.....	3-1
3.1. Test Equipments	3-1
3.2. Block Diagram of Test Setup	3-1
3.3. Power Line Conducted Emission Test Limits	3-1
3.4. Configuration of EUT on Test.....	3-2
3.5. Operating Condition of EUT	3-2
3.6. Test Procedure	3-2
3.7. Power Line Conducted Emission Test Results	3-2
4. RADIATED EMISSION TEST	4-1
4.1. Test Equipment.....	4-1
4.2. Block Diagram of Test Setup	4-2
4.3. Radiated Emission Limit	4-3
4.4. EUT Configuration on Test	4-3
4.5. Operating Condition of EUT	4-4
4.6. Test Procedure	4-4
4.7. Radiated Emission Test Results	4-4
5. CONDUCTED SPURIOUS EMISSIONS	5-1
5.1. Test Equipment.....	5-1
5.2. Limit	5-1
5.3. Test Procedure	5-1
5.4. Test result	5-1
6. BAND EDGE COMPLIANCE TEST	6-1
6.1. Test Equipment.....	6-1
6.2. Limit	6-1
6.3. Test Produce	6-1
6.4. Test Results	6-1
7. 6dB Bandwidth Test	7-1
7.1. Test Equipment.....	7-1
7.2. Limit	7-1
7.3. Test Procedure	7-1
7.4. Test Results	7-1
8. OUTPUT POWER TEST	8-1
8.1. Test Equipment.....	8-1
8.2. Limit (FCC Part 15C 15.247 b(3))	8-1
8.3. Test Procedure	8-1
8.4. Test Results	8-2
9. POWER SPECTRAL DENSITY TEST	9-1
9.1. Test Equipment.....	9-1



FCC ID:RWO-RZ090168IN

9.2.	Limit	9-1
9.3.	Test Procedure	9-1
9.4.	Test Results	9-2
10.	ANTENNA REQUIREMENT	10-1
10.1.	Standard Applicable	10-1
10.2.	Antenna Connected Construction.....	10-1
11.	DEVIATION TO TEST SPECIFICATIONS	11-1
12.	PHOTOGRAPH OF TEST.....	12-1
12.1.	Photos of Power Line Conducted Emission Test	12-1
12.2.	Photos of Radiated Emission Test	12-2

TEST REPORT CERTIFICATION

Applicant : Razer Inc.
Manufacturer : Razer Inc.
EUT Description : Notebook
FCC ID : RWO-RZ090168IN
(A) Model No. : RZ09-0184
(B) Serial No. : N/A
(C) Test Voltage : DC 20V From Adapter Input AC 120V/60Hz

Tested for comply with:
FCC CFR 47 Part 15 Subpart C: 2014

Test procedure used:
ANSI C63.10: 2013
KDB558074 D01 v03r03

The device described above is tested by AUDIX TECHNOLOGY (SHENZHEN) CO., LTD. to confirm comply with all the FCC Part 15 Subpart C requirements. The test results are contained in this test report and AUDIX TECHNOLOGY (SHENZHEN) CO., LTD. is assumed full responsibility for the accuracy and completeness of these tests. Also, this report shows that the Equipment Under Test (EUT) is to be technically compliant with the FCC and IC requirements. This report contains data that are not covered by the NVLAP accreditation.

This Report is made under FCC Part 2.1075. No modifications were required during testing to bring this product into compliance.

This report applies to above tested sample only. This report shall not be reproduced in part without written approval of AUDIX TECHNOLOGY (SHENZHEN) CO., LTD.

The report must not be used by the client to claim product certification, approval, or endorsement by NVLAP, NIST, or any agency of the federal government.

Date of Test : Jan.12~29, 2016 Report of date: Mar.11, 2016

Prepared by : Monica Liu Reviewed by : Sunny Lu
Monica Liu / Assistant Sunny Lu / Assistant Manager



Approved & Authorized Signer :

1. SUMMARY OF STANDARDS AND RESULTS

1.1. Description of Standards and Results

The EUT have been tested according to the applicable standards as referenced below.

EMISSION		
Description of Test Item	Standard	Results
Power Line Conducted Emission	FCC Part 15: 15.207	PASS
Radiated Emission	FCC Part 15: 15.209	PASS
Band Edge Compliance	FCC Part 15: 15.247	PASS
Conducted spurious emissions	FCC Part 15: 15.247	PASS
6dB Bandwidth	FCC Part 15: 15.247	PASS
Peak Output Power	FCC Part 15: 15.247	PASS
Power Spectral Density	FCC Part 15: 15.247	PASS
Antenna requirement	FCC Part 15: 15.203	PASS

N/A is an abbreviation for Not Applicable.

2. GENERAL INFORMATION

2.1. Description of Device (EUT)

Product Name	: Notebook
Model Number	: RZ09-0184
FCC ID	: RWO-RZ090168IN
Radio	: IEEE802.11 a/b/g/n/ac; Bluetooth V3.0+EDR; Bluetooth V4.1
Operation Frequency	: IEEE 802.11a: 5180MHz—5240MHz; 5260MHz—5320MHz 5500MHz—5700MHz; 5745MHz—5825MHz IEEE 802.11ac VHT20: 5180MHz—5240MHz; 5260MHz—5320MHz 5500MHz—5700MHz; 5745MHz—5825MHz IEEE 802.11ac VHT40: 5190MHz—5230MHz; 5270MHz—5310MHz 5510MHz—5670MHz; 5755MHz—5795MHz IEEE 802.11ac VHT80: 5210MHz, 5290MHz; 5530MHz; 5775MHz IEEE 802.11b: 2412MHz—2462MHz IEEE 802.11g: 2412MHz—2462MHz IEEE802.11nHT20: 2412MHz—2462MHz; 5180MHz—5240MHz; 5260MHz—5320MHz 5500MHz—5700MHz; 5745MHz—5825MHz IEEE802.11nHT40: 2422MHz—2452MHz; 5190MHz—5230MHz; 5270MHz—5310MHz 5510MHz—5670MHz; 5755MHz—5795MHz Bluetooth : 2402-2480MHz
Modulation Technology	: IEEE 802.11b: DSSS(CCK,DQPSK,DBPSK) IEEE 802.11a/g: OFDM(64QAM, 16QAM, QPSK, BPSK) IEEE 802.11ac VHT20, VHT40, VHT80: OFDM(16QAM, 64QAM, 256QAM, QPSK, BPSK) IEEE 802.11n HT20, HT40: OFDM (64QAM, 16QAM,QPSK,BPSK) Bluetooth V3.0+EDR: GFSK, $\pi/4$ DQPSK,8-DPSK Bluetooth V4.1:GFSK
Antenna Assembly Gain	: Antenna Type: PIFA Bluetooth: 2.7dBi WIFI 2.4GHz:ANT 1: 2.8dBi; ANT 2: 2.7dBi WIFI 5GHz:ANT 1: 4.3dBi; ANT 2: 4.1dBi

Applicant : Razer Inc.
9 Pasteur, Suite 100 Irvine, California 92618, United States

Manufacturer : Razer Inc.
9 Pasteur, Suite 100 Irvine, California 92618, United States

Factory : BYD Precision Manufacture Co., Ltd
No.3001, Baohe Road, Baolong Industrial, Longgang,
Shenzhen, 518116, P.R., China

Power Adapter#1 : Manufacturer: Razer Inc. M/N: RC30-016803
DC Cable: Shielded, Undetachable, 2.0m
Remark: This power adapter is the test adapter.

Power Adapter#2 : Manufacturer: Razer Inc. M/N: RC30-0168
DC Cable: Shielded, Undetachable, 2.0m

Date of Test : Jan.12~29, 2016

Date of Receipt : Jan.10, 2016

2.2. Test Information

A special test software was used to control EUT work in Continuous TX mode(nearly 100% duty cycle), and select test channel, wireless mode and data rate.

Tested mode, channel, and data rate information			
Mode	data rate (Mbps)(see Note)	Channel	Frequency (MHz)
IEEE 802.11b	1	Low :CH1	2412
	1	Middle: CH6	2437
	1	High: CH11	2462
IEEE 802.11g	6	Low :CH1	2412
	6	Middle: CH6	2437
	6	High: CH11	2462
IEEE 802.11n HT20	MCS0	Low :CH1	2412
	MCS0	Middle: CH6	2437
	MCS0	High: CH11	2462
IEEE 802.11n HT40	MCS0	Low :CH3	2422
	MCS0	Middle: CH6	2437
	MCS0	High: CH9	2452

Note: 1. According exploratory test, EUT will have maximum output power in those data rate, so those data rate were used for all test.

Note: 2. 11b/g use SISO mode, choose ANT0 which has the worse case emission for the radiated emission and band edge measurement, 11n mode use MIMO Mode, test with two antenna transmit simultaneously in 11n mode, and comply with KDB662911D01 V02r01.

2.1. Tested Supporting System Details

No.	Description	ACS No.	Manufacturer	Model	Serial Number
1.	HDD#1	ACS-EMC-HDD38	WD	WD Elements	WXA1E63CEME4
		Data Cable: Shielded, Detachable, 1.0m			
2.	HDD#2	ACS-EMC-HDD39	WD	WD Elements	WX61A8360420
		Data Cable: Shielded, Detachable, 1.0m			
3.	Headphone	ACS-EMC-EP01	OVANN	OV880V	---
		Data Cable: Shielded, Undetachable, 2.0m			
4.	Monitor	ACS-EMC-LM01R	ViewSonic	VLCDS26064-2W	A210521A0131
		Power Cord: Unshielded, Detachable, 1.8m			

2.2. Block diagram of connection between the EUT and simulators

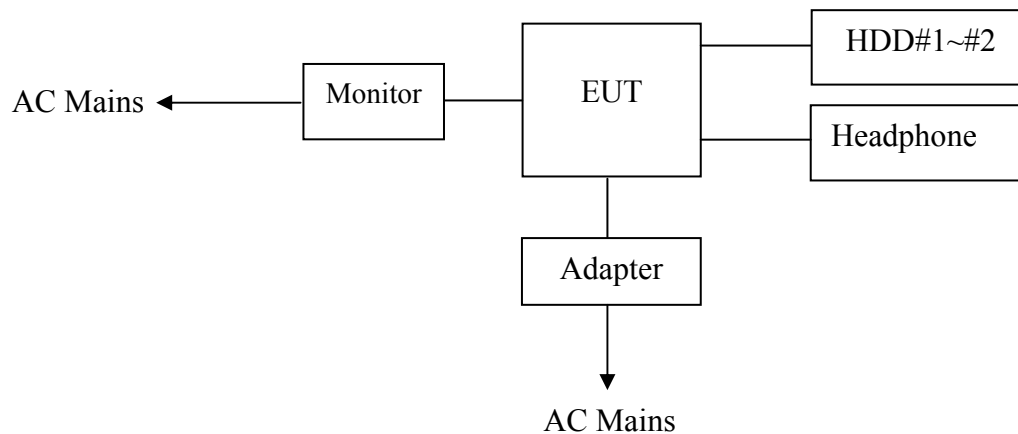

(EUT: Notebook)

2.3. Test Facility

Site Description

Name of Firm	:	Audix Technology (Shenzhen) Co., Ltd. No. 6, Ke Feng Rd., 52 Block, Shenzhen Science & Industrial Park, Nantou, Shenzhen, Guangdong, China
3m Anechoic Chamber	:	Certificated by FCC, USA Registration Number: 90454 Valid Date: Dec.30, 2017
3m & 10m Anechoic Chamber	:	Certificated by FCC, USA Registration Number: 794232 Valid Date: Jul.12, 2016
EMC Lab.	:	Certificated by Industry Canada Registration Number: IC 5183A-1 Valid Date: May.14, 2017
	:	Certificated by DAkkS, Germany Registration No: D-PL-12151-01-00 Valid Date: Dec.15, 2016
	:	Accredited by NVLAP, USA NVLAP Code: 200372-0 Valid Date: Mar.31, 2016

2.4. Measurement Uncertainty (95% confidence levels, k=2)

Test Item	Uncertainty
Uncertainty for Conduction emission test in No. 1 Conduction	3.4dB (150kHz to 30MHz)
Uncertainty for Radiation Emission test in 3m chamber	2.6dB(30~200MHz, Polarization: H)
	2.6dB(30~200MHz, Polarization: V)
	3.0dB(200M~1GHz, Polarization: H)
	2.8dB(200M~1GHz, Polarization: V)
Uncertainty for Radiation Emission test in 3m chamber (1GHz-18GHz)	6.3dB(1~6GHz, Distance: 3m)
	5.7dB(6~18GHz, Distance: 3m)
Uncertainty for Radiated Spurious Emission test in RF chamber	3.6dB
Uncertainty for Conduction Spurious emission test	2.0dB
Uncertainty for Output power test	0.8dB
Uncertainty for Bandwidth test	83kHz
Uncertainty for DC power test	0.1 %
Uncertainty for test site temperature and humidity	0.6°C
	3%

3. POWER LINE CONDUCTED EMISSION TEST

3.1. Test Equipments

Item	Equipment	Manufacturer	Model No.	Serial No.	Last Cal.	Cal. Interval
1.	1# Shielding Room	AUDIX	N/A	N/A	Apr.17,15	1 Year
2.	Test Receiver	Rohde & Schwarz	ESCI	100842	Apr.28,15	1 Year
3.	L.I.S.N.#1	Rohde & Schwarz	ESH2-Z5	100429	Oct.18,15	1 Year
4.	L.I.S.N.#2	Kyoritsu	K NW-403D	8-1750-2	Apr.28,15	1 Year
5.	Terminator	Hubersuhner	50Ω	No.1	Apr.28,15	1 Year
6.	Terminator	Hubersuhner	50Ω	No.2	Apr.28,15	1 Year
7.	RF Cable	MIYAZAKI	3D-2W	No.1	Apr.28,15	1Year
8.	Coaxial Switch	Anritsu	MP59B	6200766906	Apr.28,15	1 Year
9.	Test Software	AUDIX	E3	6.100913a	N/A	N/A

3.2. Block Diagram of Test Setup

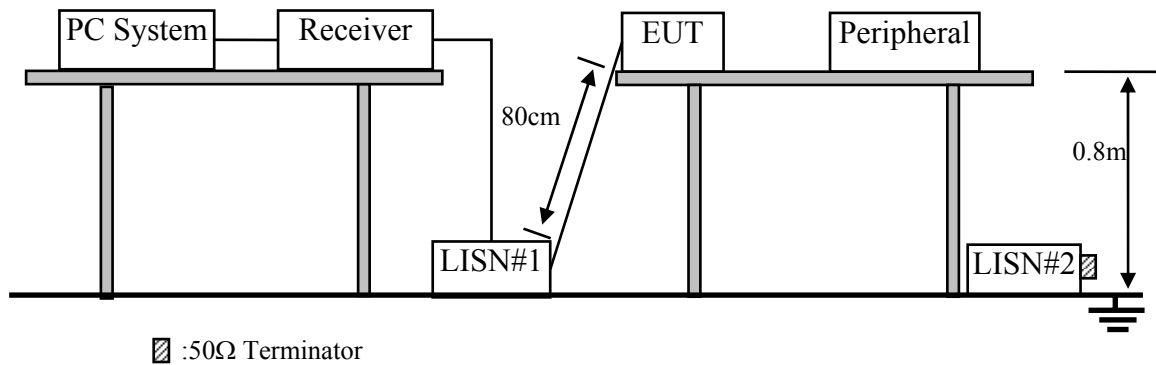

3.3. Power Line Conducted Emission Test Limits

Frequency	Maximum RF Line Voltage	
	Quasi-Peak Level dB(μV)	Average Level dB(μV)
150kHz ~ 500kHz	66 ~ 56*	56 ~ 46*
500kHz ~ 5MHz	56	46
5MHz ~ 30MHz	60	50

Notes: 1. * Decreasing linearly with logarithm of frequency.

2. The lower limit shall apply at the transition frequencies.

3.4. Configuration of EUT on Test

The following equipment are installed on Power Line Conducted Emission Test to meet the commission requirement and operating regulations in a manner which tends to maximize its emission characteristics in a normal application.

3.4.1. Notebook (EUT)

Model Number : RZ09-0184

Serial Number : N/A

3.4.2. Support Equipment: As Tested Supporting System Details, in Section 2.2.

3.5. Operating Condition of EUT

3.5.1. Setup the EUT and simulator as shown as Section 3.2.

3.5.2. Turn on the power of all equipments.

3.5.3. PC run test software to control EUT work in Tx(WiFi 2.4GHz) mode.

3.6. Test Procedure

The EUT was placed on a non-metallic table, 80cm above the ground plane. The EUT Power Via PC connected to the power mains through a line impedance stabilization network (L.I.S.N. 1#). This provides a 50 ohm coupling impedance for the EUT (Please refer the block diagram of the test setup and photographs). The AC line are checked to find out the maximum conducted emission. In order to find the maximum emission levels, the relative positions of equipment and all of the interface cables shall be changed according to ANSI C63.10: 2013 on Conducted Emission Test.

The bandwidth of test receiver (R & S ESCI) is set at 9kHz.

The frequency range from 150kHz to 30MHz is checked.

3.7. Power Line Conducted Emission Test Results

PASS. (All emissions not reported below are too low against the prescribed limits.)

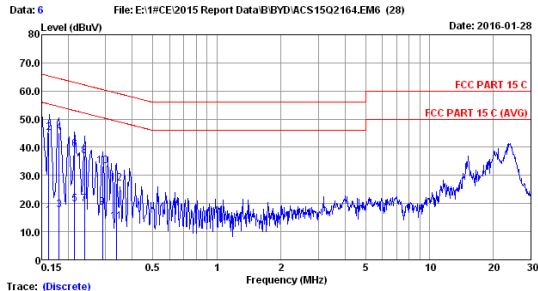

Trace: (Discrete)
 Site no :1# Conduction Data No :6
 Dis./Lism :2015 ESH2-25 LINE
 Limit :FCC PART 15 C
 Env./Ins. :25.5°C/56% Engineer :Alvis-Wu
 EUT :Notebook M/N: R209-0184
 Power Rating :DC 20V From Adapter Input AC 120V/60Hz
 Test Mode :TX Mode

No	Freq (MHz)	LISN Factor (dB)	Cable Loss (dB)	Reading (dBuV)	Emission Level (dBuV)	Limits (dBuV)	Margin (dB)	Remark
1	0.162	0.12	0.05	15.60	15.77	55.36	39.59	Average
2	0.162	0.12	0.05	45.10	45.27	55.36	20.09	QP
3	0.181	0.12	0.05	17.50	17.67	54.44	36.77	Average
4	0.181	0.12	0.05	44.90	45.07	54.44	19.37	QP
5	0.214	0.12	0.05	19.60	19.77	53.05	33.28	Average
6	0.214	0.12	0.05	39.15	39.32	53.05	23.73	QP
7	0.238	0.12	0.05	19.50	19.67	52.17	32.50	Average
8	0.238	0.12	0.05	36.75	36.92	52.17	25.25	QP
9	0.289	0.13	0.05	18.30	18.48	50.54	32.06	Average
10	0.289	0.13	0.05	33.31	33.49	50.54	27.05	QP
11	0.337	0.13	0.06	13.40	13.59	49.27	35.68	Average
12	0.337	0.13	0.06	27.09	27.28	49.27	31.99	QP

Remarks: 1.Emission Level=LISN Factor+Cable Loss+Reading.
 2.If the average limit is met when using a quasi-peak detector, the EUT shall be deemed to meet both limits and measurement with average detector is unnecessary.

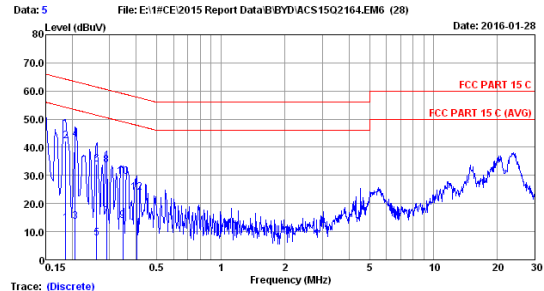

Trace: (Discrete)
 Site no :1# Conduction Data No :5
 Dis./Lism :2015 ESH2-25 NEUTRAL
 Limit :FCC PART 15 C
 Env./Ins. :25.5°C/56% Engineer :Alvis-Wu
 EUT :Notebook M/N: R209-0184
 Power Rating :DC 20V From Adapter Input AC 120V/60Hz
 Test Mode :TX Mode

No	Freq (MHz)	LISN Factor (dB)	Cable Loss (dB)	Reading (dBuV)	Emission Level (dBuV)	Limits (dBuV)	Margin (dB)	Remark
1	0.186	0.12	0.05	12.90	13.07	54.21	41.14	Average
2	0.186	0.12	0.05	42.10	42.27	54.21	21.94	QP
3	0.206	0.12	0.05	13.50	13.67	53.37	39.70	Average
4	0.206	0.12	0.05	42.60	42.77	53.37	20.60	QP
5	0.261	0.13	0.05	7.40	7.58	51.40	43.82	Average
6	0.261	0.13	0.05	33.70	33.88	51.40	27.52	QP
7	0.289	0.13	0.05	15.10	15.28	50.54	35.26	Average
8	0.289	0.13	0.05	33.54	33.72	50.54	26.82	QP
9	0.346	0.13	0.06	13.80	13.99	49.05	35.06	Average
10	0.346	0.13	0.06	29.30	29.49	49.05	29.56	QP
11	0.402	0.14	0.06	11.40	11.60	47.81	36.21	Average
12	0.402	0.14	0.06	23.76	23.96	47.81	33.85	QP

Remarks: 1.Emission Level=LISN Factor+Cable Loss+Reading.
 2.If the average limit is met when using a quasi-peak detector, the EUT shall be deemed to meet both limits and measurement with average detector is unnecessary.

4. RADIATED EMISSION TEST

4.1. Test Equipment

4.1.1. For frequency range 30MHz~1000MHz (In 3m Anechoic Chamber)

Item	Equipment	Manufacturer	Model No.	Serial No.	Last Cal.	Cal. Interval
1.	3#Chamber	AUDIX	N/A	N/A	Mar.28,15	1 Year
2.	EMI Spectrum	Agilent	E4407B	MY41440292	Apr.28,15	1 Year
3.	Test Receiver	Rohde & Schwarz	ESVS10	834468/011	Apr.28,15	1 Year
4.	Amplifier	HP	8447D	2648A04738	Apr.28,15	1 Year
5.	Bilog Antenna	TESEQ	CBL6112D	35375	Jun.30,15	1 Year
6.	RF Cable	MIYAZAKI	CFD400-NW(3.5M)	No.3	Apr.28,15	1 Year
7.	RF Cable	MIYAZAKI	CFD400-LW(22M)	No.7	Apr.28,15	1 Year
8.	Coaxial Switch	Anritsu	MP59B	6201397222	Apr.28,15	1 Year
9.	Test Software	AUDIX	E3	6.2009-5-21a(n)	N/A	N/A

4.1.2. For frequency range 1GHz~40GHz (In 3m Anechoic Chamber)

Item	Equipment	Manufacturer	Model No.	Serial No.	Last Cal.	Cal. Interval
1.	Spectrum Analyzer	Agilent	E4446A	US44300459	Apr.28,15	1 Year
2.	Horn Antenna	ETS	3115	9510-4877	Oct.15,15	1 Year
3.	Horn Antenna	ETC	MCTD 1209	DRH15F03007	Feb.03,15	1 Year
4.	Amplifier	Agilent	8449B	3008A02495	Apr.28,15	1 Year
5.	RF Cable	Hubersuhner	SUCOFLEX106	77977/6	Apr.28,15	1 Year
6.	Horn Antenna	ETS	3116	00060089	Oct.15,15	1 Year
7.	Test Software	AUDIX	E3	6.2009-5-21a(n)	N/A	N/A

4.2. Block Diagram of Test Setup

For frequency range 30MHz-1000MHz

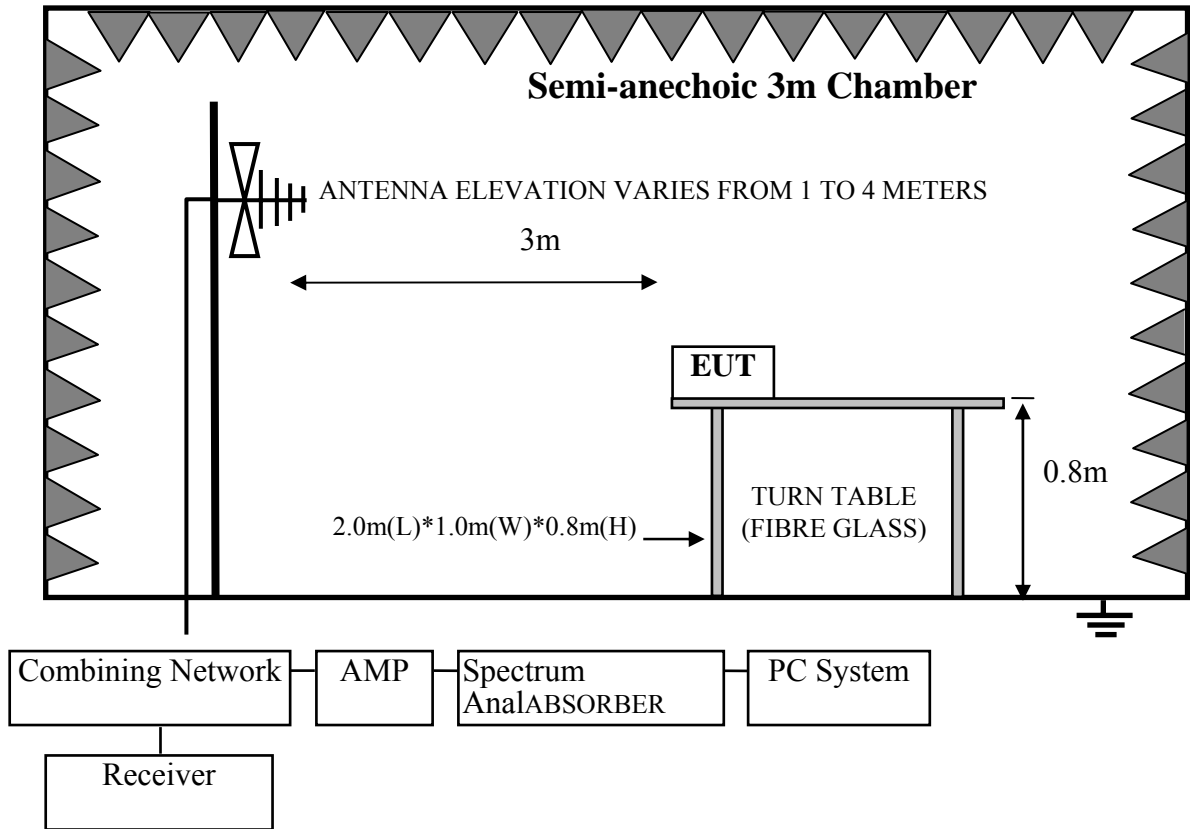

For frequency range 1GHz-25GHz

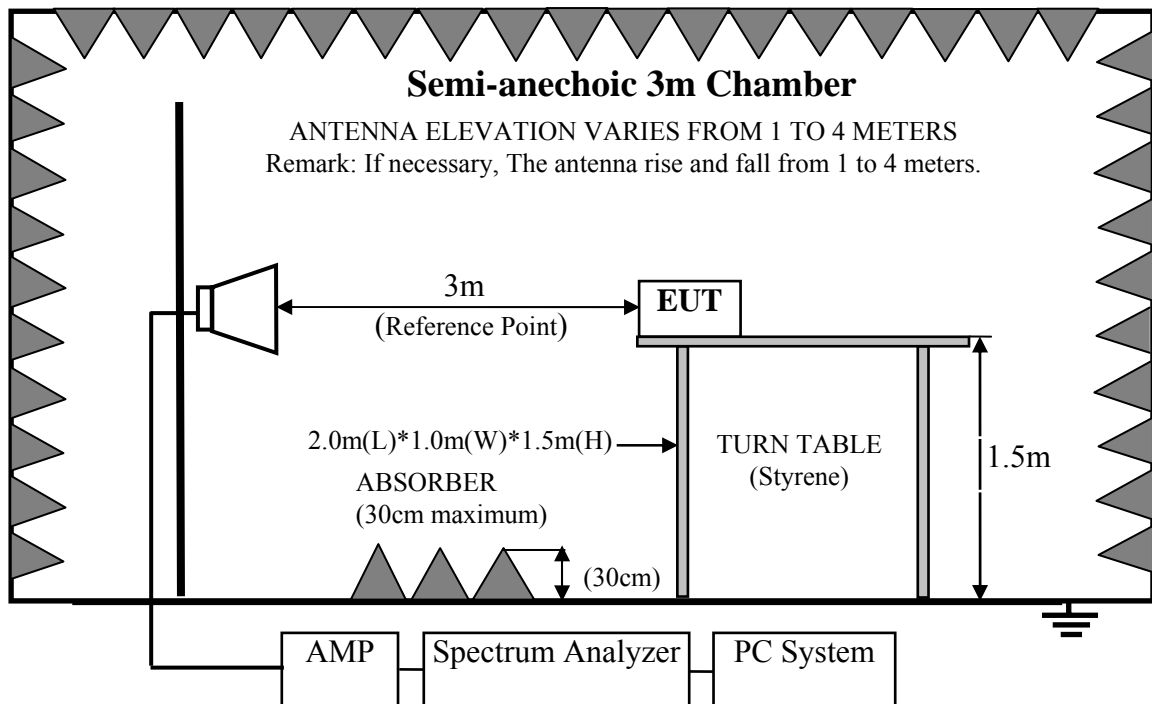

4.3. Radiated Emission Limit

4.3.1. 15.247&209 limits

FREQUENCY MHz	DISTANCE Meters	FIELD STRENGTHS LIMIT	
		μV/m	dB(μV)/m
30 ~ 88	3	100	40.0
88 ~ 216	3	150	43.5
216 ~ 960	3	200	46.0
960 ~ 1000	3	500	54.0
Above 1000	3	74.0 dB(μV)/m (Peak) 54.0 dB(μV)/m (Average)	

Remark : (1) Emission level dBμV = 20 log Emission level μV/m

(2) The smaller limit shall apply at the cross point between two frequency bands.

(3) Distance is the distance in meters between the measuring instrument, antenna and the closest point of any part of the device or system.

4.3.2. 15.205 Restricted bands of operation

MHz	MHz	MHz	GHz
0.090 - 0.110	16.42 - 16.423	399.9 - 410	4.5 - 5.15
¹ 0.495 - 0.505	16.69475 - 16.69525	608 - 614	5.35 - 5.46
2.1735 - 2.1905	16.80425 - 16.80475	960 - 1240	7.25 - 7.75
4.125 - 4.128	25.5 - 25.67	1300 - 1427	8.025 - 8.5
4.17725 - 4.17775	37.5 - 38.25	1435 - 1626.5	9.0 - 9.2
4.20725 - 4.20775	73 - 74.6	1645.5 - 1646.5	9.3 - 9.5
6.215 - 6.218	74.8 - 75.2	1660 - 1710	10.6 - 12.7
6.26775 - 6.26825	108 - 121.94	1718.8 - 1722.2	13.25 - 13.4
6.31175 - 6.31225	123 - 138	2200 - 2300	14.47 - 14.5
8.291 - 8.294	149.9 - 150.05	2310 - 2390	15.35 - 16.2
8.362 - 8.366	156.52475 - 156.52525	2483.5 - 2500	17.7 - 21.4
8.37625 - 8.38675	156.7 - 156.9	2690 - 2900	22.01 - 23.12
8.41425 - 8.41475	162.0125 - 167.17	3260 - 3267	23.6 - 24.0
12.29 - 12.293	167.72 - 173.2	3332 - 3339	31.2 - 31.8
12.51975 - 12.52025	240 - 285	3345.8 - 3358	36.43 - 36.5
12.57675 - 12.57725	322 - 335.4	3600 - 4400	(²)

All the emissions appearing within 15.205 restricted frequency bands shall not exceed the limits shown in 15.209, all the other emissions shall be at least 20dB below the fundamental emissions or comply with 15.209 limits.

4.4. EUT Configuration on Test

The following equipment are installed on Power Line Conducted Emission Test to meet the commission requirement and operating regulations in a manner which tends to maximize its emission characteristics in a normal application.

4.4.1. Notebook (EUT)

Model Number : RZ09-0184

Serial Number : N/A

4.4.2. Support Equipment: As Tested Supporting System Details, in Section 2.2.

4.5. Operating Condition of EUT

- 4.5.1. Setup the EUT and simulator as shown as Section 4.2.
- 4.5.2. Turn on the power of all equipments.
- 4.5.3. Let EUT work in Tx(WiFi 2.4GHz) mode

4.6. Test Procedure

EUT and its simulators are placed on a turn table, which is 0.8 meter high above ground for frequency 30MHz~1000MHz, 1.5 meter high above ground for frequency above 1GHz and put the absorbing with 2.4m(L)*2.4m(W)*0.3m(H) on the ground. The turn table can rotate 360 degrees to determine the position of the maximum emission level. Power on the EUT and let it working in test mode, then test it. EUT is set 3 meters away from the receiving antenna, which is mounted on a antenna tower. The antenna can be moved up and down between 1 meter and 4 meters to find out the maximum emission level. Broadband antenna (calibrated bilog antenna) is used as receiving antenna for frequency 30MHz~1000MHz, and the Horn antenna is used as receiving antenna for frequency above 1GHz. Both horizontal and vertical polarization of the antenna are set on test.

This test was performed with EUT in X, Y, Z position, and the worse case was found when EUT in X position as test photo indicated.

The bandwidth of the EMI test receiver (R&S ESVS10) is set at 120kHz for frequency range from 30MHz to 1000 MHz.

The bandwidth of the Spectrum's VBW is set at 3MHz and RBW is set at 1MHz for peak emissions measurement above 1GHz and 1MHz RBW, 10Hz VBW for average emissions measure above 1GHz

The frequency range from 30MHz to 10th harmonic (25GHz) are checked. and no any emissions were found from 18GHz to 25GHz, So the radiated emissions from 18GHz to 25GHz were not record.

4.7. Radiated Emission Test Results

PASS.

All the emissions from 30MHz to 25 GHz were comply with 15.209 limits.

Note: For emissions above 1GHz, if peak level comply with average limit, then the average level is deemed to comply with average limit.

Duty cycle

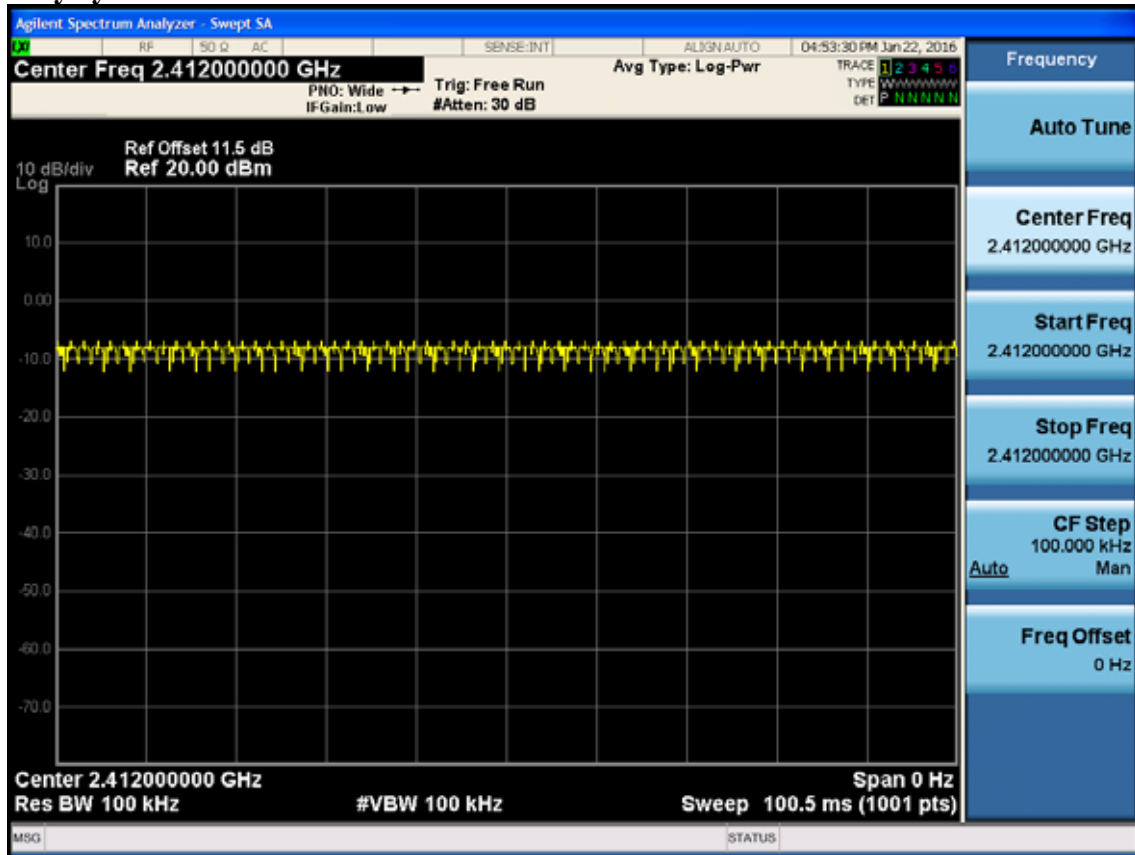

Note: The Duty Cycle is close to 100%.

Frequency: 30MHz~1GHz

Data: 6 File: E:\2015 Report Data\B\BYD\ACS1502164.EM6 (28) Date: 2016-01-28

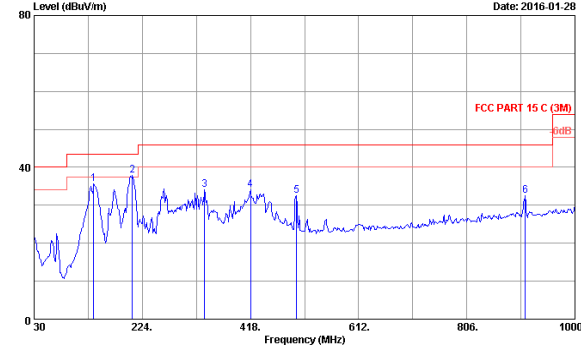

Site no. : 3m Chamber Data no. : 6
 Dis. / Ant. : 3m 2015 CBL6112D 3S375 Ant. pol. : HORIZONTAL
 Limit : FCC PART 15 C (3M)
 Env. / Ins. : 22.1°C/50% Engineer : Brown
 Power rating : DC 20V From Adapter Input AC 120V/60Hz
 Test Mode : Notebook M/N:RZ09-0184
 DC 20V From Adapter Input AC 120V/60Hz
 Tx Mode

No.	Freq. (MHz)	Ant. Factor (dB/m)	Cable Loss (dB)	Reading (dBuV)	Emission Level (dBuV/m)	Limits (dBuV/m)	Margin (dB)	Remark
1	136.700	12.43	1.27	21.85	35.55	43.50	7.95	QP
2	206.540	10.90	1.54	25.53	37.97	43.50	5.53	QP
3	335.550	15.01	2.01	16.98	34.00	46.00	12.00	QP
4	418.000	17.04	2.27	14.73	34.04	46.00	11.96	QP
5	500.450	18.40	2.51	11.62	32.53	46.00	13.47	QP
6	910.760	22.11	3.51	6.91	32.53	46.00	13.47	QP

Remarks: 1. Emission Level= Antenna Factor + Cable Loss + Reading.
 2. The emission levels that are 20dB below the official limit are not reported.

Data: 5 File: E:\2015 Report Data\B\BYD\ACS1502164.EM6 (28) Date: 2016-01-28

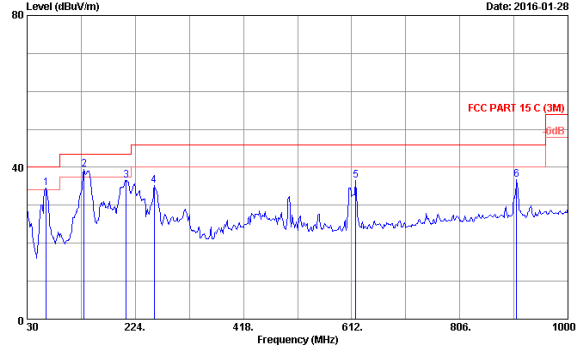

Site no. : 3m Chamber Data no. : 5
 Dis. / Ant. : 3m 2015 CBL6112D 3S375 Ant. pol. : VERTICAL
 Limit : FCC PART 15 C (3M)
 Env. / Ins. : 22.1°C/50% Engineer : Brown
 Power rating : DC 20V From Adapter Input AC 120V/60Hz
 Test Mode : Notebook M/N:RZ09-0184
 DC 20V From Adapter Input AC 120V/60Hz
 Tx Mode

No.	Freq. (MHz)	Ant. Factor (dB/m)	Cable Loss (dB)	Reading (dBuV)	Emission Level (dBuV/m)	Limits (dBuV/m)	Margin (dB)	Remark
1	63.950	6.80	0.89	26.87	34.56	40.00	5.44	QP
2	131.850	13.11	1.24	25.19	39.54	43.50	3.96	QP
3	207.510	10.90	1.54	24.02	36.46	43.50	7.04	QP
4	257.950	14.09	1.73	19.41	35.23	46.00	10.77	QP
5	619.760	19.70	2.82	14.10	36.62	46.00	9.38	QP
6	907.850	22.08	3.51	11.16	36.75	46.00	9.25	QP

Remarks: 1. Emission Level= Antenna Factor + Cable Loss + Reading.
 2. The emission levels that are 20dB below the official limit are not reported.

Frequency: 1GHz~18GHz

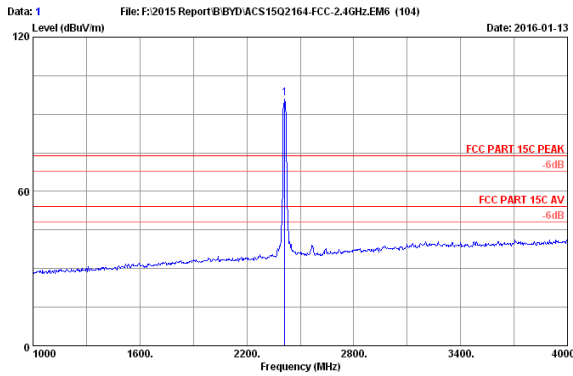

Site no. : 3m Chamber Data no. : 1
 Dis. / Ant. : 3m 2015 3115-4877 Ant. pol. : VERTICAL
 Limit : FCC PART 15C PEAK
 Env. / Ins. : 23.6°C/52.8%
 Engineer : Alice_yang
 EUT : Notebook
 Power rating : DC 20V From Adapter Input AC 120V/60Hz
 Test Mode : IEEES02.11b 2412MHz Tx
 R209-0184

No.	Freq. (MHz)	Ant. Factor (dB/m)	Cable Loss (dB)	AMP factor (dB)	Reading (dBuV)	Emission Level (dBuV/m)	Limits (dBuV/m)	Margin (dB)	Remark
1	2412.000	28.29	7.35	36.62	97.08	96.10	74.00	-22.10	Peak

Remarks: 1. Emission Level= Antenna Factor + Cable Loss + Reading - Amp Factor
 2. The emission levels that are 20dB below the official limit are not reported.

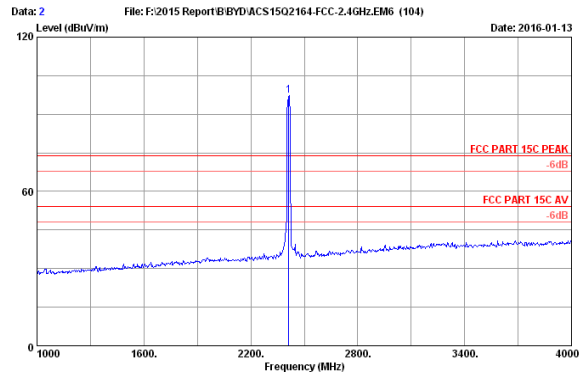

Site no. : 3m Chamber Data no. : 2
 Dis. / Ant. : 3m 2015 3115-4877 Ant. pol. : HORIZONTAL
 Limit : FCC PART 15C PEAK
 Env. / Ins. : 23.6°C/52.8%
 Engineer : Alice_yang
 EUT : Notebook
 Power rating : DC 20V From Adapter Input AC 120V/60Hz
 Test Mode : IEEES02.11b 2412MHz Tx
 R209-0184

No.	Freq. (MHz)	Ant. Factor (dB/m)	Cable Loss (dB)	AMP factor (dB)	Reading (dBuV)	Emission Level (dBuV/m)	Limits (dBuV/m)	Margin (dB)	Remark
1	2412.000	28.29	7.35	36.62	98.09	97.11	74.00	-23.11	Peak

Remarks: 1. Emission Level= Antenna Factor + Cable Loss + Reading - Amp Factor
 2. The emission levels that are 20dB below the official limit are not reported.

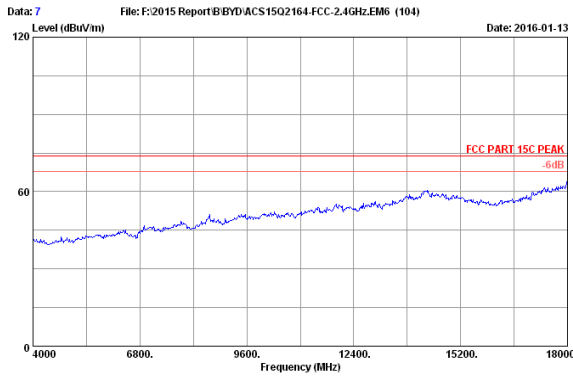

Site no. : 3m Chamber Data no. : 7
 Dis. / Ant. : 3m 2015 3115-4877 Ant. pol. : HORIZONTAL
 Limit : FCC PART 15C PEAK
 Env. / Ins. : 23.6°C/52.8%
 Engineer : Alice_yang
 EUT : Notebook
 Power rating : DC 20V From Adapter Input AC 120V/60Hz
 Test Mode : IEEES02.11b 2412MHz Tx
 R209-0184

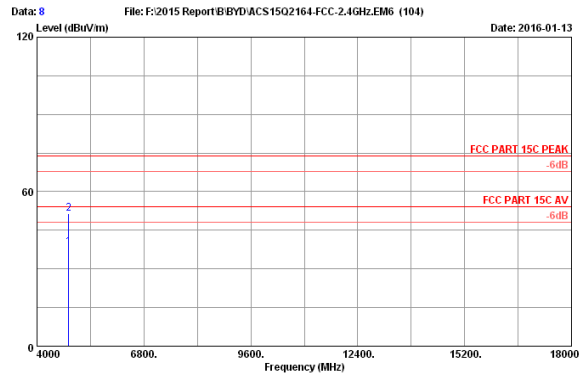

Site no. : 3m Chamber Data no. : 8
 Dis. / Ant. : 3m 2015 3115-4877 Ant. pol. : HORIZONTAL
 Limit : FCC PART 15C PEAK
 Env. / Ins. : 23.6°C/52.8%
 Engineer : Alice_yang
 EUT : Notebook
 Power rating : DC 20V From Adapter Input AC 120V/60Hz
 Test Mode : IEEES02.11b 2412MHz Tx
 R209-0184

No.	Freq. (MHz)	Ant. Factor (dB/m)	Cable Loss (dB)	AMP factor (dB)	Reading (dBuV)	Emission Level (dBuV/m)	Limits (dBuV/m)	Margin (dB)	Remark
1	4824.000	33.15	9.46	35.53	31.35	38.43	54.00	15.57	Average
2	4824.000	33.15	9.46	35.53	44.27	51.35	74.00	22.65	Peak

Remarks: 1. Emission Level= Antenna Factor + Cable Loss + Reading - Amp Factor
 2. The emission levels that are 20dB below the official limit are not reported.

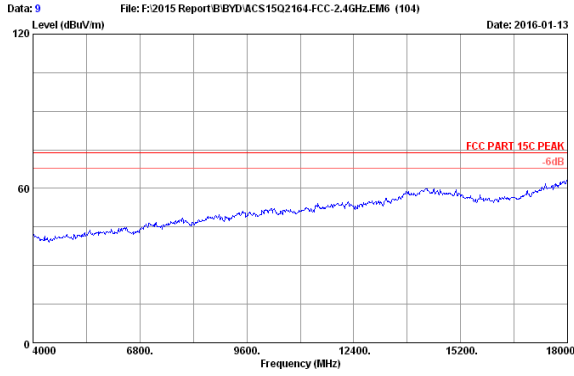

Site no. : 3m Chamber Data no. : 9
 Dis. / Ant. : 3m 2015 3115-4877 Ant. pol. : VERTICAL
 Limit : FCC PART 15C PEAK
 Env. / Ins. : 23.6°C/52.8%
 Engineer : Alice_yang
 EUT : Notebook
 Power rating : DC 20V From Adapter Input AC 120V/60Hz
 Test Mode : IEEE802.11b 2412MHz Tx
 RZ09-0184

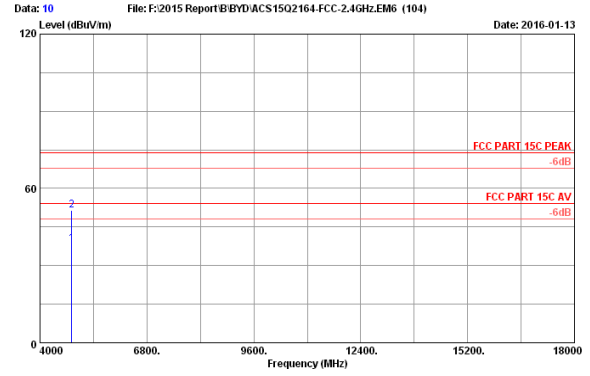

Site no. : 3m Chamber Data no. : 10
 Dis. / Ant. : 3m 2015 3115-4877 Ant. pol. : VERTICAL
 Limit : FCC PART 15C PEAK
 Env. / Ins. : 23.6°C/52.8%
 Engineer : Alice_yang
 EUT : Notebook
 Power rating : DC 20V From Adapter Input AC 120V/60Hz
 Test Mode : IEEE802.11b 2412MHz Tx
 RZ09-0184

No.	Freq. (MHz)	Ant. Factor (dB/m)	Cable Loss (dB)	AMP factor (dB)	Reading (dBuV)	Emission Level (dBuV/m)	Limits (dBuV/m)	Margin (dB)	Remark
1	4824.000	33.15	9.46	35.53	31.46	38.54	54.00	15.46	Average
2	4824.000	33.15	9.46	35.53	44.51	51.59	74.00	22.41	Peak

Remarks: 1. Emission Level= Antenna Factor + Cable Loss + Reading - Amp Factor
 2. The emission levels that are 20dB below the official limit are not reported.

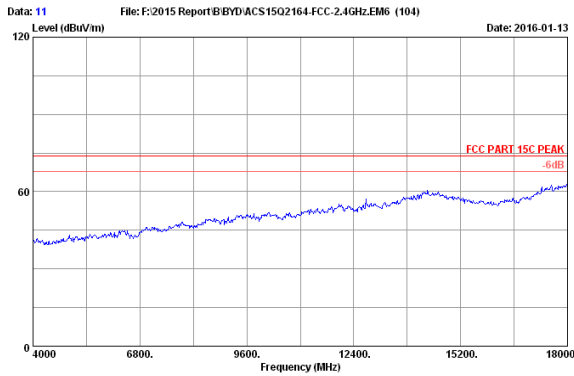

Site no. : 3m Chamber Data no. : 11
 Dis. / Ant. : 3m 2015 3115-4877 Ant. pol. : VERTICAL
 Limit : FCC PART 15C PEAK
 Env. / Ins. : 23.6°C/52.8%
 Engineer : Alice_yang
 EUT : Notebook
 Power rating : DC 20V From Adapter Input AC 120V/60Hz
 Test Mode : IEEE802.11b 2437MHz Tx
 RZ09-0184

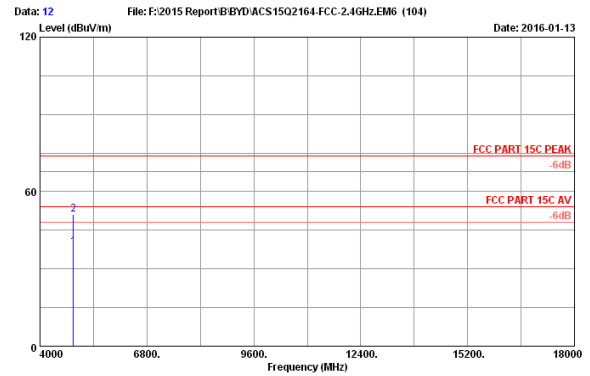

Site no. : 3m Chamber Data no. : 12
 Dis. / Ant. : 3m 2015 3115-4877 Ant. pol. : VERTICAL
 Limit : FCC PART 15C PEAK
 Env. / Ins. : 23.6°C/52.8%
 Engineer : Alice_yang
 EUT : Notebook
 Power rating : DC 20V From Adapter Input AC 120V/60Hz
 Test Mode : IEEE802.11b 2437MHz Tx
 RZ09-0184

No.	Freq. (MHz)	Ant. Factor (dB/m)	Cable Loss (dB)	AMP factor (dB)	Reading (dBuV)	Emission Level (dBuV/m)	Limits (dBuV/m)	Margin (dB)	Remark
1	4874.000	33.25	9.49	35.51	31.09	38.32	54.00	15.68	Average
2	4874.000	33.25	9.49	35.51	43.90	51.13	74.00	22.87	Peak

Remarks: 1. Emission Level= Antenna Factor + Cable Loss + Reading - Amp Factor
 2. The emission levels that are 20dB below the official limit are not reported.

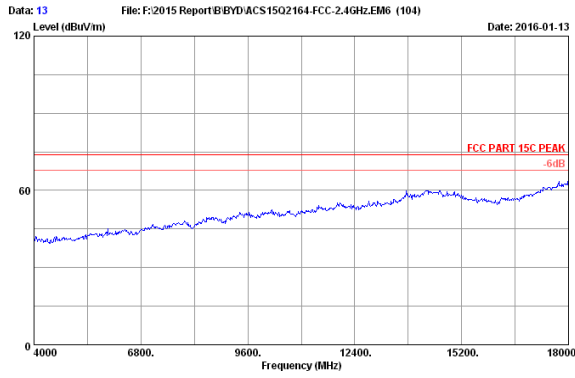

Site no. : 3m Chamber Data no. : 13
 Dis. / Ant. : 3m 2015 3115-4877 Ant. pol. : HORIZONTAL
 Limit : FCC PART 15C PEAK
 Env. / Ins. : 23.6°C/52.8%
 Engineer : Alice_yang
 EUT : Notebook
 Power rating : DC 20V From Adapter Input AC 120V/60Hz
 Test Mode : IEEE802.11b 2437MHz Tx
 RZ09-0184

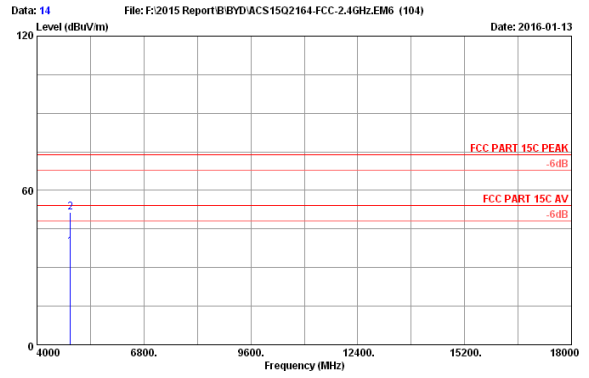

Site no. : 3m Chamber Data no. : 14
 Dis. / Ant. : 3m 2015 3115-4877 Ant. pol. : HORIZONTAL
 Limit : FCC PART 15C PEAK
 Env. / Ins. : 23.6°C/52.8%
 Engineer : Alice_yang
 EUT : Notebook
 Power rating : DC 20V From Adapter Input AC 120V/60Hz
 Test Mode : IEEE802.11b 2437MHz Tx
 RZ09-0184

No.	Freq. (MHz)	Ant. Factor (dB/m)	Cable Loss (dB)	AMP factor (dB)	Reading (dBuV)	Emission Level (dBuV/m)	Limits (dBuV/m)	Margin (dB)	Remark
1	4874.000	39.25	9.49	35.51	31.04	38.27	54.00	15.73	Average
2	4874.000	39.25	9.49	35.51	44.16	51.39	74.00	22.61	Peak

Remarks: 1. Emission Level= Antenna Factor + Cable Loss + Reading - Amp Factor
 2. The emission levels that are 20dB below the official limit are not reported.

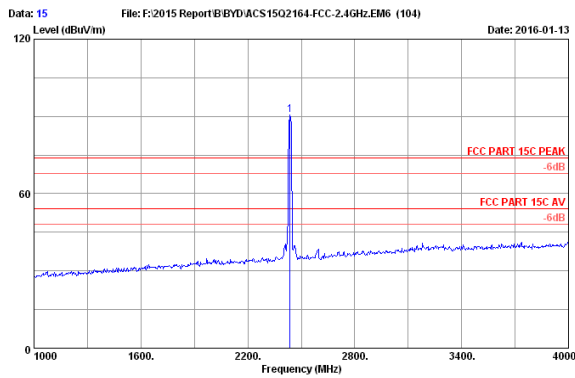

Site no. : 3m Chamber Data no. : 15
 Dis. / Ant. : 3m 2015 3115-4877 Ant. pol. : VERTICAL
 Limit : FCC PART 15C PEAK
 Env. / Ins. : 23.6°C/52.8%
 Engineer : Alice_yang
 EUT : Notebook
 Power rating : DC 20V From Adapter Input AC 120V/60Hz
 Test Mode : IEEE802.11b 2437MHz Tx
 RZ09-0184

No.	Freq. (MHz)	Ant. Factor (dB/m)	Cable Loss (dB)	AMP factor (dB)	Reading (dBuV)	Emission Level (dBuV/m)	Limits (dBuV/m)	Margin (dB)	Remark
1	2437.000	28.32	7.39	36.61	91.65	90.75	74.00	-16.75	Peak

Remarks: 1. Emission Level= Antenna Factor + Cable Loss + Reading - Amp Factor
 2. The emission levels that are 20dB below the official limit are not reported.

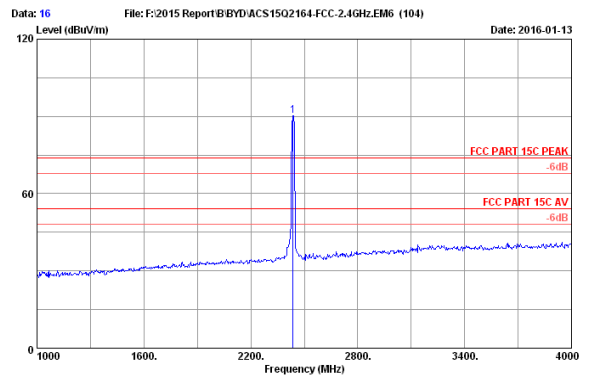

Site no. : 3m Chamber Data no. : 16
 Dis. / Ant. : 3m 2015 3115-4877 Ant. pol. : HORIZONTAL
 Limit : FCC PART 15C PEAK
 Env. / Ins. : 23.6°C/52.8%
 Engineer : Alice_yang
 EUT : Notebook
 Power rating : DC 20V From Adapter Input AC 120V/60Hz
 Test Mode : IEEE802.11b 2437MHz Tx
 RZ09-0184

No.	Freq. (MHz)	Ant. Factor (dB/m)	Cable Loss (dB)	AMP factor (dB)	Reading (dBuV)	Emission Level (dBuV/m)	Limits (dBuV/m)	Margin (dB)	Remark
1	2437.000	28.32	7.39	36.61	91.22	90.32	74.00	-16.32	Peak

Remarks: 1. Emission Level= Antenna Factor + Cable Loss + Reading - Amp Factor
 2. The emission levels that are 20dB below the official limit are not reported.

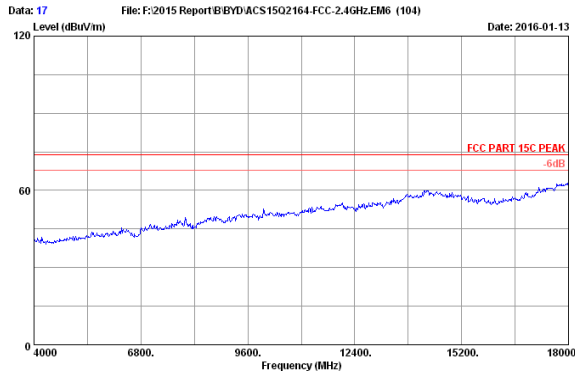

Site no. : 3m Chamber Data no. : 17
 Dis. / Ant. : 3m 2015 3115-4877 Ant. pol. : HORIZONTAL
 Limit : FCC PART 15C PEAK
 Env. / Ins. : 23.6°C/52.8%
 Engineer : Alice_yang
 EUT : Notebook
 Power rating : DC 20V From Adapter Input AC 120V/60Hz
 Test Mode : IEEE802.11b 2462MHz Tx
 RZ09-0184

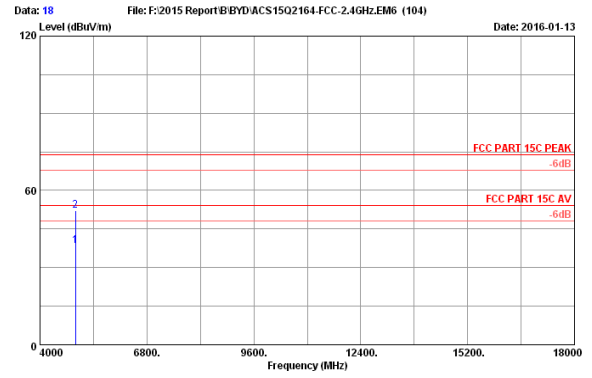

Site no. : 3m Chamber Data no. : 18
 Dis. / Ant. : 3m 2015 3115-4877 Ant. pol. : HORIZONTAL
 Limit : FCC PART 15C PEAK
 Env. / Ins. : 23.6°C/52.8%
 Engineer : Alice_yang
 EUT : Notebook
 Power rating : DC 20V From Adapter Input AC 120V/60Hz
 Test Mode : IEEE802.11b 2462MHz Tx
 RZ09-0184

No.	Freq. (MHz)	Ant. Factor (dB/m)	Cable Loss (dB)	AMP factor (dB)	Reading (dBuV)	Emission Level (dBuV/m)	Limits (dBuV/m)	Margin (dB)	Remark
1	4924.000	33.35	9.51	35.48	31.09	38.47	54.00	15.53	Average
2	4924.000	33.35	9.51	35.48	44.70	52.08	74.00	21.92	Peak

Remarks: 1. Emission Level= Antenna Factor + Cable Loss + Reading - Amp Factor
 2. The emission levels that are 20dB below the official limit are not reported.

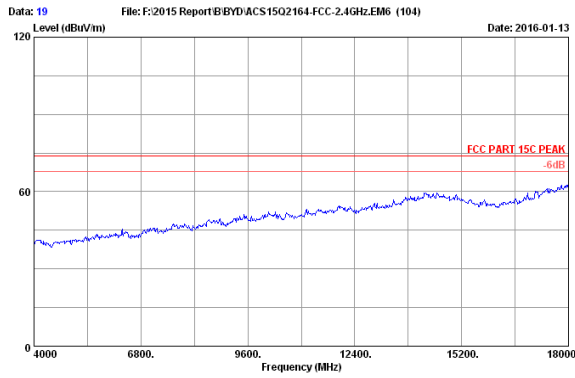

Site no. : 3m Chamber Data no. : 19
 Dis. / Ant. : 3m 2015 3115-4877 Ant. pol. : VERTICAL
 Limit : FCC PART 15C PEAK
 Env. / Ins. : 23.6°C/52.8%
 Engineer : Alice_yang
 EUT : Notebook
 Power rating : DC 20V From Adapter Input AC 120V/60Hz
 Test Mode : IEEE802.11b 2462MHz Tx
 RZ09-0184

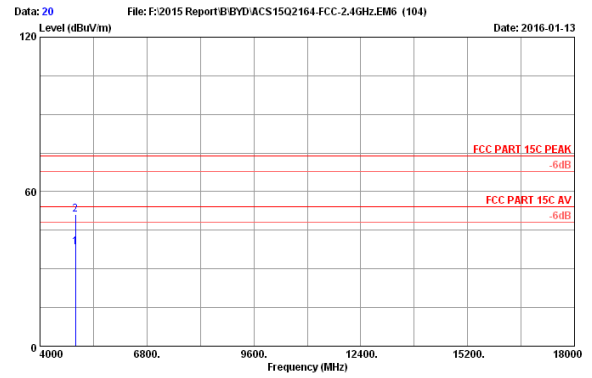

Site no. : 3m Chamber Data no. : 20
 Dis. / Ant. : 3m 2015 3115-4877 Ant. pol. : VERTICAL
 Limit : FCC PART 15C PEAK
 Env. / Ins. : 23.6°C/52.8%
 Engineer : Alice_yang
 EUT : Notebook
 Power rating : DC 20V From Adapter Input AC 120V/60Hz
 Test Mode : IEEE802.11b 2462MHz Tx
 RZ09-0184

No.	Freq. (MHz)	Ant. Factor (dB/m)	Cable Loss (dB)	AMP factor (dB)	Reading (dBuV)	Emission Level (dBuV/m)	Limits (dBuV/m)	Margin (dB)	Remark
1	4924.000	33.35	9.51	35.48	31.20	38.58	54.00	15.42	Average
2	4924.000	33.35	9.51	35.48	43.84	51.22	74.00	22.78	Peak

Remarks: 1. Emission Level= Antenna Factor + Cable Loss + Reading - Amp Factor
 2. The emission levels that are 20dB below the official limit are not reported.

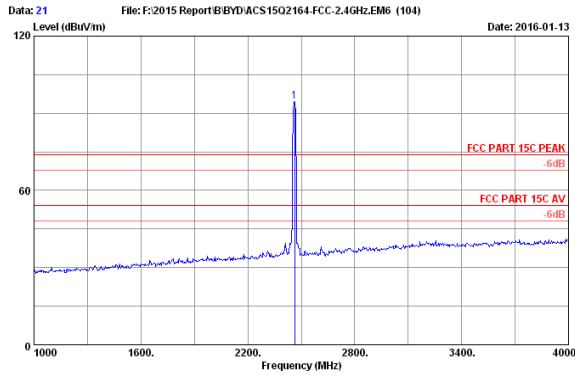

Site no. : 3m Chamber Data no. : 21
 Dis. / Ant. : 3m 2015 3115-4877 Ant. pol. : VERTICAL
 Limit : FCC PART 15C PEAK
 Env. / Ins. : 23.6°C/52.8%
 Engineer : Alice_yang
 EUT : Notebook
 Power rating : DC 20V From Adapter Input AC 120V/60Hz
 Test Mode : IEEE802.11b 2462MHz Tx
 R209-0184

No.	Freq. (MHz)	Ant. Factor (dB/m)	Cable Loss (dB)	AMP factor (dB)	Reading (dBuV)	Emission Level (dBuV/m)	Limits (dBuV/m)	Margin (dB)	Remark
1	2462.000	28.35	7.43	36.60	95.42	94.60	74.00	-20.60	Peak

Remarks: 1. Emission Level= Antenna Factor + Cable Loss + Reading - Amp Factor
 2. The emission levels that are 20dB below the official limit are not reported.

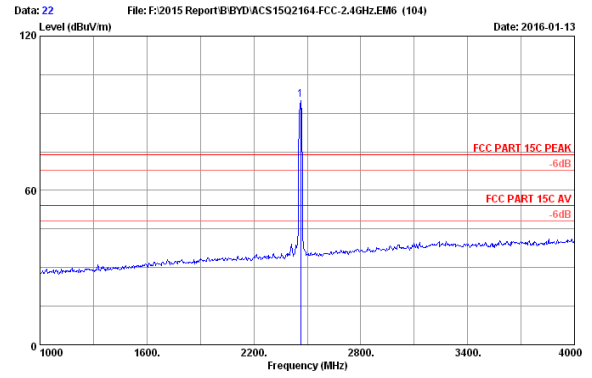

Site no. : 3m Chamber Data no. : 22
 Dis. / Ant. : 3m 2015 3115-4877 Ant. pol. : HORIZONTAL
 Limit : FCC PART 15C PEAK
 Env. / Ins. : 23.6°C/52.8%
 Engineer : Alice_yang
 EUT : Notebook
 Power rating : DC 20V From Adapter Input AC 120V/60Hz
 Test Mode : IEEE802.11b 2462MHz Tx
 R209-0184

No.	Freq. (MHz)	Ant. Factor (dB/m)	Cable Loss (dB)	AMP factor (dB)	Reading (dBuV)	Emission Level (dBuV/m)	Limits (dBuV/m)	Margin (dB)	Remark
1	2462.000	28.35	7.43	36.60	96.20	95.38	74.00	-21.38	Peak

Remarks: 1. Emission Level= Antenna Factor + Cable Loss + Reading - Amp Factor
 2. The emission levels that are 20dB below the official limit are not reported.

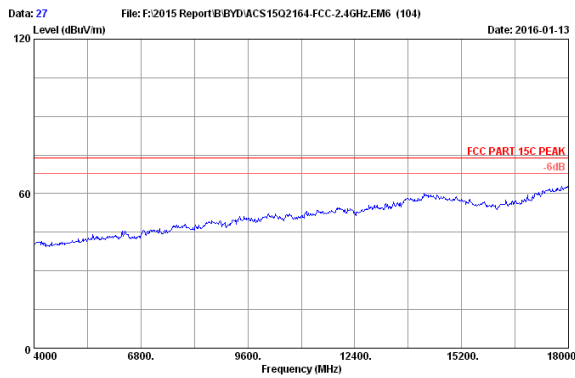

Site no. : 3m Chamber Data no. : 27
 Dis. / Ant. : 3m 2015 3115-4877 Ant. pol. : VERTICAL
 Limit : FCC PART 15C PEAK
 Env. / Ins. : 23.6°C/52.8%
 Engineer : Alice_yang
 EUT : Notebook
 Power rating : DC 20V From Adapter Input AC 120V/60Hz
 Test Mode : IEEE802.11g 2412MHz Tx
 R209-0184

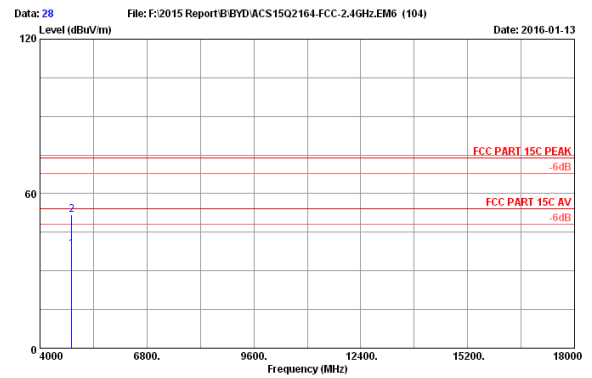

Site no. : 3m Chamber Data no. : 28
 Dis. / Ant. : 3m 2015 3115-4877 Ant. pol. : VERTICAL
 Limit : FCC PART 15C PEAK
 Env. / Ins. : 23.6°C/52.8%
 Engineer : Alice_yang
 EUT : Notebook
 Power rating : DC 20V From Adapter Input AC 120V/60Hz
 Test Mode : IEEE802.11g 2412MHz Tx
 R209-0184

No.	Freq. (MHz)	Ant. Factor (dB/m)	Cable Loss (dB)	AMP factor (dB)	Reading (dBuV)	Emission Level (dBuV/m)	Limits (dBuV/m)	Margin (dB)	Remark
1	4824.000	33.15	9.46	35.53	31.49	38.57	54.00	15.43	Average
2	4824.000	33.15	9.46	35.53	44.67	51.75	74.00	22.25	Peak

Remarks: 1. Emission Level= Antenna Factor + Cable Loss + Reading - Amp Factor
 2. The emission levels that are 20dB below the official limit are not reported.

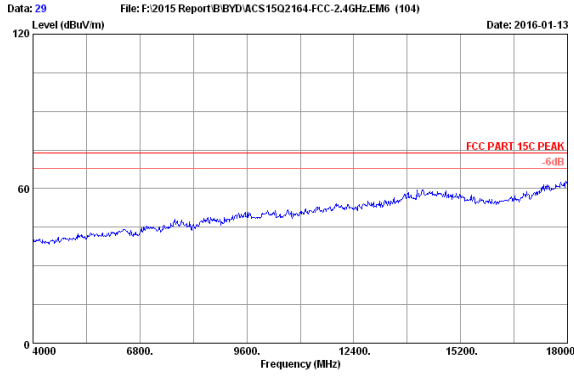

Site no. : 3m Chamber Data no. : 29
 Dis. / Ant. : 3m 2015 3115-4877 Ant. pol. : HORIZONTAL
 Limit : FCC PART 15C PEAK
 Env. / Ins. : 23.6°C/52.8%
 Engineer : Alice_yang
 EUT : Notebook
 Power rating : DC 20V From Adapter Input AC 120V/60Hz
 Test Mode : IEEE802.11g 2412MHz Tx
 R209-0184

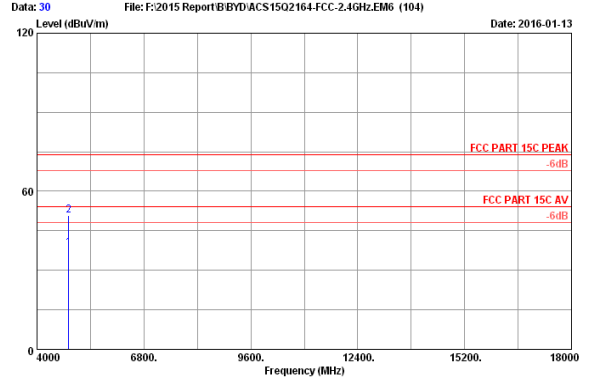

Site no. : 3m Chamber Data no. : 30
 Dis. / Ant. : 3m 2015 3115-4877 Ant. pol. : HORIZONTAL
 Limit : FCC PART 15C PEAK
 Env. / Ins. : 23.6°C/52.8%
 Engineer : Alice_yang
 EUT : Notebook
 Power rating : DC 20V From Adapter Input AC 120V/60Hz
 Test Mode : IEEE802.11g 2412MHz Tx
 R209-0184

No.	Freq. (MHz)	Ant. Factor (dB/m)	Cable Loss (dB)	AMP factor (dB)	Reading (dBuV)	Emission Level (dBuV/m)	Limits (dBuV/m)	Margin (dB)	Remark
1	4824.000	33.15	9.46	35.53	31.24	38.32	54.00	15.68	Average
2	4824.000	33.15	9.46	35.53	43.68	50.76	74.00	23.24	Peak

Remarks: 1. Emission Level= Antenna Factor + Cable Loss + Reading - Amp Factor
 2. The emission levels that are 20dB below the official limit are not reported.

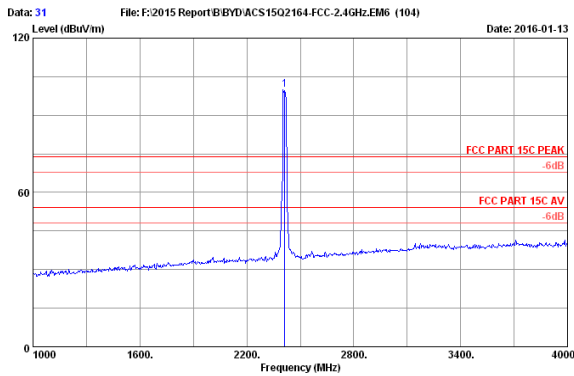

Site no. : 3m Chamber Data no. : 31
 Dis. / Ant. : 3m 2015 3115-4877 Ant. pol. : HORIZONTAL
 Limit : FCC PART 15C PEAK
 Env. / Ins. : 23.6°C/52.8%
 Engineer : Alice_yang
 EUT : Notebook
 Power rating : DC 20V From Adapter Input AC 120V/60Hz
 Test Mode : IEEE802.11g 2412MHz Tx
 R209-0184

No.	Freq. (MHz)	Ant. Factor (dB/m)	Cable Loss (dB)	AMP factor (dB)	Reading (dBuV)	Emission Level (dBuV/m)	Limits (dBuV/m)	Margin (dB)	Remark
1	2412.000	28.29	7.35	36.62	100.96	99.98	74.00	-25.98	Peak

Remarks: 1. Emission Level= Antenna Factor + Cable Loss + Reading - Amp Factor
 2. The emission levels that are 20dB below the official limit are not reported.

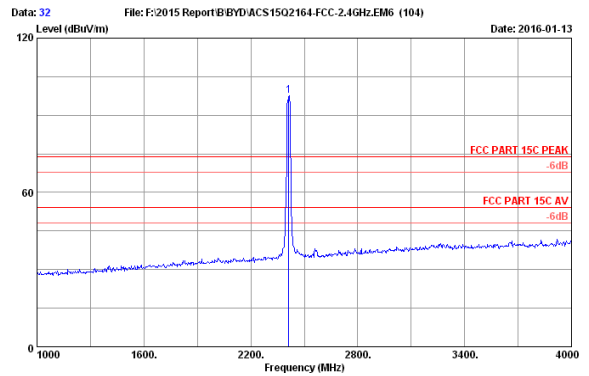

Site no. : 3m Chamber Data no. : 32
 Dis. / Ant. : 3m 2015 3115-4877 Ant. pol. : VERTICAL
 Limit : FCC PART 15C PEAK
 Env. / Ins. : 23.6°C/52.8%
 Engineer : Alice_yang
 EUT : Notebook
 Power rating : DC 20V From Adapter Input AC 120V/60Hz
 Test Mode : IEEE802.11g 2412MHz Tx
 R209-0184

No.	Freq. (MHz)	Ant. Factor (dB/m)	Cable Loss (dB)	AMP factor (dB)	Reading (dBuV)	Emission Level (dBuV/m)	Limits (dBuV/m)	Margin (dB)	Remark
1	2412.000	28.29	7.35	36.62	98.67	97.69	74.00	-23.69	Peak

Remarks: 1. Emission Level= Antenna Factor + Cable Loss + Reading - Amp Factor
 2. The emission levels that are 20dB below the official limit are not reported.

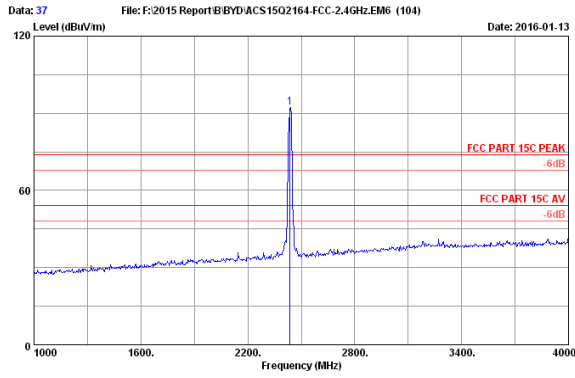

Site no. : 3m Chamber Data no. : 37
 Dis. / Ant. : 3m 2015 3115-4877 Ant. pol. : HORIZONTAL
 Limit : FCC PART 15C PEAK
 Env. / Ins. : 23.6°C/52.8%
 Engineer : Alice_yang
 EUT : Notebook
 Power rating : DC 20V From Adapter Input AC 120V/60Hz
 Test Mode : IEEE802.11g 2437MHz Tx
 RZ09-0184

No.	Freq. (MHz)	Ant. Factor (dB/m)	Cable Loss (dB)	AMP factor (dB)	Reading (dBuV)	Emission Level (dBuV/m)	Limits (dBuV/m)	Margin (dB)	Remark
1	2437.000	28.32	7.39	36.61	93.28	92.38	74.00	-18.38	Peak

Remarks: 1. Emission Level= Antenna Factor + Cable Loss + Reading - Amp Factor
 2. The emission levels that are 20dB below the official limit are not reported.

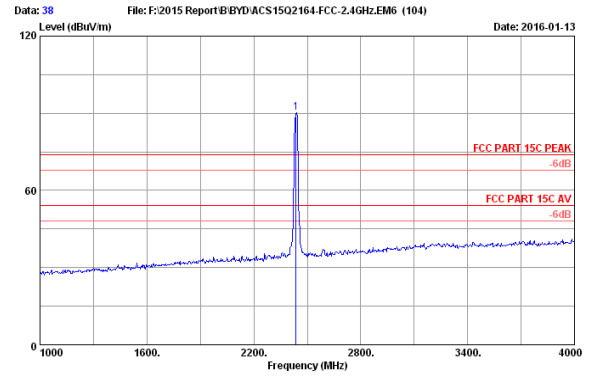

Site no. : 3m Chamber Data no. : 38
 Dis. / Ant. : 3m 2015 3115-4877 Ant. pol. : VERTICAL
 Limit : FCC PART 15C PEAK
 Env. / Ins. : 23.6°C/52.8%
 Engineer : Alice_yang
 EUT : Notebook
 Power rating : DC 20V From Adapter Input AC 120V/60Hz
 Test Mode : IEEE802.11g 2437MHz Tx
 RZ09-0184

No.	Freq. (MHz)	Ant. Factor (dB/m)	Cable Loss (dB)	AMP factor (dB)	Reading (dBuV)	Emission Level (dBuV/m)	Limits (dBuV/m)	Margin (dB)	Remark
1	2437.000	28.32	7.39	36.61	91.19	90.29	74.00	-16.29	Peak

Remarks: 1. Emission Level= Antenna Factor + Cable Loss + Reading - Amp Factor
 2. The emission levels that are 20dB below the official limit are not reported.

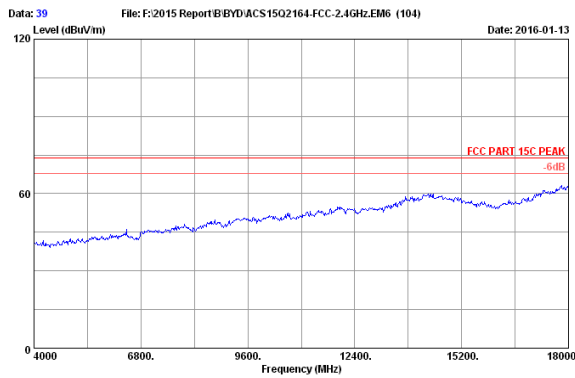

Site no. : 3m Chamber Data no. : 39
 Dis. / Ant. : 3m 2015 3115-4877 Ant. pol. : VERTICAL
 Limit : FCC PART 15C PEAK
 Env. / Ins. : 23.6°C/52.8%
 Engineer : Alice_yang
 EUT : Notebook
 Power rating : DC 20V From Adapter Input AC 120V/60Hz
 Test Mode : IEEE802.11g 2437MHz Tx
 RZ09-0184

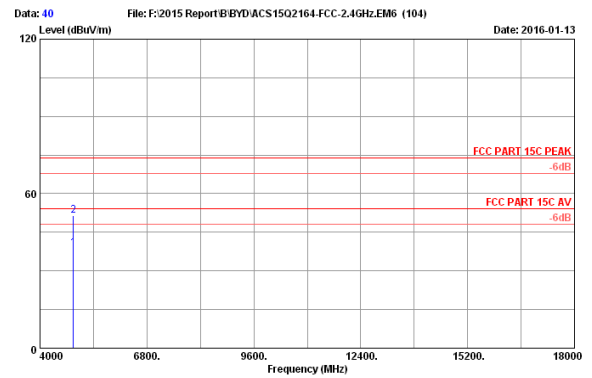

Site no. : 3m Chamber Data no. : 40
 Dis. / Ant. : 3m 2015 3115-4877 Ant. pol. : VERTICAL
 Limit : FCC PART 15C PEAK
 Env. / Ins. : 23.6°C/52.8%
 Engineer : Alice_yang
 EUT : Notebook
 Power rating : DC 20V From Adapter Input AC 120V/60Hz
 Test Mode : IEEE802.11g 2437MHz Tx
 RZ09-0184

No.	Freq. (MHz)	Ant. Factor (dB/m)	Cable Loss (dB)	AMP factor (dB)	Reading (dBuV)	Emission Level (dBuV/m)	Limits (dBuV/m)	Margin (dB)	Remark
1	4874.000	33.25	9.49	35.51	31.51	38.74	54.00	15.26	Average
2	4874.000	33.25	9.49	35.51	44.35	51.58	74.00	22.42	Peak

Remarks: 1. Emission Level= Antenna Factor + Cable Loss + Reading - Amp Factor
 2. The emission levels that are 20dB below the official limit are not reported.

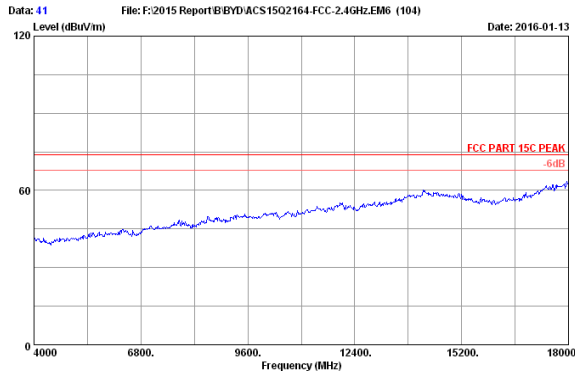

Site no. : 3m Chamber Data no. : 41
 Dis. / Ant. : 3m 2015 3115-4877 Ant. pol. : HORIZONTAL
 Limit : FCC PART 15C PEAK
 Env. / Ins. : 23.6°C/52.8%
 Engineer : Alice_yang
 EUT : Notebook
 Power rating : DC 20V From Adapter Input AC 120V/60Hz
 Test Mode : IEEE802.11g 2437MHz Tx
 R209-0184

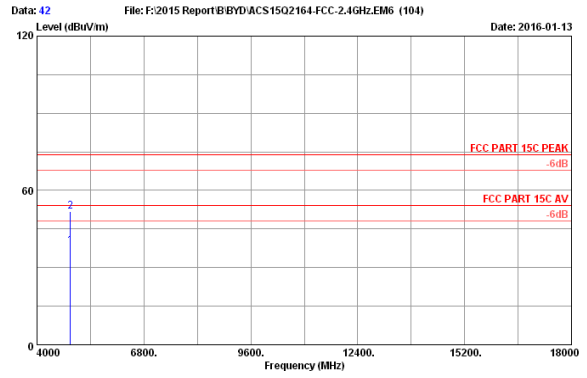

Site no. : 3m Chamber Data no. : 42
 Dis. / Ant. : 3m 2015 3115-4877 Ant. pol. : HORIZONTAL
 Limit : FCC PART 15C PEAK
 Env. / Ins. : 23.6°C/52.8%
 Engineer : Alice_yang
 EUT : Notebook
 Power rating : DC 20V From Adapter Input AC 120V/60Hz
 Test Mode : IEEE802.11g 2437MHz Tx
 R209-0184

No.	Freq. (MHz)	Ant. Factor (dB/m)	Cable Loss (dB)	AMP factor (dB)	Reading (dBuV)	Emission Level (dBuV/m)	Limits (dBuV/m)	Margin (dB)	Remark
1	4874.000	33.25	9.49	35.51	31.24	38.47	54.00	15.53	Average
2	4874.000	33.25	9.49	35.51	44.62	51.85	74.00	22.15	Peak

Remarks: 1. Emission Level= Antenna Factor + Cable Loss + Reading - Amp Factor
 2. The emission levels that are 20dB below the official limit are not reported.

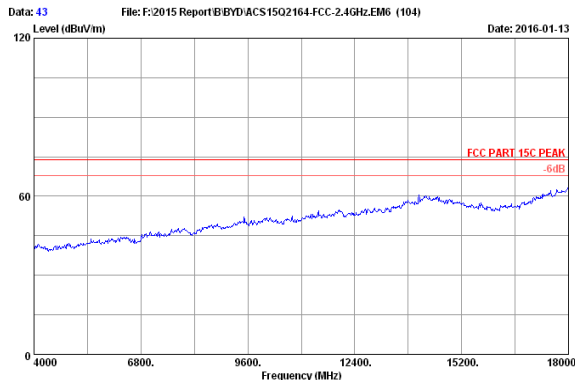

Site no. : 3m Chamber Data no. : 43
 Dis. / Ant. : 3m 2015 3115-4877 Ant. pol. : HORIZONTAL
 Limit : FCC PART 15C PEAK
 Env. / Ins. : 23.6°C/52.8%
 Engineer : Alice_yang
 EUT : Notebook
 Power rating : DC 20V From Adapter Input AC 120V/60Hz
 Test Mode : IEEE802.11g 2462MHz Tx
 R209-0184

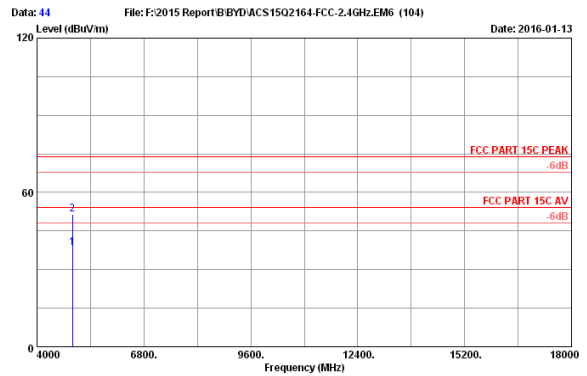

Site no. : 3m Chamber Data no. : 44
 Dis. / Ant. : 3m 2015 3115-4877 Ant. pol. : HORIZONTAL
 Limit : FCC PART 15C PEAK
 Env. / Ins. : 23.6°C/52.8%
 Engineer : Alice_yang
 EUT : Notebook
 Power rating : DC 20V From Adapter Input AC 120V/60Hz
 Test Mode : IEEE802.11g 2462MHz Tx
 R209-0184

No.	Freq. (MHz)	Ant. Factor (dB/m)	Cable Loss (dB)	AMP factor (dB)	Reading (dBuV)	Emission Level (dBuV/m)	Limits (dBuV/m)	Margin (dB)	Remark
1	4924.000	33.35	9.51	35.48	31.07	38.45	54.00	15.55	Average
2	4924.000	33.35	9.51	35.48	44.03	51.41	74.00	22.59	Peak

Remarks: 1. Emission Level= Antenna Factor + Cable Loss + Reading - Amp Factor
 2. The emission levels that are 20dB below the official limit are not reported.

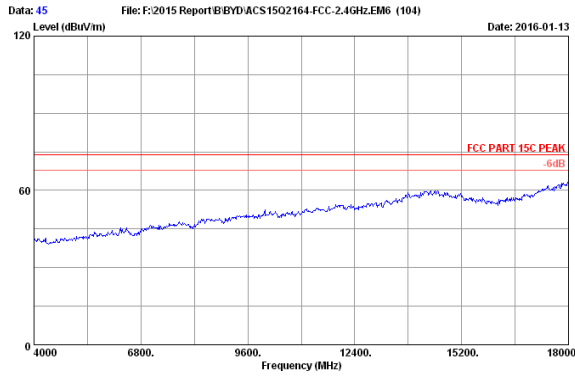

Data: 45 File: F:2015 Report\B\BYD\ACS1502164-FCC-2.4GHz.EM6 (104) Date: 2016-01-13

Site no. : 3m Chamber Data no. : 45
 Dis. / Ant. : 3m 2015 3115-4877 Ant. pol. : VERTICAL
 Limit : FCC PART 15C PEAK
 Env. / Ins. : 23.6°C/52.8%
 Engineer : Alice_yang
 EUT : Notebook
 Power rating : DC 20V From Adapter Input AC 120V/60Hz
 Test Mode : IEEE802.11g 2462MHz Tx
 RZ09-0184

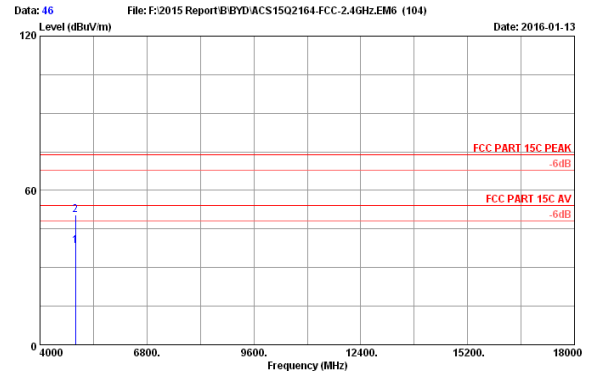

Data: 46 File: F:2015 Report\B\BYD\ACS1502164-FCC-2.4GHz.EM6 (104) Date: 2016-01-13

Site no. : 3m Chamber Data no. : 46
 Dis. / Ant. : 3m 2015 3115-4877 Ant. pol. : VERTICAL
 Limit : FCC PART 15C PEAK
 Env. / Ins. : 23.6°C/52.8%
 Engineer : Alice_yang
 EUT : Notebook
 Power rating : DC 20V From Adapter Input AC 120V/60Hz
 Test Mode : IEEE802.11g 2462MHz Tx
 RZ09-0184

No.	Freq. (MHz)	Ant. Factor (dB/m)	Cable Loss (dB)	AMP factor (dB)	Reading (dBuV)	Emission Level (dBuV/m)	Limits (dBuV/m)	Margin (dB)	Remark
1	4924.000	39.35	9.51	35.48	31.11	38.49	54.00	15.51	Average
2	4924.000	39.35	9.51	35.48	43.25	50.63	74.00	23.37	Peak

Remarks: 1. Emission Level= Antenna Factor + Cable Loss + Reading - Amp Factor
 2. The emission levels that are 20dB below the official limit are not reported.

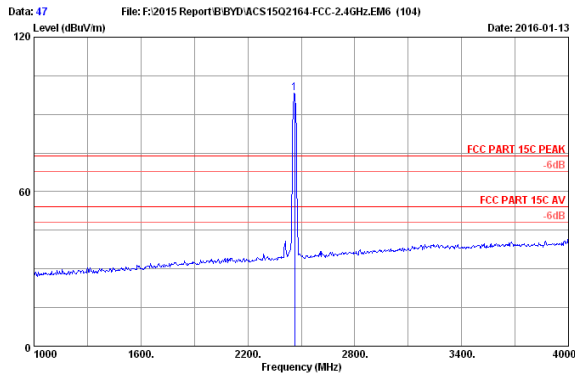

Data: 47 File: F:2015 Report\B\BYD\ACS1502164-FCC-2.4GHz.EM6 (104) Date: 2016-01-13

Site no. : 3m Chamber Data no. : 47
 Dis. / Ant. : 3m 2015 3115-4877 Ant. pol. : HORIZONTAL
 Limit : FCC PART 15C PEAK
 Env. / Ins. : 23.6°C/52.8%
 Engineer : Alice_yang
 EUT : Notebook
 Power rating : DC 20V From Adapter Input AC 120V/60Hz
 Test Mode : IEEE802.11g 2462MHz Tx
 RZ09-0184

No.	Freq. (MHz)	Ant. Factor (dB/m)	Cable Loss (dB)	AMP factor (dB)	Reading (dBuV)	Emission Level (dBuV/m)	Limits (dBuV/m)	Margin (dB)	Remark
1	2462.000	28.35	7.43	36.60	99.18	98.36	74.00	-24.36	Peak

Remarks: 1. Emission Level= Antenna Factor + Cable Loss + Reading - Amp Factor
 2. The emission levels that are 20dB below the official limit are not reported.

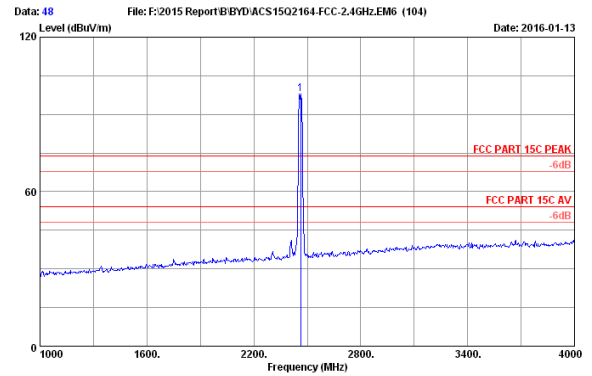

Data: 48 File: F:2015 Report\B\BYD\ACS1502164-FCC-2.4GHz.EM6 (104) Date: 2016-01-13

Site no. : 3m Chamber Data no. : 48
 Dis. / Ant. : 3m 2015 3115-4877 Ant. pol. : VERTICAL
 Limit : FCC PART 15C PEAK
 Env. / Ins. : 23.6°C/52.8%
 Engineer : Alice_yang
 EUT : Notebook
 Power rating : DC 20V From Adapter Input AC 120V/60Hz
 Test Mode : IEEE802.11g 2462MHz Tx
 RZ09-0184

No.	Freq. (MHz)	Ant. Factor (dB/m)	Cable Loss (dB)	AMP factor (dB)	Reading (dBuV)	Emission Level (dBuV/m)	Limits (dBuV/m)	Margin (dB)	Remark
1	2462.000	28.35	7.43	36.60	98.65	97.83	74.00	-23.83	Peak

Remarks: 1. Emission Level= Antenna Factor + Cable Loss + Reading - Amp Factor
 2. The emission levels that are 20dB below the official limit are not reported.

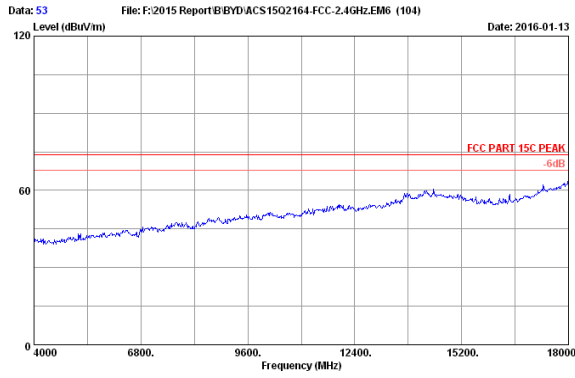

Site no. : 3m Chamber Data no. : 53
 Dis. / Ant. : 3m 2015 3115-4877 Ant. pol. : VERTICAL
 Limit : FCC PART 15C PEAK
 Env. / Ins. : 23.6°C/52.8%
 Engineer : Alice_yang
 EUT : Notebook
 Power rating : DC 20V From Adapter Input AC 120V/60Hz
 Test Mode : IEEE802.11nHT20 2412MHz Tx
 RZ09-0184

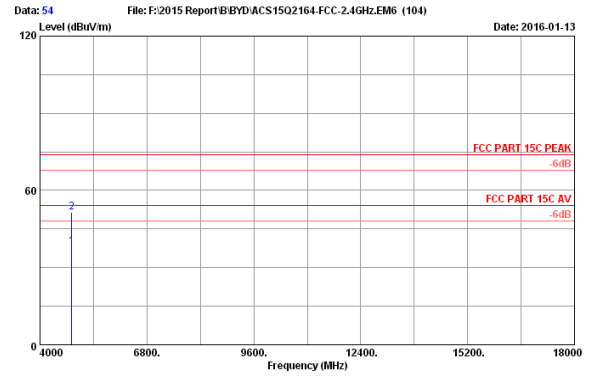

Site no. : 3m Chamber Data no. : 54
 Dis. / Ant. : 3m 2015 3115-4877 Ant. pol. : VERTICAL
 Limit : FCC PART 15C PEAK
 Env. / Ins. : 23.6°C/52.8%
 Engineer : Alice_yang
 EUT : Notebook
 Power rating : DC 20V From Adapter Input AC 120V/60Hz
 Test Mode : IEEE802.11nHT20 2412MHz Tx
 RZ09-0184

No.	Freq. (MHz)	Ant. Factor (dB/m)	Cable Loss (dB)	AMP factor (dB)	Reading (dBuV)	Emission Level (dBuV/m)	Limits (dBuV/m)	Margin (dB)	Remark
1	4824.000	33.15	9.46	35.53	30.89	37.97	54.00	16.03	Average
2	4824.000	33.15	9.46	35.53	44.35	51.43	74.00	22.57	Peak

Remarks: 1. Emission Level= Antenna Factor + Cable Loss + Reading - Amp Factor
 2. The emission levels that are 20dB below the official limit are not reported.

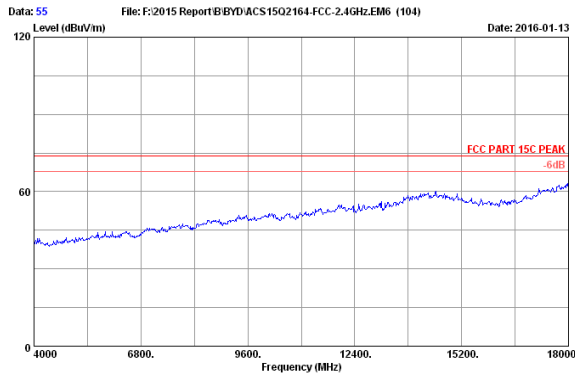

Site no. : 3m Chamber Data no. : 55
 Dis. / Ant. : 3m 2015 3115-4877 Ant. pol. : HORIZONTAL
 Limit : FCC PART 15C PEAK
 Env. / Ins. : 23.6°C/52.8%
 Engineer : Alice_yang
 EUT : Notebook
 Power rating : DC 20V From Adapter Input AC 120V/60Hz
 Test Mode : IEEE802.11nHT20 2412MHz TX
 RZ09-0184

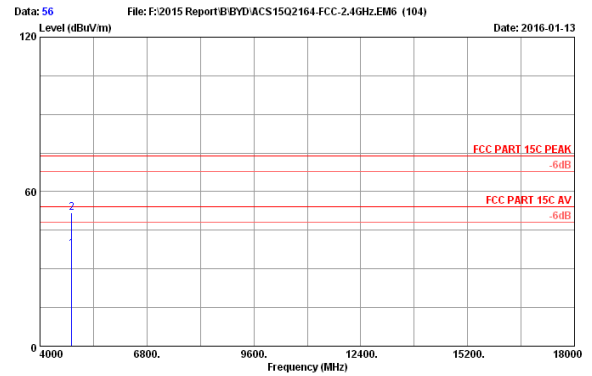

Site no. : 3m Chamber Data no. : 56
 Dis. / Ant. : 3m 2015 3115-4877 Ant. pol. : HORIZONTAL
 Limit : FCC PART 15C PEAK
 Env. / Ins. : 23.6°C/52.8%
 Engineer : Alice_yang
 EUT : Notebook
 Power rating : DC 20V From Adapter Input AC 120V/60Hz
 Test Mode : IEEE802.11nHT20 2412MHz Tx
 RZ09-0184

No.	Freq. (MHz)	Ant. Factor (dB/m)	Cable Loss (dB)	AMP factor (dB)	Reading (dBuV)	Emission Level (dBuV/m)	Limits (dBuV/m)	Margin (dB)	Remark
1	4824.000	33.15	9.46	35.53	30.57	37.65	54.00	16.35	Average
2	4824.000	33.15	9.46	35.53	44.75	51.83	74.00	22.17	Peak

Remarks: 1. Emission Level= Antenna Factor + Cable Loss + Reading - Amp Factor
 2. The emission levels that are 20dB below the official limit are not reported.

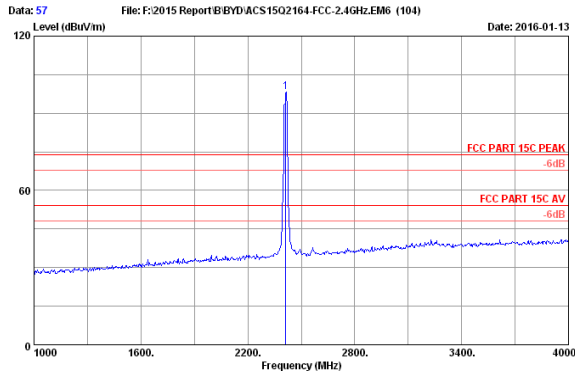

Site no. : 3m Chamber Data no. : 57
 Dis. / Ant. : 3m 2015 3115-4877 Ant. pol. : VERTICAL
 Limit : FCC PART 15C PEAK
 Env. / Ins. : 23.6°C/52.8%
 Engineer : Alice_yang
 EUT : Notebook
 Power rating : DC 20V From Adapter Input AC 120V/60Hz
 Test Mode : IEEE802.11nHT20 2412MHz Tx
 RZ09-0184

No.	Freq. (MHz)	Ant. Factor (dB/m)	Cable Loss (dB)	AMP factor (dB)	Reading (dBuV)	Emission Level (dBuV/m)	Limits (dBuV/m)	Margin (dB)	Remark
1	2412.000	28.29	7.35	36.62	99.26	98.28	74.00	-24.28	Peak

Remarks: 1. Emission Level= Antenna Factor + Cable Loss + Reading - Amp Factor
 2. The emission levels that are 20dB below the official limit are not reported.

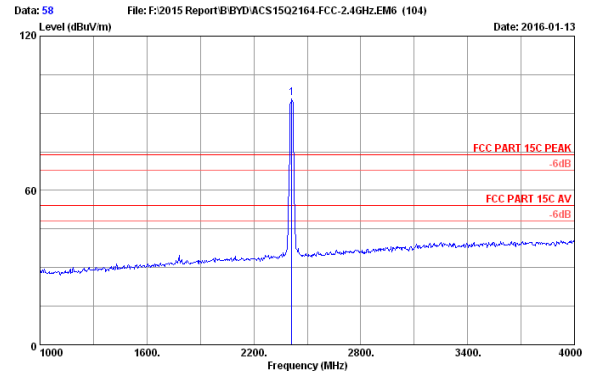

Site no. : 3m Chamber Data no. : 58
 Dis. / Ant. : 3m 2015 3115-4877 Ant. pol. : HORIZONTAL
 Limit : FCC PART 15C PEAK
 Env. / Ins. : 23.6°C/52.8%
 Engineer : Alice_yang
 EUT : Notebook
 Power rating : DC 20V From Adapter Input AC 120V/60Hz
 Test Mode : IEEE802.11nHT20 2412MHz Tx
 RZ09-0184

No.	Freq. (MHz)	Ant. Factor (dB/m)	Cable Loss (dB)	AMP factor (dB)	Reading (dBuV)	Emission Level (dBuV/m)	Limits (dBuV/m)	Margin (dB)	Remark
1	2412.000	28.29	7.35	36.62	96.92	95.94	74.00	-21.94	Peak

Remarks: 1. Emission Level= Antenna Factor + Cable Loss + Reading - Amp Factor
 2. The emission levels that are 20dB below the official limit are not reported.

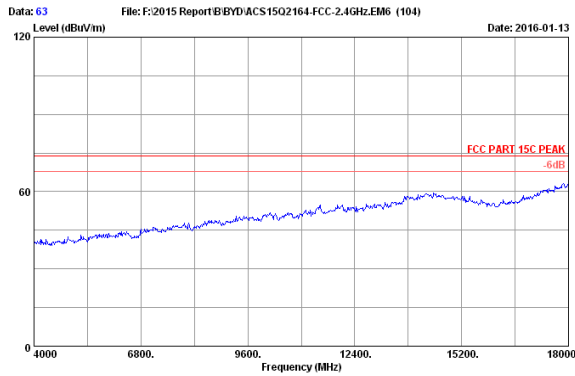

Site no. : 3m Chamber Data no. : 63
 Dis. / Ant. : 3m 2015 3115-4877 Ant. pol. : HORIZONTAL
 Limit : FCC PART 15C PEAK
 Env. / Ins. : 23.6°C/52.8%
 Engineer : Alice_yang
 EUT : Notebook
 Power rating : DC 20V From Adapter Input AC 120V/60Hz
 Test Mode : IEEE802.11nHT20 2437MHz Tx
 RZ09-0184

No.	Freq. (MHz)	Ant. Factor (dB/m)	Cable Loss (dB)	AMP factor (dB)	Reading (dBuV)	Emission Level (dBuV/m)	Limits (dBuV/m)	Margin (dB)	Remark
1	4874.000	33.25	9.49	35.51	31.28	38.51	54.00	15.49	Average
2	4874.000	33.25	9.49	35.51	44.18	51.41	74.00	22.59	Peak

Remarks: 1. Emission Level= Antenna Factor + Cable Loss + Reading - Amp Factor
 2. The emission levels that are 20dB below the official limit are not reported.

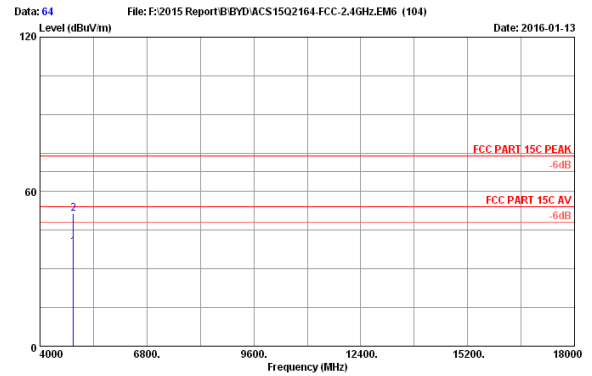

Site no. : 3m Chamber Data no. : 64
 Dis. / Ant. : 3m 2015 3115-4877 Ant. pol. : HORIZONTAL
 Limit : FCC PART 15C PEAK
 Env. / Ins. : 23.6°C/52.8%
 Engineer : Alice_yang
 EUT : Notebook
 Power rating : DC 20V From Adapter Input AC 120V/60Hz
 Test Mode : IEEE802.11nHT20 2437MHz Tx
 RZ09-0184

No.	Freq. (MHz)	Ant. Factor (dB/m)	Cable Loss (dB)	AMP factor (dB)	Reading (dBuV)	Emission Level (dBuV/m)	Limits (dBuV/m)	Margin (dB)	Remark
1	4874.000	33.25	9.49	35.51	31.28	38.51	54.00	15.49	Average
2	4874.000	33.25	9.49	35.51	44.18	51.41	74.00	22.59	Peak

Remarks: 1. Emission Level= Antenna Factor + Cable Loss + Reading - Amp Factor
 2. The emission levels that are 20dB below the official limit are not reported.

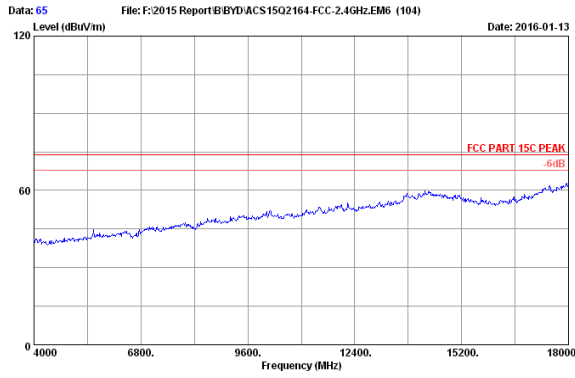

Site no. : 3m Chamber Data no. : 65
 Dis. / Ant. : 3m 2015 3115-4877 Ant. pol. : VERTICAL
 Limit : FCC PART 15C PEAK
 Env. / Ins. : 23.6°C/52.8%
 Engineer : Alice_yang
 EUT : Notebook
 Power rating : DC 20V From Adapter Input AC 120V/60Hz
 Test Mode : IEEE802.11nHT20 2437MHz Tx
 RZ09-0184

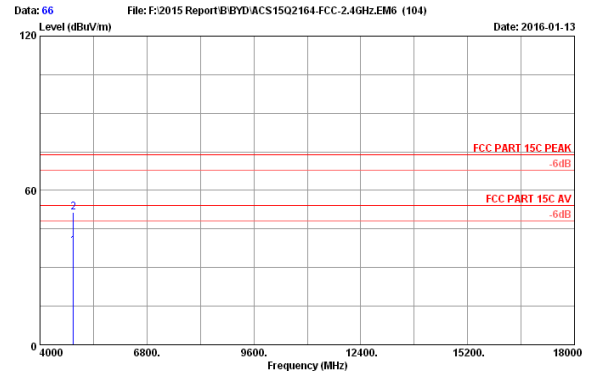

Site no. : 3m Chamber Data no. : 66
 Dis. / Ant. : 3m 2015 3115-4877 Ant. pol. : VERTICAL
 Limit : FCC PART 15C PEAK
 Env. / Ins. : 23.6°C/52.8%
 Engineer : Alice_yang
 EUT : Notebook
 Power rating : DC 20V From Adapter Input AC 120V/60Hz
 Test Mode : IEEE802.11nHT20 2437MHz Tx
 RZ09-0184

No.	Freq. (MHz)	Ant. Factor (dB/m)	Cable Loss (dB)	AMP factor (dB)	Reading (dBuV)	Emission Level (dBuV/m)	Limits (dBuV/m)	Margin (dB)	Remark
1	4874.000	39.25	9.49	35.51	31.05	38.28	54.00	15.72	Average
2	4874.000	39.25	9.49	35.51	44.35	51.58	74.00	22.42	Peak

Remarks: 1. Emission Level= Antenna Factor + Cable Loss + Reading -Amp Factor
 2. The emission levels that are 20dB below the official limit are not reported.

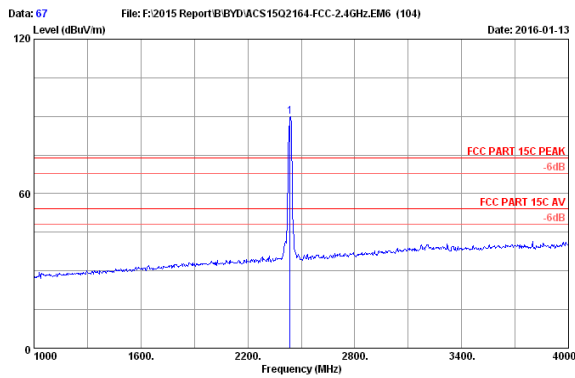

Site no. : 3m Chamber Data no. : 67
 Dis. / Ant. : 3m 2015 3115-4877 Ant. pol. : HORIZONTAL
 Limit : FCC PART 15C PEAK
 Env. / Ins. : 23.6°C/52.8%
 Engineer : Alice_yang
 EUT : Notebook
 Power rating : DC 20V From Adapter Input AC 120V/60Hz
 Test Mode : IEEE802.11nHT20 2437MHz Tx
 RZ09-0184

No.	Freq. (MHz)	Ant. Factor (dB/m)	Cable Loss (dB)	AMP factor (dB)	Reading (dBuV)	Emission Level (dBuV/m)	Limits (dBuV/m)	Margin (dB)	Remark
1	2437.000	28.32	7.39	36.61	90.71	89.81	74.00	-15.81	Peak

Remarks: 1. Emission Level= Antenna Factor + Cable Loss + Reading -Amp Factor
 2. The emission levels that are 20dB below the official limit are not reported.

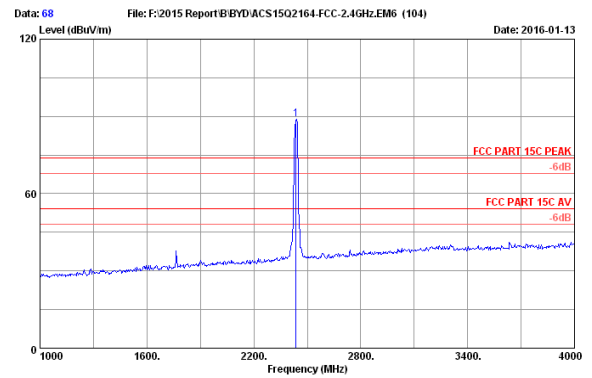

Site no. : 3m Chamber Data no. : 68
 Dis. / Ant. : 3m 2015 3115-4877 Ant. pol. : VERTICAL
 Limit : FCC PART 15C PEAK
 Env. / Ins. : 23.6°C/52.8%
 Engineer : Alice_yang
 EUT : Notebook
 Power rating : DC 20V From Adapter Input AC 120V/60Hz
 Test Mode : IEEE802.11nHT20 2437MHz Tx
 RZ09-0184

No.	Freq. (MHz)	Ant. Factor (dB/m)	Cable Loss (dB)	AMP factor (dB)	Reading (dBuV)	Emission Level (dBuV/m)	Limits (dBuV/m)	Margin (dB)	Remark
1	2437.000	28.32	7.39	36.61	89.77	88.87	74.00	-14.87	Peak

Remarks: 1. Emission Level= Antenna Factor + Cable Loss + Reading -Amp Factor
 2. The emission levels that are 20dB below the official limit are not reported.

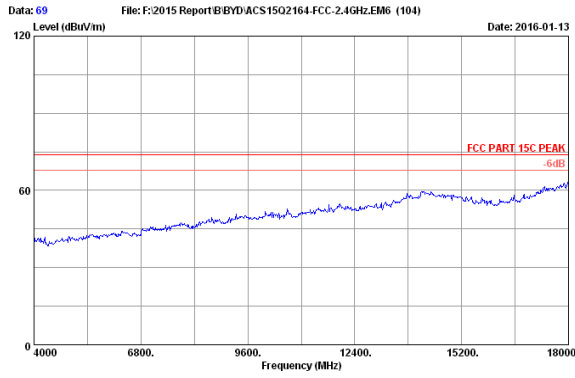

Site no. : 3m Chamber Data no. : 69
 Dis. / Ant. : 3m 2015 3115-4877 Ant. pol. : HORIZONTAL
 Limit : FCC PART 15C PEAK
 Env. / Ins. : 23.6°C/52.8%
 Engineer : Alice_yang
 EUT : Notebook
 Power rating : DC 20V From Adapter Input AC 120V/60Hz
 Test Mode : IEEE802.11nHT20 2462MHz Tx
 RZ09-0184

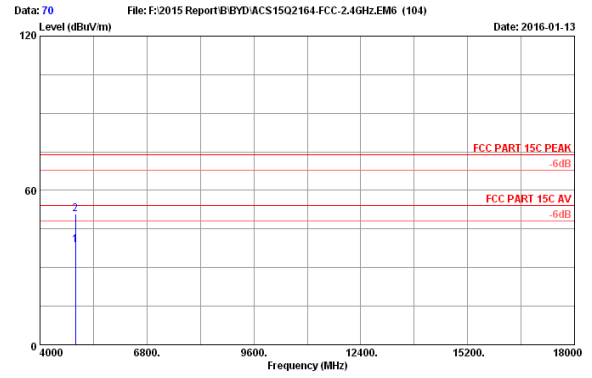

Site no. : 3m Chamber Data no. : 70
 Dis. / Ant. : 3m 2015 3115-4877 Ant. pol. : HORIZONTAL
 Limit : FCC PART 15C PEAK
 Env. / Ins. : 23.6°C/52.8%
 Engineer : Alice_yang
 EUT : Notebook
 Power rating : DC 20V From Adapter Input AC 120V/60Hz
 Test Mode : IEEE802.11nHT20 2462MHz Tx
 RZ09-0184

No.	Freq. (MHz)	Ant. Factor (dB/m)	Cable Loss (dB)	AMP factor (dB)	Reading (dBuV)	Emission Level (dBuV/m)	Limits (dBuV/m)	Margin (dB)	Remark
1	4924.000	33.35	9.51	35.48	31.39	38.77	54.00	15.23	Average
2	4924.000	33.35	9.51	35.48	43.38	50.76	74.00	23.24	Peak

Remarks: 1. Emission Level= Antenna Factor + Cable Loss + Reading - Amp Factor
 2. The emission levels that are 20dB below the official limit are not reported.

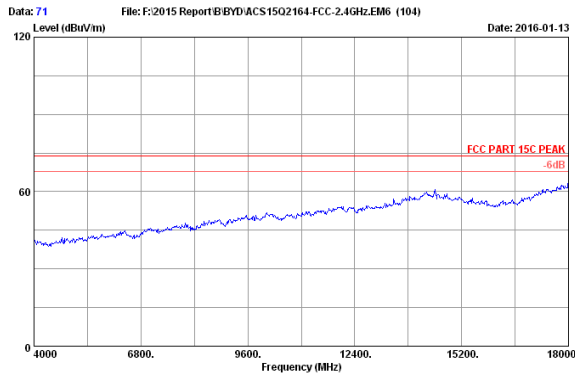

Site no. : 3m Chamber Data no. : 71
 Dis. / Ant. : 3m 2015 3115-4877 Ant. pol. : VERTICAL
 Limit : FCC PART 15C PEAK
 Env. / Ins. : 23.6°C/52.8%
 Engineer : Alice_yang
 EUT : Notebook
 Power rating : DC 20V From Adapter Input AC 120V/60Hz
 Test Mode : IEEE802.11nHT20 2462MHz TX
 RZ09-0184

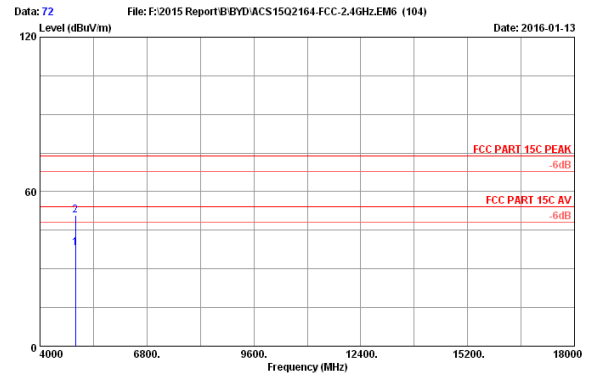

Site no. : 3m Chamber Data no. : 72
 Dis. / Ant. : 3m 2015 3115-4877 Ant. pol. : VERTICAL
 Limit : FCC PART 15C PEAK
 Env. / Ins. : 23.6°C/52.8%
 Engineer : Alice_yang
 EUT : Notebook
 Power rating : DC 20V From Adapter Input AC 120V/60Hz
 Test Mode : IEEE802.11nHT20 2462MHz Tx
 RZ09-0184

No.	Freq. (MHz)	Ant. Factor (dB/m)	Cable Loss (dB)	AMP factor (dB)	Reading (dBuV)	Emission Level (dBuV/m)	Limits (dBuV/m)	Margin (dB)	Remark
1	4924.000	33.35	9.51	35.48	30.70	38.08	54.00	15.92	Average
2	4924.000	33.35	9.51	35.48	43.28	50.66	74.00	23.34	Peak

Remarks: 1. Emission Level= Antenna Factor + Cable Loss + Reading - Amp Factor
 2. The emission levels that are 20dB below the official limit are not reported.

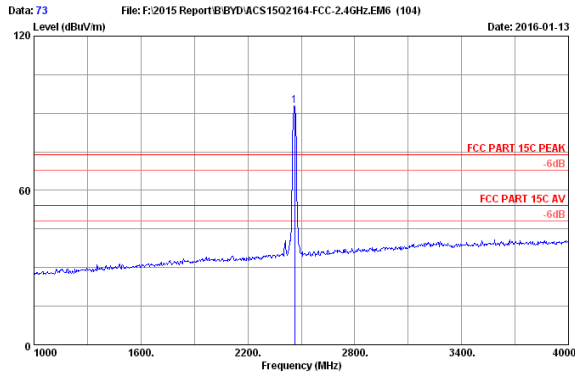

Site no. : 3m Chamber Data no. : 73
 Dis. / Ant. : 3m 2015 3115-4877 Ant. pol. : VERTICAL
 Limit : FCC PART 15C PEAK
 Env. / Ins. : 23.6°C/52.8%
 Engineer : Alice_yang
 EUT : Notebook
 Power rating : DC 20V From Adapter Input AC 120V/60Hz
 Test Mode : IEEE802.11nHT20 2462MHz Tx
 RZ09-0184

No.	Freq. (MHz)	Ant. Factor (dB/m)	Cable Loss (dB)	AMP factor (dB)	Reading (dBuV)	Emission Level (dBuV/m)	Limits (dBuV/m)	Margin (dB)	Remark
1	2462.000	28.35	7.43	36.60	93.71	92.89	74.00	-18.89	Peak

Remarks: 1. Emission Level= Antenna Factor + Cable Loss + Reading - Amp Factor
 2. The emission levels that are 20dB below the official limit are not reported.

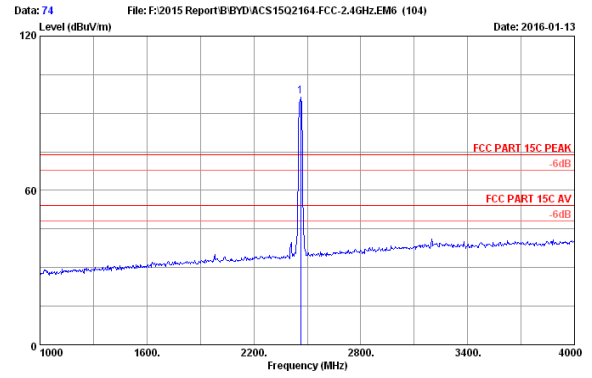

Site no. : 3m Chamber Data no. : 74
 Dis. / Ant. : 3m 2015 3115-4877 Ant. pol. : HORIZONTAL
 Limit : FCC PART 15C PEAK
 Env. / Ins. : 23.6°C/52.8%
 Engineer : Alice_yang
 EUT : Notebook
 Power rating : DC 20V From Adapter Input AC 120V/60Hz
 Test Mode : IEEE802.11nHT20 2462MHz Tx
 RZ09-0184

No.	Freq. (MHz)	Ant. Factor (dB/m)	Cable Loss (dB)	AMP factor (dB)	Reading (dBuV)	Emission Level (dBuV/m)	Limits (dBuV/m)	Margin (dB)	Remark
1	2462.000	28.35	7.43	36.60	97.32	96.50	74.00	-22.50	Peak

Remarks: 1. Emission Level= Antenna Factor + Cable Loss + Reading - Amp Factor
 2. The emission levels that are 20dB below the official limit are not reported.

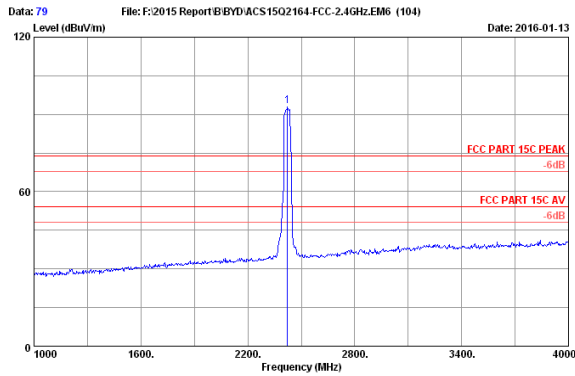

Site no. : 3m Chamber Data no. : 79
 Dis. / Ant. : 3m 2015 3115-4877 Ant. pol. : HORIZONTAL
 Limit : FCC PART 15C PEAK
 Env. / Ins. : 23.6°C/52.8%
 Engineer : Alice_yang
 EUT : Notebook
 Power rating : DC 20V From Adapter Input AC 120V/60Hz
 Test Mode : IEEE802.11nHT40 2422MHz Tx
 RZ09-0184

No.	Freq. (MHz)	Ant. Factor (dB/m)	Cable Loss (dB)	AMP factor (dB)	Reading (dBuV)	Emission Level (dBuV/m)	Limits (dBuV/m)	Margin (dB)	Remark
1	2422.000	28.31	7.35	36.61	94.06	93.11	74.00	-19.11	Peak

Remarks: 1. Emission Level= Antenna Factor + Cable Loss + Reading - Amp Factor
 2. The emission levels that are 20dB below the official limit are not reported.

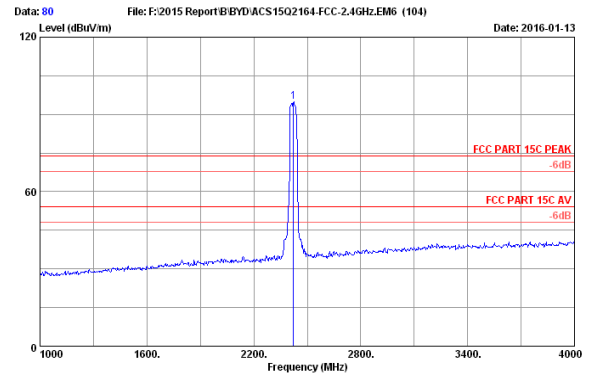

Site no. : 3m Chamber Data no. : 80
 Dis. / Ant. : 3m 2015 3115-4877 Ant. pol. : VERTICAL
 Limit : FCC PART 15C PEAK
 Env. / Ins. : 23.6°C/52.8%
 Engineer : Alice_yang
 EUT : Notebook
 Power rating : DC 20V From Adapter Input AC 120V/60Hz
 Test Mode : IEEE802.11nHT40 2422MHz Tx
 RZ09-0184

No.	Freq. (MHz)	Ant. Factor (dB/m)	Cable Loss (dB)	AMP factor (dB)	Reading (dBuV)	Emission Level (dBuV/m)	Limits (dBuV/m)	Margin (dB)	Remark
1	2422.000	28.31	7.35	36.61	95.97	95.02	74.00	-21.02	Peak

Remarks: 1. Emission Level= Antenna Factor + Cable Loss + Reading - Amp Factor
 2. The emission levels that are 20dB below the official limit are not reported.

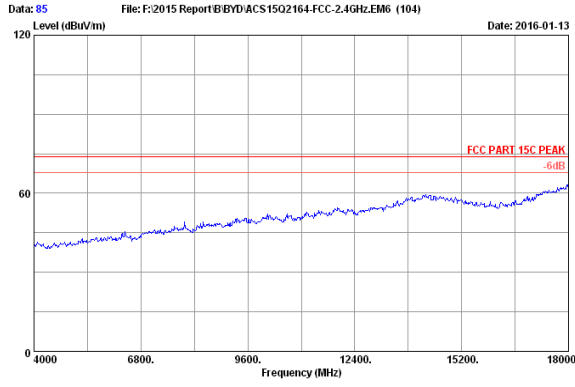

Site no. : 3m Chamber Data no. : 85
 Dis. / Ant. : 3m 2015 3115-4877 Ant. pol. : VERTICAL
 Limit : FCC PART 15C PEAK
 Env. / Ins. : 23.6°C/52.8%
 Engineer : Alice_yang
 EUT : Notebook
 Power rating : DC 20V From Adapter Input AC 120V/60Hz
 Test Mode : IEEE802.11nHT40 2422MHz Tx
 RZ09-0184

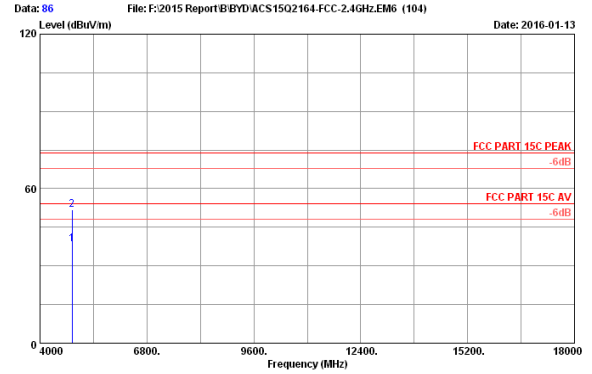

Site no. : 3m Chamber Data no. : 86
 Dis. / Ant. : 3m 2015 3115-4877 Ant. pol. : VERTICAL
 Limit : FCC PART 15C PEAK
 Env. / Ins. : 23.6°C/52.8%
 Engineer : Alice_yang
 EUT : Notebook
 Power rating : DC 20V From Adapter Input AC 120V/60Hz
 Test Mode : IEEE802.11nHT40 2422MHz Tx
 RZ09-0184

No.	Freq. (MHz)	Ant. Factor (dB/m)	Cable Loss (dB)	AMP factor (dB)	Reading (dBuV)	Emission Level (dBuV/m)	Limits (dBuV/m)	Margin (dB)	Remark
1	4844.000	33.19	9.47	35.52	31.37	38.51	54.00	15.49	Average
2	4844.000	33.19	9.47	35.52	44.54	51.68	74.00	22.32	Peak

Remarks: 1. Emission Level= Antenna Factor + Cable Loss + Reading - Amp Factor
 2. The emission levels that are 20dB below the official limit are not reported.

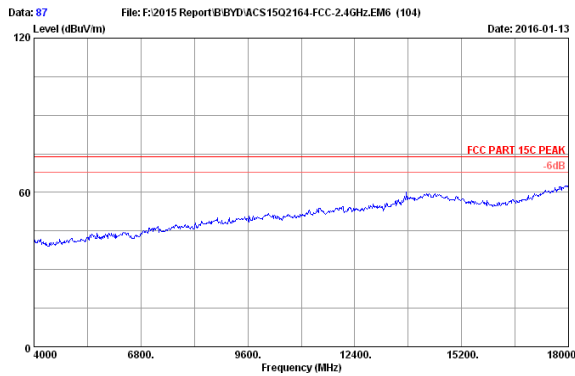

Site no. : 3m Chamber Data no. : 87
 Dis. / Ant. : 3m 2015 3115-4877 Ant. pol. : HORIZONTAL
 Limit : FCC PART 15C PEAK
 Env. / Ins. : 23.6°C/52.8%
 Engineer : Alice_yang
 EUT : Notebook
 Power rating : DC 20V From Adapter Input AC 120V/60Hz
 Test Mode : IEEE802.11nHT40 2422MHz Tx
 RZ09-0184

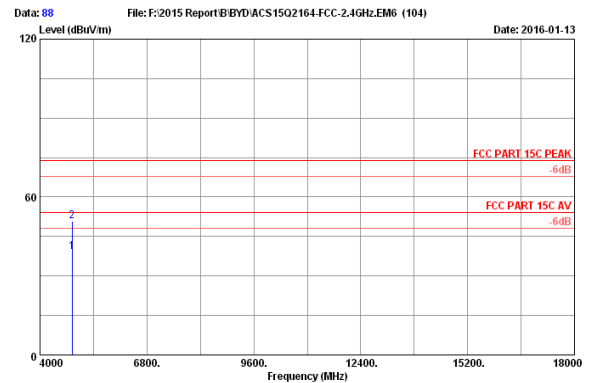

Site no. : 3m Chamber Data no. : 88
 Dis. / Ant. : 3m 2015 3115-4877 Ant. pol. : HORIZONTAL
 Limit : FCC PART 15C PEAK
 Env. / Ins. : 23.6°C/52.8%
 Engineer : Alice_yang
 EUT : Notebook
 Power rating : DC 20V From Adapter Input AC 120V/60Hz
 Test Mode : IEEE802.11nHT40 2422MHz Tx
 RZ09-0184

No.	Freq. (MHz)	Ant. Factor (dB/m)	Cable Loss (dB)	AMP factor (dB)	Reading (dBuV)	Emission Level (dBuV/m)	Limits (dBuV/m)	Margin (dB)	Remark
1	4844.000	33.19	9.47	35.52	32.07	39.21	54.00	14.79	Average
2	4844.000	33.19	9.47	35.52	43.66	50.80	74.00	23.20	Peak

Remarks: 1. Emission Level= Antenna Factor + Cable Loss + Reading - Amp Factor
 2. The emission levels that are 20dB below the official limit are not reported.

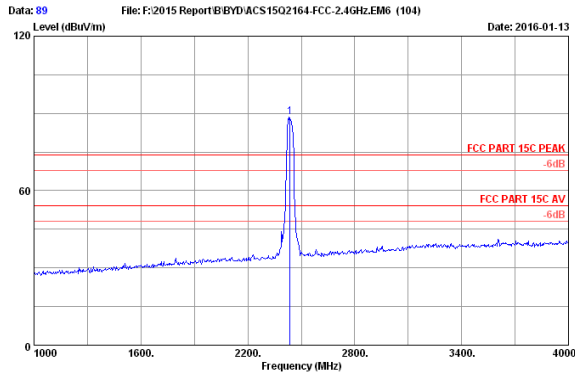

Site no. : 3m Chamber Data no. : 89
 Dis. / Ant. : 3m 2015 3115-4877 Ant. pol. : VERTICAL
 Limit : FCC PART 15C PEAK
 Env. / Ins. : 23.6°C/52.8%
 Engineer : Alice_yang
 EUT : Notebook
 Power rating : DC 20V From Adapter Input AC 120V/60Hz
 Test Mode : IEEE802.11nHT40 2437MHz Tx
 R209-0184

No.	Freq. (MHz)	Ant. Factor (dB/m)	Cable Loss (dB)	AMP factor (dB)	Reading (dBuV)	Emission Level (dBuV/m)	Limits (dBuV/m)	Margin (dB)	Remark
1	2437.000	28.32	7.39	36.61	89.62	88.72	74.00	-14.72	Peak

Remarks: 1. Emission Level= Antenna Factor + Cable Loss + Reading -Amp Factor
 2. The emission levels that are 20dB below the official limit are not reported.

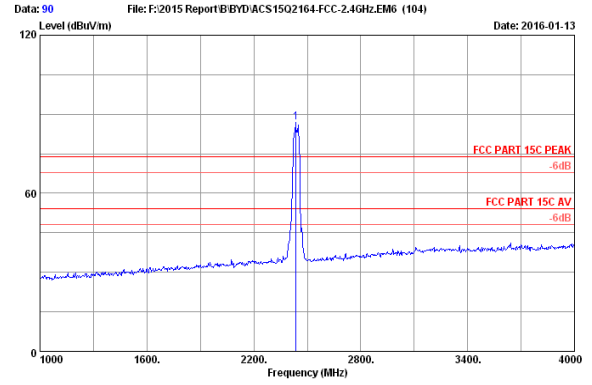

Site no. : 3m Chamber Data no. : 90
 Dis. / Ant. : 3m 2015 3115-4877 Ant. pol. : HORIZONTAL
 Limit : FCC PART 15C PEAK
 Env. / Ins. : 23.6°C/52.8%
 Engineer : Alice_yang
 EUT : Notebook
 Power rating : DC 20V From Adapter Input AC 120V/60Hz
 Test Mode : IEEE802.11nHT40 2437MHz Tx
 R209-0184

No.	Freq. (MHz)	Ant. Factor (dB/m)	Cable Loss (dB)	AMP factor (dB)	Reading (dBuV)	Emission Level (dBuV/m)	Limits (dBuV/m)	Margin (dB)	Remark
1	2437.000	28.32	7.39	36.61	87.78	86.88	74.00	-12.88	Peak

Remarks: 1. Emission Level= Antenna Factor + Cable Loss + Reading -Amp Factor
 2. The emission levels that are 20dB below the official limit are not reported.

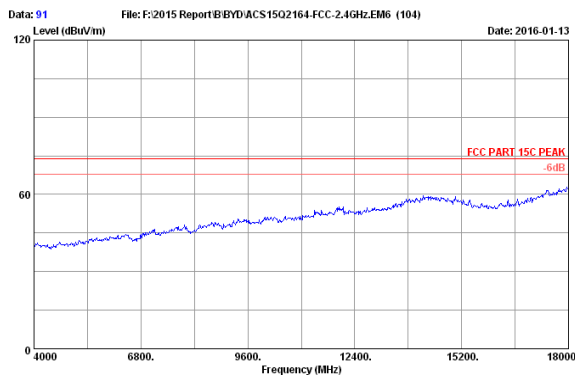

Site no. : 3m Chamber Data no. : 91
 Dis. / Ant. : 3m 2015 3115-4877 Ant. pol. : HORIZONTAL
 Limit : FCC PART 15C PEAK
 Env. / Ins. : 23.6°C/52.8%
 Engineer : Alice_yang
 EUT : Notebook
 Power rating : DC 20V From Adapter Input AC 120V/60Hz
 Test Mode : IEEE802.11nHT40 2437MHz Tx
 R209-0184

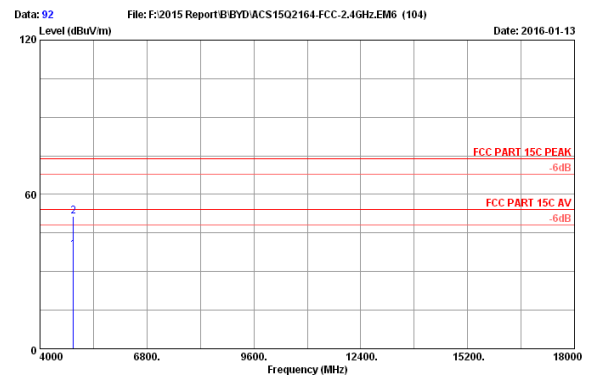

Site no. : 3m Chamber Data no. : 92
 Dis. / Ant. : 3m 2015 3115-4877 Ant. pol. : HORIZONTAL
 Limit : FCC PART 15C PEAK
 Env. / Ins. : 23.6°C/52.8%
 Engineer : Alice_yang
 EUT : Notebook
 Power rating : DC 20V From Adapter Input AC 120V/60Hz
 Test Mode : IEEE802.11nHT40 2437MHz Tx
 R209-0184

No.	Freq. (MHz)	Ant. Factor (dB/m)	Cable Loss (dB)	AMP factor (dB)	Reading (dBuV)	Emission Level (dBuV/m)	Limits (dBuV/m)	Margin (dB)	Remark
1	4874.000	33.25	9.49	35.51	31.27	38.50	54.00	15.50	Average
2	4874.000	33.25	9.49	35.51	44.37	51.60	74.00	22.40	Peak

Remarks: 1. Emission Level= Antenna Factor + Cable Loss + Reading -Amp Factor
 2. The emission levels that are 20dB below the official limit are not reported.

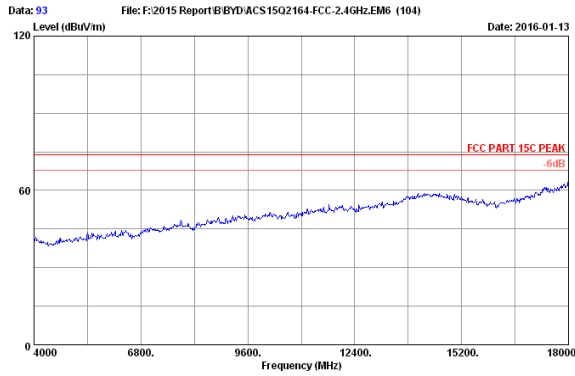

Data: 93 File: F:\2015 Report\BYD\ACS1502164-FCC-2.4GHz.EM6 (104) Date: 2016-01-13

Site no. : 3m Chamber Data no. : 93
 Dis. / Ant. : 3m 2015 3115-4877 Ant. pol. : VERTICAL
 Limit : FCC PART 15C PEAK
 Env. / Ins. : 23.6°C/52.8%
 Engineer : Alice_yang
 EUT : Notebook
 Power rating : DC 20V From Adapter Input AC 120V/60Hz
 Test Mode : IEEE802.11nHT40 2437MHz Tx
 RZ09-0184

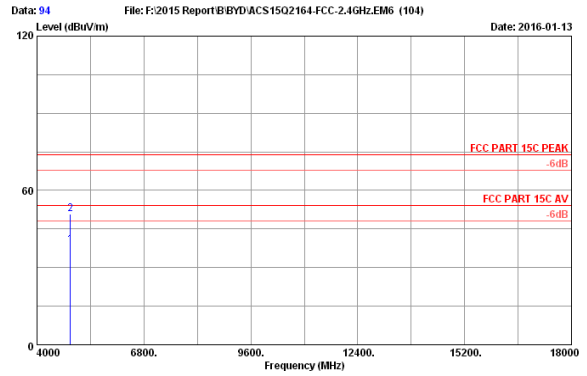

Data: 94 File: F:\2015 Report\BYD\ACS1502164-FCC-2.4GHz.EM6 (104) Date: 2016-01-13

Site no. : 3m Chamber Data no. : 94
 Dis. / Ant. : 3m 2015 3115-4877 Ant. pol. : VERTICAL
 Limit : FCC PART 15C PEAK
 Env. / Ins. : 23.6°C/52.8%
 Engineer : Alice_yang
 EUT : Notebook
 Power rating : DC 20V From Adapter Input AC 120V/60Hz
 Test Mode : IEEE802.11nHT40 2437MHz Tx
 RZ09-0184

No.	Freq. (MHz)	Ant. Factor (dB/m)	Cable Loss (dB)	AMP factor (dB)	Reading (dBuV)	Emission Level (dBuV/m)	Limits (dBuV/m)	Margin (dB)	Remark
1	4874.000	39.25	9.49	35.51	31.55	38.78	54.00	15.22	Average
2	4874.000	39.25	9.49	35.51	43.71	50.94	74.00	23.06	Peak

Remarks: 1. Emission Level= Antenna Factor + Cable Loss + Reading - Amp Factor
 2. The emission levels that are 20dB below the official limit are not reported.

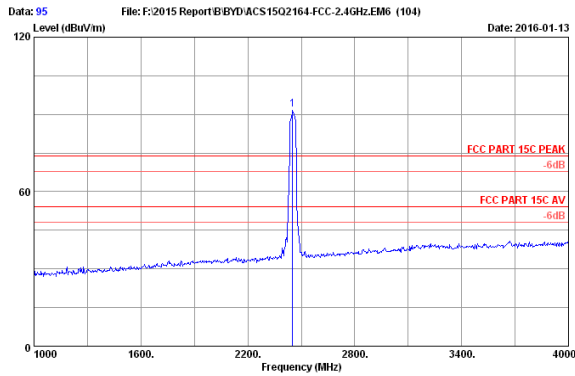

Data: 95 File: F:\2015 Report\BYD\ACS1502164-FCC-2.4GHz.EM6 (104) Date: 2016-01-13

Site no. : 3m Chamber Data no. : 95
 Dis. / Ant. : 3m 2015 3115-4877 Ant. pol. : HORIZONTAL
 Limit : FCC PART 15C PEAK
 Env. / Ins. : 23.6°C/52.8%
 Engineer : Alice_yang
 EUT : Notebook
 Power rating : DC 20V From Adapter Input AC 120V/60Hz
 Test Mode : IEEE802.11nHT40 2452MHz Tx
 RZ09-0184

No.	Freq. (MHz)	Ant. Factor (dB/m)	Cable Loss (dB)	AMP factor (dB)	Reading (dBuV)	Emission Level (dBuV/m)	Limits (dBuV/m)	Margin (dB)	Remark
1	2452.000	28.34	7.43	36.60	92.71	91.88	74.00	-17.88	Peak

Remarks: 1. Emission Level= Antenna Factor + Cable Loss + Reading - Amp Factor
 2. The emission levels that are 20dB below the official limit are not reported.

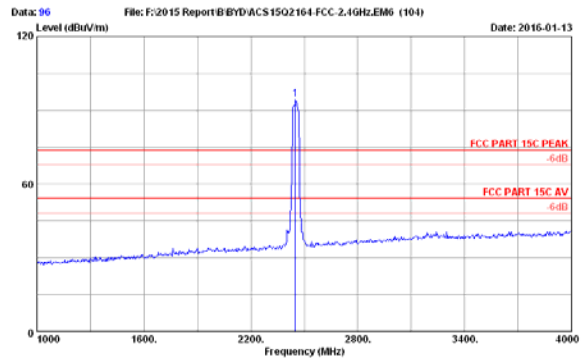

Data: 96 File: F:\2015 Report\BYD\ACS1502164-FCC-2.4GHz.EM6 (104) Date: 2016-01-13

Site no. : 3m Chamber Data no. : 96
 Dis. / Ant. : 3m 2015 3115-4877 Ant. pol. : VERTICAL
 Limit : FCC PART 15C PEAK
 Env. / Ins. : 23.6°C/52.8%
 Engineer : Alice_yang
 EUT : Notebook
 Power rating : DC 20V From Adapter Input AC 120V/60Hz
 Test Mode : IEEE802.11nHT40 2452MHz Tx
 RZ09-0184

No.	Freq. (MHz)	Ant. Factor (dB/m)	Cable Loss (dB)	AMP factor (dB)	Reading (dBuV)	Emission Level (dBuV/m)	Limits (dBuV/m)	Margin (dB)	Remark
1	2452.000	28.34	7.43	36.60	95.27	94.54	74.00	-20.54	Peak

Remarks: 1. Emission Level= Antenna Factor + Cable Loss + Reading - Amp Factor
 2. The emission levels that are 20dB below the official limit are not reported.

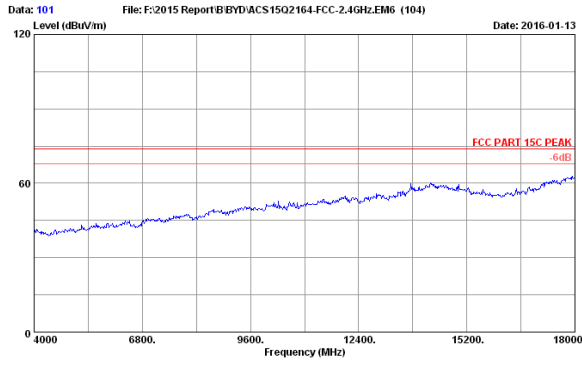

Site no. : 3m Chamber Data no. : 101
 Dis. / Ant. : 3m 2015 3115-4877 Ant. pol. : VERTICAL
 Limit : FCC PART 15C PEAK
 Env. / Ins. : 23.6°C/52.8%
 Engineer : Alice_yang
 EUT : Notebook
 Power rating : DC 20V From Adapter Input AC 120V/60Hz
 Test Mode : IEEE902.11nHT40 2452MHz Tx
 RZ09-0184

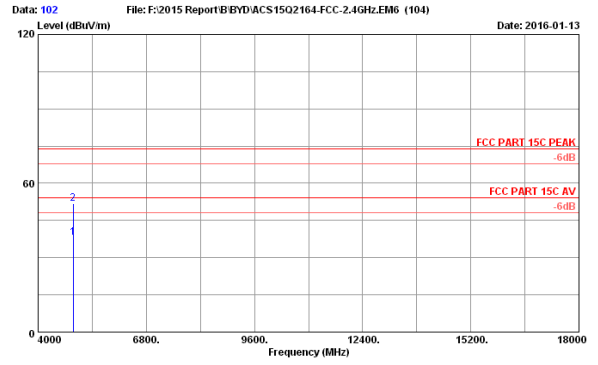

Site no. : 3m Chamber Data no. : 102
 Dis. / Ant. : 3m 2015 3115-4877 Ant. pol. : VERTICAL
 Limit : FCC PART 15C PEAK
 Env. / Ins. : 23.6°C/52.8%
 Engineer : Alice_yang
 EUT : Notebook
 Power rating : DC 20V From Adapter Input AC 120V/60Hz
 Test Mode : IEEE902.11nHT40 2452MHz Tx
 RZ09-0184

No.	Freq. (MHz)	Ant. Factor (dB/m)	Cable Loss (dB)	AMP factor (dB)	Reading (dBuV)	Emission Level (dBuV/m)	Limits (dBuV/m)	Margin (dB)	Remark
1	4904.000	33.31	9.50	35.50	30.75	38.06	54.00	15.94	Average
2	4904.000	33.31	9.50	35.50	44.52	51.83	74.00	22.17	Peak

Remarks: 1. Emission Level= Antenna Factor + Cable Loss + Reading
 -amp Factor
 2. The emission levels that are 20dB below the official limit are not reported.

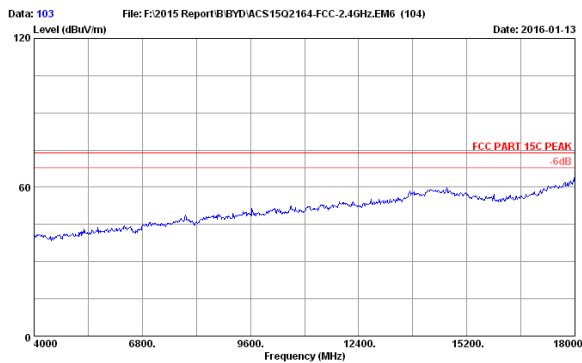

Site no. : 3m Chamber Data no. : 103
 Dis. / Ant. : 3m 2015 3115-4877 Ant. pol. : HORIZONTAL
 Limit : FCC PART 15C PEAK
 Env. / Ins. : 23.6°C/52.8%
 Engineer : Alice_yang
 EUT : Notebook
 Power rating : DC 20V From Adapter Input AC 120V/60Hz
 Test Mode : IEEE902.11nHT40 2452MHz Tx
 RZ09-0184

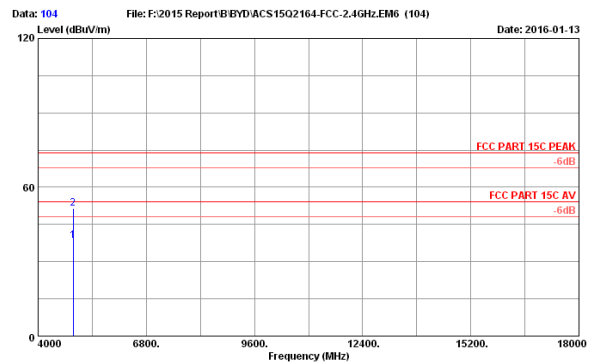

Site no. : 3m Chamber Data no. : 104
 Dis. / Ant. : 3m 2015 3115-4877 Ant. pol. : HORIZONTAL
 Limit : FCC PART 15C PEAK
 Env. / Ins. : 23.6°C/52.8%
 Engineer : Alice_yang
 EUT : Notebook
 Power rating : DC 20V From Adapter Input AC 120V/60Hz
 Test Mode : IEEE902.11nHT40 2452MHz Tx
 RZ09-0184

No.	Freq. (MHz)	Ant. Factor (dB/m)	Cable Loss (dB)	AMP factor (dB)	Reading (dBuV)	Emission Level (dBuV/m)	Limits (dBuV/m)	Margin (dB)	Remark
1	4904.000	33.31	9.50	35.50	31.16	38.47	54.00	15.53	Average
2	4904.000	33.31	9.50	35.50	44.20	51.51	74.00	22.49	Peak

Remarks: 1. Emission Level= Antenna Factor + Cable Loss + Reading
 -amp Factor
 2. The emission levels that are 20dB below the official limit are not reported.

5. CONDUCTED SPURIOUS EMISSIONS

5.1. Test Equipment

Item	Equipment	Manufacturer	Model No.	Serial No.	Last Cal.	Cal. Interval
1.	Spectrum	Agilent	N9030A	MY51380221	Oct.17, 15	1Year
2.	Attenuator (20dB)	Agilent	8491B	MY39262165	Apr. 28,15	1 Year
3.	RF Cable	Hubersuhner	SUCOFLEX102	28620/2	Apr. 28,15	1 Year

5.2. Limit

In any 100kHz bandwidth outside the frequency bands in which the spread spectrum intentional radiator is operating, the radio frequency power that is produced by the intentional radiator shall be at least 20dB below that in the 100kHz bandwidth within the band that contains the highest level of the desired power.

5.3. Test Procedure

The transmitter output was connected to a spectrum analyzer, The resolution bandwidth is set to 100 kHz, The video bandwidth is set to 300 kHz and measure all the emissions with peak detector.

5.4. Test result

PASS (The testing data was attached in the next pages.)

ANT1:

Test Mode: IEEE 802.11b
 Test CH1: 2412MHz

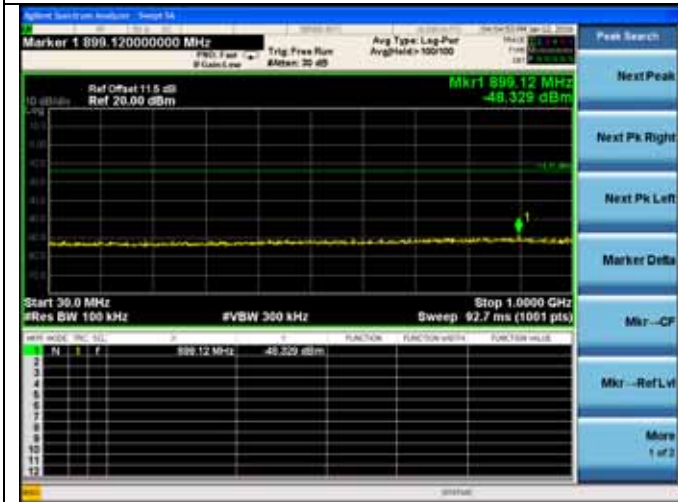

Test CH6: 2437MHz

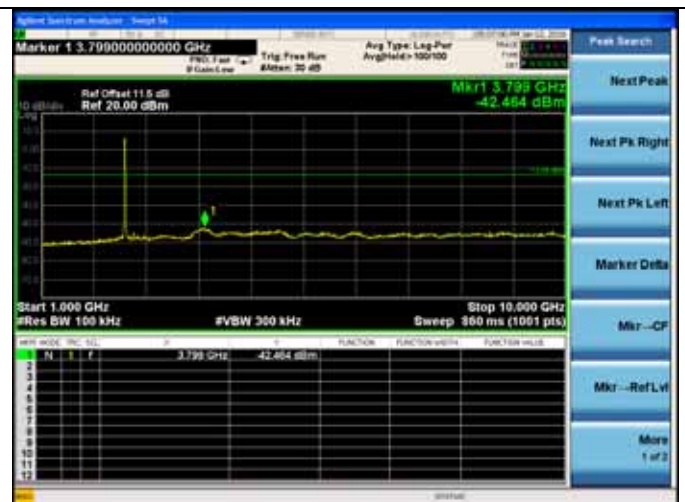
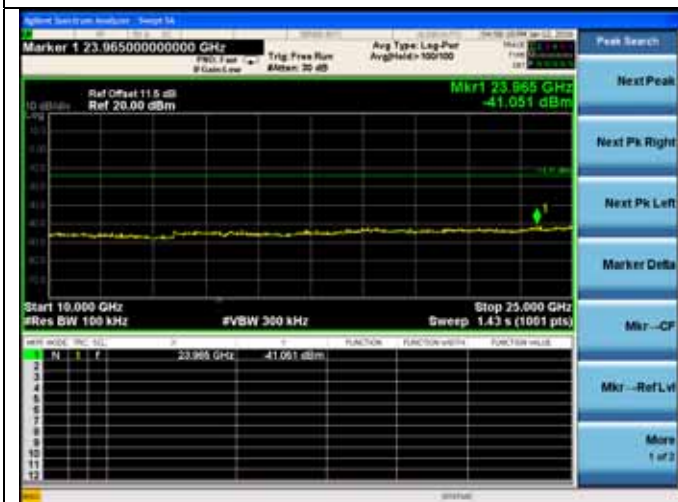
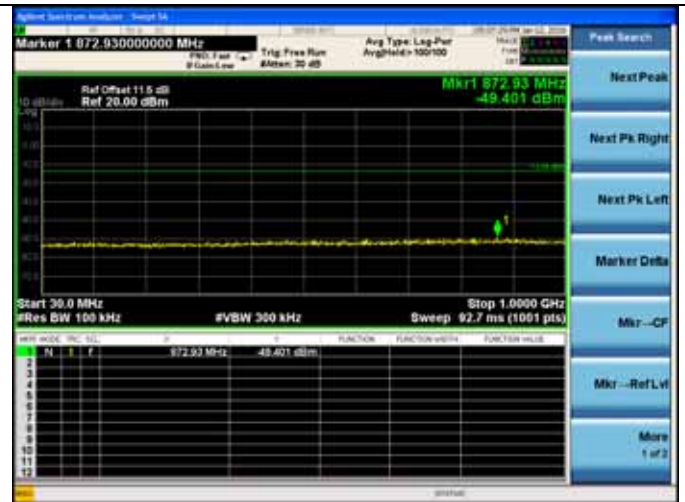

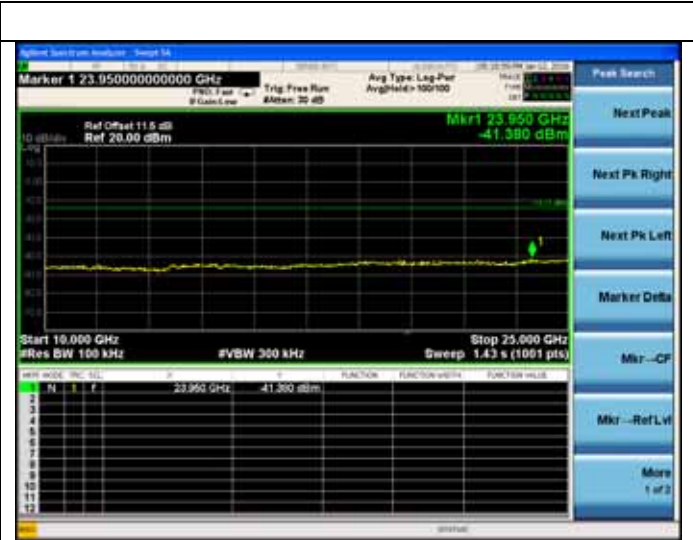
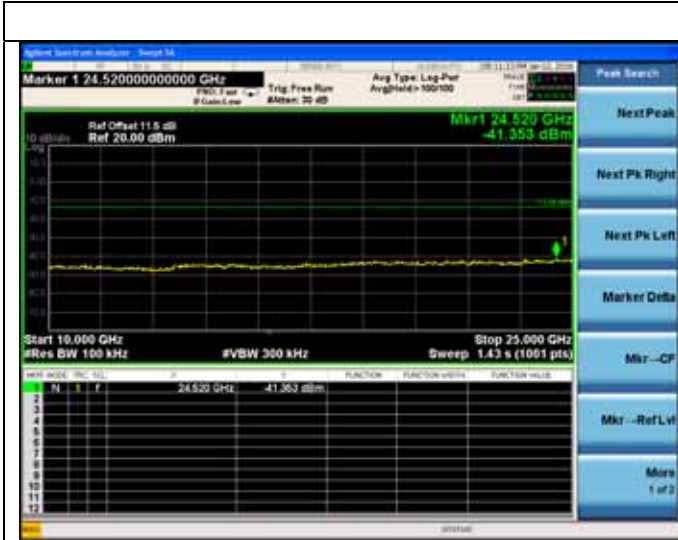

Test CH11: 2462MHz

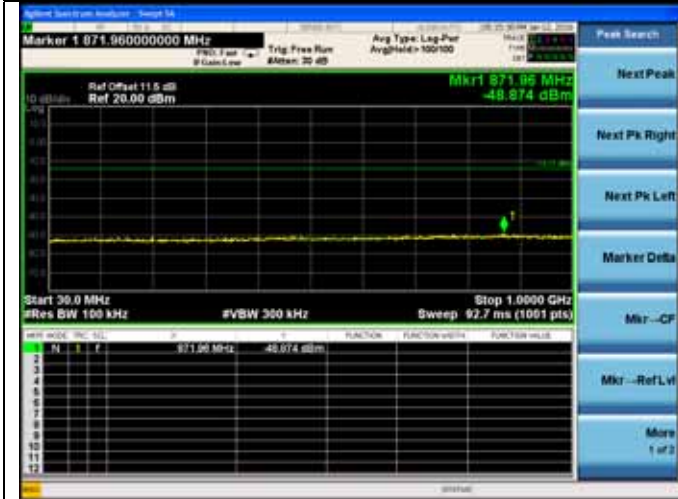

Test Mode: IEEE 802.11g
Test CH1: 2412MHz

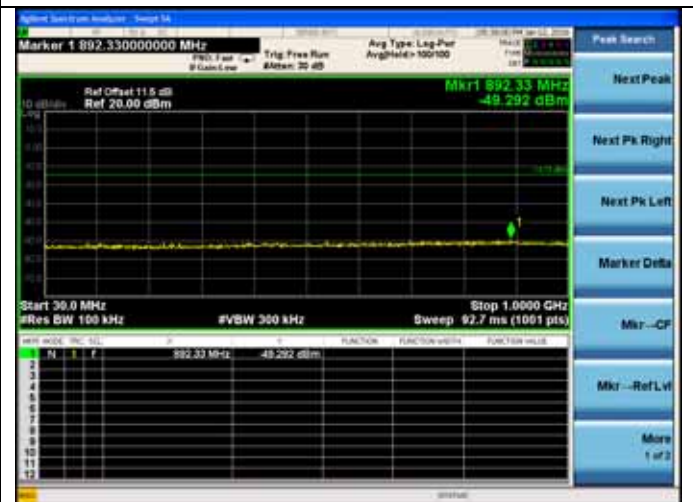
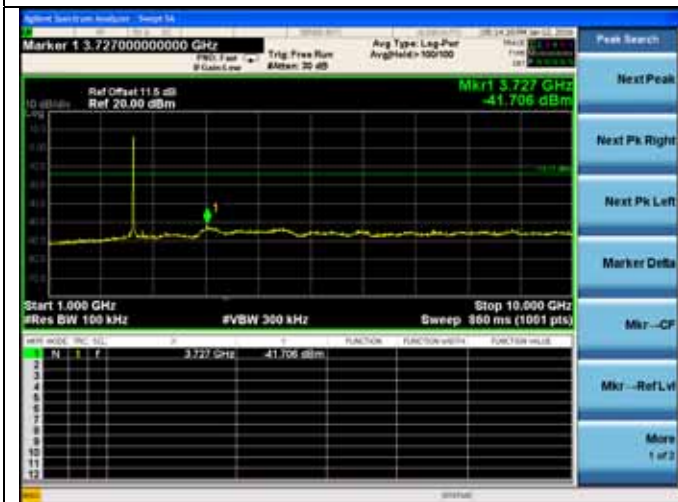

Test CH6: 2437MHz

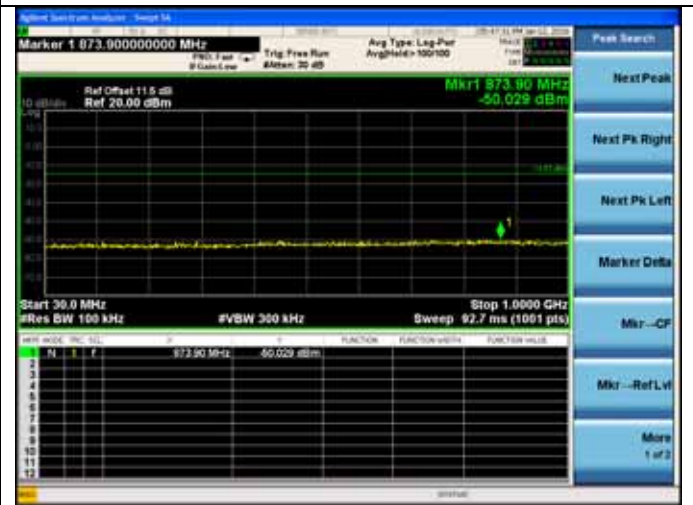

Test CH11: 2462MHz

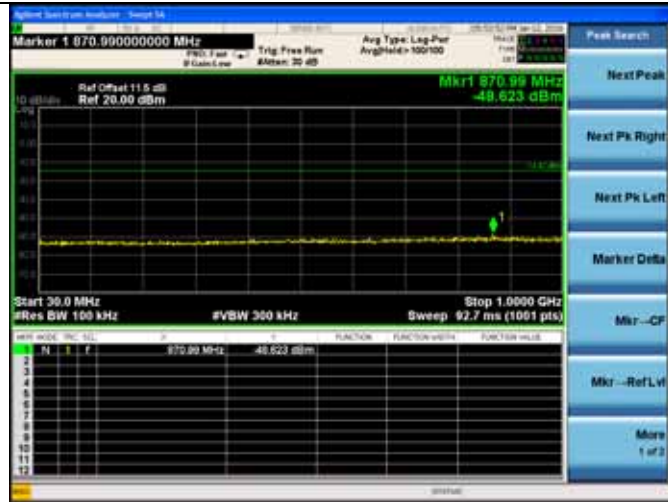

Test Mode: IEEE 802.11n HT20
Test CH1: 2412MHz

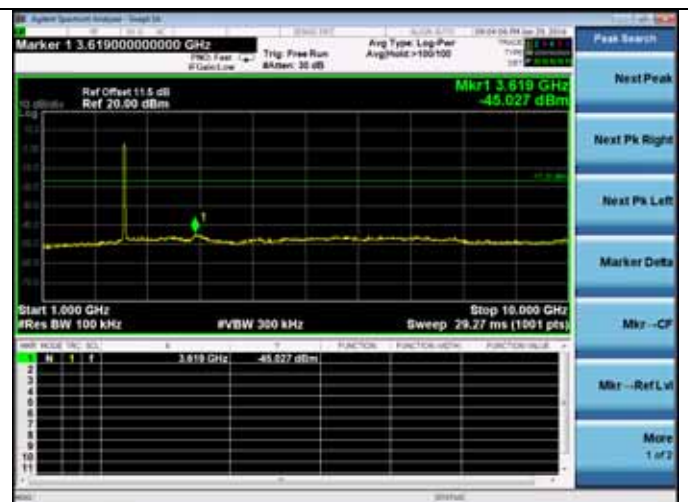
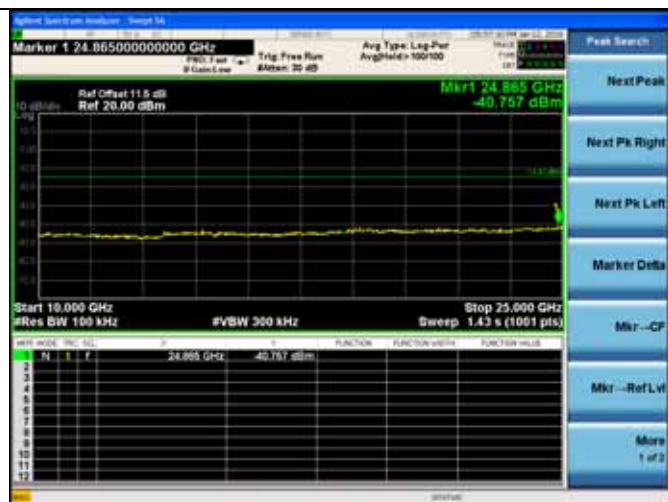
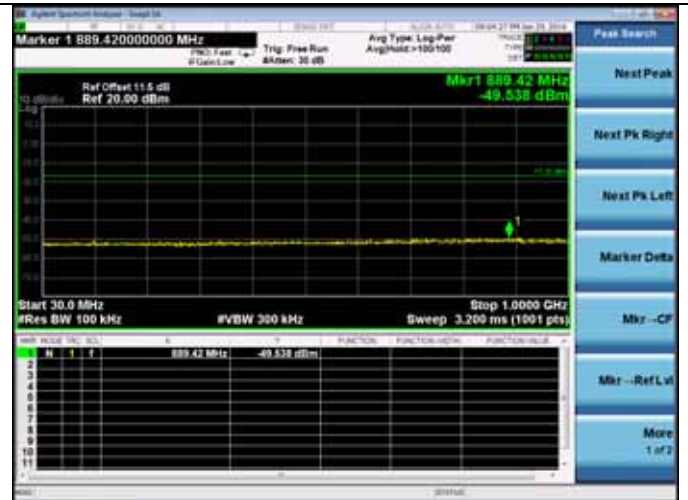
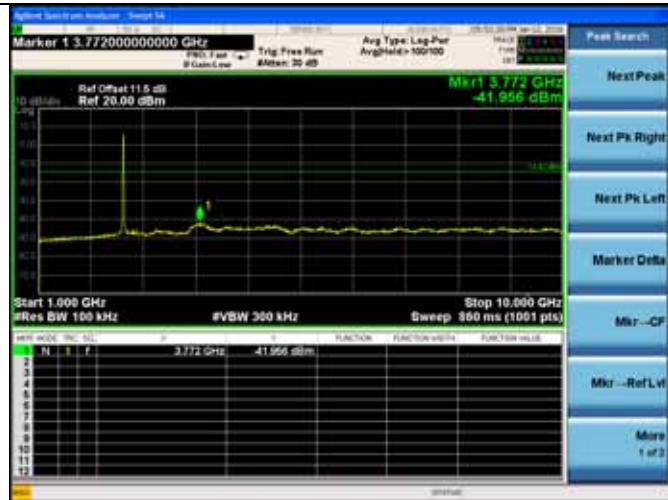

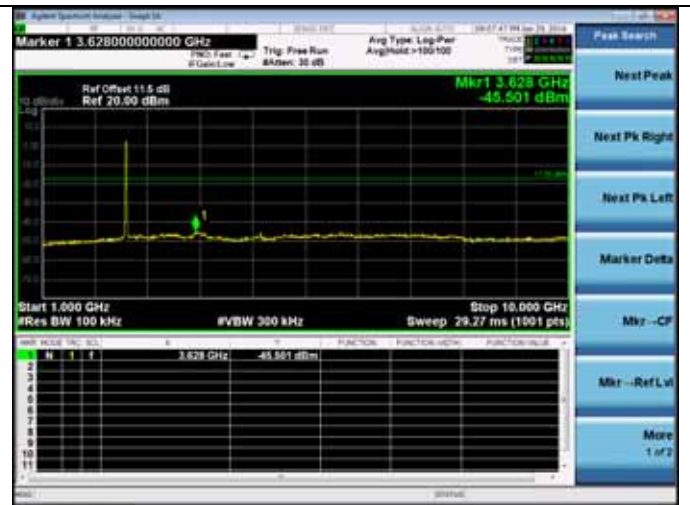

Test CH6: 2437MHz

Test CH11: 2462MHz

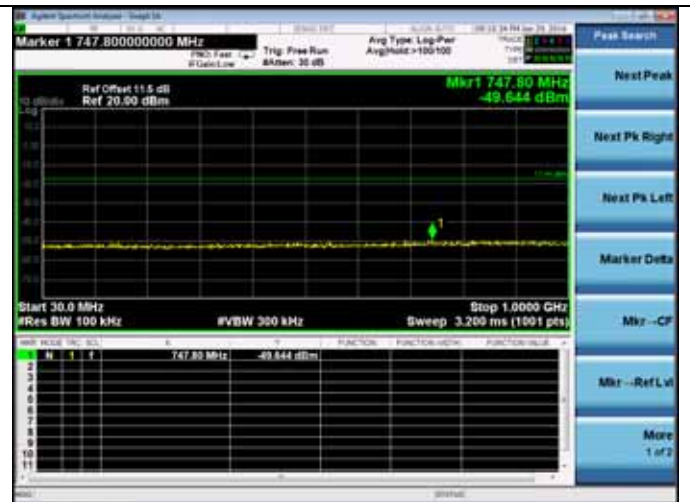
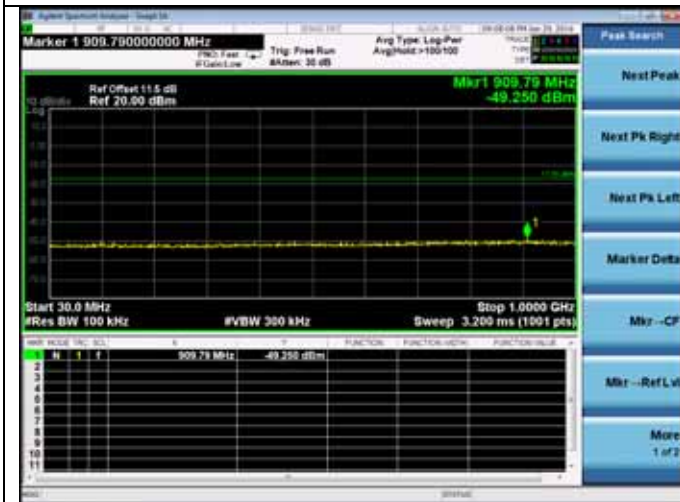

Test Mode: IEEE 802.11n HT40
 Test CH3: 2422MHz

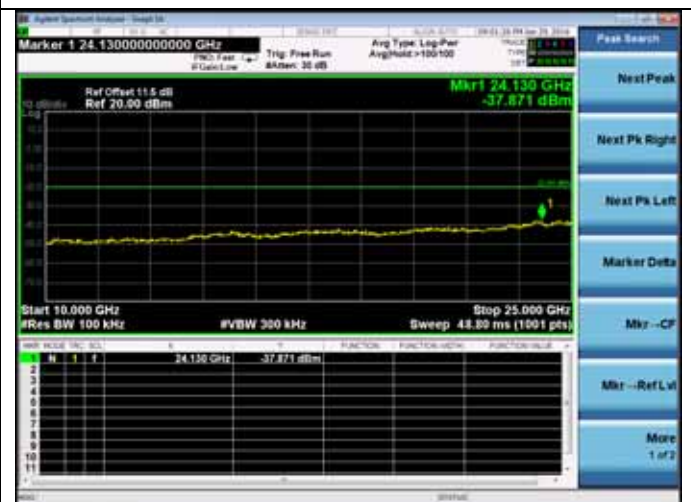
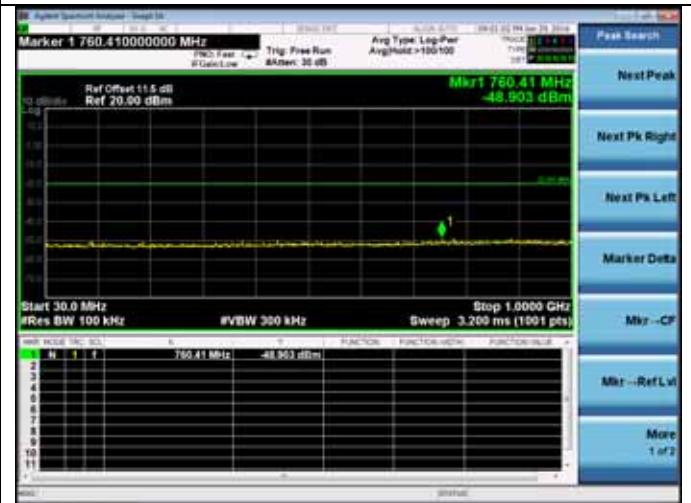
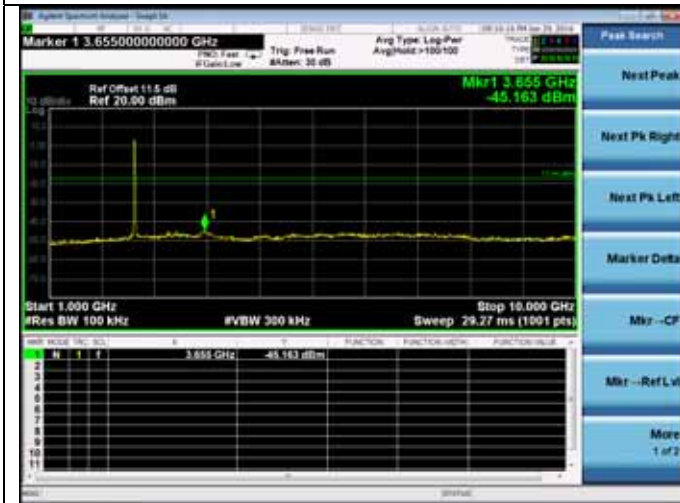

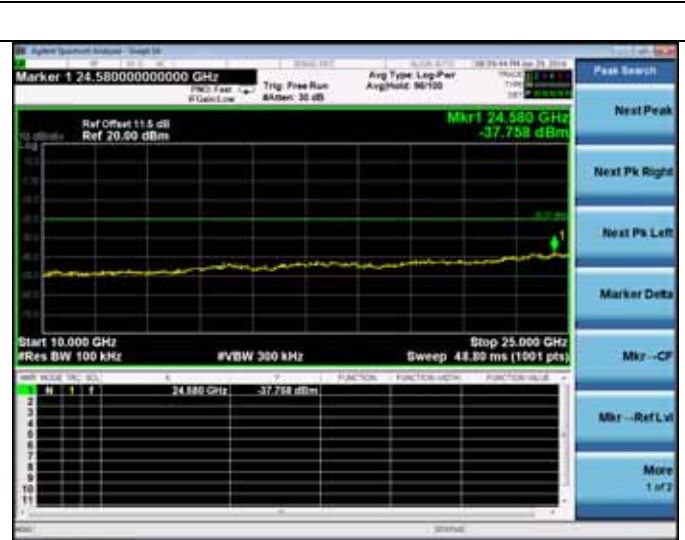

Test CH6: 2437MHz

Test CH9: 2452MHz

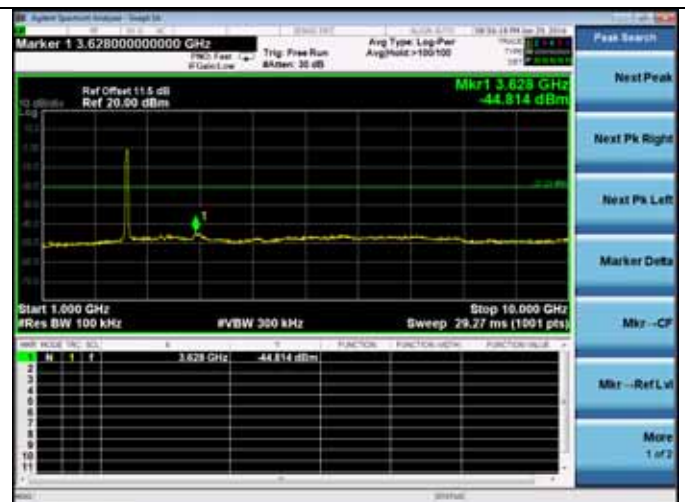
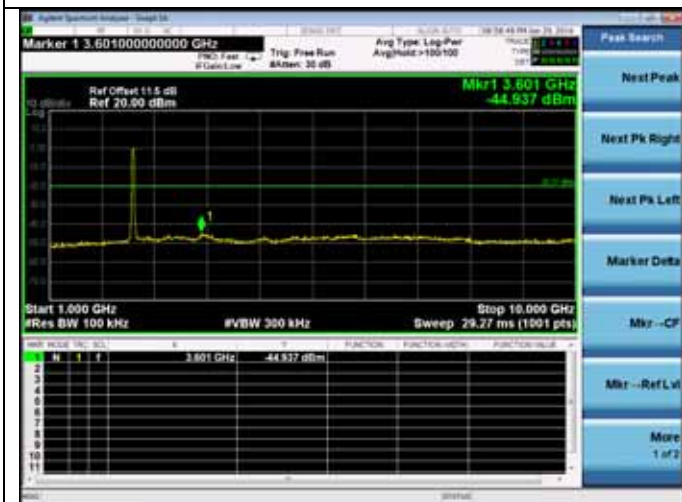
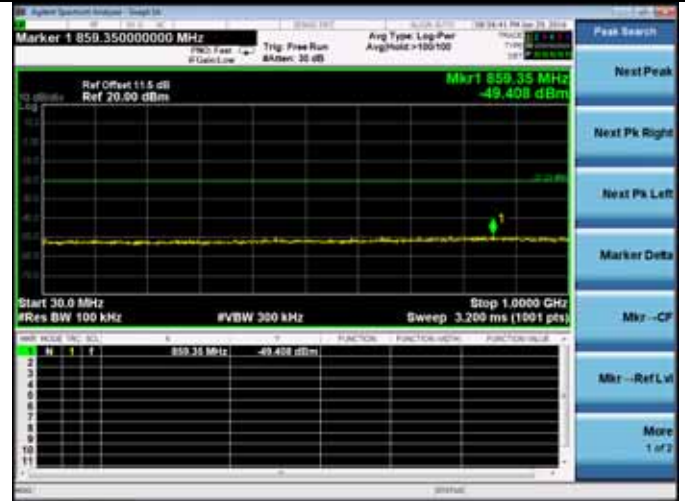
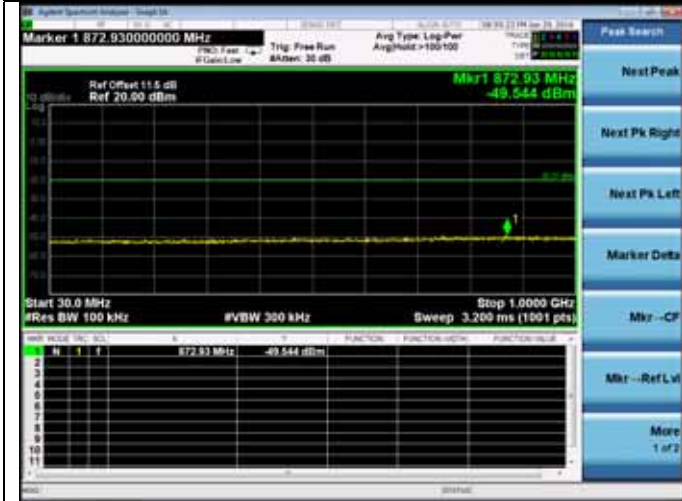



ANT2:

Test Mode: IEEE 802.11b
 Test CH1: 2412MHz

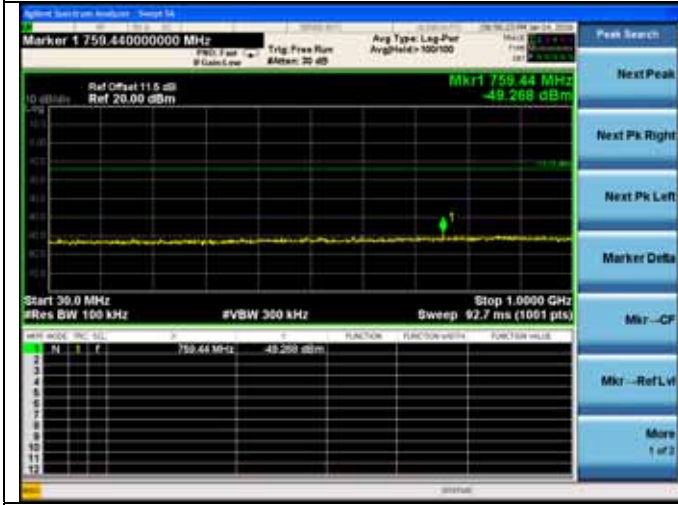

Test CH6: 2437MHz

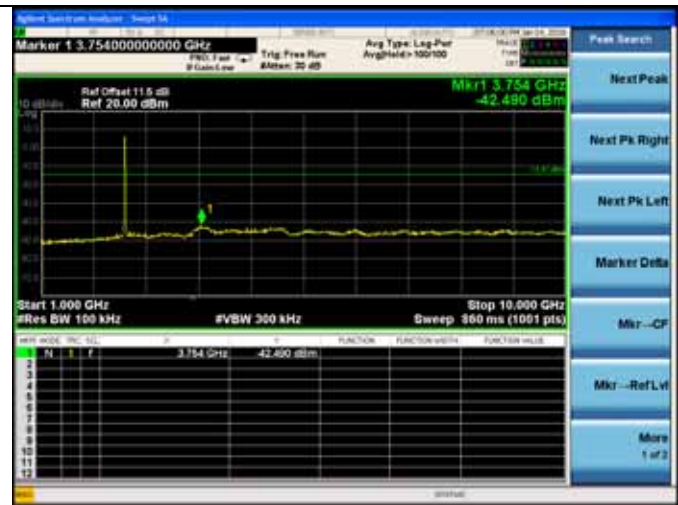
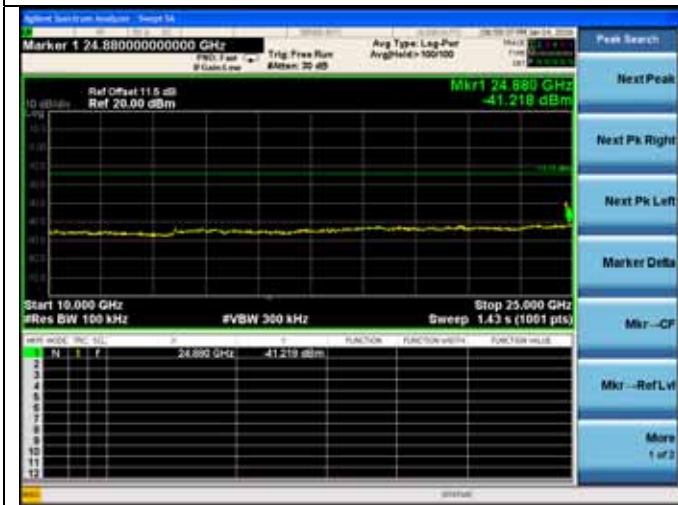
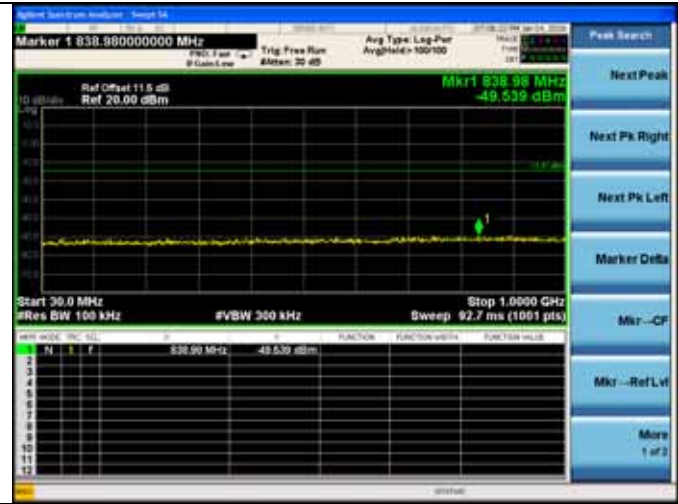

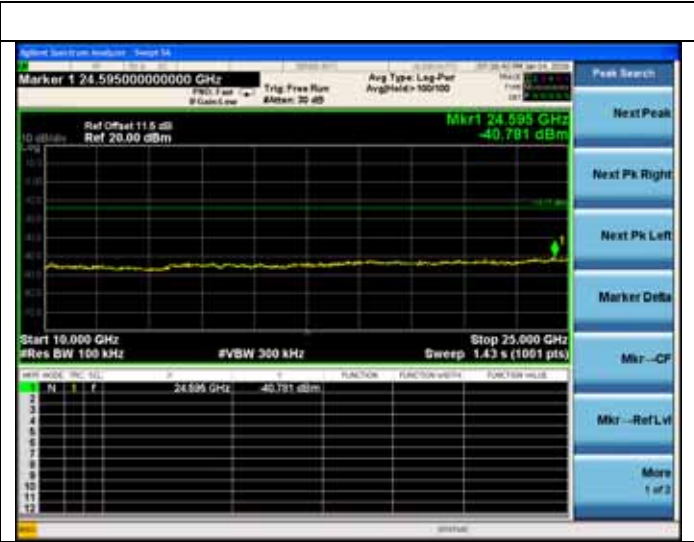

Test CH11: 2462MHz

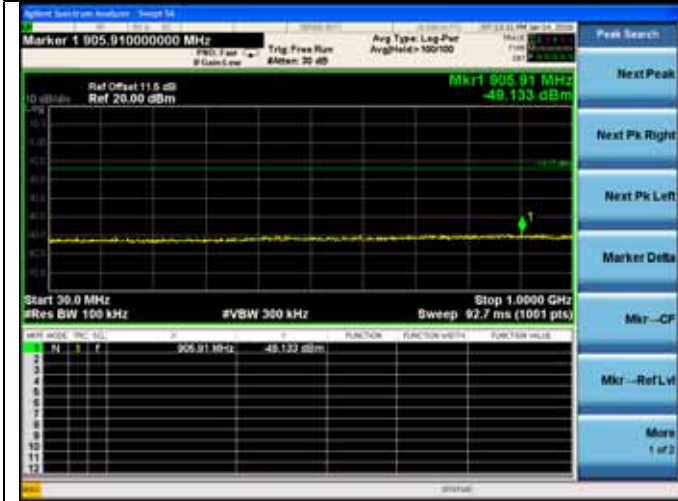

Test Mode: IEEE 802.11g
 Test CH1: 2412MHz

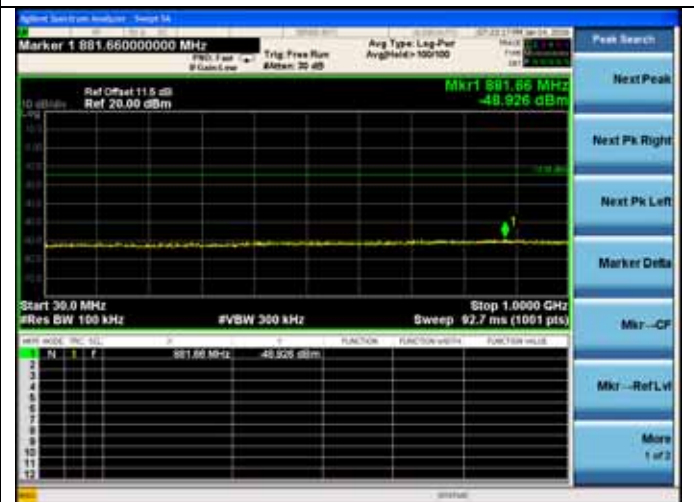
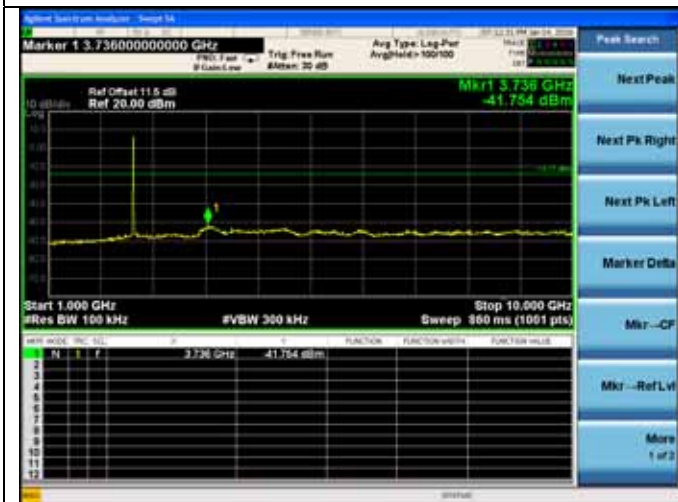

Test CH6: 2437MHz

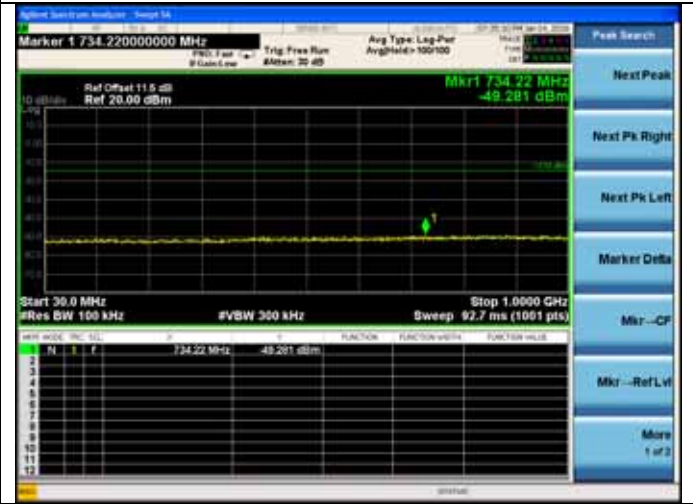

Test CH11: 2462MHz

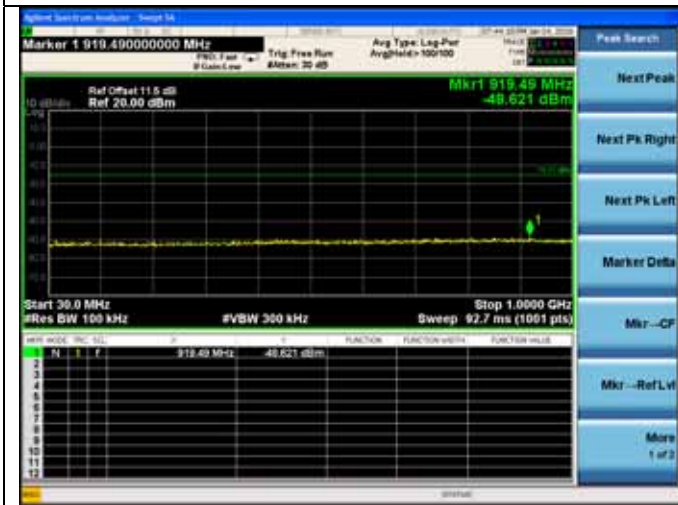

Test Mode: IEEE 802.11n HT20
 Test CH1: 2412MHz

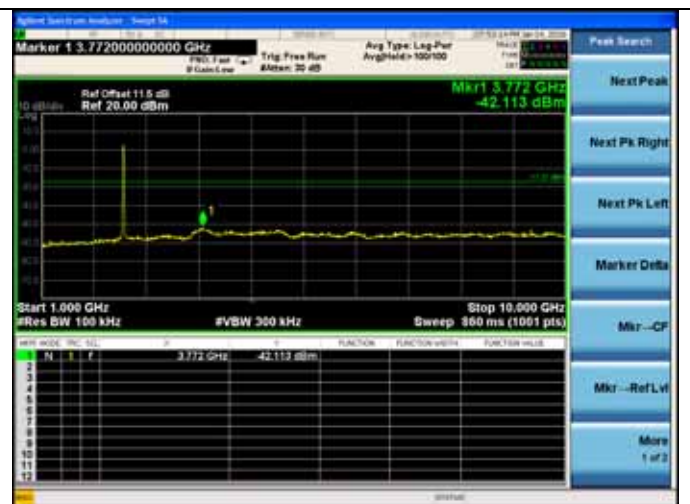
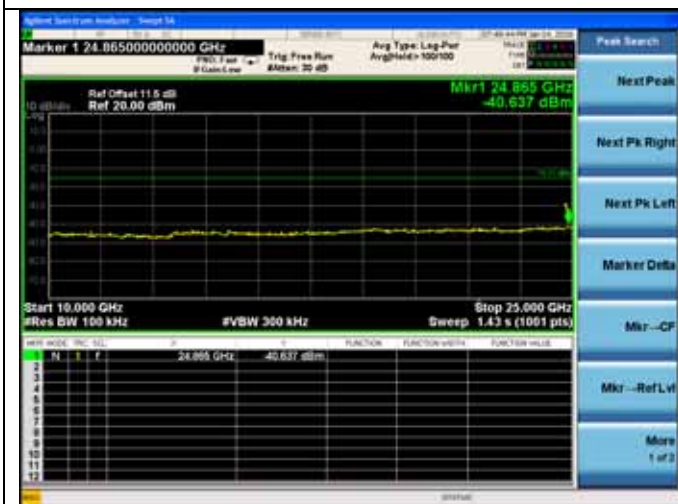
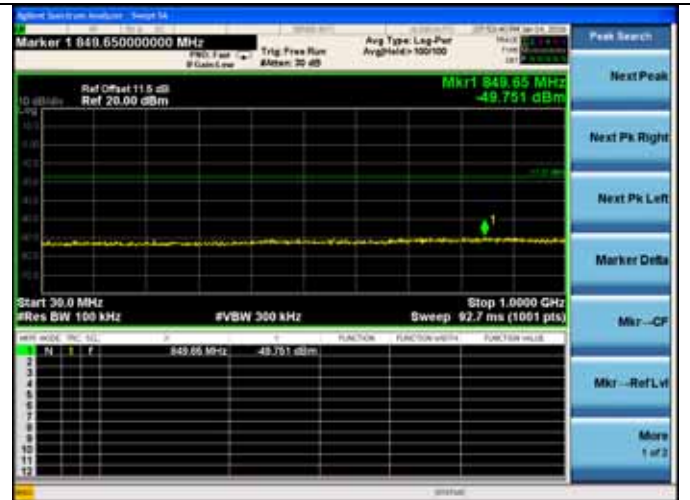

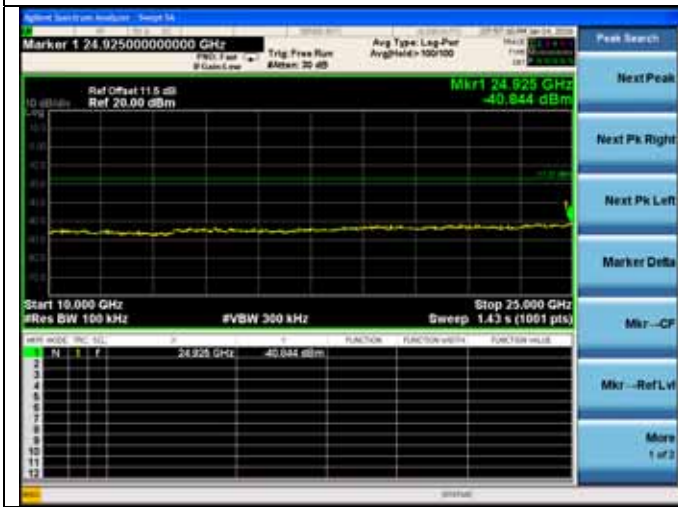

Test CH6: 2437MHz

Test CH11: 2462MHz

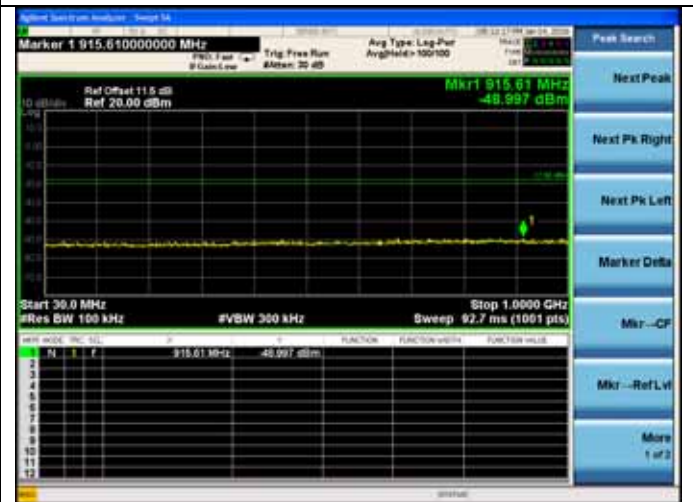
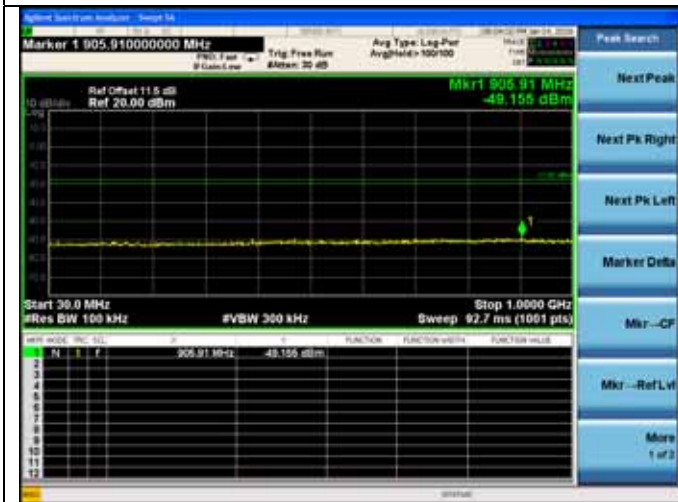

Test Mode: IEEE 802.11n HT40
 Test CH3: 2422MHz

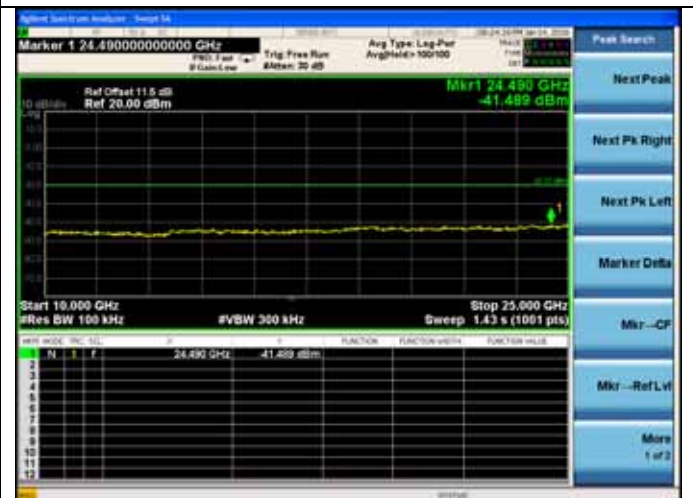
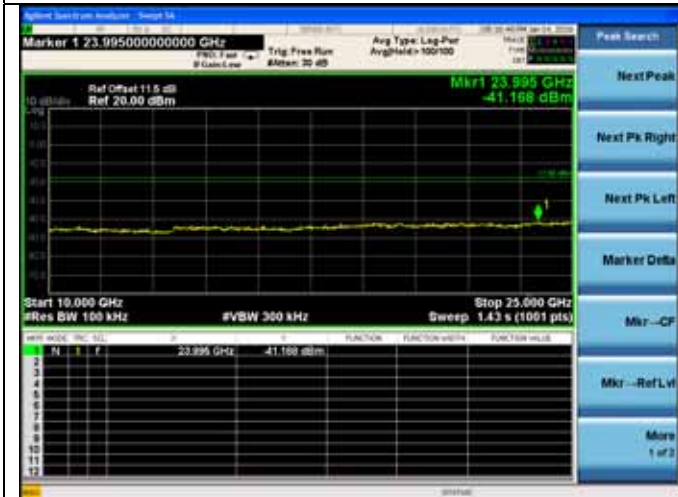
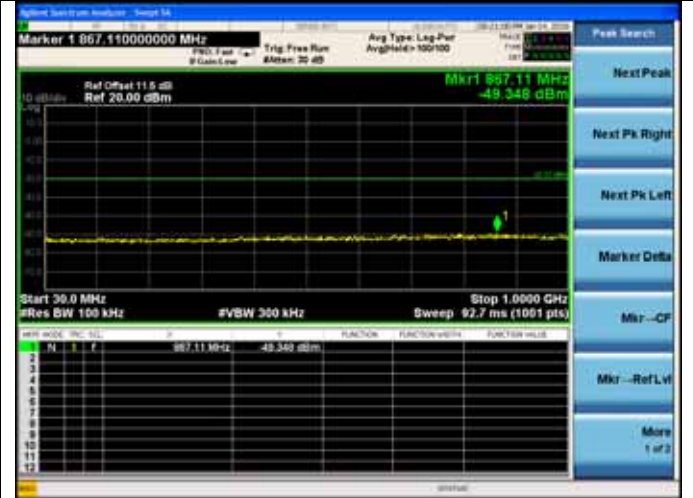

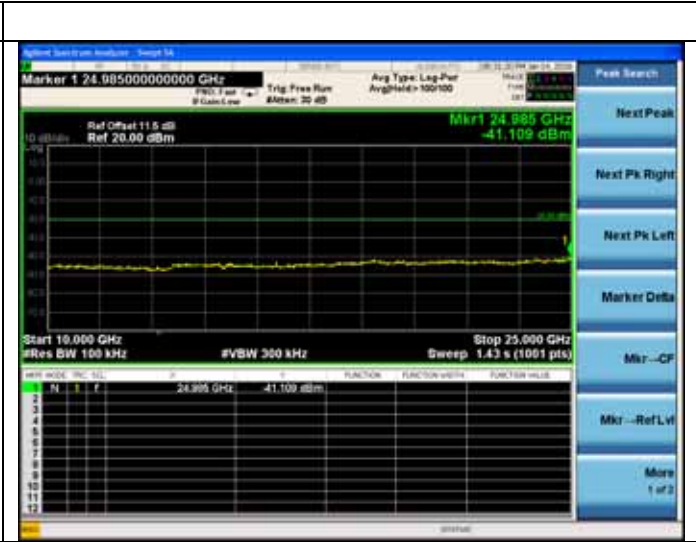

Test CH6: 2437MHz

Test CH9: 2452MHz

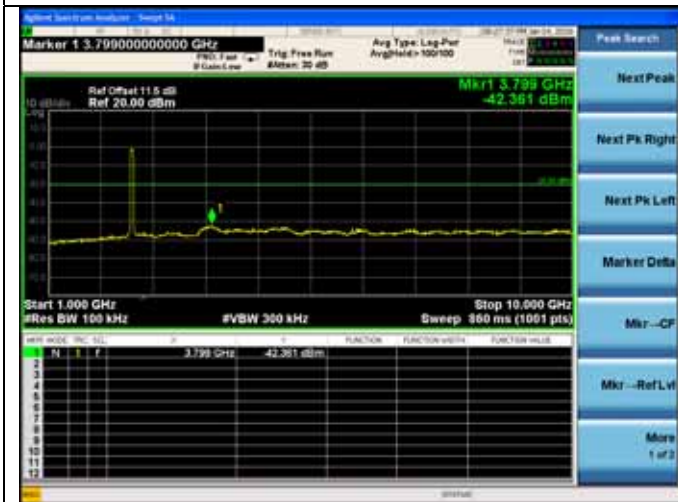
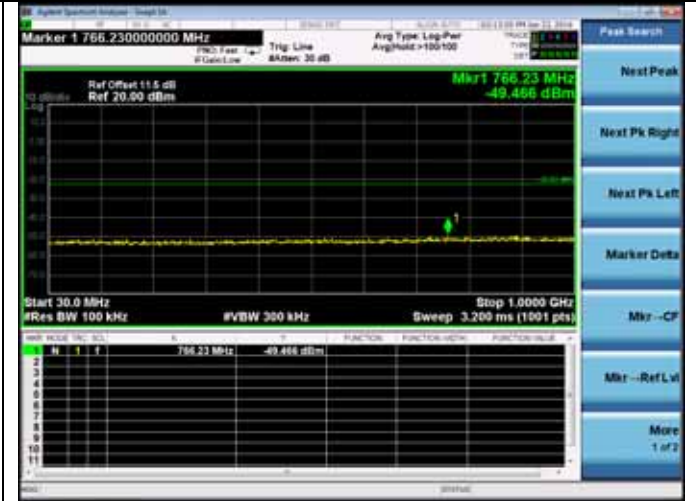
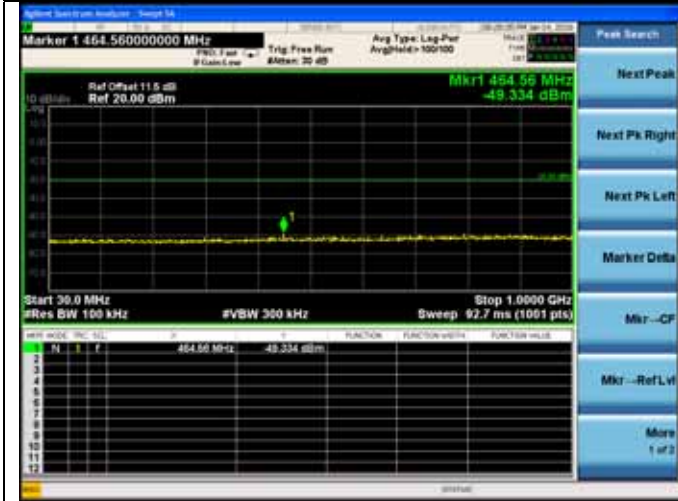



6. BAND EDGE COMPLIANCE TEST

6.1. Test Equipment

Item	Equipment	Manufacturer	Model No.	Serial No.	Last Cal.	Cal. Interval
1.	Amp	HP	8449B	3008A02495	Apr. 28,15	1 Year
2.	Horn Antenna	ETS	3115	9510-4877	Oct. 15,15	1 Year
3.	HF Cable	Hubersuhner	Sucoflex104	274094/4	Apr. 28,15	1 Year
4.	RF Cable	Hubersuhner	Sucoflex102	28610/2	Apr. 28,15	1 Year

6.2. Limit

All the lower and upper band-edges emissions appearing within 2310MHz to 2390MHz and 2483.5MHz to 2500MHz restricted frequency bands shall not exceed the limits shown in 15.209, all the other emissions outside operation frequency band 2400MHz to 2483.5MHz shall be at least 20dB below the fundamental emissions, or comply with 15.209 limits.

6.3. Test Produce

1. The EUT is placed on a turntable, which is 1.5m above the ground plane and worked at highest radiated power.
2. The turntable was rotated for 360 degrees to determine the position of maximum emission level.
3. EUT is set 3m away from the receiving antenna, which is varied from 1m to 4m to find out the highest emission.
4. Set the spectrum analyzer in the following setting in order to capture the lower and upper band-edges of the emission:
 - (a) PEAK: RBW=1MHz; VBW=3MHz; Sweep=AUTO
 - (b) AVERAGE: RBW=1MHz; VBW=10Hz; Sweep=AUTO

6.4. Test Results

Pass (The testing data was attached in the next pages.)

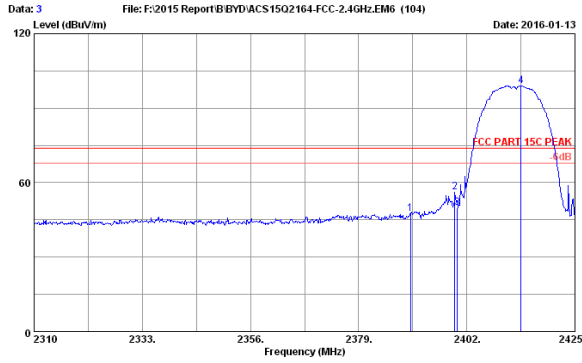

File: F:\2015 Report\BYD\ACS1502164-FCC-2.4GHz.EM6 (104) Date: 2016-01-13

Site no. : 3m Chamber Data no. : 3
 Dis. / Ant. : 3m 2015 3115-4877 Ant. pol. : HORIZONTAL
 Limit : FCC PART 15C PEAK
 Env. / Ins. : 23.6°C/52.8%
 Engineer : Alice_yang
 EUT : Notebook
 Power rating : DC 20V From Adapter Input AC 120V/60Hz
 Test Mode : IEE802.11b 2412MHz TX
 RZ09-0184

No.	Freq. (MHz)	Ant. Factor (dB/m)	Cable Loss (dB)	AMP factor (dB)	Reading (dBuV)	Emission Level (dBuV/m)	Limits (dBuV/m)	Margin (dB)	Remark
1	2390.000	28.27	7.28	36.62	48.39	47.32	74.00	26.68	Peak
2	2399.470	28.28	7.32	36.62	57.27	56.25	74.00	17.75	Peak
3	2400.000	28.28	7.32	36.62	50.93	49.91	74.00	24.09	Peak
4	2413.500	28.30	7.35	36.61	99.91	98.95	74.00	-24.95	Peak

Remarks: 1. Emission Level= Antenna Factor + Cable Loss + Reading - Amp Factor
 2. The emission levels that are 20dB below the official limit are not reported.

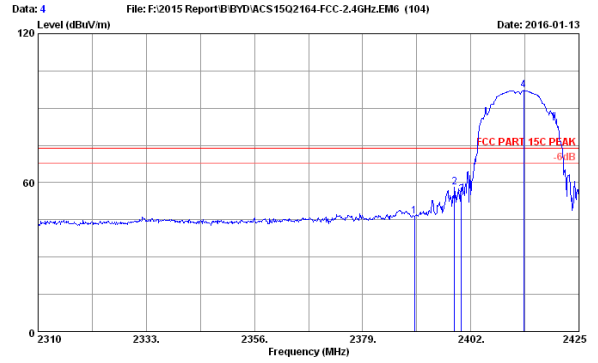

File: F:\2015 Report\BYD\ACS1502164-FCC-2.4GHz.EM6 (104) Date: 2016-01-13

Site no. : 3m Chamber Data no. : 4
 Dis. / Ant. : 3m 2015 3115-4877 Ant. pol. : VERTICAL
 Limit : FCC PART 15C PEAK
 Env. / Ins. : 23.6°C/52.8%
 Engineer : Alice_yang
 EUT : Notebook
 Power rating : DC 20V From Adapter Input AC 120V/60Hz
 Test Mode : IEE802.11b 2412MHz TX
 RZ09-0184

No.	Freq. (MHz)	Ant. Factor (dB/m)	Cable Loss (dB)	AMP factor (dB)	Reading (dBuV)	Emission Level (dBuV/m)	Limits (dBuV/m)	Margin (dB)	Remark
1	2390.000	28.27	7.28	36.62	47.59	46.52	74.00	27.48	Peak
2	2398.550	28.28	7.32	36.62	59.17	58.15	74.00	15.85	Peak
3	2400.000	28.28	7.32	36.62	56.13	55.11	74.00	18.89	Peak
4	2413.270	28.30	7.35	36.61	98.07	97.11	74.00	-23.11	Peak

Remarks: 1. Emission Level= Antenna Factor + Cable Loss + Reading - Amp Factor
 2. The emission levels that are 20dB below the official limit are not reported.

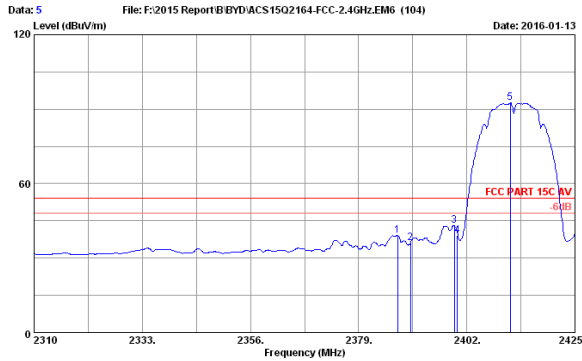

File: F:\2015 Report\BYD\ACS1502164-FCC-2.4GHz.EM6 (104) Date: 2016-01-13

Site no. : 3m Chamber Data no. : 5
 Dis. / Ant. : 3m 2015 3115-4877 Ant. pol. : VERTICAL
 Limit : FCC PART 15C AV
 Env. / Ins. : 23.6°C/52.8%
 Engineer : Alice_yang
 EUT : Notebook
 Power rating : DC 20V From Adapter Input AC 120V/60Hz
 Test Mode : IEE802.11b 2412MHz TX
 RZ09-0184

No.	Freq. (MHz)	Ant. Factor (dB/m)	Cable Loss (dB)	AMP factor (dB)	Reading (dBuV)	Emission Level (dBuV/m)	Limits (dBuV/m)	Margin (dB)	Remark
1	2387.280	28.26	7.28	36.63	40.21	39.12	54.00	14.88	Average
2	2390.000	28.27	7.28	36.62	37.19	36.12	54.00	17.88	Average
3	2399.355	28.28	7.32	36.62	44.22	43.20	54.00	10.80	Average
4	2400.000	28.28	7.32	36.62	40.07	39.05	54.00	14.95	Average
5	2411.200	28.29	7.35	36.62	93.45	92.47	54.00	-38.47	Average

Remarks: 1. Emission Level= Antenna Factor + Cable Loss + Reading - Amp Factor
 2. The emission levels that are 20dB below the official limit are not reported.

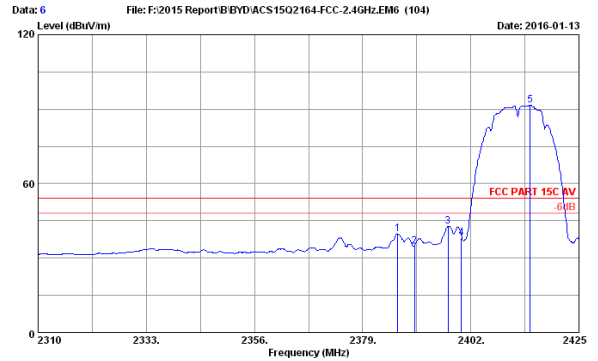

File: F:\2015 Report\BYD\ACS1502164-FCC-2.4GHz.EM6 (104) Date: 2016-01-13

Site no. : 3m Chamber Data no. : 6
 Dis. / Ant. : 3m 2015 3115-4877 Ant. pol. : HORIZONTAL
 Limit : FCC PART 15C AV
 Env. / Ins. : 23.6°C/52.8%
 Engineer : Alice_yang
 EUT : Notebook
 Power rating : DC 20V From Adapter Input AC 120V/60Hz
 Test Mode : IEE802.11b 2412MHz TX
 RZ09-0184

No.	Freq. (MHz)	Ant. Factor (dB/m)	Cable Loss (dB)	AMP factor (dB)	Reading (dBuV)	Emission Level (dBuV/m)	Limits (dBuV/m)	Margin (dB)	Remark
1	2386.475	28.26	7.28	36.63	40.73	39.64	54.00	14.36	Average
2	2390.000	28.27	7.28	36.62	35.95	34.88	54.00	19.12	Average
3	2397.170	28.28	7.32	36.62	43.93	42.91	54.00	11.09	Average
4	2400.000	28.28	7.32	36.62	39.14	38.12	54.00	15.88	Average
5	2414.650	28.30	7.35	36.61	92.50	91.54	54.00	-37.54	Average

Remarks: 1. Emission Level= Antenna Factor + Cable Loss + Reading - Amp Factor
 2. The emission levels that are 20dB below the official limit are not reported.

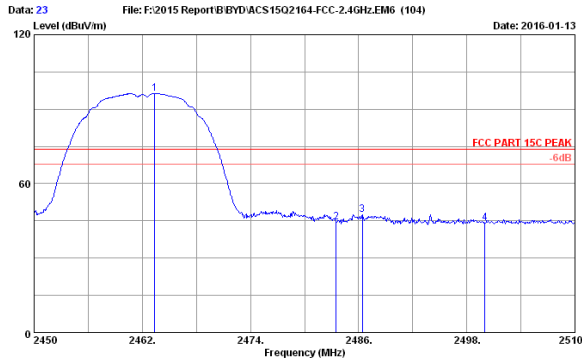

Site no. : 3m Chamber Data no. : 23
 Dis. / Ant. : 3m 2015 3115-4877 Ant. pol. : HORIZONTAL
 Limit : FCC PART 15C PEAK
 Env. / Ins. : 23.6°C/52.8%
 Engineer : Alice_yang
 EUT : Notebook
 Power rating : DC 20V From Adapter Input AC 120V/60Hz
 Test Mode : IEEE802.11b 2462MHz Tx
 R209-0184

No.	Freq. (MHz)	Ant. Factor (dB/m)	Cable Loss (dB)	AMP factor (dB)	Reading (dBuV)	Emission Level (dBuV/m)	Limits (dBuV/m)	Margin (dB)	Remark
1	2463.380	28.36	7.43	36.59	97.12	96.32	74.00	-22.32	Peak
2	2483.500	28.38	7.51	36.59	45.23	44.53	74.00	29.47	Peak
3	2486.420	28.38	7.51	36.59	48.17	47.47	74.00	26.53	Peak
4	2500.000	28.40	7.51	36.58	44.91	44.24	74.00	29.76	Peak

Remarks: 1. Emission Level= Antenna Factor + Cable Loss + Reading - Amp Factor
 2. The emission levels that are 20dB below the official limit are not reported.

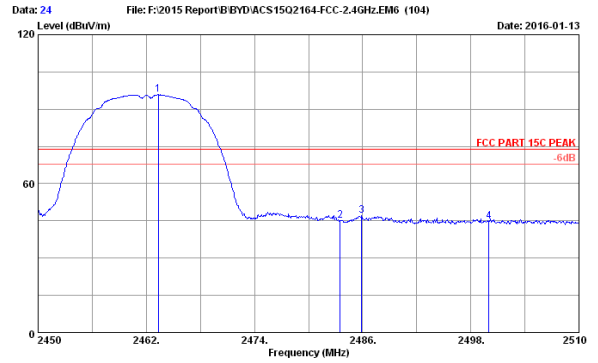

Site no. : 3m Chamber Data no. : 24
 Dis. / Ant. : 3m 2015 3115-4877 Ant. pol. : VERTICAL
 Limit : FCC PART 15C PEAK
 Env. / Ins. : 23.6°C/52.8%
 Engineer : Alice_yang
 EUT : Notebook
 Power rating : DC 20V From Adapter Input AC 120V/60Hz
 Test Mode : IEEE802.11b 2462MHz Tx
 R209-0184

No.	Freq. (MHz)	Ant. Factor (dB/m)	Cable Loss (dB)	AMP factor (dB)	Reading (dBuV)	Emission Level (dBuV/m)	Limits (dBuV/m)	Margin (dB)	Remark
1	2463.320	28.36	7.43	36.59	96.63	95.83	74.00	-21.83	Peak
2	2483.500	28.38	7.51	36.59	45.82	45.12	74.00	28.88	Peak
3	2485.880	28.38	7.51	36.59	47.81	47.11	74.00	26.89	Peak
4	2500.000	28.40	7.51	36.58	45.62	44.95	74.00	29.05	Peak

Remarks: 1. Emission Level= Antenna Factor + Cable Loss + Reading - Amp Factor
 2. The emission levels that are 20dB below the official limit are not reported.

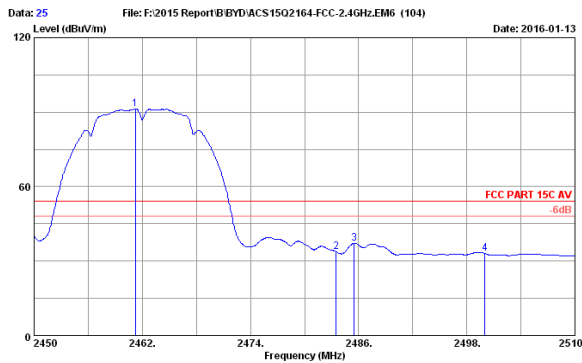

Site no. : 3m Chamber Data no. : 25
 Dis. / Ant. : 3m 2015 3115-4877 Ant. pol. : VERTICAL
 Limit : FCC PART 15C AV
 Env. / Ins. : 23.6°C/52.8%
 Engineer : Alice_yang
 EUT : Notebook
 Power rating : DC 20V From Adapter Input AC 120V/60Hz
 Test Mode : IEEE802.11b 2462MHz Tx
 R209-0184

No.	Freq. (MHz)	Ant. Factor (dB/m)	Cable Loss (dB)	AMP factor (dB)	Reading (dBuV)	Emission Level (dBuV/m)	Limits (dBuV/m)	Margin (dB)	Remark
1	2461.220	28.35	7.43	36.60	92.10	91.28	54.00	-37.28	Average
2	2483.500	28.38	7.51	36.59	34.54	33.84	54.00	20.16	Average
3	2485.520	28.38	7.51	36.59	37.78	37.08	54.00	16.92	Average
4	2500.000	28.40	7.51	36.58	33.73	33.06	54.00	20.94	Average

Remarks: 1. Emission Level= Antenna Factor + Cable Loss + Reading - Amp Factor
 2. The emission levels that are 20dB below the official limit are not reported.

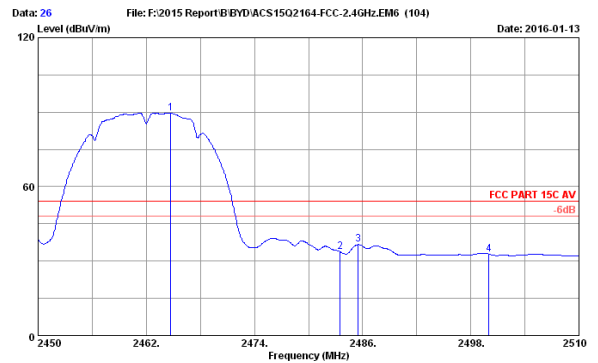

Site no. : 3m Chamber Data no. : 26
 Dis. / Ant. : 3m 2015 3115-4877 Ant. pol. : HORIZONTAL
 Limit : FCC PART 15C AV
 Env. / Ins. : 23.6°C/52.8%
 Engineer : Alice_yang
 EUT : Notebook
 Power rating : DC 20V From Adapter Input AC 120V/60Hz
 Test Mode : IEEE802.11b 2462MHz Tx
 R209-0184

No.	Freq. (MHz)	Ant. Factor (dB/m)	Cable Loss (dB)	AMP factor (dB)	Reading (dBuV)	Emission Level (dBuV/m)	Limits (dBuV/m)	Margin (dB)	Remark
1	2464.700	28.36	7.43	36.59	90.48	89.68	54.00	-35.68	Average
2	2483.500	28.38	7.51	36.59	34.47	33.77	54.00	20.23	Average
3	2485.520	28.38	7.51	36.59	37.33	36.63	54.00	17.37	Average
4	2500.000	28.40	7.51	36.58	33.51	32.84	54.00	21.16	Average

Remarks: 1. Emission Level= Antenna Factor + Cable Loss + Reading - Amp Factor
 2. The emission levels that are 20dB below the official limit are not reported.

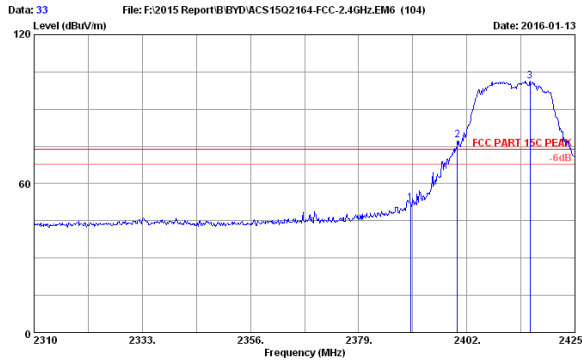

Site no. : 3m Chamber Data no. : 33
 Dis. / Ant. : 3m 2015 3115-4877 Ant. pol. : HORIZONTAL
 Limit : FCC PART 15C PEAK
 Env. / Ins. : 23.6°C/52.8%
 Engineer : Alice_yang
 EUT : Notebook
 Power rating : DC 20V From Adapter Input AC 120V/60Hz
 Test Mode : IEEE802.11g 2412MHz Tx
 R209-0184

No.	Freq. (MHz)	Ant. Factor (dB/m)	Cable Loss (dB)	AMP factor (dB)	Reading (dBuV)	Emission Level (dBuV/m)	Limits (dBuV/m)	Margin (dB)	Remark
1	2390.000	28.27	7.28	36.62	53.29	52.22	74.00	21.78	Peak
2	2400.000	28.28	7.32	36.62	78.59	77.57	74.00	-3.57	Peak
3	2415.455	28.30	7.35	36.61	102.22	101.26	74.00	-27.26	Peak

Remarks: 1. Emission Level= Antenna Factor + Cable Loss + Reading - Amp Factor
 2. The emission levels that are 20dB below the official limit are not reported.

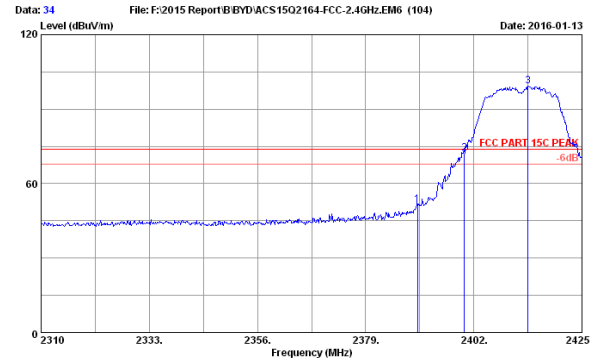

Site no. : 3m Chamber Data no. : 34
 Dis. / Ant. : 3m 2015 3115-4877 Ant. pol. : VERTICAL
 Limit : FCC PART 15C PEAK
 Env. / Ins. : 23.6°C/52.8%
 Engineer : Alice_yang
 EUT : Notebook
 Power rating : DC 20V From Adapter Input AC 120V/60Hz
 Test Mode : IEEE802.11g 2412MHz Tx
 R209-0184

No.	Freq. (MHz)	Ant. Factor (dB/m)	Cable Loss (dB)	AMP factor (dB)	Reading (dBuV)	Emission Level (dBuV/m)	Limits (dBuV/m)	Margin (dB)	Remark
1	2390.000	28.27	7.28	36.62	52.64	51.57	74.00	22.43	Peak
2	2400.000	28.28	7.32	36.62	73.36	72.34	74.00	1.66	Peak
3	2413.500	28.30	7.35	36.61	100.18	99.22	74.00	-25.22	Peak

Remarks: 1. Emission Level= Antenna Factor + Cable Loss + Reading - Amp Factor
 2. The emission levels that are 20dB below the official limit are not reported.

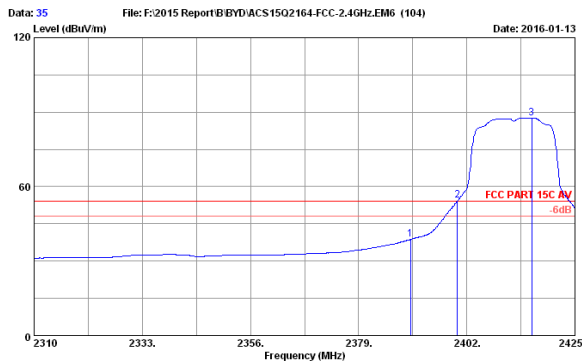

Site no. : 3m Chamber Data no. : 35
 Dis. / Ant. : 3m 2015 3115-4877 Ant. pol. : VERTICAL
 Limit : FCC PART 15C AV
 Env. / Ins. : 23.6°C/52.8%
 Engineer : Alice_yang
 EUT : Notebook
 Power rating : DC 20V From Adapter Input AC 120V/60Hz
 Test Mode : IEEE802.11g 2412MHz Tx
 R209-0184

No.	Freq. (MHz)	Ant. Factor (dB/m)	Cable Loss (dB)	AMP factor (dB)	Reading (dBuV)	Emission Level (dBuV/m)	Limits (dBuV/m)	Margin (dB)	Remark
1	2390.000	28.27	7.28	36.62	39.76	38.69	54.00	15.31	Average
2	2400.000	28.28	7.32	36.62	55.41	54.39	54.00	-0.39	Average
3	2415.800	28.30	7.35	36.61	88.70	87.74	54.00	-33.74	Average

Remarks: 1. Emission Level= Antenna Factor + Cable Loss + Reading - Amp Factor
 2. The emission levels that are 20dB below the official limit are not reported.

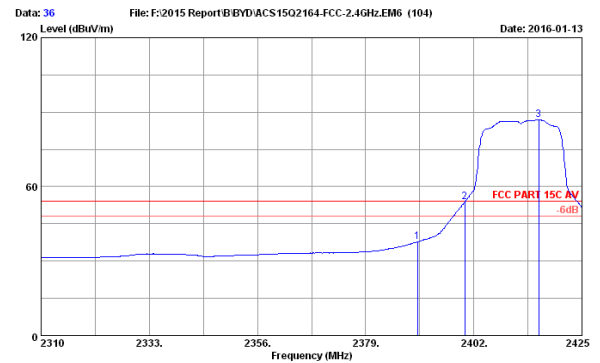

Site no. : 3m Chamber Data no. : 36
 Dis. / Ant. : 3m 2015 3115-4877 Ant. pol. : HORIZONTAL
 Limit : FCC PART 15C AV
 Env. / Ins. : 23.6°C/52.8%
 Engineer : Alice_yang
 EUT : Notebook
 Power rating : DC 20V From Adapter Input AC 120V/60Hz
 Test Mode : IEEE802.11g 2412MHz Tx
 R209-0184

No.	Freq. (MHz)	Ant. Factor (dB/m)	Cable Loss (dB)	AMP factor (dB)	Reading (dBuV)	Emission Level (dBuV/m)	Limits (dBuV/m)	Margin (dB)	Remark
1	2390.040	28.27	7.28	36.62	38.82	37.75	54.00	16.25	Average
2	2400.045	28.28	7.32	36.62	54.85	53.83	54.00	0.17	Average
3	2415.800	28.30	7.35	36.61	87.79	86.83	54.00	-32.83	Average

Remarks: 1. Emission Level= Antenna Factor + Cable Loss + Reading - Amp Factor
 2. The emission levels that are 20dB below the official limit are not reported.

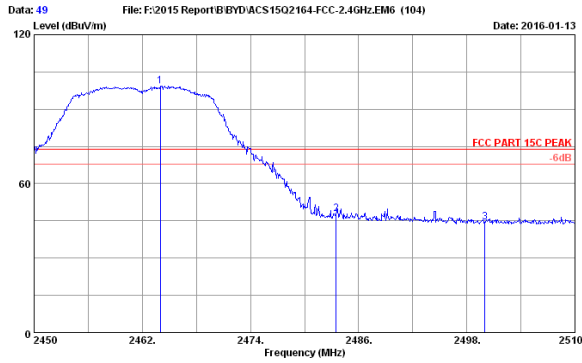

Site no. : 3m Chamber Data no. : 49
 Dis. / Ant. : 3m 2015 3115-4877 Ant. pol. : VERTICAL
 Limit : FCC PART 15C PEAK
 Env. / Ins. : 23.6°C/52.8%
 Engineer : Alice_yang
 EUT : Notebook
 Power rating : DC 20V From Adapter Input AC 120V/60Hz
 Test Mode : IEEE802.11g 2462MHz Tx
 R209-0184

No.	Freq. (MHz)	Ant. Factor (dB/m)	Cable Loss (dB)	AMP factor (dB)	Reading (dBuV)	Emission Level (dBuV/m)	Limits (dBuV/m)	Margin (dB)	Remark
1	2463.980	28.36	7.43	36.59	100.14	99.34	74.00	-25.34	Peak
2	2483.500	28.38	7.51	36.59	48.46	47.76	74.00	26.24	Peak
3	2500.000	28.40	7.51	36.58	45.18	44.51	74.00	29.49	Peak

Remarks: 1. Emission Level= Antenna Factor + Cable Loss + Reading - Amp Factor
 2. The emission levels that are 20dB below the official limit are not reported.

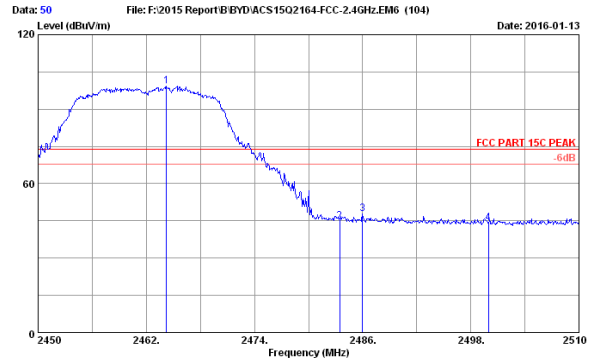

Site no. : 3m Chamber Data no. : 50
 Dis. / Ant. : 3m 2015 3115-4877 Ant. pol. : HORIZONTAL
 Limit : FCC PART 15C PEAK
 Env. / Ins. : 23.6°C/52.8%
 Engineer : Alice_yang
 EUT : Notebook
 Power rating : DC 20V From Adapter Input AC 120V/60Hz
 Test Mode : IEEE802.11g 2462MHz Tx
 R209-0184

No.	Freq. (MHz)	Ant. Factor (dB/m)	Cable Loss (dB)	AMP factor (dB)	Reading (dBuV)	Emission Level (dBuV/m)	Limits (dBuV/m)	Margin (dB)	Remark
1	2464.220	28.36	7.43	36.59	100.09	99.29	74.00	-25.29	Peak
2	2483.480	28.38	7.51	36.59	45.64	44.94	74.00	29.06	Peak
3	2486.000	28.38	7.51	36.59	48.52	47.82	74.00	26.18	Peak
4	2499.900	28.40	7.51	36.58	44.91	44.24	74.00	29.76	Peak

Remarks: 1. Emission Level= Antenna Factor + Cable Loss + Reading - Amp Factor
 2. The emission levels that are 20dB below the official limit are not reported.

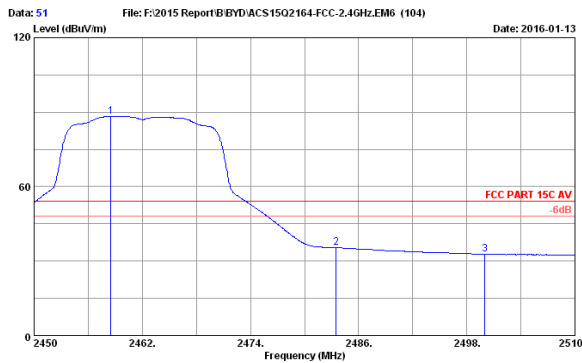

Site no. : 3m Chamber Data no. : 51
 Dis. / Ant. : 3m 2015 3115-4877 Ant. pol. : HORIZONTAL
 Limit : FCC PART 15C AV
 Env. / Ins. : 23.6°C/52.8%
 Engineer : Alice_yang
 EUT : Notebook
 Power rating : DC 20V From Adapter Input AC 120V/60Hz
 Test Mode : IEEE802.11g 2462MHz Tx
 R209-0184

No.	Freq. (MHz)	Ant. Factor (dB/m)	Cable Loss (dB)	AMP factor (dB)	Reading (dBuV)	Emission Level (dBuV/m)	Limits (dBuV/m)	Margin (dB)	Remark
1	2458.520	28.35	7.43	36.60	89.03	88.21	54.00	-34.21	Average
2	2483.500	28.38	7.51	36.59	36.08	35.38	54.00	18.62	Average
3	2500.000	28.40	7.51	36.58	33.41	32.74	54.00	21.26	Average

Remarks: 1. Emission Level= Antenna Factor + Cable Loss + Reading - Amp Factor
 2. The emission levels that are 20dB below the official limit are not reported.

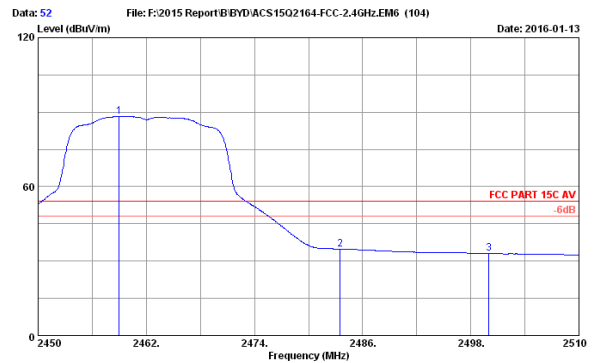

Site no. : 3m Chamber Data no. : 52
 Dis. / Ant. : 3m 2015 3115-4877 Ant. pol. : VERTICAL
 Limit : FCC PART 15C AV
 Env. / Ins. : 23.6°C/52.8%
 Engineer : Alice_yang
 EUT : Notebook
 Power rating : DC 20V From Adapter Input AC 120V/60Hz
 Test Mode : IEEE802.11g 2462MHz Tx
 R209-0184

No.	Freq. (MHz)	Ant. Factor (dB/m)	Cable Loss (dB)	AMP factor (dB)	Reading (dBuV)	Emission Level (dBuV/m)	Limits (dBuV/m)	Margin (dB)	Remark
1	2459.000	28.35	7.43	36.60	88.95	88.13	54.00	-34.13	Average
2	2483.500	28.38	7.51	36.59	35.50	34.80	54.00	19.20	Average
3	2500.000	28.40	7.51	36.58	33.68	33.01	54.00	20.99	Average

Remarks: 1. Emission Level= Antenna Factor + Cable Loss + Reading - Amp Factor
 2. The emission levels that are 20dB below the official limit are not reported.

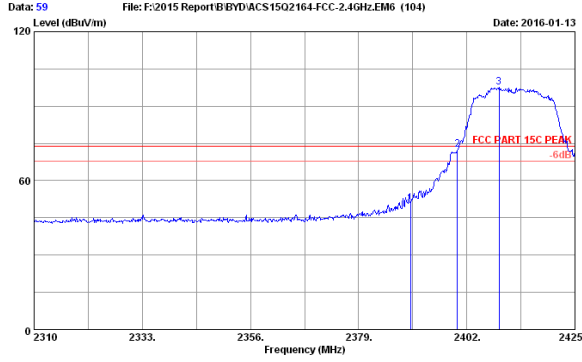

Site no. : 3m Chamber Data no. : 59
 Dis. / Ant. : 3m 2015 3115-4877 Ant. pol. : HORIZONTAL
 Limit : FCC PART 15C PEAK
 Env. / Ins. : 23.6°C/52.8%
 Engineer : Alice_yang
 EUT : Notebook
 Power rating : DC 20V From Adapter Input AC 120V/60Hz
 Test Mode : IEEE802.11nHT20 2412MHz TX
 R209-0184

No.	Freq. (MHz)	Ant. Factor (dB/m)	Cable Loss (dB)	AMP factor (dB)	Reading (dBuV)	Emission Level (dBuV/m)	Limits (dBuV/m)	Margin (dB)	Remark
1	2390.000	28.27	7.28	36.62	51.90	50.83	74.00	23.17	Peak
2	2400.000	28.28	7.32	36.62	73.63	72.61	74.00	1.39	Peak
3	2408.900	28.29	7.32	36.62	98.51	97.50	74.00	-23.50	Peak

Remarks: 1. Emission Level= Antenna Factor + Cable Loss + Reading - Amp Factor
 2. The emission levels that are 20dB below the official limit are not reported.

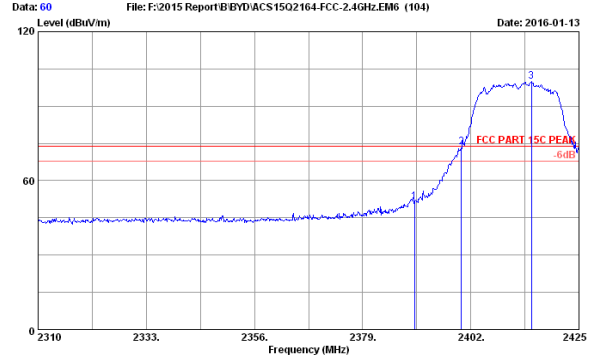

Site no. : 3m Chamber Data no. : 60
 Dis. / Ant. : 3m 2015 3115-4877 Ant. pol. : VERTICAL
 Limit : FCC PART 15C PEAK
 Env. / Ins. : 23.6°C/52.8%
 Engineer : Alice_yang
 EUT : Notebook
 Power rating : DC 20V From Adapter Input AC 120V/60Hz
 Test Mode : IEEE802.11nHT20 2412MHz TX
 R209-0184

No.	Freq. (MHz)	Ant. Factor (dB/m)	Cable Loss (dB)	AMP factor (dB)	Reading (dBuV)	Emission Level (dBuV/m)	Limits (dBuV/m)	Margin (dB)	Remark
1	2390.000	28.27	7.28	36.62	52.40	51.33	74.00	22.67	Peak
2	2400.000	28.28	7.32	36.62	74.52	73.50	74.00	0.50	Peak
3	2414.880	28.30	7.35	36.61	100.99	100.03	74.00	-26.03	Peak

Remarks: 1. Emission Level= Antenna Factor + Cable Loss + Reading - Amp Factor
 2. The emission levels that are 20dB below the official limit are not reported.

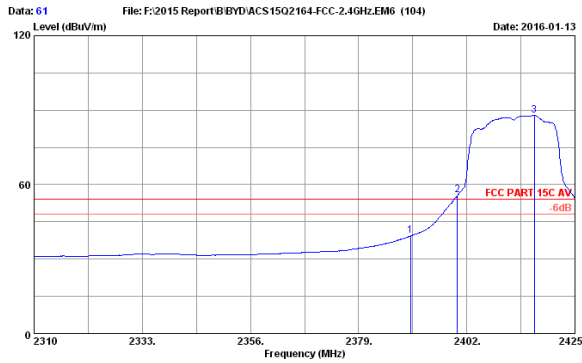

Site no. : 3m Chamber Data no. : 61
 Dis. / Ant. : 3m 2015 3115-4877 Ant. pol. : VERTICAL
 Limit : FCC PART 15C AV
 Env. / Ins. : 23.6°C/52.8%
 Engineer : Alice_yang
 EUT : Notebook
 Power rating : DC 20V From Adapter Input AC 120V/60Hz
 Test Mode : IEEE802.11nHT20 2412MHz TX
 R209-0184

No.	Freq. (MHz)	Ant. Factor (dB/m)	Cable Loss (dB)	AMP factor (dB)	Reading (dBuV)	Emission Level (dBuV/m)	Limits (dBuV/m)	Margin (dB)	Remark
1	2390.000	28.27	7.28	36.62	40.38	39.31	54.00	14.69	Average
2	2400.000	28.28	7.32	36.62	56.84	55.82	54.00	-1.82	Average
3	2416.375	28.30	7.35	36.61	86.74	87.78	54.00	-33.78	Average

Remarks: 1. Emission Level= Antenna Factor + Cable Loss + Reading - Amp Factor
 2. The emission levels that are 20dB below the official limit are not reported.

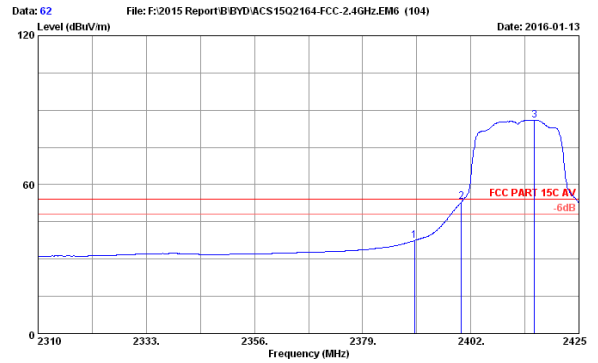

Site no. : 3m Chamber Data no. : 62
 Dis. / Ant. : 3m 2015 3115-4877 Ant. pol. : HORIZONTAL
 Limit : FCC PART 15C AV
 Env. / Ins. : 23.6°C/52.8%
 Engineer : Alice_yang
 EUT : Notebook
 Power rating : DC 20V From Adapter Input AC 120V/60Hz
 Test Mode : IEEE802.11nHT20 2412MHz TX
 R209-0184

No.	Freq. (MHz)	Ant. Factor (dB/m)	Cable Loss (dB)	AMP factor (dB)	Reading (dBuV)	Emission Level (dBuV/m)	Limits (dBuV/m)	Margin (dB)	Remark
1	2390.000	28.27	7.28	36.62	38.55	37.48	54.00	16.52	Average
2	2400.000	28.28	7.32	36.62	54.25	53.23	54.00	0.77	Average
3	2415.570	28.30	7.35	36.61	86.93	85.97	54.00	-31.97	Average

Remarks: 1. Emission Level= Antenna Factor + Cable Loss + Reading - Amp Factor
 2. The emission levels that are 20dB below the official limit are not reported.

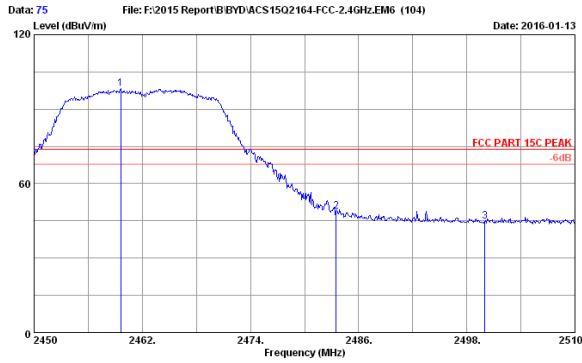

Site no. : 3m Chamber Data no. : 75
 Dis. / Ant. : 3m 2015 3115-4877 Ant. pol. : HORIZONTAL
 Limit : FCC PART 15C PEAK
 Env. / Ins. : 23.6°C/52.8%
 Engineer : Alice_yang
 EUT : Notebook
 Power rating : DC 20V From Adapter Input AC 120V/60Hz
 Test Mode : IEEE802.11nHT20 2462MHz TX
 R209-0184

No.	Freq. (MHz)	Ant. Factor (dB/m)	Cable Loss (dB)	AMP factor (dB)	Reading (dBuV)	Emission Level (dBuV/m)	Limits (dBuV/m)	Margin (dB)	Remark
1	2459.600	28.35	7.43	36.60	99.07	98.25	74.00	-24.25	Peak
2	2483.500	28.38	7.51	36.59	49.38	48.68	74.00	25.32	Peak
3	2500.000	28.40	7.51	36.58	45.49	44.82	74.00	29.18	Peak

Remarks: 1. Emission Level= Antenna Factor + Cable Loss + Reading - Amp Factor
 2. The emission levels that are 20dB below the official limit are not reported.

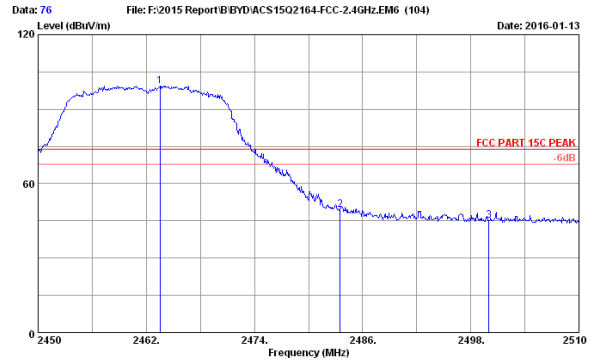

Site no. : 3m Chamber Data no. : 76
 Dis. / Ant. : 3m 2015 3115-4877 Ant. pol. : VERTICAL
 Limit : FCC PART 15C PEAK
 Env. / Ins. : 23.6°C/52.8%
 Engineer : Alice_yang
 EUT : Notebook
 Power rating : DC 20V From Adapter Input AC 120V/60Hz
 Test Mode : IEEE802.11nHT20 2462MHz TX
 R209-0184

No.	Freq. (MHz)	Ant. Factor (dB/m)	Cable Loss (dB)	AMP factor (dB)	Reading (dBuV)	Emission Level (dBuV/m)	Limits (dBuV/m)	Margin (dB)	Remark
1	2463.500	28.36	7.43	36.59	100.24	99.44	74.00	-25.44	Peak
2	2483.500	28.38	7.51	36.59	50.18	49.48	74.00	24.52	Peak
3	2500.000	28.40	7.51	36.58	45.85	45.18	74.00	28.82	Peak

Remarks: 1. Emission Level= Antenna Factor + Cable Loss + Reading - Amp Factor
 2. The emission levels that are 20dB below the official limit are not reported.

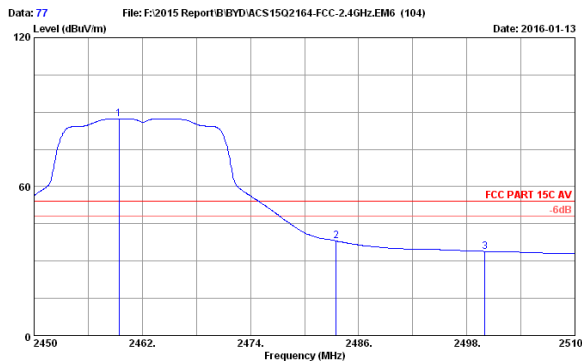

Site no. : 3m Chamber Data no. : 77
 Dis. / Ant. : 3m 2015 3115-4877 Ant. pol. : VERTICAL
 Limit : FCC PART 15C AV
 Env. / Ins. : 23.6°C/52.8%
 Engineer : Alice_yang
 EUT : Notebook
 Power rating : DC 20V From Adapter Input AC 120V/60Hz
 Test Mode : IEEE802.11nHT20 2462MHz TX
 R209-0184

No.	Freq. (MHz)	Ant. Factor (dB/m)	Cable Loss (dB)	AMP factor (dB)	Reading (dBuV)	Emission Level (dBuV/m)	Limits (dBuV/m)	Margin (dB)	Remark
1	2459.420	28.35	7.43	36.60	88.16	87.34	54.00	-33.34	Average
2	2483.500	28.38	7.51	36.59	38.81	38.11	54.00	15.89	Average
3	2500.000	28.40	7.51	36.58	34.55	33.88	54.00	20.12	Average

Remarks: 1. Emission Level= Antenna Factor + Cable Loss + Reading - Amp Factor
 2. The emission levels that are 20dB below the official limit are not reported.

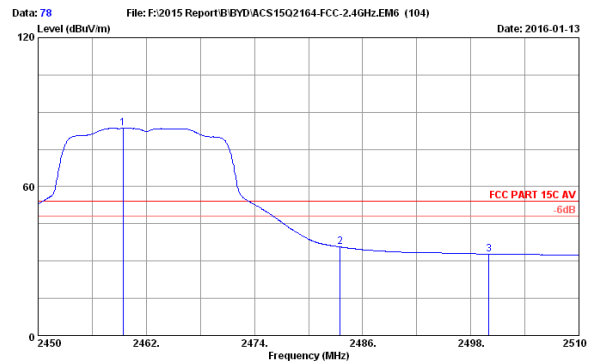

Site no. : 3m Chamber Data no. : 78
 Dis. / Ant. : 3m 2015 3115-4877 Ant. pol. : HORIZONTAL
 Limit : FCC PART 15C AV
 Env. / Ins. : 23.6°C/52.8%
 Engineer : Alice_yang
 EUT : Notebook
 Power rating : DC 20V From Adapter Input AC 120V/60Hz
 Test Mode : IEEE802.11nHT20 2462MHz TX
 R209-0184

No.	Freq. (MHz)	Ant. Factor (dB/m)	Cable Loss (dB)	AMP factor (dB)	Reading (dBuV)	Emission Level (dBuV/m)	Limits (dBuV/m)	Margin (dB)	Remark
1	2459.420	28.35	7.43	36.60	84.33	83.51	54.00	-29.51	Average
2	2483.500	28.38	7.51	36.59	36.39	35.69	54.00	18.31	Average
3	2500.000	28.40	7.51	36.58	33.47	32.80	54.00	21.20	Average

Remarks: 1. Emission Level= Antenna Factor + Cable Loss + Reading - Amp Factor
 2. The emission levels that are 20dB below the official limit are not reported.

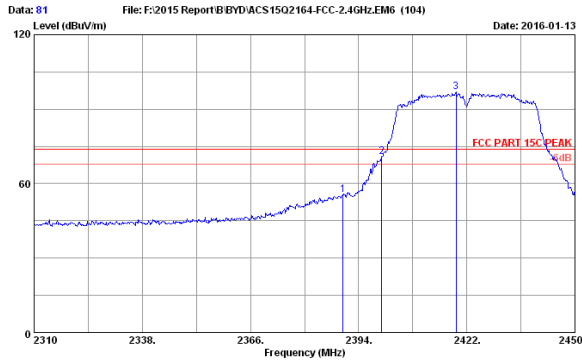

Site no. : 3m Chamber Data no. : 81
 Dis. / Ant. : 3m 2015 3115-4877 Ant. pol. : VERTICAL
 Limit : FCC PART 15C PEAK
 Env. / Ins. : 23.6°C/52.8%
 Engineer : Alice_yang
 EUT : Notebook
 Power rating : DC 20V From Adapter Input AC 120V/60Hz
 Test Mode : IEEE802.11nHT40 2422MHz TX
 R209-0184

No.	Freq. (MHz)	Ant. Factor (dB/m)	Cable Loss (dB)	AMP factor (dB)	Reading (dBuV)	Emission Level (dBuV/m)	Limits (dBuV/m)	Margin (dB)	Remark
1	2390.000	28.27	7.28	36.62	56.62	55.55	74.00	18.45	Peak
2	2400.000	28.28	7.32	36.62	71.82	70.80	74.00	3.20	Peak
3	2419.200	28.30	7.35	36.61	97.77	96.81	74.00	-22.81	Peak

Remarks: 1. Emission Level= Antenna Factor + Cable Loss + Reading - Amp Factor
 2. The emission levels that are 20dB below the official limit are not reported.

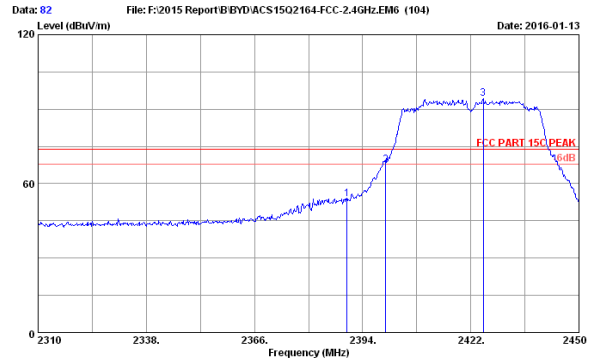

Site no. : 3m Chamber Data no. : 82
 Dis. / Ant. : 3m 2015 3115-4877 Ant. pol. : HORIZONTAL
 Limit : FCC PART 15C PEAK
 Env. / Ins. : 23.6°C/52.8%
 Engineer : Alice_yang
 EUT : Notebook
 Power rating : DC 20V From Adapter Input AC 120V/60Hz
 Test Mode : IEEE802.11nHT40 2422MHz TX
 R209-0184

No.	Freq. (MHz)	Ant. Factor (dB/m)	Cable Loss (dB)	AMP factor (dB)	Reading (dBuV)	Emission Level (dBuV/m)	Limits (dBuV/m)	Margin (dB)	Remark
1	2390.000	28.27	7.28	36.62	54.02	53.75	74.00	20.25	Peak
2	2400.000	28.28	7.32	36.62	68.55	67.53	74.00	6.47	Peak
3	2425.220	28.31	7.35	36.61	95.20	94.25	74.00	-20.25	Peak

Remarks: 1. Emission Level= Antenna Factor + Cable Loss + Reading - Amp Factor
 2. The emission levels that are 20dB below the official limit are not reported.

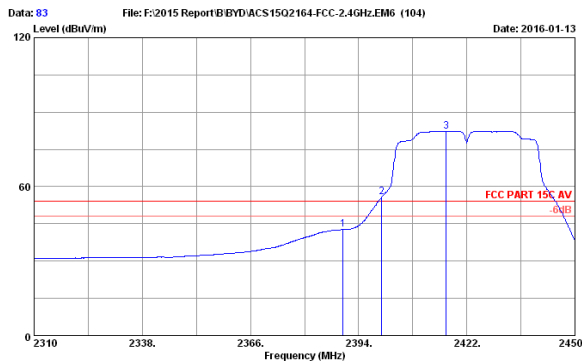

Site no. : 3m Chamber Data no. : 83
 Dis. / Ant. : 3m 2015 3115-4877 Ant. pol. : HORIZONTAL
 Limit : FCC PART 15C AV
 Env. / Ins. : 23.6°C/52.8%
 Engineer : Alice_yang
 EUT : Notebook
 Power rating : DC 20V From Adapter Input AC 120V/60Hz
 Test Mode : IEEE802.11nHT40 2422MHz TX
 R209-0184

No.	Freq. (MHz)	Ant. Factor (dB/m)	Cable Loss (dB)	AMP factor (dB)	Reading (dBuV)	Emission Level (dBuV/m)	Limits (dBuV/m)	Margin (dB)	Remark
1	2390.000	28.27	7.28	36.62	43.76	42.69	54.00	11.31	Average
2	2400.000	28.28	7.32	36.62	57.00	55.98	54.00	-1.98	Average
3	2416.680	28.30	7.35	36.61	83.34	82.38	54.00	-28.38	Average

Remarks: 1. Emission Level= Antenna Factor + Cable Loss + Reading - Amp Factor
 2. The emission levels that are 20dB below the official limit are not reported.

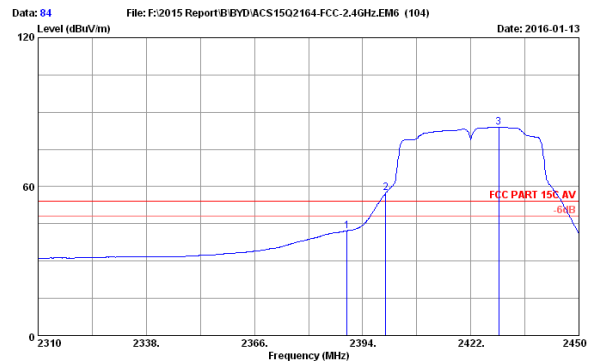

Site no. : 3m Chamber Data no. : 84
 Dis. / Ant. : 3m 2015 3115-4877 Ant. pol. : VERTICAL
 Limit : FCC PART 15C AV
 Env. / Ins. : 23.6°C/52.8%
 Engineer : Alice_yang
 EUT : Notebook
 Power rating : DC 20V From Adapter Input AC 120V/60Hz
 Test Mode : IEEE802.11nHT40 2422MHz TX
 R209-0184

No.	Freq. (MHz)	Ant. Factor (dB/m)	Cable Loss (dB)	AMP factor (dB)	Reading (dBuV)	Emission Level (dBuV/m)	Limits (dBuV/m)	Margin (dB)	Remark
1	2390.000	28.27	7.28	36.62	43.30	42.23	54.00	11.77	Average
2	2400.000	28.28	7.32	36.62	58.57	57.55	54.00	-3.55	Average
3	2429.280	28.32	7.39	36.61	84.83	83.93	54.00	-29.93	Average

Remarks: 1. Emission Level= Antenna Factor + Cable Loss + Reading - Amp Factor
 2. The emission levels that are 20dB below the official limit are not reported.

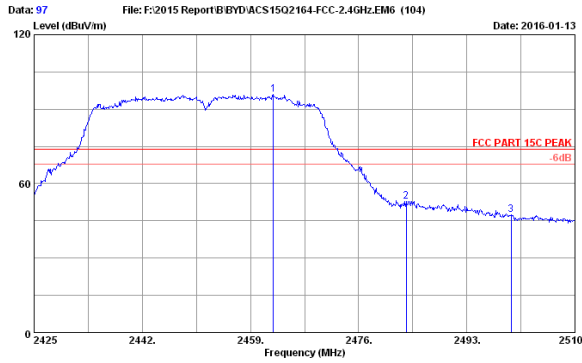

Site no. : 3m Chamber Data no. : 97
 Dis. / Ant. : 3m 2015 3115-4877 Ant. pol. : VERTICAL
 Limit : FCC PART 15C PEAK
 Env. / Ins. : 23.6°C/52.8%
 Engineer : Alice_yang
 EUT : Notebook
 Power rating : DC 20V From Adapter Input AC 120V/60Hz
 Test Mode : IEEE802.11nHT40 2452MHz TX
 R209-0184

No.	Freq. (MHz)	Ant. Factor (dB/m)	Cable Loss (dB)	AMP factor (dB)	Reading (dBuV)	Emission Level (dBuV/m)	Limits (dBuV/m)	Margin (dB)	Remark
1	2462.570	28.36	7.43	36.59	96.69	95.89	74.00	-21.89	Peak
2	2483.500	28.38	7.51	36.59	53.47	52.77	74.00	21.23	Peak
3	2500.000	28.40	7.51	36.58	48.06	47.39	74.00	26.61	Peak

Remarks: 1. Emission Level= Antenna Factor + Cable Loss + Reading - Amp Factor
 2. The emission levels that are 20dB below the official limit are not reported.

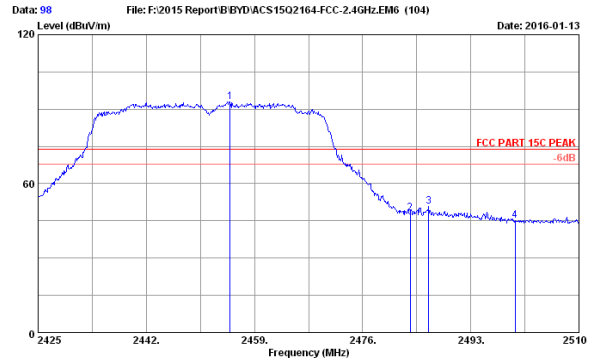

Site no. : 3m Chamber Data no. : 98
 Dis. / Ant. : 3m 2015 3115-4877 Ant. pol. : HORIZONTAL
 Limit : FCC PART 15C PEAK
 Env. / Ins. : 23.6°C/52.8%
 Engineer : Alice_yang
 EUT : Notebook
 Power rating : DC 20V From Adapter Input AC 120V/60Hz
 Test Mode : IEEE802.11nHT40 2452MHz TX
 R209-0184

No.	Freq. (MHz)	Ant. Factor (dB/m)	Cable Loss (dB)	AMP factor (dB)	Reading (dBuV)	Emission Level (dBuV/m)	Limits (dBuV/m)	Margin (dB)	Remark
1	2455.175	28.35	7.43	36.60	93.67	92.85	74.00	-18.85	Peak
2	2483.500	28.38	7.51	36.59	48.80	48.10	74.00	25.90	Peak
3	2486.370	28.38	7.51	36.59	51.42	50.72	74.00	23.28	Peak
4	2500.000	28.40	7.51	36.58	45.75	45.08	74.00	28.92	Peak

Remarks: 1. Emission Level= Antenna Factor + Cable Loss + Reading - Amp Factor
 2. The emission levels that are 20dB below the official limit are not reported.

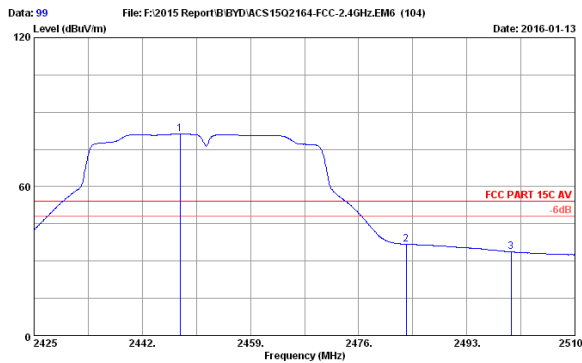

Site no. : 3m Chamber Data no. : 99
 Dis. / Ant. : 3m 2015 3115-4877 Ant. pol. : HORIZONTAL
 Limit : FCC PART 15C AV
 Env. / Ins. : 23.6°C/52.8%
 Engineer : Alice_yang
 EUT : Notebook
 Power rating : DC 20V From Adapter Input AC 120V/60Hz
 Test Mode : IEEE802.11nHT40 2452MHz TX
 R209-0184

No.	Freq. (MHz)	Ant. Factor (dB/m)	Cable Loss (dB)	AMP factor (dB)	Reading (dBuV)	Emission Level (dBuV/m)	Limits (dBuV/m)	Margin (dB)	Remark
1	2447.950	28.34	7.43	36.60	82.00	81.17	54.00	-27.17	Average
2	2483.500	28.38	7.51	36.59	37.54	36.84	54.00	17.16	Average
3	2500.000	28.40	7.51	36.58	34.42	33.75	54.00	20.25	Average

Remarks: 1. Emission Level= Antenna Factor + Cable Loss + Reading - Amp Factor
 2. The emission levels that are 20dB below the official limit are not reported.

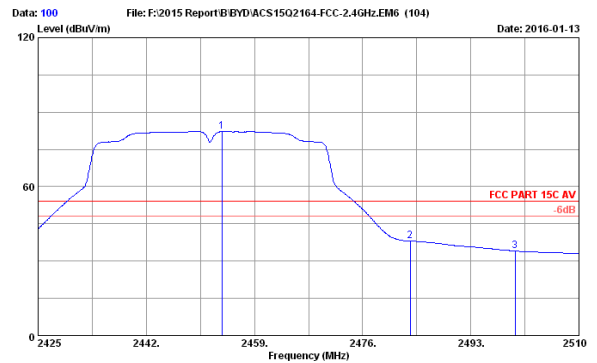

Site no. : 3m Chamber Data no. : 100
 Dis. / Ant. : 3m 2015 3115-4877 Ant. pol. : VERTICAL
 Limit : FCC PART 15C AV
 Env. / Ins. : 23.6°C/52.8%
 Engineer : Alice_yang
 EUT : Notebook
 Power rating : DC 20V From Adapter Input AC 120V/60Hz
 Test Mode : IEEE802.11nHT40 2452MHz TX
 R209-0184

No.	Freq. (MHz)	Ant. Factor (dB/m)	Cable Loss (dB)	AMP factor (dB)	Reading (dBuV)	Emission Level (dBuV/m)	Limits (dBuV/m)	Margin (dB)	Remark
1	2453.900	28.34	7.43	36.60	83.08	82.25	54.00	-28.25	Average
2	2483.500	28.38	7.51	36.59	38.80	38.10	54.00	15.90	Average
3	2500.000	28.40	7.51	36.58	34.73	34.06	54.00	19.94	Average

Remarks: 1. Emission Level= Antenna Factor + Cable Loss + Reading - Amp Factor
 2. The emission levels that are 20dB below the official limit are not reported.

7. 6dB & 99% Bandwidth Test

7.1. Test Equipment

Item	Equipment	Manufacturer	Model No.	Serial No.	Last Cal.	Cal. Interval
1.	Spectrum	Agilent	N9030A	MY51380221	Oct.17, 15	1 Year
2.	Attenuator	Agilent	8491B	MY39262165	Apr.28, 15	1 Year
3.	RF Cable	Hubersuhner	SUCOFLEX102	28620/2	Apr.28, 15	1 Year

7.2. Limit

For direct sequence systems, the minimum 6dB bandwidth shall be at least 500kHz

7.3. Test Procedure

The transmitter output was connected to a spectrum analyzer, The bandwidth of the fundamental frequency was measured by spectrum analyzer with 100kHz RBW and 300kHz VBW. The 6dB bandwidth is defined as the total spectrum the power of which is higher than peak power minus 6dB.

7.4. Test Results

EUT: Notebook		
M/N: RZ09-0184		
Test date: 2016-01-22	Pressure: 102.3±1.0kpa	Humidity: 50.7±3.0%
Tested by: Alice-Yang	Test site: RF site	Temperature: 21.9±0.6 °C

Test Mode	CH	6dB bandwidth (MHz)		Limit (kHz)
		ANT1	ANT2	
11b	CH1	10.05	10.06	>500
	CH6	10.06	10.04	>500
	CH11	10.07	10.06	>500
11g	CH1	15.28	15.30	>500
	CH6	15.13	15.32	>500
	CH11	15.13	15.13	>500
11n HT20	CH1	15.33	16.31	>500
	CH6	15.15	16.55	>500
	CH11	15.14	17.26	>500
11n HT40	CH3	35.13	35.08	>500
	CH6	35.14	35.28	>500
	CH9	35.14	35.69	>500
Conclusion : PASS				

Test Mode	CH	99% Bandwidth (MHz)		Limit (kHz)
		ANT1	ANT2	
11b	CH1	13.645	13.570	N/A
	CH6	13.578	13.545	N/A
	CH11	13.557	13.666	N/A
11g	CH1	16.379	16.379	N/A
	CH6	16.398	16.414	N/A
	CH11	16.391	16.388	N/A
11n HT20	CH1	17.671	17.601	N/A
	CH6	17.613	17.614	N/A
	CH11	17.603	17.628	N/A
11n HT40	CH3	36.080	36.061	N/A
	CH6	36.073	36.074	N/A
	CH9	36.061	36.097	N/A

Conclusion : PASS

ANT1:

Test Mode: IEEE 802.11b
Test CH1: 2412MHz

Test Mode: IEEE 802.11g
Test CH1: 2412MHz



Test CH6: 2437MHz

Test CH6: 2437MHz

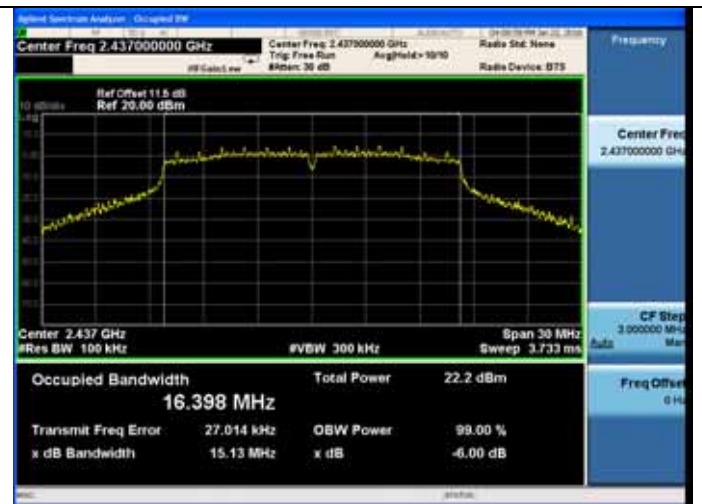
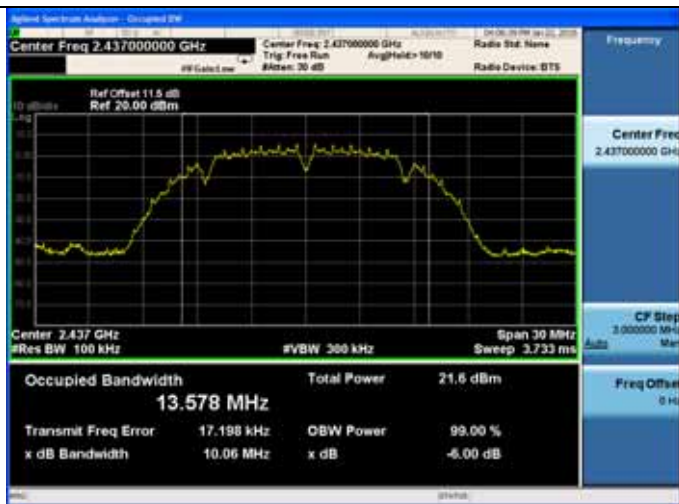

Test CH11: 2462MHz

Test CH11: 2462MHz

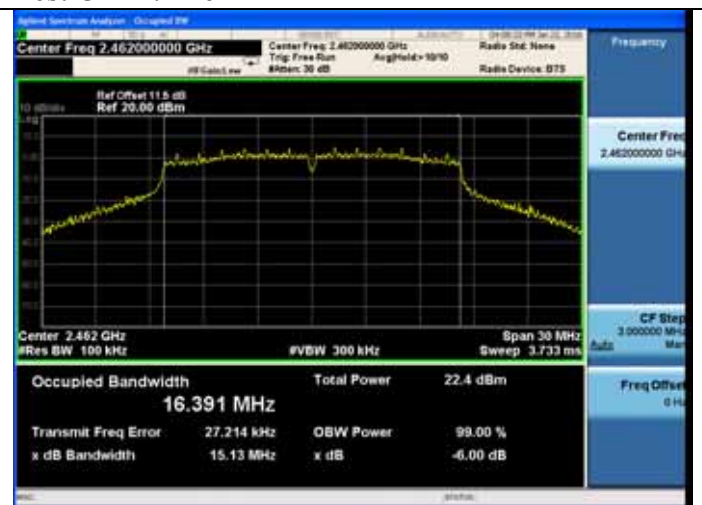
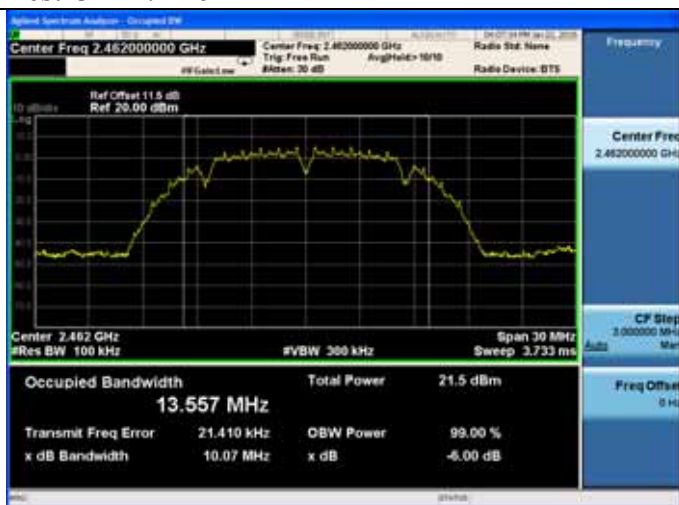

Test Mode: IEEE 802.11n HT20
Test CH1: 2412MHz

Test Mode: IEEE 802.11n HT40
Test CH3: 2422MHz

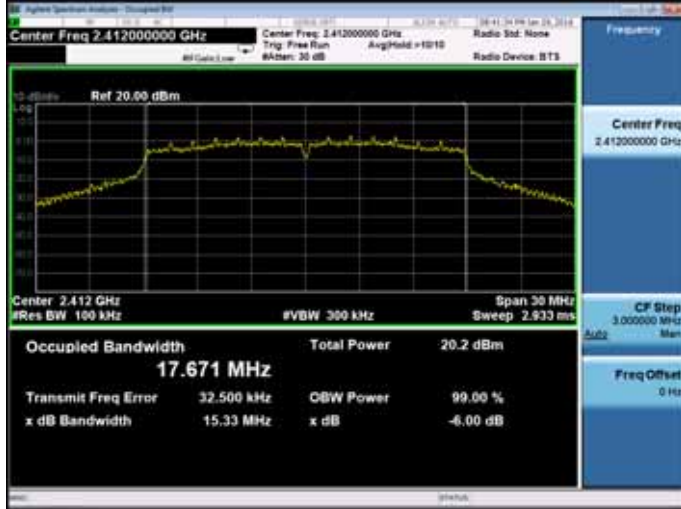

Test CH6: 2437MHz

Test CH6: 2437MHz

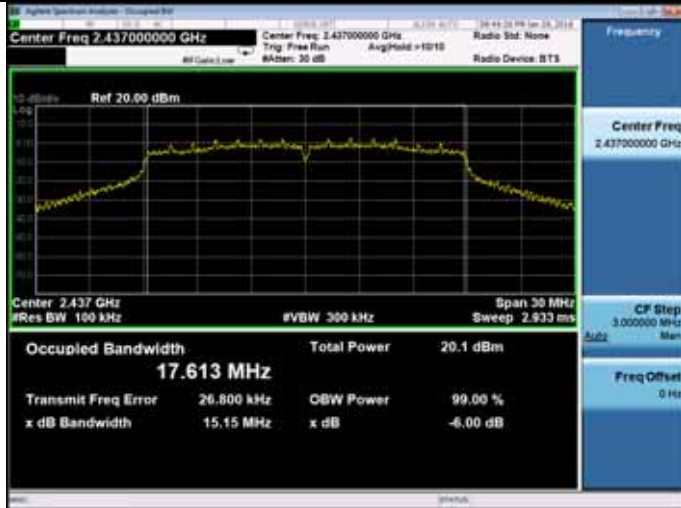

Test CH11: 2462MHz

Test CH9: 2452MHz



ANT2:

Test Mode: IEEE 802.11b
Test CH1: 2412MHz

Test Mode: IEEE 802.11g
Test CH1: 2412MHz

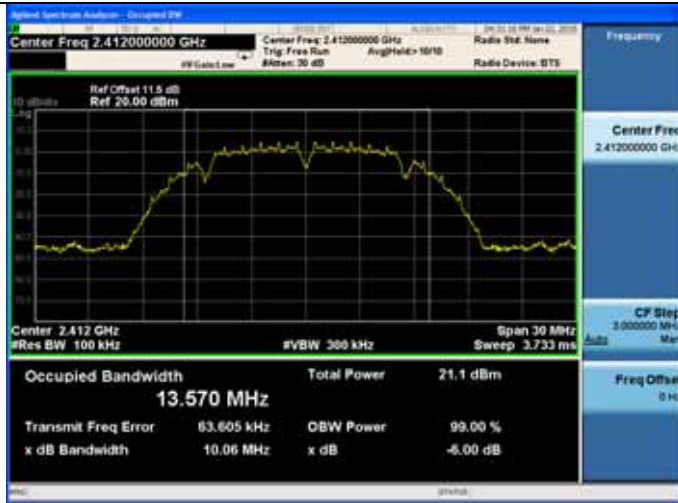

Test CH6: 2437MHz

Test CH6: 2437MHz

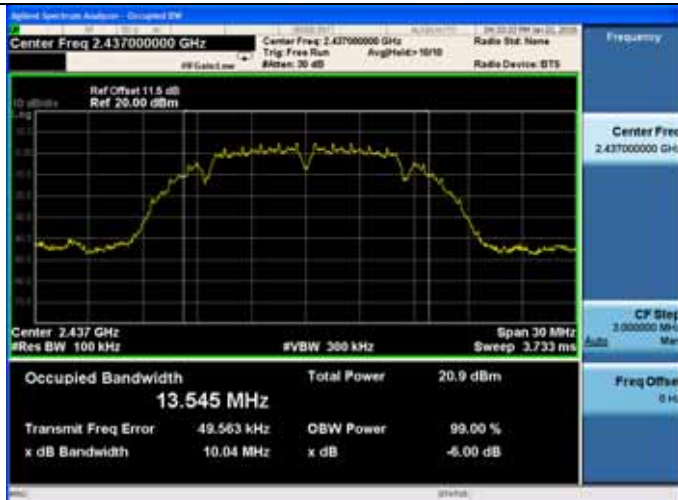

Test CH11: 2462MHz

Test CH11: 2462MHz

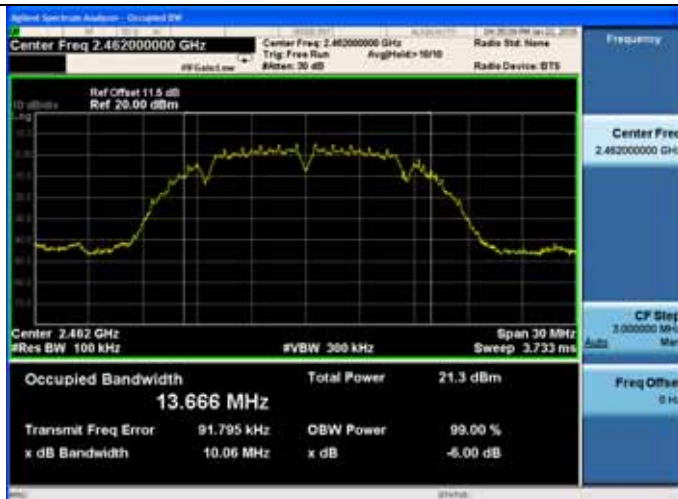

Test Mode: IEEE 802.11n HT20
Test CH1: 2412MHz

Test Mode: IEEE 802.11n HT40
Test CH3: 2422MHz

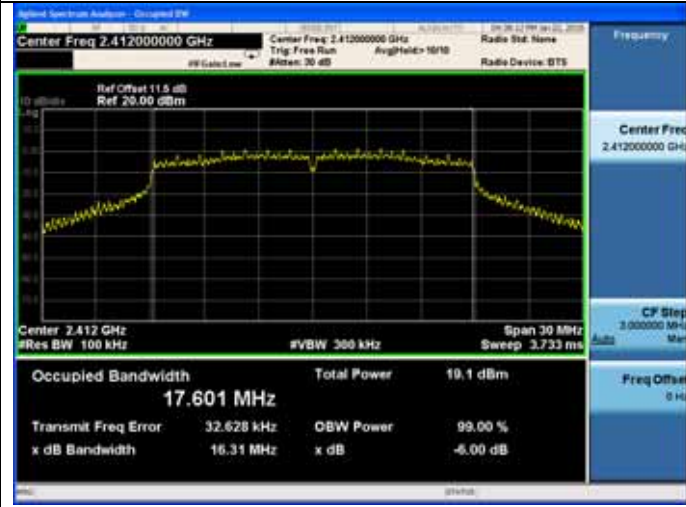

Test CH6: 2437MHz

Test CH6: 2437MHz

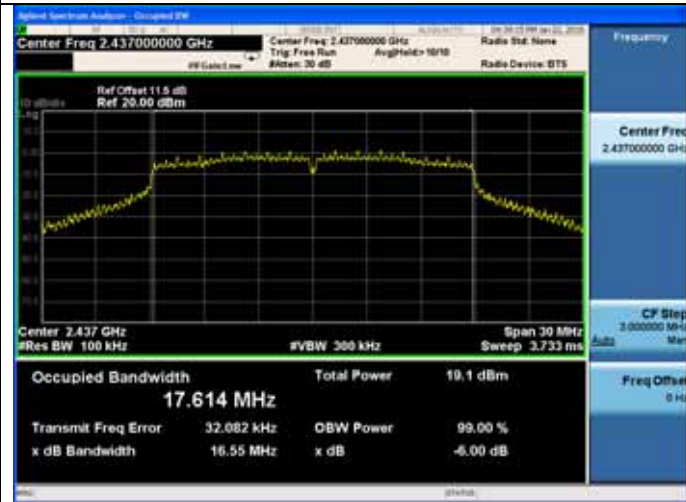

Test CH11: 2462MHz

Test CH9: 2452MHz

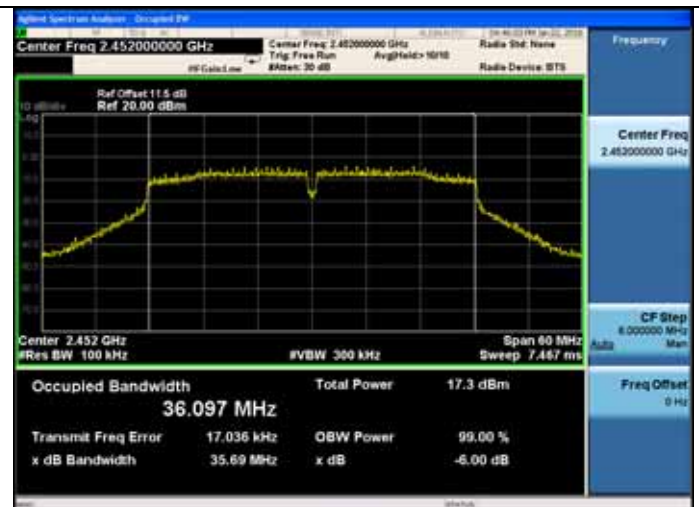
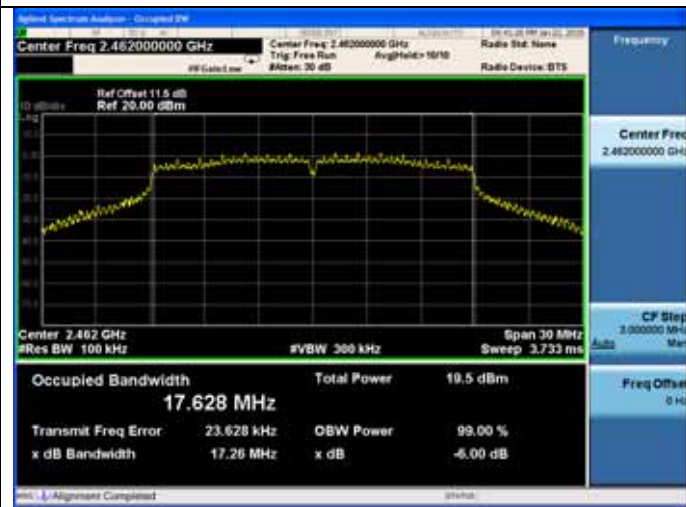

8. OUTPUT POWER TEST

8.1. Test Equipment

Item	Equipment	Manufacturer	Model No.	Serial No.	Last Cal.	Cal. Interval
1.	Spectrum	Agilent	N9030A	MY51380221	Oct.17, 15	1Year
2.	Power meter	Anritsu	ML2487A	6K00002472	Apr.28, 15	1Year
3.	Power sensor	Anritsu	MA2491A	0033005	Apr.28, 15	1Year
4.	Attenuator	Agilent	8491B	MY39262165	Apr.28, 15	1Year
5.	RF Cable	Hubersuhner	SUCOFLEX102	28610/2	Apr.28, 15	1Year

8.2. Limit (FCC Part 15C 15.247 b(3))

For systems using digital modulation in the 2400—2483.5MHz, The Peak output Power shall not exceed 1W(30dBm), As an alternative to a peak power measurement, compliance with the one Watt limit can be based on a measurement of the maximum conducted output power. Maximum Conducted Output Power is defined as the total transmit power delivered to all antennas and antenna elements averaged across all symbols in the signaling alphabet when the transmitter is operating at its maximum power control level.

8.3. Test Procedure

- 1, Connected the EUT's antenna port to measure device by 26dB attenuator.
- 2, For IEEE 802.11b/g and IEEE802.11n HT20 modes, use a power meter which bandwidth is 20MHz, above the bandwidth of signals, to measure out output power in each mode.
- 3, For IEEE802.11n HT40 mode, since the signal bandwidth is nearly 40MHz, which is above 20MHz bandwidth of power sensor of ML2491A. use the test method descried in KDB558074 clause 9.2.2.
 - 1) Set the RBW=1MHz and VBW =3MHz
 - 2) Set the span at least 1.5 times the OBW
 - 3) Detector = RMS
 - 4) Sweep time = auto couple
 - 5) allow trace to fully stabilize
 - 6) use the spectrum analyser's integrated band power measurement function with band limits set equal to the EBW band edges.

Note: The cable loss and attenuator loss were offset into measure device as an amplitude offset.

8.4. Test Results

EUT: Notebook					
M/N: RZ09-0184					
Test date: 2016-01-12		Pressure: 102.4±1.0kpa		Humidity: 52.6±3.0%	
Tested by: Alice-Yang		Test site: RF site		Temperature:23.4±0.6 °C	
Test Mode	CH	output Power (dBm)			Limit (dBm)
		ANT 1	ANT 2	Total	
11b	CH1	15.24	15.05	N/A	30
	CH6	15.39	14.93	N/A	30
	CH11	15.18	14.98	N/A	30
11g	CH1	15.98	15.82	N/A	30
	CH6	16.09	15.72	N/A	30
	CH11	15.92	15.83	N/A	30
11n HT20	CH1	12.55	12.08	15.33	30
	CH6	12.71	12.03	15.39	30
	CH11	12.73	12.09	15.43	30
11n HT40	CH3	12.48	12.62	15.56	30
	CH6	12.42	12.57	15.51	30
	CH9	11.53	11.59	14.57	30
Conclusion: PASS					

ANT1:

Test Mode: IEEE 802.11n HT40
Test CH3: 2422MHz

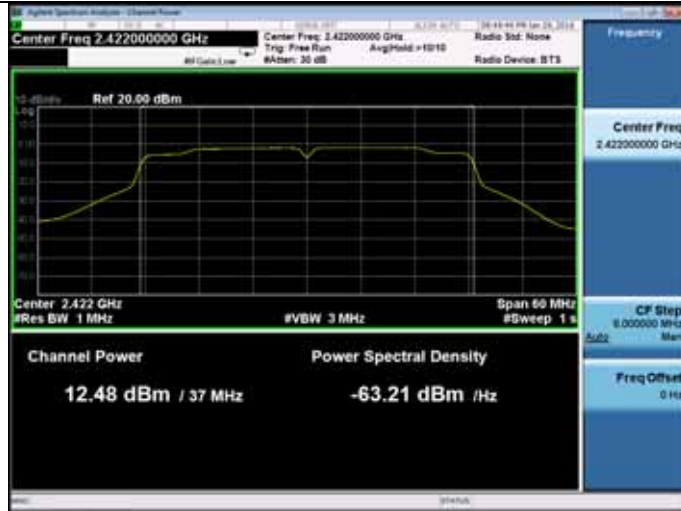

ANT2:

Test Mode: IEEE 802.11n HT40
Test CH3: 2422MHz



Test CH6: 2437MHz

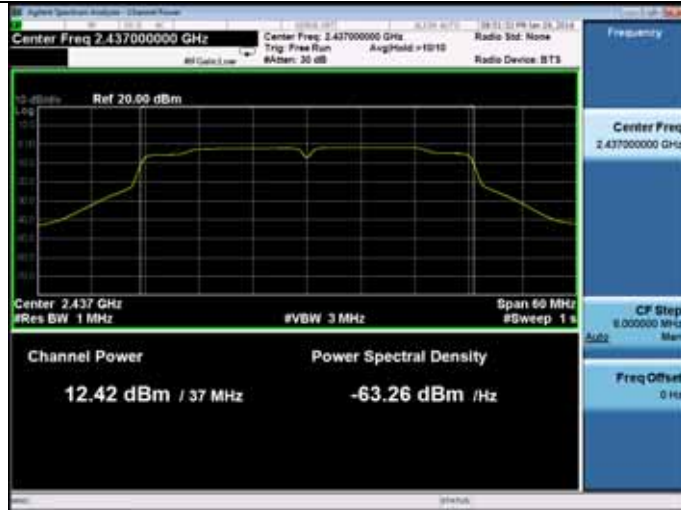

Test CH6: 2437MHz



Test CH9: 2452MHz

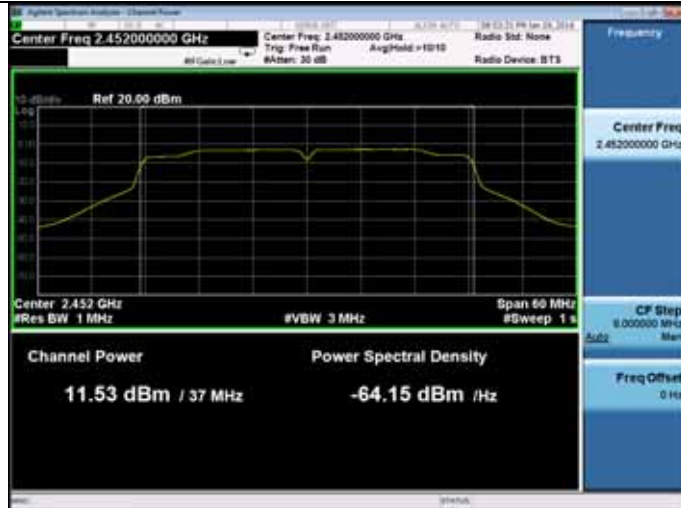

Test CH9: 2452MHz



9. POWER SPECTRAL DENSITY TEST

9.1. Test Equipment

Item	Equipment	Manufacturer	Model No.	Serial No.	Last Cal.	Cal. Interval
1.	Spectrum	Agilent	N9030A	MY51380221	Oct.17, 15	1Year
2.	Attenuator	Agilent	8491B	MY39262165	Apr.28, 15	1 Year
3	RF Cable	Hubersuhner	SUCOFLEX102	28610/2	Apr.28, 15	1 Year

9.2. Limit

For digitally modulated systems, the power spectral density conducted from the intentional radiator to the antenna shall not be greater than 8dBm in any 3kHz band during any time interval of continuous transmission.

9.3. Test Procedure

1. Connected the EUT's antenna port to spectrum analyzer device by 20dB attenuator.
2. Set span to 1.5 times the DTS Bandwidth.
3. Set the RBW=3KHz, VBW=10KHz.
4. Detector=peak, Sweep time=Auto, Trace mode=max Hold
5. All the trace to fully stabilize.
6. Use the peak marker function to determine the maximum amplitude level with in the RBW.

Note: The cable loss and attenuator loss were offset into measure device as an amplitude

9.4. Test Results

EUT: Notebook					
M/N: RZ09-0184					
Test date: 2016-01-12		Pressure: 102.8±1.0 kpa		Humidity: 51.9±3.0%	
Tested by: Alice-Yang		Test site: RF site		Temperature: 22.7±0.6 °C	
Test Mode	CH	Power Density (dBm/3KHz)			Limit (dBm/3KHz)
		ANT 1	ANT 2	Total	
11b	CH1	-9.253	-9.382	N/A	8
	CH6	-9.070	-9.541	N/A	8
	CH11	-9.104	-9.343	N/A	8
11g	CH1	-8.939	-8.446	N/A	8
	CH6	-8.561	-9.576	N/A	8
	CH11	-9.274	-8.133	N/A	8
11n HT20	CH1	-11.105	-12.063	-8.55	8
	CH6	-11.239	-12.314	-8.73	8
	CH11	-10.264	-11.535	-7.84	8
11n HT40	CH3	-14.648	-14.864	-11.74	8
	CH6	-14.680	-15.674	-12.14	8
	CH9	-15.965	-15.847	-12.90	8
Conclusion: PASS					

Note: For 11n mode, the direction gain less than 6dBi.

ANT1:

Test Mode: IEEE 802.11b
Test CH1: 2412MHz



Test Mode: IEEE 802.11g
Test CH1: 2412MHz

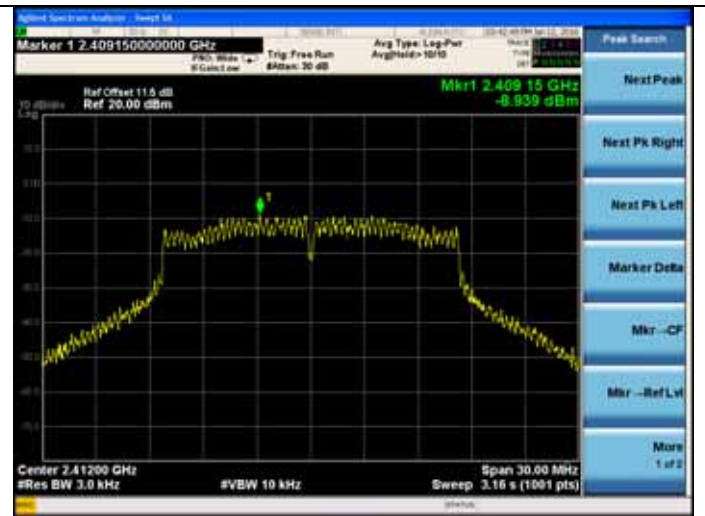

Test CH6: 2437MHz



Test CH6: 2437MHz

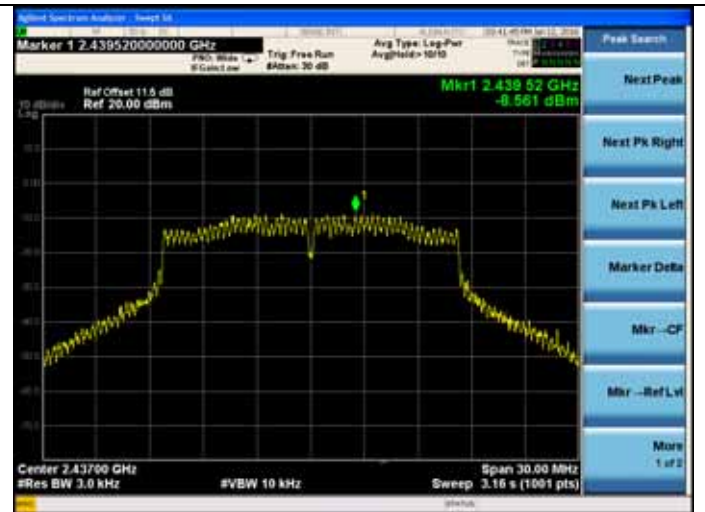

Test CH11: 2462MHz



Test CH11: 2462MHz

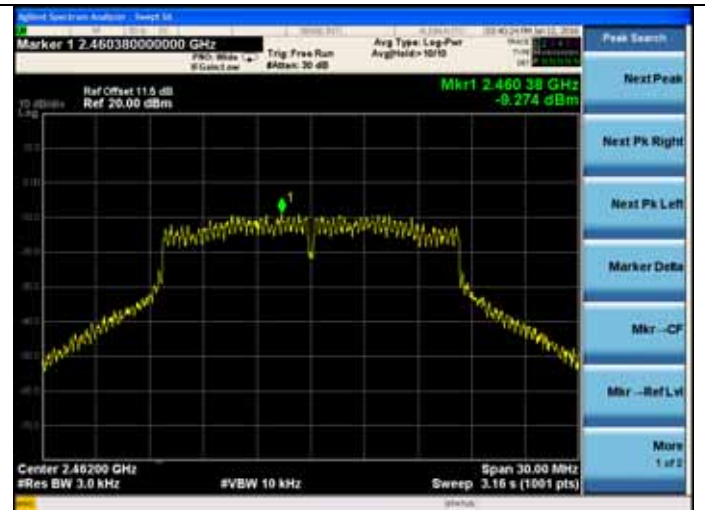

Test Mode: IEEE 802.11n HT20
Test CH1: 2412MHz

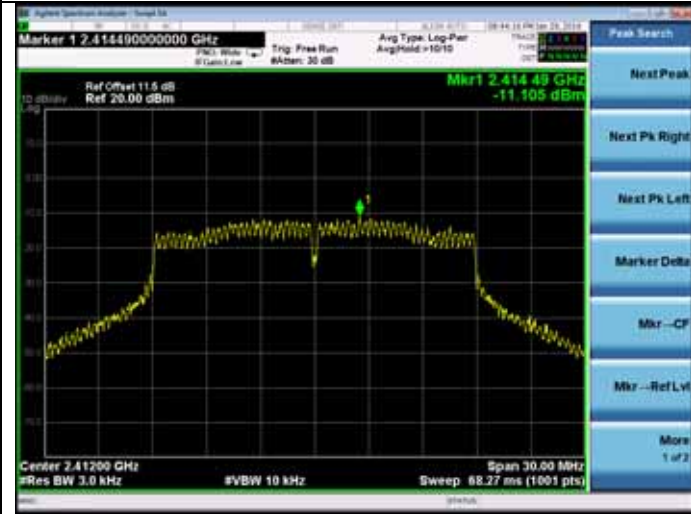

Test Mode: IEEE 802.11n HT40
Test CH3: 2422MHz



Test CH6: 2437MHz

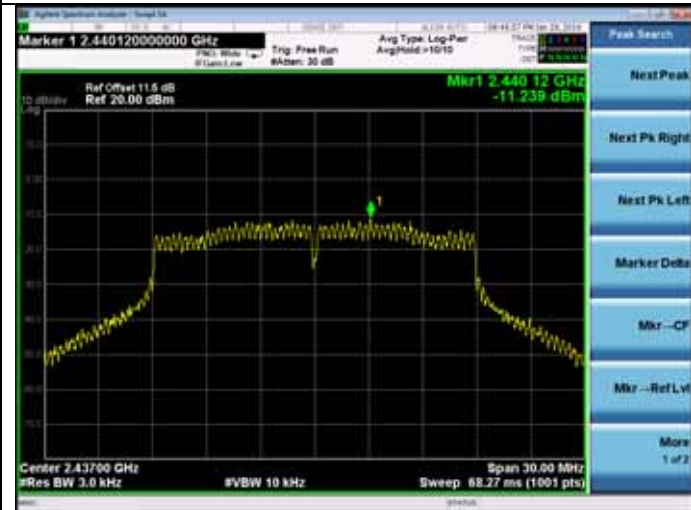

Test CH6: 2437MHz

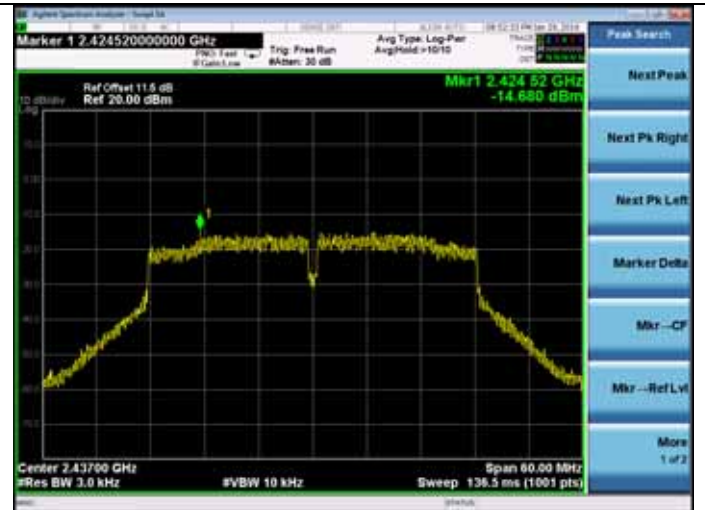

Test CH11: 2462MHz

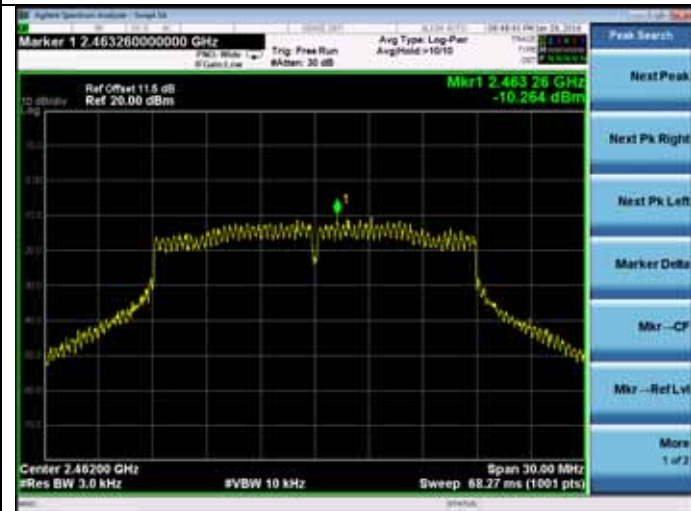

Test CH9: 2452MHz

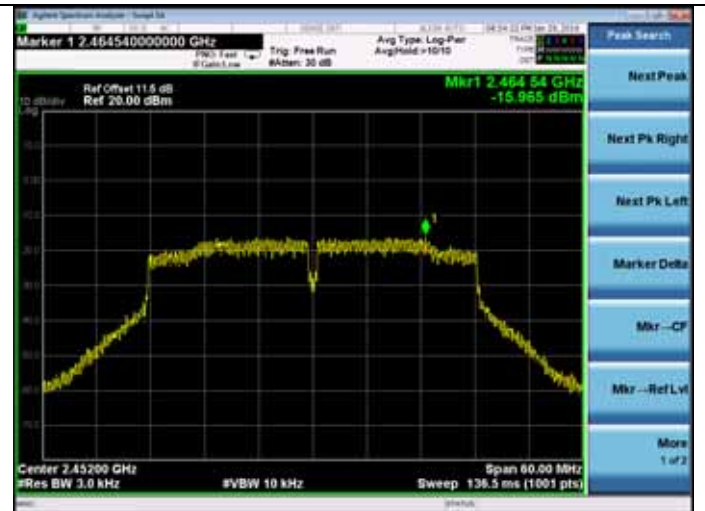

ANT2:

Test Mode: IEEE 802.11b
Test CH1: 2412MHz



Test Mode: IEEE 802.11g
Test CH1: 2412MHz



Test CH6: 2437MHz



Test CH6: 2437MHz

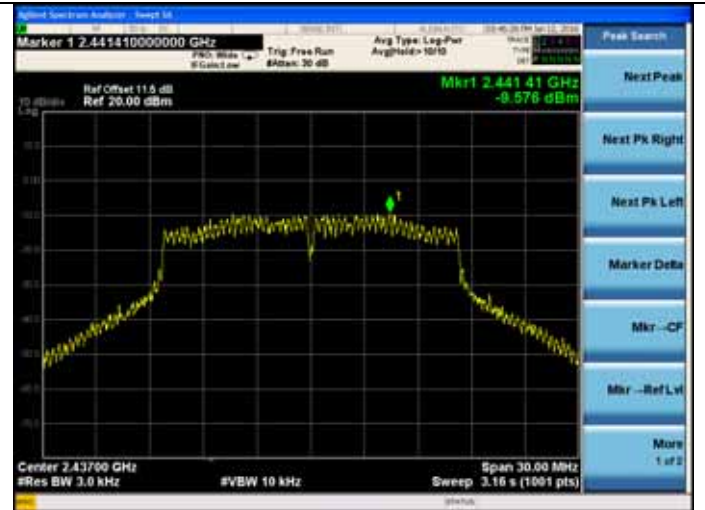

Test CH11: 2462MHz



Test CH11: 2462MHz

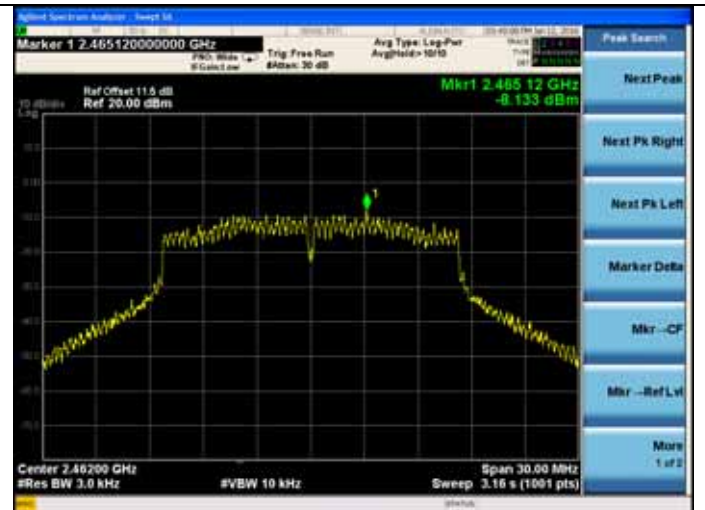

Test Mode: IEEE 802.11n HT20
Test CH1: 2412MHz



Test Mode: IEEE 802.11n HT40
Test CH3: 2422MHz



Test CH6: 2437MHz

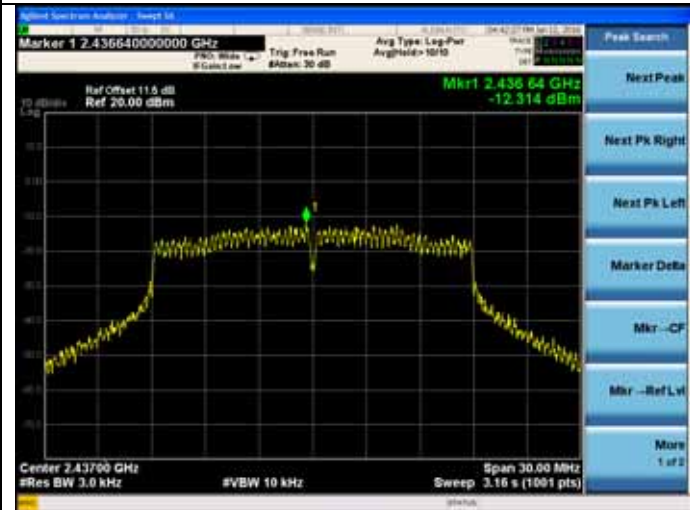

Test CH6: 2437MHz

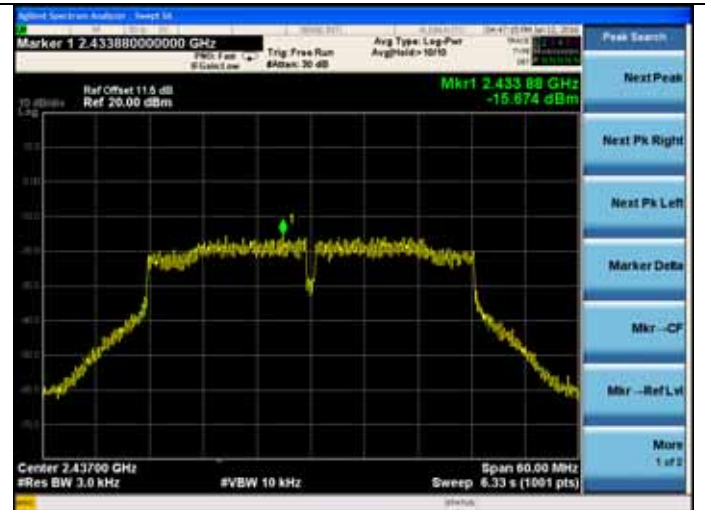

Test CH11: 2462MHz

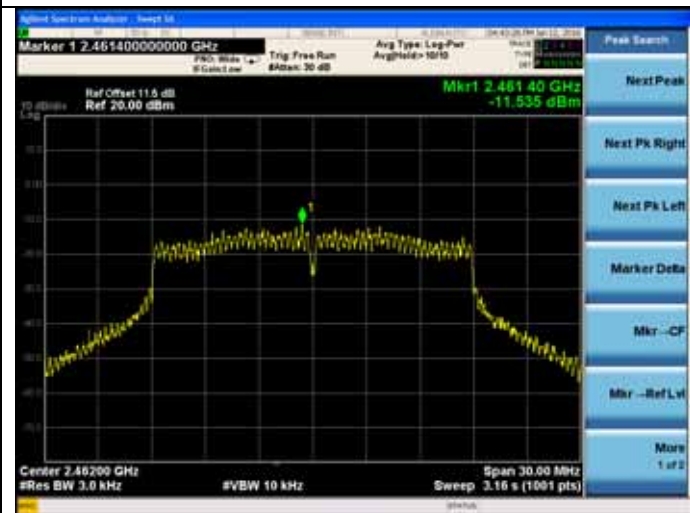

Test CH9: 2452MHz

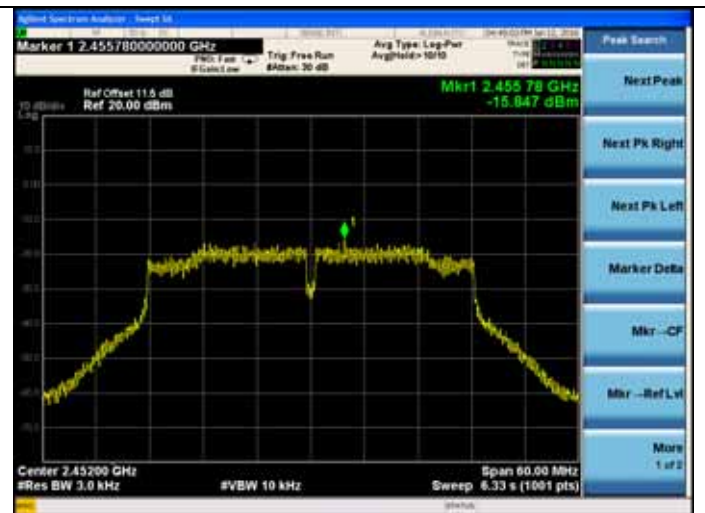

10. ANTENNA REQUIREMENT

10.1. Standard Applicable

For intentional device, according to FCC 47 CFR Section 15.203, an intentional radiator shall be designed to ensure that no antenna other than that furnished by the responsible party shall be used with the device. And according to FCC 47 CFR Section 15.247 (b), if transmitting antennas of directional gain greater than 6dBi are used, the power shall be reduced by the amount in dB that the directional gain of the antenna exceeds 6dBi.

10.2. Antenna Connected Construction

The antennas used for this product are PIFA antenna that no antenna other than that furnished by the responsible party shall be used with the device, the maximum peak gain of the transmit antenna is 2.8dBi.

11.DEVIATION TO TEST SPECIFICATIONS

[NONE]