

FCC Dynamic Frequency Selection Test Report

for

Razer Inc.

Notebook

Model No.: RZ09-0168

FCC ID: RWO-RZ090168

Prepared for : Razer Inc.

9 Pasteur, Suite 100 Irvine, California 92618, United States

Prepared By : Audix Technology (Shenzhen) Co., Ltd.

No. 6, Ke Feng Rd., 52 Block,
Shenzhen Science & Industrial Park,
Nantou, Shenzhen, Guangdong, China

Tel: (0755) 26639496

Report Number : ACS-F15263

Date of Test : Sep.02~06, 2015

Date of Report ; Sep.24, 2015

TABLE OF CONTENTS

<u>Description</u>	<u>Page</u>
TEST REPORT VERIFICATION.....	3
1.SUMMARY OF MEASUREMENTS AND RESULTS	4
2.GENERAL INFORMATION.....	5
2.1.Description of Device (EUT).....	5
2.2.Support Equipment.....	7
2.3.Test Channel.....	7
2.4.Description of Test Facility.....	8
2.5.Measurement Uncertainty	8
3.TEST EQUIPMENT.....	9
4.WORKING MODES AND REQUIREMENT TEST ITEM.....	10
4.1.Applicability of DFS Requirements Prior To Use A Channel	10
4.2.Applicability of DFS Requirements During Normal Operation.....	10
5.DFS DETECTION THRESHOLOLOS AND RADAR TEST WAVEFORMS	11
5.1.Interference Threshold Value, Master or Client Incorporating In-Service Monitoring	11
5.2.Radar Test Waveform Minimum Step	11
5.3.Short Pulse Radar Test Waveforms.....	12
5.4.Long Pulse Radar Test Waveforms.....	13
5.5.Frequency Hopping Pulse Radar Test Waveforms	15
5.6.Conducted Calibration Setup	17
5.7.Radar Waveform Calibration Procedure	17
5.8.Calibration Deviation	17
5.9.Radar Waveform Calibration Result	18
6.TEST SETUP AND TEST RESULT.....	21
6.1.Test Setup.....	21
6.2.Channel Move Time, Channel Closing Transmission Time Measurement.....	25
7.HOTOGRAPHS OF MEASUREMENT	35
8.PHOTOGRAPH OF EUT.....	36

TEST REPORT VERIFICATION

Applicant : Razer Inc.
Manufacturer : Razer Inc.
FCC ID : RWO-RZ090168
EUT Description : Notebook
(A) Model : RZ09-0168
(B) Power Supply : DC 20V
(C) Test Voltage : DC 20V From Adapter Input AC 120V/60Hz

Measurement Standards Used:

FCC RULES AND REGULATIONS PART 15 Subpart E, Oct. 2014
(FCC CFR 47 Part 15E, §15.407)

The device described above was tested by Audix Technology (Shenzhen) Co., Ltd. to determine the maximum emission levels emanating from the device. The maximum emission levels were compared to the FCC Part 15 subpart E limits.

The measurement results are contained in this test report and Audix Technology (Shenzhen) Co., Ltd. is assumed full responsibility for the accuracy and completeness of these measurements. Also, this report shows that the EUT to be technically compliant with the requirements of FCC Part 15E standards.

This report applies to above tested sample only. This report shall not be reproduced in part without written approval of Audix Technology (Shenzhen) Co., Ltd.

Date of Test : Sep.02~06, 2015 Report of date: Sep.24, 2015

Prepared by : Kayli He Reviewed by : [Signature]
Kayli He / Assistant Sunny Lu / Assistant Manager



Approved & Authorized Signer : Signature: David Jin
David Jin / Manager

1. SUMMARY OF MEASUREMENTS AND RESULTS

The EUT has been tested according to the applicable standards as referenced below.

Description of Test Item	Results
Channel Availability Check Time	N/A
Channel Move Time	PASS
Non-Occupancy Period	N/A
Channel Closing Transmission Time	PASS
U-NII Detection Bandwidth	N/A

N/A is an abbreviation for Not Applicable, sine the product is client without radar detection function

2. GENERAL INFORMATION

2.1. Description of Device (EUT)

Product Name	: Notebook
Model Number	: RZ09-0168
FCC ID	: RWO-RZ090168
Radio	: IEEE802.11 a/b/g/n/ac; Bluetooth V3.0+EDR; Bluetooth V4.1
Operation Frequency	: IEEE 802.11a: 5180MHz—5240MHz; 5260MHz—5320MHz 5500MHz—5700MHz; 5745MHz—5825MHz IEEE 802.11ac VHT20: 5180MHz—5240MHz; 5260MHz—5320MHz 5500MHz—5700MHz; 5745MHz—5825MHz IEEE 802.11ac VHT40: 5190MHz—5230MHz; 5270MHz—5310MHz 5510MHz—5670MHz; 5755MHz—5795MHz IEEE 802.11ac VHT80: 5210MHz, 5290MHz; 5530MHz; 5775MHz IEEE 802.11b: 2412MHz—2462MHz IEEE 802.11g: 2412MHz—2462MHz IEEE802.11nHT20: 2412MHz—2462MHz; 5180MHz—5240MHz; 5260MHz—5320MHz 5500MHz—5700MHz; 5745MHz—5825MHz IEEE802.11nHT40: 2422MHz—2452MHz; 5190MHz—5230MHz; 5270MHz—5310MHz 5510MHz—5670MHz; 5755MHz—5795MHz Bluetooth : 2402-2480MHz
Modulation Technology	: IEEE 802.11b: DSSS(CCK,DQPSK,DBPSK) IEEE 802.11a/g: OFDM(64QAM, 16QAM, QPSK, BPSK) IEEE 802.11ac VHT20, VHT40, VHT80: OFDM(16QAM, 64QAM, 256QAM, QPSK, BPSK) IEEE 802.11n HT20, HT40: OFDM (64QAM, 16QAM,QPSK,BPSK) Bluetooth V3.0+EDR: GFSK, $\pi/4$ DQPSK,8-DPSK Bluetooth V4.1:GFSK

Antenna Assembly : Antenna Type: PIFA
Gain Bluetooth: 2.84dBi
WIFI 2.4GHz:ANT 0: 2.84dBi; ANT 1: 2.37dBi
U-NII 5180-5240MHz Band: ANT 0: -0.18dBi; ANT 1: -0.78dBi
U-NII 5260-5320MHz Band: ANT 0: 0.32dBi; ANT 1: -0.08dBi
U-NII 5500-5700MHz Band: ANT 0: 3.52dBi; ANT 1: 3.07dBi
U-NII 5745-5825MHz Band: ANT 0: 3.48dBi; ANT 1: 3.18dBi

Applicant : Razer Inc.
9 Pasteur, Suite 100 Irvine, California 92618, United States

Manufacturer : Razer Inc.
9 Pasteur, Suite 100 Irvine, California 92618, United States

Factory : BYD Precision Manufacture Co., Ltd
No.3001, Baohe Road, Baolong Industrial, Longgang,
Shenzhen, 518116, P.R., China

Power Adapter : Manufacturer: Razer Inc. M/N: RC30-0168
Input: 100-240 Vac,50/60Hz, 2.0A
Output: 20V,2.25A

Date of Test : Sep.02~06, 2015

Date of Receipt : Aug.17, 2015

2.2. Support Equipment

Item	Manufacturer	Model	Remark
AP Server	CISCO	AIR-AP1262N-A-K9	FCC ID: LDK102073 IC:2461B-102073
AP Server	D-Link	DIR-815A1	NCC ID: CCA110LP092AT0 FCC ID: KA2IR815A1 IC: 4216A-IR815A1
AP Server	NEC	PA-WR8750N-HP	

2.3. Test Channel

Frequency Band	Channel No.	Frequency
5260-5320MHz (UNII Band II)	20MHz	
	60	5300MHz
	40MHz	
	60	5300MHz
	80MHz	
	58	5290MHz
5500-5700MHz (UNII Band III)	20MHz	
	100	5500MHz
	40MHz	
	108	5540MHz
	80MHz	
	106	5530MHz

2.4. Description of Test Facility

Site Description

Name of Firm : Audix Technology (Shenzhen) Co., Ltd.
No. 6, Ke Feng Rd., 52 Block, Shenzhen
Science & Industrial Park, Nantou, Shenzhen,
Guangdong, China

3m Anechoic Chamber : Certificated by FCC, USA
Registration Number: 90454
Valid Date: Dec.30, 2017

3m & 10m Anechoic Chamber : Certificated by FCC, USA
Registration Number: 794232
Valid Date: Jul.12, 2017

EMC Lab. : Certificated by DAkkS, Germany
Registration No: D-PL-12151-01-00
Valid Date: Dec.15, 2016

Accredited by NVLAP, USA
NVLAP Code: 200372-0
Valid Date: Mar.31, 2016

2.5. Measurement Uncertainty

Test Item	Uncertainty
DFS Measurement	$\pm 0.5\text{ms}$
Threshold	$\pm 0.33\text{dB}$

3. TEST EQUIPMENT

Item	Equipment	Manufacturer	Model No.	Serial No.	Last Cal.	Cal. Interval
1	Vector Signal Generation	R&S	SMU200A	105064	Oct.29,14	1 Year
2	Spectrum Analyzer	R&S	FSV7	102493	Oct.29,14	1 Year
3	Attenuator (10dB)	Marvelous	MVE2213-10	NO.1	NCR	NCR
4	Attenuator (30 dB)	Marvelous	MVE2213-30	NO.1	NCR	NCR
5	Attenuator (10dB)	Marvelous	MVE2213-10	NO.2	NCR	NCR
6	Attenuator (30 dB)	Marvelous	MVE2213-30	NO.2	NCR	NCR
7	Power Splitter	Marvelous	MVE8576	NO.1	NCR	NCR
8	Power Splitter	Marvelous	MVE8576	NO.2	NCR	NCR

4. WORKING MODES AND REQUIREMENT TEST ITEM

4.1. Applicability of DFS Requirements Prior To Use A Channel

Requirement	Operational Mode		
	Master	Client without radar detection	Client with radar detection
Non-Occupancy Period	✓	Not required	✓
DFS Detection Threshold	✓	Not required	✓
Channel Availability Check Time	✓	Not required	Not required
Uniform Spreading	✓	Not required	Not required
U-NII Detection Bandwidth	✓	Not required	✓

4.2. Applicability of DFS Requirements During Normal Operation

Requirement	Operational Mode		
	Master	Client without radar detection	Client with radar detection
DFS Detection Threshold	✓	Not required	✓
Channel Closing Transmission Time	✓	✓	✓
Channel Move Time	✓	✓	✓
U-NII Detection Bandwidth	✓	Not required	✓

5. DFS DETECTION THRESHOLOS AND RADAR TEST

WAVEFORMS

5.1. Interference Threshold Value, Master or Client Incorporating In-Service Monitoring

Maximum Transmit Power	Value (See Notes 1 and 2)
≥ 200 milliwatt	-64dBm
< 200 milliwatt	-62dBm

Note 1: This is the level at the input of the receiver assuming a 0 dBi receive antenna.

Note 2: Throughout these test procedures an additional 1 dB has been added to the amplitude of the test transmission waveforms to account for variations in measurement equipment. This will ensure that the test signal is at or above the detection threshold level to trigger a DFS response.

The radar Detection Threshold, lowest antenna gain is the parameter of interference radar DFS detection threshold.

5.2. Radar Test Waveform Minimum Step

Step intervals of 0.1 microsecond for Pulse Width, 1 microsecond for PRI, 1MHz for chirp width and 1 for the number of pulses will be utilized for the random determination of specific test waveforms.

5.3. Short Pulse Radar Test Waveforms

Radar Type	Pulse Width (μsec)	PRI (μsec)	Number of Pulse	Minimum Percentage of Successful Detection	Minimum number of Trials
1	1	1428	18	60%	30
2	1-5	150-230	23-29	60%	30
3	6-10	200-500	16-18	60%	30
4	11-20	200-500	12-16	60%	30
Aggregate (Radar Types 1-4)				80%	120

A minimum of 30 unique waveforms are required for each of the short pulse radar type 2 through 4. For short pulse radar type 1, the same waveform is used a minimum of 30 times. If more than 30 waveforms are used for short pulse radar types 2 through 4, then each additional waveform must also be unique and not repeated from the previous waveforms. The aggregate is the average of the percentage of successful detections of short pulse radar types 1-4.

FCC Radar Types (1~4) System Diagram

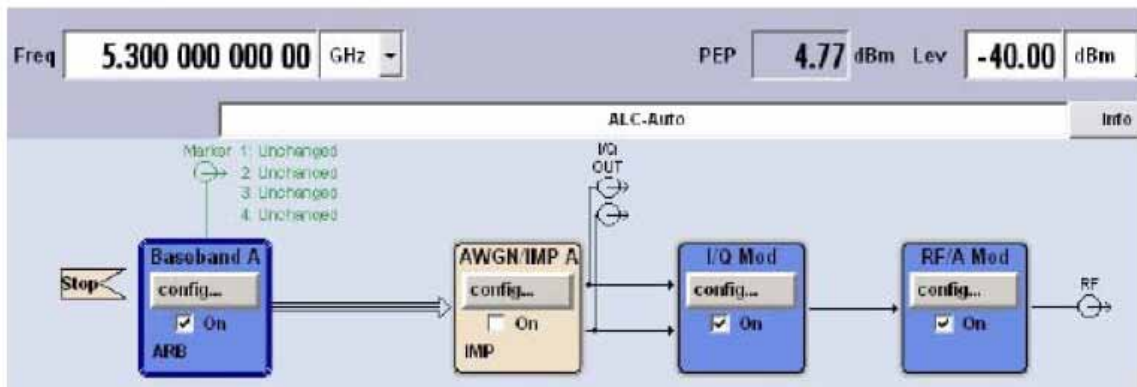

Used R&S SMU200A (Vector SG with two ARB)

B11: Base-band Generator with ARB (16M samples) and Digital Modulation

B13: Base-band Main Module

B106: frequency range (100 kHz to 6 GHz)

For selecting the waveform parameters from within the bounds of the signal type, system was random selection using uniform distribution.

5.4. Long Pulse Radar Test Waveforms

Radar Type	Pulse Width (μsec)	Chirp Width (MHz)	PRI (μsec)	Number of Pulse Per Burst	Number of Bursts	Minimum Percentage of Successful Detection	Minimum of Trials
5	50-100	5-20	1000-2000	1-3	8-20	80%	30

The parameters for this waveform are randomly chosen. Thirty unique waveforms are required for the Long Pulse radar test signal. If more 30 waveforms are used for the Long Pulse radar test signal, then each additional waveform must also be unique and not repeated from the previous waveforms. Each waveform is defined as following:

- (1) The transmission period for the Long Pulse Radar test signal is 12 seconds.
- (2) There are a total of 8 to 20 Bursts in the 12 second period, with the number of Bursts being randomly chosen. This number is Burst_Count.
- (3) Each Burst consists of 1 to 3 pulses, with the number of pulses being randomly chosen. Each Burst within the 12 second sequence may have a different number of pulses.
- (4) The pulse width is between 50 and 100 microseconds, with the pulse width being randomly chosen. Each pulse within a Burst will have the same pulse width. Pulses in different Bursts may have different pulse widths.
- (5) Each pulse has a linear FM chirp between 5 and 20MHz, with the chirp width being randomly chosen. Each pulse within a Burst will have the same chirp width. Pulses in different Burst may have different chirp widths. The chirp is centered on the pulse. For example, with a radar frequency of 5300MHz and a 20MHz chirped signal, the chirp starts at 5290MHz and ends at 5310MHz.

- (6) If more than one pulse is present in a Burst, the time between the pulses will be between 1000 and 2000 microseconds, with the time being randomly chosen. If three pulses are present in a Burst, the time between the first and second pulses is chosen independently of the time between the second and third pulses.
- (7) The 12 second transmission period is divided into even intervals. The number of intervals is equal to Burst_Count. Each interval is of length $(12000000/\text{Burst_Count})$ microseconds. Each interval contains one Burst. The start time for the Burst, relative to the beginning of the interval, is between 1 and $[(12000000/\text{Burst_Count}) - (\text{Total Burst length}) + (\text{One Random PRI interval})]$ microseconds, with the start time being randomly chosen. The step interval for the start time is 1 microsecond. The start time for each Burst is chosen independently.

A representative example of a Long Pulse radar test waveform:

- (1) The total test signal length is 12 seconds.
- (2) 8 Bursts are randomly generated for the Burst_Count.
- (3) Burst 1 has 2 randomly generated pulses.
- (4) The pulse width (for both pulses) is randomly selected to be 75 microseconds.
- (5) The PRI is randomly selected to be at 1213 microseconds.
- (6) Bursts 2 through 8 are generated using steps 3-5.
- (7) Each Burst is contained in even intervals of 1500000 microseconds. The starting location for Pulse 1. Burst 1 is randomly generated (1 to 1500000 minus the total Burst 1 length + 1 random PRI interval) at the 325001 microsecond step. Bursts 2 through 8 randomly fall in successive 1500000 microsecond intervals (i.e. Burst 2 falls in the 1500001-3000000 microsecond range).

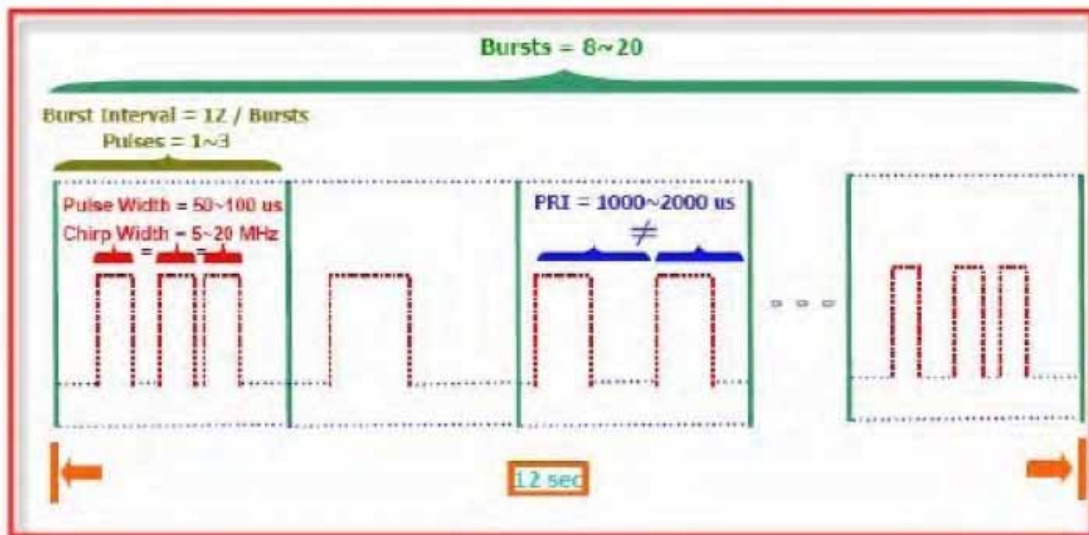

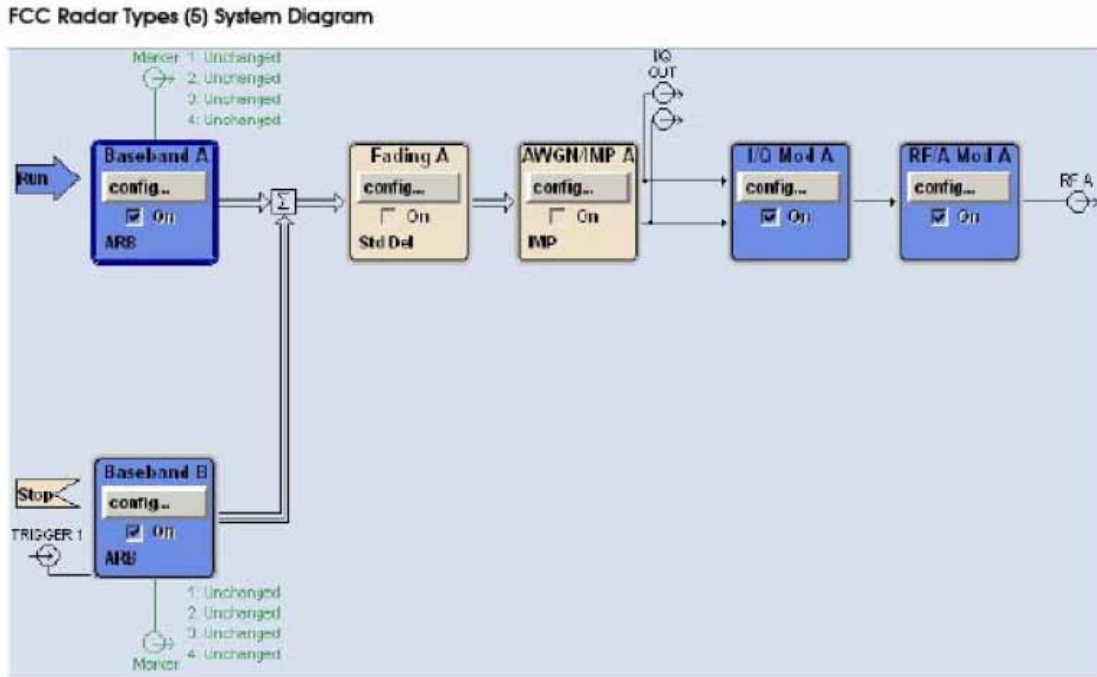

Used R&S SMU200A (Vector SG with two ARB)

Path A/Path B Two B11: Base-band Generator with ARB (16M samples) and Digital Modulation

B13: Base-band Main Module

B106: frequency range (100 kHz to 6 GHz)

For selecting the waveform parameters from within the bounds of the signal type, system was random selection using uniform distribution.

5.5. Frequency Hopping Pulse Radar Test Waveforms

Radar Type	Pulse Width (μsec)	PRI (μsec)	Pulses Per Hop	Hopping Rate (kHz)	Hopping Sequence Length (ms)	Minimum Percentage of Successful Detection	Minimum of Trials
6	1	333	9	0.333	300	70%	30

For the Frequency Hopping Radar Type, the same Burst parameters are used for each waveform. The hopping sequence is different for each waveform and a 100-length segment is selected from the hopping sequence defined by the following algorithm: The first frequency in a hopping sequence is selected randomly from the group of 475 integer frequencies from 5250-5274MHz. Next, the frequency that was just chosen is removed from the group and a frequency is randomly selected from the remaining 474 frequencies in the group. This process continues until all 475 frequencies are chosen for the set. For selection of random frequency, the frequencies remaining within the group are always treated as equally likely.

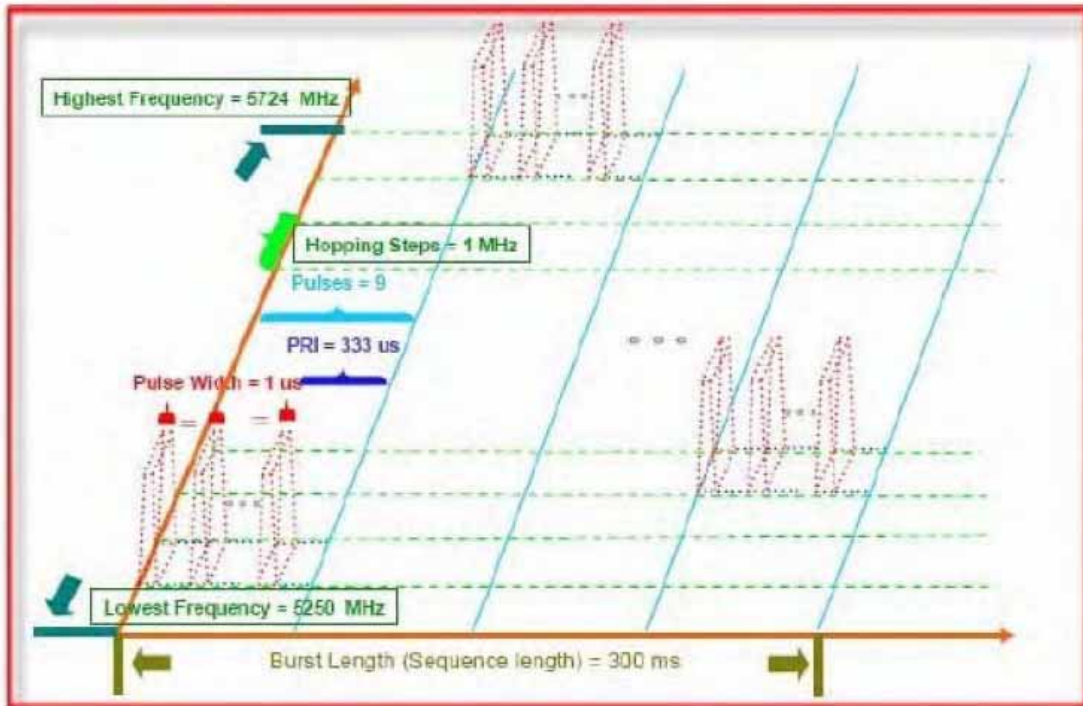

FCC Radar Types (6) System Diagram

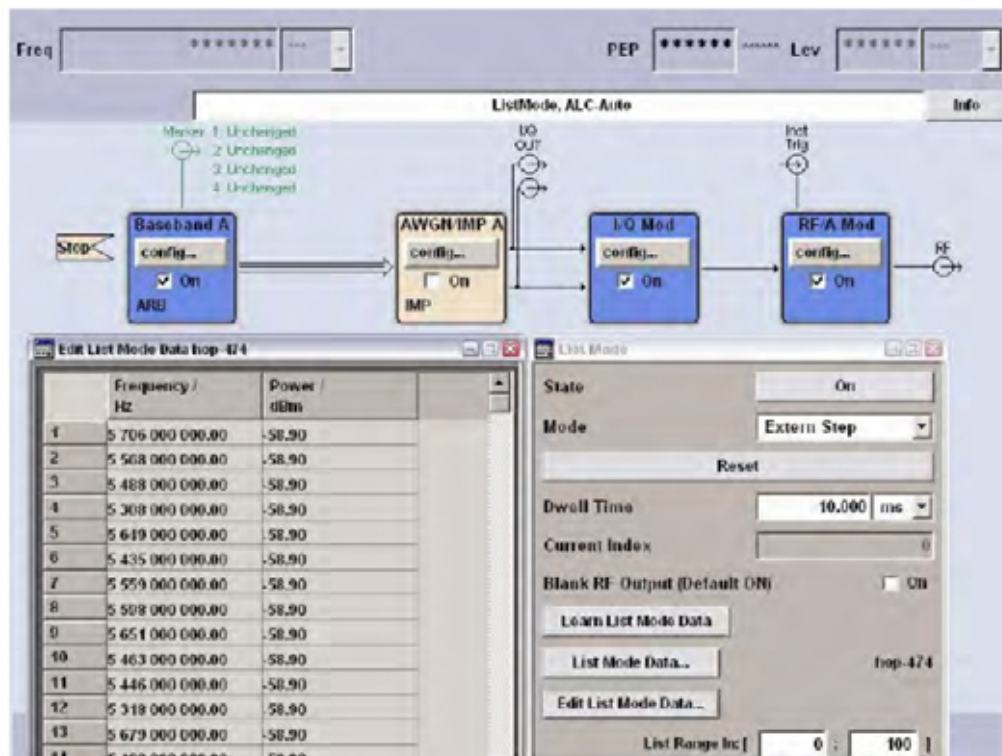

Used R&S SMU200A (Vector SG with two ARB)
 B11: Base-band Generator with ARB (16M samples) and Digital Modulation
 B13: Base-band Main Module
 B106: frequency range (100 kHz to 6 GHz)
 For selecting the waveform parameters from within the bounds of the signal type, system was random selection using uniform distribution.

5.6. Conducted Calibration Setup

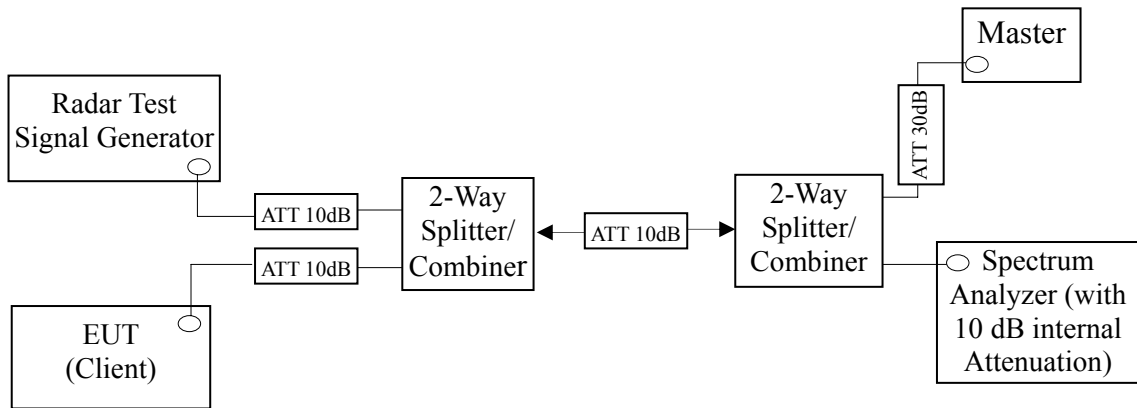

5.7. Radar Waveform Calibration Procedure

The measured frequency is 5300MHz & 5290MHz for Band II, 5500MHz & 5530MHz & 5540MHz for Band III. The radar signal was the same as transmitted channels, and injected into the antenna port of AP (master) or Client Device with Radar Detection, measured the channel closing transmission time and channel move time. The calibrated conducted detection threshold level is set to -62dBm. The tested level is lower than required level hence it provides margin to the limit.

5.8. Calibration Deviation

There is no deviation with the original standard.

5.9. Radar Waveform Calibration Result

DFS detection threshold level and the burst of pulses on the Channel frequency **Band II**
20MHz

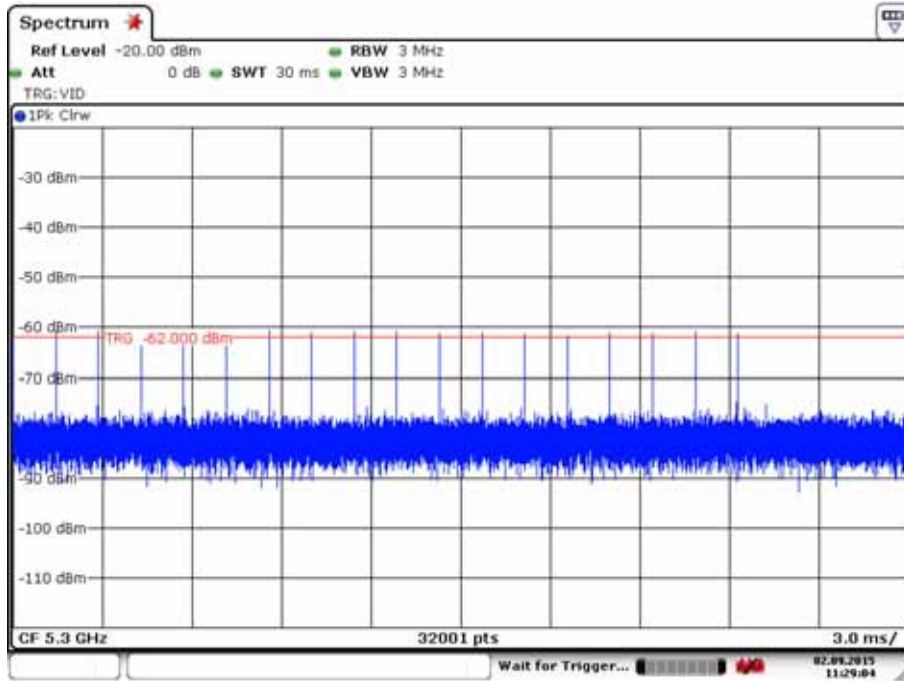

40MHz

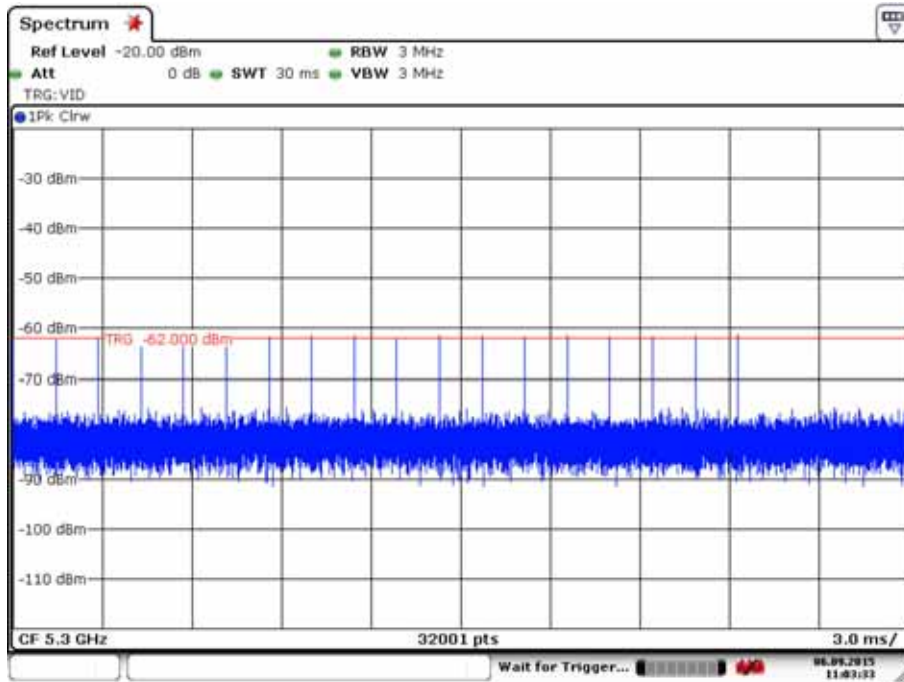

80MHz

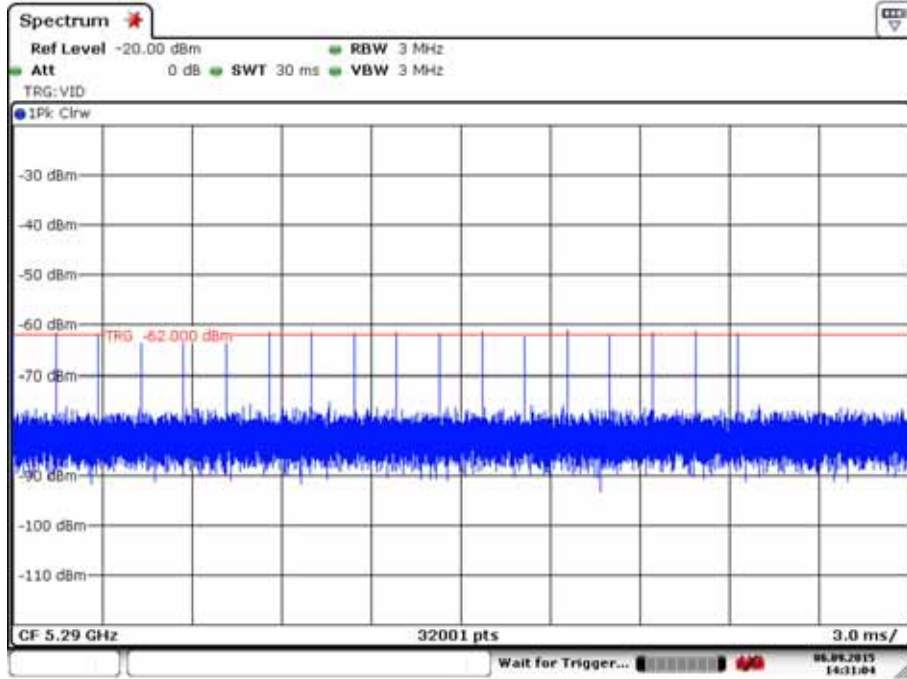

Date: 6.SEP.2015 14:31:04

Band III 20MHz

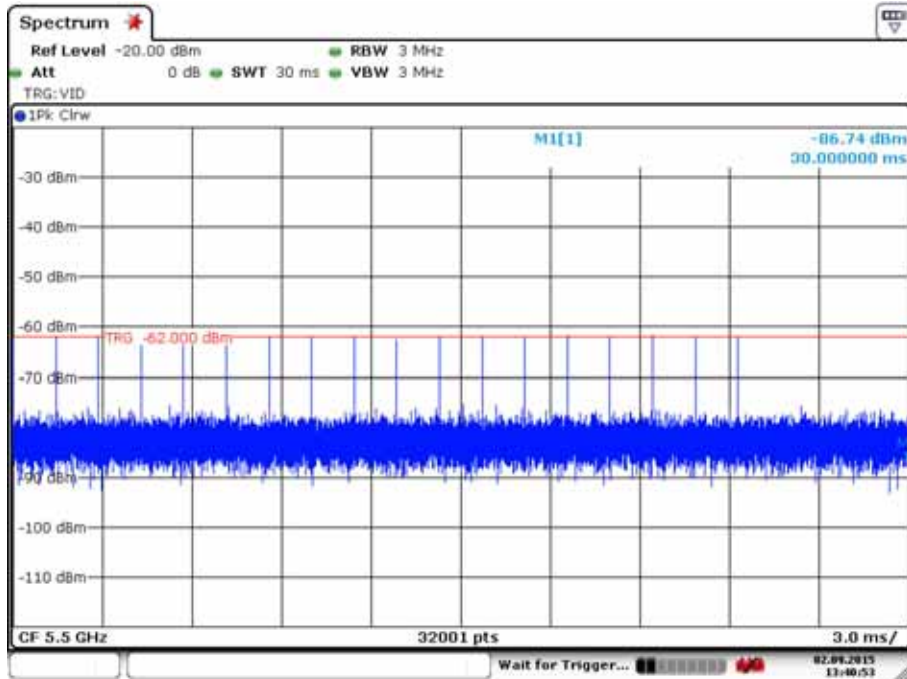

Date: 2.SEP.2015 13:40:53

40MHz

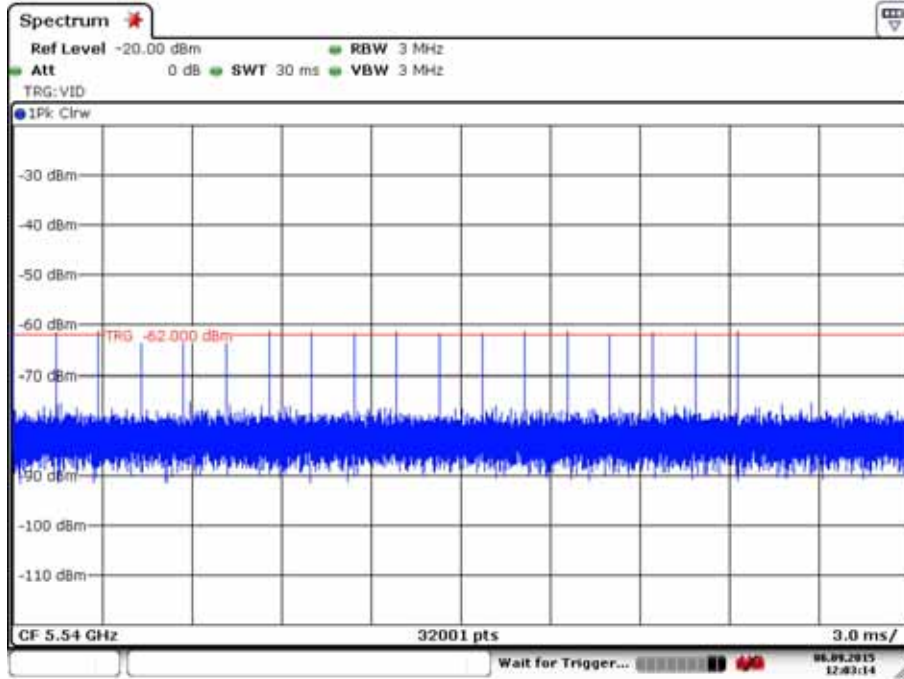

Date: 6.SEP.2015 12:03:14

80MHz

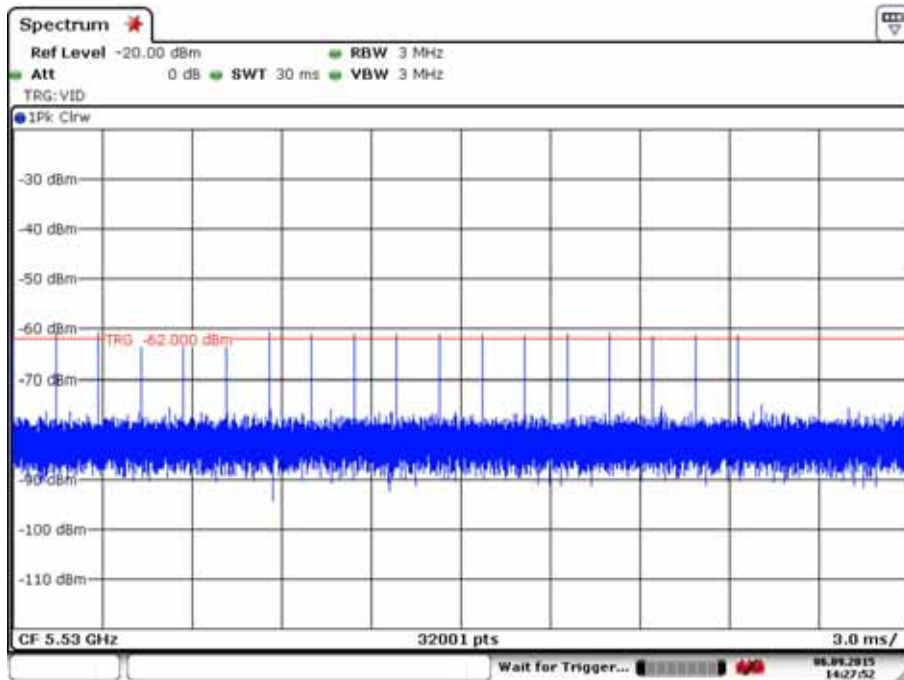

Date: 6.SEP.2015 14:27:52

6. TEST SETUP AND TEST RESULT

6.1. Test Setup

6.1.1. Test Setup Diagram

Following is the test setup for generated the radar waveforms and used to monitor UNII device.

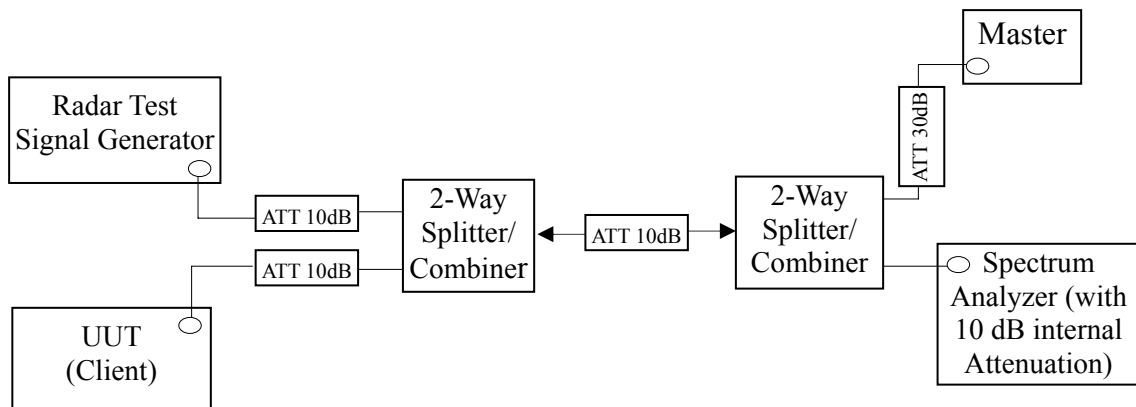

6.1.2. Test Setup Operation

System testing was performed with the designated test file that streams full motion video from the Access Point to Client in full motion video mode using the media player with the V2.61 Codec package. This file is used by IP and Frame based systems for loading the test channel during the in-service compliance testing of the U-NII device.

The waveform parameters from within the bounds of the signal type are selected randomly using uniform distribution.

A spectrum analyzer is used as a monitor to verify that the EUT has vacated the Channel within the (Channel Closing Transmission Time and Channel Move Time, and does not transmit on a Channel during the Non-Occupancy Period after the detection and Channel move. It is also used to monitor EUT transmissions during the Channel Availability Check Time.

6.1.3. Test Setup for Data Traffic Plot

Test Date: Sep.02~06, 2015 Temperature: 21°C

Humidity:56%

Band II 20MHz

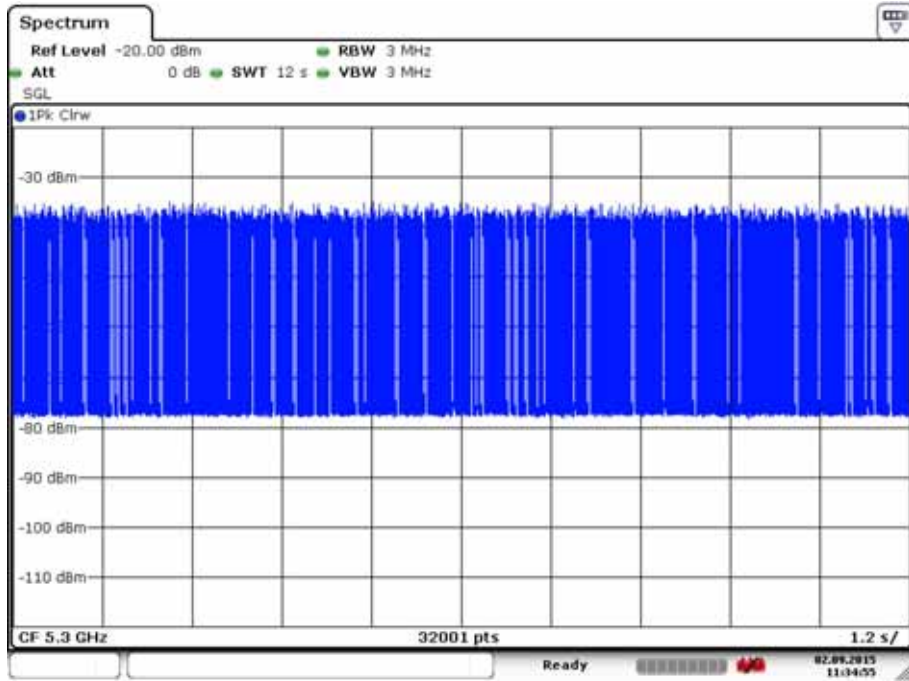

Date: 2.SEP.2015 11:34:35

40MHz

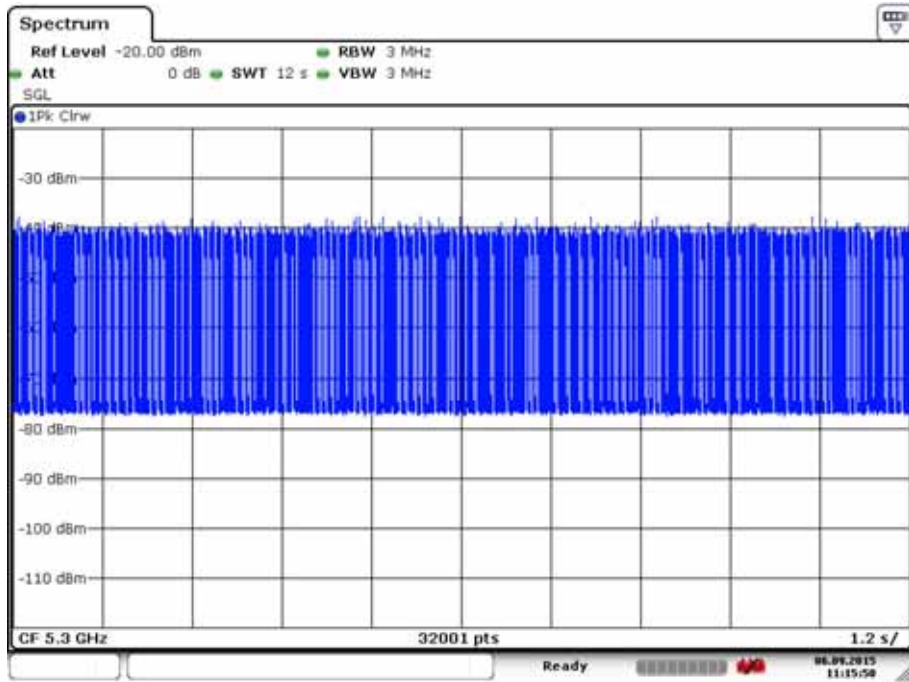

Date: 6.SEP.2015 11:15:51

80MHz

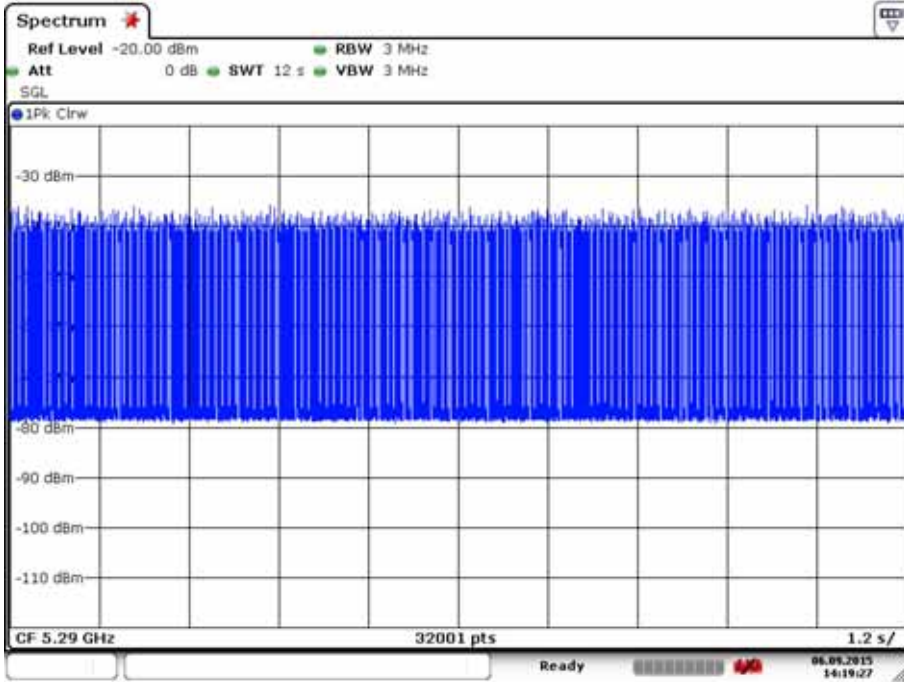

Date: 6.SEP.2015 14:19:27

Band III 20MHz

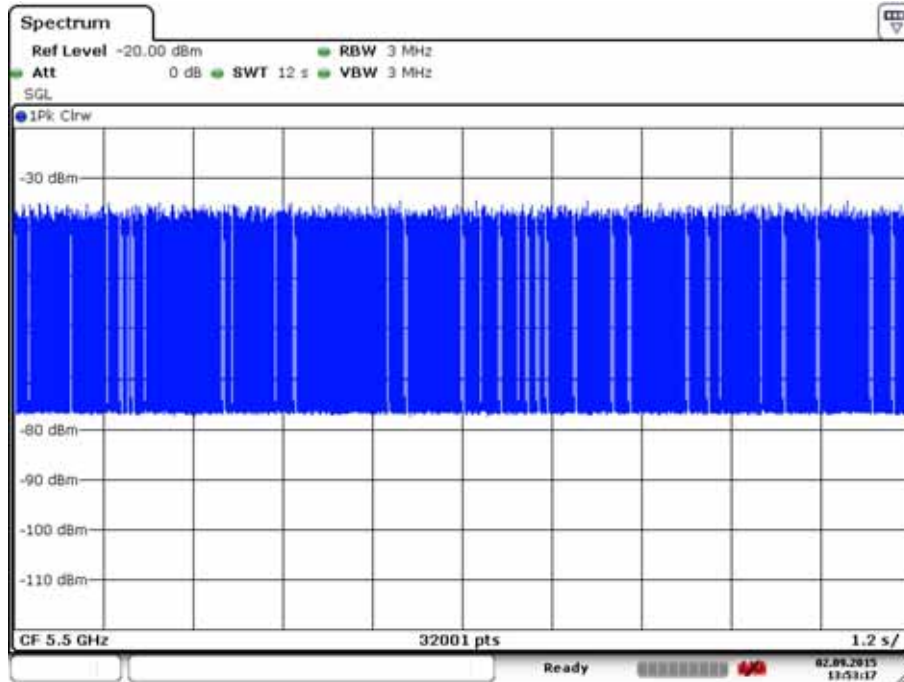

Date: 2.SEP.2015 13:53:17

40MHz

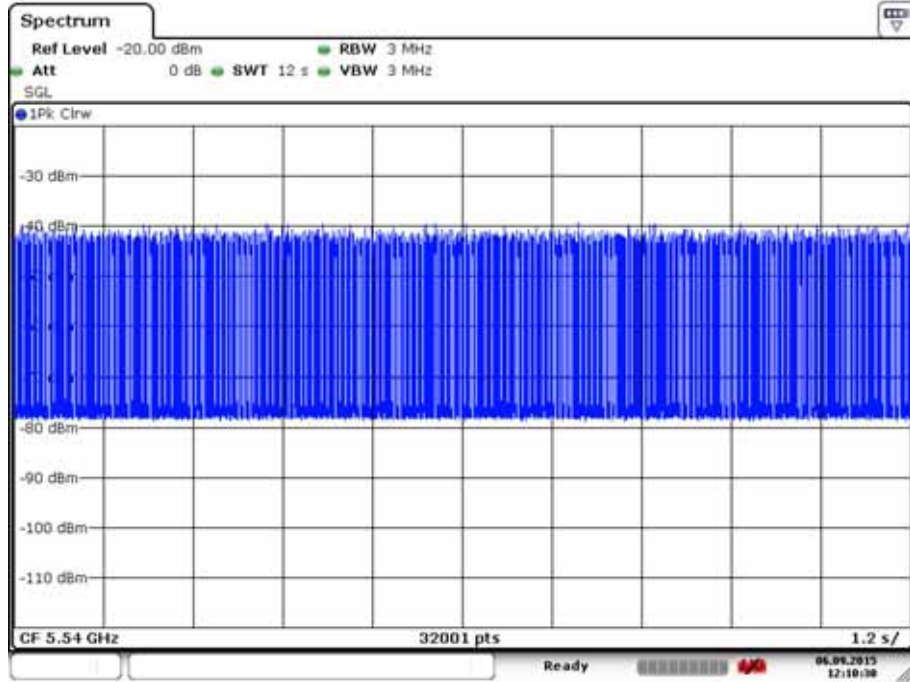

Date: 6,SEP,2015 12:10:30

80MHz

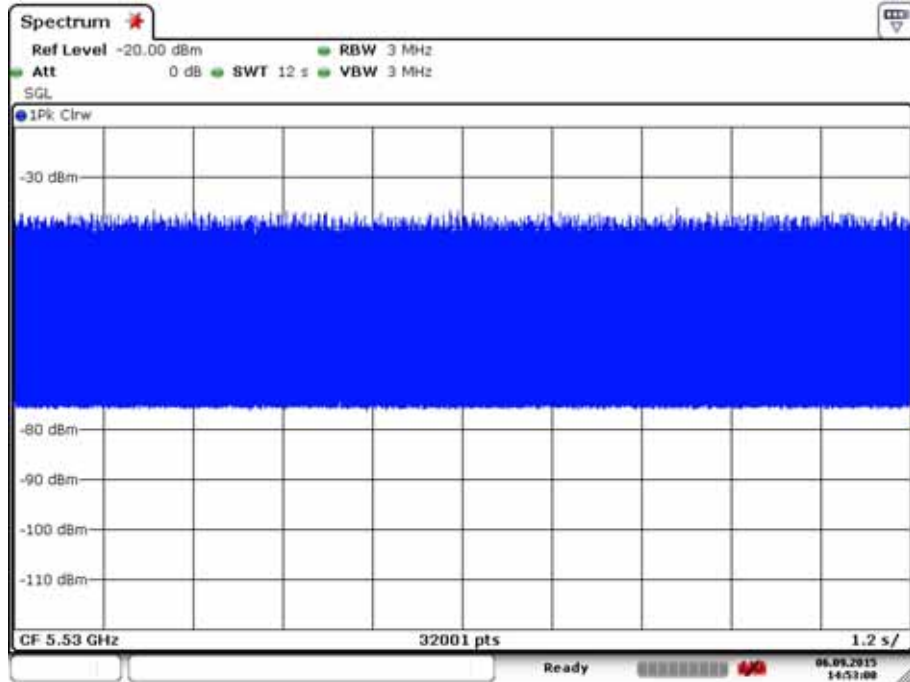

Date: 6,SEP,2015 14:53:00

6.2. Channel Move Time, Channel Closing Transmission Time Measurement

6.2.1. Limit

Parameter	Value
Channel Move Time	10 seconds See Note 1.
Channel Closing Transmission Time	200 milliseconds + an aggregate of 60 milliseconds over remaining 10 second period. See Notes 1 and 2.

Note 1: The instant that the Channel Move Time and the Channel Closing Transmission Time begins is as follows:

- a. For the Short Pulse Radar Test Signals this instant is the end of the Burst.
- b. For the Frequency Hopping radar Test Signal, this instant is the end of the last radar Burst generated.
- c. For the Long Pulse Radar Test Signal this instant is the end of the 12 second period defining the Radar Waveform.

Note 2: The Channel Closing Transmission Time is comprised of 200 milliseconds starting at the beginning of the Channel Move Time plus any additional intermittent control signals required to facilitate a Channel move (an aggregate of 60 milliseconds) during the remainder of the 10 second period. The aggregate duration of control signals will not count quiet periods in between transmissions.

6.2.2. Test Procedures

- 6.2.2.1. When a radar Burst with a level equal to the DFS Detection Threshold + 1dB is generated on the operating channel of the U-NII device. A U-NII device operating as a Client Device will associate with the Master of channel. Stream the MPEG test file from the Master Device to the Client Device on the selected channel for entire period of the test. At time to the radar waveform generator sends a Burst of pulses for each of the radar types at Detection Threshold + 1dB.
- 6.2.2.2. Observe the transmissions of the EUT at the end of the radar Burst on the Operating channel. Measure and record the transmissions from the EUT during the observation time [Channel Move Time]. One 10 Second plot be reported for the short Pulse Radar type 1-4 and one for the Long Pulse Radar Type test in a 22 second plot. The plot for the Short Pulse Radar types start at the end of the radar burst. The Channel Move Time will be calculated based on the plot of the short Pulse Radar Type. The Long Pulse Radar Type plot show the device ceased transmissions within the 10 second window after detection has occurred. The plot for the Long Pulse Radar type should start at the beginning of the 12 second waveform.

6.2.3. Test Result

Applicability of DFS Requirement During Normal Operation

6.2.3.1. Channel Closing Transmission Time & Channel Move Time (PASS)

Test Mode: UNII Band II, 20MHz

Test Date: Sep.02~06, 2015 Temperature: 21°C Humidity:56%

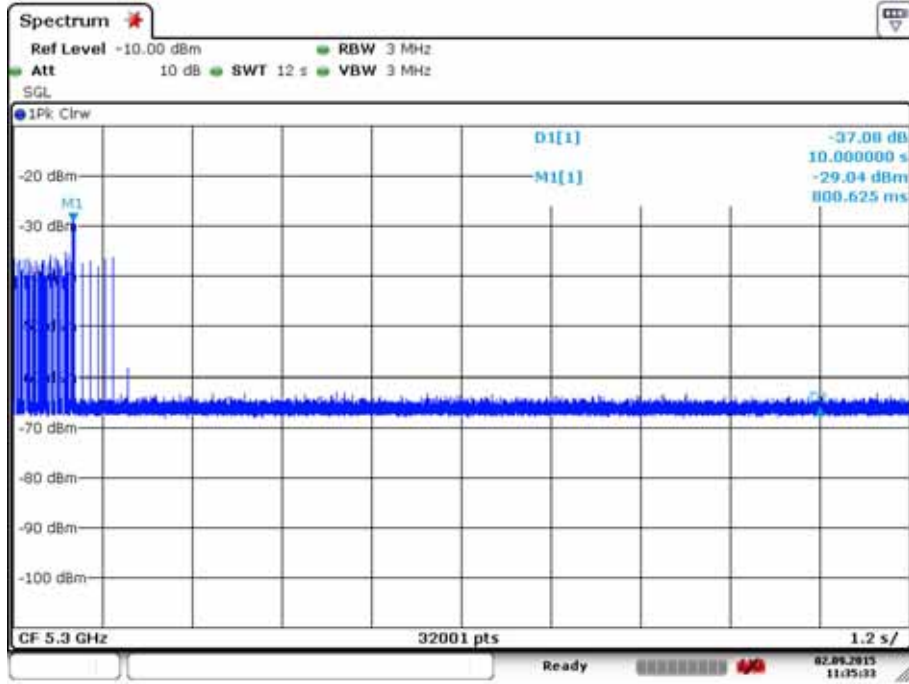

Date: 2.SEP.2015 11:35:32

Channel move time < 10 S

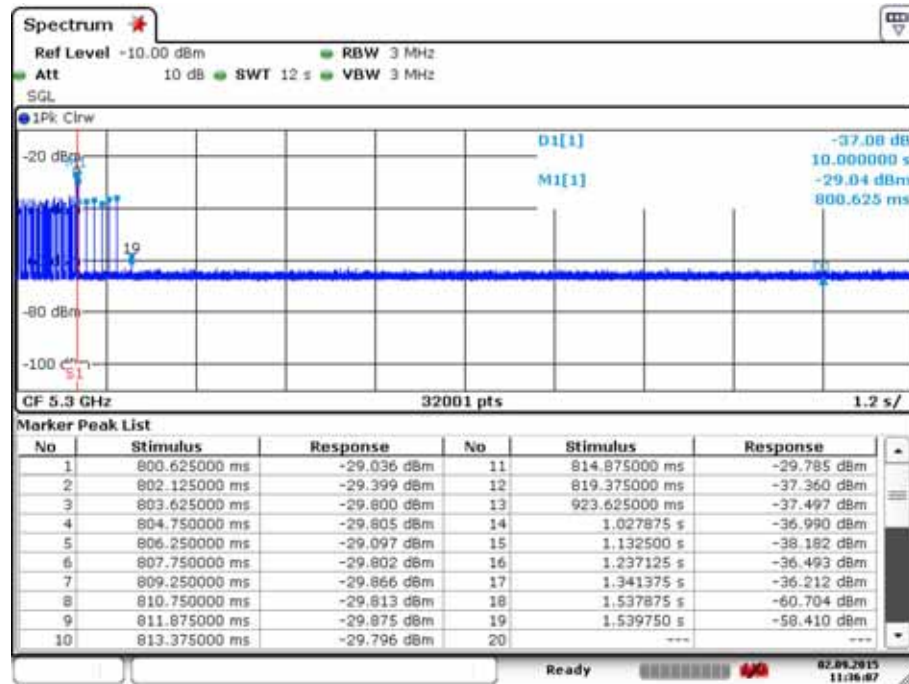

Date: 2.SEP.2015 11:36:08

40MHz

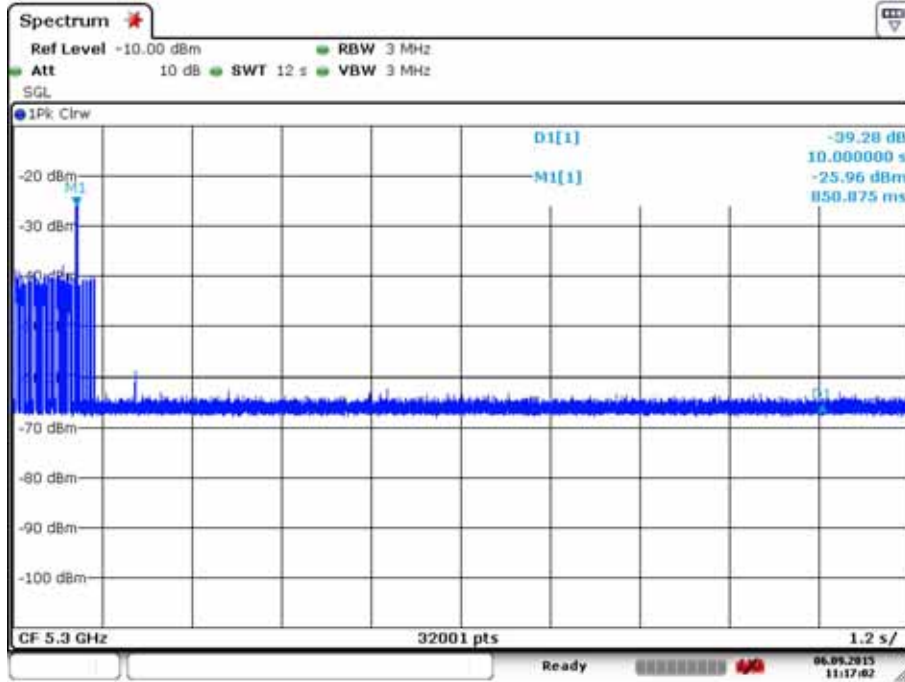

Date: 6.SEP.2015 11:17:03

Channel move time < 10 S

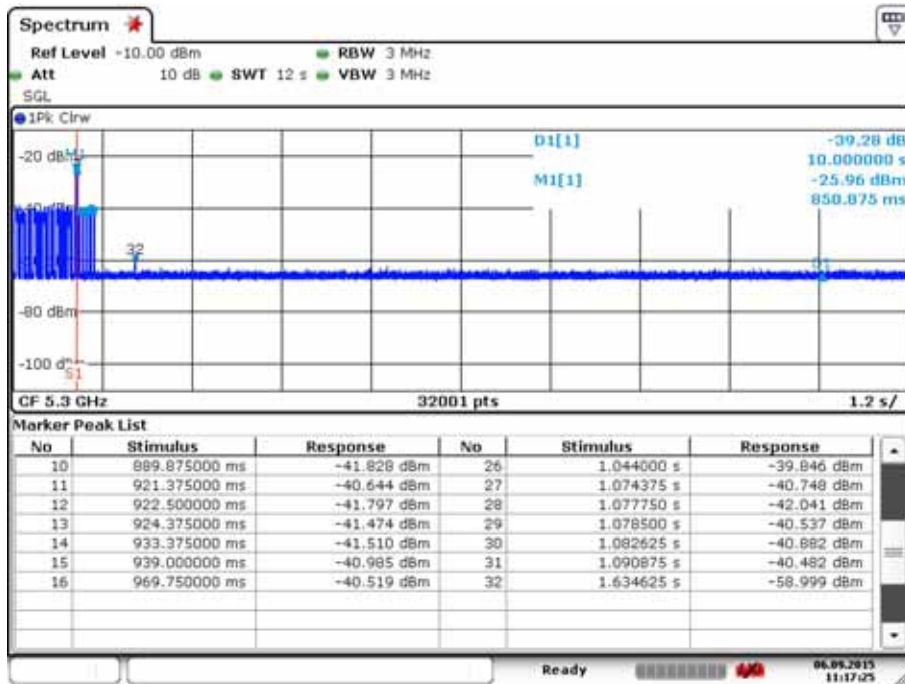

Date: 6.SEP.2015 11:17:26

80MHz

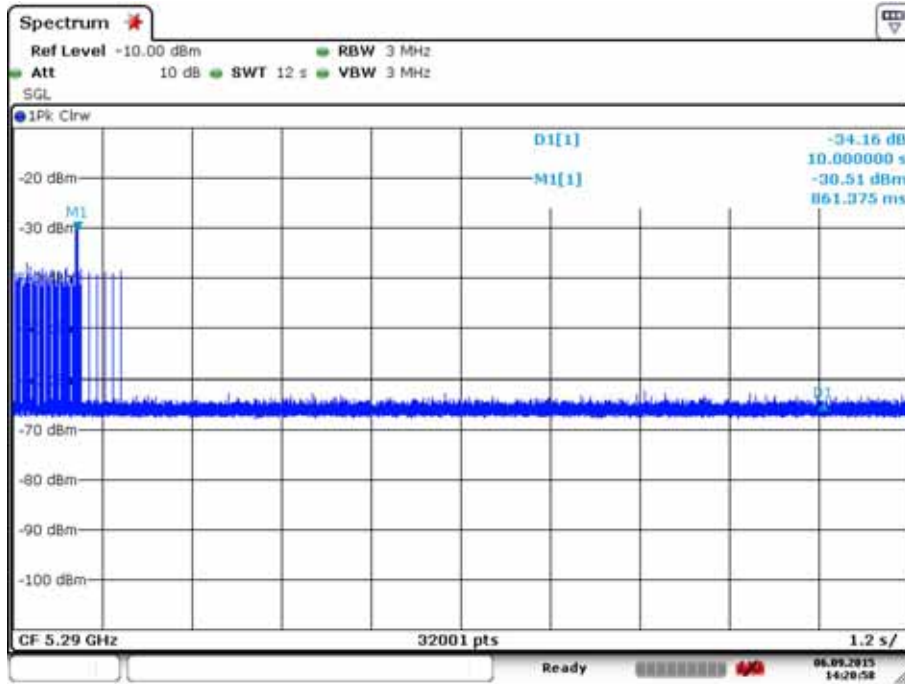

Date: 6.SEP.2015 14:20:58

Channel move time < 10 S

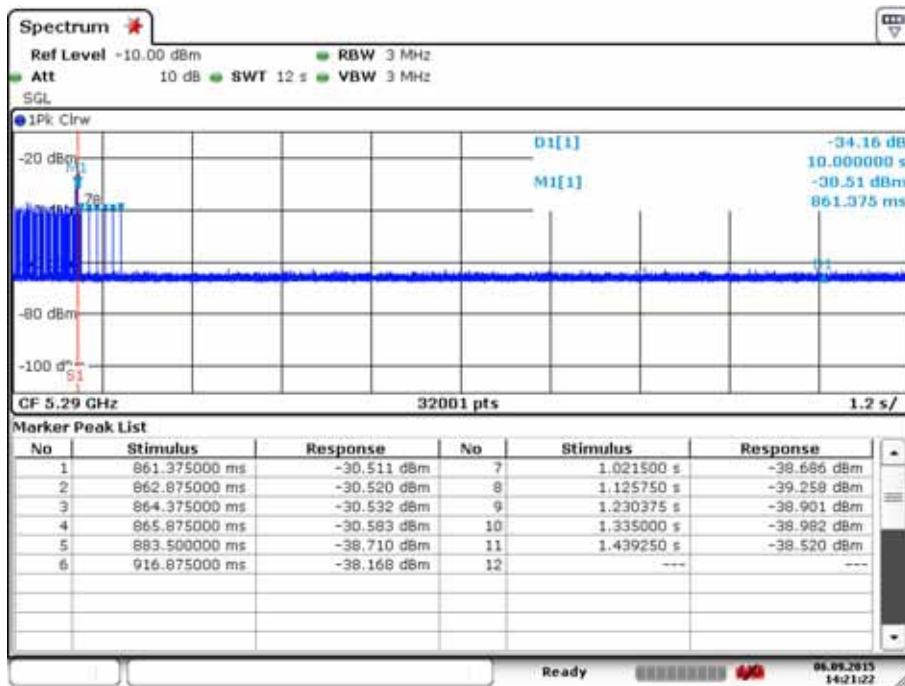

Date: 6.SEP.2015 14:21:22

20MHz

Test Channel: CH 60, Test Frequency: 5300MHz

Channel Closing Transmission Time Calculated	
Sweep Time(S) sec	12
Sweep points (P)	32001
Number of Sweep points in 10 sec (N)	19
Channel Closing Time (C)	7.12 ms

Channel closing time is calculated from $C=N* \text{dwell}$; where dwell is the occupancy time per sweep point calculated by the formula: $\text{dwell}=S/P$. N is the number of sweep points indicating transmission after S1; where S1 is the radar signal detected.

40MHz

Test Channel: CH 60, Test Frequency: 5300MHz

Channel Closing Transmission Time Calculated	
Sweep Time(S) sec	12
Sweep points (P)	32001
Number of Sweep points in 10 sec (N)	32
Channel Closing Time (C)	12.00 ms

Channel closing time is calculated from $C=N* \text{dwell}$; where dwell is the occupancy time per sweep point calculated by the formula: $\text{dwell}=S/P$. N is the number of sweep points indicating transmission after S1; where S1 is the radar signal detected.

80MHz

Test Channel: CH 58, Test Frequency: 5290MHz

Channel Closing Transmission Time Calculated	
Sweep Time(S) sec	12
Sweep points (P)	32001
Number of Sweep points in 10 sec (N)	11
Channel Closing Time (C)	4.12 ms

Channel closing time is calculated from $C=N* \text{dwell}$; where dwell is the occupancy time per sweep point calculated by the formula: $\text{dwell}=S/P$. N is the number of sweep points indicating transmission after S1; where S1 is the radar signal detected.

Test Mode: UNII Band III, 20MHz

Test Date: Sep.02~06, 2015

Temperature: 21°C

Humidity:56%

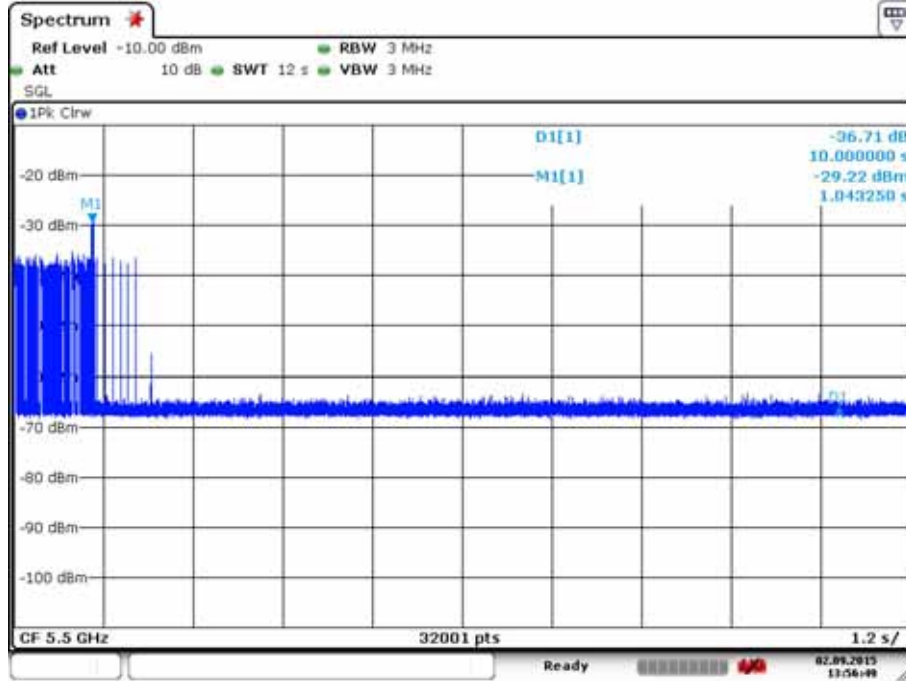

Date: 2.SEP.2015 13:56:48

Channel move time > 10 S

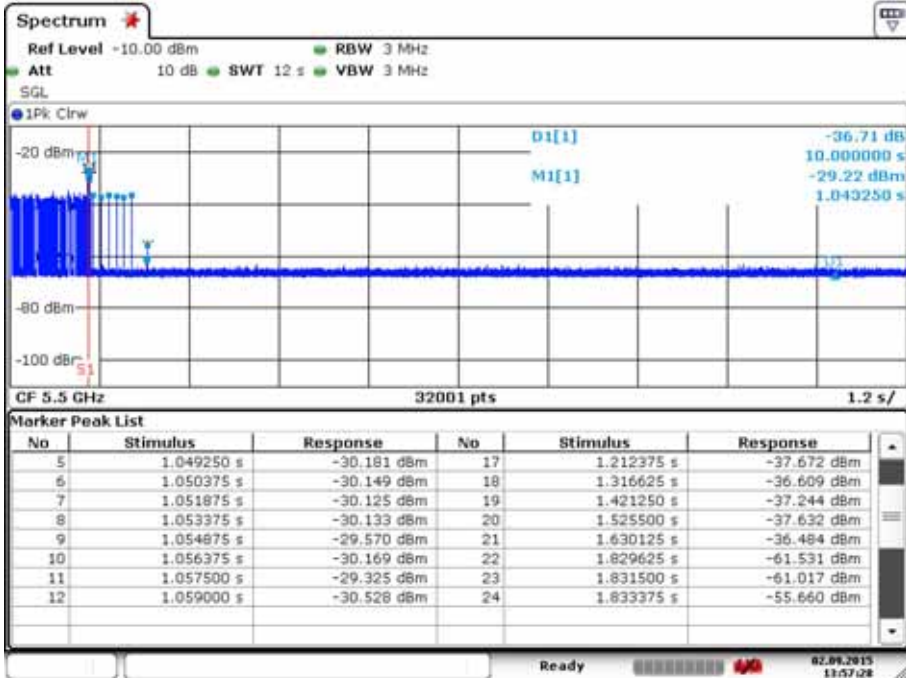

Date: 2.SEP.2015 13:57:28

40MHz

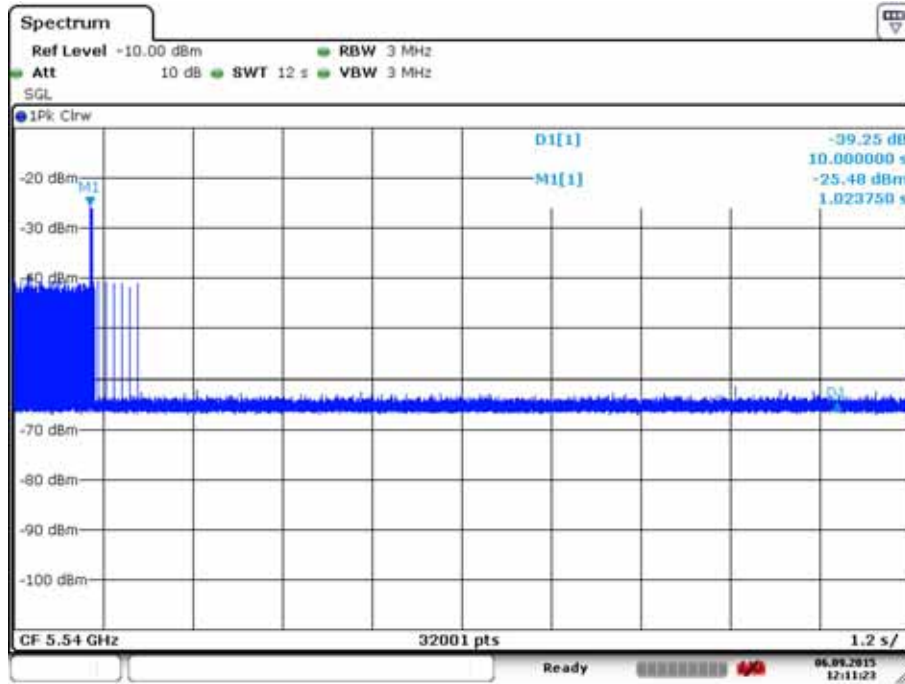

Date: 6.SEP.2015 12:11:23

Channel move time < 10 S

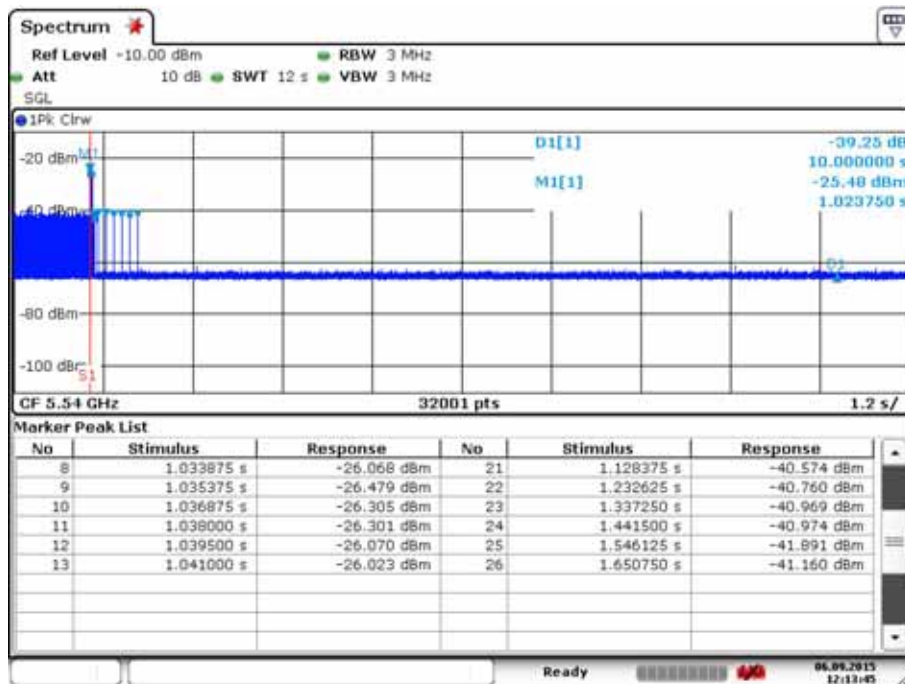

Date: 6.SEP.2015 12:13:45

80MHz

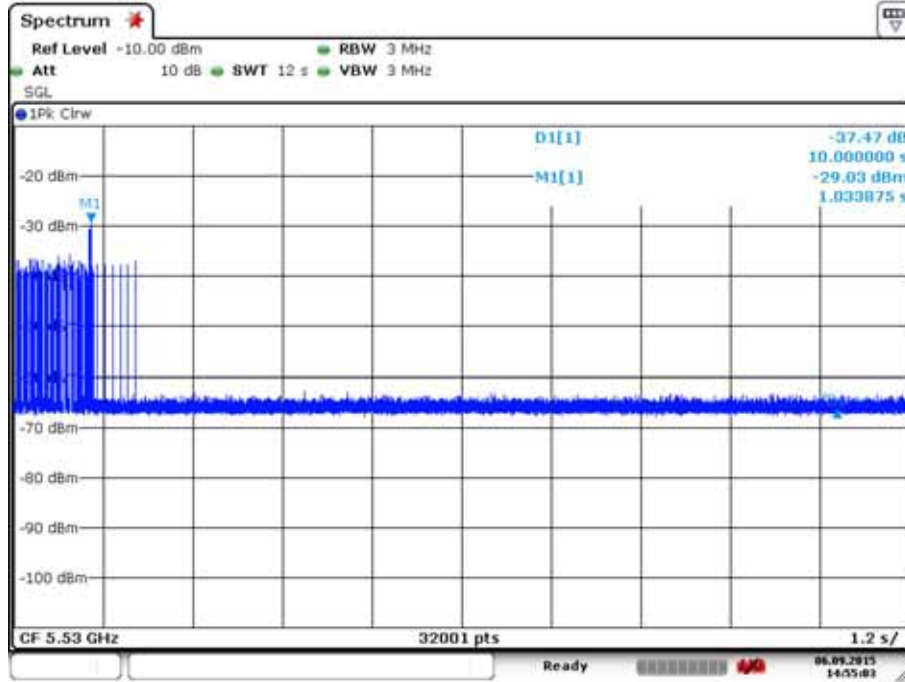

Date: 6.SEP.2015 14:55:03

Channel move time < 10 S

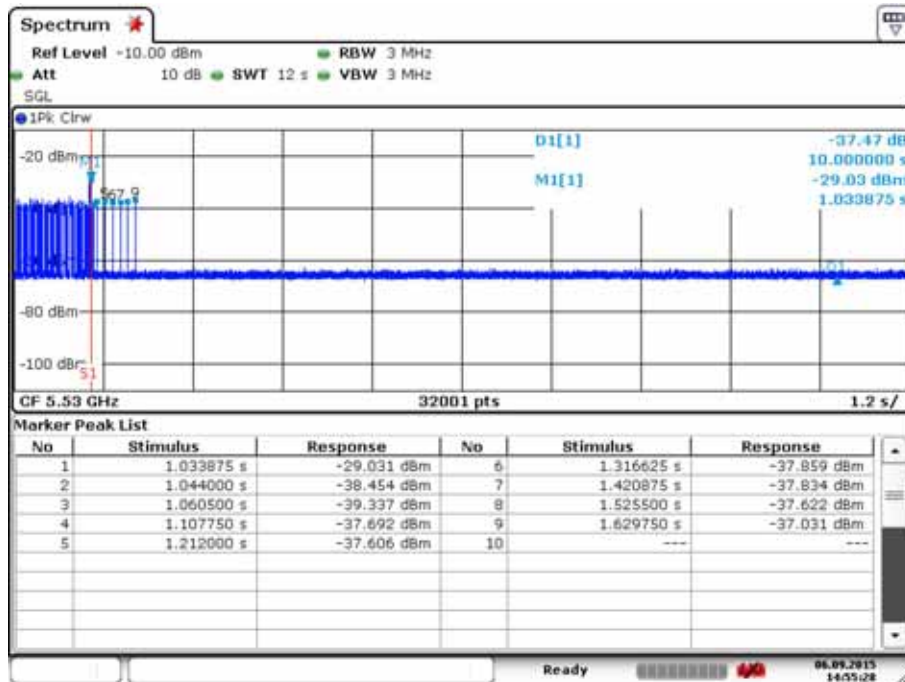

Date: 6.SEP.2015 14:55:28

20MHz

Test Channel: CH 100, Test Frequency: 5500MHz

Channel Closing Transmission Time Calculated	
Sweep Time(S) sec	12
Sweep points (P)	32001
Number of Sweep points in 10 sec (N)	24
Channel Closing Time (C)	9.00 ms

Channel closing time is calculated from $C=N* \text{dwell}$; where dwell is the occupancy time per sweep point calculated by the formula: $\text{dwell}=S/P$. N is the number of sweep points indicating transmission after S1; where S1 is the radar signal detected.

40MHz

Test Channel: CH 108, Test Frequency: 5540MHz

Channel Closing Transmission Time Calculated	
Sweep Time(S) sec	12
Sweep points (P)	32001
Number of Sweep points in 10 sec (N)	26
Channel Closing Time (C)	9.75 ms

Channel closing time is calculated from $C=N* \text{dwell}$; where dwell is the occupancy time per sweep point calculated by the formula: $\text{dwell}=S/P$. N is the number of sweep points indicating transmission after S1; where S1 is the radar signal detected.

80MHz

Test Channel: CH 106, Test Frequency: 5530MHz

Channel Closing Transmission Time Calculated	
Sweep Time(S) sec	12
Sweep points (P)	32001
Number of Sweep points in 10 sec (N)	9
Channel Closing Time (C)	3.37 ms

Channel closing time is calculated from $C=N* \text{dwell}$; where dwell is the occupancy time per sweep point calculated by the formula: $\text{dwell}=S/P$. N is the number of sweep points indicating transmission after S1; where S1 is the radar signal detected.