



FCC ID:RWO-RZ090168

AUDIX Technology (Shenzhen) Co., Ltd.

FCC PART 15C TEST REPORT FOR CERTIFICATION  
On Behalf of

Razer Inc.

Notebook

Model No.: RZ09-0168

FCC ID: RWO-RZ090168

Prepared for : Razer Inc.  
9 Pasteur, Suite 100 Irvine, California 92618, United States

Prepared By : Audix Technology (Shenzhen) Co., Ltd.  
No. 6, Ke Feng Rd., 52 Block,  
Shenzhen Science & Industrial Park,  
Nantou, Shenzhen, Guangdong, China

Tel: (0755) 26639496

Report Number : ACS-F15261  
Date of Test : Aug.24~Sep.08, 2015  
Date of Report : Sep.24, 2015

## TABLE OF CONTENTS

Description	Page
<b>1. SUMMARY OF STANDARDS AND RESULTS.....</b>	<b>1-1</b>
1.1. Description of Standards and Results .....	1-1
<b>2. GENERAL INFORMATION .....</b>	<b>2-1</b>
2.1. Description of Device (EUT).....	2-1
2.2. Tested Supporting System Details .....	2-2
2.3. Block Diagram of connection between EUT and simulators.....	2-3
2.4. Test information.....	2-3
2.5. Test Facility .....	2-4
2.6. Measurement Uncertainty (95% confidence levels, k=2).....	2-4
<b>3. POWER LINE CONDUCTED EMISSION TEST .....</b>	<b>3-1</b>
3.1. Test Equipments.....	3-1
3.2. Block Diagram of Test Setup.....	3-1
3.3. Power Line Conducted Emission Test Limits.....	3-1
3.4. Configuration of EUT on Test .....	3-2
3.5. Operating Condition of EUT .....	3-2
3.6. Test Procedure .....	3-2
3.7. Power Line Conducted Emission Test Results .....	3-2
<b>4. RADIATED EMISSION MEASUREMENT.....</b>	<b>4-1</b>
4.1. Test Equipment .....	4-1
4.2. Block Diagram of Test Setup.....	4-1
4.3. Radiated Emission Limit Standard: .....	4-2
4.4. EUT Configuration on Test .....	4-2
4.5. Operating Condition of EUT .....	4-2
4.6. Test Procedure .....	4-2
4.7. Radiated Emission Test Results.....	4-3
<b>5. CONDUCTED SPURIOUS EMISSIONS.....</b>	<b>5-1</b>
5.1. Test Equipment .....	5-1
5.2. Limit.....	5-1
5.3. Test Procedure .....	5-1
5.4. Test result.....	5-1
<b>6. 20 DB BANDWIDTH TEST .....</b>	<b>6-1</b>
6.1. Test Equipment .....	6-1
6.2. Limit.....	6-1
6.3. Test Results.....	6-1
<b>7. CARRIER FREQUENCY SEPARATION TEST .....</b>	<b>7-1</b>
7.1. Test Equipment .....	7-1
7.2. Limit.....	7-1
7.3. Test Results.....	7-1
<b>8. NUMBER OF HOPPING FREQUENCY TEST .....</b>	<b>8-1</b>
8.1. Test Equipment .....	8-1
8.2. Limit.....	8-1
8.3. Test Results.....	8-1
<b>9. DWELL TIME .....</b>	<b>9-1</b>
9.1. Test Equipment .....	9-1

9.2.	Limit.....	9-1
9.3.	Test Results.....	9-1
<b>10.</b>	<b>MAXIMUM PEAK OUTPUT POWER TEST .....</b>	<b>10-1</b>
10.1.	Test Equipment.....	10-1
10.2.	Limit.....	10-1
10.3.	Test Procedure .....	10-1
10.4.	Test Results.....	10-1
<b>11.</b>	<b>BAND EDGE COMPLIANCE TEST .....</b>	<b>11-1</b>
11.1.	Test Equipment.....	11-1
11.2.	Limit.....	11-1
11.3.	Test Produce.....	11-1
11.4.	Test Results .....	11-1
<b>12.</b>	<b>TENNA REQUIREMENT .....</b>	<b>12-1</b>
12.1.	Standard Applicable.....	12-1
12.2.	Antenna Connected Construction .....	12-1
<b>13.</b>	<b>DEVIATION TO TEST SPECIFICATIONS.....</b>	<b>13-1</b>
<b>14.</b>	<b>PHOTOGRAPH OF TEST .....</b>	<b>14-1</b>
14.1.	Photos of Power Line Conducted Emission Test.....	14-1
14.2.	Photos of Radiated Emission Test .....	14-2
<b>1.</b>	<b>PHOTOGRAPH OF EUT .....</b>	<b>14-1</b>



FCC ID:RWO-RZ090168

### TEST REPORT CERTIFICATION

Applicant : Razer Inc.  
 Manufacturer : Razer Inc.  
 EUT Description : Notebook  
 FCC ID : RWO-RZ090168  
 (A) Model NO. : RZ09-0168  
 (B) Serial NO. : N/A  
 (C) Test Voltage : DC 20V From Adapter Input 120V/60Hz

Tested for comply with:  
 FCC CFR47 Part 15 Subpart C: 2014

Test procedure used:  
 ANSI C63.10: 2013

The device described above is tested by AUDIX TECHNOLOGY (SHENZHEN) CO., LTD. to confirm comply with all the FCC Part 15 Subpart C requirements. The test results are contained in this test report and AUDIX TECHNOLOGY (SHENZHEN) CO., LTD. is assumed full responsibility for the accuracy and completeness of these tests. Also, this report shows that the Equipment Under Test (EUT) is to be technically compliant with the FCC and IC requirements. This report contains data that are not covered by the NVLAP accreditation.

This Report is made under FCC Part 2.1075. No modifications were required during testing to bring this product into compliance.

This report applies to above tested sample only. This report shall not be reproduced in part without written approval of AUDIX TECHNOLOGY (SHENZHEN) CO., LTD.

The report must not be used by the client to claim product certification, approval, or endorsement by NVLAP, NIST, or any agency of the federal government.

Date of Test : Aug.24~Sep.08, 2015 Report of date: Sep.24, 2015

Prepared by : Cindy Zhu / Assistant      Reviewed by : Sunny Lu / Assistant Manager

**AUDIX**® 信華科技(深圳)有限公司  
 Audix Technology (Shenzhen) Co., Ltd.  
 EMC 部門報告專用章  
 Stamp only for EMC Dept. Report  
 Signature: David Jin  
 David Jin / Manager

Approved & Authorized Signer :

## 1. SUMMARY OF STANDARDS AND RESULTS

### 1.1. Description of Standards and Results

The EUT have been tested according to the applicable standards as referenced below.

EMISSION		
Description of Test Item	Standard	Results
Power Line Conducted Emission Test	FCC Part 15: 15.207 ANSI C63.10 2013	PASS
Radiated Emission Test	FCC Part 15 15.209 FCC Part 15 15.247(d) ANSI C63.10 2013	PASS
Conducted Spurious Emissions	FCC Part 15: 15.247(a)(1) ANSI C63.10 2013	PASS
Carrier Frequency Separation Test	FCC Part 15: 15.247(a)(1) ANSI C63.10 2013	PASS
20dB Bandwidth Test	FCC Part 15: 15.215 ANSI C63.10 2013	PASS
Number Of Hopping Frequency Test	FCC Part 15: 15.247(a)(1)(iii) ANSI C63.10 2013	PASS
Dwell Time Test	FCC Part 15: 15.247(a)(1)(iii) ANSI C63.10 2013	PASS
Maximum Peak Output Power Test	FCC Part 15 15.247(b)(1)\ ANSI C63.10 2013	PASS
Band Edge Compliance Test	FCC Part 15 15.247(d) ANSI C63.10 2013	PASS



## 2. GENERAL INFORMATION

### 2.1. Description of Device (EUT)

Product Name	: Notebook
Model Number	: RZ09-0168
FCC ID	: RWO-RZ090168
Radio	: IEEE802.11 a/b/g/n/ac; Bluetooth V3.0+EDR; Bluetooth V4.1
Operation Frequency	: IEEE 802.11a: 5180MHz—5240MHz; 5260MHz—5320MHz 5500MHz—5700MHz; 5745MHz—5825MHz IEEE 802.11ac VHT20: 5180MHz—5240MHz; 5260MHz—5320MHz 5500MHz—5700MHz; 5745MHz—5825MHz IEEE 802.11ac VHT40: 5190MHz—5230MHz; 5270MHz—5310MHz 5510MHz—5670MHz; 5755MHz—5795MHz : IEEE 802.11ac VHT80: 5210MHz, 5290MHz; 5530MHz; 5775MHz IEEE 802.11b: 2412MHz—2462MHz IEEE 802.11g: 2412MHz—2462MHz IEEE802.11nHT20: 2412MHz—2462MHz; 5180MHz—5240MHz; 5260MHz—5320MHz 5500MHz—5700MHz; 5745MHz—5825MHz IEEE802.11nHT40: 2422MHz—2452MHz; 5190MHz—5230MHz; 5270MHz—5310MHz 5510MHz—5670MHz; 5755MHz—5795MHz Bluetooth : 2402-2480MHz
Modulation Technology	: IEEE 802.11b: DSSS(CCK,DQPSK,DBPSK) IEEE 802.11a/g: OFDM(64QAM, 16QAM, QPSK, BPSK) IEEE 802.11ac VHT20, VHT40, VHT80: OFDM(16QAM, 64QAM, 256QAM, QPSK, BPSK) IEEE 802.11n HT20, HT40: OFDM (64QAM, 16QAM,QPSK,BPSK) Bluetooth V3.0+EDR: GFSK, $\pi/4$ DQPSK,8-DPSK Bluetooth V4.1:GFSK
Antenna Assembly Gain	: Antenna Type: PIFA Bluetooth: 2.84dBi WIFI 2.4GHz:ANT 0: 2.84dBi; ANT 1: 2.37dBi : U-NII 5180-5240MHz Band: ANT 0: -0.18dBi; ANT 1: -0.78dBi U-NII 5260-5320MHz Band: ANT 0: 0.32dBi; ANT 1: -0.08dBi U-NII 5500-5700MHz Band: ANT 0: 3.52dBi; ANT 1: 3.07dBi U-NII 5745-5825MHz Band: ANT 0: 3.48dBi; ANT 1: 3.18dBi

**Applicant** : Razer Inc.  
 9 Pasteur, Suite 100 Irvine, California 92618, United States

**Manufacturer** : Razer Inc.  
 9 Pasteur, Suite 100 Irvine, California 92618, United States

**Factory** : BYD Precision Manufacture Co., Ltd  
 No.3001, Baohe Road, Baolong Industrial, Longgang,  
 Shenzhen, 518116, P.R., China

**Adapter** : Manufacturer: Razer Inc. Model No: RC30-0168  
 : Input: 100-240 Vac,50/60Hz, 2.0A  
 Output: 20V,2.25A

**Date of Test** : Aug.24~Sep.08, 2015

**Date of Receipt** : Aug.20, 2015

## 2.2. Tested Supporting System Details

No.	Description	ACS No.	Manufacturer	Model	Serial Number	Approved type
1.	HDD#1	ACS-EMC-HDD02	Terasys	F12-UF	A0100215-53 90018	<input type="checkbox"/> FCC ID <input checked="" type="checkbox"/> BSMI ID : 4912A022
		Data Cable: Shielded, Detachable, 1.0m				
2.	HDD#2	ACS-EMC-HDD03	Terasys	F12-UF	A0100215-53 90030	<input type="checkbox"/> FCC ID <input checked="" type="checkbox"/> BSMI ID : 4912A022
		Data Cable: Shielded, Detachable, 1.0m				
3.	Earphone	ACS-EMC-EP01	OVANN	OV880V	---	<input checked="" type="checkbox"/> CCC
		Data Cable: Shielded, Undetachable, 2.0m				
4.	3D Monitor	---	Samsung	SA950	---	---
		Adapter: M/N:AD-6314N DC Cable:Unshielded Undetachable 1.5m AC Cable: Unshielded Detachable 1.8m				

2.3. Block Diagram of connection between EUT and simulators

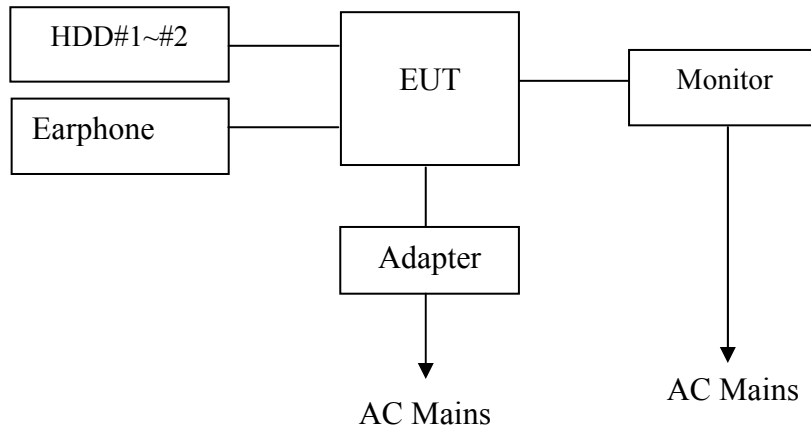

**(EUT: Notebook)**

2.4. Test information

A special software was used to control EUT work in continuous TX mode (GFSK,  $\pi/4$ DQPSK, 8-DPSK Modulation)

Tested mode, channel, and data rate information			
Mode	data rate (Mbps)	Channel	Frequency (MHz)
Tx Mode GFSK modulation	1	Low :CH 0	2402
	1	Middle: CH39	2441
	1	High: CH78	2480
Tx Mode 8-DPSK modulation	3	Low :CH 0	2402
	3	Middle: CH39	2441
	3	High: CH78	2480

Note:  $\pi/4$ DQPSK modulation is same type modulation with 8-DPSK, and according exploratory test, 8-DPSK will have worse emissions, so the final test were only performed with GFSK and 8-DPSK modulation.



**2.5. Test Facility**

Site Description

- Name of Firm : Audix Technology (Shenzhen) Co., Ltd.  
 No. 6, Ke Feng Rd., 52 Block, Shenzhen  
 Science & Industrial Park, Nantou, Shenzhen,  
 Guangdong, China
- 3m Anechoic Chamber : Certificated by FCC, USA  
 Registration Number: 90454  
 Valid Date: Dec.30, 2017
- 3m & 10m Anechoic Chamber : Certificated by FCC, USA  
 Registration Number: 794232  
 Valid Date: Jul.12, 2017
- EMC Lab. : Certificated by Industry Canada  
 Registration Number: IC 5183A-1  
 Valid Date: May.14, 2017
- : Certificated by DAkkS, Germany  
 Registration No: D-PL-12151-01-00  
 Valid Date: Dec.15, 2016
- : Accredited by NVLAP, USA  
 NVLAP Code: 200372-0  
 Valid Date: Mar.31, 2016

**2.6. Measurement Uncertainty (95% confidence levels, k=2)**

Test Item	Uncertainty
Uncertainty for Conduction emission test in No. 1 Conduction	3.4dB (150KHz to 30MHz)
Uncertainty for Radiation Emission test in 3m chamber	3.0 dB(30~200MHz, Polarization: H)
	3.0 dB(30~200MHz, Polarization: V)
	3.2 dB(200M~1GHz, Polarization: H)
	3.1 dB(200M~1GHz, Polarization: V)
Uncertainty for Radiation Emission test in 3m chamber (1GHz-18GHz)	6.3 dB (1~6GHz, Distance: 3m)
	5.7 dB (6~18GHz, Distance: 3m)
Uncertainty for Radiated Spurious Emission test in RF chamber	3.6 dB
Uncertainty for Conduction Spurious emission test	2.0 dB
Uncertainty for Output power test	0.8 dB
Uncertainty for Bandwidth test	83 kHz
Uncertainty for DC power test	0.1 %
Uncertainty for test site temperature and humidity	0.6
	3%

### 3. POWER LINE CONDUCTED EMISSION TEST

#### 3.1. Test Equipments

Item	Equipment	Manufacturer	Model No.	Serial No.	Last Cal.	Cal. Interval
1.	1# Shielding Room	AUDIX	N/A	N/A	Apr.17,15	1 Year
2.	Test Receiver	Rohde & Schwarz	ESCI	100842	Apr.28,15	1 Year
3.	L.I.S.N.#1	Rohde & Schwarz	ESH2-Z5	100429	Oct.29,14	1 Year
4.	L.I.S.N.#2	Kyoritsu	K NW-403D	8-1750-2	Apr.28,15	1 Year
5.	Terminator	Hubersuhner	50Ω	No.1	Apr.28,15	1 Year
6.	Terminator	Hubersuhner	50Ω	No.2	Apr.28,15	1 Year
7.	RF Cable	MIYAZAKI	3D-2W	No.1	Apr.28,15	1Year
8.	Coaxial Switch	Anritsu	MP59B	6200766906	Apr.28,15	1 Year
9.	Pulse Limiter	Rohde & Schwarz	ESH3-Z2	101838	Oct.29,14	1 Year
10.	Test Software	AUDIX	E3	6.100913a	N/A	N/A

#### 3.2. Block Diagram of Test Setup

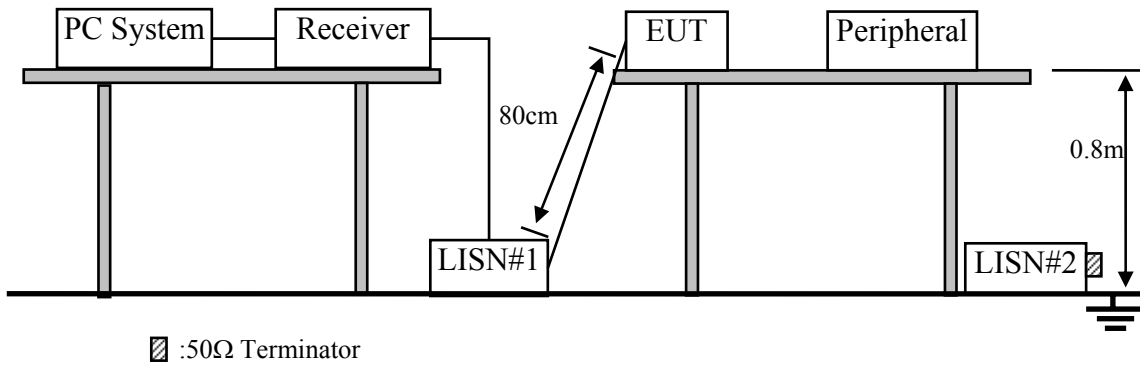

#### 3.3. Power Line Conducted Emission Test Limits

Frequency	Maximum RF Line Voltage	
	Quasi-Peak Level dB(μV)	Average Level dB(μV)
150kHz ~ 500kHz	66 ~ 56*	56 ~ 46*
500kHz ~ 5MHz	56	46
5MHz ~ 30MHz	60	50

Notes: 1. \* Decreasing linearly with logarithm of frequency.

2. The lower limit shall apply at the transition frequencies.

### 3.4. Configuration of EUT on Test

The following equipment are installed on Power Line Conducted Emission Test to meet the commission requirement and operating regulations in a manner which tends to maximize its emission characteristics in a normal application.

#### 3.4.1. Notebook (EUT)

Model Number : RZ09-0168  
Serial Number : N/A

3.4.2. Support Equipment: As Tested Supporting System Details, in Section 2.2.

### 3.5. Operating Condition of EUT

3.5.1. Setup the EUT and simulator as shown as Section 3.2.

3.5.2. Turned on the power of all equipment.

3.5.3. PC run test software to control EUT work in BT 3.0 Tx mode.

### 3.6. Test Procedure

The EUT was placed on a non-metallic table, 80cm above the ground plane. The EUT Power Via PC connected to the power mains through a line impedance stabilization network (L.I.S.N. 1#). This provides a 50 ohm coupling impedance for the EUT (Please refer the block diagram of the test setup and photographs). The AC line are checked to find out the maximum conducted emission. In order to find the maximum emission levels, the relative positions of equipment and all of the interface cables shall be changed according to ANSI C63.10: 2013 on Conducted Emission Test.

The bandwidth of test receiver (R & S ESCI ) is set at 9kHz.

The frequency range from 150kHz to 30MHz is checked.

### 3.7. Power Line Conducted Emission Test Results

**PASS.** (All emissions not reported below are too low against the prescribed limits.)

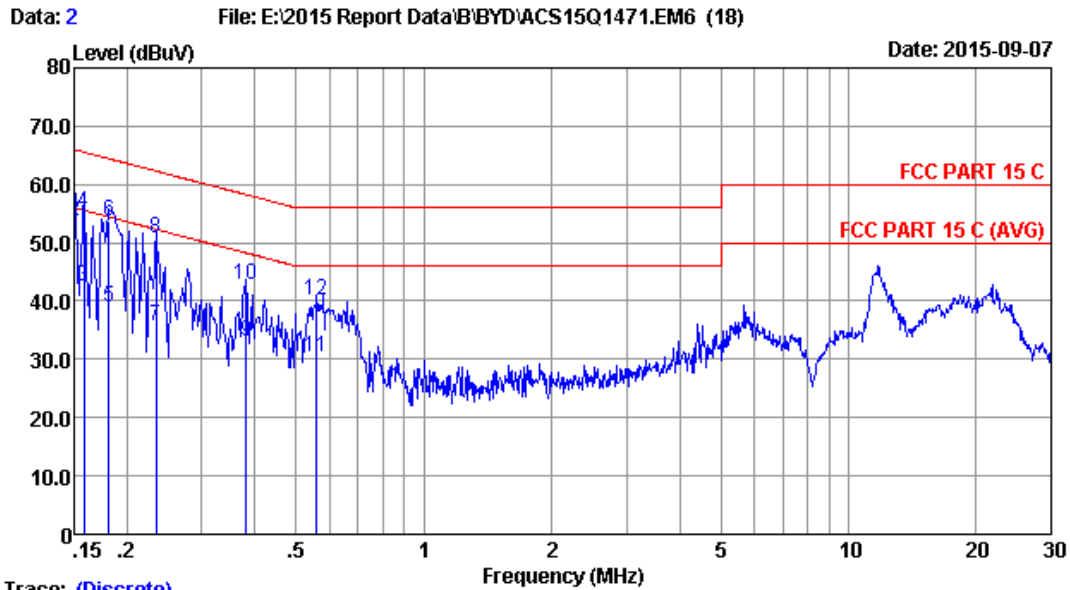

Trace: (Discrete)

Site no :1# Conduction Data No :2  
 Dis./Lisn :2014 ESH2-25 LINE  
 Limit :FCC PART 15 C  
 Env./Ins. :25.5\*C/54% Engineer :Evan  
 EUT :Notebook M/N:RZ09-0168  
 Power Rating :DC 20V From Adapter Input AC 120V/60Hz  
 Test Mode :TX Mode

No	Freq (MHz)	LISN Factor (dB)	Cable Loss (dB)	Reading (dBuV)	Emission Level (dBuV)	Limits (dBuV)	Margin (dB)	Remark
1	0.150	0.14	10.30	27.90	38.34	56.00	17.66	Average
2	0.150	0.14	10.30	43.40	53.84	66.00	12.16	QP
3	0.158	0.14	10.30	32.10	42.54	55.56	13.02	Average
4	0.158	0.14	10.30	44.75	55.19	65.56	10.37	QP
5	0.182	0.14	10.28	28.60	39.02	54.42	15.40	Average
6	0.182	0.14	10.28	43.32	53.74	64.42	10.68	QP
7	0.234	0.13	10.25	25.30	35.68	52.30	16.62	Average
8	0.234	0.13	10.25	40.36	50.74	62.30	11.56	QP
9	0.381	0.60	10.19	22.20	32.99	48.25	15.26	Average
10	0.381	0.60	10.19	31.91	42.70	58.25	15.55	QP
11	0.558	0.15	10.15	20.10	30.40	46.00	15.60	Average
12	0.558	0.15	10.15	29.72	40.02	56.00	15.98	QP

Remarks: 1.Emission Level=LISN Factor+Cable Loss(Include 10dB pulse limit)+Reading.  
 2.If the average limit is met when using a quasi-peak detector, the EUT shall be deemed to meet both limits and measurement with average detector is unnecessary.

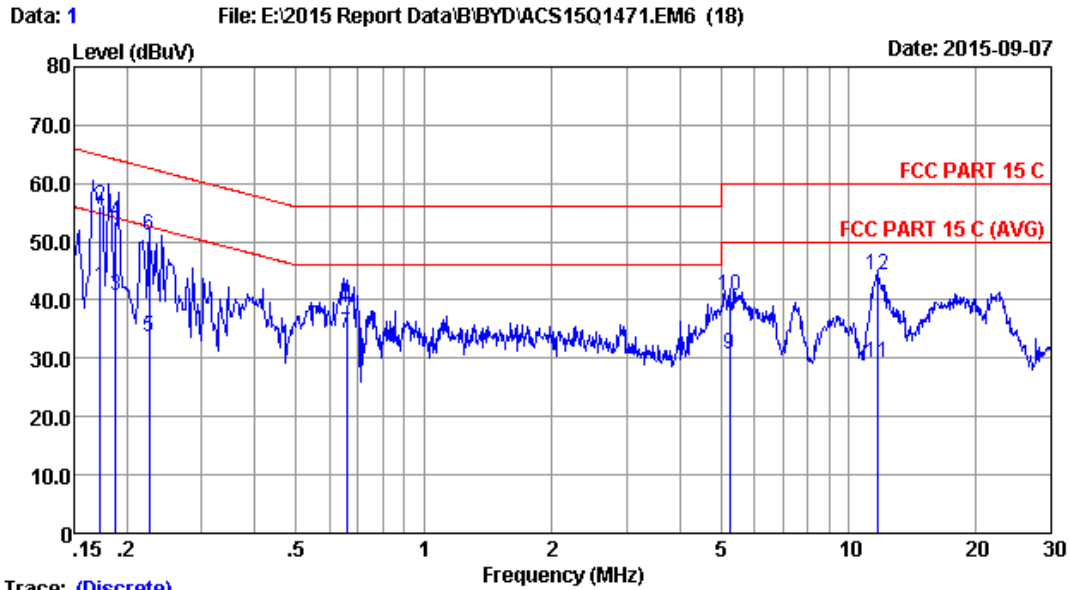

Trace: (Discrete)

Site no :1# Conduction Data No :1  
 Dis./Lisn :2014 ESH2-25 NEUTRAL  
 Limit :FCC PART 15 C  
 Env./Ins. :25.5\*C/54% Engineer :Evan  
 EUT :Notebook M/N:RZ09-0168  
 Power Rating :DC 20V From Adapter Input AC 120V/60Hz  
 Test Mode :TX Mode

No	Freq (MHz)	LISN Factor (dB)	Cable Loss (dB)	Reading (dBUV)	Emission Level (dBUV)	Limits (dBUV)	Margin (dB)	Remark
1	0.173	0.13	10.29	31.80	42.22	54.82	12.60	Average
2	0.173	0.13	10.29	45.60	56.02	64.82	8.80	QP
3	0.188	0.13	10.28	30.20	40.61	54.12	13.51	Average
4	0.188	0.13	10.28	43.00	53.41	64.12	10.71	QP
5	0.226	0.13	10.25	23.20	33.58	52.61	19.03	Average
6	0.226	0.13	10.25	40.61	50.99	62.61	11.62	QP
7	0.657	0.16	10.16	23.80	34.12	46.00	11.88	Average
8	0.657	0.16	10.16	28.90	39.22	56.00	16.78	QP
9	5.249	0.28	10.19	20.30	30.77	50.00	19.23	Average
10	5.249	0.28	10.19	30.36	40.83	60.00	19.17	QP
11	11.683	0.42	10.11	18.60	29.13	50.00	20.87	Average
12	11.683	0.42	10.11	33.66	44.19	60.00	15.81	QP

Remarks: 1.Emission Level=LISN Factor+Cable Loss(Include 10dB pulse limit)+Reading.  
 2.If the average limit is met when using a quasi-peak detector.  
 the EUT shall be deemed to meet both limits and measurement  
 with average detector is unnecessary.

## 4. RADIATED EMISSION MEASUREMENT

### 4.1. Test Equipment

Frequency range: 30~1000MHz

Item	Equipment	Manufacturer	Model No.	Serial No.	Last Cal.	Cal. Interval
1.	3#Chamber	AUDIX	N/A	N/A	Nov.23,14	1 Year
2.	EMI Spectrum	Agilent	E4407B	MY41440292	Apr.28,15	1 Year
3.	Test Receiver	Rohde & Schwarz	ESVS10	834468/011	Apr.28,15	1 Year
4.	Amplifier	HP	8447D	2648A04738	Apr.28,15	1 Year
5.	Trilog-Broadband Antenna	SCHWARZBECK	VULB 9168	9168-493	May.06,15	1 Year
6.	RF Cable	MIYAZAKI	CFD400-N W(3.5M)	No.3	Apr.28,15	1 Year
7.	RF Cable	MIYAZAKI	CFD400-L W(22M)	No.7	Apr.28,15	1 Year
8.	Coaxial Switch	Anritsu	MP59B	6201397222	Apr.28,15	1 Year
9.	Test Software	AUDIX	E3	6.2009-5-21a(n)	N/A	N/A

Frequency range: above 1000MHz

Item	Equipment	Manufacturer	Model No.	Serial No.	Last Cal.	Cal. Interval
1.	3#Chamber	AUDIX	N/A	N/A	Nov.02, 14	1 Year
2.	Spectrum Analyzer	Agilent	E4407B	MY41440292	Apr. 28,15	1 Year
3.	Horn Antenna	ETS	3115	9607-4877	Sep.20, 14	1 Year
4.	Amplifier	Agilent	8449B	3008A00863	Apr. 28,15	1 Year
5.	RF Cable	Hubersuhner	SUCOFLEX106	77977/6	Apr. 28,15	1 Year
6.	RF Cable	Hubersuhner	SUCOFLEX106	28616/2	Apr. 28,15	1 Year
7.	Horn Antenna	ETS	3116	00060089	Sep.20, 14	1 Year



4.2. Block Diagram of Test Setup  
For frequency range 30MHz-1000MHz

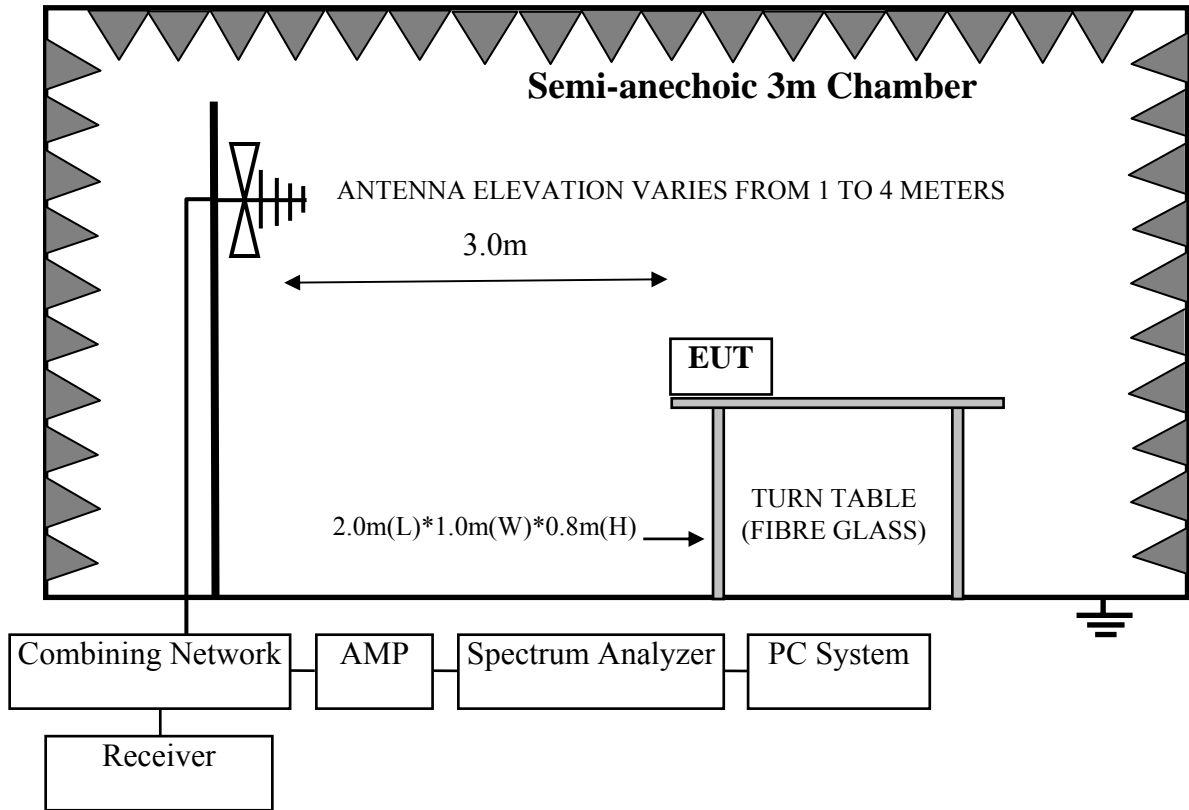

For frequency range 1GHz-25GHz

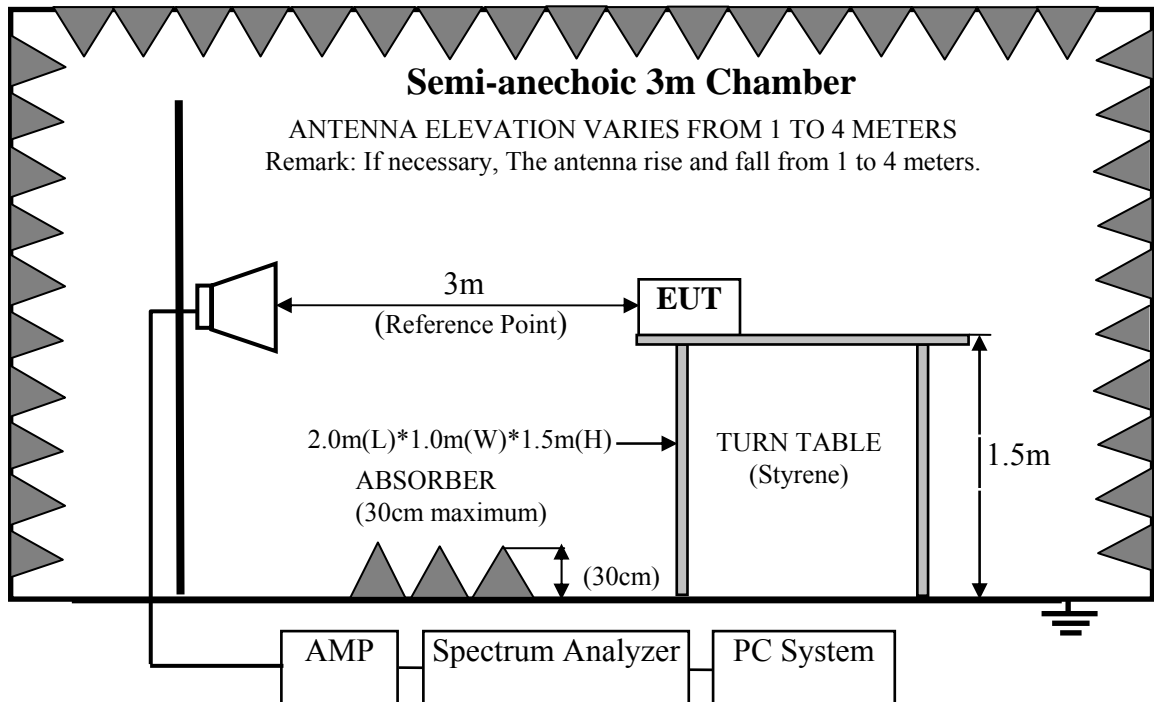

4.3. Radiated Emission Limit Standard:

FREQUENCY MHz	DISTANCE Meters	FIELD STRENGTHS LIMIT	
		μV/m	dB(μV)/m
30 ~ 88	3	100	40.0
88 ~ 216	3	150	43.5
216 ~ 960	3	200	46.0
960 ~ 1000	3	500	54.0
Above 1000MHz	3	74.0 dB(μV)/m (Peak) 54.0 dB(μV)/m (Average)	

- Remark :
- (1) Emission level dBμV = 20 log Emission level μV/m
  - (2) The smaller limit shall apply at the cross point between two frequency bands.
  - (3) Distance is the distance in meters between the measuring instrument, antenna and the closest point of any part of the device or system.
  - (4) The emission limits shown in the above table are based on measurements employing a CISPR quasi-peak detector except for the frequency bands 9-90 kHz, 110-490 kHz and above 1000 MHz. Radiated emission limits in these three bands are based on measurements employing an average detector.

4.4. EUT Configuration on Test

The following equipment are installed on Radiated Emission Test to meet the commission requirements and operating regulations in a manner which tends to maximize its emission characteristics in normal application.

4.4.1. Notebook (EUT)

Model Number : RZ09-0168  
Serial Number : N/A

4.5. Operating Condition of EUT

- 4.5.1. Setup the EUT and simulator as shown as Section 4.2.
- 4.5.2. Turned on the power of all equipment.
- 4.5.3. Let EUT work in BT 3.0 Tx mode.

4.6. Test Procedure

EUT and its simulators are placed on a turn table, which is 0.8 meter high above ground for frequency 30MHz~1000MHz, 1.5 meter high above ground for frequency above 1GHz and put the absorbing with 2.4m(L)\*2.4m(W)\*0.3m(H) on the ground . The turn table can rotate 360 degrees to determine the position of the maximum emission level. Power on the EUT and let it working in test mode, then test it. EUT is set 3 meters away from the receiving antenna, which is mounted on a antenna tower. The antenna can be moved up and down between 1 meter and 4 meters to find out the maximum emission level. Broadband antenna (calibrated bilog antenna) is used as receiving antenna for frequency 30MHz~1000MHz, and the Horn antenna is used as receiving antenna for frequency above 1GHz. Both horizontal and vertical polarization of the antenna is set on Test. In order to find the maximum emission levels, all of the interface cables must be manipulated according to ANSI C63.10-2013 on radiated emission Test.

This test was performed with EUT in X, Y, Z position, and the worse case was found when EUT in X position as the test photo indicated.

The bandwidth of the EMI test receiver (R&S ESVS10) is set at 120kHz for frequency range from 30MHz to 1000 MHz.

The bandwidth of the Spectrum's RBW is set at 1MHz and VBW is set at 3MHz for peak emissions measurement above 1GHz

This device is pulse Modulated, a duty cycle factor was used to calculated average level based measured peak level.

The frequency range from 30MHz to 10th harmonic (25GHz) are checked. and no any emissions were found from 18GHz to 25 GHz, So the radiated emissions from 18GHz to 25GHz were not record.

#### 4.7.Radiated Emission Test Results

**PASS.**

All the emissions from 30MHz to 25GHz were comply with the 15.209 Limit.

Note: The duty cycle factor for calculate average level is -30.648 dB, and average limit is 20dB below peak limit, so if peak measured level comply with average limit, the average level was deemed to comply with average limit.

Duty cycle factor =  $20\log ( \text{Dwell time}/100\text{ms} ) = -30.648$

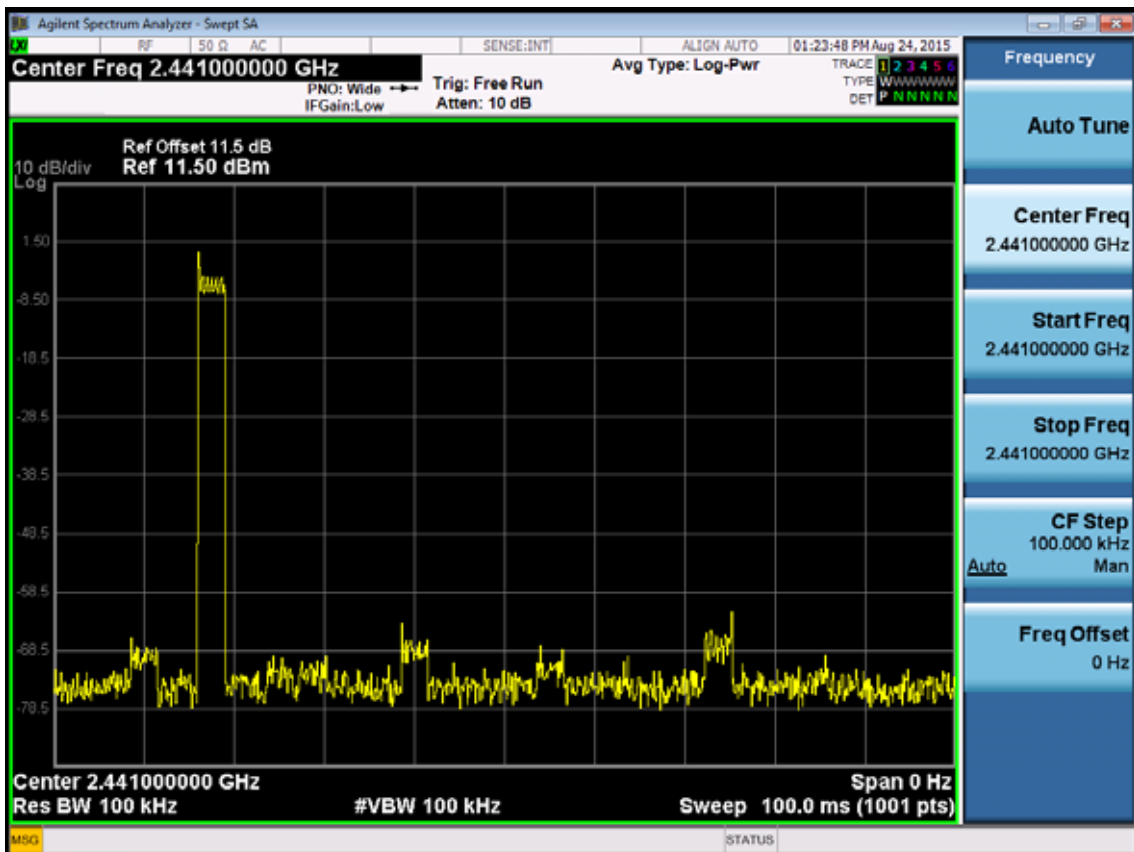
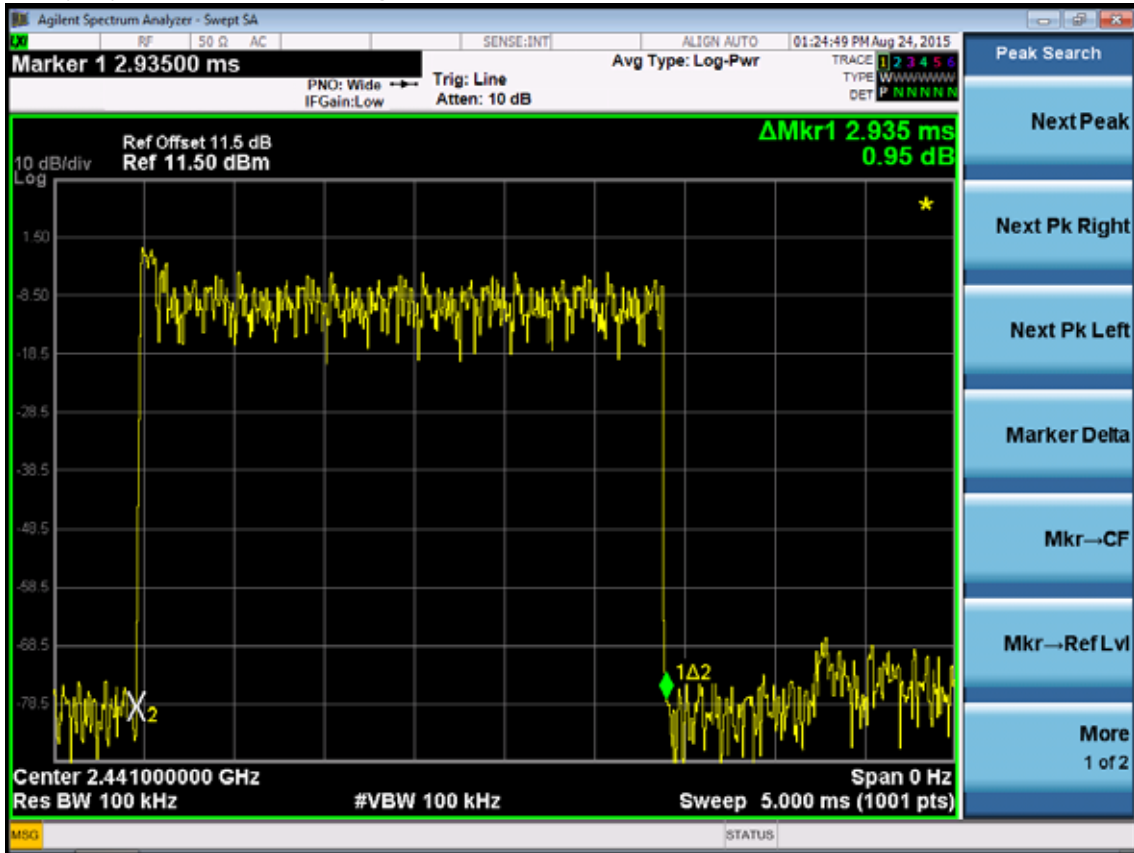

Frequency: 30MHz~1GHz

Data: 1

File: E:\2015 Report Data\B\BYD\ACS15Q1471.EM6 (16)

Date: 2015-09-08

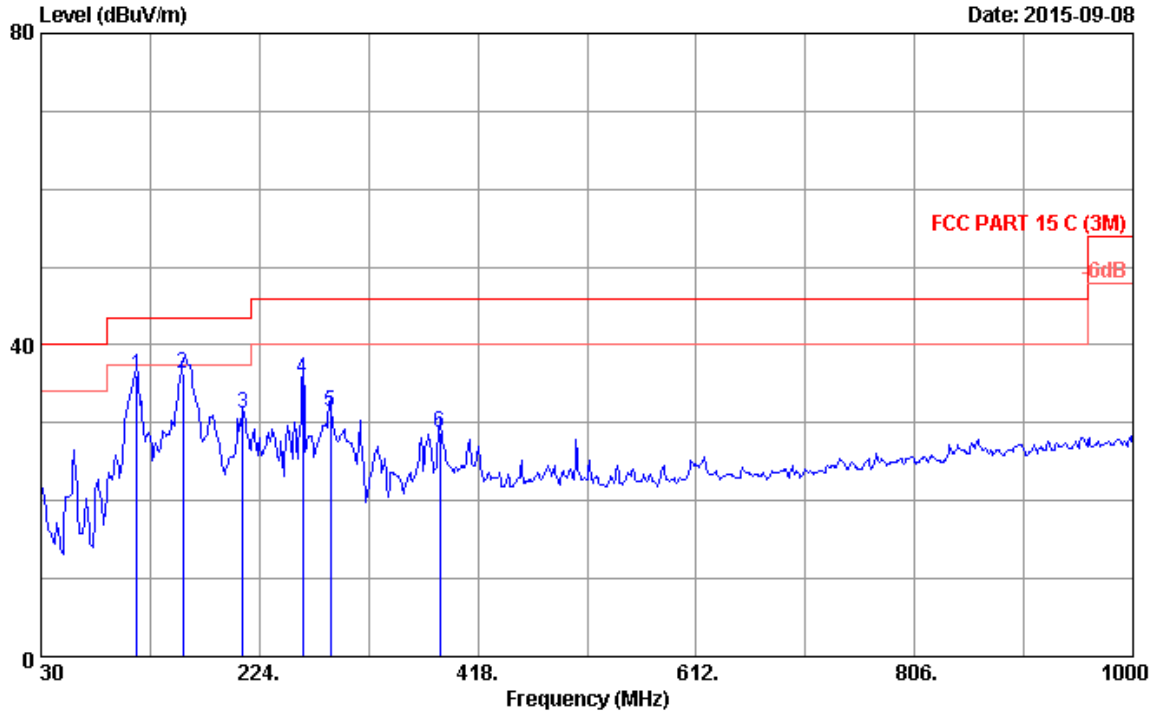

Site no. : 3m Chamber Data no. : 1  
 Dis. / Ant. : 3m 2015 CBL6112D 35375 Ant. pol. : HORIZONTAL  
 Limit : FCC PART 15 C (3M)  
 Env. / Ins. : 24°C/56% Engineer : Brown  
 EUT : Notebook M/N:RZ09-0168  
 Power rating : DC 20V From Adapter Input AC 120V/60Hz  
 Test Mode : Tx Mode

No.	Freq. (MHz)	Ant. Factor (dB/m)	Cable Loss (dB)	Reading (dBUV)	Emission Level (dBUV/m)	Limits (dBUV/m)	Margin (dB)	Remark
1	115.360	12.84	1.16	49.68	36.13	43.50	7.37	QP
2	156.100	11.49	1.32	51.00	36.41	43.50	7.09	QP
3	209.450	10.83	1.54	46.00	31.15	43.50	12.35	QP
4	262.800	14.36	1.76	46.60	35.69	46.00	10.31	QP
5	287.050	13.95	1.84	42.59	31.43	46.00	14.57	QP
6	384.050	16.32	2.16	37.44	28.67	46.00	17.33	QP

Remarks: 1. Emission Level= Antenna Factor + Cable Loss + Reading.  
 2. The emission levels that are 20dB below the official limit are not reported.

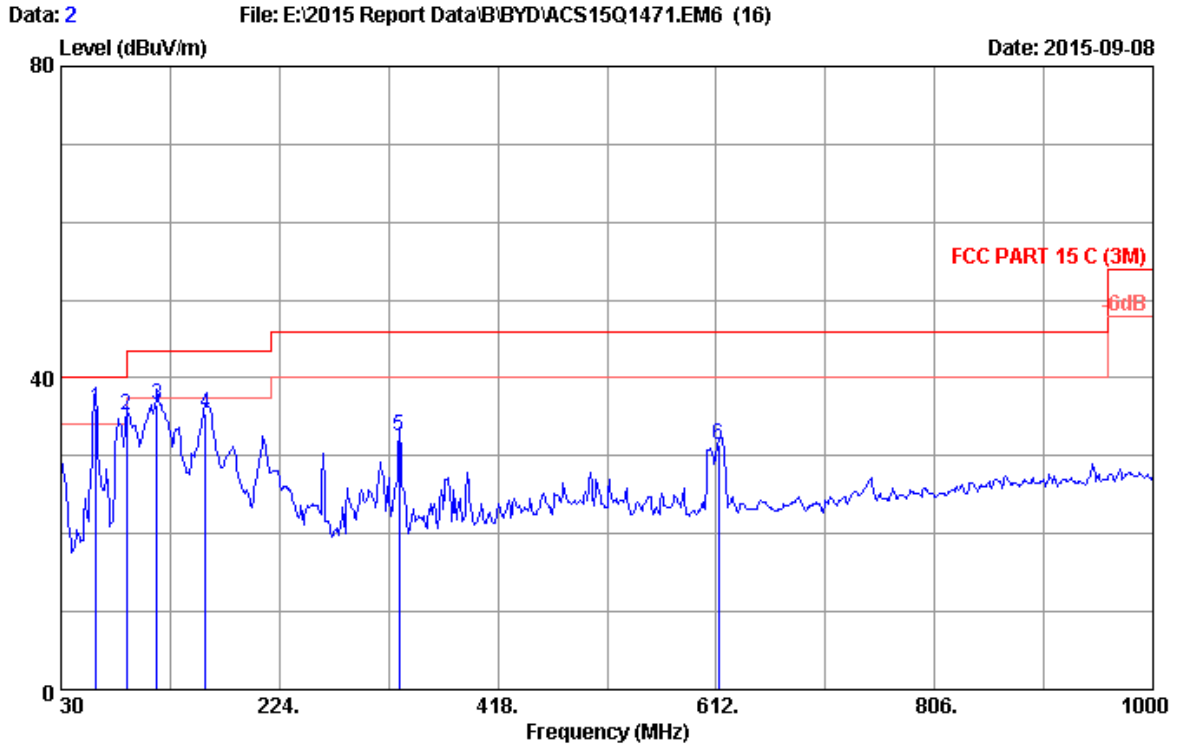

Site no. : 3m Chamber Data no. : 2  
 Dis. / Ant. : 3m 2015 CBL6112D 35375 Ant. pol. : VERTICAL  
 Limit : FCC PART 15 C (3M)  
 Env. / Ins. : 24°C/56% Engineer : Brown  
 EUT : Notebook M/N:RZ09-0168  
 Power rating : DC 20V From Adapter Input AC 120V/60Hz  
 Test Mode : Tx Mode

No.	Freq. (MHz)	Ant. Factor (dB/m)	Cable Loss (dB)	Reading (dBUV)	Emission Level (dBUV/m)	Limits (dBUV/m)	Margin (dB)	Remark
1	61.040	6.80	0.89	56.15	36.06	40.00	3.94	QP
2	88.200	9.36	1.06	52.49	35.25	43.50	8.25	QP
3	115.360	12.84	1.16	50.09	36.54	43.50	6.96	QP
4	158.040	11.40	1.35	50.11	35.47	43.50	8.03	QP
5	330.700	14.91	1.99	42.77	32.64	46.00	13.36	QP
6	613.940	19.58	2.81	37.11	31.40	46.00	14.60	QP

Remarks: 1. Emission Level= Antenna Factor + Cable Loss + Reading.  
 2. The emission levels that are 20dB below the official limit are not reported.







Site no. : 3m Chamber Data no. : 4  
 Dis. / Ant. : 3m 2014 3115 9607-4877 Ant. pol. : HORIZONTAL  
 Limit : FCC PART 15C PEAK  
 Env. / Ins. : 23°C/54%  
 Engineer : Alice\_yang  
 EUT : Notebook  
 Power rating : DC 20V From Adapter Input AC 120V/60Hz  
 Test Mode : GFSK 2402MHz Tx Mode  
 M/N : RZ09-0168

No.	Freq. (MHz)	Ant. Factor (dB/m)	Cable Loss (dB)	AMP factor (dB)	Reading (dBuV)	Emission Level (dBuV/m)	Limits (dBuV/m)	Margin (dB)	Remark
1	2402.000	28.26	7.32	36.62	89.21	88.17	74.00	-14.17	Peak
2	4804.000	33.02	9.46	35.54	44.29	51.23	74.00	22.77	Peak

Remarks: 1. Emission Level= Antenna Factor + Cable Loss + Reading - Amp Factor  
 2. The emission levels that are 20dB below the official limit are not reported.

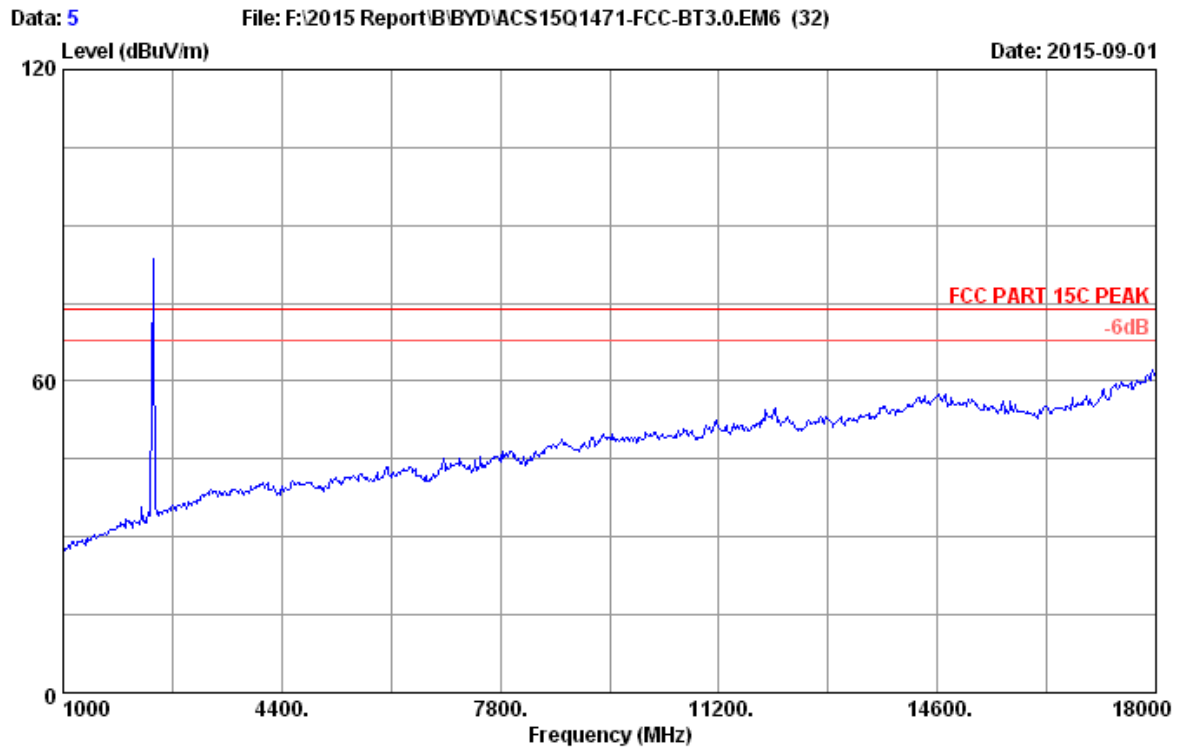

Site no. : 3m Chamber Data no. : 5  
Dis. / Ant. : 3m 2014 3115 9607-4877 Ant. pol. : VERTICAL  
Limit : FCC PART 15C PEAK  
Env. / Ins. : 23°C/54%  
Engineer : Alice\_yang  
EUT : Notebook  
Power rating : DC 20V From Adapter Input AC 120V/60Hz  
Test Mode : GFSK 2402MHz Tx Mode  
M/N : RZ09-0168

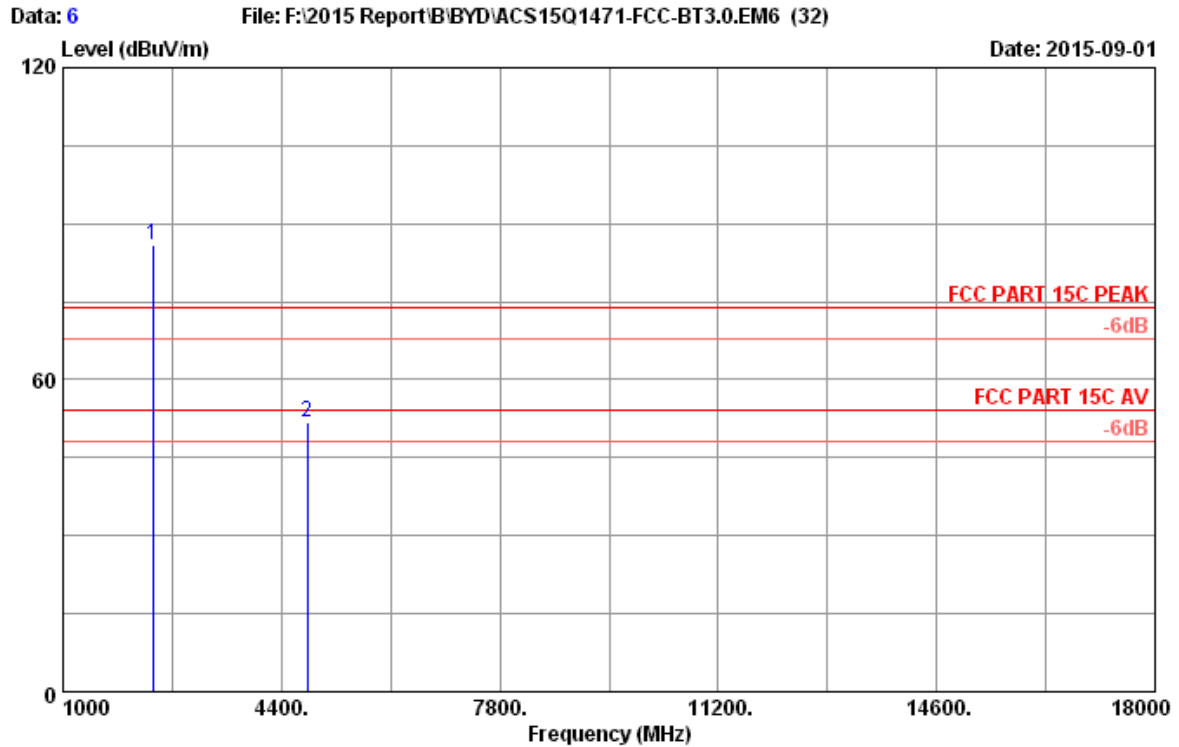

Site no. : 3m Chamber Data no. : 6  
 Dis. / Ant. : 3m 2014 3115 9607-4877 Ant. pol. : VERTICAL  
 Limit : FCC PART 15C PEAK  
 Env. / Ins. : 23°C/54%  
 Engineer : Alice\_yang  
 EUT : Notebook  
 Power rating : DC 20V From Adapter Input AC 120V/60Hz  
 Test Mode : GFSK 2402MHz Tx Mode  
 M/N : RZ09-0168

No.	Freq. (MHz)	Ant. Factor (dB/m)	Cable Loss (dB)	AMP factor (dB)	Reading (dBuV)	Emission Level (dBuV/m)	Limits (dBuV/m)	Margin (dB)	Remark
1	2402.000	28.26	7.32	36.62	86.80	85.76	74.00	-11.76	Peak
2	4804.000	33.02	9.46	35.54	44.78	51.72	74.00	22.28	Peak

Remarks: 1. Emission Level= Antenna Factor + Cable Loss + Reading -Amp Factor  
 2. The emission levels that are 20dB below the official limit are not reported.

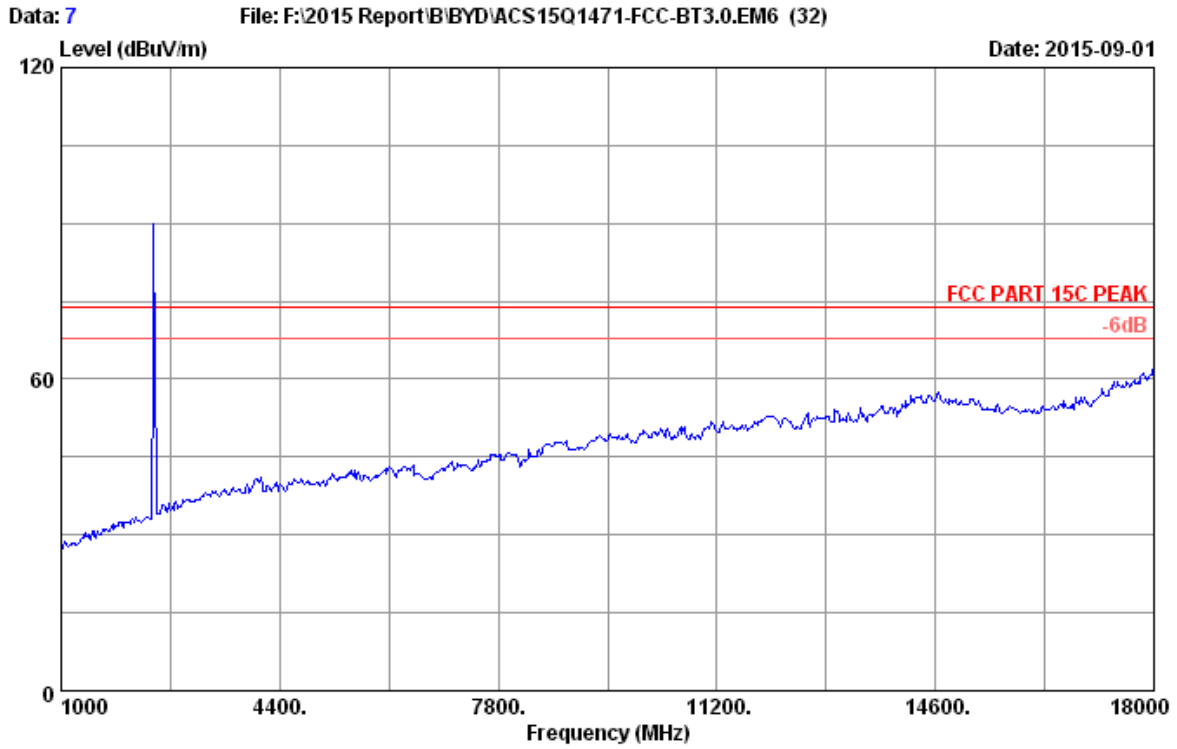

Site no. : 3m Chamber Data no. : 7  
Dis. / Ant. : 3m 2014 3115 9607-4877 Ant. pol. : HORIZONTAL  
Limit : FCC PART 15C PEAK  
Env. / Ins. : 23°C/54%  
Engineer : Alice\_yang  
EUT : Notebook  
Power rating : DC 20V From Adapter Input AC 120V/60Hz  
Test Mode : GFSK 2441MHz Tx Mode  
M/N : RZ09-0168

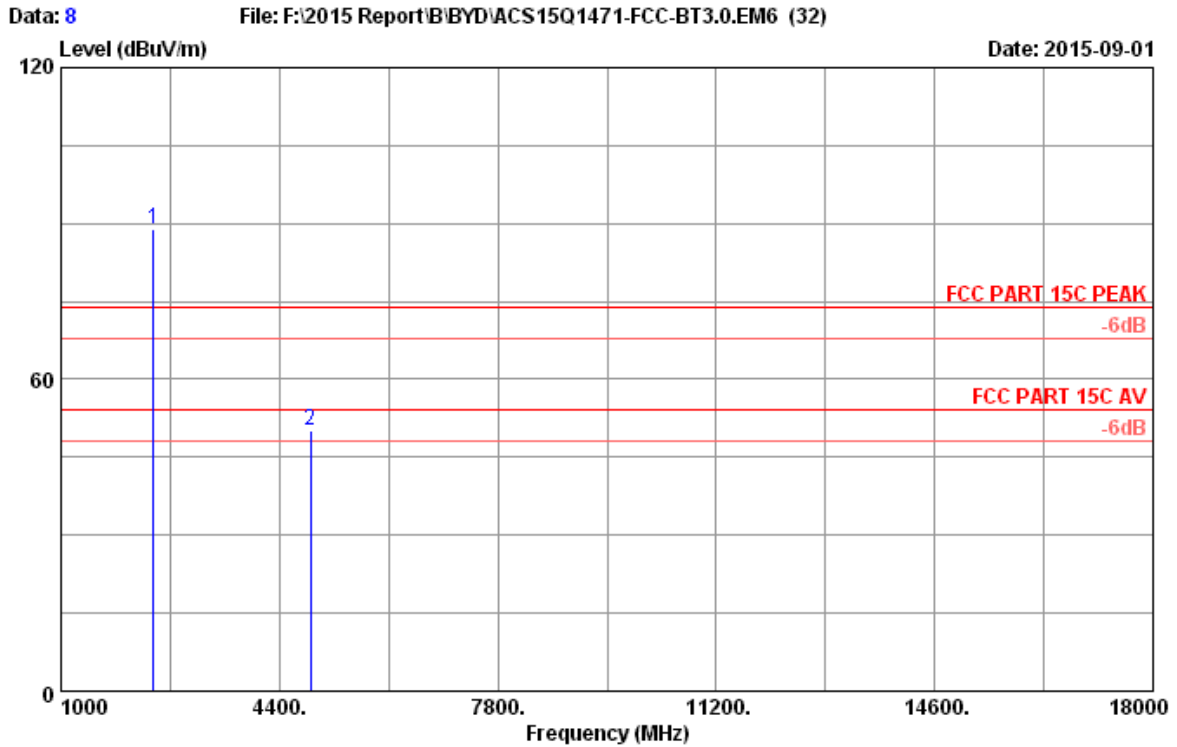

Site no. : 3m Chamber Data no. : 8  
 Dis. / Ant. : 3m 2014 3115 9607-4877 Ant. pol. : HORIZONTAL  
 Limit : FCC PART 15C PEAK  
 Env. / Ins. : 23°C/54%  
 Engineer : Alice\_yang  
 EUT : Notebook  
 Power rating : DC 20V From Adapter Input AC 120V/60Hz  
 Test Mode : GFSK 2441MHz Tx Mode  
 M/N : RZ09-0168

No.	Freq. (MHz)	Ant. Factor (dB/m)	Cable Loss (dB)	AMP factor (dB)	Reading (dBuV)	Emission Level (dBuV/m)	Limits (dBuV/m)	Margin (dB)	Remark
1	2441.000	28.31	7.39	36.60	89.88	88.98	74.00	-14.98	Peak
2	4882.000	33.17	9.49	35.51	42.98	50.13	74.00	23.87	Peak

Remarks: 1. Emission Level= Antenna Factor + Cable Loss + Reading -Amp Factor  
 2. The emission levels that are 20dB below the official limit are not reported.



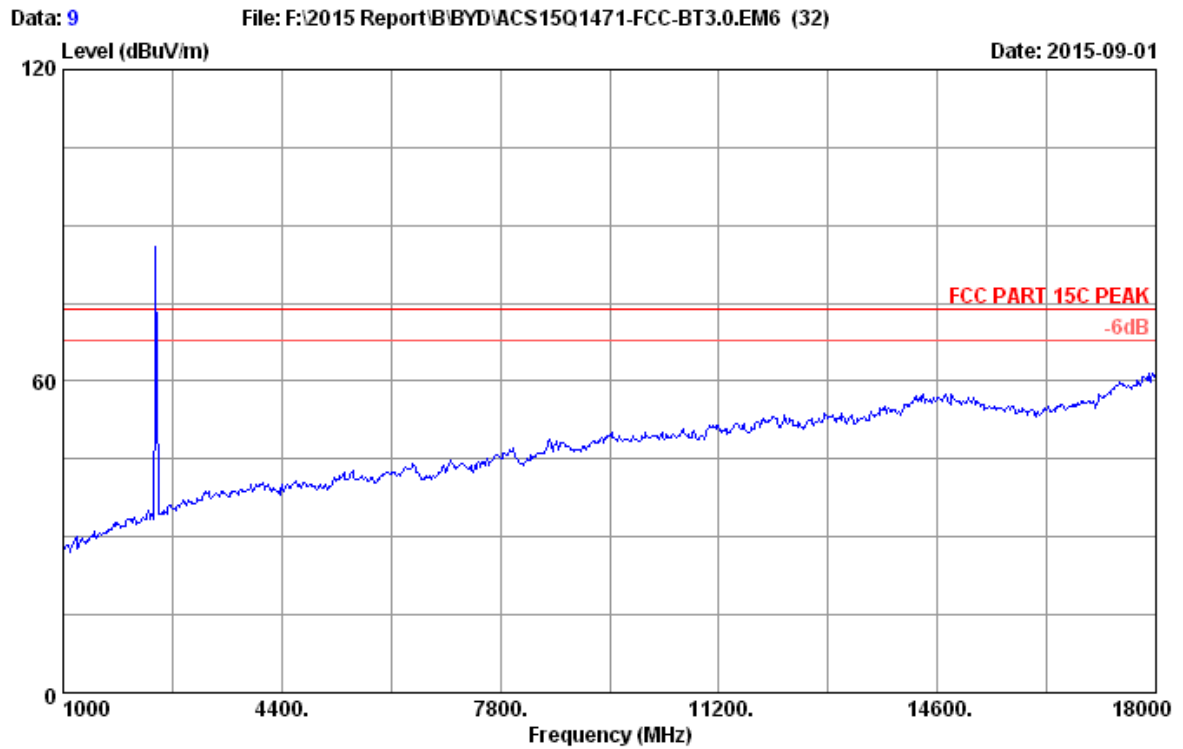

Site no. : 3m Chamber Data no. : 9  
Dis. / Ant. : 3m 2014 3115 9607-4877 Ant. pol. : VERTICAL  
Limit : FCC PART 15C PEAK  
Env. / Ins. : 23°C/54%  
Engineer : Alice\_yang  
EUT : Notebook  
Power rating : DC 20V From Adapter Input AC 120V/60Hz  
Test Mode : GFSK 2441MHz Tx Mode  
M/N : RZ09-0168

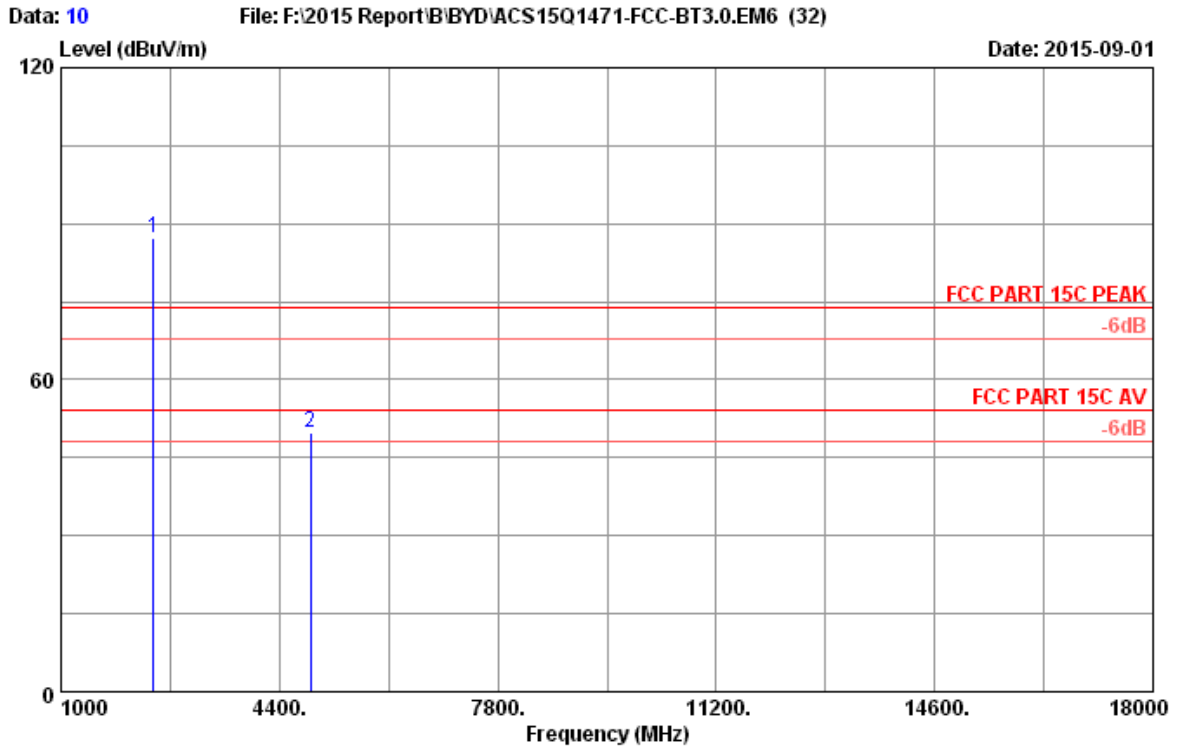

Site no. : 3m Chamber Data no. : 10  
 Dis. / Ant. : 3m 2014 3115 9607-4877 Ant. pol. : VERTICAL  
 Limit : FCC PART 15C PEAK  
 Env. / Ins. : 23°C/54%  
 Engineer : Alice\_yang  
 EUT : Notebook  
 Power rating : DC 20V From Adapter Input AC 120V/60Hz  
 Test Mode : GFSK 2441MHz Tx Mode  
 M/N : RZ09-0168

No.	Freq. (MHz)	Ant. Factor (dB/m)	Cable Loss (dB)	AMP factor (dB)	Reading (dBuV)	Emission Level (dBuV/m)	Limits (dBuV/m)	Margin (dB)	Remark
1	2441.000	28.31	7.39	36.60	88.27	87.37	74.00	-13.37	Peak
2	4882.000	33.17	9.49	35.51	42.82	49.97	74.00	24.03	Peak

Remarks: 1. Emission Level= Antenna Factor + Cable Loss + Reading -Amp Factor  
 2. The emission levels that are 20dB below the official limit are not reported.

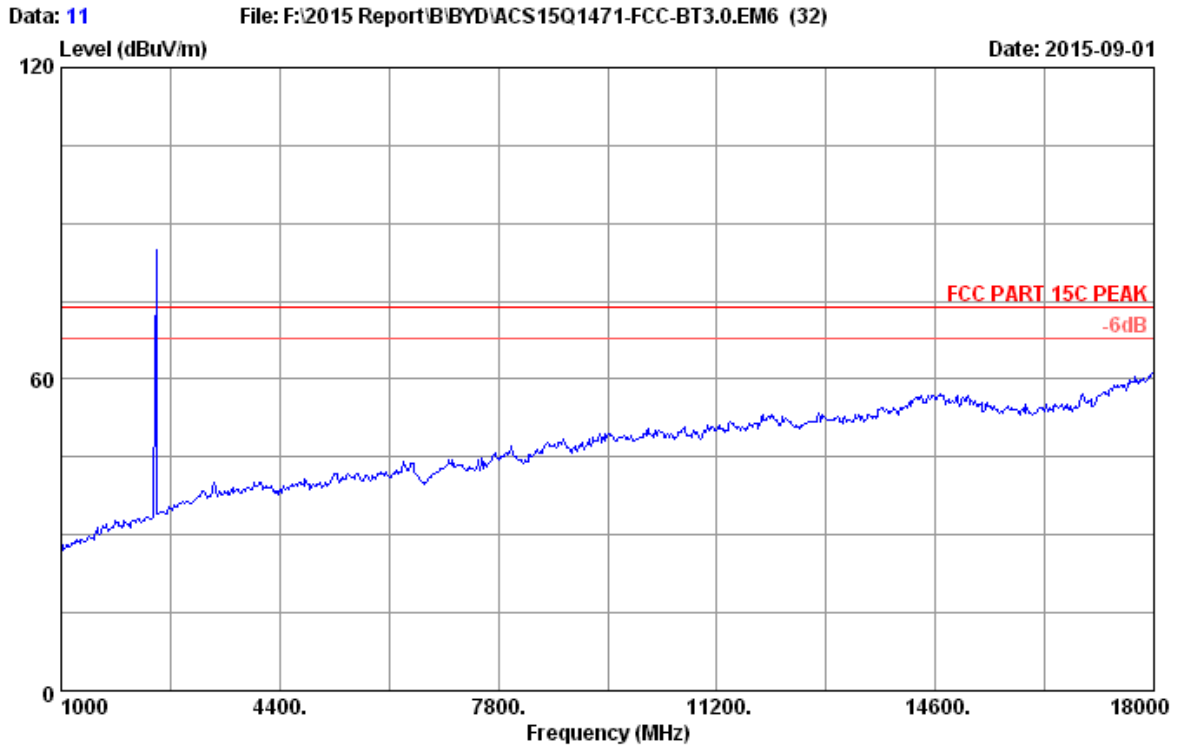

Site no. : 3m Chamber Data no. : 11  
Dis. / Ant. : 3m 2014 3115 9607-4877 Ant. pol. : VERTICAL  
Limit : FCC PART 15C PEAK  
Env. / Ins. : 23°C/54%  
Engineer : Alice\_yang  
EUT : Notebook  
Power rating : DC 20V From Adapter Input AC 120V/60Hz  
Test Mode : GFSK 2480MHz Tx Mode  
M/N : RZ09-0168

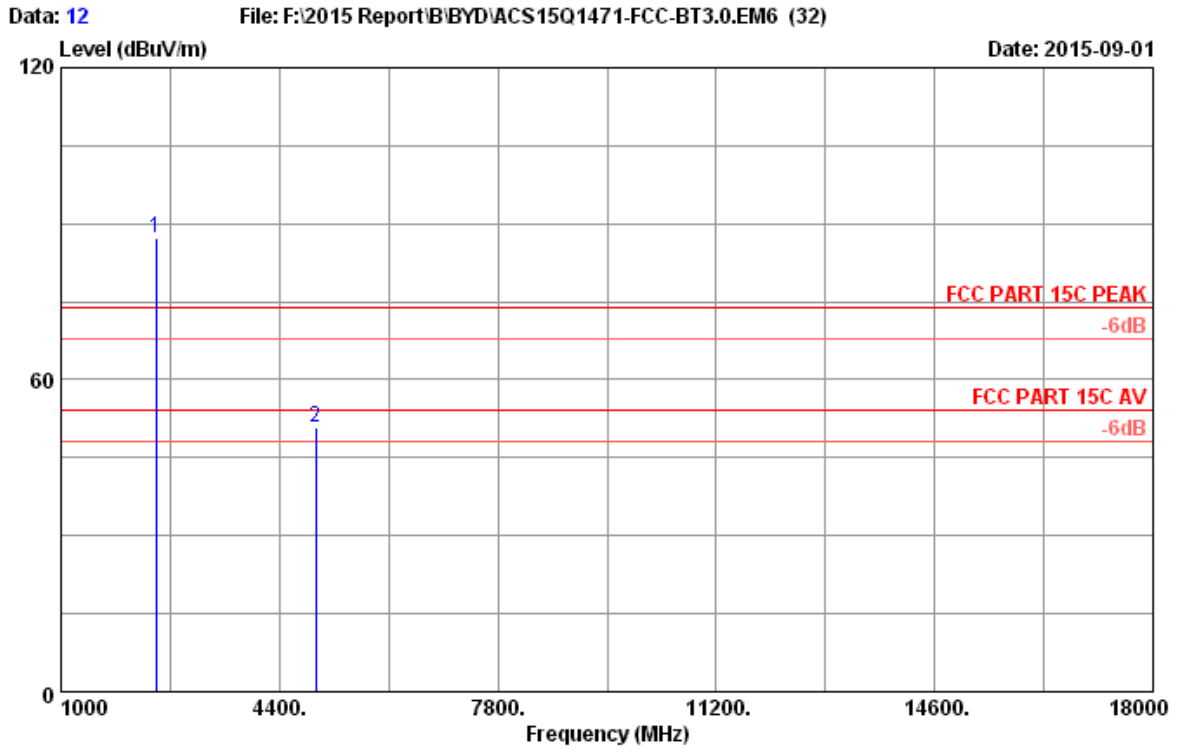

Site no. : 3m Chamber Data no. : 12  
 Dis. / Ant. : 3m 2014 3115 9607-4877 Ant. pol. : VERTICAL  
 Limit : FCC PART 15C PEAK  
 Env. / Ins. : 23°C/54%  
 Engineer : Alice\_yang  
 EUT : Notebook  
 Power rating : DC 20V From Adapter Input AC 120V/60Hz  
 Test Mode : GFSK 2480MHz Tx Mode  
 M/N : RZ09-0168

No.	Freq. (MHz)	Ant. Factor (dB/m)	Cable Loss (dB)	AMP factor (dB)	Reading (dBuV)	Emission Level (dBuV/m)	Limits (dBuV/m)	Margin (dB)	Remark
1	2480.000	28.37	7.47	36.59	88.10	87.35	74.00	-13.35	Peak
2	4960.000	33.32	9.52	35.47	43.28	50.65	74.00	23.35	Peak

Remarks: 1. Emission Level= Antenna Factor + Cable Loss + Reading - Amp Factor  
 2. The emission levels that are 20dB below the official limit are not reported.

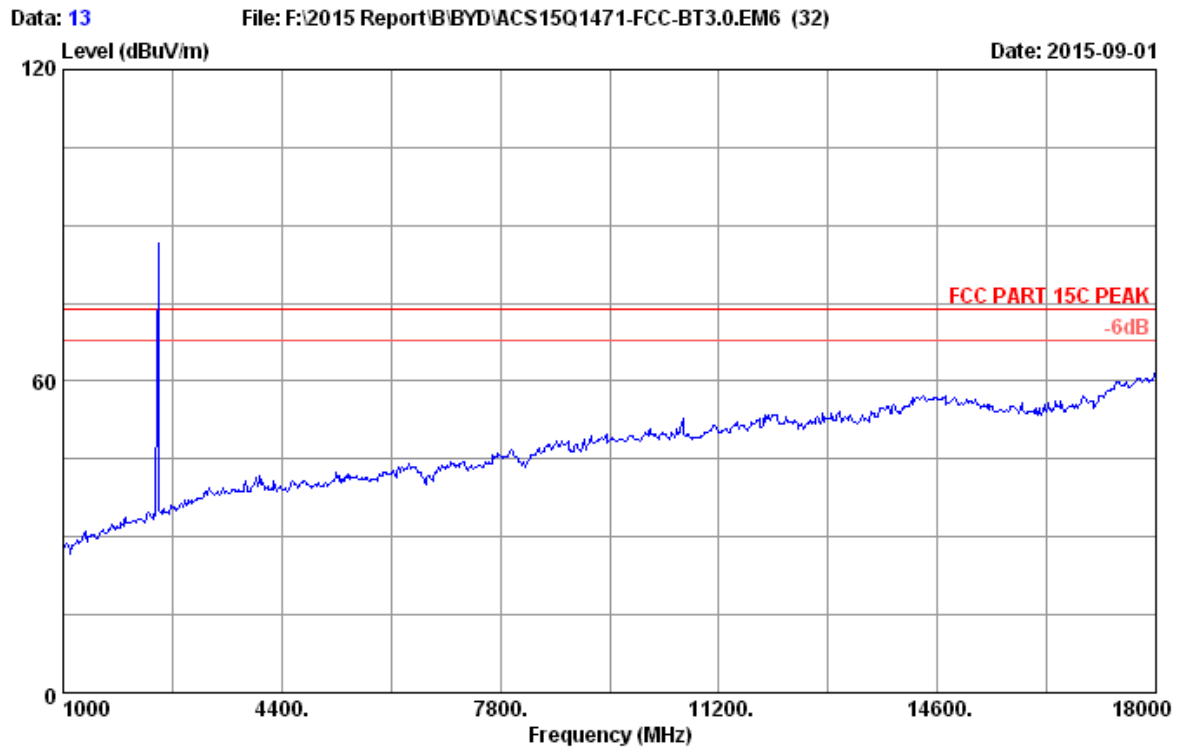

Site no. : 3m Chamber Data no. : 13  
Dis. / Ant. : 3m 2014 3115 9607-4877 Ant. pol. : HORIZONTAL  
Limit : FCC PART 15C PEAK  
Env. / Ins. : 23°C/54%  
Engineer : Alice\_yang  
EUT : Notebook  
Power rating : DC 20V From Adapter Input AC 120V/60Hz  
Test Mode : GFSK 2480MHz Tx Mode  
M/N : RZ09-0168

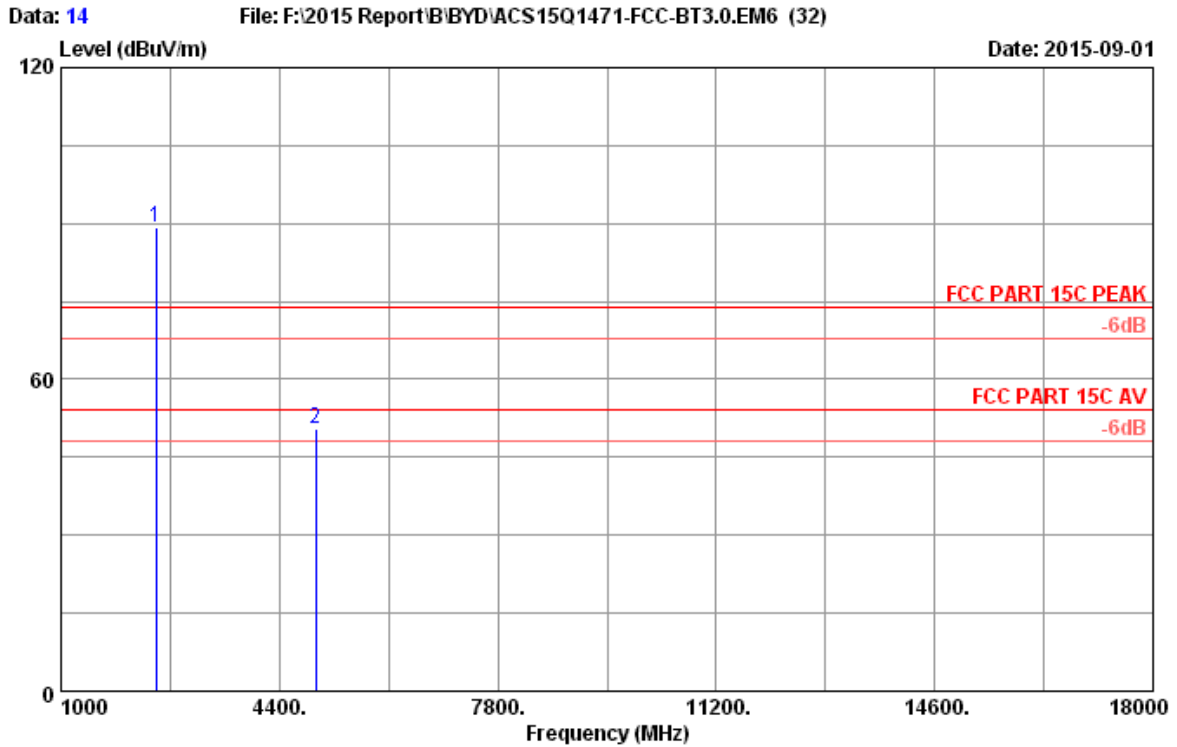

Site no. : 3m Chamber Data no. : 14  
 Dis. / Ant. : 3m 2014 3115 9607-4877 Ant. pol. : HORIZONTAL  
 Limit : FCC PART 15C PEAK  
 Env. / Ins. : 23°C/54%  
 Engineer : Alice\_yang  
 EUT : Notebook  
 Power rating : DC 20V From Adapter Input AC 120V/60Hz  
 Test Mode : GFSK 2480MHz Tx Mode  
 M/N : RZ09-0168

No.	Freq. (MHz)	Ant. Factor (dB/m)	Cable Loss (dB)	AMP factor (dB)	Reading (dBuV)	Emission Level (dBuV/m)	Limits (dBuV/m)	Margin (dB)	Remark
1	2480.000	28.37	7.47	36.59	90.16	89.41	74.00	-15.41	Peak
2	4960.000	33.32	9.52	35.47	43.17	50.54	74.00	23.46	Peak

Remarks: 1. Emission Level= Antenna Factor + Cable Loss + Reading - Amp Factor  
 2. The emission levels that are 20dB below the official limit are not reported.

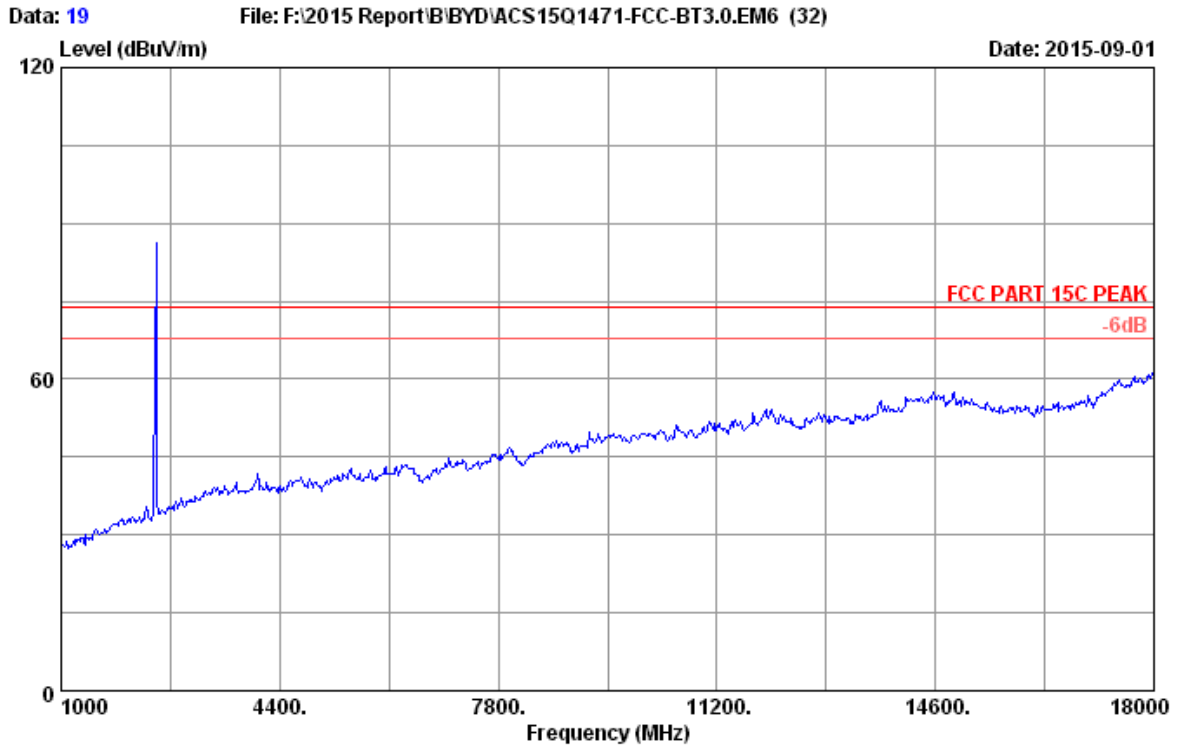

Site no. : 3m Chamber Data no. : 19  
Dis. / Ant. : 3m 2014 3115 9607-4877 Ant. pol. : HORIZONTAL  
Limit : FCC PART 15C PEAK  
Env. / Ins. : 23°C/54%  
Engineer : Alice\_yang  
EUT : Notebook  
Power rating : DC 20V From Adapter Input AC 120V/60Hz  
Test Mode : 8-DPSK 2480MHz Tx Mode  
M/N : RZ09-0168

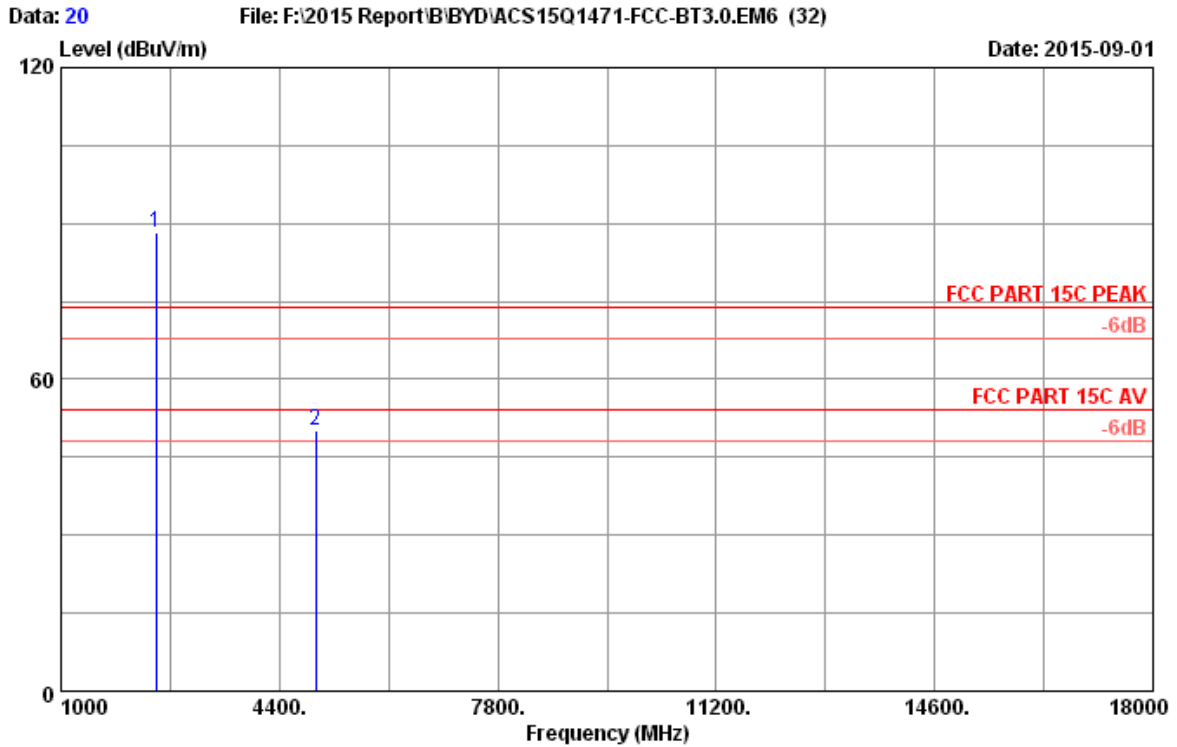

Site no. : 3m Chamber Data no. : 20  
 Dis. / Ant. : 3m 2014 3115 9607-4877 Ant. pol. : HORIZONTAL  
 Limit : FCC PART 15C PEAK  
 Env. / Ins. : 23°C/54%  
 Engineer : Alice\_yang  
 EUT : Notebook  
 Power rating : DC 20V From Adapter Input AC 120V/60Hz  
 Test Mode : 8-DPSK 2480MHz Tx Mode  
 M/N : RZ09-0168

No.	Freq. (MHz)	Ant. Factor (dB/m)	Cable Loss (dB)	AMP factor (dB)	Reading (dBuV)	Emission Level (dBuV/m)	Limits (dBuV/m)	Margin (dB)	Remark
1	2480.000	28.37	7.47	36.59	89.05	88.30	74.00	-14.30	Peak
2	4960.000	33.32	9.52	35.47	42.77	50.14	74.00	23.86	Peak

Remarks: 1. Emission Level= Antenna Factor + Cable Loss + Reading - Amp Factor  
 2. The emission levels that are 20dB below the official limit are not reported.



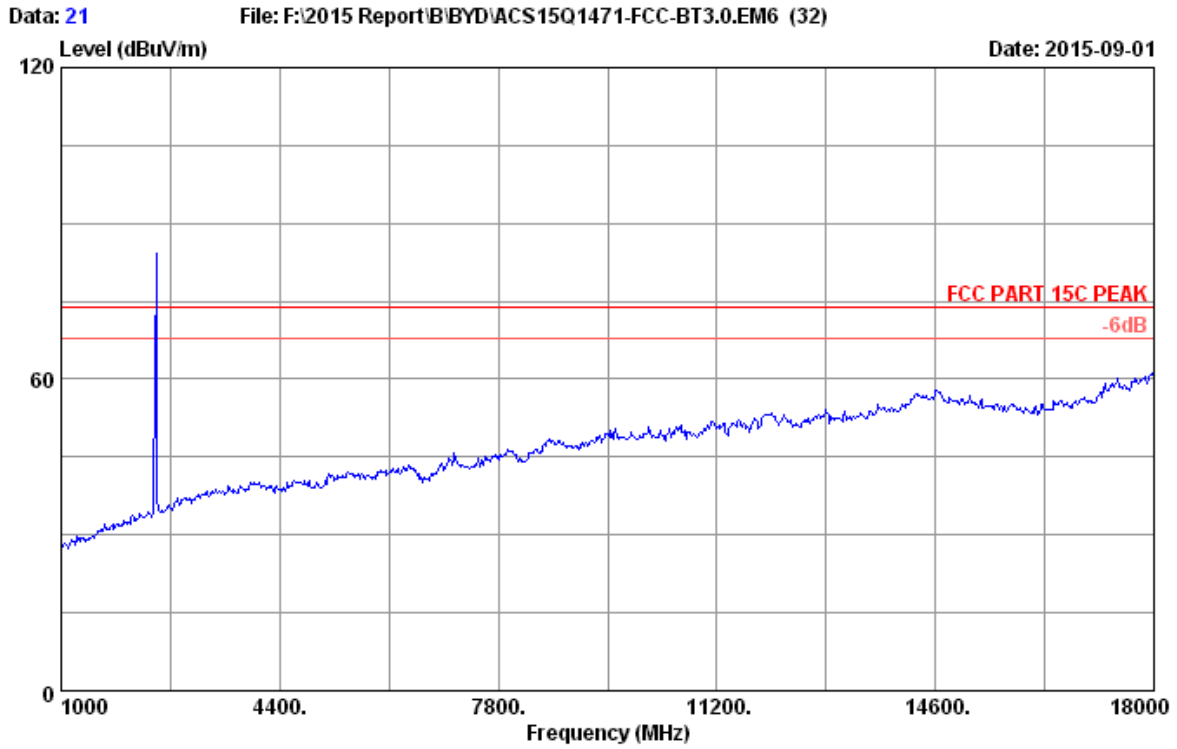

Site no. : 3m Chamber Data no. : 21  
Dis. / Ant. : 3m 2014 3115 9607-4877 Ant. pol. : VERTICAL  
Limit : FCC PART 15C PEAK  
Env. / Ins. : 23°C/54%  
Engineer : Alice\_yang  
EUT : Notebook  
Power rating : DC 20V From Adapter Input AC 120V/60Hz  
Test Mode : 8-DPSK 2480MHz Tx Mode  
M/N : RZ09-0168

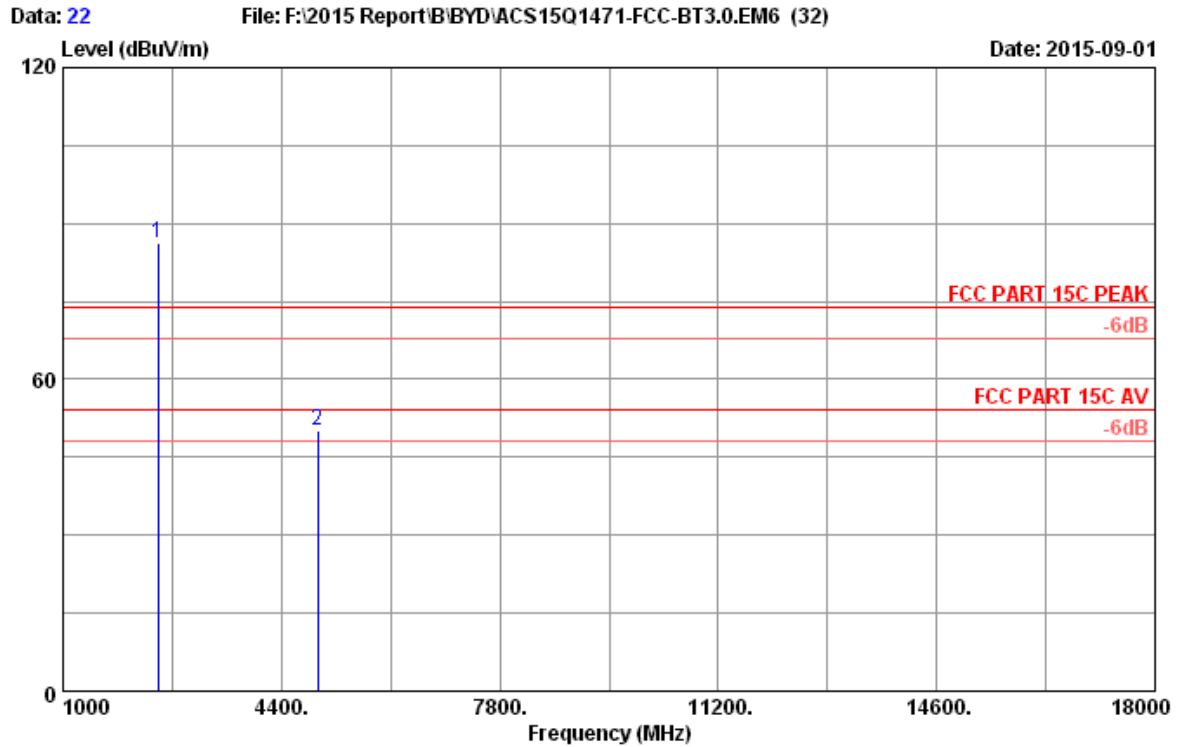

Site no. : 3m Chamber Data no. : 22  
 Dis. / Ant. : 3m 2014 3115 9607-4877 Ant. pol. : VERTICAL  
 Limit : FCC PART 15C PEAK  
 Env. / Ins. : 23°C/54%  
 Engineer : Alice\_yang  
 EUT : Notebook  
 Power rating : DC 20V From Adapter Input AC 120V/60Hz  
 Test Mode : 8-DPSK 2480MHz Tx Mode  
 M/N : RZ09-0168

No.	Freq. (MHz)	Ant. Factor (dB/m)	Cable Loss (dB)	AMP factor (dB)	Reading (dBuV)	Emission Level (dBuV/m)	Limits (dBuV/m)	Margin (dB)	Remark
1	2480.000	28.37	7.47	36.59	86.95	86.20	74.00	-12.20	Peak
2	4960.000	33.32	9.52	35.47	42.88	50.25	74.00	23.75	Peak

Remarks: 1. Emission Level= Antenna Factor + Cable Loss + Reading - Amp Factor  
 2. The emission levels that are 20dB below the official limit are not reported.

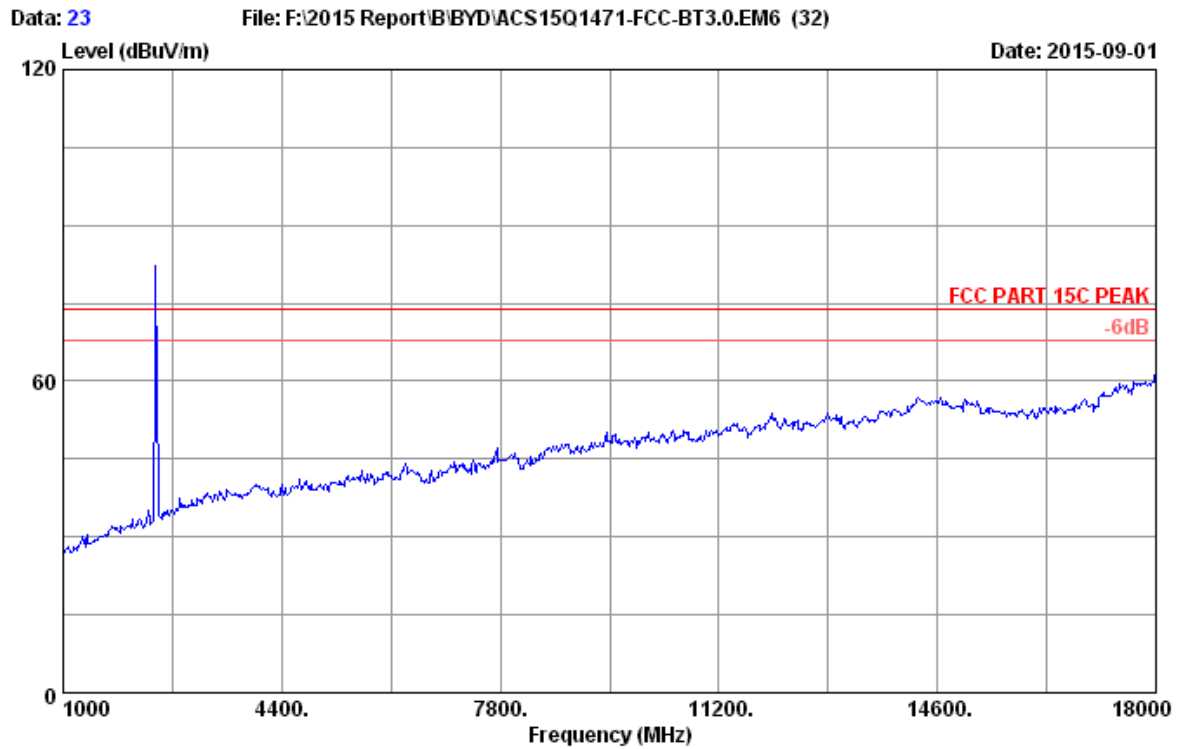

Site no. : 3m Chamber Data no. : 23  
Dis. / Ant. : 3m 2014 3115 9607-4877 Ant. pol. : VERTICAL  
Limit : FCC PART 15C PEAK  
Env. / Ins. : 23°C/54%  
Engineer : Alice\_yang  
EUT : Notebook  
Power rating : DC 20V From Adapter Input AC 120V/60Hz  
Test Mode : 8-DPSK 2441MHz Tx Mode  
M/N : RZ09-0168

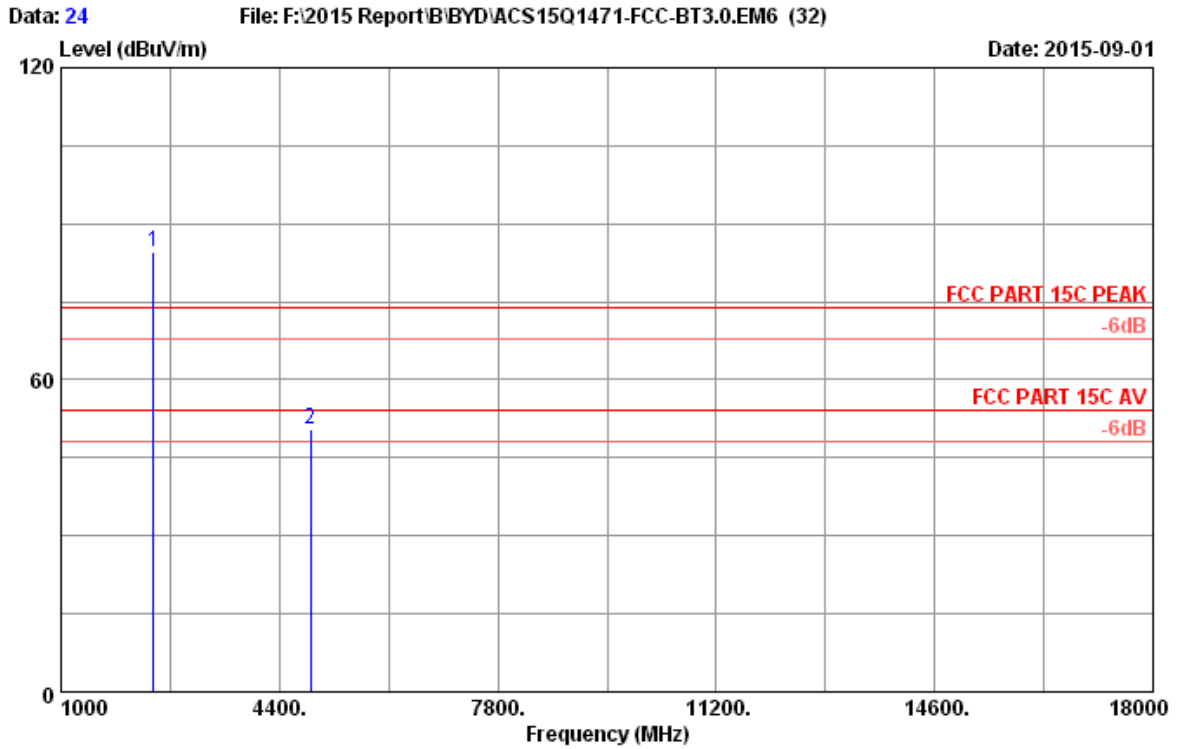

Site no. : 3m Chamber Data no. : 24  
 Dis. / Ant. : 3m 2014 3115 9607-4877 Ant. pol. : VERTICAL  
 Limit : FCC PART 15C PEAK  
 Env. / Ins. : 23°C/54%  
 Engineer : Alice\_yang  
 EUT : Notebook  
 Power rating : DC 20V From Adapter Input AC 120V/60Hz  
 Test Mode : 8-DPSK 2441MHz Tx Mode  
 M/N : RZ09-0168

No.	Freq. (MHz)	Ant. Factor (dB/m)	Cable Loss (dB)	AMP factor (dB)	Reading (dBuV)	Emission Level (dBuV/m)	Limits (dBuV/m)	Margin (dB)	Remark
1	2441.000	28.31	7.39	36.60	85.47	84.57	74.00	-10.57	Peak
2	4882.000	33.17	9.49	35.51	43.18	50.33	74.00	23.67	Peak

Remarks: 1. Emission Level= Antenna Factor + Cable Loss + Reading -Amp Factor  
 2. The emission levels that are 20dB below the official limit are not reported.

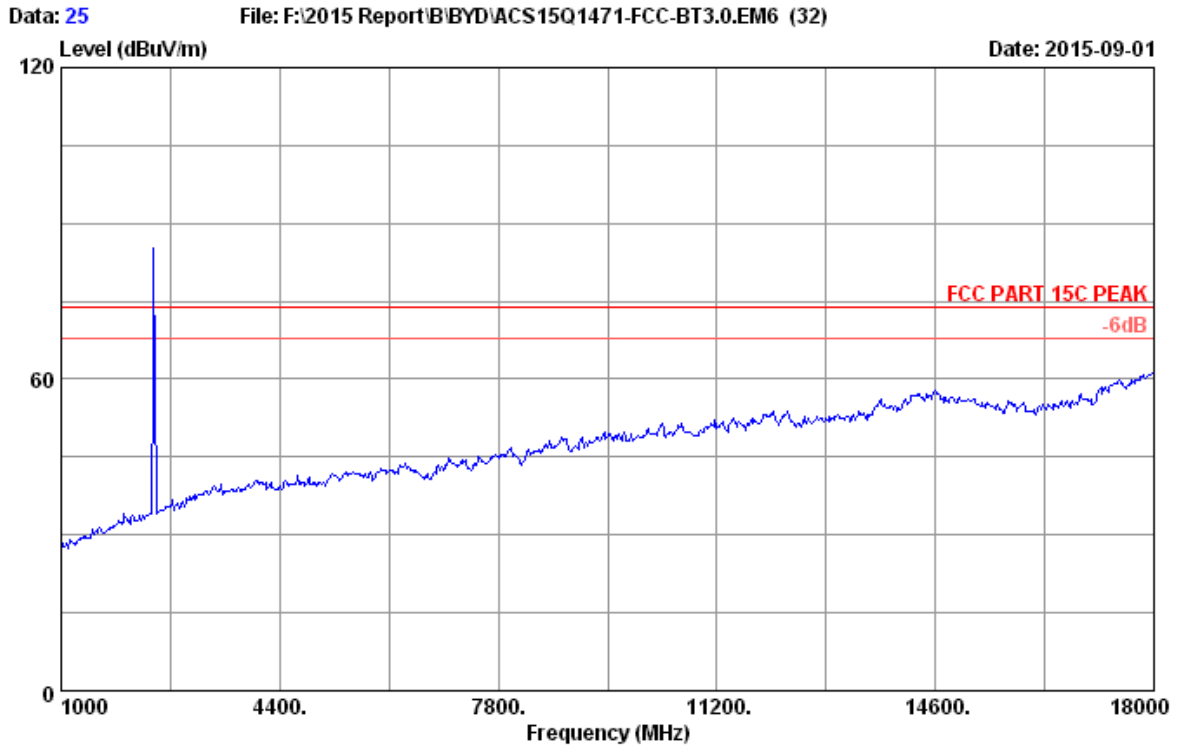

Site no. : 3m Chamber Data no. : 25  
Dis. / Ant. : 3m 2014 3115 9607-4877 Ant. pol. : HORIZONTAL  
Limit : FCC PART 15C PEAK  
Env. / Ins. : 23°C/54%  
Engineer : Alice\_yang  
EUT : Notebook  
Power rating : DC 20V From Adapter Input AC 120V/60Hz  
Test Mode : 8-DPSK 2441MHz Tx Mode  
M/N : RZ09-0168

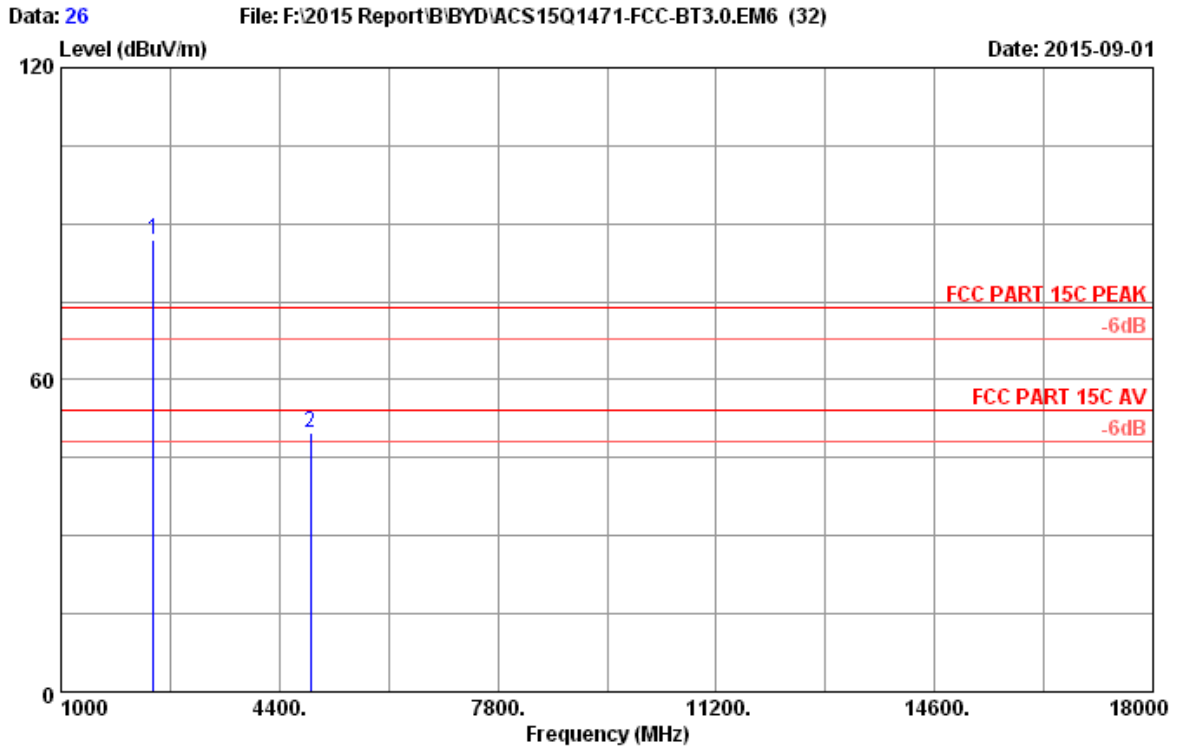

Site no. : 3m Chamber Data no. : 26  
 Dis. / Ant. : 3m 2014 3115 9607-4877 Ant. pol. : HORIZONTAL  
 Limit : FCC PART 15C PEAK  
 Env. / Ins. : 23°C/54%  
 Engineer : Alice\_yang  
 EUT : Notebook  
 Power rating : DC 20V From Adapter Input AC 120V/60Hz  
 Test Mode : 8-DPSK 2441MHz Tx Mode  
 M/N : RZ09-0168

No.	Freq. (MHz)	Ant. Factor (dB/m)	Cable Loss (dB)	AMP factor (dB)	Reading (dBuV)	Emission Level (dBuV/m)	Limits (dBuV/m)	Margin (dB)	Remark
1	2441.000	28.31	7.39	36.60	87.93	87.03	74.00	-13.03	Peak
2	4882.000	33.17	9.49	35.51	42.70	49.85	49.85	24.15	Peak

Remarks: 1. Emission Level= Antenna Factor + Cable Loss + Reading - Amp Factor  
 2. The emission levels that are 20dB below the official limit are not reported.

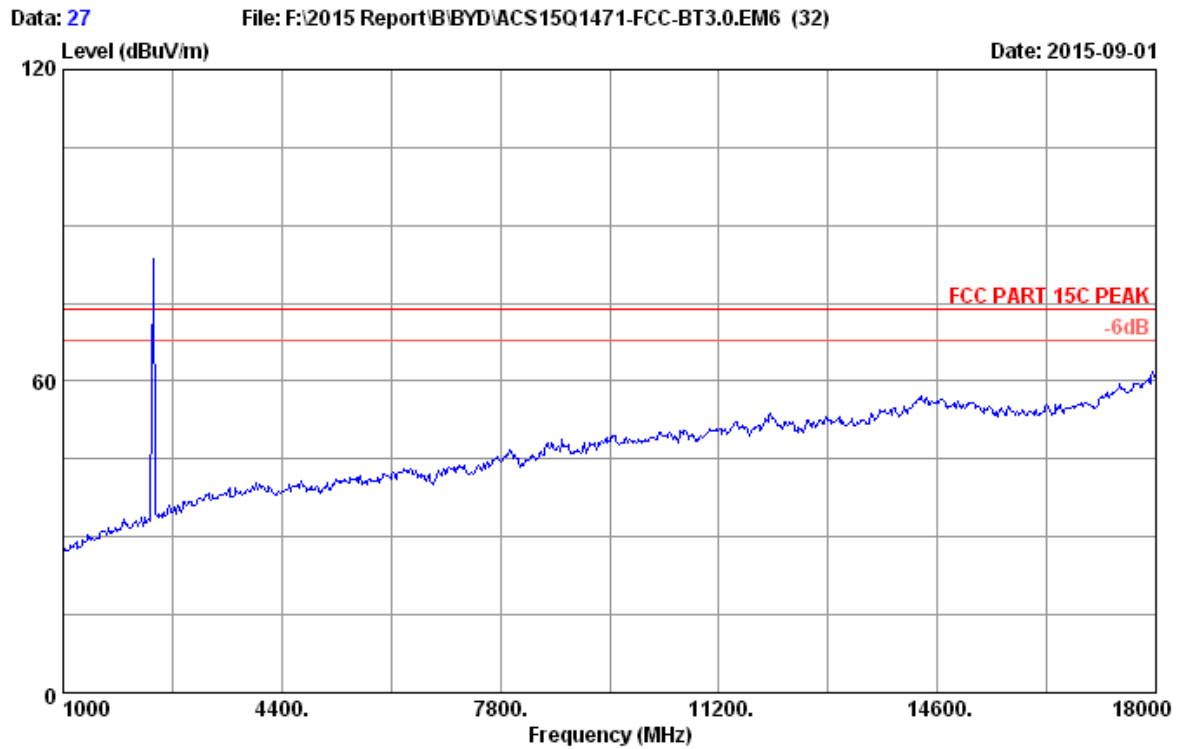

Site no. : 3m Chamber Data no. : 27  
Dis. / Ant. : 3m 2014 3115 9607-4877 Ant. pol. : HORIZONTAL  
Limit : FCC PART 15C PEAK  
Env. / Ins. : 23°C/54%  
Engineer : Alice\_yang  
EUT : Notebook  
Power rating : DC 20V From Adapter Input AC 120V/60Hz  
Test Mode : 8-DPSK 2402MHz Tx Mode  
M/N : RZ09-0168

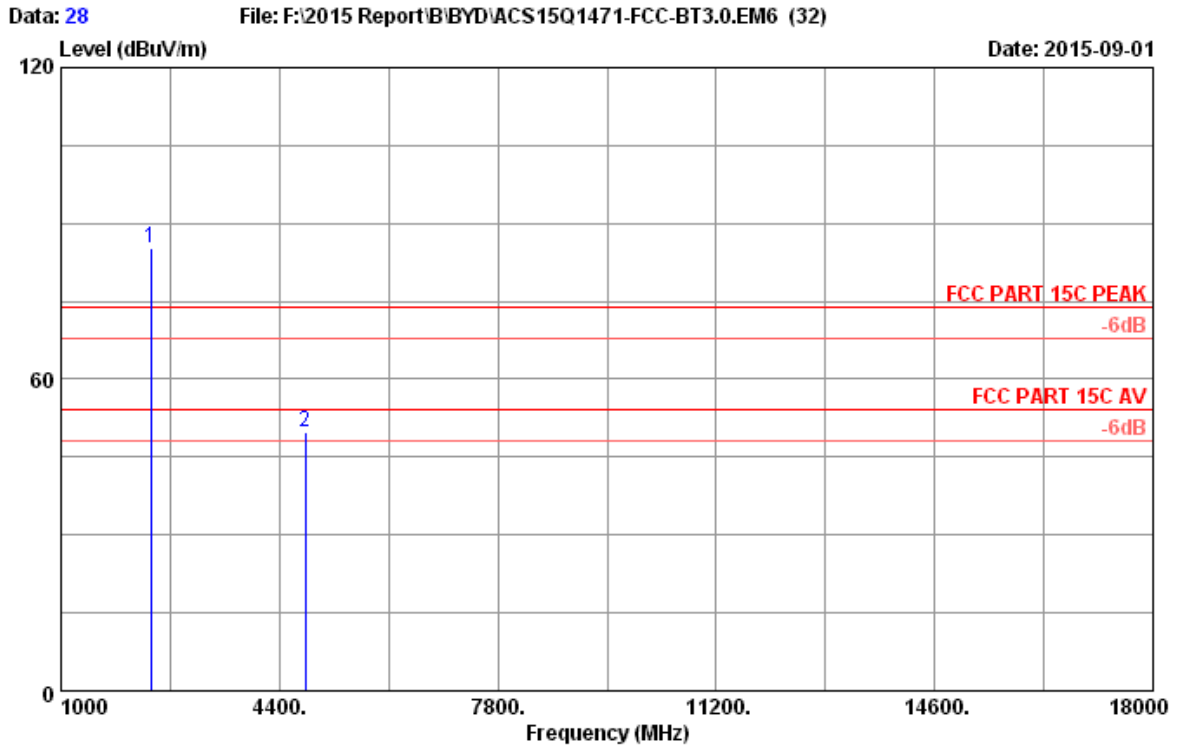

Site no. : 3m Chamber Data no. : 28  
 Dis. / Ant. : 3m 2014 3115 9607-4877 Ant. pol. : HORIZONTAL  
 Limit : FCC PART 15C PEAK  
 Env. / Ins. : 23°C/54%  
 Engineer : Alice\_yang  
 EUT : Notebook  
 Power rating : DC 20V From Adapter Input AC 120V/60Hz  
 Test Mode : 8-DPSK 2402MHz Tx Mode  
 M/N : RZ09-0168

No.	Freq. (MHz)	Ant. Factor (dB/m)	Cable Loss (dB)	AMP factor (dB)	Reading (dBuV)	Emission			Remark
						Level (dBuV/m)	Limits (dBuV/m)	Margin (dB)	
1	2402.000	28.26	7.32	36.62	86.44	85.40	74.00	-11.40	Peak
2	4804.000	33.02	9.46	35.54	42.76	49.70	74.00	24.30	Peak

Remarks: 1. Emission Level= Antenna Factor + Cable Loss + Reading - Amp Factor  
 2. The emission levels that are 20dB below the official limit are not reported.



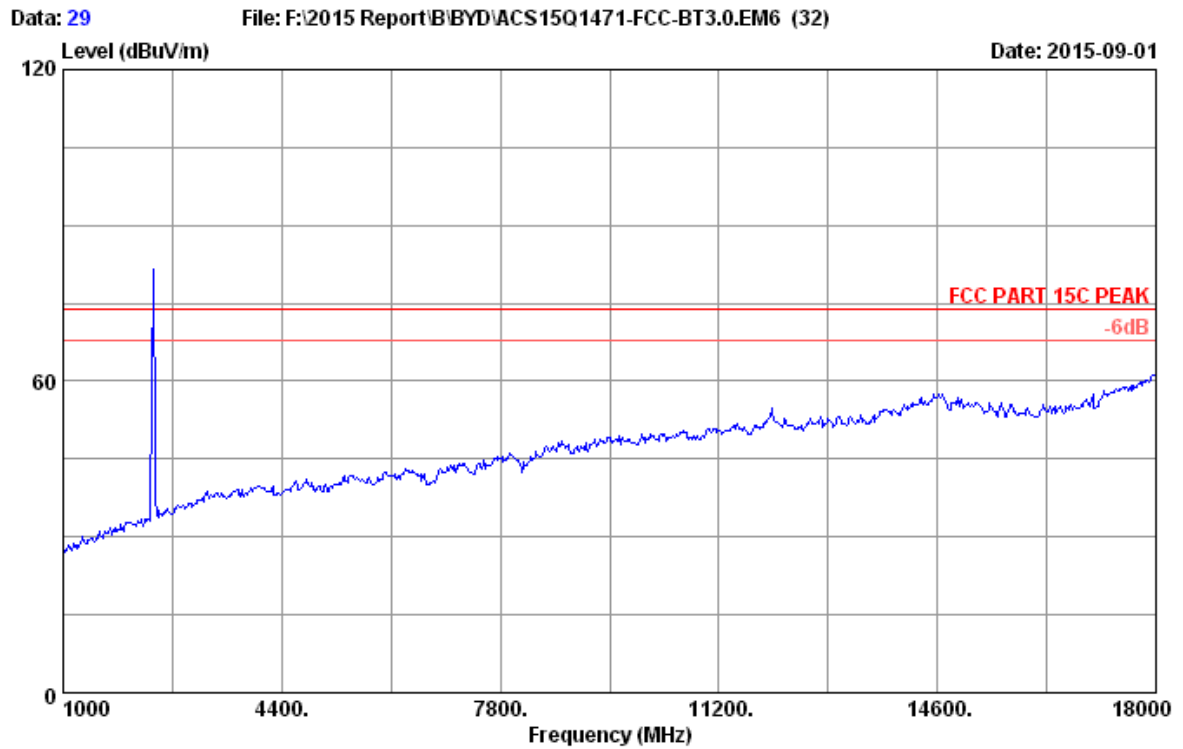

Site no. : 3m Chamber Data no. : 29  
Dis. / Ant. : 3m 2014 3115 9607-4877 Ant. pol. : VERTICAL  
Limit : FCC PART 15C PEAK  
Env. / Ins. : 23°C/54%  
Engineer : Alice\_yang  
EUT : Notebook  
Power rating : DC 20V From Adapter Input AC 120V/60Hz  
Test Mode : 8-DPSK 2402MHz Tx Mode  
M/N : RZ09-0168

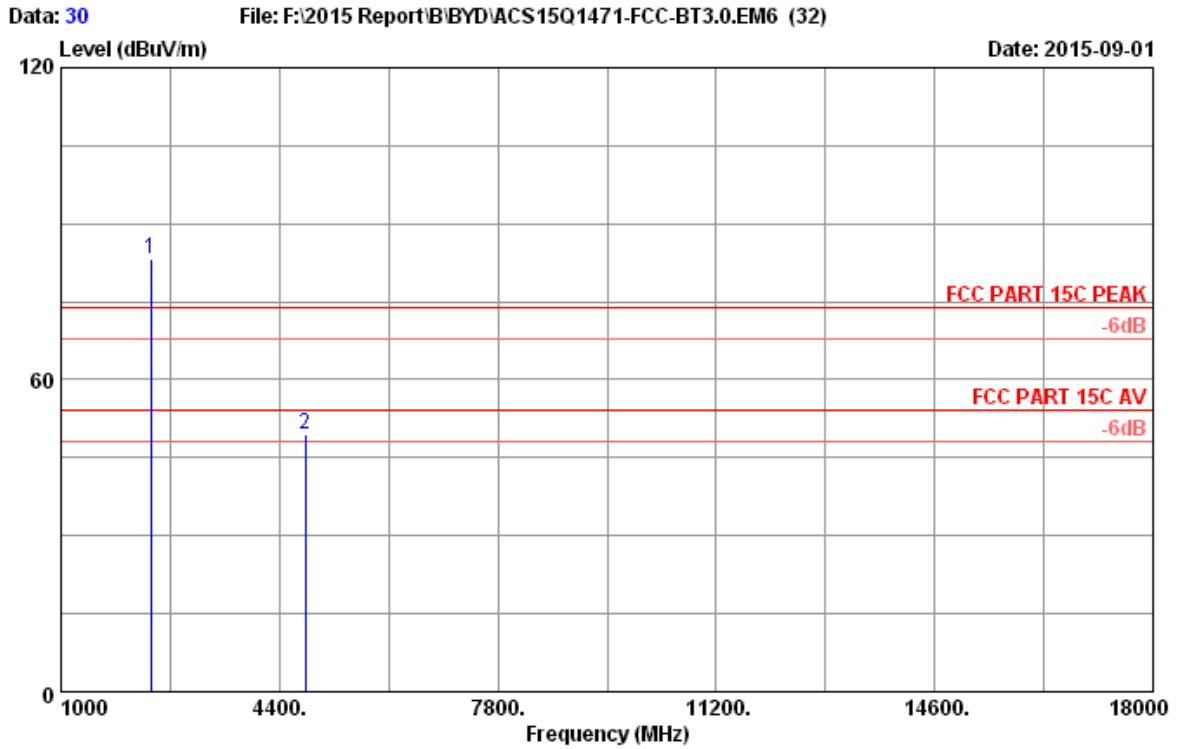

Site no. : 3m Chamber Data no. : 30  
 Dis. / Ant. : 3m 2014 3115 9607-4877 Ant. pol. : VERTICAL  
 Limit : FCC PART 15C PEAK  
 Env. / Ins. : 23°C/54%  
 Engineer : Alice\_yang  
 EUT : Notebook  
 Power rating : DC 20V From Adapter Input AC 120V/60Hz  
 Test Mode : 8-DPSK 2402MHz Tx Mode  
 M/N : RZ09-0168

No.	Freq. (MHz)	Ant. Factor (dB/m)	Cable Loss (dB)	AMP factor (dB)	Reading (dBuV)	Emission Level (dBuV/m)	Limits (dBuV/m)	Margin (dB)	Remark
1	2402.000	28.26	7.32	36.62	84.22	83.18	74.00	-9.18	Peak
2	4804.000	33.02	9.46	35.54	42.67	49.61	74.00	24.39	Peak

Remarks: 1. Emission Level= Antenna Factor + Cable Loss + Reading - Amp Factor  
 2. The emission levels that are 20dB below the official limit are not reported.

## 5. CONDUCTED SPURIOUS EMISSIONS

### 5.1. Test Equipment

Item	Equipment	Manufacturer	Model No.	Serial No.	Last Cal.	Cal. Interval
1.	Spectrum	Agilent	N9030A	MY51380221	Oct.29, 14	1Year
2.	Attenuator (20dB)	Agilent	8491B	MY39262165	Apr. 28,15	1 Year
3.	RF Cable	Hubersuhner	SUCOFLEX102	28620/2	Apr. 28,15	1 Year

### 5.2. Limit

In any 100kHz bandwidth outside the frequency bands in which the spread spectrum intentional radiator is operating, the radio frequency power that is produced by the intentional radiator shall be at least 20dB below that in the 100kHz bandwidth within the band that contains the highest level of the desired power.

### 5.3. Test Procedure

The transmitter output was connected to a spectrum analyzer, The resolution bandwidth is set to 100 kHz, The video bandwidth is set to 300 kHz and measure all the emissions With peak detector.

### 5.4. Test result

**PASS** (The testing data was attached in the next pages.)

**Hopping off**

**GFSK**

2402MHz(30MHz – 1GHz)

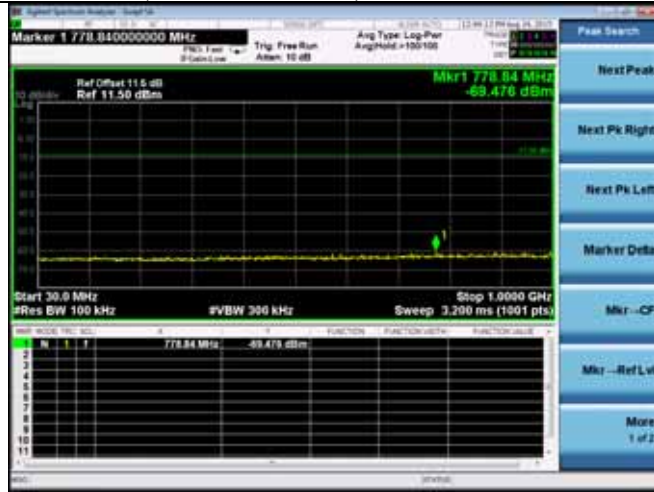

2402MHz(10GHz – 25GHz)



2402MHz(1GHz – 10GHz)

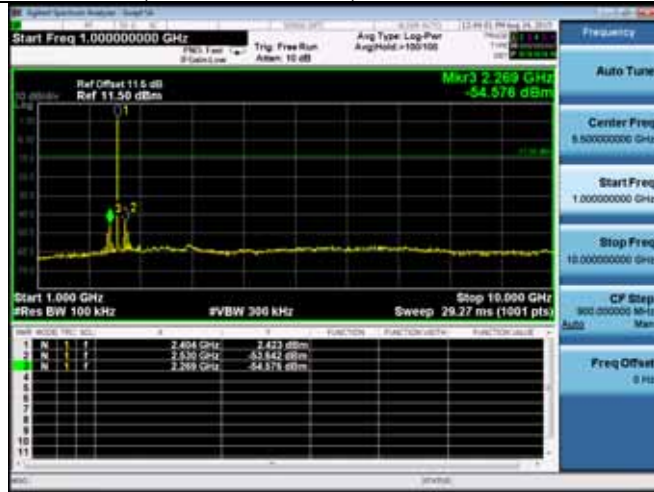

2441(30MHz – 1GHz)

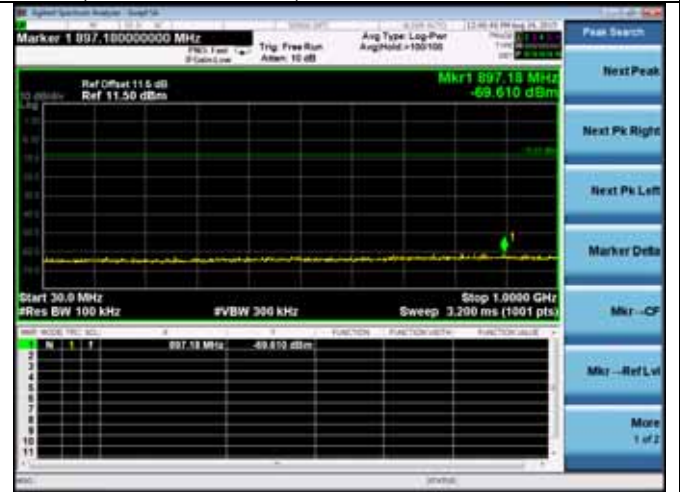

2402MHz(2.3GHz – 2.4GHz)

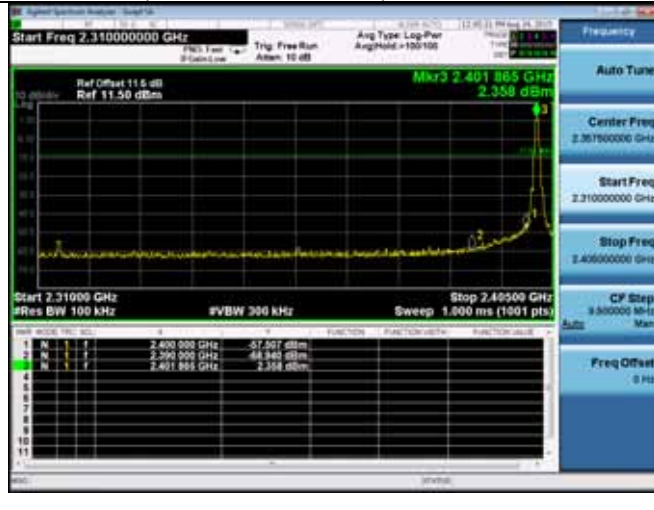

2441(1GHz – 10GHz)

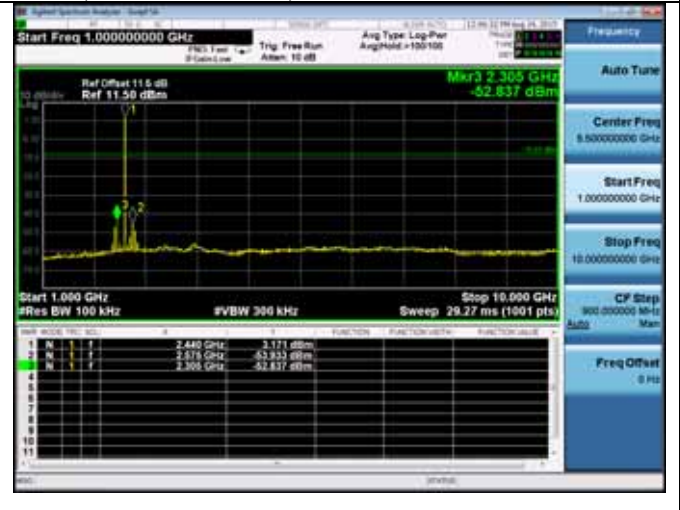

2441(10GHz – 25GHz)



2480MHz(2.4GHz – 2.5GHz)



2480MHz(30MHz – 1GHz)

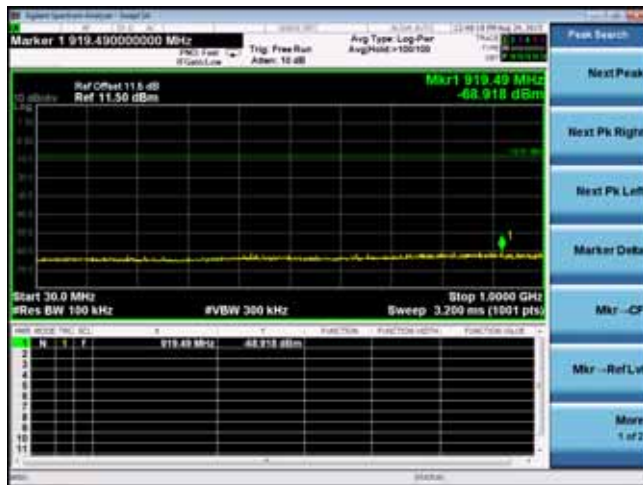

2480MHz(10GHz – 25GHz)

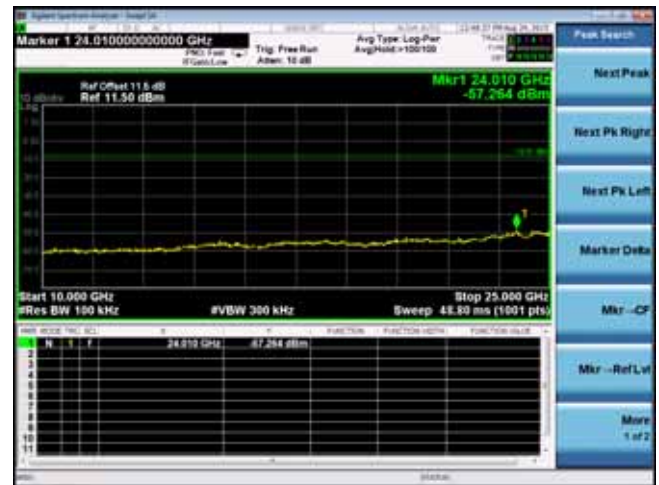

2480MHz(1GHz – 10GHz)

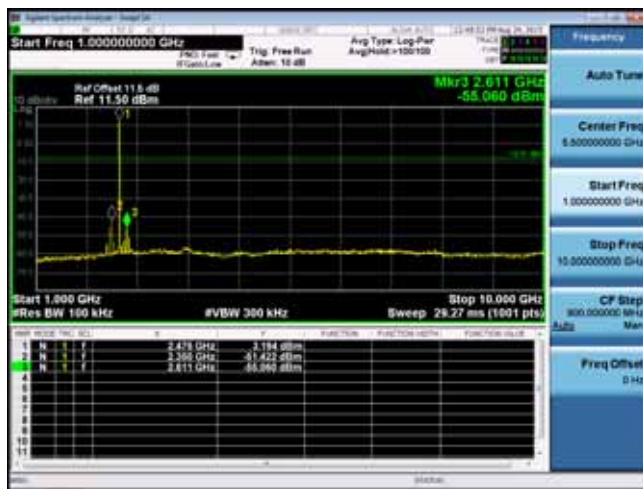

8-DPSK

2402MHz(30MHz – 1GHz)

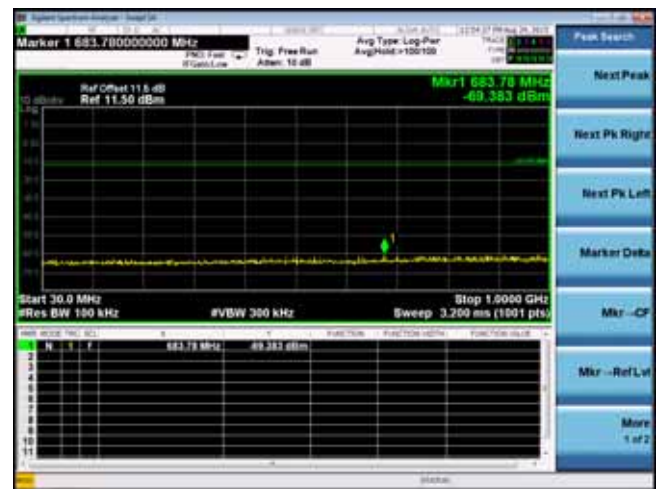



2402MHz(1GHz – 10GHz)

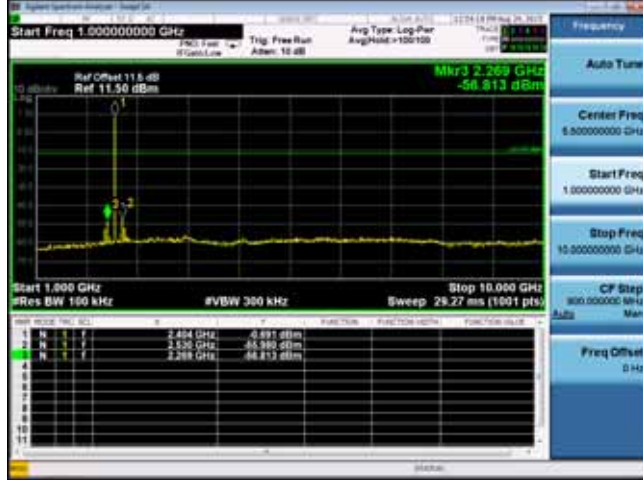

2441MHz (30MHz – 1GHz)

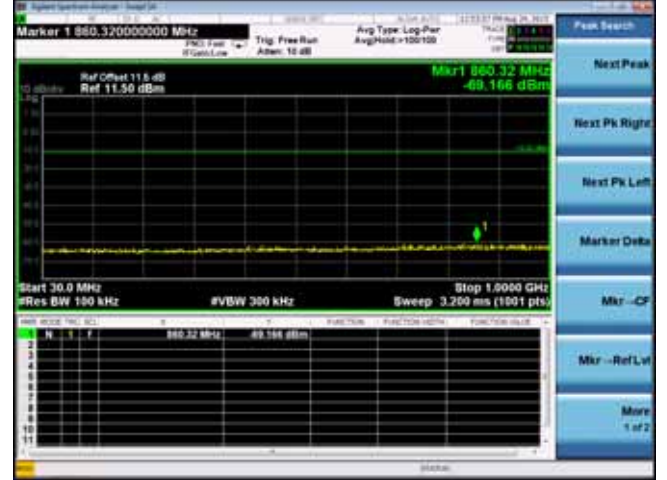

2402MHz(2.3GHz – 2.4GHz)

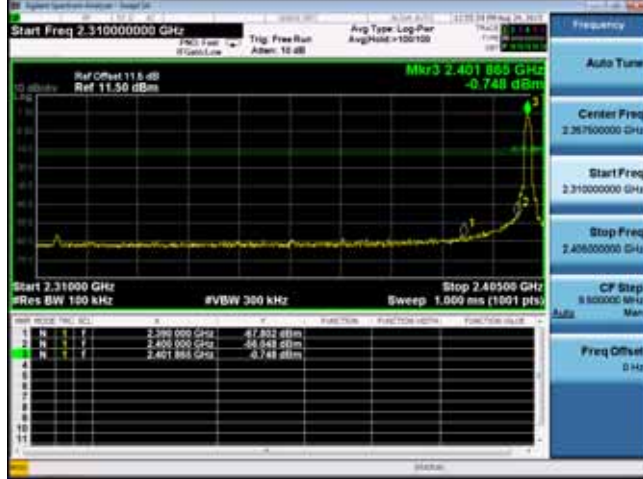

2441MHz(1GHz – 10GHz)

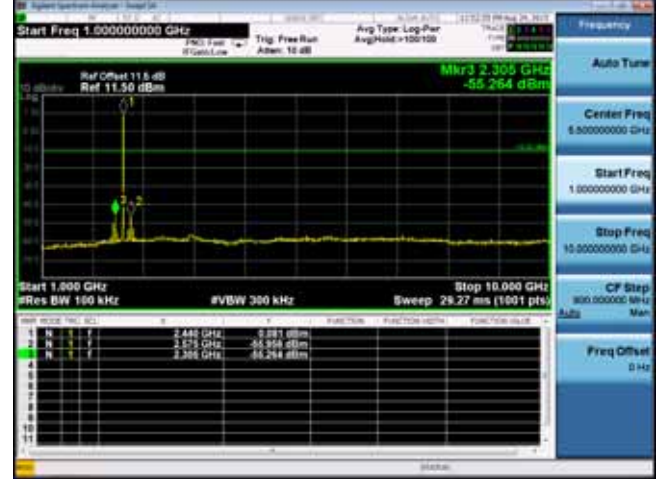

2402MHz(10GHz – 25GHz)

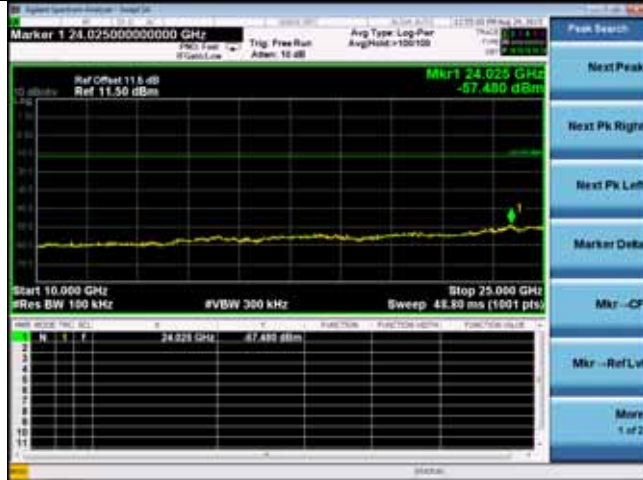

2441MHz(10GHz – 25GHz)

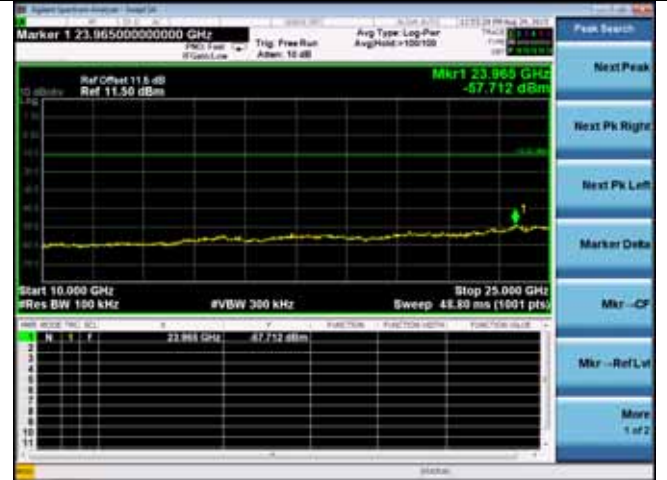

2480MHz(30MHz – 1GHz)

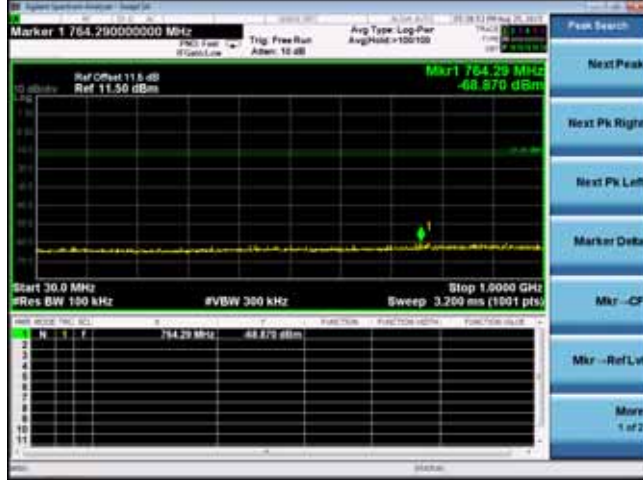

2480MHz(10GHz – 25GHz)



2480MHz(1GHz – 10GHz)

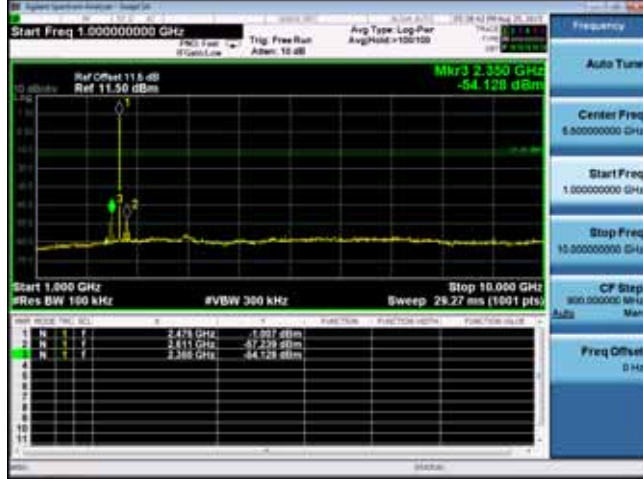

Hopping on GFSK(2.3GHz – 2.4GHz)

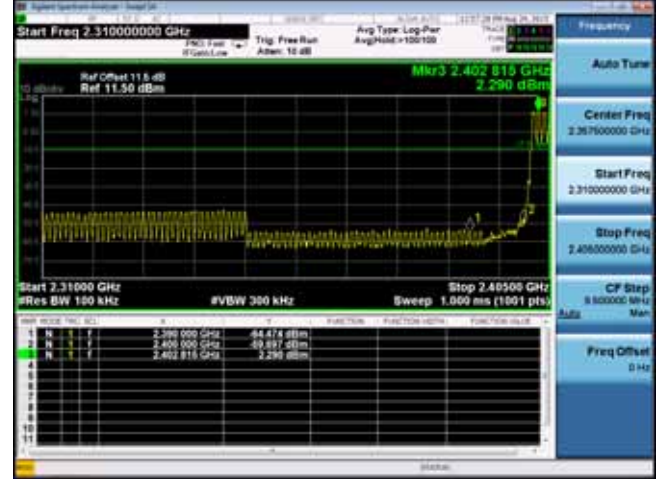

2480MHz(2.4GHz – 2.5GHz)

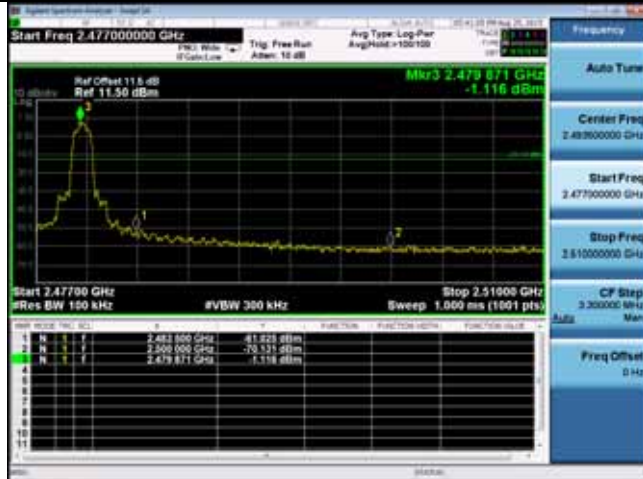

(2.4GHz – 2.5GHz)

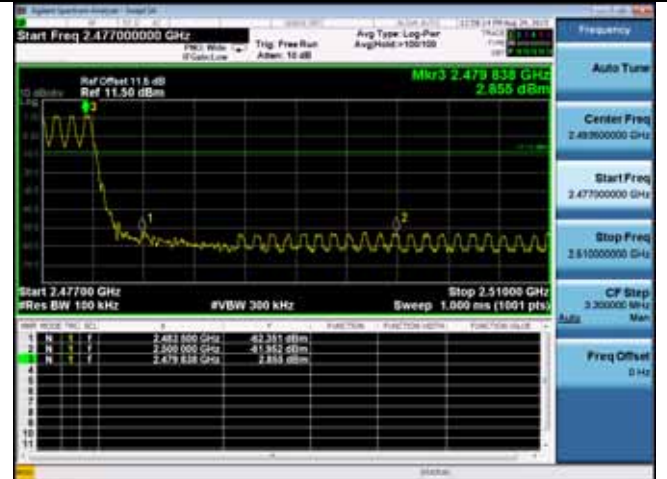

**8-DPSK(2.3GHz – 2.4GHz)**

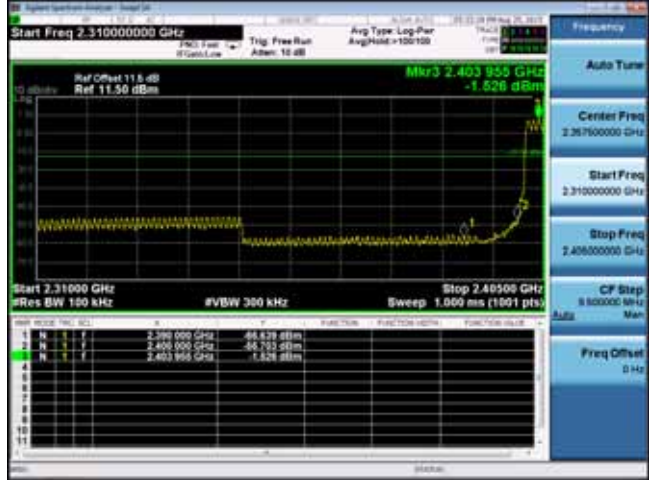

**(2.4GHz – 2.5GHz)**

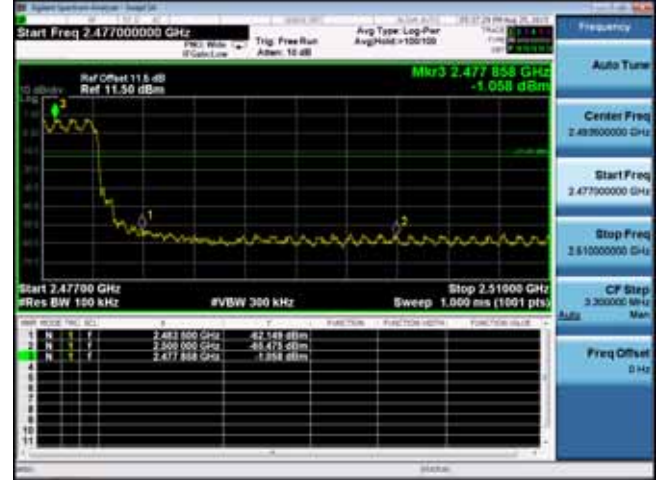



## 6. 20 DB BANDWIDTH TEST

### 6.1. Test Equipment

Item	Equipment	Manufacturer	Model No.	Serial No.	Last Cal.	Cal. Interval
1.	Spectrum	Agilent	N9030A	MY51380221	Oct.29, 14	1 Year
2.	Attenuator (20dB)	Agilent	8491B	MY39262165	Apr. 28,15	1 Year
3.	RF Cable	Hubersuhner	SUCOFLEX102	28620/2	Apr. 28,15	1 Year

### 6.2. Limit

Intentional radiators operating under the alternative provisions to the general emission limits, as contained in §§ 15.217 through 15.257 and in Subpart E of this part, must be designed to ensure that the 20 dB bandwidth of the emission, or whatever bandwidth may otherwise be specified in the specific rule section under which the equipment operates, is contained within the frequency band designated in the rule section under which the equipment is operated.

### 6.3. Test Results

EUT: Notebook			
M/N: RZ09-0168			
Test date: 2015-08-24		Pressure: 101.9±1.0 kpa	Humidity: 49.6±3.0%
Tested by: Alice-Yang		Test site: RF site	Temperature: 22.1±0.6
Test Mode	Frequency ( MHz )	20dB bandwidth ( KHz )	Limit (KHz)
GFSK	2402	929.1	N/A
	2441	928.7	N/A
	2480	906.1	N/A
8-DPSK	2402	1241	N/A
	2441	1243	N/A
	2480	1247	N/A
Conclusion : PASS			

**GFSK**

2402MHz



**8-DPSK**

2402MHz



2441MHz



2441MHz



2480MHz



2480MHz



## 7. CARRIER FREQUENCY SEPARATION TEST

### 7.1. Test Equipment

Item	Equipment	Manufacturer	Model No.	Serial No.	Last Cal.	Cal. Interval
1	Spectrum Analyzer	Agilent	N9030A	MY51380221	Oct.29, 14	1Year
2.	RF Cable	Hubersuhner	SUCOFLEX102	28620/2	Apr. 28,15	1 Year

### 7.2. Limit

Frequency hopping systems shall have hopping channel carrier frequency separated by a minimum of 25kHz or the 20dB bandwidth of the hopping channel, whichever is greater. Alternatively, frequency hopping systems operating in the 2400-2483.5 MHz band may have hopping channel carrier frequencies that are separated by 25 kHz or two-thirds of the 20 dB bandwidth of the hopping channel, whichever is greater, provided the systems operate with an output power no greater than 125 mW.

### 7.3. Test Results.

EUT: Notebook		
M/N: RZ09-0168		
Test date: 2015-08-24	Pressure: 101.4±1.0 kpa	Humidity: 51.4±3.0%
Tested by: Alice-Yang	Test site: RF Site	Temperature: 23.4±0.6

Test Mode	Channel separation	Limit(KHz)	Conclusion
8-DPSK	1.0MHz	581.67	PASS
GFSK	1.0MHz	808.67	PASS



## 8. NUMBER OF HOPPING FREQUENCY TEST

### 8.1. Test Equipment

Item	Equipment	Manufacturer	Model No.	Serial No.	Last Cal.	Cal. Interval
1	Spectrum Analyzer	Agilent	N9030A	MY51380221	Oct.29, 14	1 Year
2.	RF Cable	Hubersuhner	SUCOFLEX102	28620/2	Apr.28, 15	1 Year

### 8.2. Limit

Frequency hopping systems in the 2400-2483.5 MHz band shall use at least 15 channels

### 8.3. Test Results

EUT: Notebook		
M/N: RZ09-0168		
Test date: 2015-08-24	Pressure: 101.4±1.0 kpa	Humidity: 51.4±3.0%
Tested by: Alice-Yang	Test site: RF Site	Temperature: 23.4±0.6

Test Mode	Number of channel	Limit	Conclusion
8-DPSK	79	>=15	PASS
GFSK	79	>=15	PASS

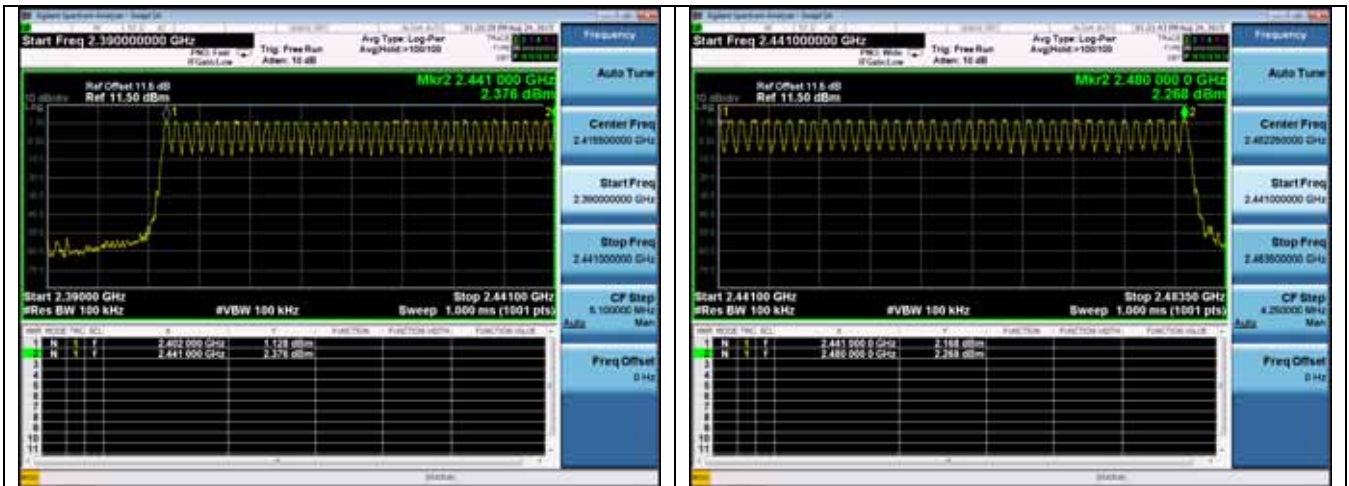

## 9. DWELL TIME

### 9.1. Test Equipment

Item	Equipment	Manufacturer	Model No.	Serial No.	Last Cal.	Cal. Interval
1	Spectrum Analyzer	Agilent	N9030A	MY51380221	Oct.29, 14	1Year
2.	RF Cable	Hubersuhner	SUCOFLEX102	28620/2	Apr.28, 15	1 Year

### 9.2. Limit

The average time of occupancy on any channel shall not be greater than 0.4 seconds within a period of 0.4 seconds multiplied by the number of hopping channels employed.

### 9.3. Test Results

EUT: Notebook		
M/N: RZ09-0168		
Test date: 2015-08-25	Pressure: 101.4±1.0 kpa	Humidity: 51.4±3.0%
Tested by: Alice-Yang	Test site: RF Site	Temperature: 23.4±0.6

Mode	dwell time		Limit	Conclusion
GFSK	DH1	$48\text{hops}/5\text{s} * 0.4 * 79\text{channels} * 0.417\text{ms} = 126.501\text{ms}$	<400ms	PASS
	DH3	$24\text{hops}/5\text{s} * 0.4 * 79\text{channels} * 1.689\text{ms} = 256.188\text{ms}$	<400ms	PASS
	DH5	$9\text{hops}/5\text{s} * 0.4 * 79\text{channels} * 2.940\text{ms} = 167.227\text{ms}$	<400ms	PASS
8-DPSK	DH1	$48\text{hops}/5\text{s} * 0.4 * 79\text{channels} * 0.419\text{ms} = 127.108\text{ms}$	<400ms	PASS
	DH3	$24\text{hops}/5\text{s} * 0.4 * 79\text{channels} * 1.683\text{ms} = 255.277\text{ms}$	<400ms	PASS
	DH5	$18\text{hops}/5\text{s} * 0.4 * 79\text{channels} * 2.945\text{ms} = 335.023\text{ms}$	<400ms	PASS

Note: All the lower levels were signaled from receiver and should not be considered in here.



**GFSK**

**DH 1**

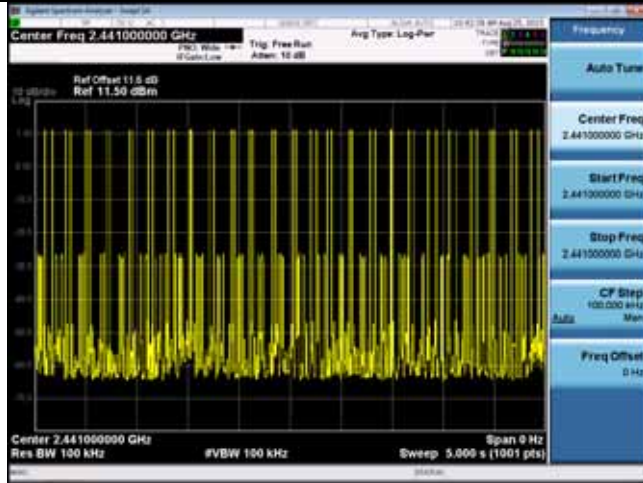

**DH 3**

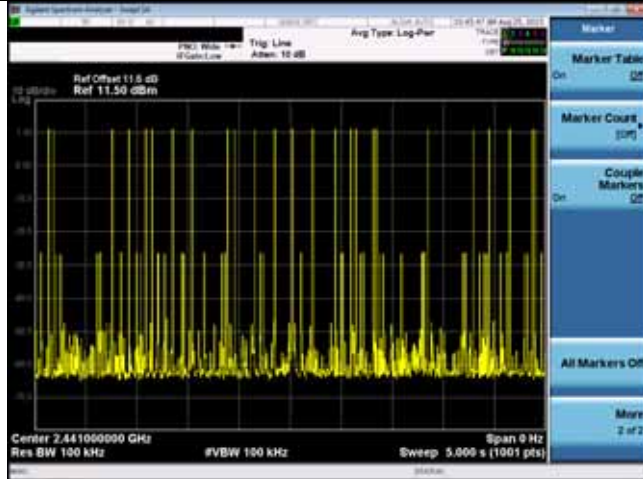

**DH 5**

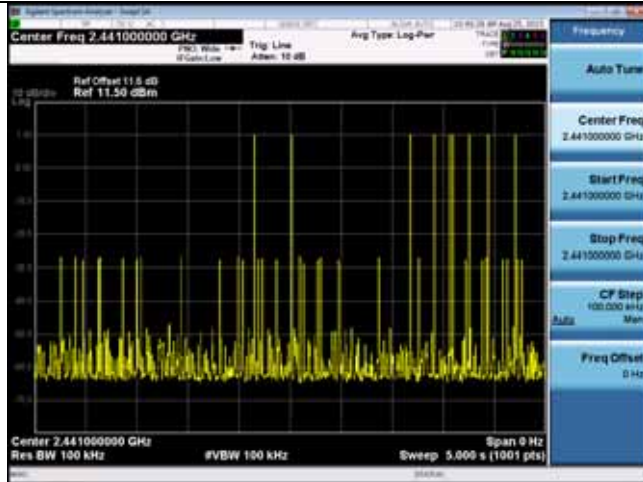

**8-DPSK**

**3DH 1**

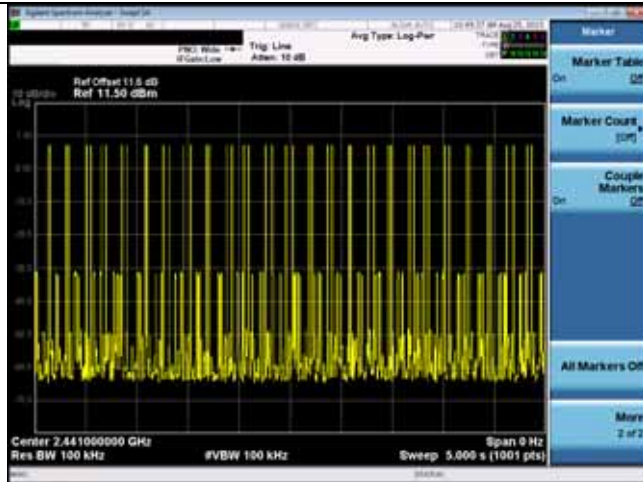

**3DH 3**

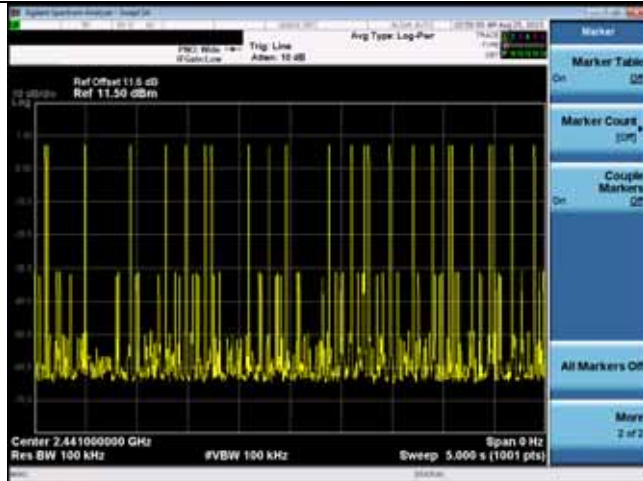

**3DH 5**

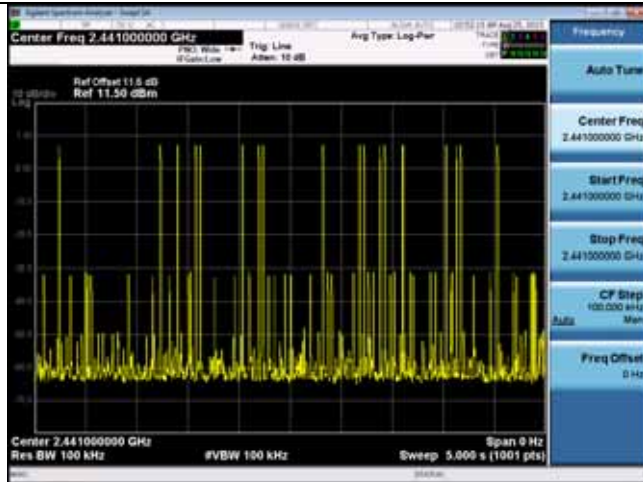

## 10. MAXIMUM PEAK OUTPUT POWER TEST

### 10.1. Test Equipment

Item	Equipment	Manufacturer	Model No.	Serial No.	Last Cal.	Cal. Interval
1.	Spectrum	Agilent	N9030A	MY51380221	Oct.29, 14	1Year
2.	Power meter	Anritsu	ML2487A	6K00002472	Apr. 28,15	1Year
3.	Power sensor	Anritsu	MA2491A	0033005	Apr. 28,15	1Year
4.	Attenuator (20dB)	Agilent	8491B	MY39262165	Apr. 28,15	1Year
5.	RF Cable	Hubersuhner	SUCOFLEX102	28610/2	Apr. 28,15	1Year

### 10.2. Limit

For frequency hopping systems operating in the 2400-2483.5 MHz band employing at least 75 non-overlapping hopping channels, and all frequency hopping systems in the 5725-5850 MHz band: 1 watt.

### 10.3. Test Procedure

Connected the EUT's antenna port to Power Sensor, and use power meter to test peak output power directly.

### 10.4. Test Results

EUT: Notebook			
M/N: RZ09-0168			
Test date: 2015-08-21		Pressure: 101.7±1.0 kpa	Humidity: 50.4±3.0%
Tested by: Alice-Yang		Test site: RF site	Temperature:22.1±0.6
Test Mode	Frequency (MHz)	Peak output Power ( dBm )	Limit (dBm)
GFSK	2402	2.274	30
	2441	3.122	30
	2480	3.231	30
8-DPSK	2402	1.532	30
	2441	2.396	30
	2480	2.438	30
Conclusion: PASS			



## 11. BAND EDGE COMPLIANCE TEST

### 11.1. Test Equipment

Item	Equipment	Manufacturer	Model No.	Serial No.	Last Cal.	Cal. Interval
1.	Spectrum	Agilent	E4446A	US44300459	Apr.28,15	1 Year
2.	Amp	HP	8449B	3008A02495	Apr.28,15	1 Year
3.	Horn Antenna	ETS	3115	9510-4877	Sep.20,14	1 Year
4.	HF Cable	Hubersuhner	Sucoflex104	274094/4	Apr.28,15	1 Year

### 11.2. Limit

All the lower and upper band-edges emissions appearing within 2310MHz to 2390MHz and 2483.5MHz to 2500MHz restricted frequency bands shall not exceed the limits shown in 15.209, all the other emissions outside operation frequency band 2400MHz to 2483.5MHz shall be at least 20dB below the fundamental emissions, or comply with 15.209 limits.

### 11.3. Test Produce

For upper band emissions that are up to two bandwidths(2MHz) away (2483.5MHz to 2485.5MHz ) from the band-edge use below produce:

1. Choose a spectrum analyzer span that encompasses both the peak of the fundamental emission and the band-edge emission under investigation. Set the analyzer RBW to 100KHz and with a video bandwidth 300KHz. Record the peak levels of the fundamental emission and the relevant band-edge emission, Observe the stored trace and measure the amplitude delta between the peak of the fundamental and the peak of the band-edge emission. This is not a field strength measurement, it is only a relative measurement to determine the amount by which the emission drops at the band edge relative to the highest fundamental emission level.
2. Subtract the delta measured in step (1) from the maximum field strengths measured in clause 4 .The resultant field strengths are then used to determine band-edge compliance as required by Section 15.205

For emissions above two bandwidths away from the band-edge use below produce:

1. The EUT is placed on a insulating material (up to 12mm thick) worked at highest radiated power.
2. The turntable was rotated for 360 degrees to determine the position of maximum emission level.
3. EUT is set 3m away from the receiving antenna, which is varied from 1m to 4m to find out the highest emission.
4. Set the spectrum analyzer in the following setting in order to capture the lower and upperband-edges of the emission:
  - (a) PEAK: RBW=1MHz ;VBW=3MHz, PK detector, Sweep=AUTO
  - (b) This is pulse Modulation device a duty cycle factor was used to calculate average level based measured peak level.

### 11.4. Test Results

Pass (The testing data was attached in the next pages.)

Note: If the PK measured levels comply with average limit, then the average level were deemed to comply with average limit.

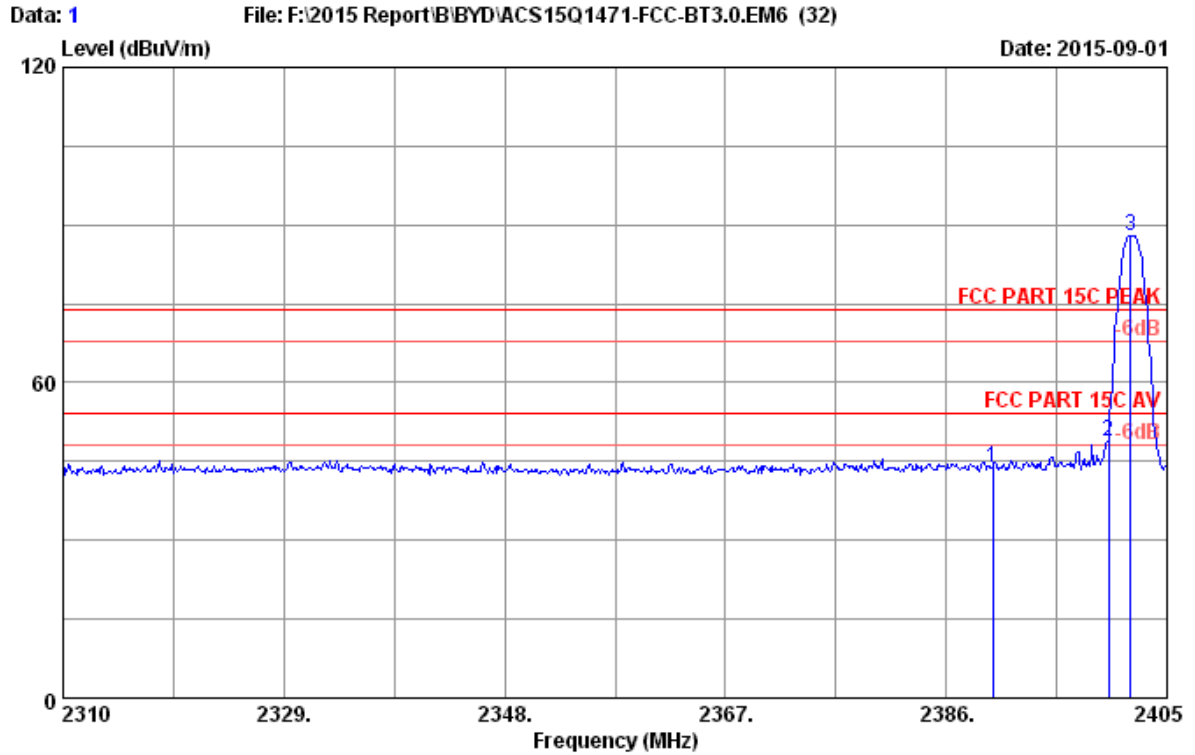

Site no. : 3m Chamber Data no. : 1  
 Dis. / Ant. : 3m 2014 3115 9607-4877 Ant. pol. : VERTICAL  
 Limit : FCC PART 15C PEAK  
 Env. / Ins. : 23°C/54%  
 Engineer : Alice\_yang  
 EUT : Notebook  
 Power rating : DC 20V From Adapter Input AC 120V/60Hz  
 Test Mode : GFSK 2402MHz Tx Mode  
 M/N : RZ09-0168

No.	Freq. (MHz)	Ant. Factor (dB/m)	Cable Loss (dB)	AMP factor (dB)	Reading (dBUV)	Emission Level (dBUV/m)	Limits (dBUV/m)	Margin (dB)	Remark
1	2390.000	28.24	7.28	36.62	44.83	43.73	74.00	30.27	Peak
2	2400.000	28.25	7.32	36.62	49.97	48.92	74.00	25.08	Peak
3	2401.865	28.26	7.32	36.62	89.06	88.02	74.00	-14.02	Peak

Remarks: 1. Emission Level= Antenna Factor + Cable Loss + Reading - Amp Factor  
 2. The emission levels that are 20dB below the official limit are not reported.

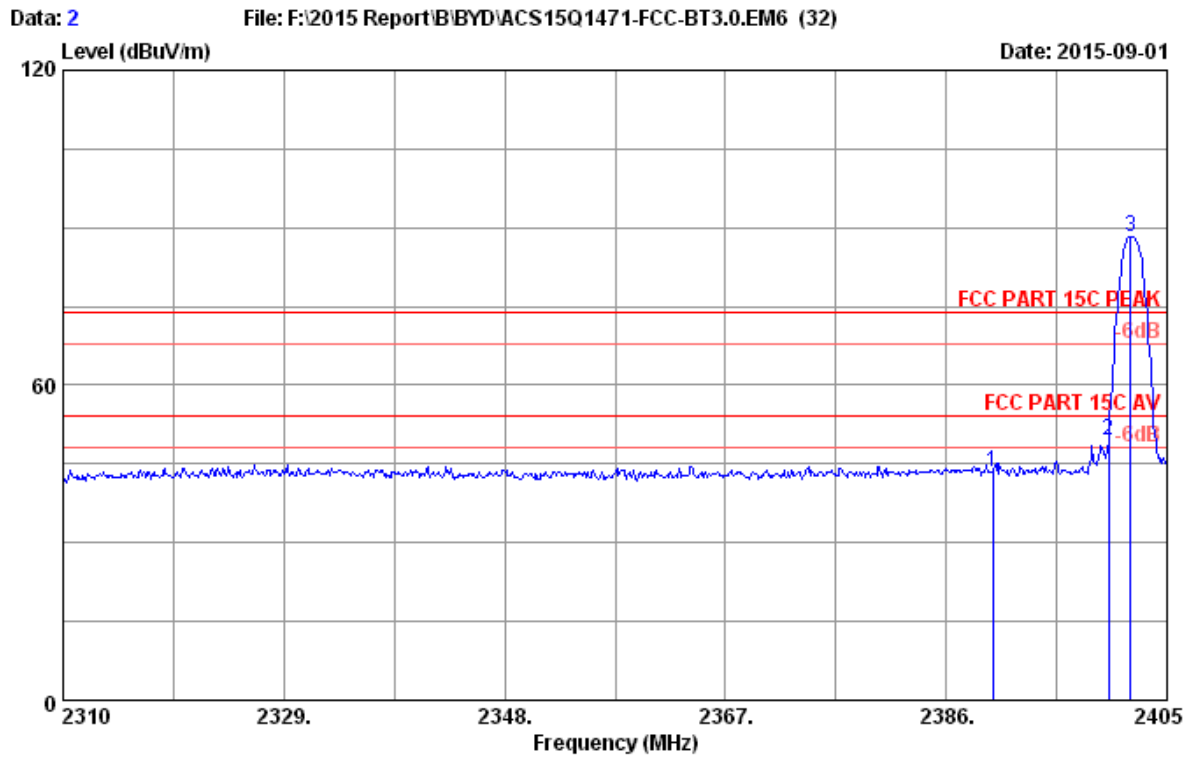

Site no. : 3m Chamber Data no. : 2  
 Dis. / Ant. : 3m 2014 3115 9607-4877 Ant. pol. : HORIZONTAL  
 Limit : FCC PART 15C PEAK  
 Env. / Ins. : 23°C/54%  
 Engineer : Alice\_yang  
 EUT : Notebook  
 Power rating : DC 20V From Adapter Input AC 120V/60Hz  
 Test Mode : GFSK 2402MHz Tx Mode  
 M/N : RZ09-0168

No.	Freq. (MHz)	Ant. Factor (dB/m)	Cable Loss (dB)	AMP factor (dB)	Reading (dBuV)	Emission Level (dBuV/m)	Limits (dBuV/m)	Margin (dB)	Remark
1	2390.000	28.24	7.28	36.62	44.57	43.47	74.00	30.53	Peak
2	2400.000	28.25	7.32	36.62	50.59	49.54	74.00	24.46	Peak
3	2401.865	28.26	7.32	36.62	89.29	88.25	74.00	-14.25	Peak

Remarks: 1. Emission Level= Antenna Factor + Cable Loss + Reading - Amp Factor  
 2. The emission levels that are 20dB below the official limit are not reported.

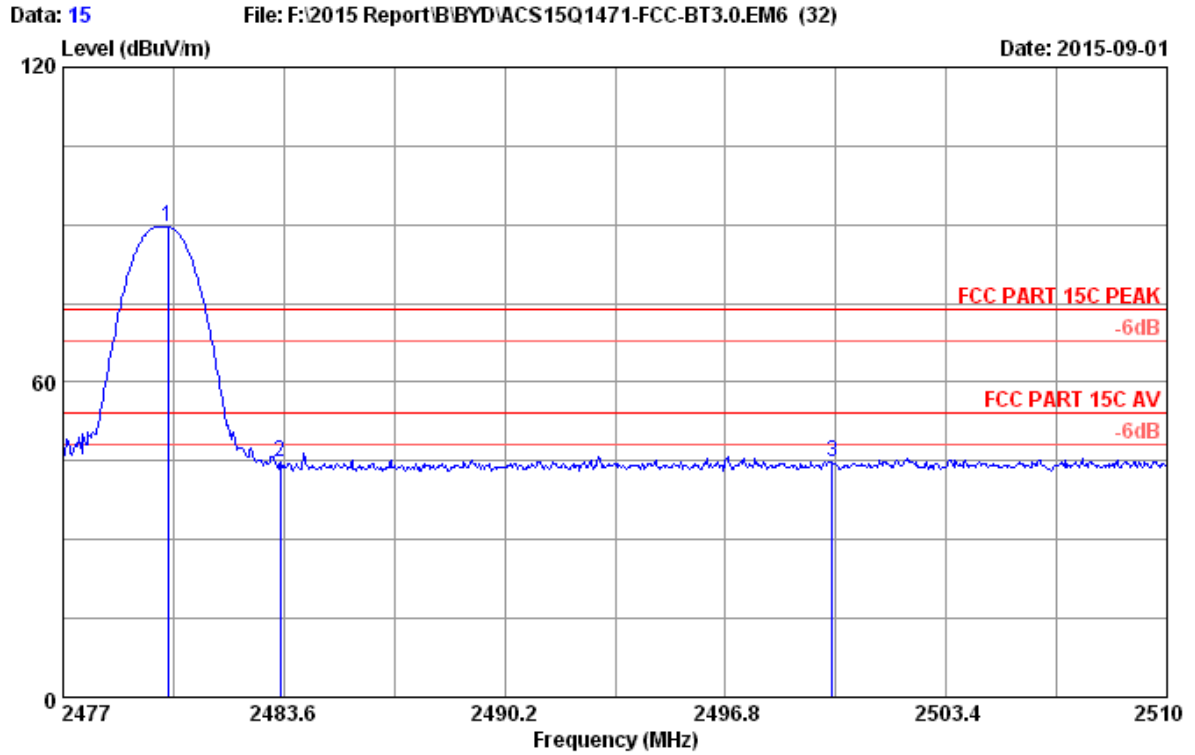

Site no. : 3m Chamber Data no. : 15  
 Dis. / Ant. : 3m 2014 3115 9607-4877 Ant. pol. : HORIZONTAL  
 Limit : FCC PART 15C PEAK  
 Env. / Ins. : 23°C/54%  
 Engineer : Alice\_yang  
 EUT : Notebook  
 Power rating : DC 20V From Adapter Input AC 120V/60Hz  
 Test Mode : GFSK 2480MHz Tx Mode  
 M/N : R209-0168

No.	Freq. (MHz)	Ant. Factor (dB/m)	Cable Loss (dB)	AMP factor (dB)	Reading (dBuV)	Emission Level (dBuV/m)	Limits (dBuV/m)	Margin (dB)	Remark
1	2480.135	28.37	7.47	36.59	90.32	89.57	74.00	-15.57	Peak
2	2483.500	28.38	7.51	36.59	45.38	44.68	74.00	29.32	Peak
3	2500.000	28.40	7.51	36.58	45.61	44.94	74.00	29.06	Peak

Remarks: 1. Emission Level= Antenna Factor + Cable Loss + Reading - Amp Factor  
 2. The emission levels that are 20dB below the official limit are not reported.

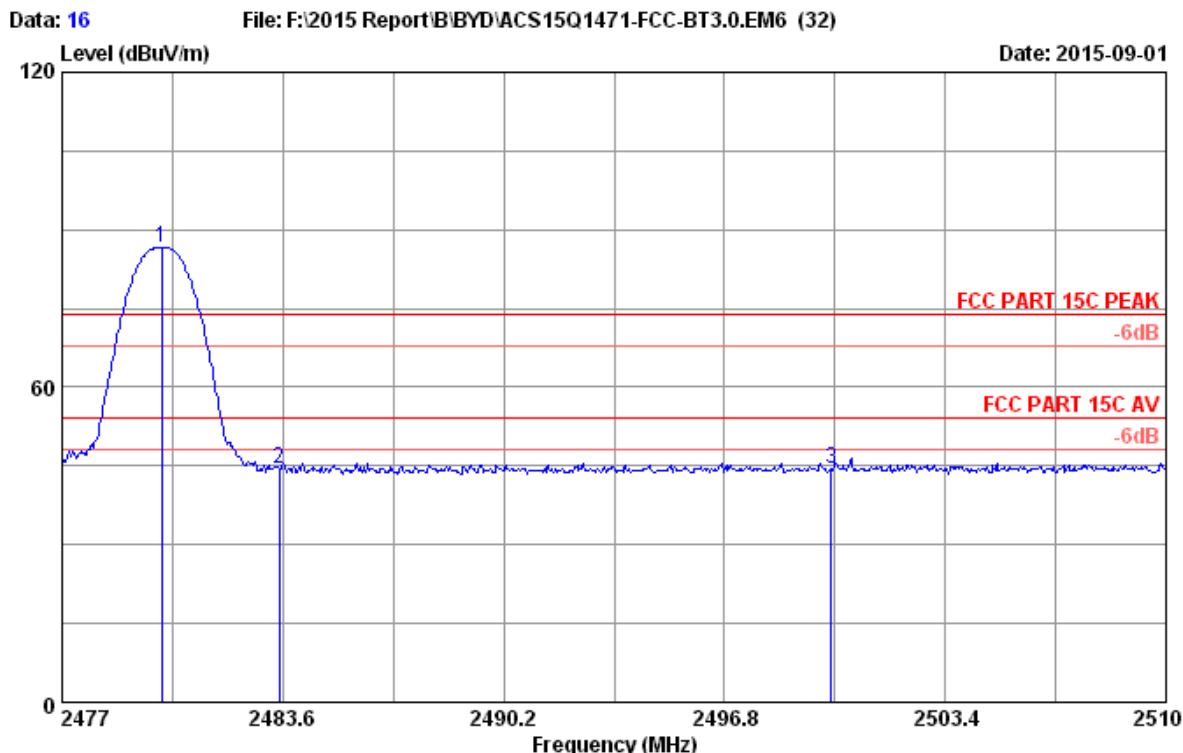

Site no. : 3m Chamber Data no. : 16  
 Dis. / Ant. : 3m 2014 3115 9607-4877 Ant. pol. : VERTICAL  
 Limit : FCC PART 15C PEAK  
 Env. / Ins. : 23°C/54%  
 Engineer : Alice\_yang  
 EUT : Notebook  
 Power rating : DC 20V From Adapter Input AC 120V/60Hz  
 Test Mode : GFSK 2480MHz Tx Mode  
 M/N : RZ09-0168

No.	Freq. (MHz)	Ant. Factor (dB/m)	Cable Loss (dB)	AMP factor (dB)	Reading (dBuV)	Emission Level (dBuV/m)	Limits (dBuV/m)	Margin (dB)	Remark
1	2479.970	28.37	7.47	36.59	87.31	86.56	74.00	-12.56	Peak
2	2483.500	28.38	7.51	36.59	45.09	44.39	74.00	29.61	Peak
3	2500.000	28.40	7.51	36.58	45.25	44.58	74.00	29.42	Peak

Remarks: 1. Emission Level= Antenna Factor + Cable Loss + Reading - Amp Factor  
 2. The emission levels that are 20dB below the official limit are not reported.

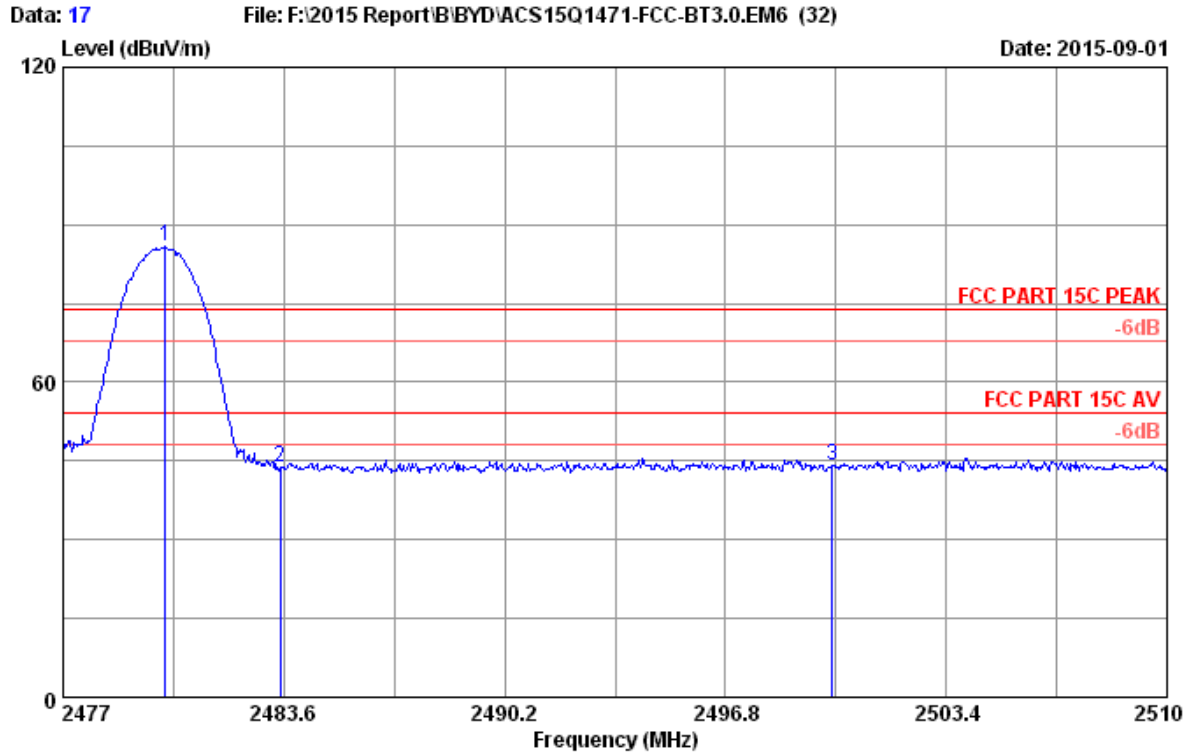

Site no. : 3m Chamber Data no. : 17  
 Dis. / Ant. : 3m 2014 3115 9607-4877 Ant. pol. : VERTICAL  
 Limit : FCC PART 15C PEAK  
 Env. / Ins. : 23°C/54%  
 Engineer : Alice\_yang  
 EUT : Notebook  
 Power rating : DC 20V From Adapter Input AC 120V/60Hz  
 Test Mode : 8-DPSK 2480MHz Tx Mode  
 M/N : RZ09-0168

No.	Freq. (MHz)	Ant. Factor (dB/m)	Cable Loss (dB)	AMP factor (dB)	Reading (dBuV)	Emission Level (dBuV/m)	Limits (dBuV/m)	Margin (dB)	Remark
1	2480.069	28.37	7.47	36.59	86.63	85.88	74.00	-11.88	Peak
2	2483.500	28.38	7.51	36.59	44.39	43.69	74.00	30.31	Peak
3	2500.000	28.40	7.51	36.58	44.65	43.98	74.00	30.02	Peak

Remarks: 1. Emission Level= Antenna Factor + Cable Loss + Reading - Amp Factor  
 2. The emission levels that are 20dB below the official limit are not reported.

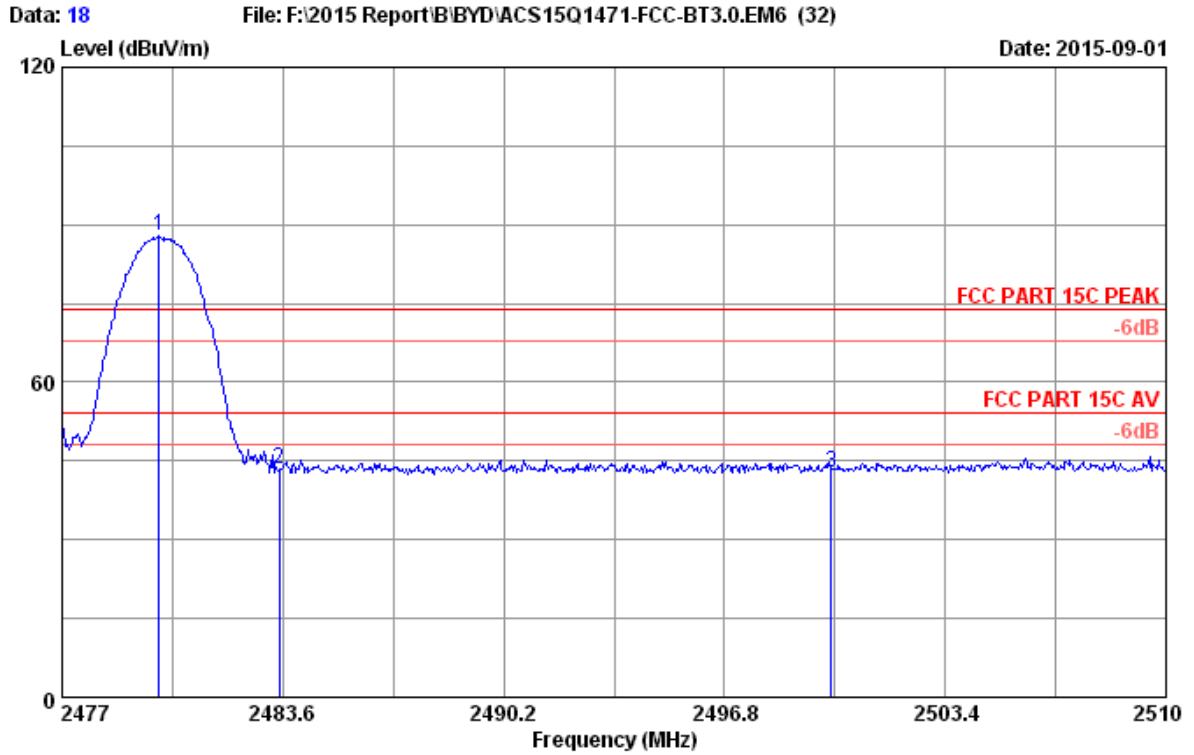

Site no. : 3m Chamber Data no. : 18  
 Dis. / Ant. : 3m 2014 3115 9607-4877 Ant. pol. : HORIZONTAL  
 Limit : FCC PART 15C PEAK  
 Env. / Ins. : 23°C/54%  
 Engineer : Alice\_yang  
 EUT : Notebook  
 Power rating : DC 20V From Adapter Input AC 120V/60Hz  
 Test Mode : 8-DPSK 2480MHz Tx Mode  
 M/N : RZ09-0168

No.	Freq. (MHz)	Ant. Factor (dB/m)	Cable Loss (dB)	AMP factor (dB)	Reading (dBuV)	Emission Level (dBuV/m)	Limits (dBuV/m)	Margin (dB)	Remark
1	2479.904	28.37	7.47	36.59	88.54	87.79	74.00	-13.79	Peak
2	2483.500	28.38	7.51	36.59	44.08	43.38	74.00	30.62	Peak
3	2500.000	28.40	7.51	36.58	43.62	42.95	74.00	31.05	Peak

Remarks: 1. Emission Level= Antenna Factor + Cable Loss + Reading - Amp Factor  
 2. The emission levels that are 20dB below the official limit are not reported.

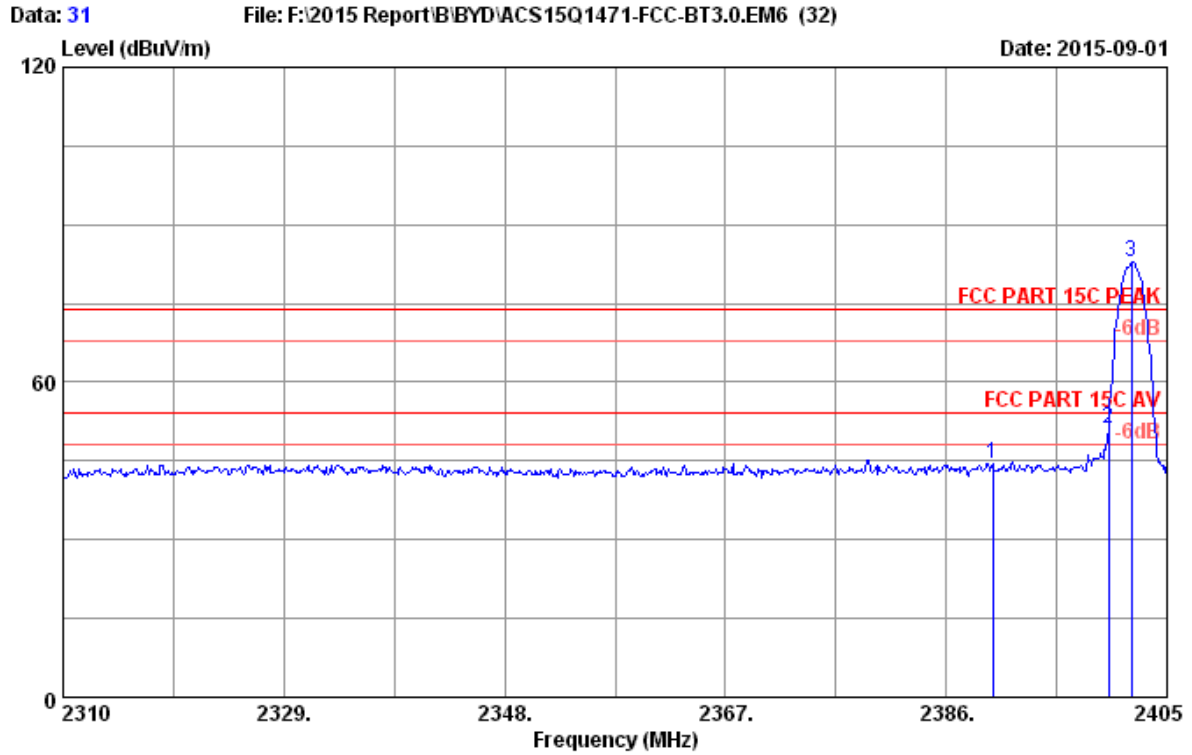

Site no. : 3m Chamber Data no. : 31  
 Dis. / Ant. : 3m 2014 3115 9607-4877 Ant. pol. : VERTICAL  
 Limit : FCC PART 15C PEAK  
 Env. / Ins. : 23°C/54%  
 Engineer : Alice\_yang  
 EUT : Notebook  
 Power rating : DC 20V From Adapter Input AC 120V/60Hz  
 Test Mode : 8-DPSK 2402MHz Tx Mode  
 M/N : R209-0168

No.	Freq. (MHz)	Ant. Factor (dB/m)	Cable Loss (dB)	AMP factor (dB)	Reading (dBuV)	Emission Level (dBuV/m)	Limits (dBuV/m)	Margin (dB)	Remark
1	2390.000	28.24	7.28	36.62	45.40	44.30	74.00	29.70	Peak
2	2400.000	28.25	7.32	36.62	52.14	51.09	74.00	22.91	Peak
3	2401.960	28.26	7.32	36.62	83.85	82.81	74.00	-8.81	Peak

Remarks: 1. Emission Level= Antenna Factor + Cable Loss + Reading - Amp Factor  
 2. The emission levels that are 20dB below the official limit are not reported.



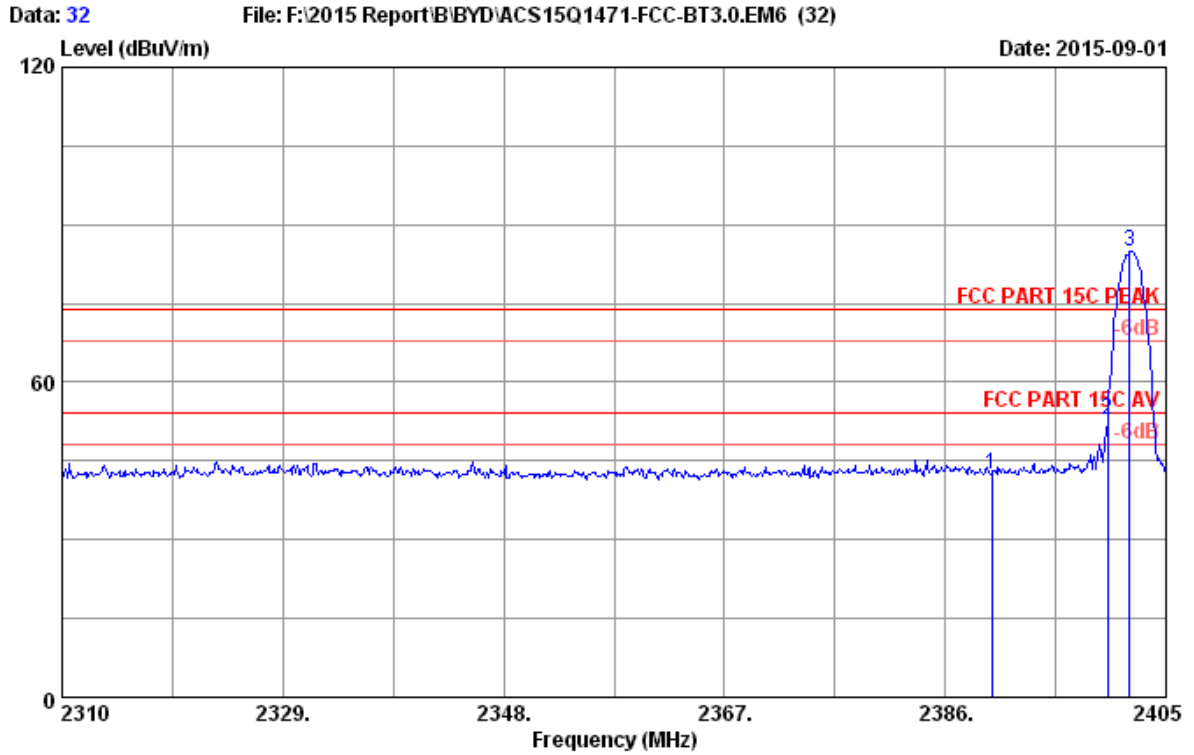

Site no. : 3m Chamber Data no. : 32  
 Dis. / Ant. : 3m 2014 3115 9607-4877 Ant. pol. : HORIZONTAL  
 Limit : FCC PART 15C PEAK  
 Env. / Ins. : 23°C/54%  
 Engineer : Alice\_yang  
 EUT : Notebook  
 Power rating : DC 20V From Adapter Input AC 120V/60Hz  
 Test Mode : 8-DPSK 2402MHz Tx Mode  
 M/N : RZ09-0168

No.	Freq. (MHz)	Ant. Factor (dB/m)	Cable Loss (dB)	AMP factor (dB)	Reading (dBuV)	Emission Level (dBuV/m)	Limits (dBuV/m)	Margin (dB)	Remark
1	2390.000	28.24	7.28	36.62	43.47	42.37	74.00	31.63	Peak
2	2400.000	28.25	7.32	36.62	53.88	52.83	74.00	21.17	Peak
3	2401.865	28.26	7.32	36.62	85.96	84.92	74.00	-10.92	Peak

Remarks: 1. Emission Level= Antenna Factor + Cable Loss + Reading - Amp Factor  
 2. The emission levels that are 20dB below the official limit are not reported.

## 12. TENNA REQUIREMENT

### 12.1. Standard Applicable

For intentional device, according to FCC 47 CFR Section 15.203, an intentional radiator shall be designed to ensure that no antenna other than that furnished by the responsible party shall be used with the device. And according to FCC 47 CFR Section 15.247 (b), if transmitting antennas of directional gain greater than 6dBi are used, the power shall be reduced by the amount in dB that the directional gain of the antenna exceeds 6dBi.

### 12.2. Antenna Connected Construction

The antennas used for this product are PISA antenna that no antenna other than that furnished by the responsible party shall be used with the device, the maximum peak gain of the transmit antenna is 2.84dBi

### **13.DEVIATION TO TEST SPECIFICATIONS**

[NONE]