

FCC Radio Test Report

FCC ID: RWO-RZ090166

This report concerns (check one): Original Grant Class I Change Class II Change

Project No. : 1607C289
Equipment : Notebook
Model Name : RZ09-0166
Applicant : Razer Inc.
Address : 201 3rd Street, Suite 900, San Francisco, CA 94103

Date of Receipt : Jul. 28, 2016
Date of Test : Jul. 28, 2016 ~ Aug. 22, 2016
Issued Date : Aug. 23, 2016
Tested by : BTL Inc.

Testing Engineer : Shawn Xiao
(Shawn Xiao)

Technical Manager : David Mao
(David Mao)

Authorized Signatory : Steven Lu
(Steven Lu)

B T L I N C .

No.3, Jinshagang 1st Road, Shixia, Dalang Town, Dongguan,
Guangdong, China.

TEL: +86-769-8318-3000 FAX: +86-769-8319-6000

Declaration

BTL represents to the client that testing is done in accordance with standard procedures as applicable and that test instruments used has been calibrated with standards traceable to international standard(s) and/or national standard(s).

BTL's reports apply only to the specific samples tested under conditions. It is manufacture's responsibility to ensure that additional production units of this model are manufactured with the identical electrical and mechanical components. **BTL** shall have no liability for any declarations, inferences or generalizations drawn by the client or others from **BTL** issued reports.

BTL's report must not be used by the client to claim product certification, approval, or endorsement by NVLAP, NIST, or any agency of the Federal Government.

This report is the confidential property of the client. As a mutual protection to the clients, the public and **BTL-self**, extracts from the test report shall not be reproduced except in full with **BTL's** authorized written approval.

BTL's laboratory quality assurance procedures are in compliance with the **ISO Guide 17025** requirements, and accredited by the conformity assessment authorities listed in this test report.

Limitation

For the use of the authority's logo is limited unless the Test Standard(s)/Scope(s)/Item(s) mentioned in this test report is (are) included in the conformity assessment authorities acceptance respective.

Table of Contents	Page
1 . CERTIFICATION	7
2 . SUMMARY OF TEST RESULTS	8
2.1 TEST FACILITY	9
2.2 MEASUREMENT UNCERTAINTY	9
3 . GENERAL INFORMATION	10
3.1 GENERAL DESCRIPTION OF EUT	10
3.2 DESCRIPTION OF TEST MODES	12
3.3 TABLE OF PARAMETERS OF TEXT SOFTWARE SETTING	12
3.4 BLOCK DIAGRAM SHOWING THE CONFIGURATION OF SYSTEM TESTED	13
3.5 DESCRIPTION OF SUPPORT UNITS	13
4 . EMC EMISSION TEST	14
4.1 CONDUCTED EMISSION MEASUREMENT	14
4.1.1 POWER LINE CONDUCTED EMISSION LIMITS	14
4.1.2 TEST PROCEDURE	14
4.1.3 DEVIATION FROM TEST STANDARD	14
4.1.4 TEST SETUP	15
4.1.5 EUT OPERATING CONDITIONS	15
4.1.6 EUT TEST CONDITIONS	15
4.1.7 TEST RESULTS	15
4.2 RADIATED EMISSION MEASUREMENT	16
4.2.1 RADIATED EMISSION LIMITS	16
4.2.2 TEST PROCEDURE	17
4.2.3 DEVIATION FROM TEST STANDARD	17
4.2.4 TEST SETUP	18
4.2.5 EUT OPERATING CONDITIONS	19
4.2.6 EUT TEST CONDITIONS	19
4.2.7 TEST RESULTS (9KHZ TO 30MHZ)	19
4.2.8 TEST RESULTS (30MHZ TO 1000 MHZ)	20
4.2.9 TEST RESULTS (ABOVE 1000 MHZ)	20
5 . NUMBER OF HOPPING CHANNEL	21
5.1 APPLIED PROCEDURES	21
5.1.1 TEST PROCEDURE	21
5.1.2 DEVIATION FROM STANDARD	21
5.1.3 TEST SETUP	21
5.1.4 EUT OPERATION CONDITIONS	21
5.1.5 EUT TEST CONDITIONS	21
5.1.6 TEST RESULTS	21

Table of Contents	Page
6 . AVERAGE TIME OF OCCUPANCY	22
6.1 APPLIED PROCEDURES / LIMIT	22
6.1.1 TEST PROCEDURE	22
6.1.2 DEVIATION FROM STANDARD	22
6.1.3 TEST SETUP	22
6.1.4 EUT OPERATION CONDITIONS	23
6.1.5 EUT TEST CONDITIONS	23
6.1.6 TEST RESULTS	23
7 . HOPPING CHANNEL SEPARATION MEASUREMENT	24
7.1 APPLIED PROCEDURES / LIMIT	24
7.1.1 TEST PROCEDURE	24
7.1.2 DEVIATION FROM STANDARD	24
7.1.3 TEST SETUP	24
7.1.4 EUT TEST CONDITIONS	24
7.1.5 TEST RESULTS	24
8 . BANDWIDTH TEST	25
8.1 APPLIED PROCEDURES	25
8.1.1 TEST PROCEDURE	25
8.1.2 DEVIATION FROM STANDARD	25
8.1.3 TEST SETUP	25
8.1.4 EUT OPERATION CONDITIONS	25
8.1.5 EUT TEST CONDITIONS	25
8.1.6 TEST RESULTS	25
9 . PEAK OUTPUT POWER TEST	26
9.1 APPLIED PROCEDURES / LIMIT	26
9.1.1 TEST PROCEDURE	26
9.1.2 DEVIATION FROM STANDARD	26
9.1.3 TEST SETUP	26
9.1.4 EUT OPERATION CONDITIONS	26
9.1.5 EUT TEST CONDITIONS	26
9.1.6 TEST RESULTS	26
10 . ANTENNA CONDUCTED SPURIOUS EMISSION	27
10.1 APPLIED PROCEDURES / LIMIT	27
10.1.1 TEST PROCEDURE	27
10.1.2 DEVIATION FROM STANDARD	27
10.1.3 TEST SETUP	27
10.1.4 EUT OPERATION CONDITIONS	27
10.1.5 EUT TEST CONDITIONS	27
10.1.6 TEST RESULTS	27
11 . MEASUREMENT INSTRUMENTS LIST	28

Table of Contents	Page
ATTACHMENT A - CONDUCTED EMISSION	30
ATTACHMENT B - RADIATED EMISSION (9KHZ-30MHZ)	33
ATTACHMENT C - RADIATED EMISSION (30MHZ TO 1000MHZ)	35
ATTACHMENT D - RADIATED EMISSION (ABOVE 1000MHZ)	42
ATTACHMENT E - NUMBER OF HOPPING CHANNEL	67
ATTACHMENT F - AVERAGE TIME OF OCCUPANCY	69
ATTACHMENT G - HOPPING CHANNEL SEPARATION MEASUREMENT	82
ATTACHMENT H - BANDWIDTH	87
ATTACHMENT I - PEAK OUTPUT POWER	92
ATTACHMENT J - ANTENNA CONDUCTED SPURIOUS EMISSION	97

REPORT ISSUED HISTORY

Issued No.	Description	Issued Date
BTL-FCCP-1-1607C289	Original Issue.	Aug. 23, 2016

1. CERTIFICATION

Equipment : Notebook
Brand Name : RAZER
Model Name : RZ09-0166
Applicant : Razer Inc.
Manufacturer : Razer Inc.
Address : 201 3rd Street, Suite 900, San Francisco, CA 94103
Factory : RAZER TECHNOLOGY AND DEVELOPMENT (SHENZHEN) CO., LTD
Address : East Wing, 3rd Floor, Block 2, Phase 1 of Vision Shenzhen Business Park Keji
South Road, Hi-Tech Industrial Park, Shenzhen 518057, China
Date of Test : Jul. 28, 2016 ~ Aug. 22, 2016
Test Sample : Engineering Sample
Standard(s) : FCC Part15, Subpart C (15.247)/ ANSI C63.10-2013

The above equipment has been tested and found compliance with the requirement of the relative standards by BTL Inc.

The test data, data evaluation, and equipment configuration contained in our test report (Ref No. BTL-FCCP-1-1607C289) were obtained utilizing the test procedures, test instruments, test sites that has been accredited by the Authority of TAF according to the ISO-17025 quality assessment standard and technical standard(s).

Test results included in this report is only for the Bluetooth part.

2. SUMMARY OF TEST RESULTS

Test procedures according to the technical standard(s):

Applied Standard(s): 47 CFR Part 15, Subpart C;			
Standard(s) Section	Test Item	Judgment	Remark
15.207	Conducted Emission	PASS	
15.247(d)	Antenna conducted Spurious Emission	PASS	
15.247 (a)(1)	Hopping Channel Separation	PASS	
15.247(a)(1)	Bandwidth	PASS	
15.247 (b)(1)	Peak Output Power	PASS	
15.247(d) 15.209	Radiated Spurious Emission	PASS	
15.247 (a)(1)(iii)	Number of Hopping Frequency	PASS	
15.247 (a)(1)(iii)	Dwell Time	PASS	
15.205	Restricted Bands	PASS	
15.203	Antenna Requirement	PASS	

Note:

(1) "N/A" denotes test is not applicable in this test report

2.1 TEST FACILITY

The test facilities used to collect the test data in this report is at the location of No.3, Jinshagang 1st Road, Shixia, Dalang Town, Dongguan, Guangdong, China.
 BTL's test firm number for FCC: 319330

2.2 MEASUREMENT UNCERTAINTY

Where relevant, the following measurement uncertainty levels have been estimated for tests performed on the EUT as specified in CISPR 16-4-2. The measurement instrumentation uncertainty considerations contained in CISPR 16-4-2.

The reported uncertainty of measurement $y \pm U$, where expanded uncertainty U is based on a standard uncertainty multiplied by a coverage factor of $k=2$, providing a level of confidence of approximately **95 %**.

A. Conducted Measurement :

Test Site	Method	Measurement Frequency Range	U, (dB)
DG-C02	CISPR	150 KHz ~ 30MHz	2.32

B. Radiated Measurement :

Test Site	Method	Measurement Frequency Range	Ant. H / V	U, (dB)
DG-CB03	CISPR	9KHz~30MHz	V	3.79
		9KHz~30MHz	H	3.57
		30MHz ~ 200MHz	V	3.82
		30MHz ~ 200MHz	H	3.78
		200MHz ~ 1,000MHz	V	4.10
		200MHz ~ 1,000MHz	H	4.06
		1GHz~18GHz	V	3.12
		1GHz~18GHz	H	3.68
		18GHz~40GHz	V	4.15
		18GHz~40GHz	H	4.14

Note: Unless specifically mentioned, the uncertainty of measurement has not been taken into account to declare the compliance or non-compliance to the specification.

3. GENERAL INFORMATION

3.1 GENERAL DESCRIPTION OF EUT

Equipment	Notebook	
Brand Name	RAZER	
Model Name	RZ09-0166	
Model Difference	N/A	
Output Power (Max.)	Operation Frequency	2402~2480 MHz
	Modulation Technology	GFSK(1Mbps) $\pi/4$ -DQPSK(2Mbps)
	Bit Rate of Transmitter	8-DPSK(3Mbps)
	Output Power Max.	3.75 dBm(1Mbps) 4.10 dBm(3Mbps)
Power Source	#1 DC voltage supplied from AC/DC adapter. Brand/Model: Razer / RC30-0166 #2 Supplied from battery. Model:F1	
Power Rating	#1 I/P:100-240Vac,3.4A O/P:19Vdc,13.16A #2 11.4Vdc,8700mA	

Note:

1. For a more detailed features description, please refer to the manufacturer's specifications or the user's manual.

2. Channel List:

Channel	Frequency (MHz)	Channel	Frequency (MHz)	Channel	Frequency (MHz)
00	2402	27	2429	54	2456
01	2403	28	2430	55	2457
02	2404	29	2431	56	2458
03	2405	30	2432	57	2459
04	2406	31	2433	58	2460
05	2407	32	2434	59	2461
06	2408	33	2435	60	2462
07	2409	34	2436	61	2463
08	2410	35	2437	62	2464
09	2411	36	2438	63	2465
10	2412	37	2439	64	2466
11	2413	38	2440	65	2467
12	2414	39	2441	66	2468
13	2415	40	2442	67	2469
14	2416	41	2443	68	2470
15	2417	42	2444	69	2471
16	2418	43	2445	70	2472
17	2419	44	2446	71	2473
18	2420	45	2447	72	2474
19	2421	46	2448	73	2475
20	2422	47	2449	74	2476
21	2423	48	2450	75	2477
22	2424	49	2451	76	2478
23	2425	50	2452	77	2479
24	2426	51	2453	78	2480
25	2427	52	2454		
26	2428	53	2455		

3. Table for Filed Antenna

Ant.	Brand	Model Name	Antenna Type	Connector	Gain (dBi)
1	INPAQ TECHNOLOGY CO.LTD	WA-F-LB-01-038	Internal	IPEX	1.15

3.2 DESCRIPTION OF TEST MODES

To investigate the maximum EMI emission characteristics generates from EUT, the test system was pre-scanning tested base on the consideration of following EUT operation mode or test configuration mode which possible have effect on EMI emission level. Each of these EUT operation mode(s) or test configuration mode(s) mentioned above was evaluated respectively.

Pretest Mode	Description
Mode 1	TX Mode Note (1)

The EUT system operated these modes were found to be the worst case during the pre-scanning test as following:

For Conducted Emission	
Final Test Mode	Description
Mode 1	TX Mode

For Radiated Emission	
Final Test Mode	Description
Mode 1	TX Mode Note (1)

Note:

- (1) The measurements are performed at the high, middle, low available channels.
- (2) The measurements for Hopping Channel Separation, Bandwidth and Peak Output Power were tested during 1Mbps, 2Mbps and 3Mbps, the worst case are 1Mbps and 3Mbps, only worst case was documented.

3.3 TABLE OF PARAMETERS OF TEXT SOFTWARE SETTING

During testing, channel & power controlling software provided by the customer was used to control the operating channel as well as the output power level. The RF output power selection is for the setting of RF output power expected by the customer and is going to be fixed on the firmware of the final end product power parameters of FHSS

Test Software Version	QCARCT		
Frequency	2402 MHz	2441 MHz	2480 MHz
Parameters(1Mbps)	8	8	8
Parameters(3Mbps)	8	8	8

3.4 BLOCK DIAGRAM SHOWING THE CONFIGURATION OF SYSTEM TESTED

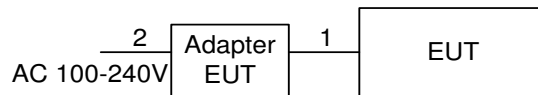

3.5 DESCRIPTION OF SUPPORT UNITS

The EUT has been tested as an independent unit together with other necessary accessories or support units. The following support units or accessories were used to form a representative test configuration during the tests.

Item	Equipment	Mfr/Brand	Model/Type No.	FCC ID	Series No.
-	-	-	-	-	-

Item	Shielded Type	Ferrite Core	Length	Note
1	NO	NO	1.8m	DC Cable
2	NO	NO	1m	AC Cable

4. EMC EMISSION TEST

4.1 CONDUCTED EMISSION MEASUREMENT

4.1.1 POWER LINE CONDUCTED EMISSION LIMITS (Frequency Range 150KHz-30MHz)

Frequency of Emission (MHz)	Conducted Limit (dB μ V)	
	Quasi-peak	Average
0.15 -0.50	66 to 56*	56 to 46*
0.50 -5.0	56	46
5.0 -30.0	60	50

Note:

- (1) The limit of " * " decreases with the logarithm of the frequency
- (2) The test result calculated as following:
 Measurement Value = Reading Level + Correct Factor
 Correct Factor = Insertion Loss + Cable Loss + Attenuator Factor(if use)
 Margin Level = Measurement Value - Limit Value

The following table is the setting of the receiver

Receiver Parameters	Setting
Attenuation	10 dB
Start Frequency	0.15 MHz
Stop Frequency	30 MHz
IF Bandwidth	9 KHz

4.1.2 TEST PROCEDURE

- a. The EUT was placed 0.8 meters from the horizontal ground plane with EUT being connected to the power mains through a line impedance stabilization network (LISN). All other support equipment powered from additional LISN(s). The LISN provide 50 Ohm/ 50uH of coupling impedance for the measuring instrument.
- b. Interconnecting cables that hang closer than 40 cm to the ground plane shall be folded back and forth in the center forming a bundle 30 to 40 cm long.
- c. I/O cables that are not connected to a peripheral shall be bundled in the center. The end of the cable may be terminated, if required, using the correct terminating impedance. The overall length shall not exceed 1 m.
- d. LISN at least 80 cm from nearest part of EUT chassis.
- e. For the actual test configuration, please refer to the related Item –EUT Test Photos.

4.1.3 DEVIATION FROM TEST STANDARD

No deviation

4.1.4 TEST SETUP

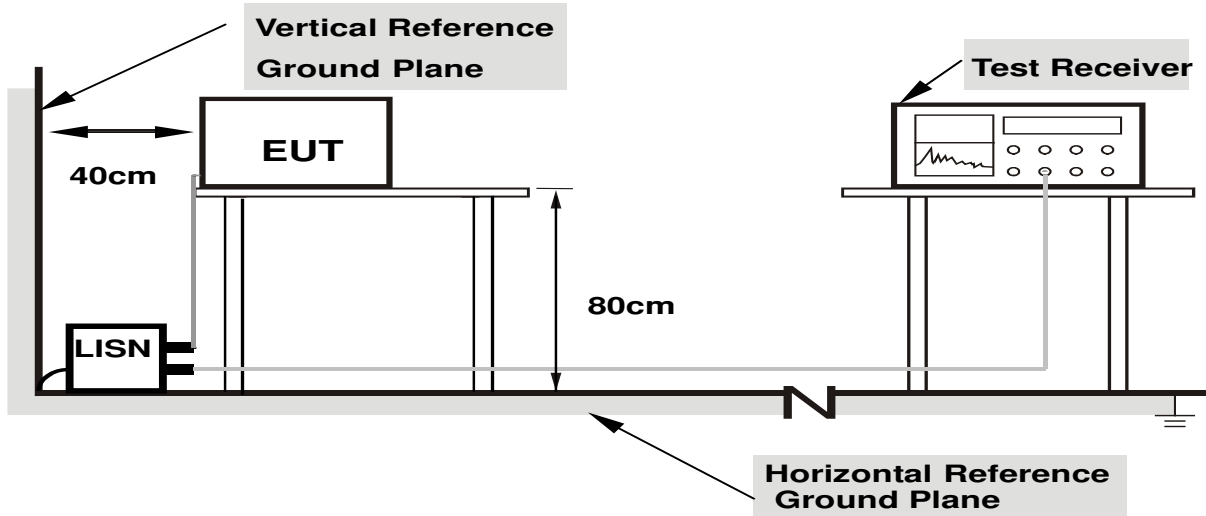

- Note:**
1. Support units were connected to second LISN.
 2. Both of LISNs (AMN) are 80 cm from EUT and at least 80 from other units and other metal planes

4.1.5 EUT OPERATING CONDITIONS

The EUT was configured for testing in a typical function (as a customer would normally use it), EUT was programmed to be in continuously transmitting/receiving data or hopping on mode.

4.1.6 EUT TEST CONDITIONS

Temperature: 25°C
 Relative Humidity: 55%
 Test Voltage: AC 120V/60Hz

4.1.7 TEST RESULTS

Please refer to the Attachment A.

Remark:

- (1) All readings are QP Mode value unless otherwise stated AVG in column of『Note』. If the QP Mode Measured value compliance with the QP Limits and lower than AVG Limits, the EUT shall be deemed to meet both QP & AVG Limits and then only QP Mode was measured, but AVG Mode didn't perform in this case, a "*" marked in AVG Mode column of Interference Voltage Measured.
- (2) Measuring frequency range from 150KHz to 30MHz.

4.2 RADIATED EMISSION MEASUREMENT

4.2.1 RADIATED EMISSION LIMITS (Frequency Range 9KHz -1000MHz)

In case the emission fall within the restricted band specified on 15.205(a), then the 15.209(a) limit in the table below has to be followed.

Frequency (MHz)	Field Strength (microvolts/meter)	Measurement Distance (meters)
0.009~0.490	2400/F(KHz)	300
0.490~1.705	24000/F(KHz)	30
1.705~30.0	30	30
30~88	100	3
88~216	150	3
216~960	200	3
960~1000	500	3

LIMITS OF RADIATED EMISSION MEASUREMENT (Above 1000MHz)

Frequency (MHz)	dB(uV/m) (at 3 meters)	
	Peak	Average
Above 1000	74	54

Notes:

- (1) The limit for radiated test was performed according to FCC PART 15C.
- (2) The tighter limit applies at the band edges.
- (3) Emission level (dBuV/m) = 20log Emission level (uV/m).
- (4) The test result calculated as following:
 Measurement Value = Reading Level + Correct Factor
 Correct Factor = Antenna Factor + Cable Loss - Amplifier Gain(if use)
 Margin Level = Measurement Value - Limit Value

Spectrum Parameter	Setting
Attenuation	Auto
Start Frequency	1000 MHz
Stop Frequency	10th carrier harmonic
RBW / VBW (emission in restricted band)	1 MHz / 1 MHz for Peak, 1 MHz / 10Hz for Average

Spectrum Receiver Parameter	Setting
Attenuation	Auto
Start ~ Stop Frequency	9KHz ~90KHz for PK/AVG detector
Start ~ Stop Frequency	90KHz ~110KHz for QP detector
Start ~ Stop Frequency	110KHz ~490KHz for PK/AVG detector
Start ~ Stop Frequency	490KHz ~30MHz for QP detector
Start ~ Stop Frequency	30MHz~1000MHz for QP detector

4.2.2 TEST PROCEDURE

- a. The measuring distance of at 3 m shall be used for measurements. The EUT was placed on the top of a rotating table 0.8 meter above the ground at a 3 meter semi-anechoic chamber. The table was rotated 360 degrees to determine the position of the highest radiation.(below 1GHz)
- b. The measuring distance of at 3 m shall be used for measurements. The EUT was placed on the top of a rotating table 1.5 meter above the ground at a 3 meter semi-anechoic chamber. The table was rotated 360 degrees to determine the position of the highest radiation.(above 1GHz)
- c. The height of the equipment or of the substitution antenna shall be 0.8m or 1.5m; the height of the test antenna shall vary between 1 m to 4 m. Both horizontal and vertical polarizations of the antenna are set to make the measurement.
- d. For each suspected emission, the EUT was arranged to its worst case and then the antenna was tuned to heights find the maximum reading (used Bore sight function).
- e. The receiver system was set to peak and average detect function and specified bandwidth with maximum hold mode when the test frequency is above 1GHz.
- f. The initial step in collecting conducted emission data is a receiver peak detector mode pre-scanning the measurement frequency range. Significant peaks are then marked and then Quasi Peak detector mode re-measured.
- g. All readings are Peak unless otherwise stated QP in column of Note. Peak denotes that the Peak reading compliance with the QP Limits and then QP Mode measurement didn't perform. (below 1GHz)
- h. All readings are Peak Mode value unless otherwise stated AVG in column of Note. If the Peak Mode Measured value compliance with the Peak Limits and lower than AVG Limits, the EUT shall be deemed to meet both Peak & AVG Limits and then only Peak Mode was measured, but AVG Mode didn't perform. (above 1GHz)
- i. For the actual test configuration, please refer to the related Item –EUT Test Photos.

4.2.3 DEVIATION FROM TEST STANDARD

No deviation

4.2.4 TEST SETUP

(A) Radiated Emission Test Set-Up Frequency Below 1 GHz

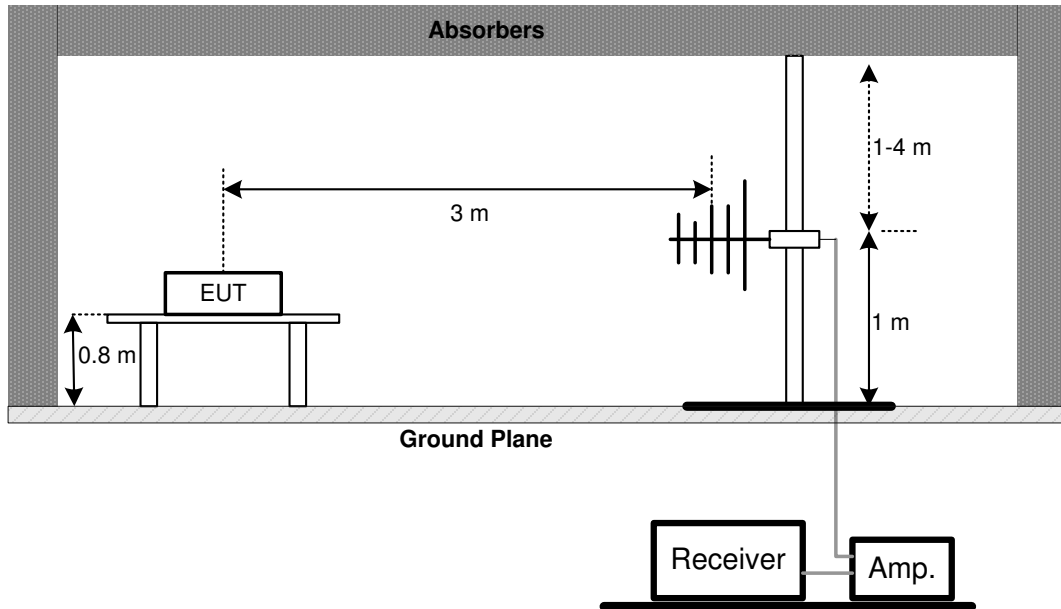

(B) Radiated Emission Test Set-Up Frequency Above 1 GHz

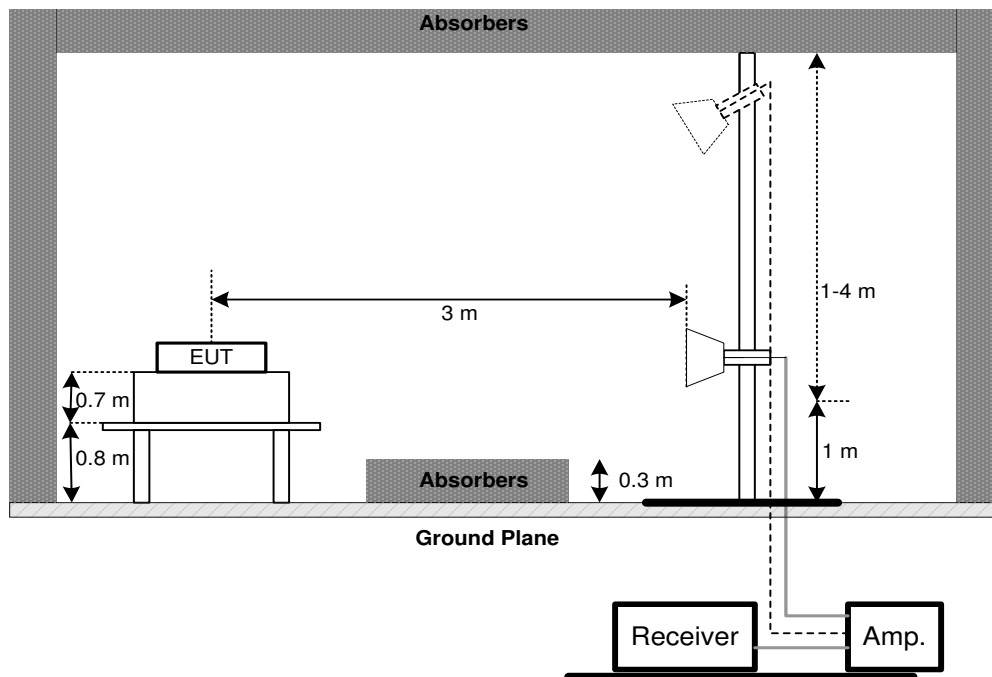

(C) For Radiated Emissions Below 30MHz

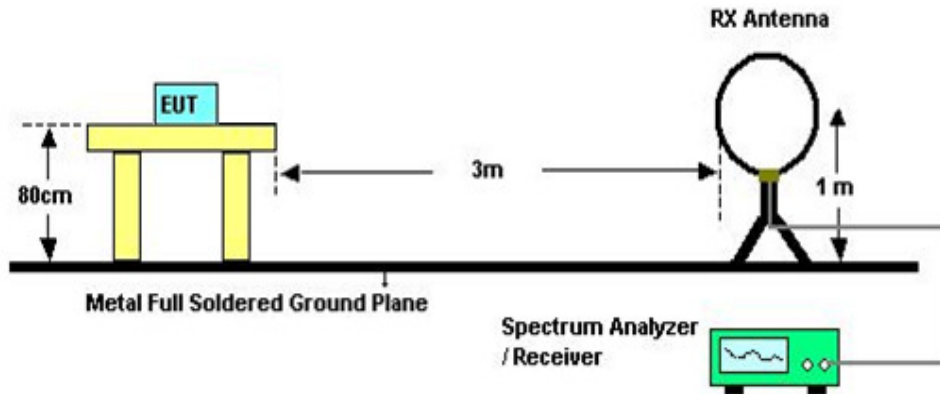

4.2.5 EUT OPERATING CONDITIONS

The EUT tested system was configured as the statements of 4.1.5 unless otherwise a special operating condition is specified in the follows during the testing

4.2.6 EUT TEST CONDITIONS

Temperature: 25°C
 Relative Humidity: 55%
 Test Voltage: AC 120V/60Hz

4.2.7 TEST RESULTS (9KHZ TO 30MHZ)

Please refer to the Attachment B

Remark:

- (1) The amplitude of spurious emissions which are attenuated by more than 20 dB below the permissible value has no need to be reported.
- (2) Distance extrapolation factor = $40 \log(\text{specific distance} / \text{test distance})$ (dB).
- (3) Limit line = specific limits (dBuV) + distance extrapolation factor.

4.2.8 TEST RESULTS (30MHZ TO 1000 MHZ)

Please refer to the Attachment C.

Remark:

- (1) Reading in which marked as QP or Peak means measurements by using are Quasi-Peak Mode or Peak Mode with Detector BW=120KHz; SPA setting in RBW=120KHz, VBW =120KHz, Swp. Time = 0.3 sec./MHz.
- (2) All readings are Peak unless otherwise stated QP in column of 『Note』. Peak denotes that the Peak reading compliance with the QP Limits and then QP Mode measurement didn't perform.
- (3) Measuring frequency range from 30MHz to 1000MHz.
- (4) If the peak scan value lower limit more than 20dB, then this signal data does not show in table.

4.2.9 TEST RESULTS (ABOVE 1000 MHZ)

Please refer to the Attachment D.

Remark:

- (1) Radiated emissions measured in frequency range above 1000MHz were made with an instrument using Peak detector mode and AV detector mode of the emission
- (2) A preamp and high pass filter were used for this test in order to provide sufficient measurement sensitivity.
- (3) EUT Orthogonal Axis:
"X" - denotes Laid on Table; "Y" - denotes Vertical Stand; "Z" - denotes Side Stand
- (4) During the measurements above 1 GHz it is taken care of that the EUT is always within the 3 dB cone of radiation BW of the used antenna
- (5) No limit: This is fundamental signal, the judgment is not applicable.
For fundamental signal judgment was referred to Peak output test.

5. NUMBER OF HOPPING CHANNEL

5.1 APPLIED PROCEDURES

FCC Part15 (15.247) , Subpart C			
Section	Test Item	Frequency Range (MHz)	Result
15.247(a)(1)(iii)	Number of Hopping Channel	2400-2483.5	PASS

Spectrum Parameters	Setting
Attenuation	Auto
Span Frequency	> Operating Frequency Range
RBW	100 KHz
VBW	100 KHz
Detector	Peak
Trace	Max Hold
Sweep Time	Auto

5.1.1 TEST PROCEDURE

- a. The EUT was directly connected to the spectrum analyzer and antenna output port as show in the block diagram below,
- b. Spectrum Setting: RBW=100KHz, VBW=100KHz, Sweep time = Auto.

5.1.2 DEVIATION FROM STANDARD

No deviation.

5.1.3 TEST SETUP



5.1.4 EUT OPERATION CONDITIONS

The EUT tested system was configured as the statements of 4.1.5 unless otherwise a special operating condition is specified in the follows during the testing.

5.1.5 EUT TEST CONDITIONS

Temperature: 25°C
 Relative Humidity: 55%
 Test Voltage: AC 120V/60Hz

5.1.6 TEST RESULTS

Please refer to the Attachment E

6. AVERAGE TIME OF OCCUPANCY

6.1 APPLIED PROCEDURES / LIMIT

FCC Part15 (15.247) , Subpart C				
Section	Test Item	Limit	Frequency Range (MHz)	Result
15.247(a)(1)(iii)	Average Time of Occupancy	0.4sec	2400-2483.5	PASS

6.1.1 TEST PROCEDURE

- a. The transmitter output (antenna port) was connected to the spectrum analyzer
- b. Set RBW of spectrum analyzer to 1MHz and VBW to 1MHz.
- c. Use a video trigger with the trigger level set to enable triggering only on full pulses.
- d. Sweep Time is more than once pulse time.
- e. Set the center frequency on any frequency would be measure and set the frequency span to zero span.
- f. Measure the maximum time duration of one single pulse.
- g. Set the EUT for DH5, DH3 and DH1 packet transmitting.
- h. Measure the maximum time duration of one single pulse.
- i. DH5 Packet permit maximum $1600 / 79 / 6 = 3.37$ hops per second in each channel (5 time slots TX, 1 time slot RX). So, the dwell time is the time duration of the pulse times $3.37 \times 31.6 = 106.6$ within 31.6 seconds.
- j. DH3 Packet permit maximum $1600 / 79 / 4 = 5.06$ hops per second in each channel (3 time slots TX, 1 time slot RX). So, the dwell time is the time duration of the pulse times $5.06 \times 31.6 = 160$ within 31.6 seconds.
- k. DH1 Packet permit maximum $1600 / 79 / 2 = 10.12$ hops per second in each channel (1 time slot TX, 1 time slot RX). So, the dwell time is the time duration of the pulse times $10.12 \times 31.6 = 320$ within 31.6 seconds.

6.1.2 DEVIATION FROM STANDARD

No deviation.

6.1.3 TEST SETUP

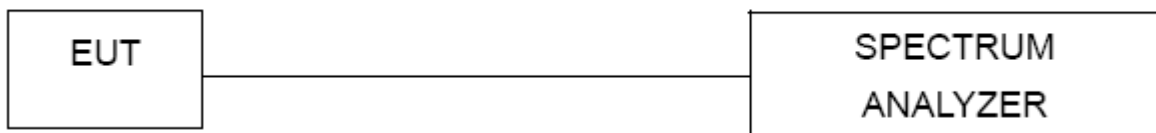

6.1.4 EUT OPERATION CONDITIONS

The EUT tested system was configured as the statements of 4.1.5 unless otherwise a special operating condition is specified in the follows during the testing.

6.1.5 EUT TEST CONDITIONS

Temperature: 25°C

Relative Humidity: 55%

Test Voltage: AC 120V/60Hz

6.1.6 TEST RESULTS

Please refer to the Attachment F

7. HOPPING CHANNEL SEPARATION MEASUREMENT

7.1 APPLIED PROCEDURES / LIMIT

Frequency hopping systems operating in the 2400-2483.5 MHz band may have hopping channel carrier frequencies that are separated by 25 KHz or two-thirds of the 20 dB bandwidth of the hopping channel, whichever is greater.

Spectrum Parameter	Setting
Attenuation	Auto
Span Frequency	> Measurement Bandwidth or Channel Separation
RBW	30 KHz
VBW	100 KHz
Detector	Peak
Trace	Max Hold
Sweep Time	Auto

7.1.1 TEST PROCEDURE

- a. The EUT must have its hopping function enabled
- b. Span = wide enough to capture the peaks of two adjacent channels
 - Resolution (or IF) Bandwidth (RBW) \geq 1% of the span
 - Video (or Average) Bandwidth (VBW) \geq RBW
 - Sweep = Auto
 - Detector function = Peak
 - Trace = Max Hold

7.1.2 DEVIATION FROM STANDARD

No deviation.

7.1.3 TEST SETUP

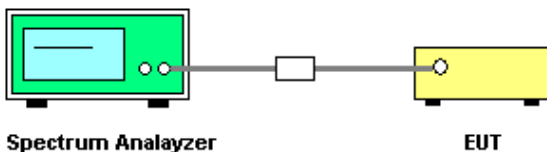

7.1.4 EUT TEST CONDITIONS

Temperature: 25°C
 Relative Humidity: 55%
 Test Voltage: AC 120V/60Hz

7.1.5 TEST RESULTS

Please refer to the Attachment G

8. BANDWIDTH TEST

8.1 APPLIED PROCEDURES

FCC Part15 (15.247) , Subpart C		
Section	Test Item	Frequency Range (MHz)
15.247(a)(2)	Bandwidth	2400-2483.5

Spectrum Parameter	Setting
Attenuation	Auto
Span Frequency	> Measurement Bandwidth or Channel Separation
RBW	30 KHz (20dB Bandwidth) / 30 KHz (Channel Separation)
VBW	100 KHz (20dB Bandwidth) / 100 KHz (Channel Separation)
Detector	Peak
Trace	Max Hold
Sweep Time	Auto

8.1.1 TEST PROCEDURE

- a. The EUT was directly connected to the spectrum analyzer and antenna output port as show in the block diagram below,
- b. Spectrum Setting: RBW= 30KHz, VBW=100KHz, Sweep Time = Auto.

8.1.2 DEVIATION FROM STANDARD

No deviation.

8.1.3 TEST SETUP

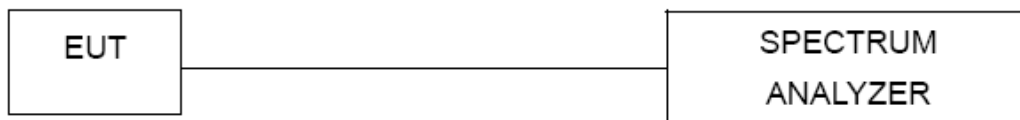

8.1.4 EUT OPERATION CONDITIONS

The EUT tested system was configured as the statements of 4.1.5 unless otherwise a special operating condition is specified in the follows during the testing.

8.1.5 EUT TEST CONDITIONS

Temperature: 25°C
 Relative Humidity: 55%
 Test Voltage: AC 120V/60Hz

8.1.6 TEST RESULTS

Please refer to the Attachment H

9. PEAK OUTPUT POWER TEST

9.1 APPLIED PROCEDURES / LIMIT

FCC Part15 (15.247) , Subpart C				
Section	Test Item	Limit	Frequency Range (MHz)	Result
15.247(b)(1)	Peak Output Power	1 Watt or 30dBm (hopping channel >75) 0.125Watt or 21dBm (hopping channel <75)	2400-2483.5	PASS

9.1.1 TEST PROCEDURE

- a. The EUT was directly connected to the spectrum analyzer and antenna output port as show in the block diagram below,
- b. Spectrum Setting: RBW= 1MHz/3MHz, VBW= 1MHz/3MHz, Sweep time = Auto.

9.1.2 DEVIATION FROM STANDARD

No deviation.

9.1.3 TEST SETUP



9.1.4 EUT OPERATION CONDITIONS

The EUT tested system was configured as the statements of 4.1.5 unless otherwise a special operating condition is specified in the follows during the testing.

9.1.5 EUT TEST CONDITIONS

Temperature: 25°C
Relative Humidity: 55%
Test Voltage: AC 120V/60Hz

9.1.6 TEST RESULTS

Please refer to the Attachment I

10. ANTENNA CONDUCTED SPURIOUS EMISSION

10.1 APPLIED PROCEDURES / LIMIT

In any 100 kHz bandwidth outside the frequency band in which the spread spectrum or digitally modulated device is operating, the RF power that is produced shall be at least 20 dB below that in the 100 kHz bandwidth within the band that contains the highest level of the desired power, based on either an RF conducted or a radiated measurement, provided that the transmitter demonstrates compliance with the peak conducted power limits.

10.1.1 TEST PROCEDURE

- a. The EUT was directly connected to the spectrum analyzer and antenna output port as show in the block diagram below,
- b. Spectrum Setting: RBW= 100KHz, VBW=100KHz, Sweep time = Auto.
- c. Offset=antenna gain+cable loss

10.1.2 DEVIATION FROM STANDARD

No deviation.

10.1.3 TEST SETUP



10.1.4 EUT OPERATION CONDITIONS

The EUT tested system was configured as the statements of 4.1.5 unless otherwise a special operating condition is specified in the follows during the testing.

10.1.5 EUT TEST CONDITIONS

Temperature: 25°C

Relative Humidity: 55%

Test Voltage: AC 120V/60Hz

10.1.6 TEST RESULTS

Please refer to the Attachment J

11. MEASUREMENT INSTRUMENTS LIST

Conducted Emission Measurement					
Item	Kind of Equipment	Manufacturer	Type No.	Serial No.	Calibrated until
1	LISN	EMCO	3816/2	0052765	Mar. 27, 2017
2	LISN	R&S	ENV216	101447	Mar. 27, 2017
3	Test Cable	emci	RG223(9KHz-30 MHz)	C_17	Mar. 10, 2017
4	EMI Test Receiver	R&S	ESCI	100382	Mar. 27, 2017
5	50Ω Terminator	SHX	TF2-3G-A	08122901	Mar. 27, 2017
6	Measurement Software	Farad	EZ-EMC Ver.NB-03A1-01	N/A	N/A

Radiated Emission Measurement					
Item	Kind of Equipment	Manufacturer	Type No.	Serial No.	Calibrated until
1	Antenna	Schwarbeck	VULB9160	9160-3232	Mar. 27, 2017
2	Amplifier	HP	8447D	2944A09673	Nov. 09, 2016
3	Receiver	AGILENT	N9038A	MY52130039	Oct. 11, 2016
4	Test Cable	emci	LMR-400(30MHz-1GHz)	C-01	Jun. 26, 2017
5	Control	CT	SC100	N/A	N/A
6	Position Control	MF	MF-7802	MF780208416	N/A
7	Antenna	ETS	3115	00075789	Mar. 27, 2017
8	Amplifier	Agilent	8449B	3008A02274	Nov. 01, 2016
9	Receiver	AGILENT	N9038A	MY52130039	Oct. 11, 2016
10	Test Cable	emci	EMC104-SM-S M-10000(1GHz-26.5GHz)	C-68	Jun. 26, 2017
11	Controller	CT	SC100	N/A	N/A
12	Broad-Band Horn Antenna	Schwarzbeck	BBHA 9170	9170319	Apr. 23, 2017
13	Microwave Preamplifier With Adaptor	EMC INSTRUMENT	EMC2654045	980039 & HA01	Mar. 27, 2017
14	Active Loop Antenna	R&S	HFH2-Z2	830749/020	Sep. 07, 2016
15	Measurement Software	Farad	EZ-EMC Ver.NB-03A1-01	N/A	N/A

Number of Hopping Channel					
Item	Kind of Equipment	Manufacturer	Type No.	Serial No.	Calibrated until
1	Spectrum Analyzer	R&S	FSP 40	100185	Oct. 11, 2016

Average Time of Occupancy					
Item	Kind of Equipment	Manufacturer	Type No.	Serial No.	Calibrated until
1	Spectrum Analyzer	R&S	FSP 40	100185	Oct. 11, 2016

Hopping Channel Separation Measurement					
Item	Kind of Equipment	Manufacturer	Type No.	Serial No.	Calibrated until
1	Spectrum Analyzer	R&S	FSP 40	100185	Oct. 11, 2016

Bandwidth					
Item	Kind of Equipment	Manufacturer	Type No.	Serial No.	Calibrated until
1	Spectrum Analyzer	R&S	FSP 40	100185	Oct. 11, 2016

Peak Output Power					
Item	Kind of Equipment	Manufacturer	Type No.	Serial No.	Calibrated until
1	Spectrum Analyzer	R&S	FSP 40	100185	Oct. 11, 2016

Antenna Conducted Spurious Emission					
Item	Kind of Equipment	Manufacturer	Type No.	Serial No.	Calibrated until
1	Spectrum Analyzer	R&S	FSP 40	100185	Oct. 11, 2016

Remark: "N/A" denotes no model name, serial no. or calibration specified.
 All calibration period of equipment list is one year.

ATTACHMENT A - CONDUCTED EMISSION

Test Mode: TX Mode

Line

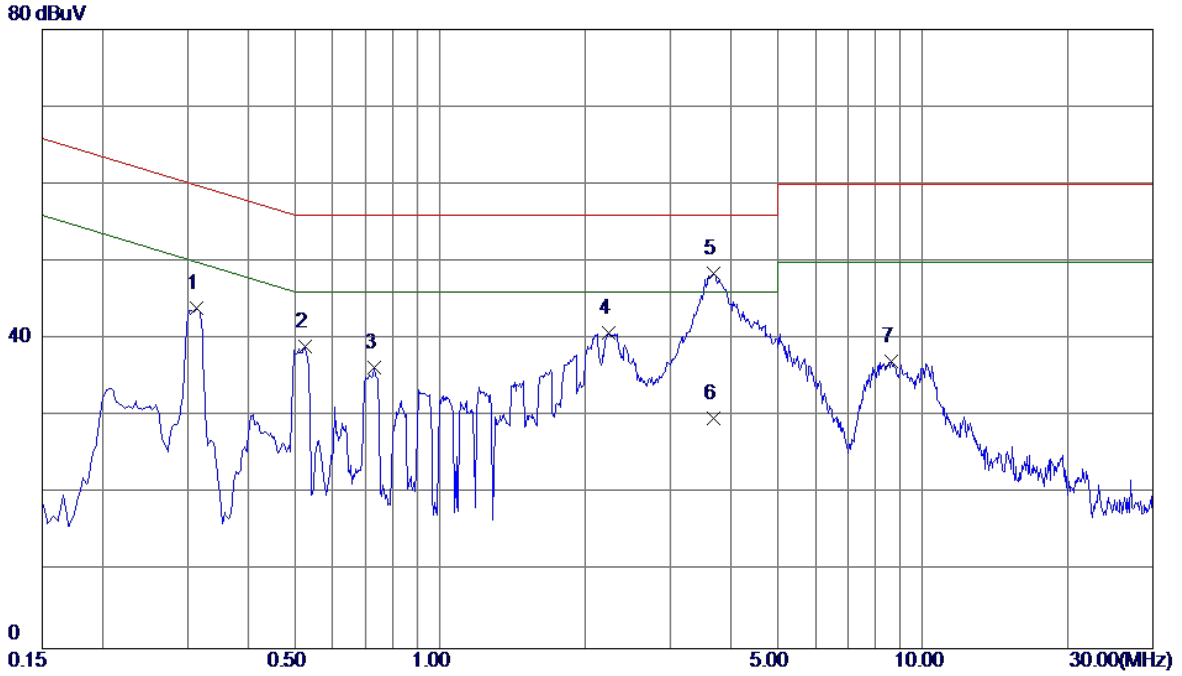

No.	Freq. MHz	Reading Level dBuV	Correct Factor dB	Measure ment dBuV	Limit dBuV	Margin dB	Detector	Comment
1	0.3140	34.40	9.53	43.93	59.86	-15.93	Peak	
2	0.5260	29.37	9.64	39.01	56.00	-16.99	Peak	
3	0.7300	26.60	9.68	36.28	56.00	-19.72	Peak	
4	2.2340	30.79	9.98	40.77	56.00	-15.23	Peak	
5 *	3.6940	38.32	10.16	48.48	56.00	-7.52	Peak	
6	3.6940	19.60	10.16	29.76	46.00	-16.24	AVG	
7	8.6059	27.00	10.19	37.19	60.00	-22.81	Peak	

Test Mode: TX Mode

Neutral

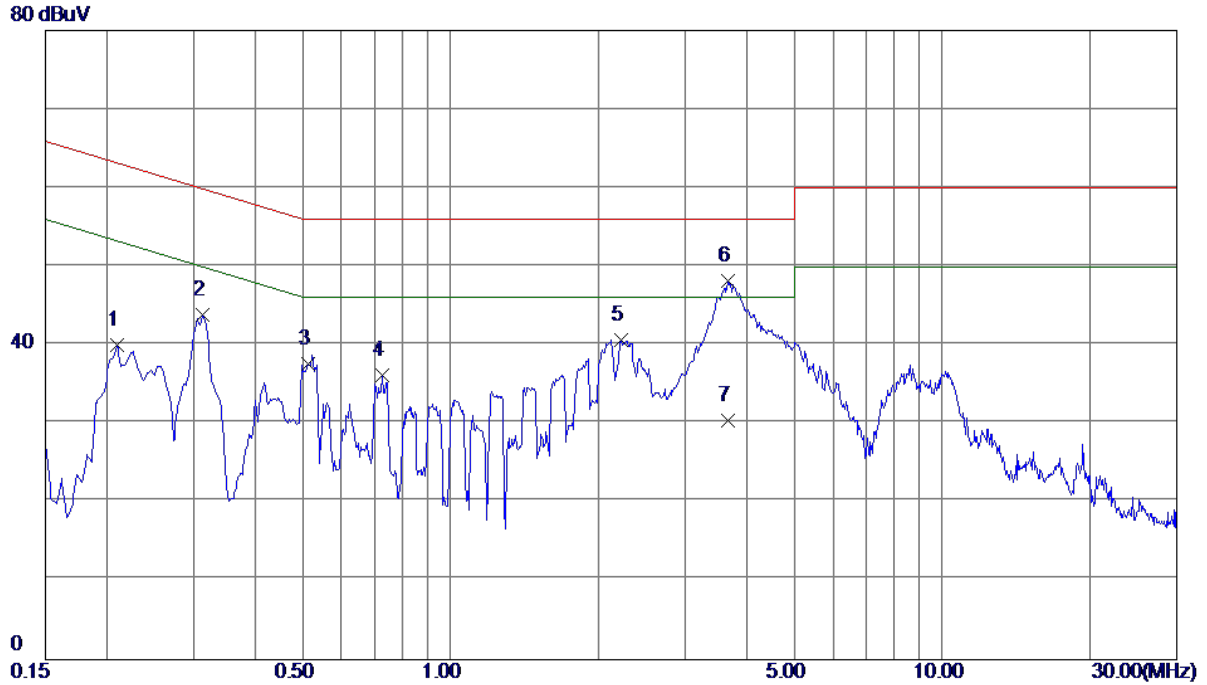

No.	Freq. MHz	Reading Level dBuV	Correct Factor dB	Measure ment dBuV	Limit dBuV	Margin dB	Detector	Comment
1	0.2100	30.50	9.53	40.03	63.21	-23.18	Peak	
2	0.3140	34.34	9.53	43.87	59.86	-15.99	Peak	
3	0.5140	28.12	9.44	37.56	56.00	-18.44	Peak	
4	0.7260	26.74	9.47	36.21	56.00	-19.79	Peak	
5	2.2300	30.97	9.74	40.71	56.00	-15.29	Peak	
6 *	3.6780	38.34	9.86	48.20	56.00	-7.80	Peak	
7	3.6780	20.50	9.86	30.36	46.00	-15.64	AVG	

ATTACHMENT B - RADIATED EMISSION (9KHZ-30MHZ)

Test Mode:	TX Mode
------------	---------

Frequency (MHz)	Ant 0°/90°	Read level dBuV/m	Factor (dB)	Measured(FS) (dBuV/m)	Limit (dBuV/m)	Margin (dB)	Note
0.0092	0°	13.41	24.9840	38.3940	128.3285	-89.9345	AVG
0.0092	0°	14.28	24.9840	39.2640	148.3285	-109.0645	PEAK
0.0274	0°	6.73	23.8313	30.5613	118.8492	-88.2879	AVG
0.0274	0°	8.12	23.8313	31.9513	138.8492	-106.8979	PEAK
0.0365	0°	3.17	23.2550	26.4250	116.3584	-89.9334	AVG
0.0365	0°	5.58	23.2550	28.8350	136.3584	-107.5234	PEAK
0.0534	0°	1.16	22.3320	23.4920	113.0534	-89.5614	AVG
0.0534	0°	2.53	22.3320	24.8620	133.0534	-108.1914	PEAK
0.5152	0°	19.36	19.8486	39.2086	73.3647	-34.1561	QP
1.9542	0°	23.71	19.5046	43.2146	69.5400	-26.3254	QP

Frequency (MHz)	Ant 0°/90°	Read level dBuV/m	Factor (dB)	Measured(FS) (dBuV/m)	Limit (dBuV/m)	Margin (dB)	Note
0.0127	90°	13.16	24.3000	37.4600	125.5282	-88.0682	AVG
0.0127	90°	14.89	24.3000	39.1900	145.5282	-106.3382	PEAK
0.0259	90°	7.28	23.9263	31.2063	119.3382	-88.1319	AVG
0.0259	90°	8.94	23.9263	32.8663	139.3382	-106.4719	PEAK
0.0413	90°	5.23	22.9510	28.1810	115.2852	-87.1042	AVG
0.0413	90°	6.19	22.9510	29.1410	135.2852	-106.1442	PEAK
0.0557	90°	1.54	22.2860	23.8260	112.6871	-88.8611	AVG
0.0557	90°	2.86	22.2860	25.1460	132.6871	-107.5411	PEAK
0.6262	90°	22.17	20.2038	42.3738	71.6700	-29.2961	QP
2.0514	90°	24.56	19.4692	44.0292	69.5400	-25.5108	QP

ATTACHMENT C - RADIATED EMISSION (30MHZ TO 1000MHZ)

Test Mode: TX 2402MHz _CH00_1Mbps

Vertical

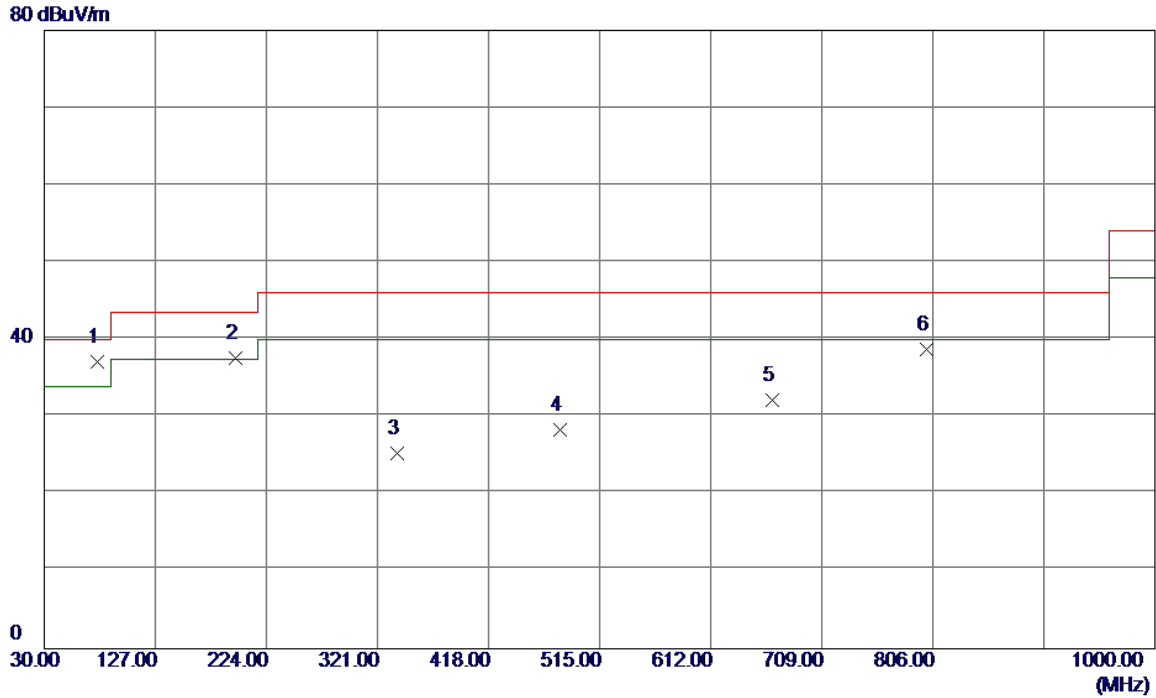

No.	Freq. MHz	Reading Level dBuV/m	Correct Factor dB	Measure ment dBuV/m	Limit dBuV/m	Margin dB	Detector	Comment
1 *	76.5600	53.50	-16.42	37.08	40.00	-2.92	QP	
2	196.8400	51.87	-14.27	37.60	43.50	-5.90	Peak	
3	338.4600	36.23	-10.98	25.25	46.00	-20.75	Peak	
4	480.0800	37.37	-9.03	28.34	46.00	-17.66	Peak	
5	666.3200	35.60	-3.50	32.10	46.00	-13.90	Peak	
6	800.1800	38.42	0.25	38.67	46.00	-7.33	Peak	

Test Mode: TX 2402MHz _CH00_ 1Mbps

Horizontal

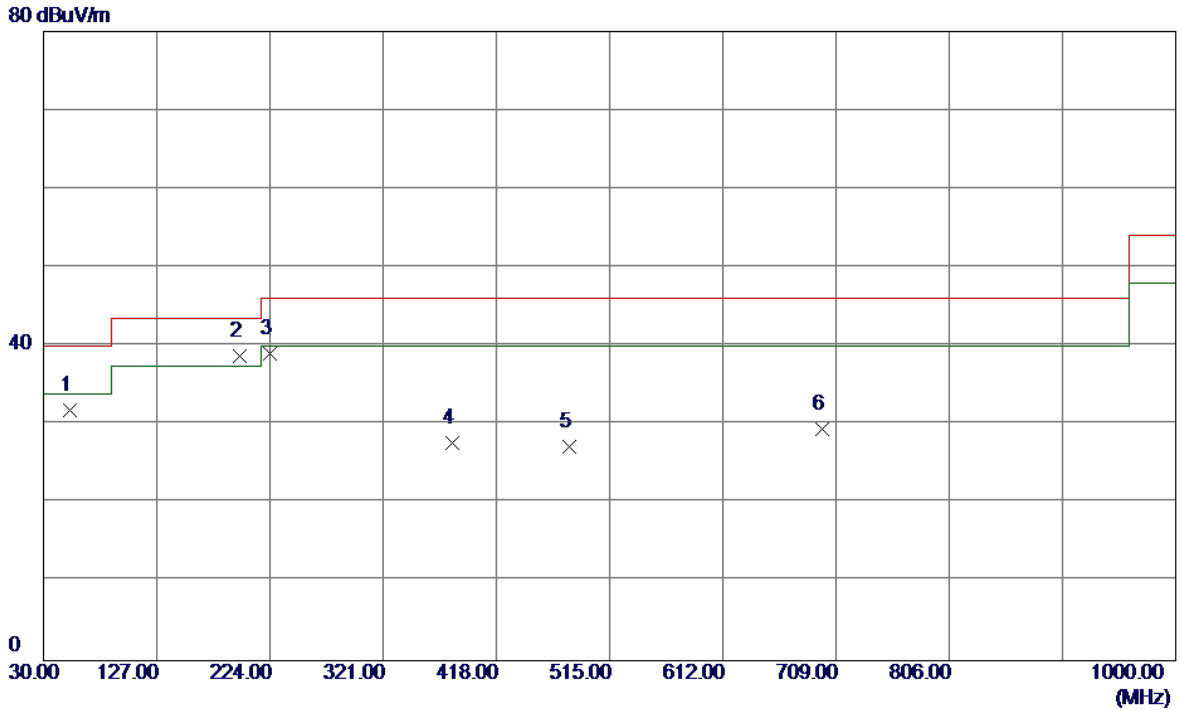

No.	Freq. MHz	Reading Level dBuV/m	Correct Factor dB	Measure ment dBuV/m	Limit dBuV/m	Margin dB	Detector	Comment
1	52.3100	45.74	-13.84	31.90	40.00	-8.10	Peak	
2 *	197.8100	52.97	-14.32	38.65	43.50	-4.85	Peak	
3	224.0000	53.00	-13.90	39.10	46.00	-6.90	Peak	
4	380.1700	36.88	-9.14	27.74	46.00	-18.26	Peak	
5	480.0800	36.19	-9.03	27.16	46.00	-18.84	Peak	
6	697.3600	31.59	-2.21	29.38	46.00	-16.62	Peak	

Test Mode: TX 2441MHz _CH39_1Mbps

Vertical

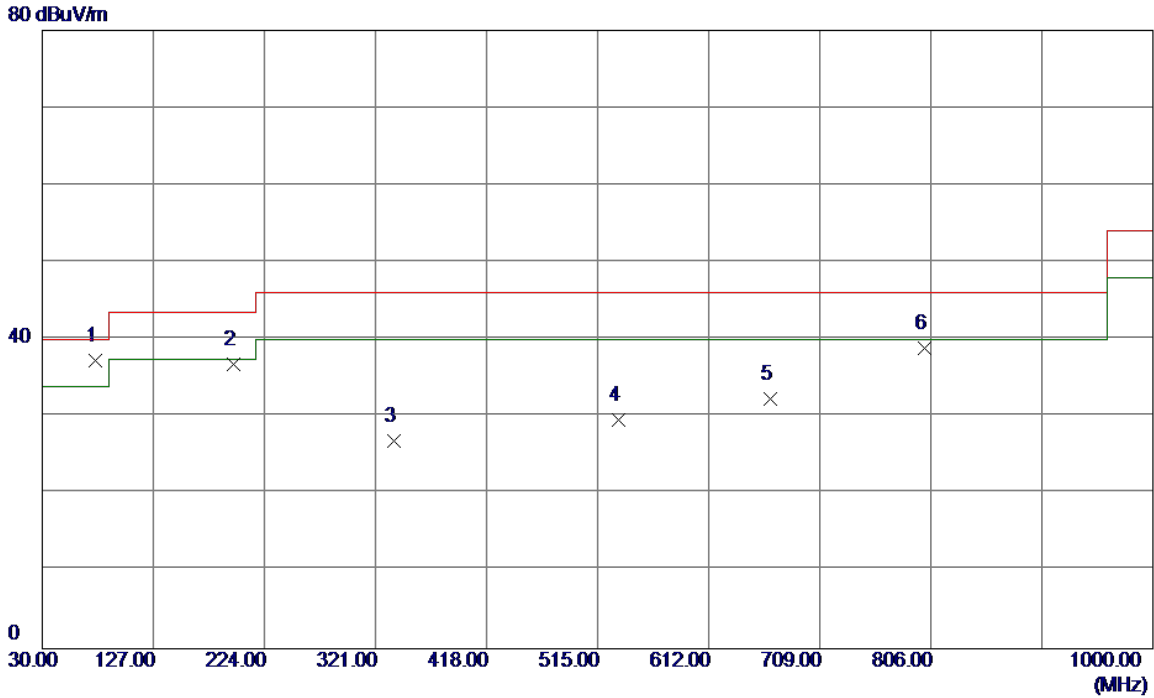

No.	Freq. MHz	Reading Level dBuV/m	Correct Factor dB	Measure ment dBuV/m	Limit dBuV/m	Margin dB	Detector	Comment
1 *	76.5600	53.76	-16.42	37.34	40.00	-2.66	QP	
2	196.8400	51.12	-14.27	36.85	43.50	-6.65	Peak	
3	337.4900	37.82	-10.95	26.87	46.00	-19.13	Peak	
4	533.4300	35.84	-6.26	29.58	46.00	-16.42	Peak	
5	666.3200	35.75	-3.50	32.25	46.00	-13.75	Peak	
6	800.1800	38.61	0.25	38.86	46.00	-7.14	Peak	

Test Mode: TX 2441MHz _CH39_ 1Mbps

Horizontal

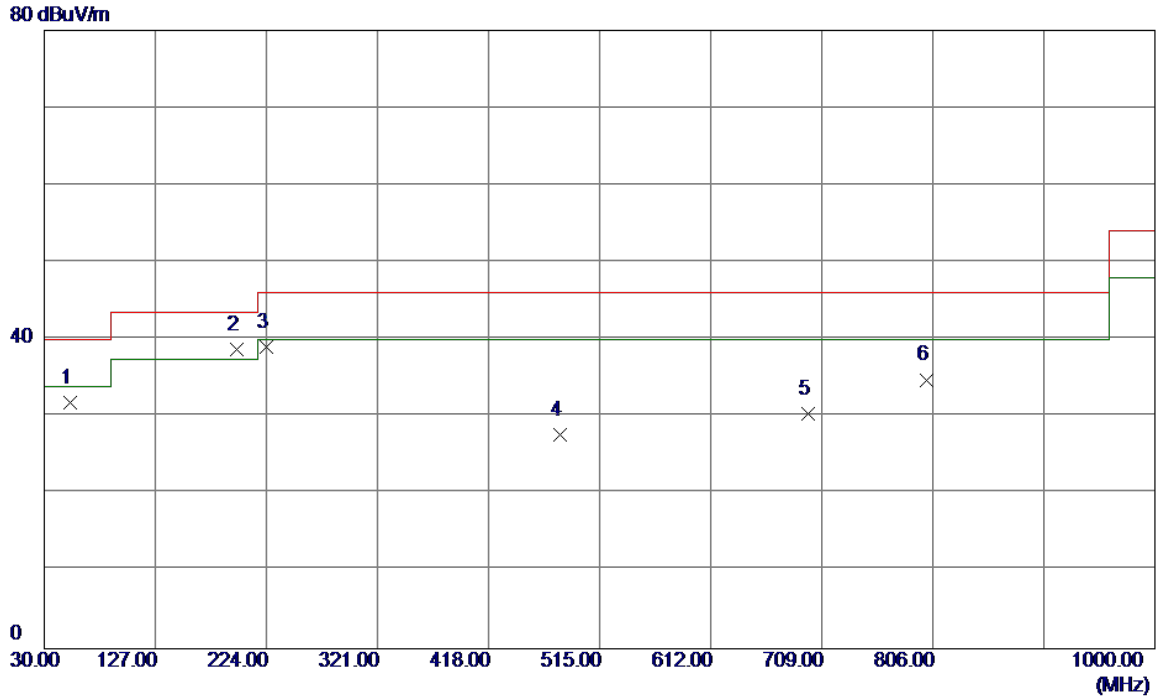

No.	Freq. MHz	Reading Level dBuV/m	Correct Factor dB	Measure ment dBuV/m	Limit dBuV/m	Margin dB	Detector	Comment
1	52.3100	45.74	-13.84	31.90	40.00	-8.10	Peak	
2 *	197.8100	52.97	-14.32	38.65	43.50	-4.85	Peak	
3	224.0000	53.00	-13.90	39.10	46.00	-6.90	Peak	
4	480.0800	36.77	-9.03	27.74	46.00	-18.26	Peak	
5	697.3600	32.58	-2.21	30.37	46.00	-15.63	Peak	
6	800.1800	34.55	0.25	34.80	46.00	-11.20	Peak	

Test Mode: TX 2480MHz _CH78_ 1Mbps

Vertical

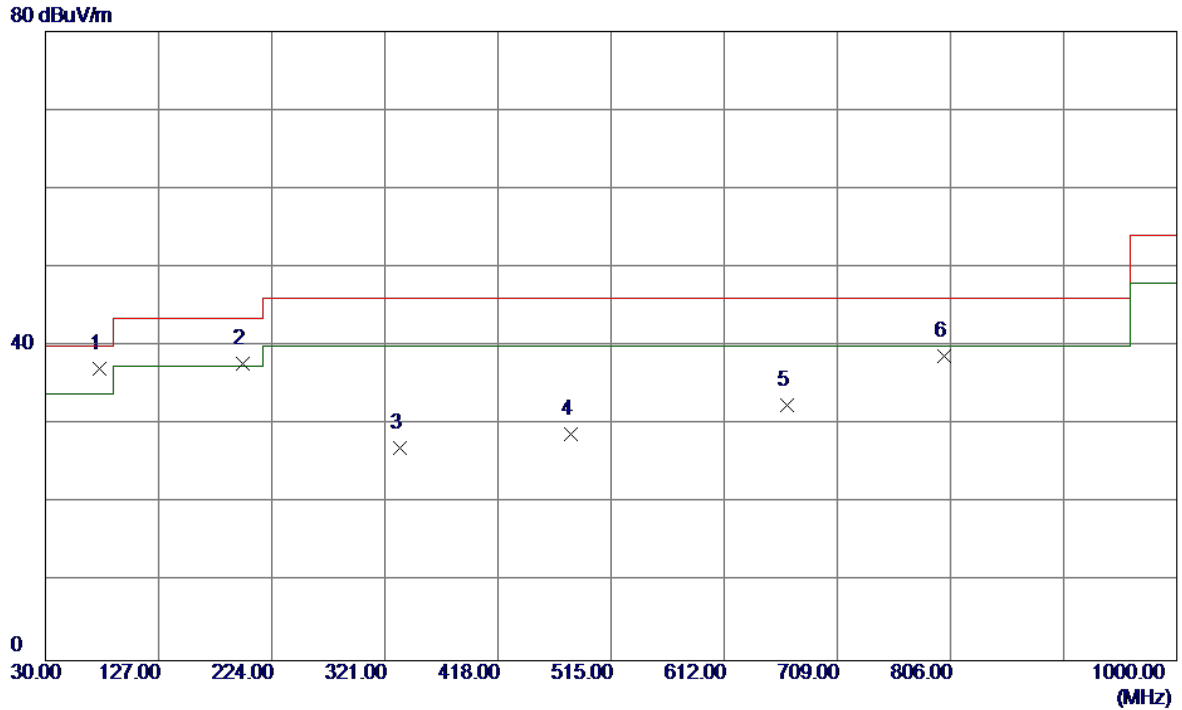

No.	Freq. MHz	Reading Level dBuV/m	Correct Factor dB	Measure ment dBuV/m	Limit dBuV/m	Margin dB	Detector	Comment
1 *	76.5600	53.47	-16.42	37.05	40.00	-2.95	QP	
2	198.7800	52.09	-14.37	37.72	43.50	-5.78	Peak	
3	333.6099	37.98	-10.87	27.11	46.00	-18.89	Peak	
4	480.0800	37.76	-9.03	28.73	46.00	-17.27	Peak	
5	666.3200	35.93	-3.50	32.43	46.00	-13.57	Peak	
6	800.1800	38.49	0.25	38.74	46.00	-7.26	Peak	

Test Mode: TX 2480MHz _CH78_ 1Mbps

Horizontal

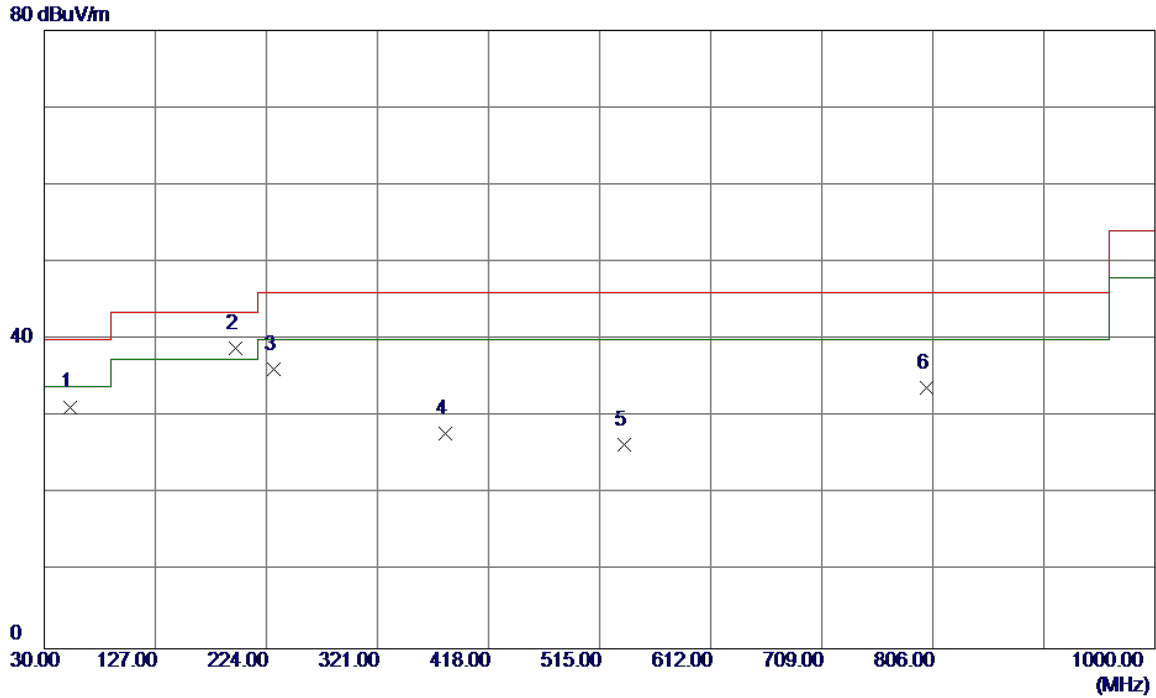

No.	Freq. MHz	Reading Level dBuV/m	Correct Factor dB	Measure ment dBuV/m	Limit dBuV/m	Margin dB	Detector	Comment
1	52.3100	45.12	-13.84	31.28	40.00	-8.72	Peak	
2 *	196.8400	53.18	-14.27	38.91	43.50	-4.59	Peak	
3	230.7900	49.53	-13.40	36.13	46.00	-9.87	Peak	
4	380.1700	36.98	-9.14	27.84	46.00	-18.16	Peak	
5	536.3400	32.36	-5.96	26.40	46.00	-19.60	Peak	
6	800.1800	33.47	0.25	33.72	46.00	-12.28	Peak	

ATTACHMENT D - RADIATED EMISSION (ABOVE 1000MHZ)

Test Mode : TX 2402MHz _CH00_1Mbps

Vertical

120 dBuV/m

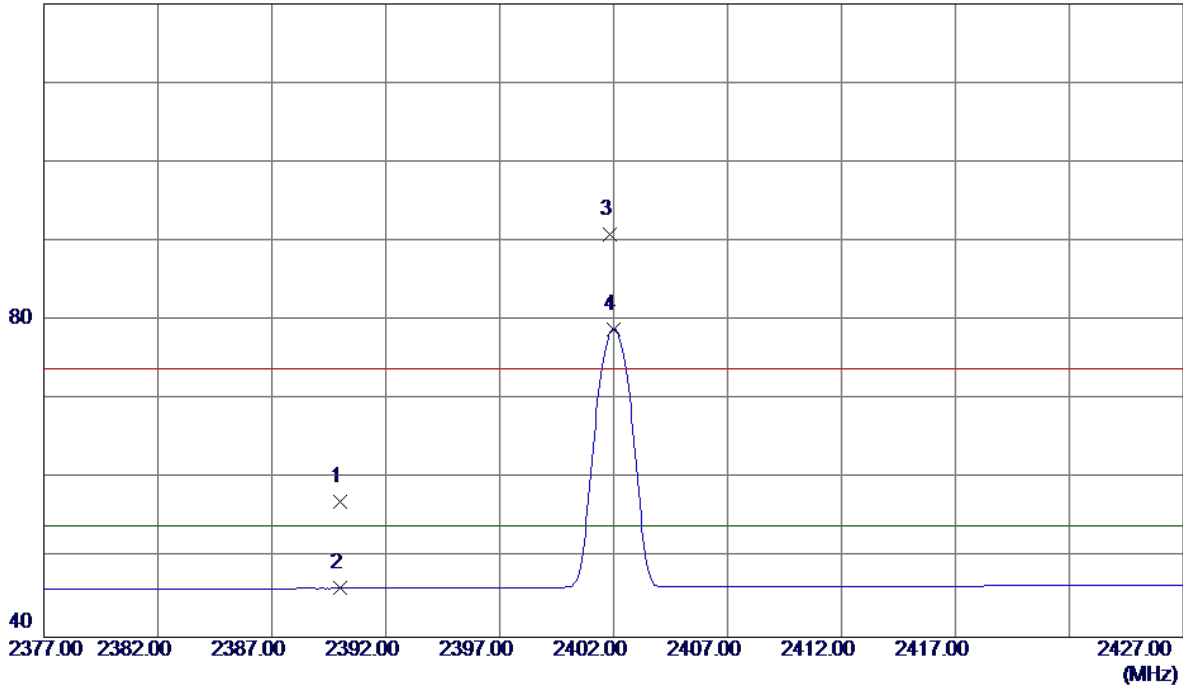

No.	Freq. MHz	Reading Level dBuV/m	Correct Factor dB	Measure ment dBuV/m	Limit dBuV/m	Margin dB	Detector	Comment
1	2390.0000	24.09	33.01	57.10	74.00	-16.90	Peak	
2	2390.0000	13.16	33.01	46.17	54.00	-7.83	AVG	
3	2401.8500	57.88	33.06	90.94	74.00	16.94	Peak	No Limit
4 *	2402.0000	45.86	33.06	78.92	54.00	24.92	AVG	No Limit

Test Mode : TX 2402MHz _CH00_1Mbps

Vertical

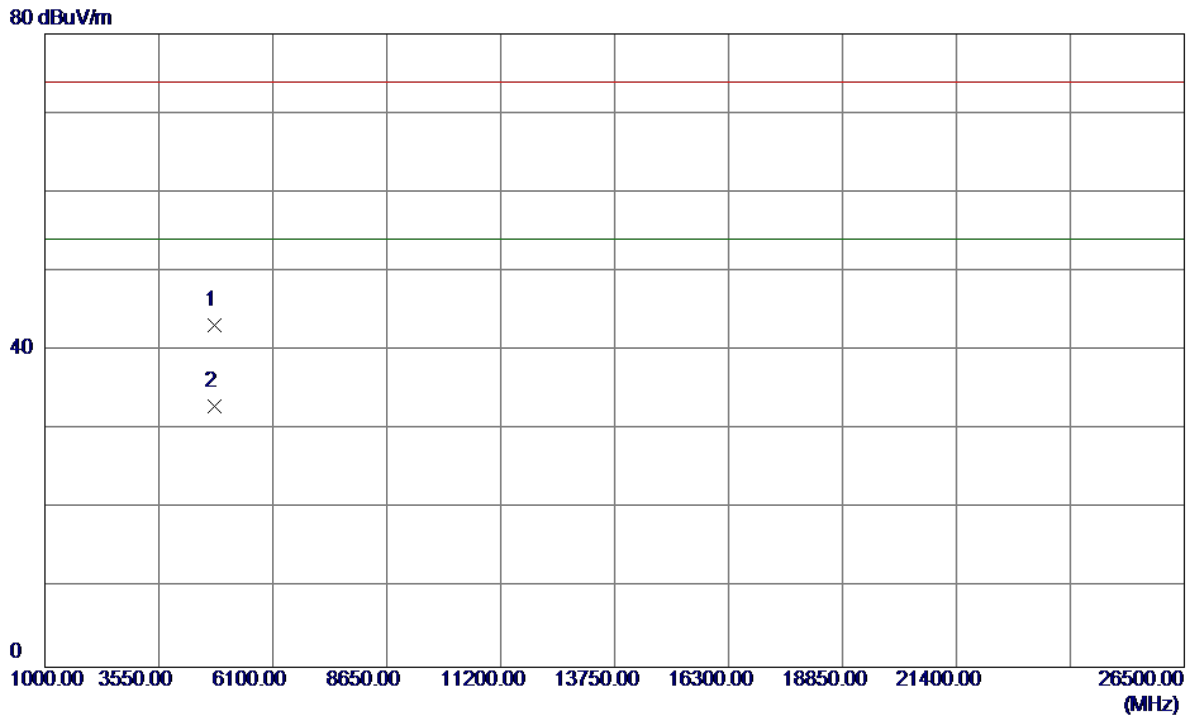

No.	Freq. MHz	Reading Level dBuV/m	Correct Factor dB	Measure ment dBuV/m	Limit dBuV/m	Margin dB	Detector	Comment
1	4803.7000	38.40	4.77	43.17	74.00	-30.83	Peak	
2 *	4804.1000	28.18	4.77	32.95	54.00	-21.05	AVG	

Test Mode : TX 2402MHz _CH00_1Mbps

Horizontal

120 dBuV/m

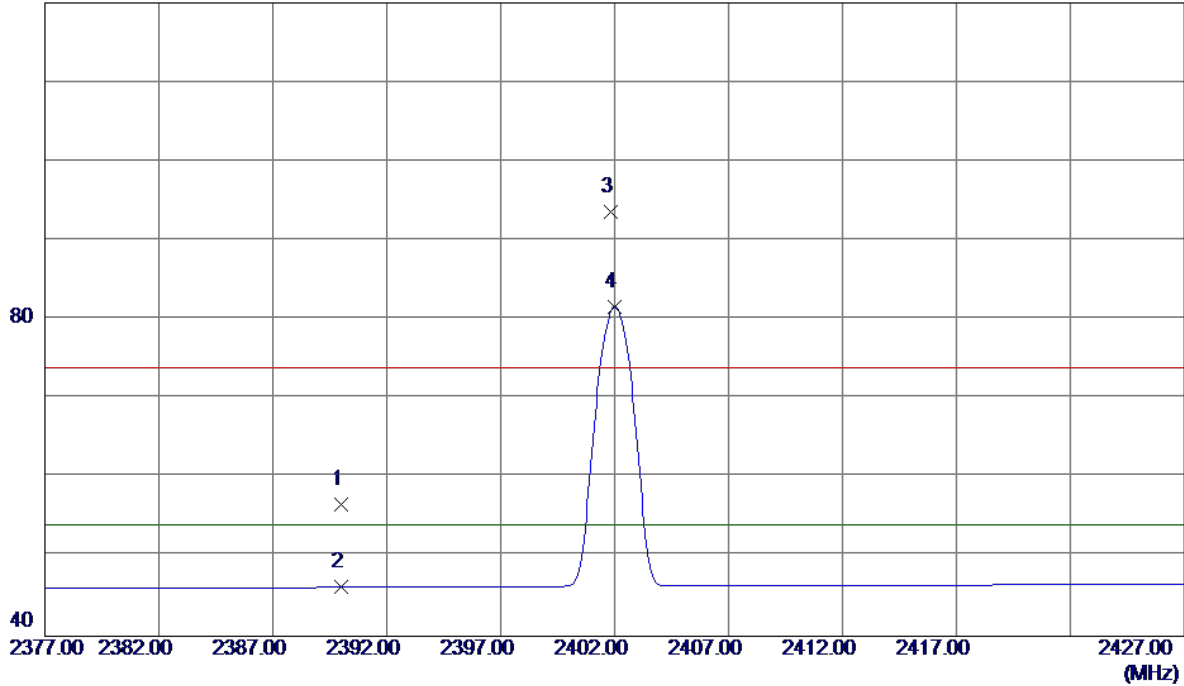

No.	Freq. MHz	Reading Level dBuV/m	Correct Factor dB	Measure ment dBuV/m	Limit dBuV/m	Margin dB	Detector	Comment
1	2390.0000	23.68	33.01	56.69	74.00	-17.31	Peak	
2	2390.0000	13.16	33.01	46.17	54.00	-7.83	AVG	
3	2401.8500	60.57	33.06	93.63	74.00	19.63	Peak	No Limit
4 *	2402.0000	48.53	33.06	81.59	54.00	27.59	AVG	No Limit

Test Mode : TX 2402MHz _CH00_1Mbps

Horizontal

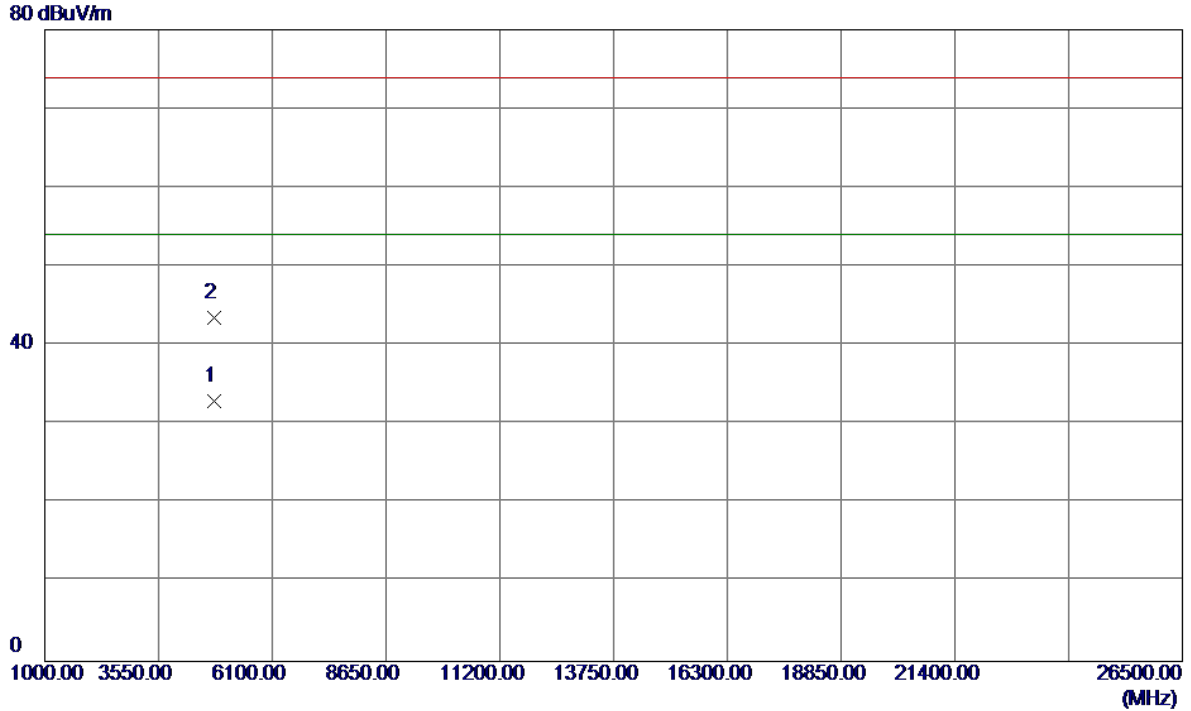

No.	Freq. MHz	Reading Level dBuV/m	Correct Factor dB	Measure ment dBuV/m	Limit dBuV/m	Margin dB	Detector	Comment
1 *	4803.3000	28.16	4.77	32.93	54.00	-21.07	AVG	
2	4805.5000	38.68	4.78	43.46	74.00	-30.54	Peak	

Test Mode : TX 2441MHz _CH39_1Mbps

Vertical

120 dBuV/m

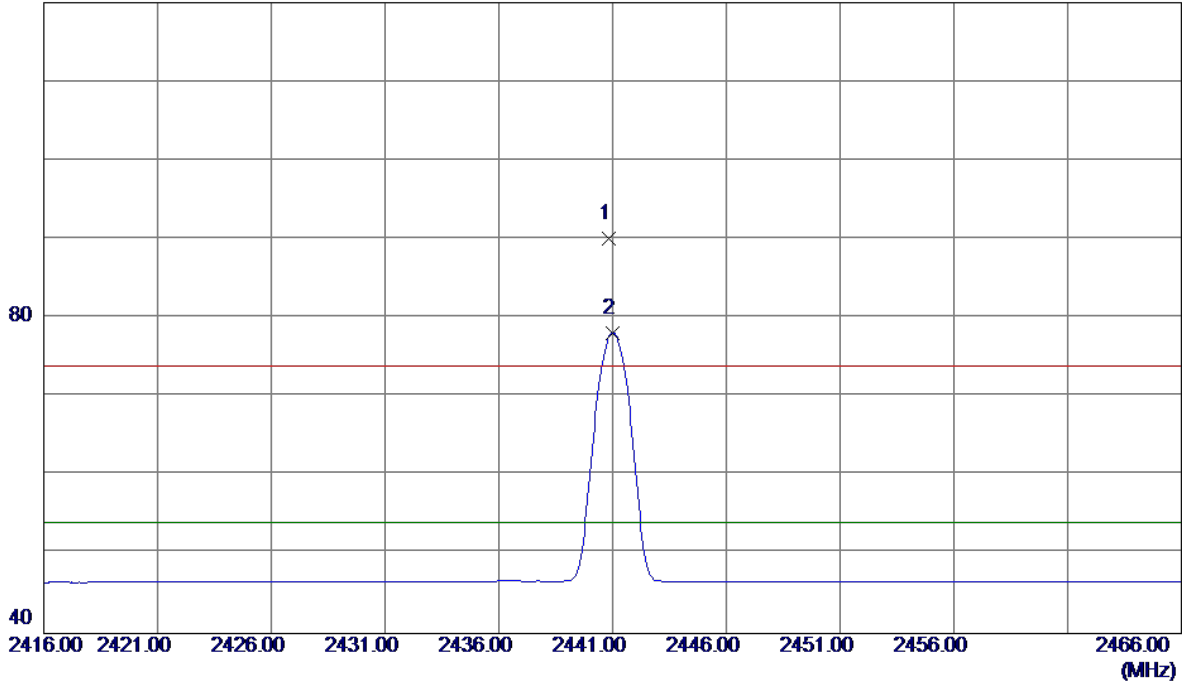

No.	Freq. MHz	Reading Level dBuV/m	Correct Factor dB	Measure ment dBuV/m	Limit dBuV/m	Margin dB	Detector	Comment
1	2440.8500	56.83	33.22	90.05	74.00	16.05	Peak	No Limit
2 *	2441.0000	44.91	33.22	78.13	54.00	24.13	AVG	No Limit

Test Mode : TX 2441MHz _CH39_1Mbps

Vertical

80 dBuV/m



No.	Freq. MHz	Reading Level dBuV/m	Correct Factor dB	Measure ment dBuV/m	Limit dBuV/m	Margin dB	Detector	Comment
1	4880.7000	37.84	5.09	42.93	74.00	-31.07	Peak	
2 *	4881.1000	28.36	5.10	33.46	54.00	-20.54	AVG	

Test Mode : TX 2441MHz _CH39_1Mbps

Horizontal

120 dBuV/m

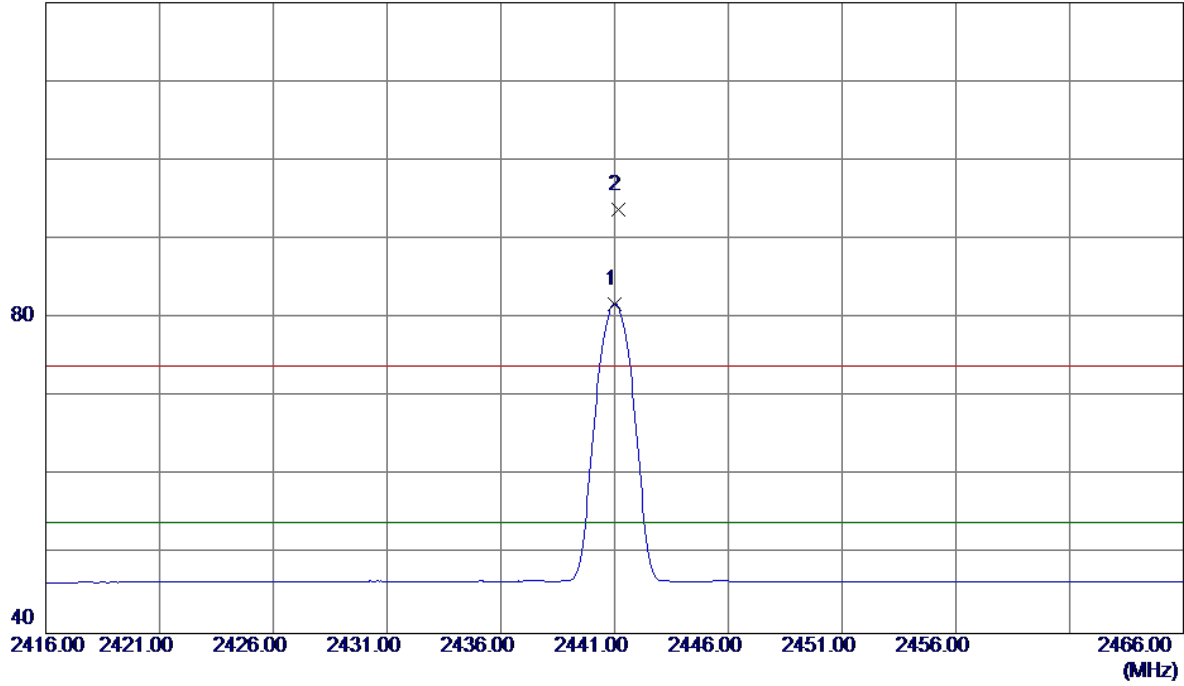

No.	Freq. MHz	Reading Level dBuV/m	Correct Factor dB	Measure ment dBuV/m	Limit dBuV/m	Margin dB	Detector	Comment
1 *	2441.0000	48.58	33.22	81.80	54.00	27.80	AVG	No Limit
2	2441.1500	60.59	33.22	93.81	74.00	19.81	Peak	No Limit

Test Mode : TX 2441MHz _CH39_1Mbps

Horizontal

80 dBuV/m



No.	Freq. MHz	Reading Level dBuV/m	Correct Factor dB	Measure ment dBuV/m	Limit dBuV/m	Margin dB	Detector	Comment
1	4882.6000	38.74	5.10	43.84	74.00	-30.16	Peak	
2 *	4882.9000	28.38	5.10	33.48	54.00	-20.52	AVG	

Test Mode : TX 2480MHz _CH78_1Mbps

Vertical

120 dBuV/m

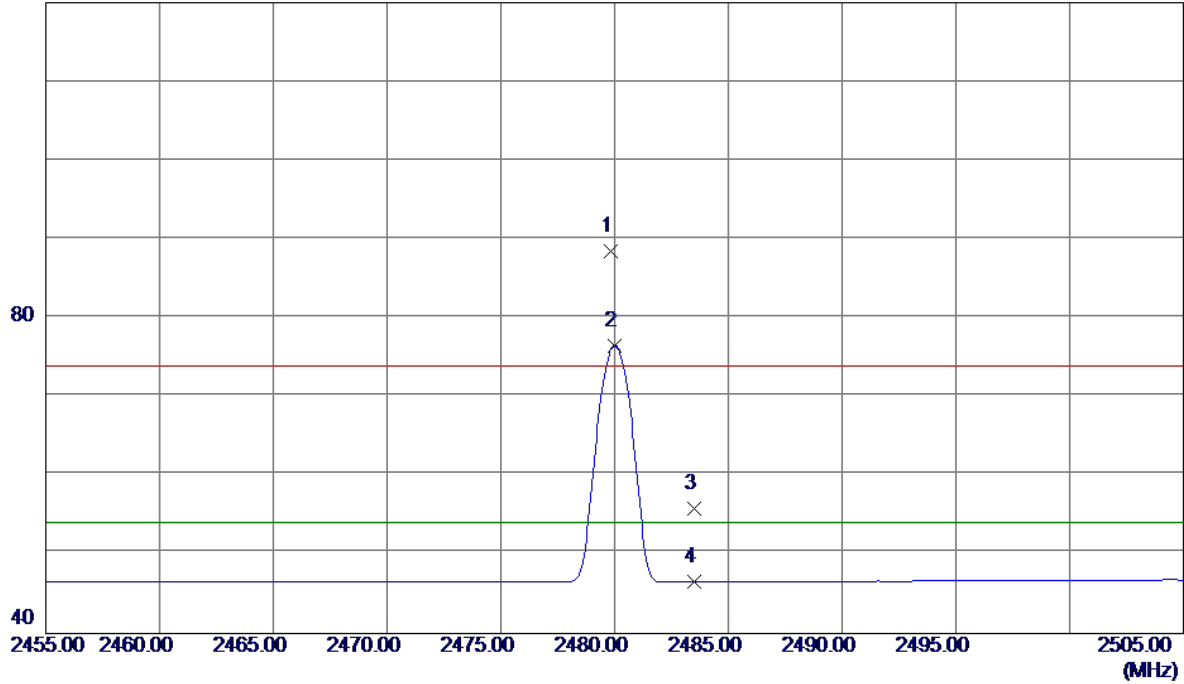

No.	Freq. MHz	Reading Level dBuV/m	Correct Factor dB	Measure ment dBuV/m	Limit dBuV/m	Margin dB	Detector	Comment
1	2479.8500	55.11	33.39	88.50	74.00	14.50	Peak	No Limit
2 *	2480.0000	43.12	33.39	76.51	54.00	22.51	AVG	No Limit
3	2483.5000	22.45	33.40	55.85	74.00	-18.15	Peak	
4	2483.5000	13.15	33.40	46.55	54.00	-7.45	AVG	

Test Mode : TX 2480MHz _CH78_1Mbps

Vertical

80 dBuV/m



No.	Freq. MHz	Reading Level dBuV/m	Correct Factor dB	Measure ment dBuV/m	Limit dBuV/m	Margin dB	Detector	Comment
1	4952.0000	40.65	5.40	46.05	74.00	-27.95	Peak	
2 *	4957.0000	29.14	5.42	34.56	54.00	-19.44	AVG	

Test Mode : TX 2480MHz _CH78_1Mbps

Horizontal

120 dBuV/m

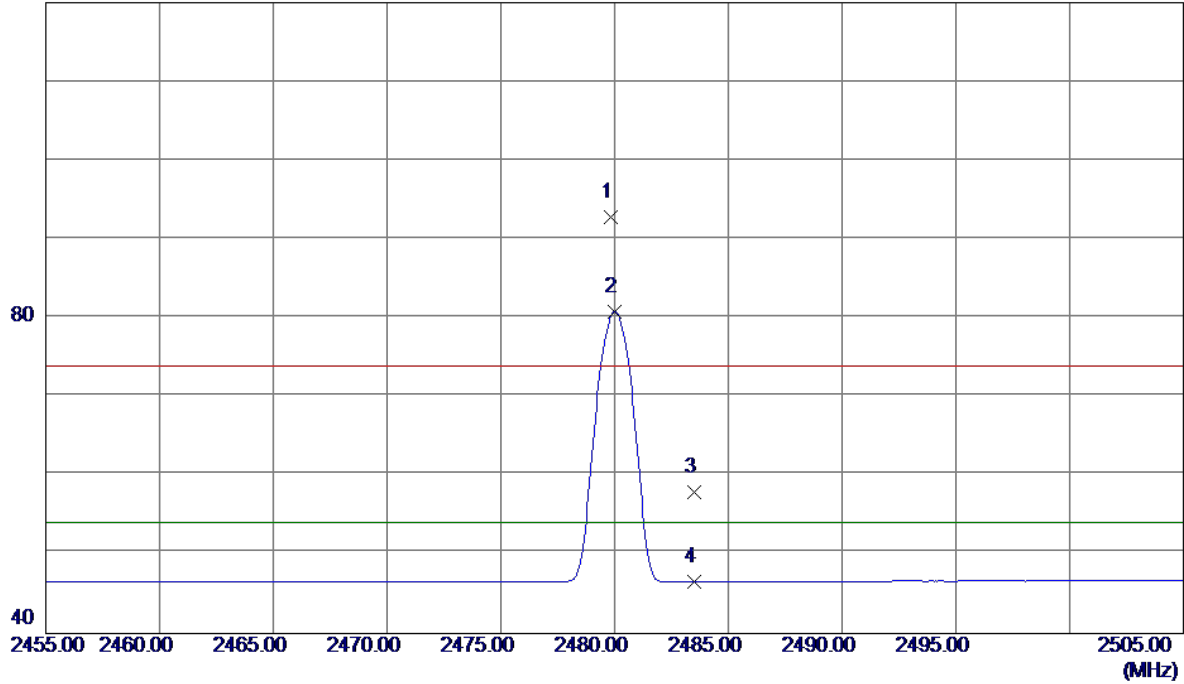

No.	Freq. MHz	Reading Level dBuV/m	Correct Factor dB	Measure ment dBuV/m	Limit dBuV/m	Margin dB	Detector	Comment
1	2479.8500	59.36	33.39	92.75	74.00	18.75	Peak	No Limit
2 *	2480.0000	47.38	33.39	80.77	54.00	26.77	AVG	No Limit
3	2483.5000	24.45	33.40	57.85	74.00	-16.15	Peak	
4	2483.5000	13.15	33.40	46.55	54.00	-7.45	AVG	

Test Mode : TX 2480MHz _CH78_1Mbps

Horizontal

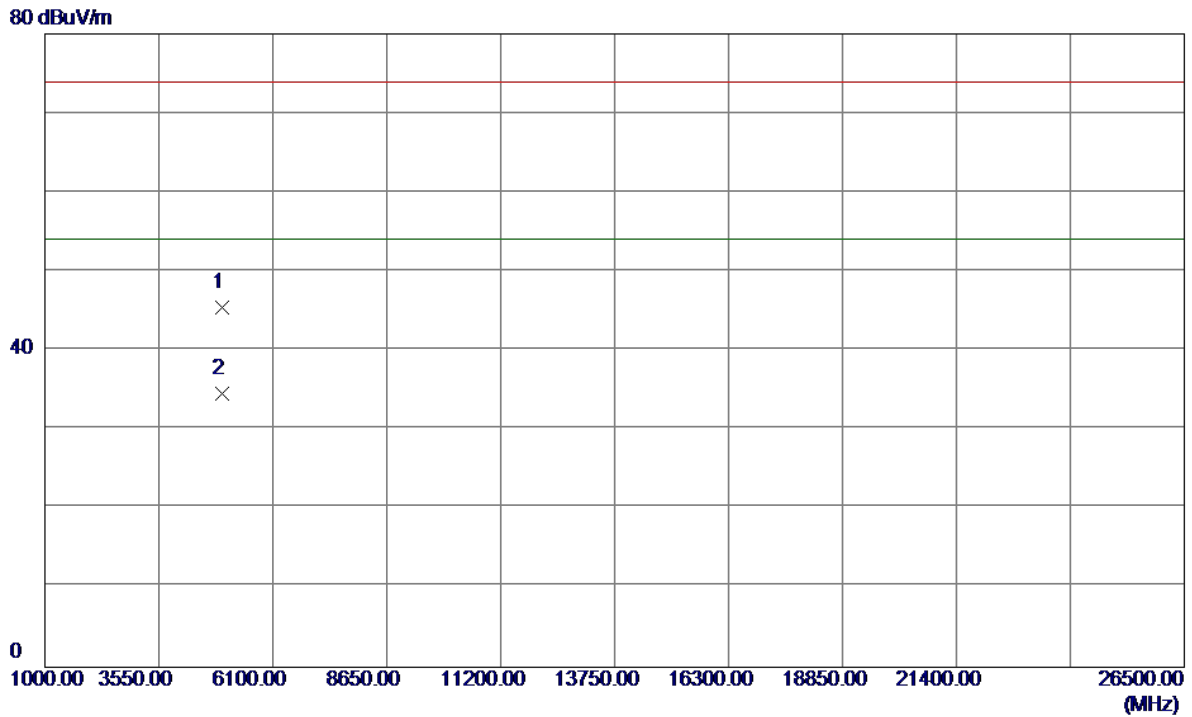

No.	Freq. MHz	Reading Level dBuV/m	Correct Factor dB	Measure ment dBuV/m	Limit dBuV/m	Margin dB	Detector	Comment
1	4960.0200	40.05	5.43	45.48	74.00	-28.52	Peak	
2 *	4960.0700	29.08	5.43	34.51	54.00	-19.49	AVG	

Test Mode : TX 2402MHz _CH00_3Mbps

Vertical

120 dBuV/m

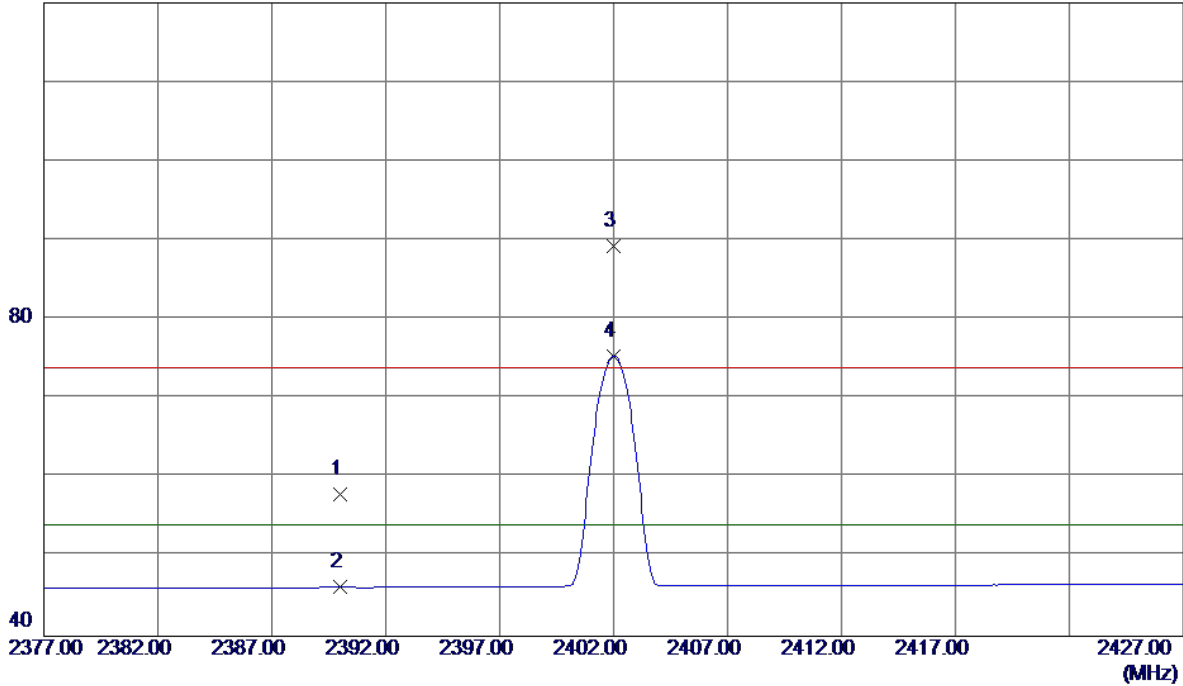

No.	Freq. MHz	Reading Level dBuV/m	Correct Factor dB	Measure ment dBuV/m	Limit dBuV/m	Margin dB	Detector	Comment
1	2390.0000	24.88	33.01	57.89	74.00	-16.11	Peak	
2	2390.0000	13.16	33.01	46.17	54.00	-7.83	AVG	
3	2402.0000	56.21	33.06	89.27	74.00	15.27	Peak	No Limit
4 *	2402.0000	42.32	33.06	75.38	54.00	21.38	AVG	No Limit

Test Mode : TX 2402MHz _CH00_3Mbps

Vertical

80 dBuV/m

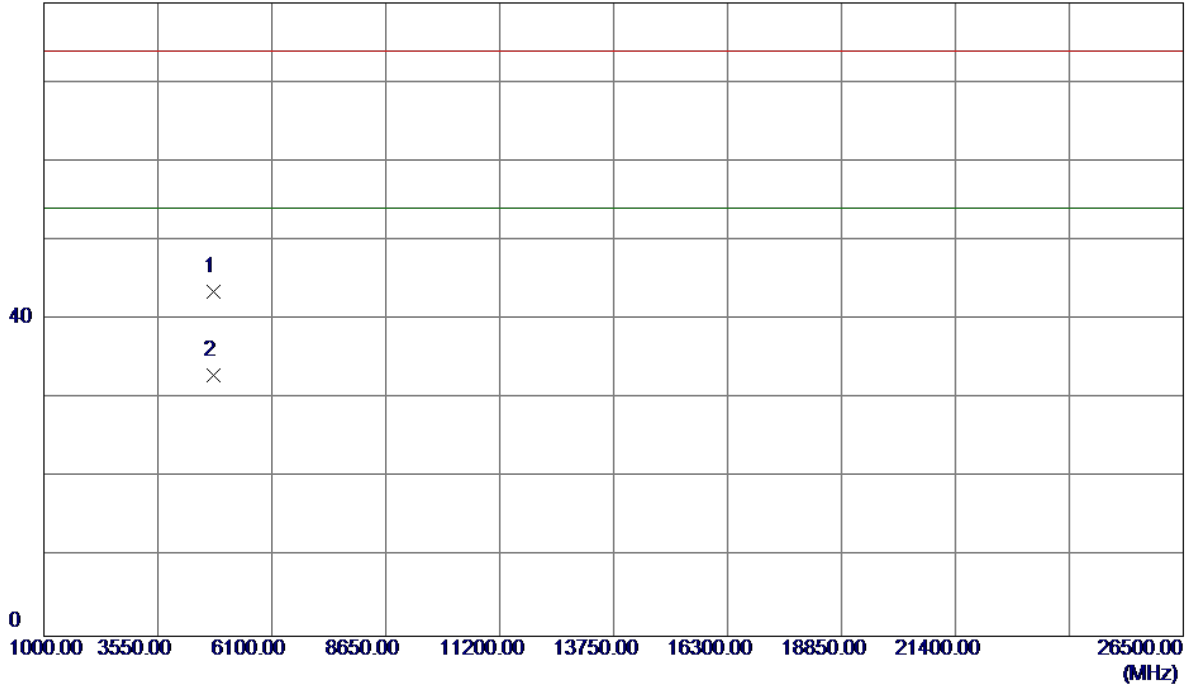

No.	Freq. MHz	Reading Level dBuV/m	Correct Factor dB	Measure ment dBuV/m	Limit dBuV/m	Margin dB	Detector	Comment
1	4803.6000	38.69	4.77	43.46	74.00	-30.54	Peak	
2 *	4804.2000	28.18	4.77	32.95	54.00	-21.05	AVG	

Test Mode : TX 2402MHz _CH00_3Mbps

Horizontal

120 dBuV/m

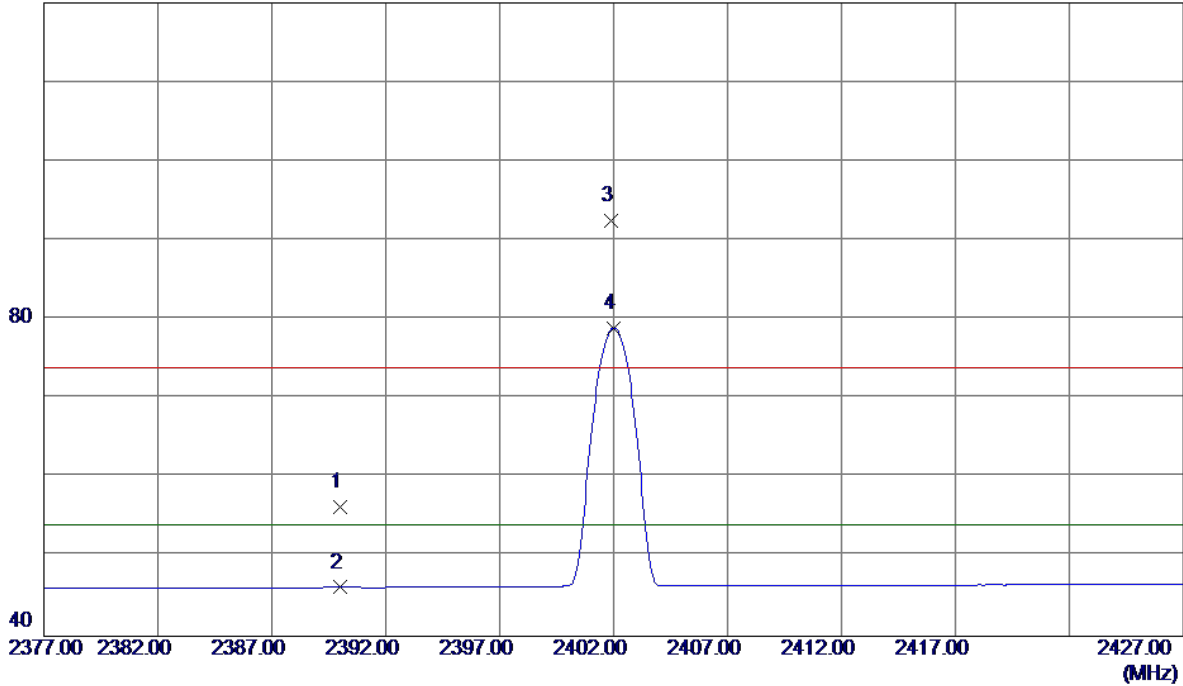

No.	Freq. MHz	Reading Level dBuV/m	Correct Factor dB	Measure ment dBuV/m	Limit dBuV/m	Margin dB	Detector	Comment
1	2390.0000	23.31	33.01	56.32	74.00	-17.68	Peak	
2	2390.0000	13.15	33.01	46.16	54.00	-7.84	AVG	
3	2401.9000	59.44	33.06	92.50	74.00	18.50	Peak	No Limit
4 *	2402.0000	45.88	33.06	78.94	54.00	24.94	AVG	No Limit

Test Mode : TX 2402MHz _CH00_3Mbps

Horizontal

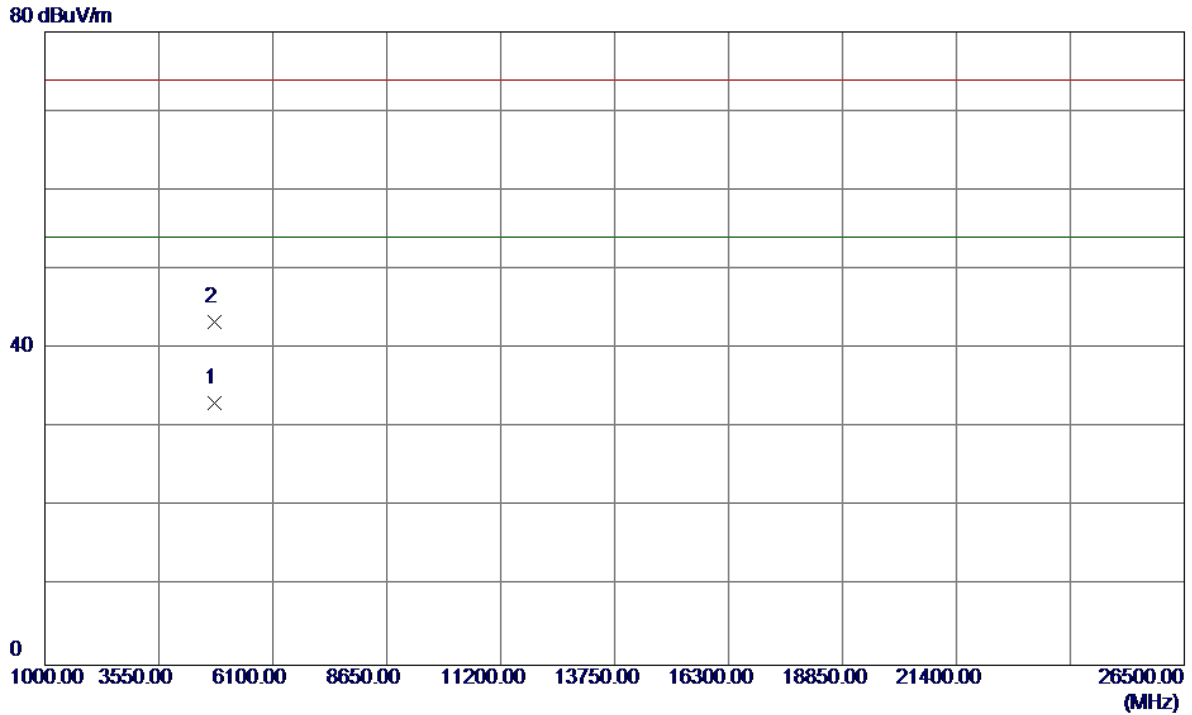

No.	Freq. MHz	Reading Level dBuV/m	Correct Factor dB	Measure ment dBuV/m	Limit dBuV/m	Margin dB	Detector	Comment
1 *	4803.4000	28.29	4.77	33.06	54.00	-20.94	AVG	
2	4805.5200	38.51	4.78	43.29	74.00	-30.71	Peak	

Test Mode : TX 2441MHz _CH39_3Mbps

Vertical

120 dBuV/m

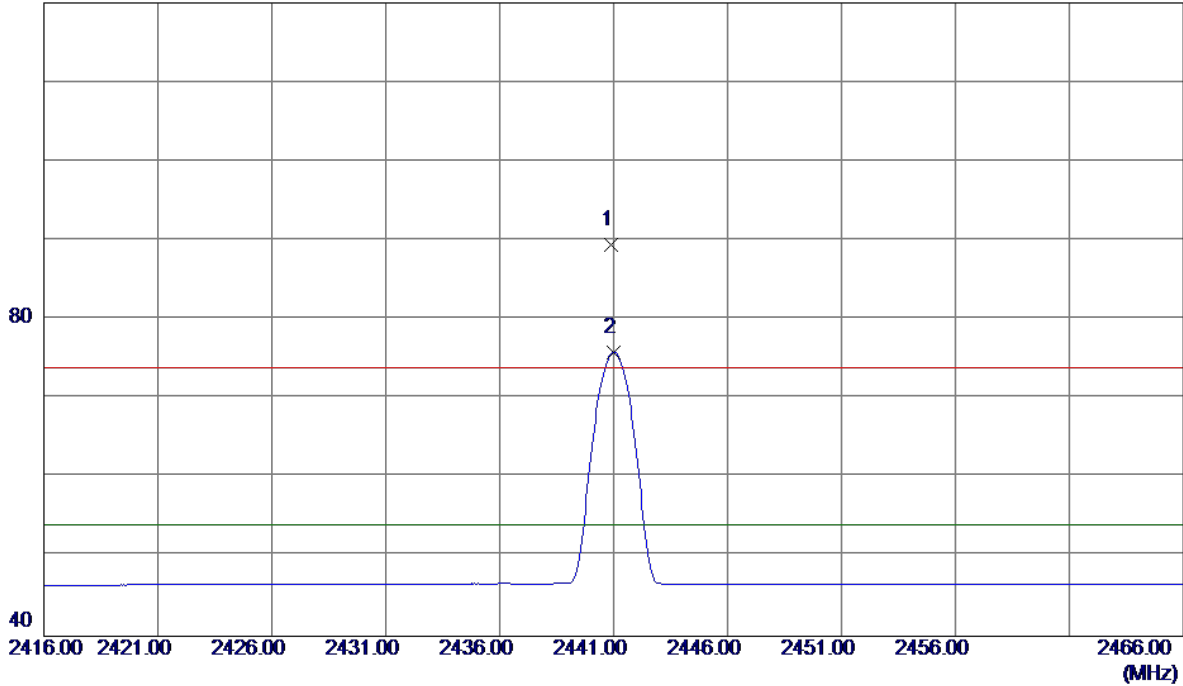

No.	Freq. MHz	Reading Level dBuV/m	Correct Factor dB	Measure ment dBuV/m	Limit dBuV/m	Margin dB	Detector	Comment
1	2440.9000	56.26	33.22	89.48	74.00	15.48	Peak	No Limit
2 *	2441.0000	42.64	33.22	75.86	54.00	21.86	AVG	No Limit

Test Mode : TX 2441MHz _CH39_3Mbps

Vertical

80 dBuV/m

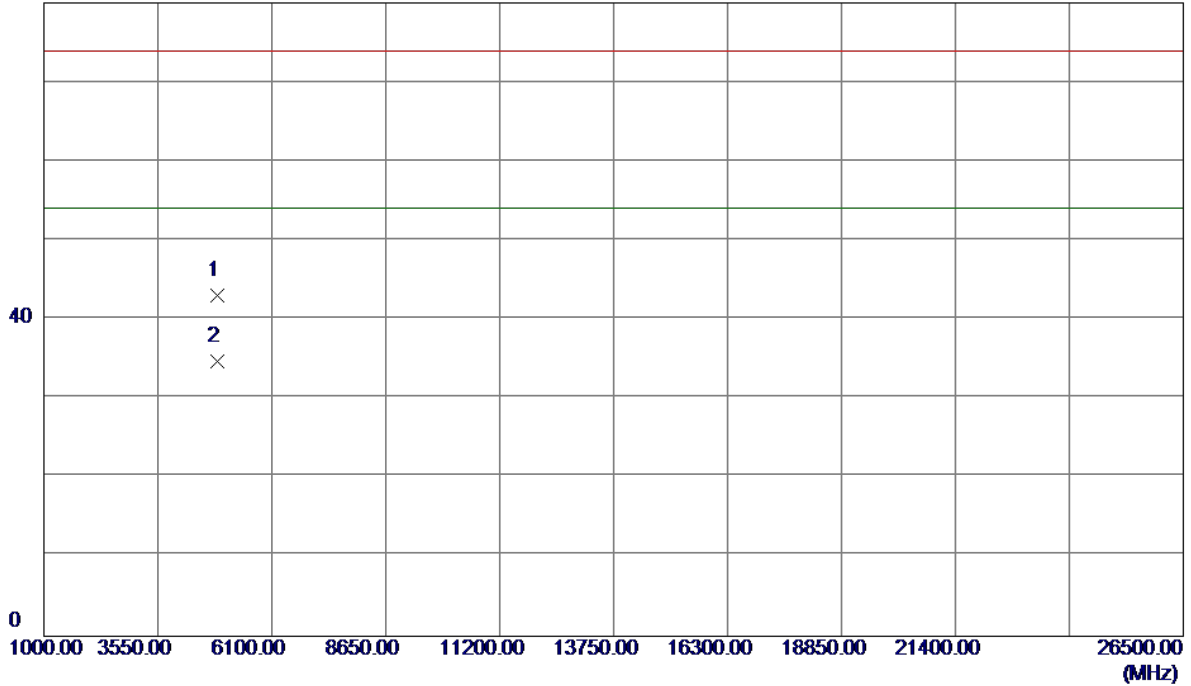

No.	Freq. MHz	Reading Level dBuV/m	Correct Factor dB	Measure ment dBuV/m	Limit dBuV/m	Margin dB	Detector	Comment
1	4880.5000	37.96	5.09	43.05	74.00	-30.95	Peak	
2 *	4881.3000	29.57	5.10	34.67	54.00	-19.33	AVG	

Test Mode : TX 2441MHz _CH39_3Mbps

Horizontal

120 dBuV/m

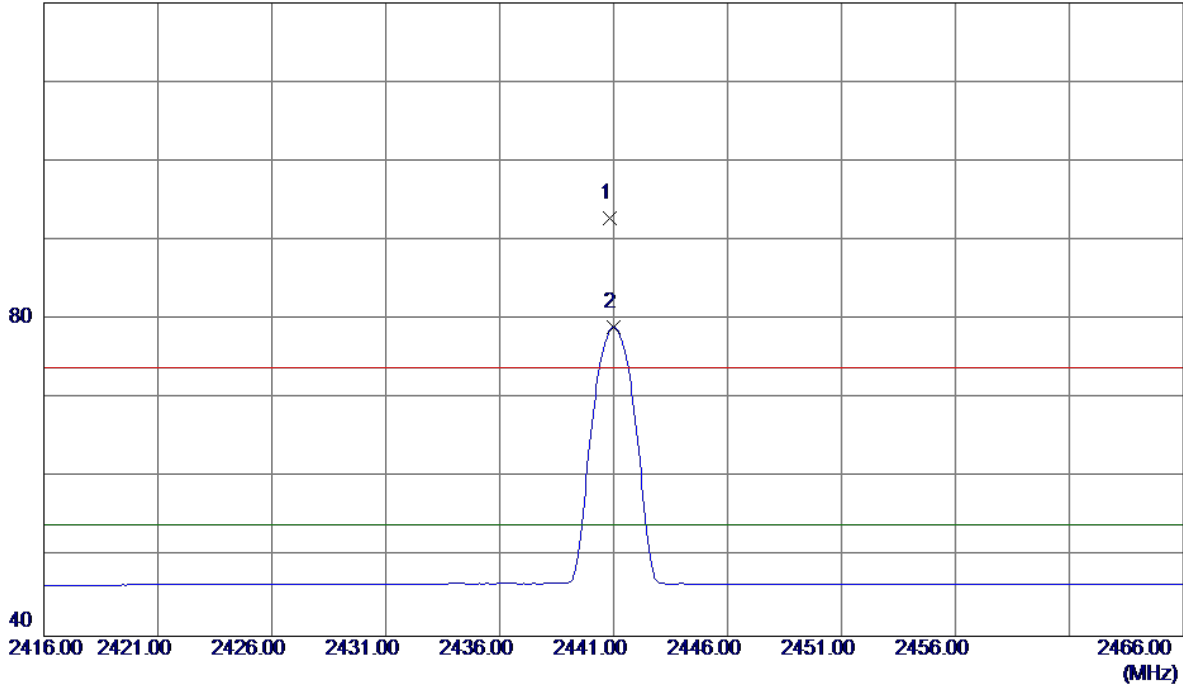

No.	Freq. MHz	Reading Level dBuV/m	Correct Factor dB	Measure ment dBuV/m	Limit dBuV/m	Margin dB	Detector	Comment
1	2440.8500	59.63	33.22	92.85	74.00	18.85	Peak	No Limit
2 *	2441.0000	45.80	33.22	79.02	54.00	25.02	AVG	No Limit

Test Mode : TX 2441MHz _CH39_3Mbps

Horizontal

80 dBuV/m



No.	Freq. MHz	Reading Level dBuV/m	Correct Factor dB	Measure ment dBuV/m	Limit dBuV/m	Margin dB	Detector	Comment
1	4882.6000	38.74	5.10	43.84	74.00	-30.16	Peak	
2 *	4882.5000	28.38	5.10	33.48	54.00	-20.52	AVG	

Test Mode : TX 2480MHz _CH78_3Mbps

Vertical

120 dBuV/m

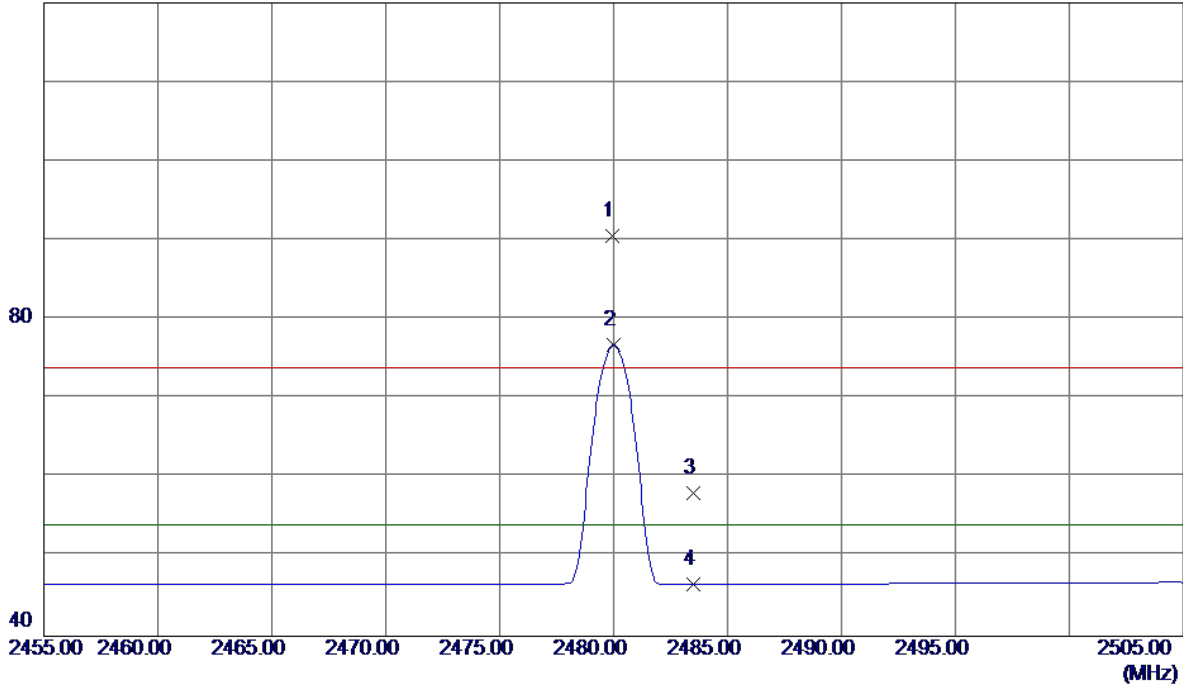

No.	Freq. MHz	Reading Level dBuV/m	Correct Factor dB	Measure ment dBuV/m	Limit dBuV/m	Margin dB	Detector	Comment
1	2479.9500	57.13	33.39	90.52	74.00	16.52	Peak	No Limit
2 *	2480.0000	43.38	33.39	76.77	54.00	22.77	AVG	No Limit
3	2483.5000	24.65	33.40	58.05	74.00	-15.95	Peak	
4	2483.5000	13.16	33.40	46.56	54.00	-7.44	AVG	

Test Mode : TX 2480MHz _CH78_3Mbps

Vertical

80 dBuV/m

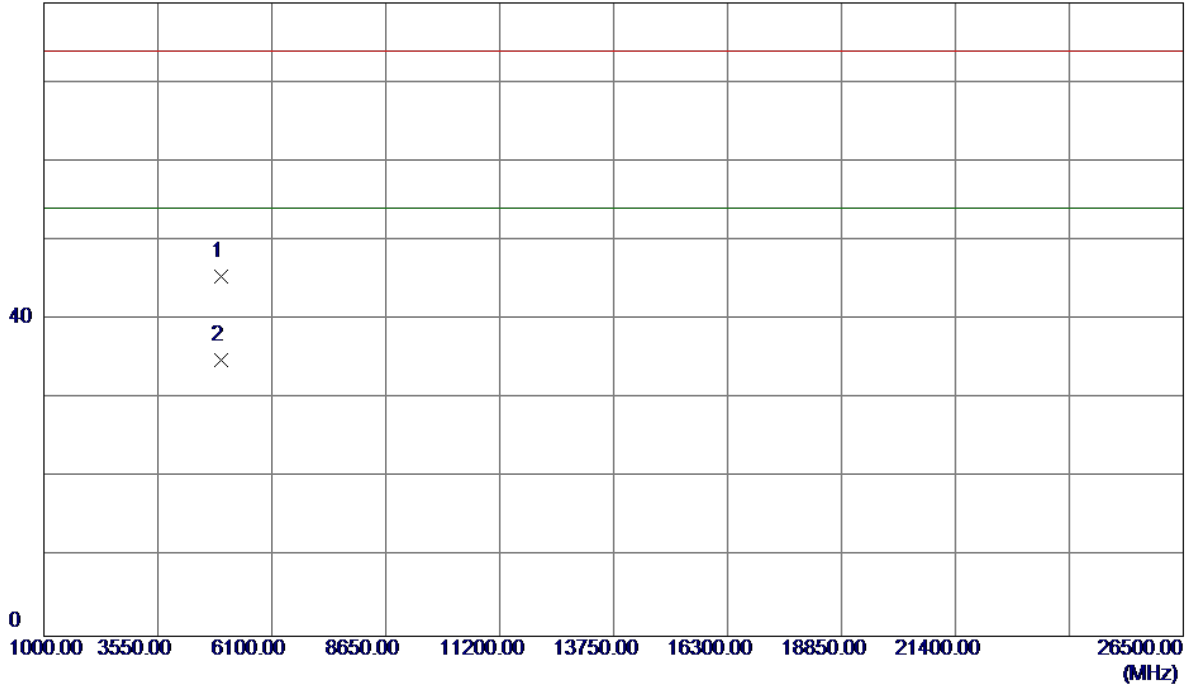

No.	Freq. MHz	Reading Level dBuV/m	Correct Factor dB	Measure ment dBuV/m	Limit dBuV/m	Margin dB	Detector	Comment
1	4956.0000	40.09	5.41	45.50	74.00	-28.50	Peak	
2 *	4958.0000	29.39	5.42	34.81	54.00	-19.19	AVG	

Test Mode : TX 2480MHz _CH78_3Mbps

Horizontal

120 dBuV/m

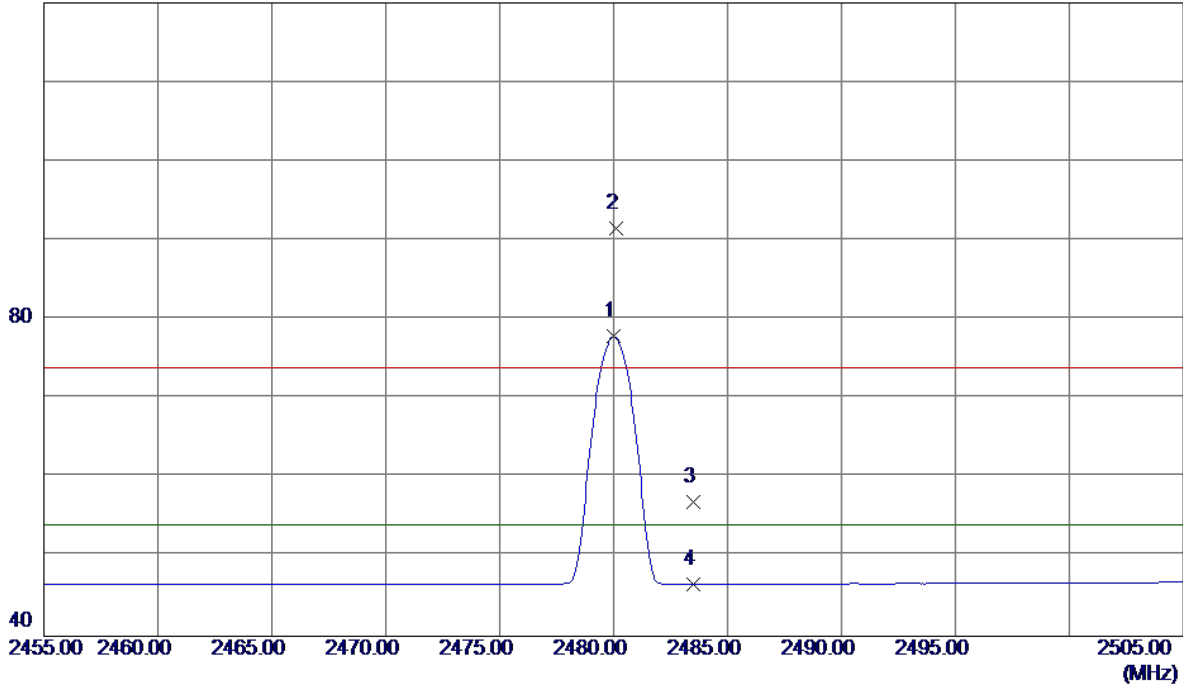

No.	Freq. MHz	Reading Level dBuV/m	Correct Factor dB	Measure ment dBuV/m	Limit dBuV/m	Margin dB	Detector	Comment
1 *	2480.0000	44.46	33.39	77.85	54.00	23.85	AVG	No Limit
2	2480.1000	58.20	33.39	91.59	74.00	17.59	Peak	No Limit
3	2483.5000	23.53	33.40	56.93	74.00	-17.07	Peak	
4	2483.5000	13.15	33.40	46.55	54.00	-7.45	AVG	

Test Mode : TX 2480MHz _CH78_3Mbps

Horizontal

80 dBuV/m

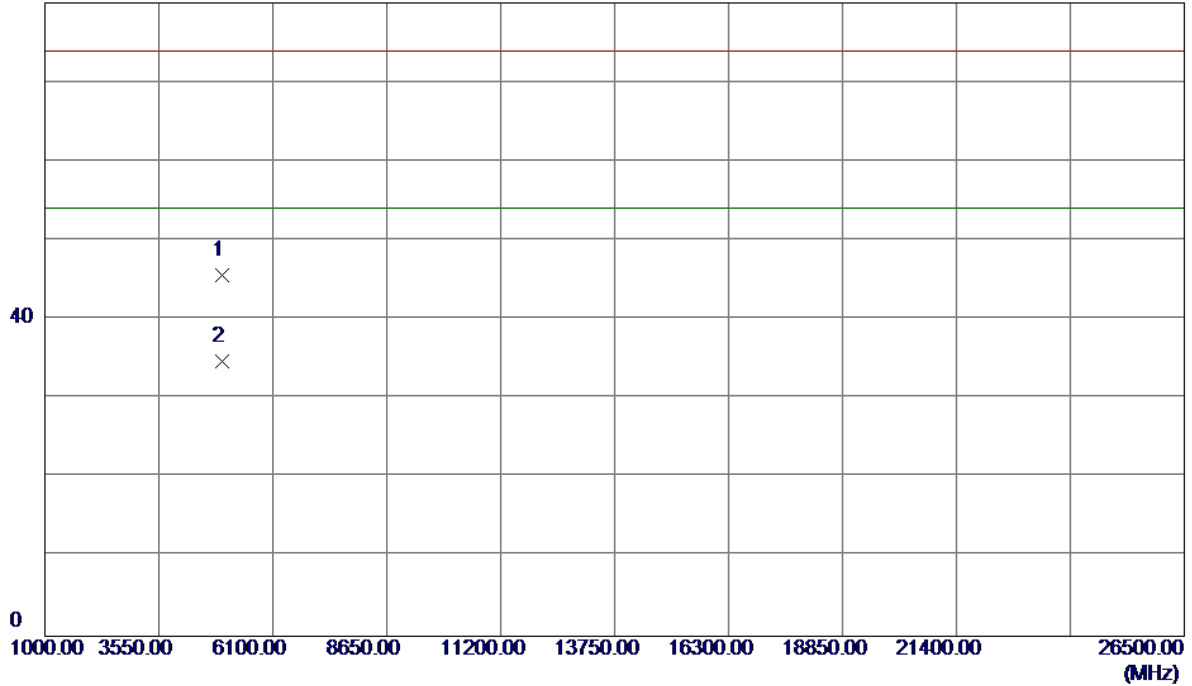

No.	Freq. MHz	Reading Level dBuV/m	Correct Factor dB	Measure ment dBuV/m	Limit dBuV/m	Margin dB	Detector	Comment
1	4960.0600	40.18	5.43	45.61	74.00	-28.39	Peak	
2 *	4960.0200	29.29	5.43	34.72	54.00	-19.28	AVG	

ATTACHMENT E - NUMBER OF HOPPING CHANNEL

Test Mode **Hopping Mode_1Mbps**

Number of Hopping Channel 79

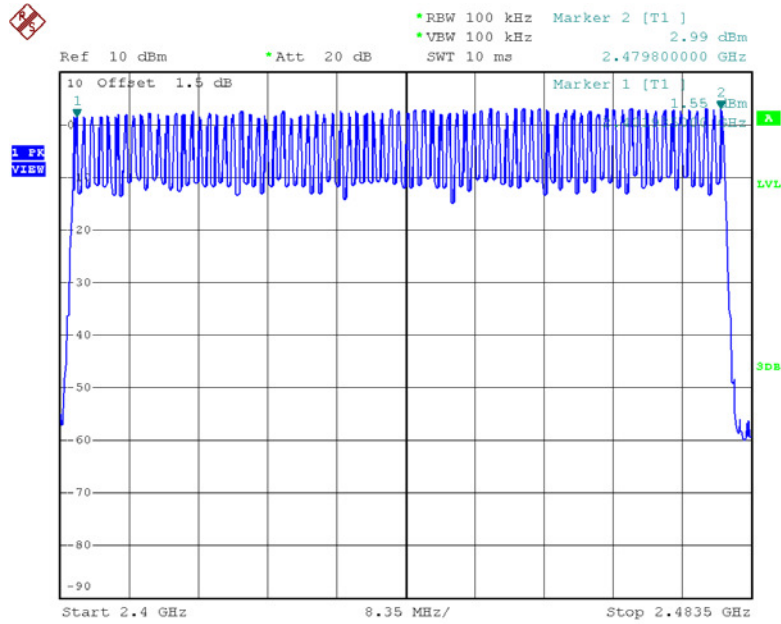

Date: 4.AUG.2016 20:59:21

Test Mode **Hopping Mode_3Mbps**

Number of Hopping Channel 79

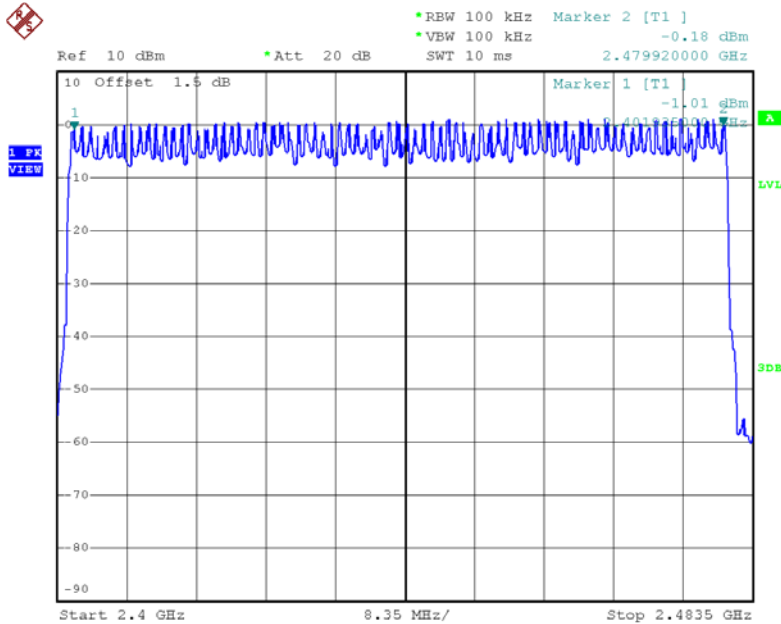

Date: 4.AUG.2016 21:20:06

ATTACHMENT F - AVERAGE TIME OF OCCUPANCY

Test Mode :	TX Mode_1Mbps
-------------	---------------

Data Packet	Frequency (MHz)	Pulse Duration (ms)	Dwell Time (s)	Limits (s)	Test Result
DH5	2402	2.8800	0.3072	0.4000	Pass
DH3	2402	1.6400	0.1749	0.4000	Pass
DH1	2402	0.3800	0.0405	0.4000	Pass
DH5	2441	2.8800	0.3072	0.4000	Pass
DH3	2441	1.6400	0.1749	0.4000	Pass
DH1	2441	0.3850	0.0411	0.4000	Pass
DH5	2480	2.8800	0.3072	0.4000	Pass
DH3	2480	1.6400	0.1749	0.4000	Pass
DH1	2480	0.3850	0.0411	0.4000	Pass

CH00-DH1

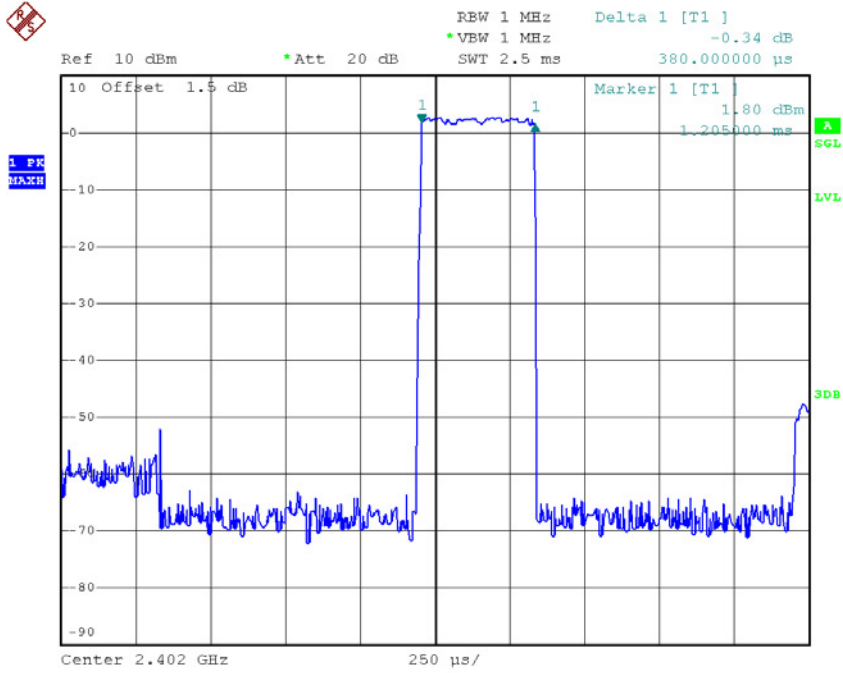

Date: 4.AUG.2016 20:53:54

CH00-DH3

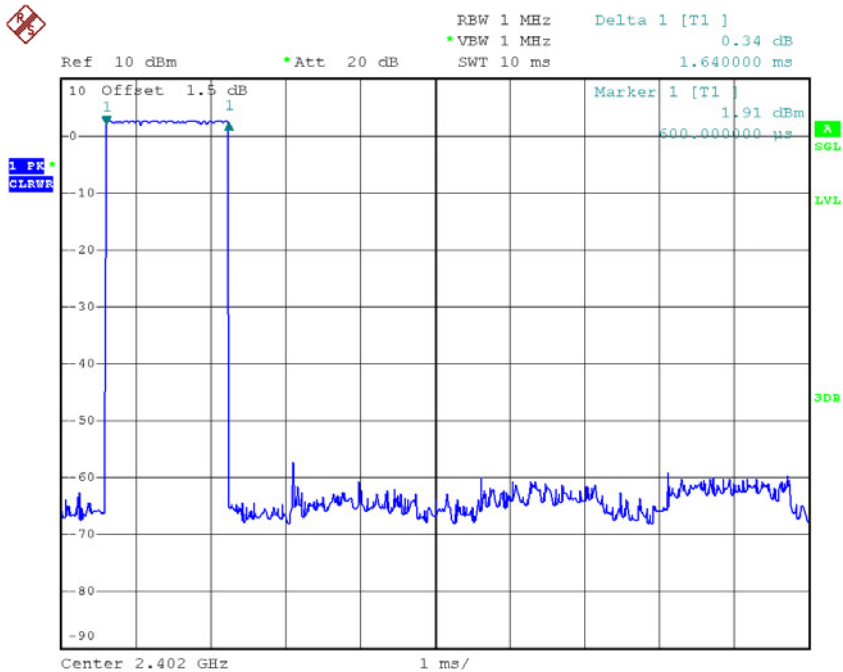

Date: 4.AUG.2016 21:04:15

CH00-DH5

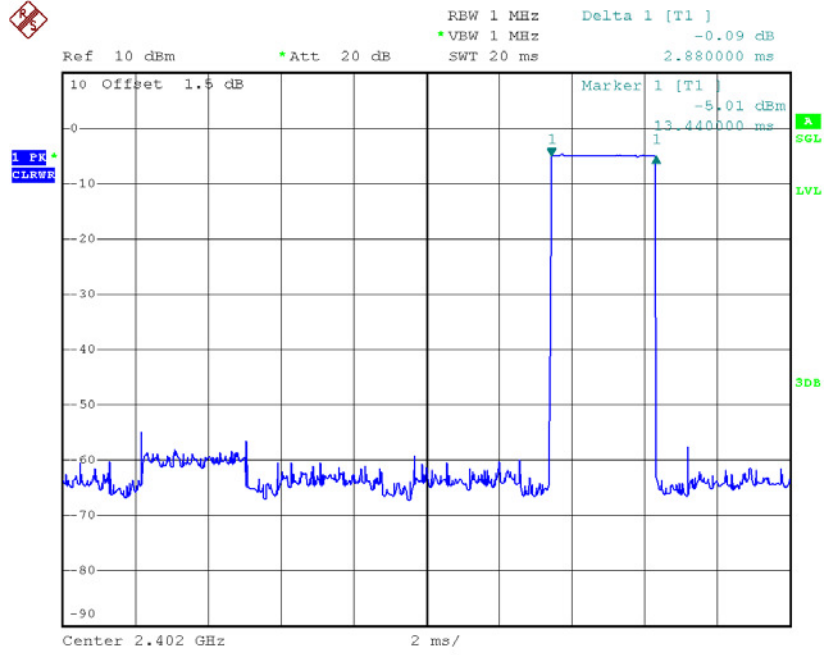

Date: 4.AUG.2016 21:06:14

CH39-DH1

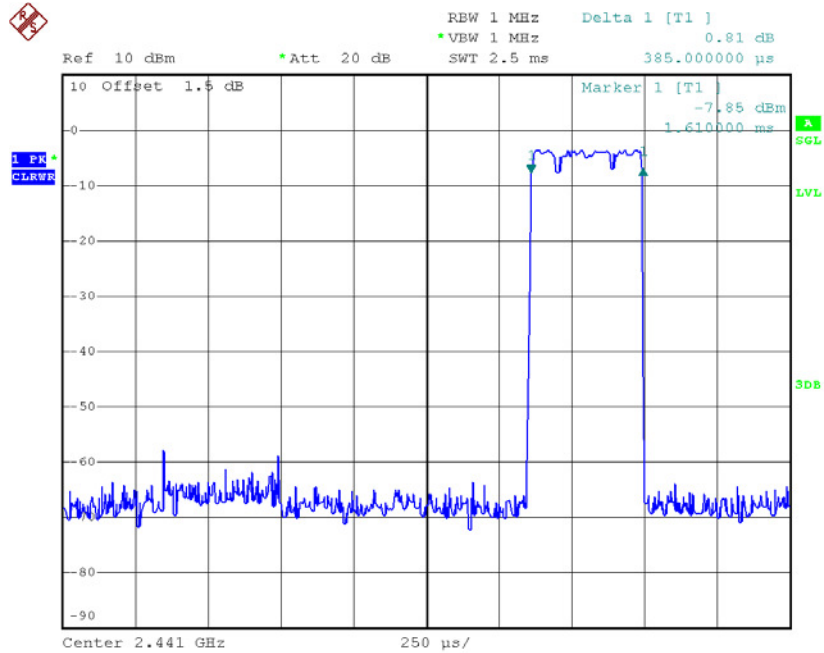

Date: 4.AUG.2016 20:53:59

CH39-DH3

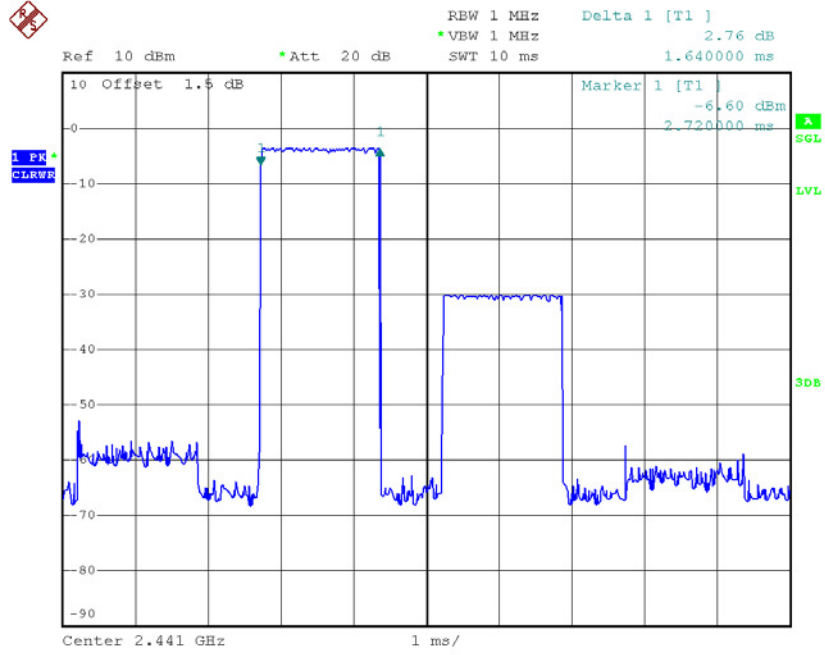

Date: 4.AUG.2016 21:04:20

CH39-DH5

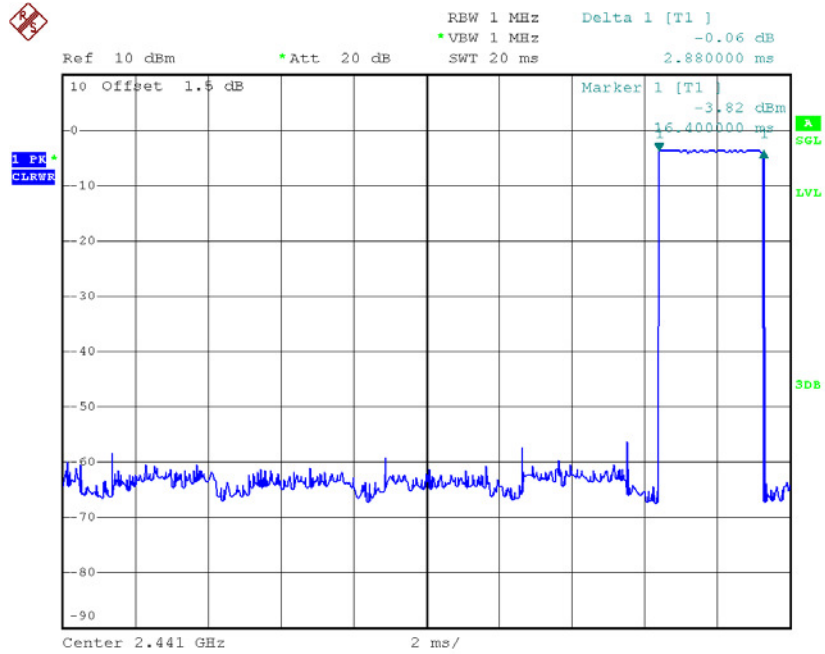

Date: 4.AUG.2016 21:06:19

CH78-DH1

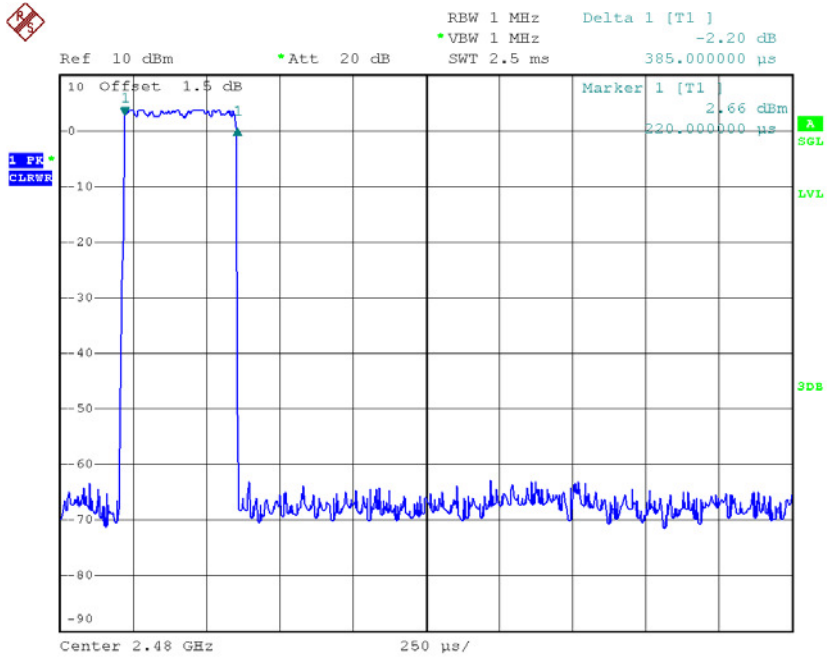

Date: 4.AUG.2016 20:54:05

CH78-DH3

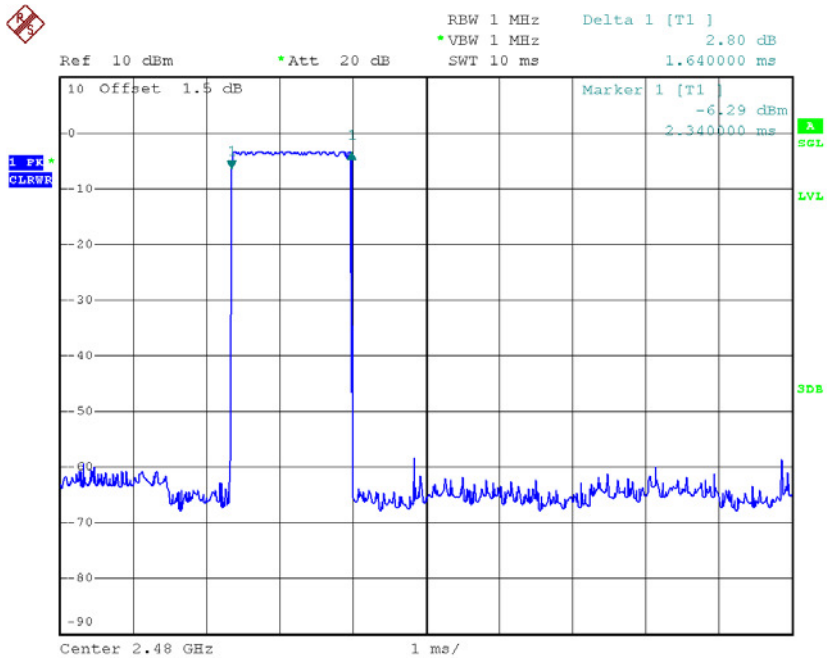

Date: 4.AUG.2016 21:04:26

CH78-DH5

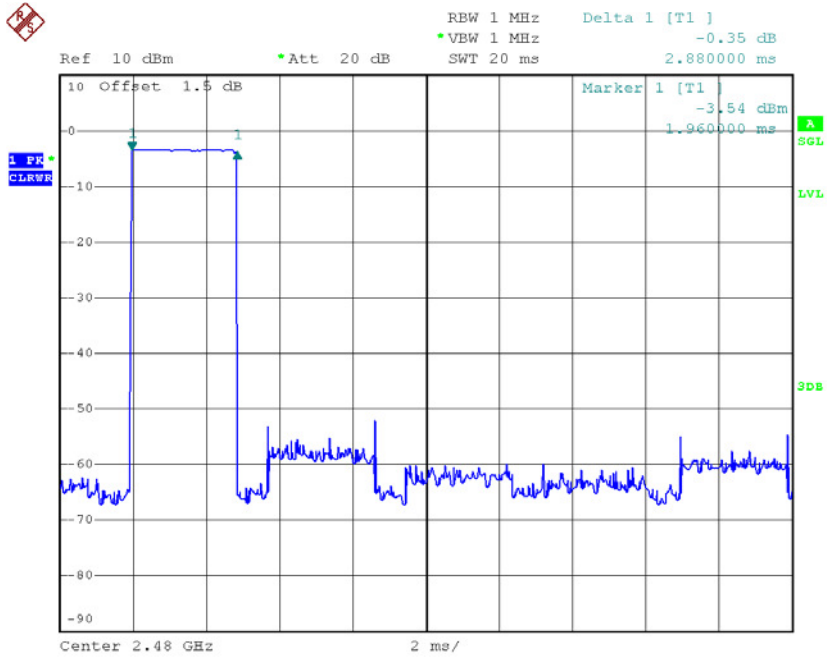

Date: 4.AUG.2016 21:06:25

Test Mode :	TX Mode_3Mbps
-------------	---------------

Data Packet	Frequency	Pulse Duration(ms)	Dwell Time(s)	Limits(s)	Test Result
DH5	2402	2.8800	0.3072	0.4000	Pass
DH3	2402	1.6400	0.1749	0.4000	Pass
DH1	2402	0.3750	0.0400	0.4000	Pass
DH5	2441	2.8800	0.3072	0.4000	Pass
DH3	2441	1.6200	0.1728	0.4000	Pass
DH1	2441	0.3750	0.0400	0.4000	Pass
DH5	2480	2.8800	0.3072	0.4000	Pass
DH3	2480	1.6400	0.1749	0.4000	Pass
DH1	2480	0.3750	0.0400	0.4000	Pass

CH00-DH1

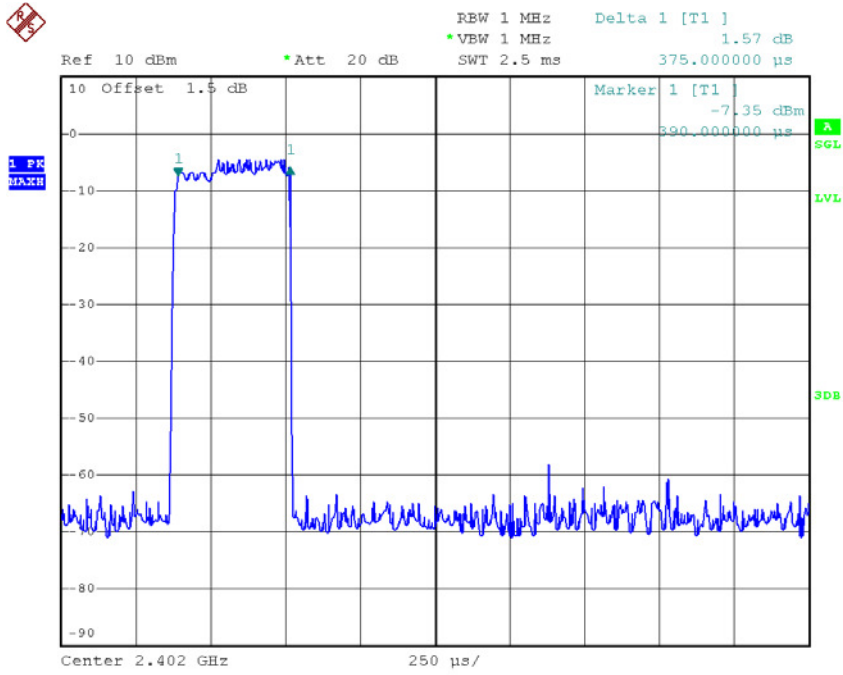

Date: 4.AUG.2016 21:14:36

CH00-DH3

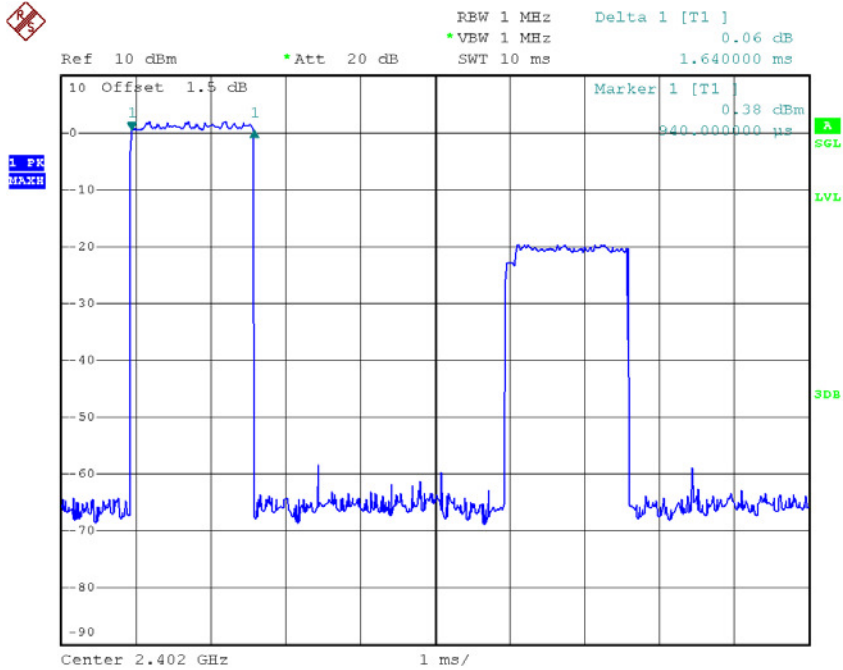

Date: 4.AUG.2016 21:21:48

CH00-DH5

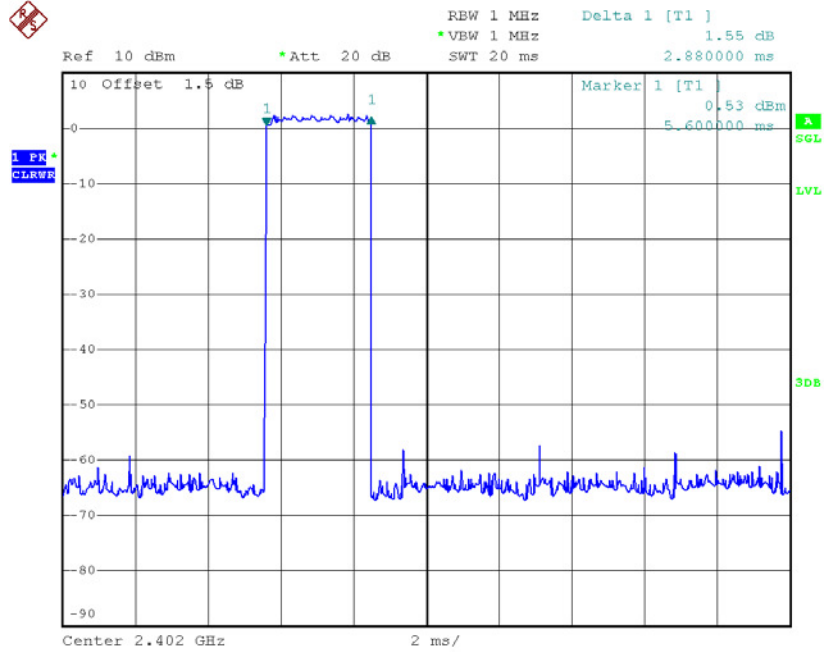

Date: 4.AUG.2016 21:22:25

CH39-DH1

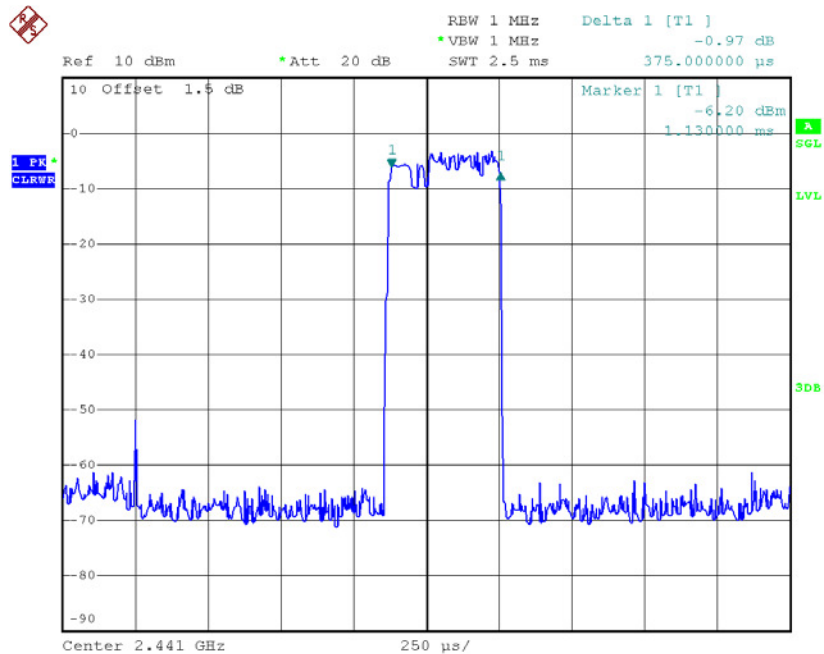

Date: 4.AUG.2016 21:14:44

CH39-DH3

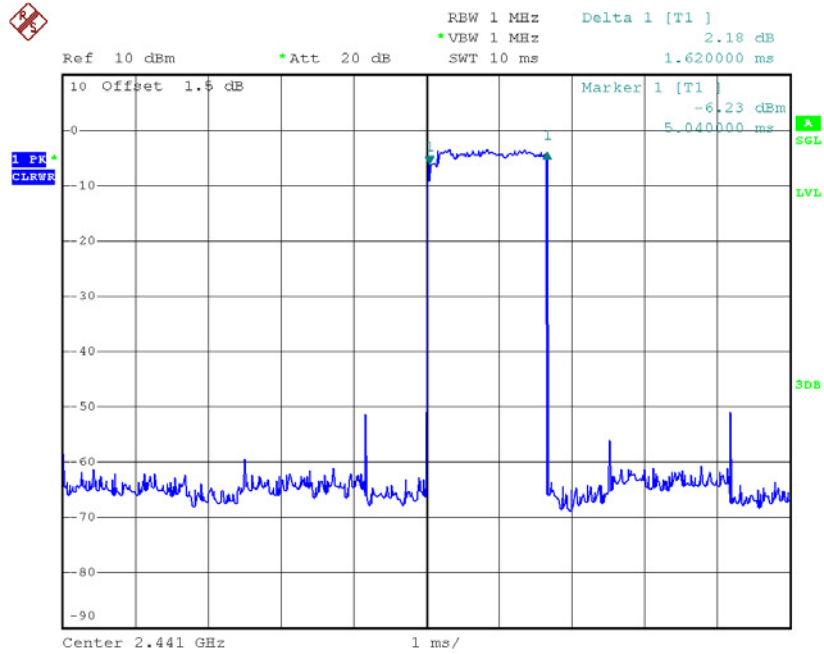

Date: 4.AUG.2016 21:21:56

CH39-DH5

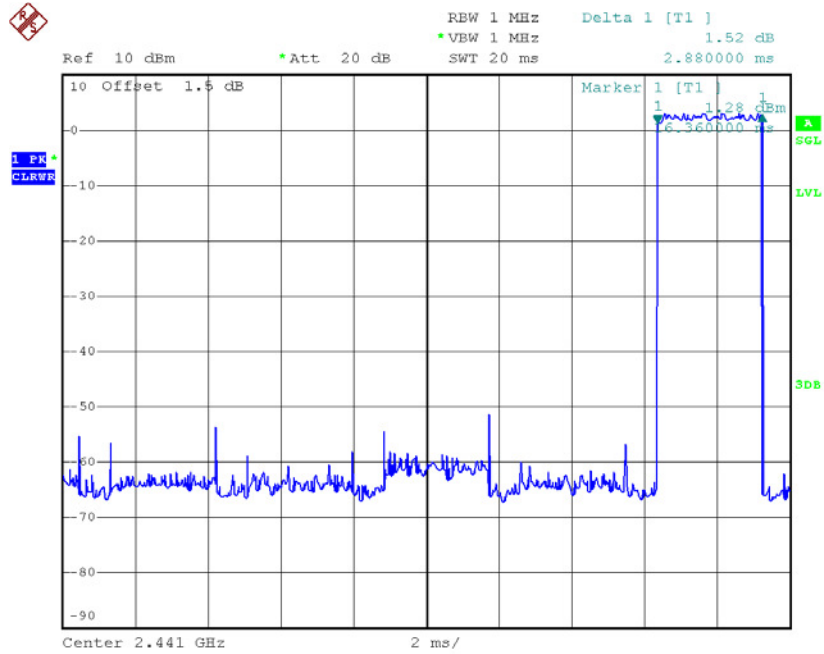

Date: 4.AUG.2016 21:22:30

CH78-DH1

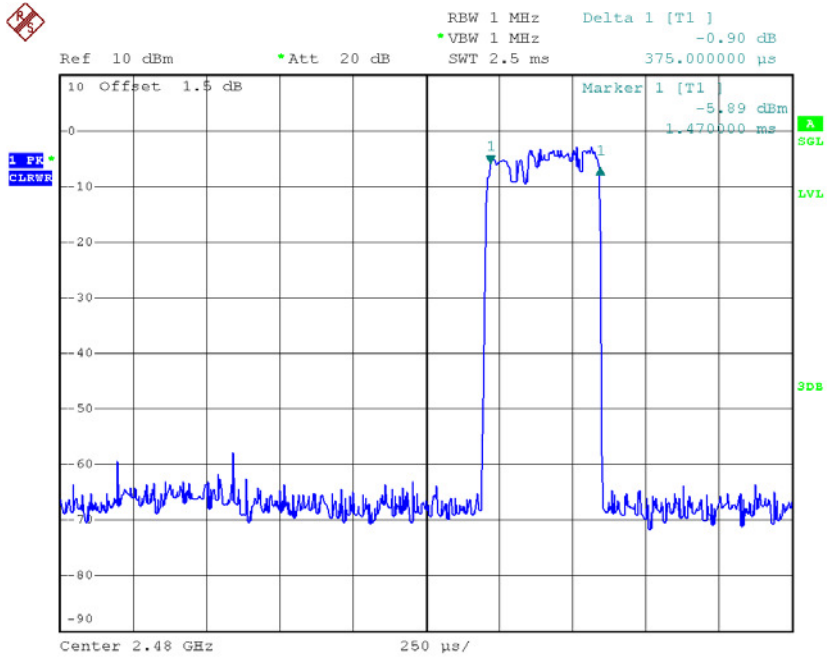

Date: 4.AUG.2016 21:14:50

CH78-DH3

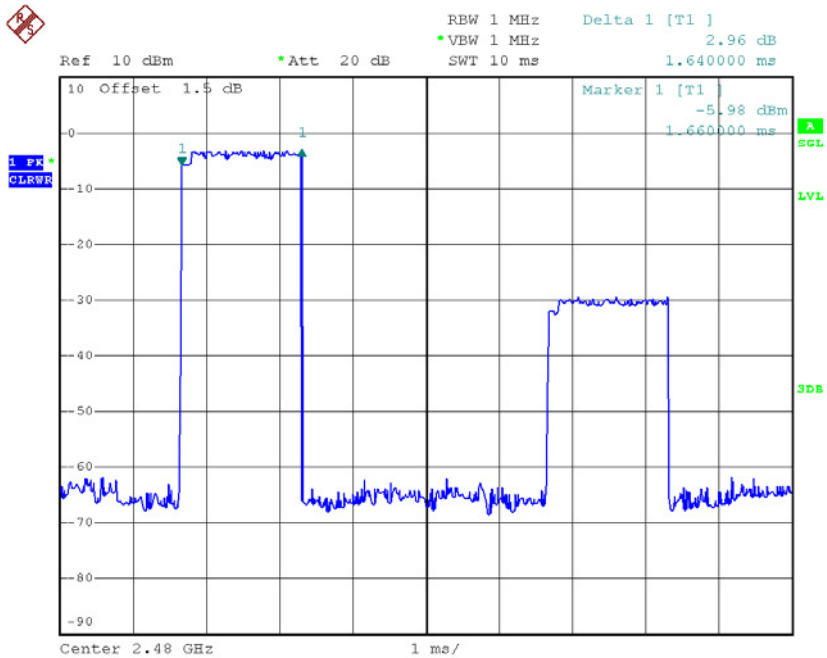

Date: 4.AUG.2016 21:22:05

CH78-DH5

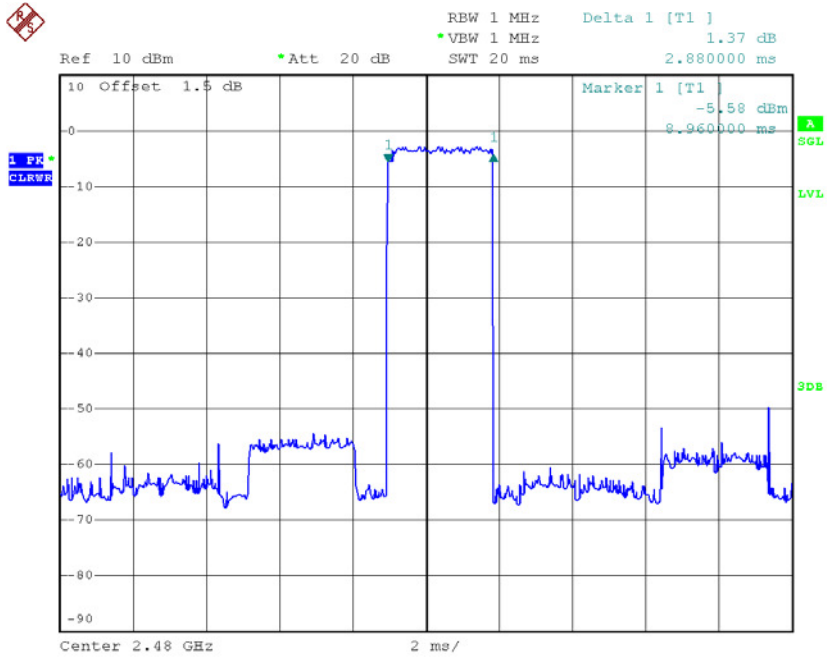

Date: 4.AUG.2016 21:22:35

ATTACHMENT G - HOPPING CHANNEL SEPARATION MEASUREMENT

Test Mode : Hopping on _1Mbps

Frequency (MHz)	Channel Separation (MHz)	2/3 of 20dB Bandwidth (MHz)	Test Result
2402	0.996	0.619	Pass
2441	1.004	0.631	Pass
2480	0.994	0.576	Pass

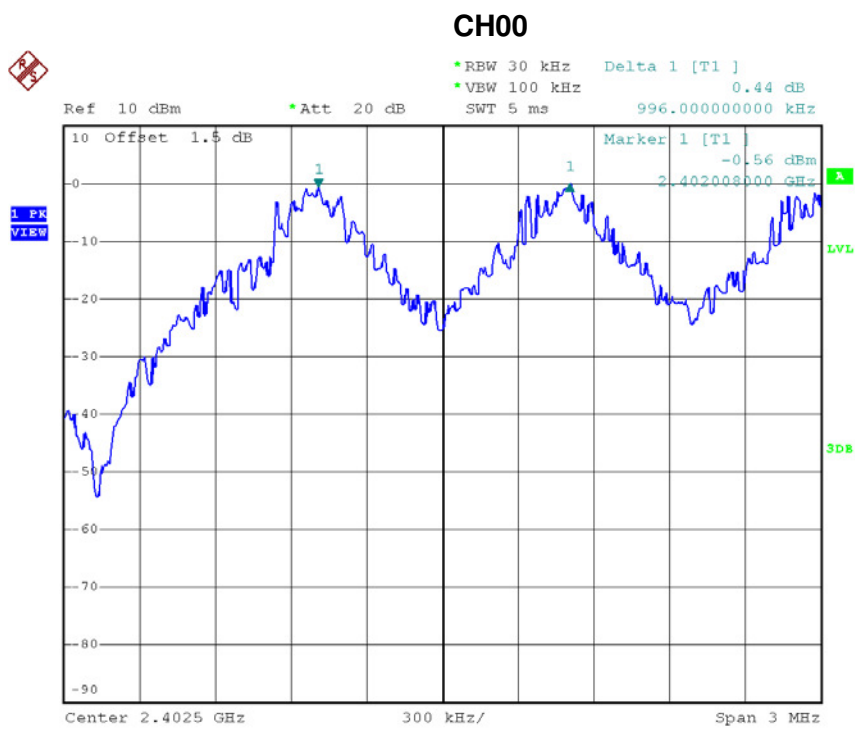

Date: 4.AUG.2016 20:55:12

CH39

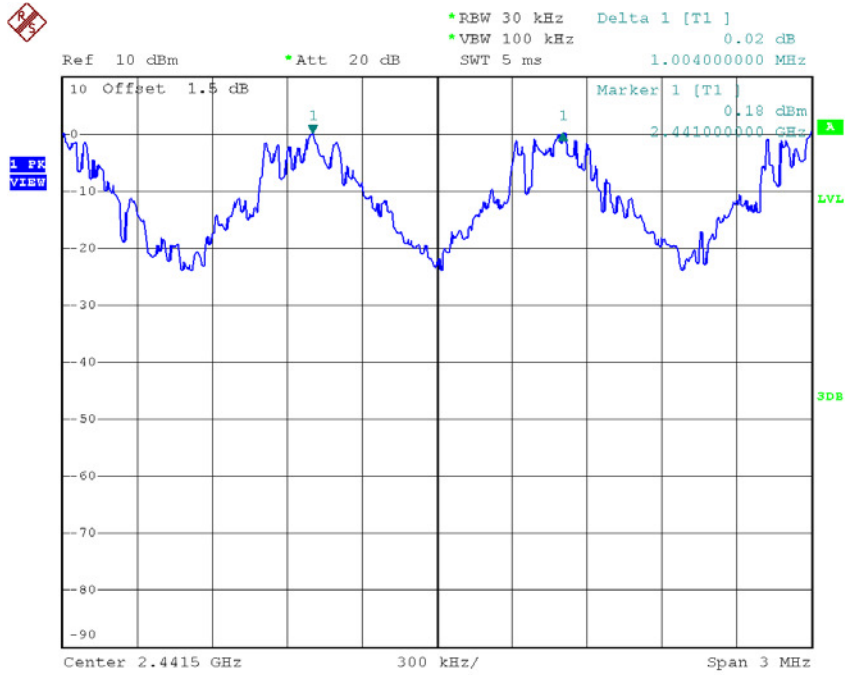

Date: 4.AUG.2016 20:56:21

CH78

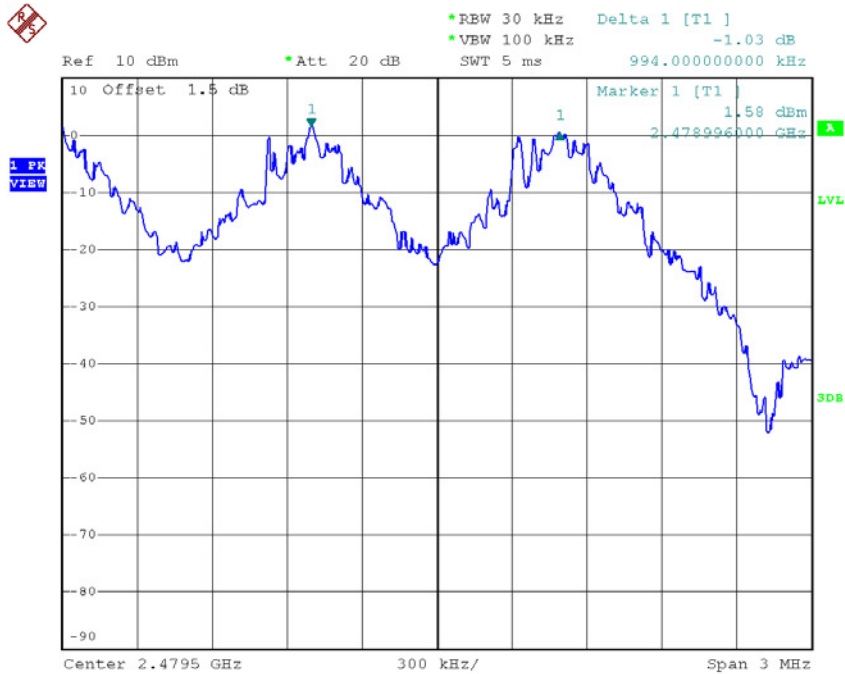

Date: 4.AUG.2016 20:57:31

Test Mode : Hopping on _3Mbps

Frequency (MHz)	Channel Separation (MHz)	2/3 of 20dB Bandwidth (MHz)	Test Result
2402	0.977	0.804	Pass
2441	0.990	0.808	Pass
2480	0.998	0.832	Pass

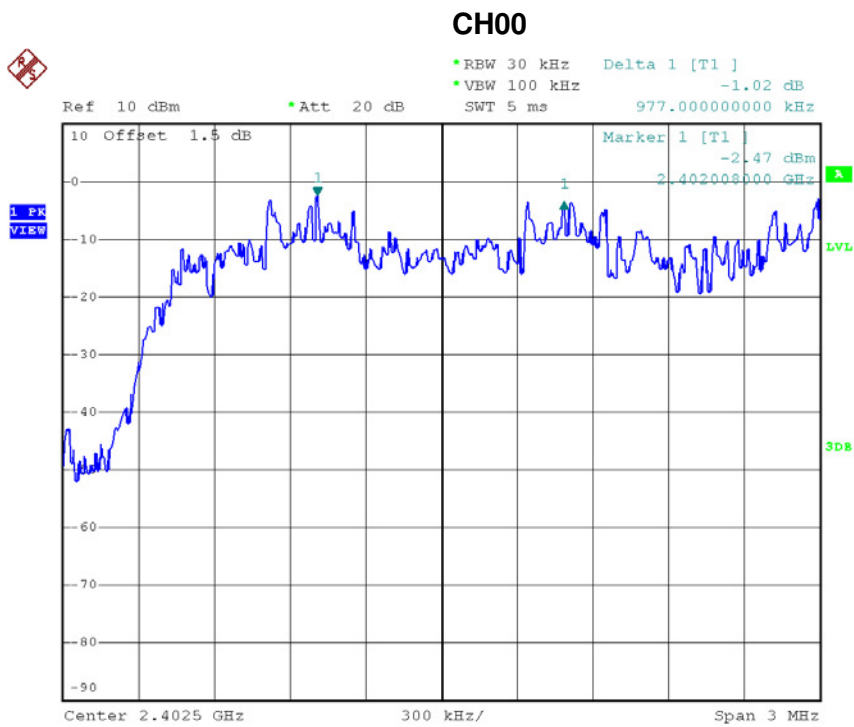

Date: 4.AUG.2016 21:16:03

CH39

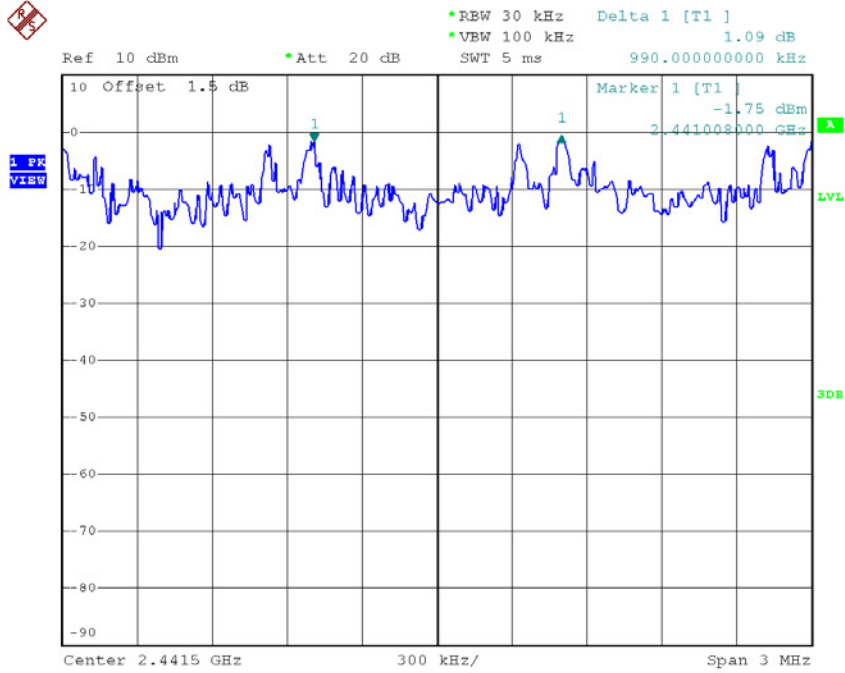

Date: 4.AUG.2016 21:17:08

CH78

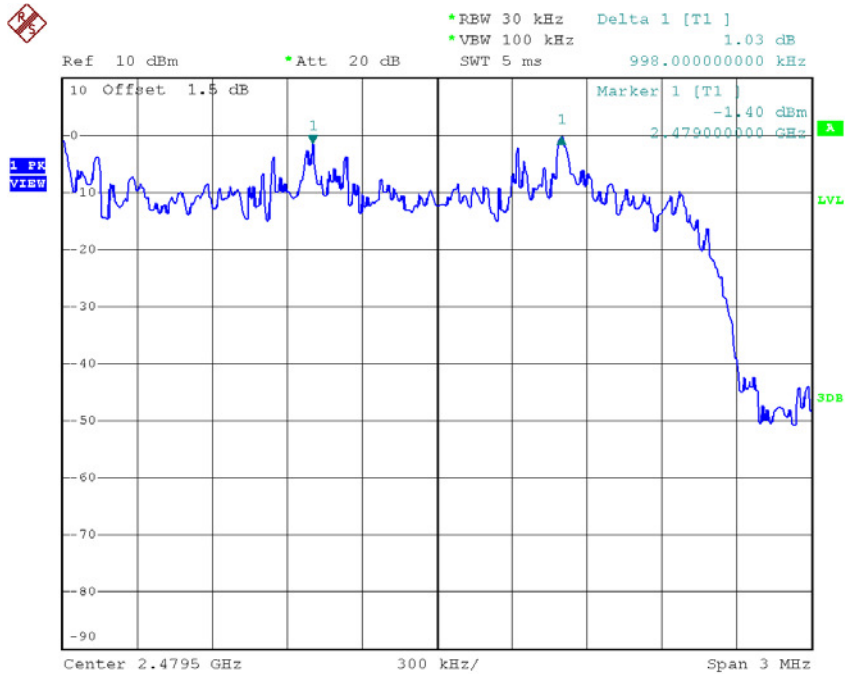

Date: 4.AUG.2016 21:18:16

ATTACHMENT H - BANDWIDTH

Test Mode : TX Mode _1Mbps

Frequency (MHz)	20dB Bandwidth (MHz)	99% Occupied BW (MHz)	Test Result
2402	0.928	0.872	Pass
2441	0.946	0.864	Pass
2480	0.864	0.864	Pass

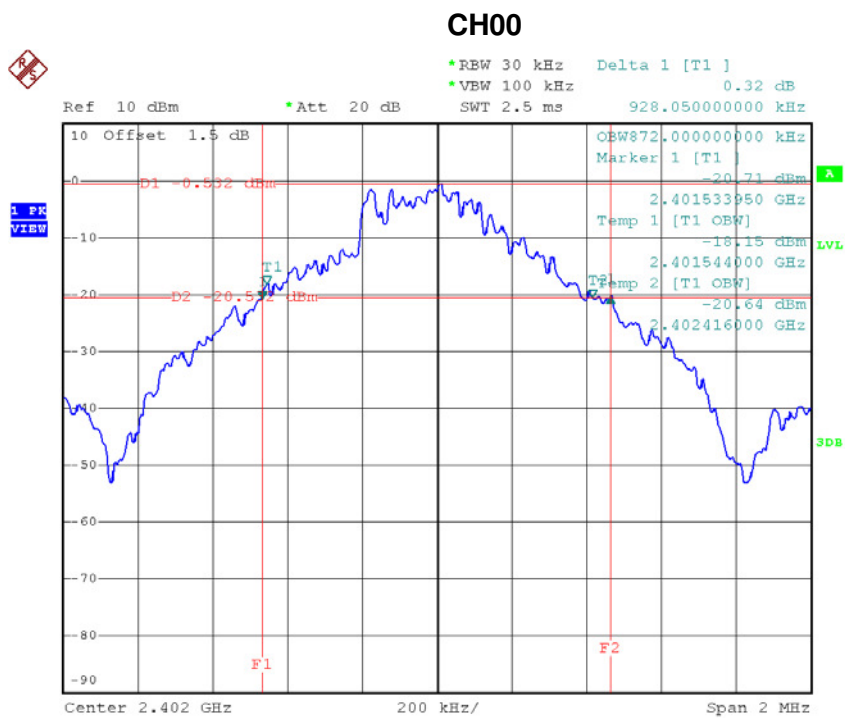

Date: 4.AUG.2016 20:47:51

CH39

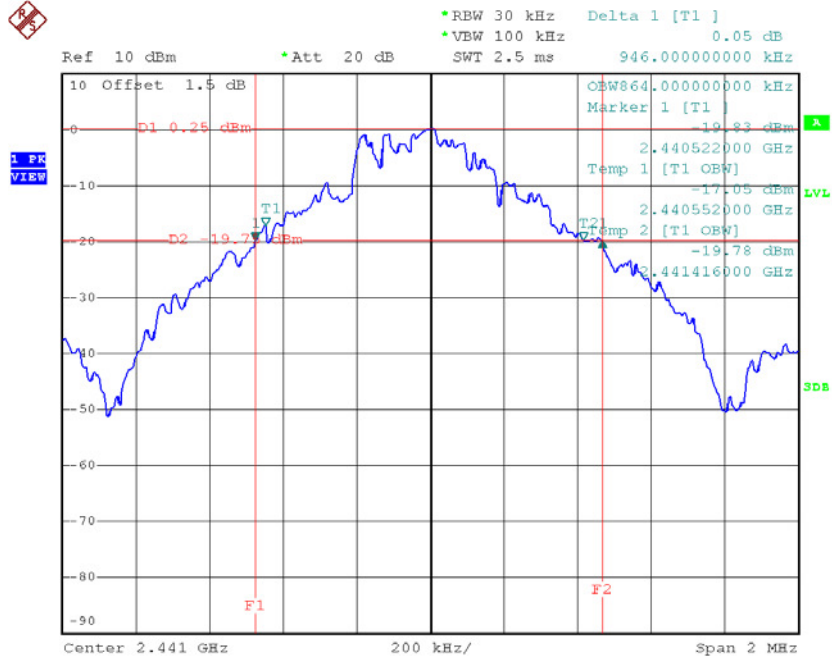

Date: 4.AUG.2016 20:49:59

CH78

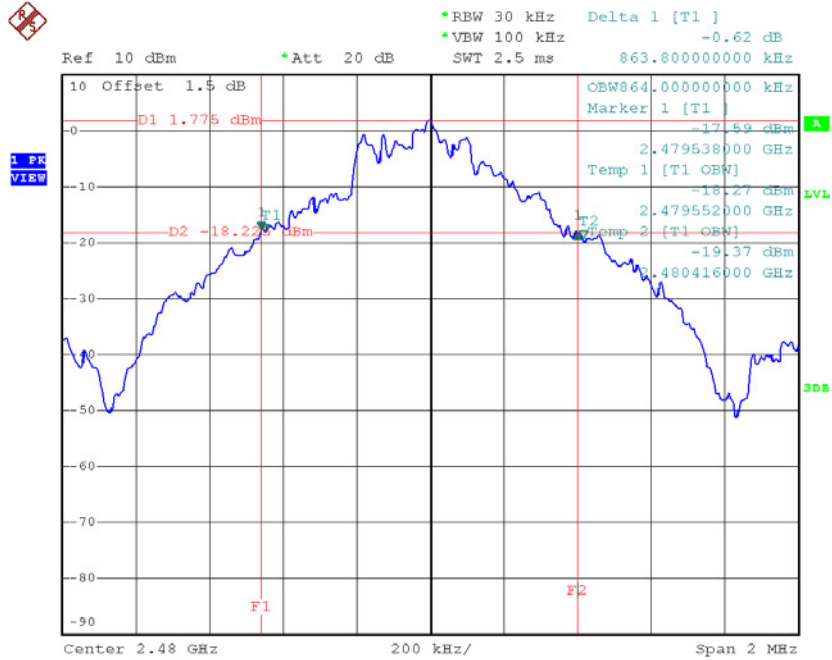

Date: 4.AUG.2016 20:53:03

Test Mode : TX Mode_3Mbps

Frequency (MHz)	20dB Bandwidth (MHz)	99% Occupied BW (MHz)	Test Result
2402	1.206	1.148	Pass
2441	1.212	1.148	Pass
2480	1.248	1.152	Pass

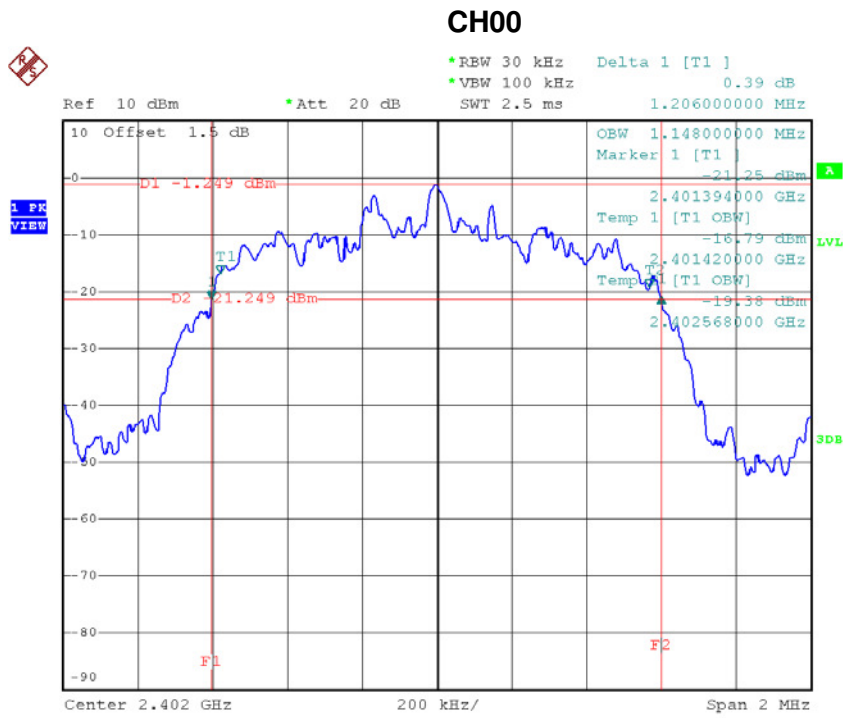

Date: 4.AUG.2016 21:08:45

CH39

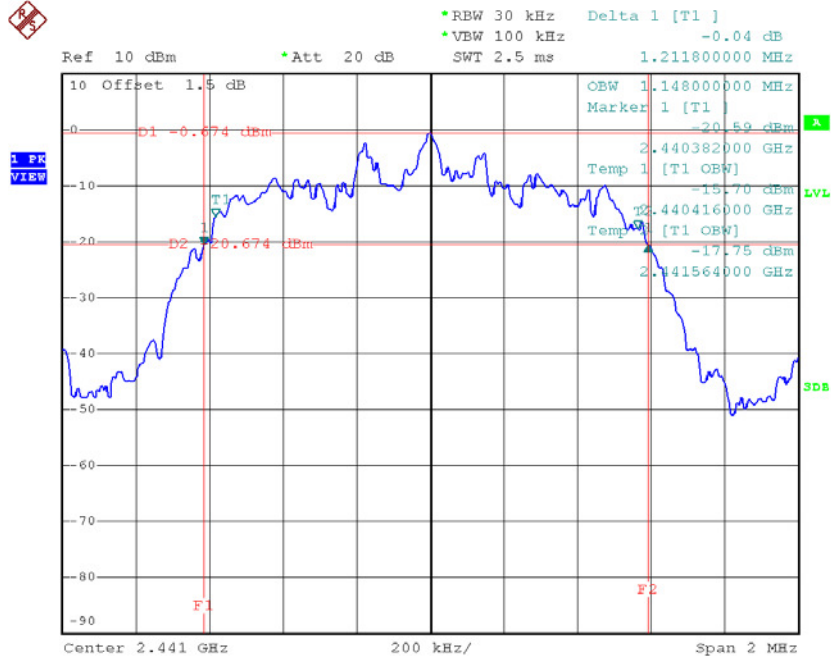

Date: 4.AUG.2016 21:10:43

CH78

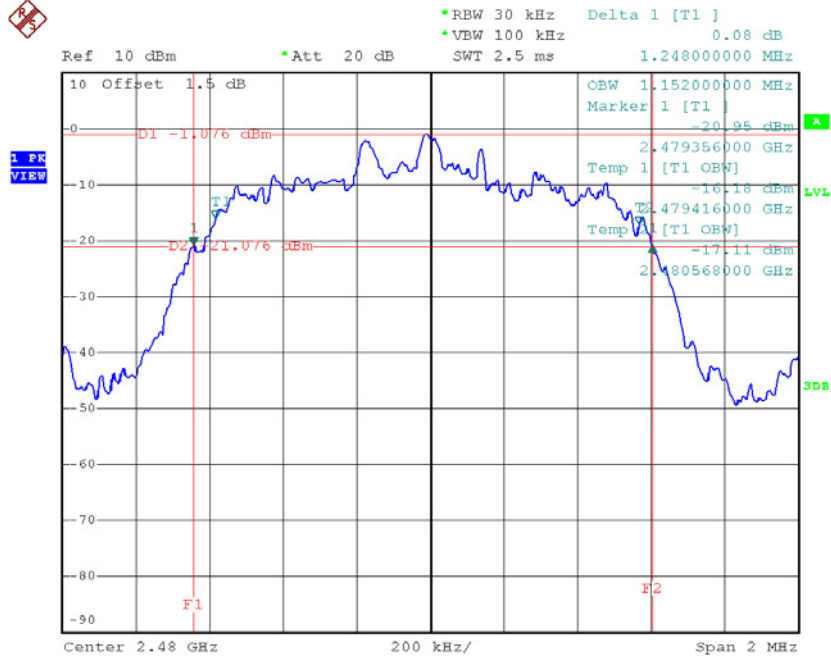

Date: 4.AUG.2016 21:11:57

ATTACHMENT I - PEAK OUTPUT POWER

CH39

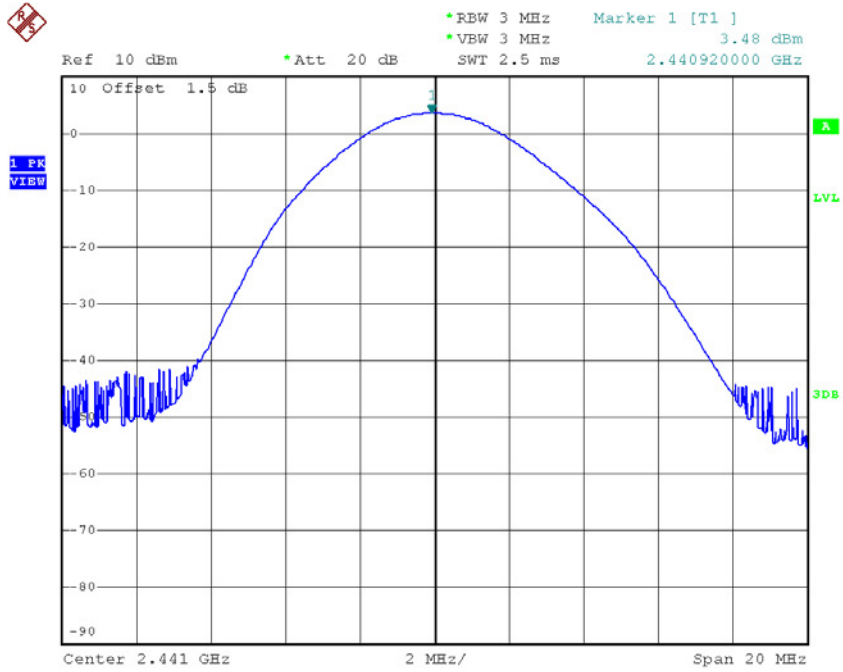

Date: 4.AUG.2016 20:42:41

CH78

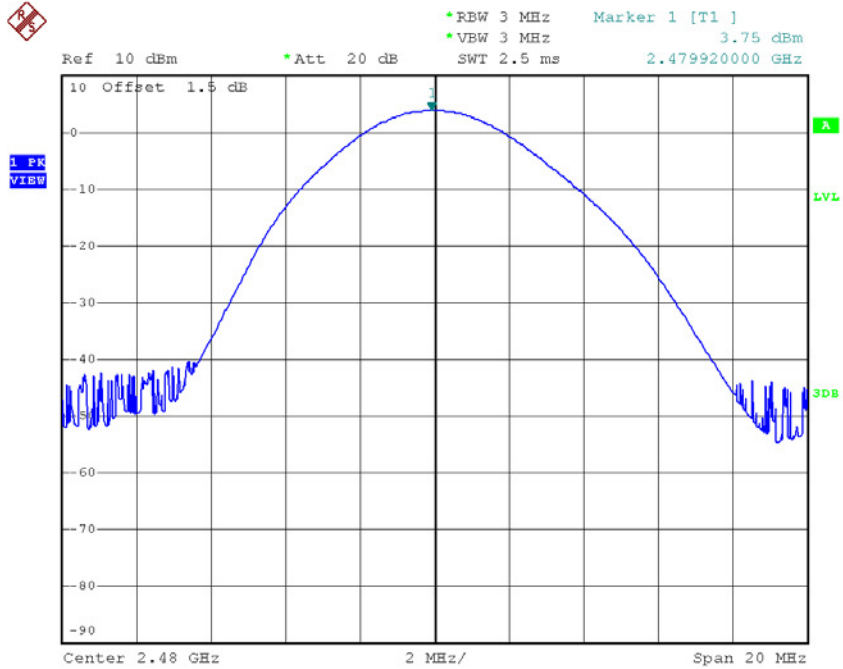

Date: 4.AUG.2016 20:43:26

Test Mode : TX Mode _3Mbps

Frequency (MHz)	Conducted Power (dBm)	Conducted Power (W)	Max. Limit (dBm)	Max. Limit (W)	Test Result
2402	3.00	0.0020	21.00	0.125	Pass
2441	3.90	0.0025	21.00	0.125	Pass
2480	4.10	0.0026	21.00	0.125	Pass

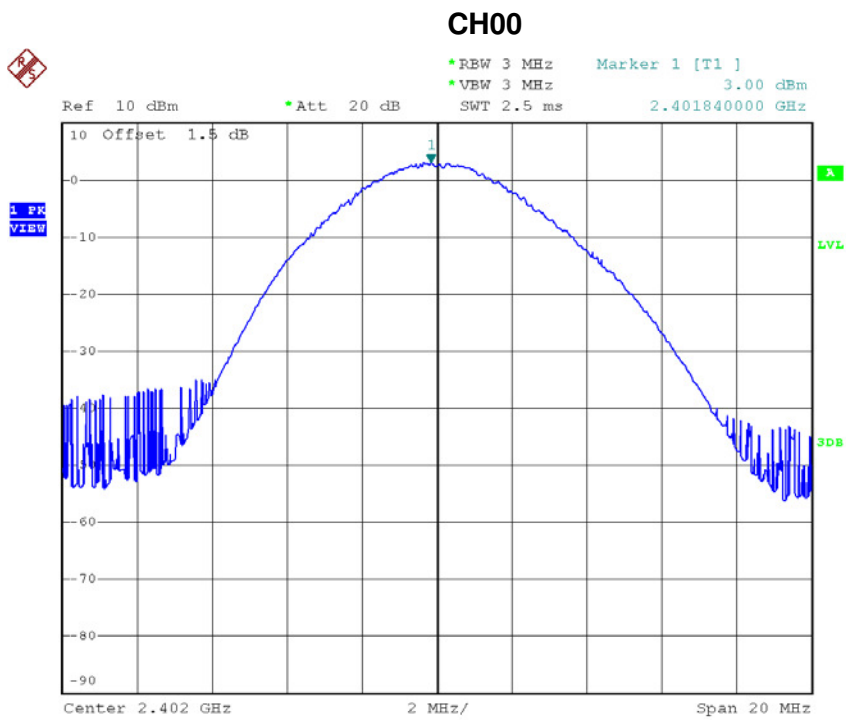

Date: 4.AUG.2016 20:44:18

CH39

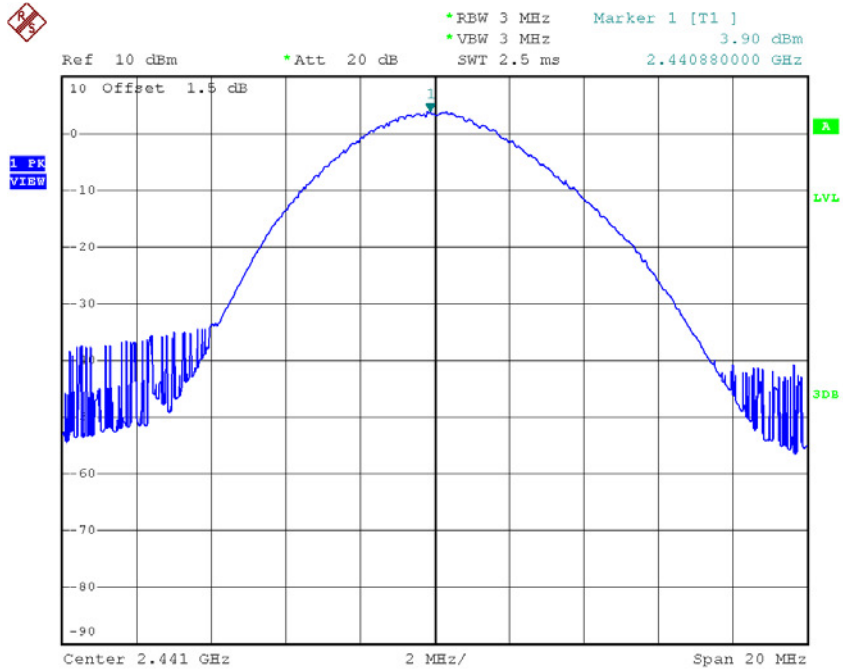

Date: 4.AUG.2016 20:44:57

CH78

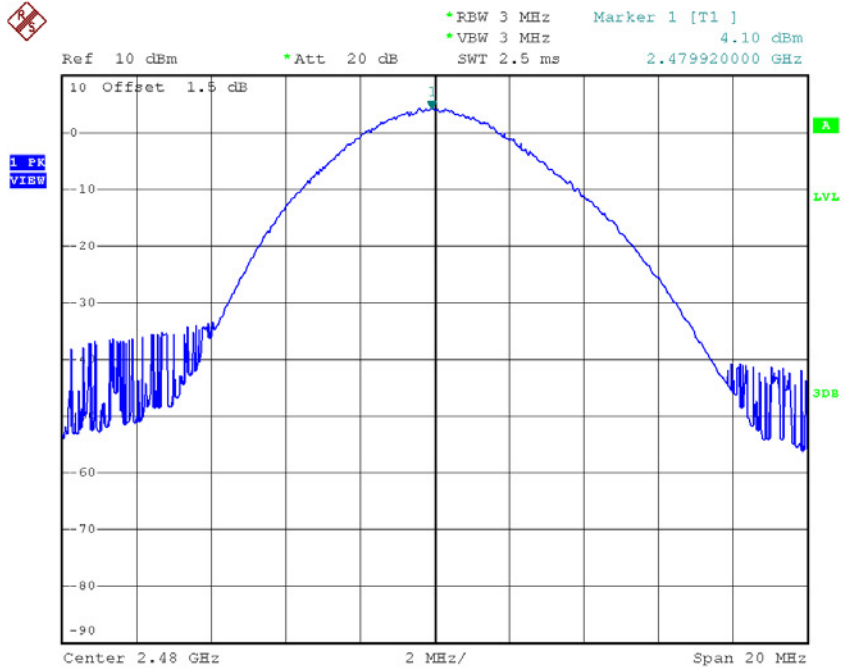

Date: 4.AUG.2016 20:45:19

ATTACHMENT J - ANTENNA CONDUCTED SPURIOUS EMISSION

CH00 (Lower)_1Mbps

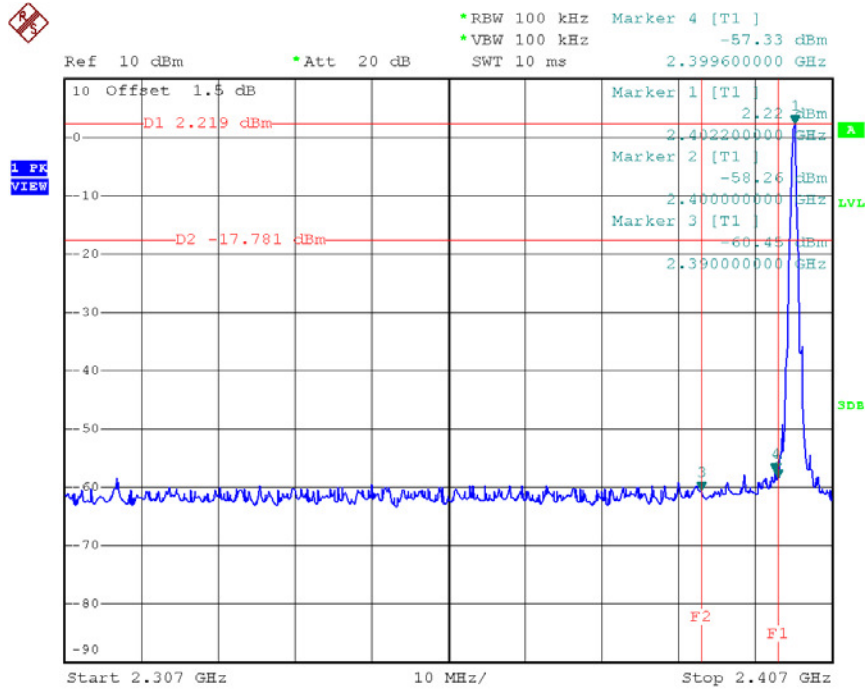

Date: 4.AUG.2016 20:47:15

CH78 (Upper)_1Mbps

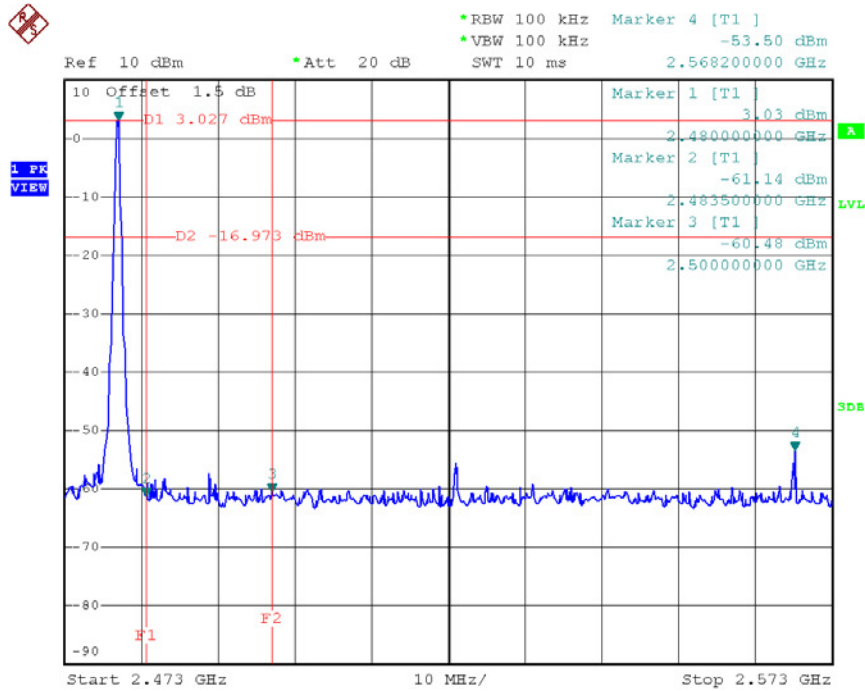

Date: 4.AUG.2016 20:52:23

CH00 Hopping on mode (Lower)_1Mbps

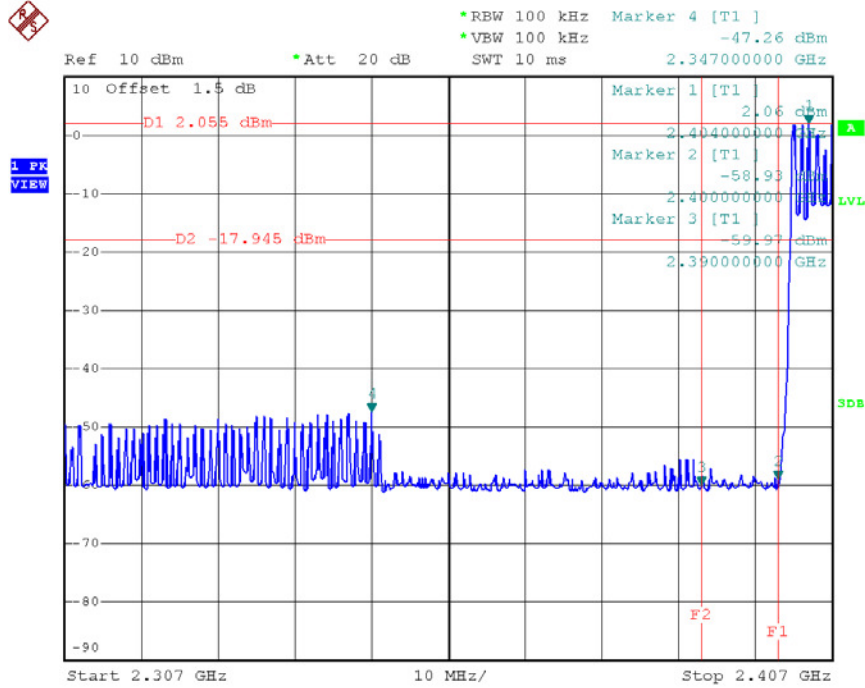

Date: 4.AUG.2016 21:00:00

CH78 Hopping on mode (Upper)_1Mbps

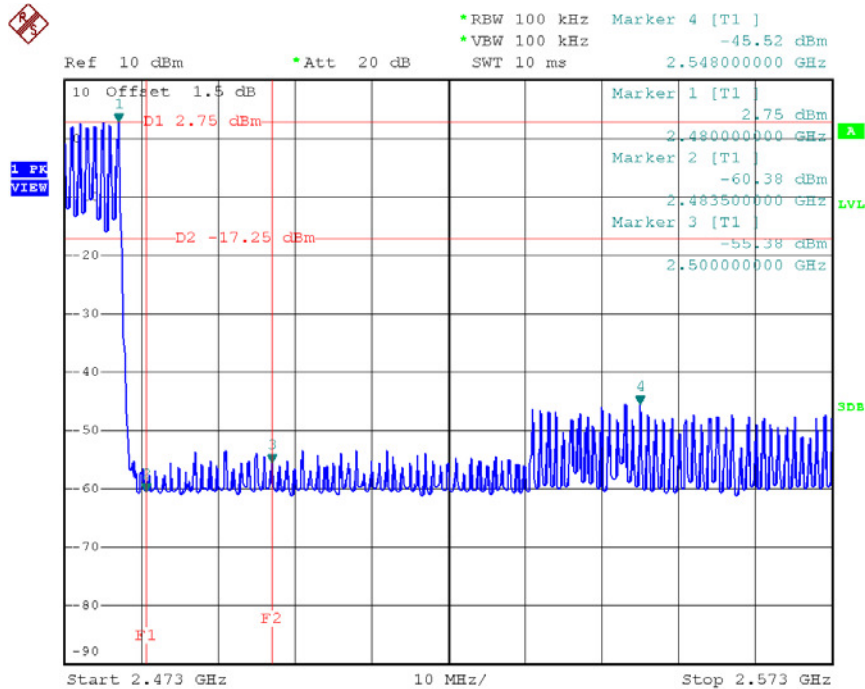

Date: 4.AUG.2016 21:02:50

CH00 (10 Harmonic of the frequency) _1Mbps

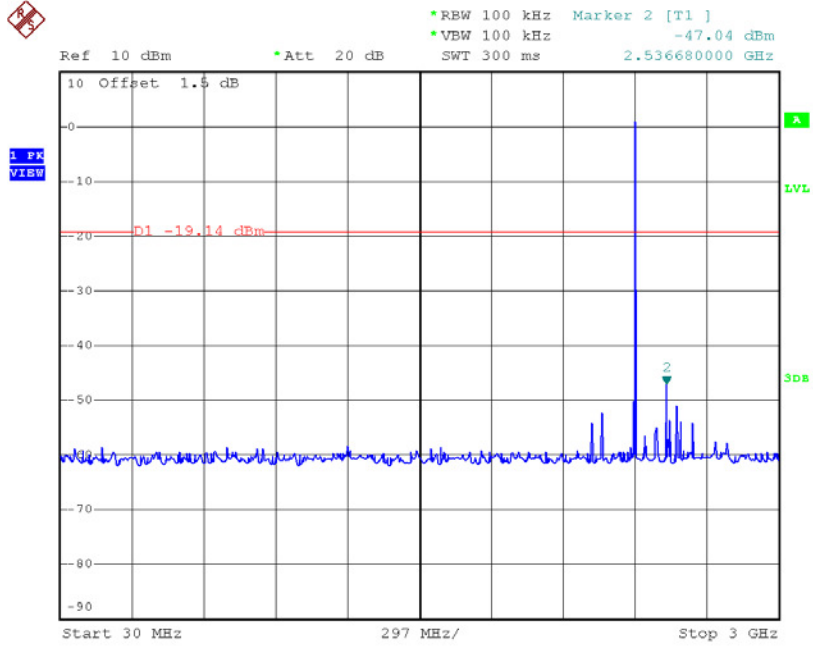

Date: 4.AUG.2016 20:48:05

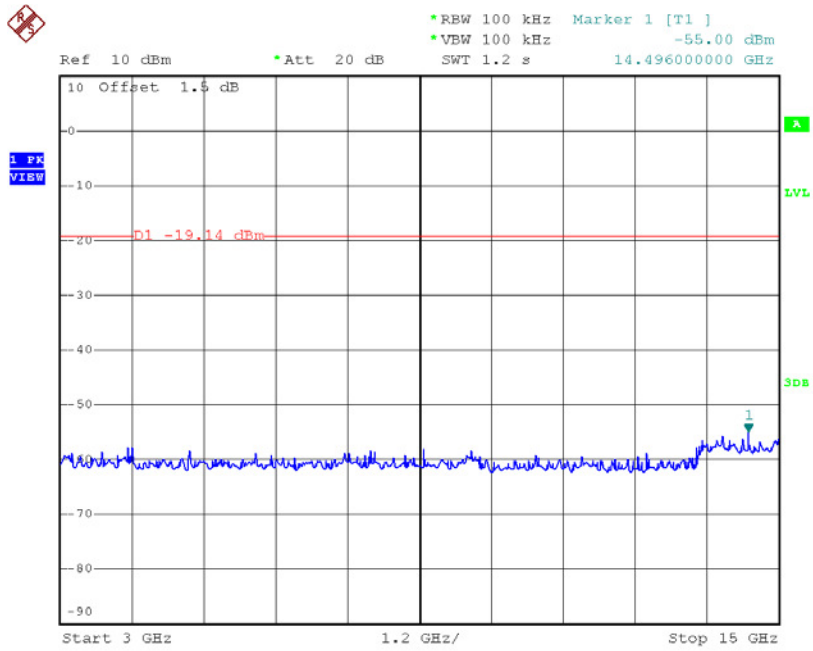

Date: 4.AUG.2016 20:48:15

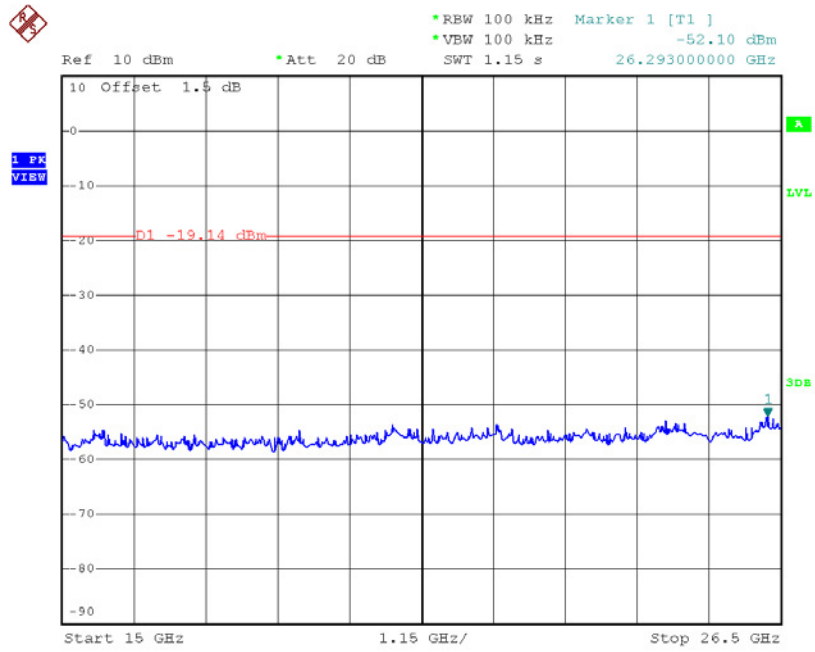

Date: 4.AUG.2016 20:48:24

CH39 (10 Harmonic of the frequency) _1Mbps

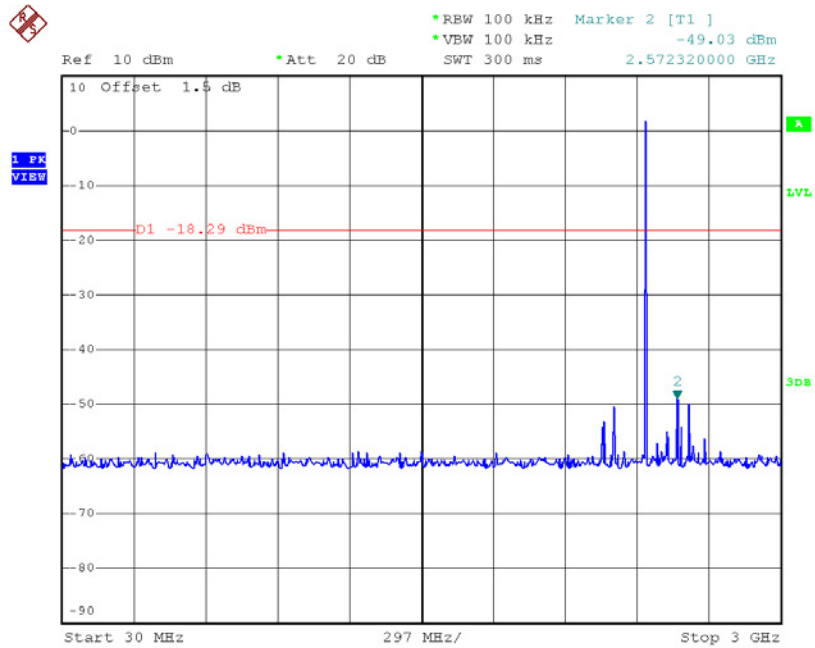

Date: 4.AUG.2016 20:49:06

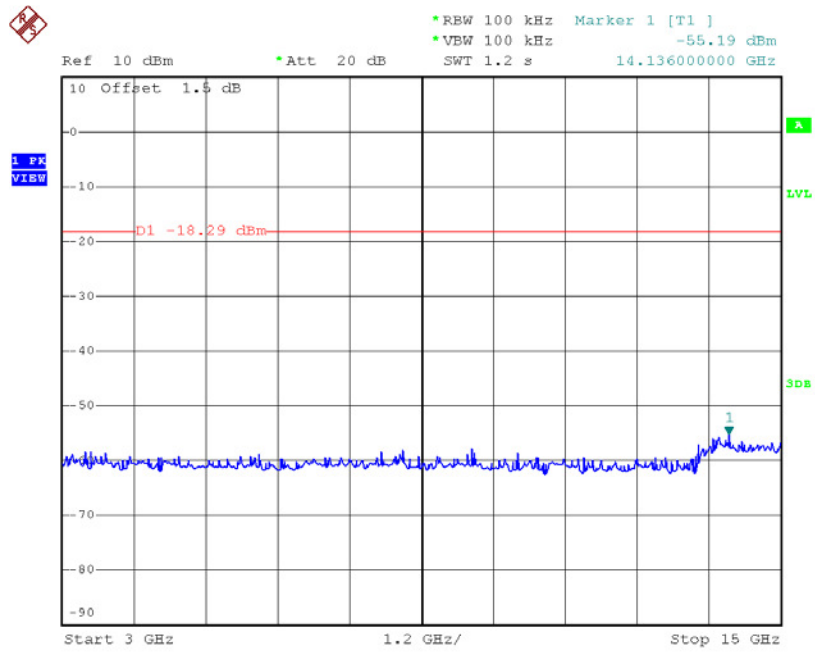

Date: 4.AUG.2016 20:49:15

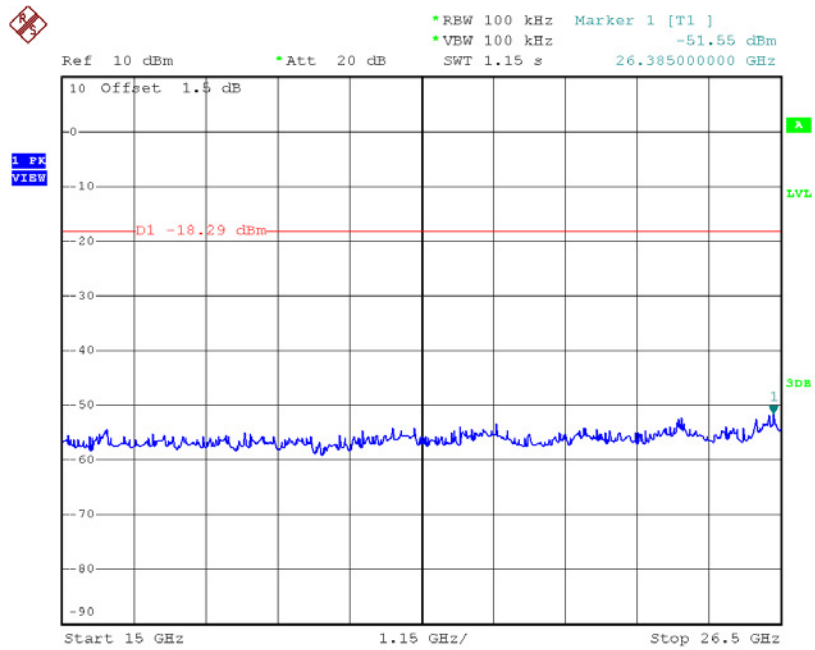

Date: 4.AUG.2016 20:49:25

CH78 (10 Harmonic of the frequency) _1Mbps

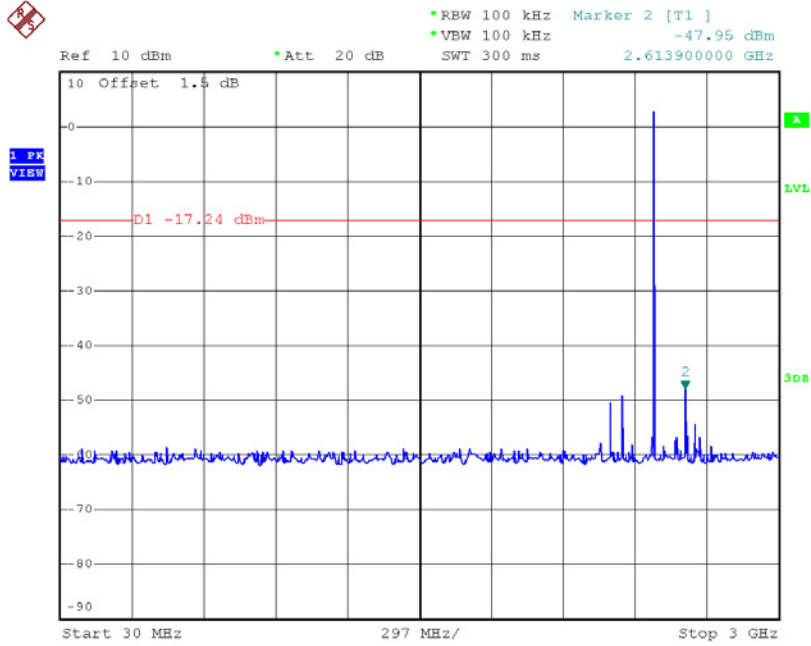

Date: 4.AUG.2016 20:53:18

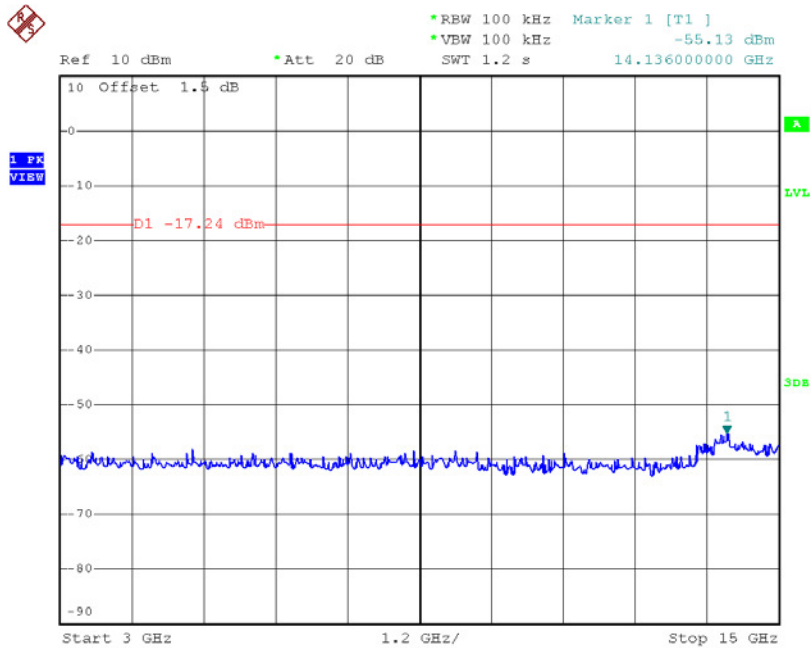

Date: 4.AUG.2016 20:53:27

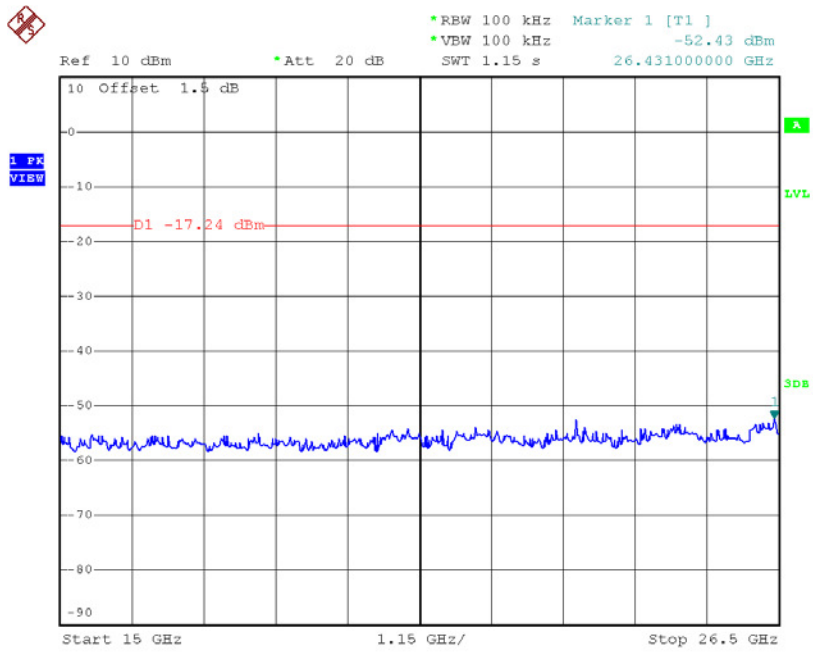

Date: 4.AUG.2016 20:53:36

CH00 (Lower) _3Mbps

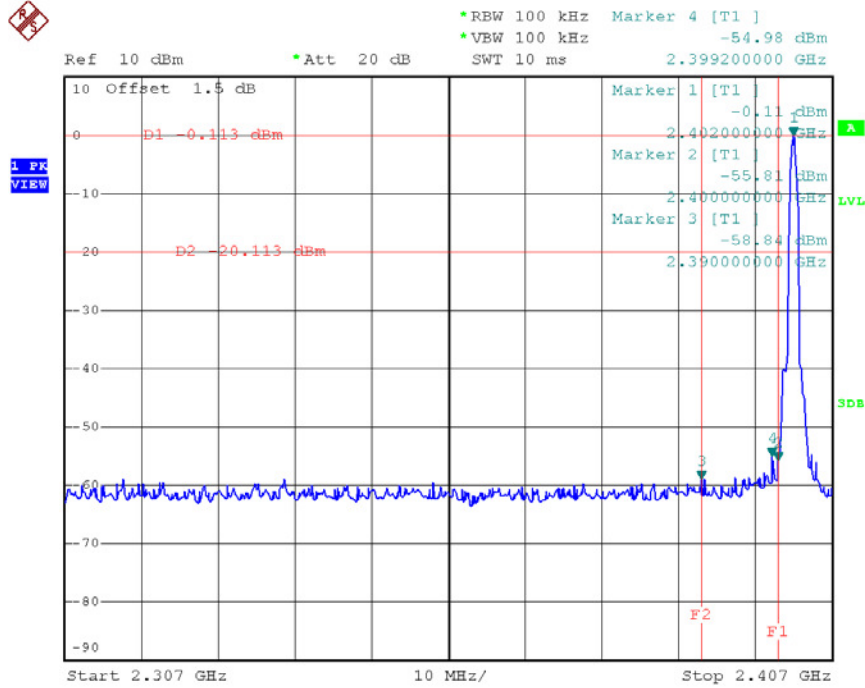

Date: 4.AUG.2016 21:08:18

CH78 (Upper) _3Mbps

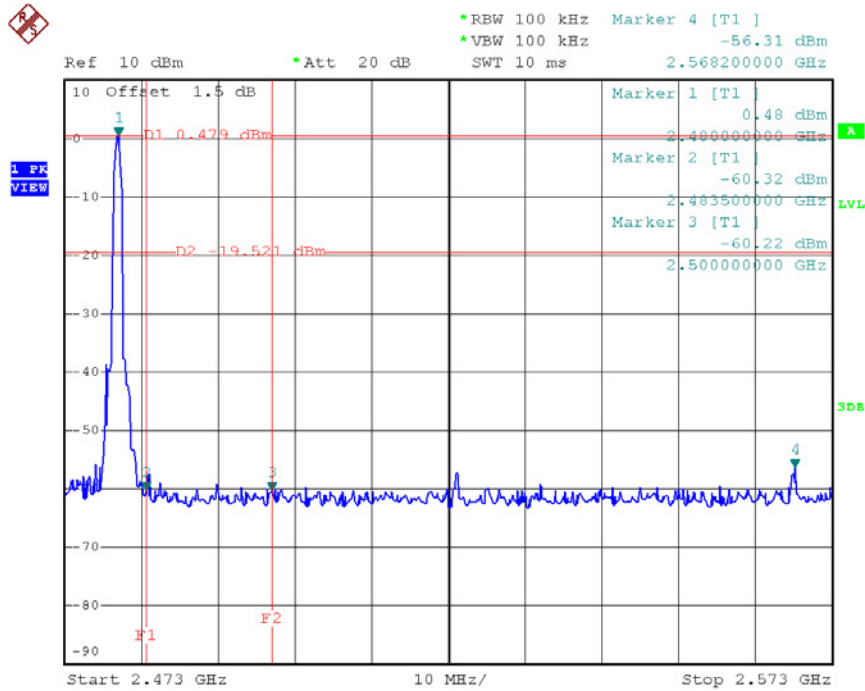

Date: 4.AUG.2016 21:11:31

CH00 Hopping on mode (Lower)_3Mbps

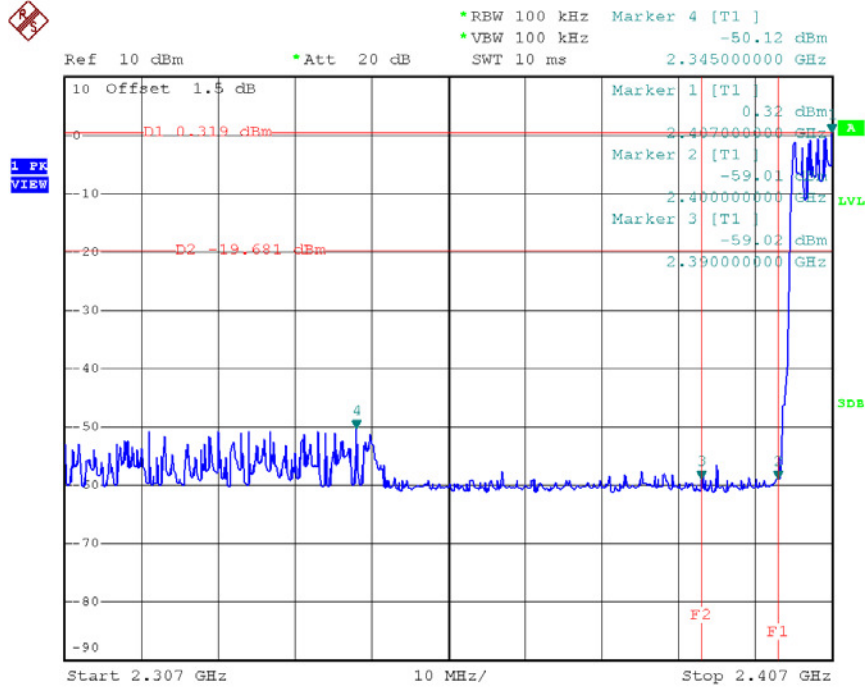

Date: 4.AUG.2016 21:20:43

CH78 Hopping on mode (Upper)_3Mbps

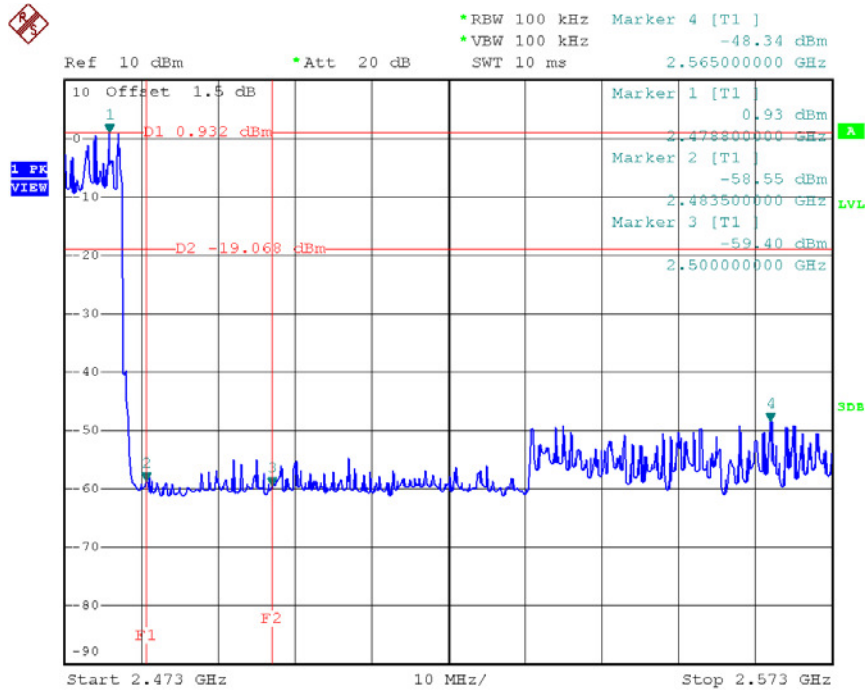

Date: 4.AUG.2016 21:21:20

CH00 (10 Harmonic of the frequency) _3Mbps

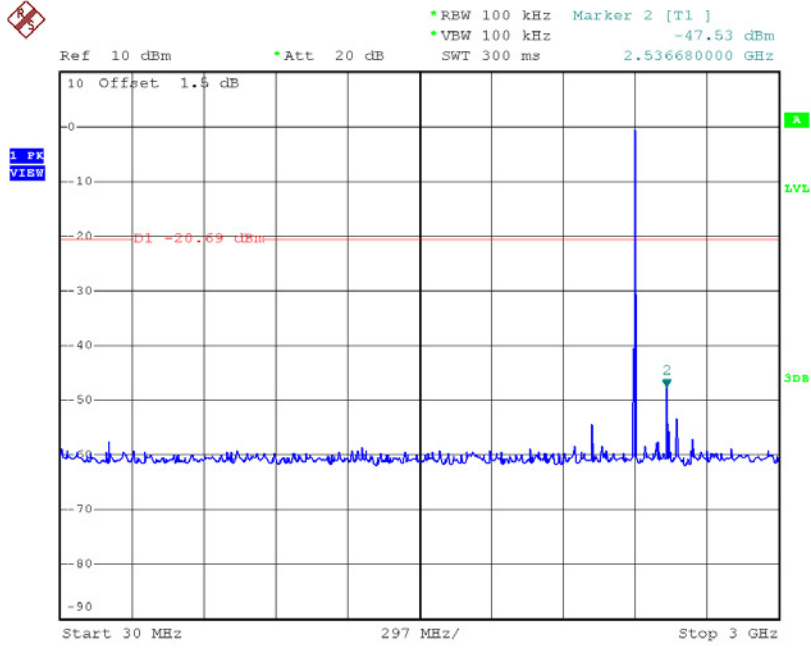

Date: 4.AUG.2016 21:09:00

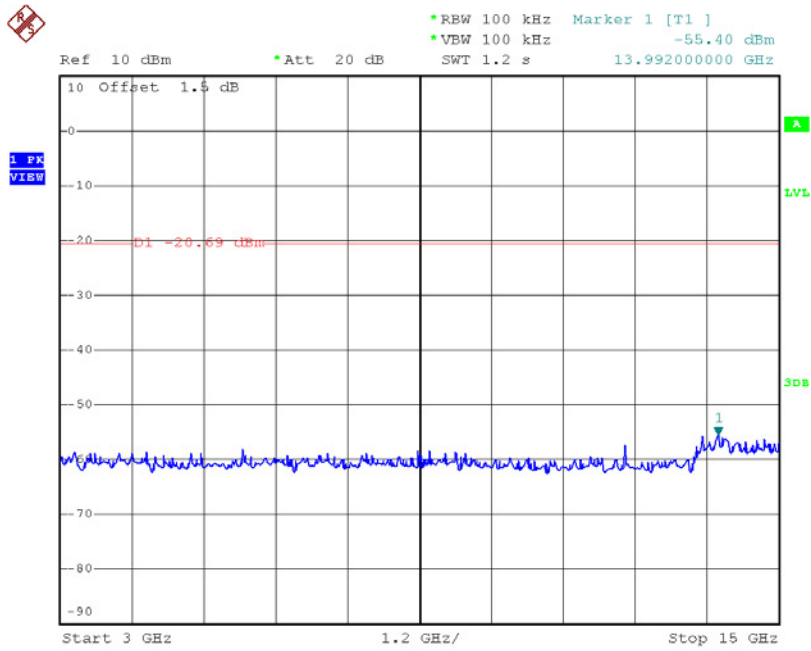

Date: 4.AUG.2016 21:09:09

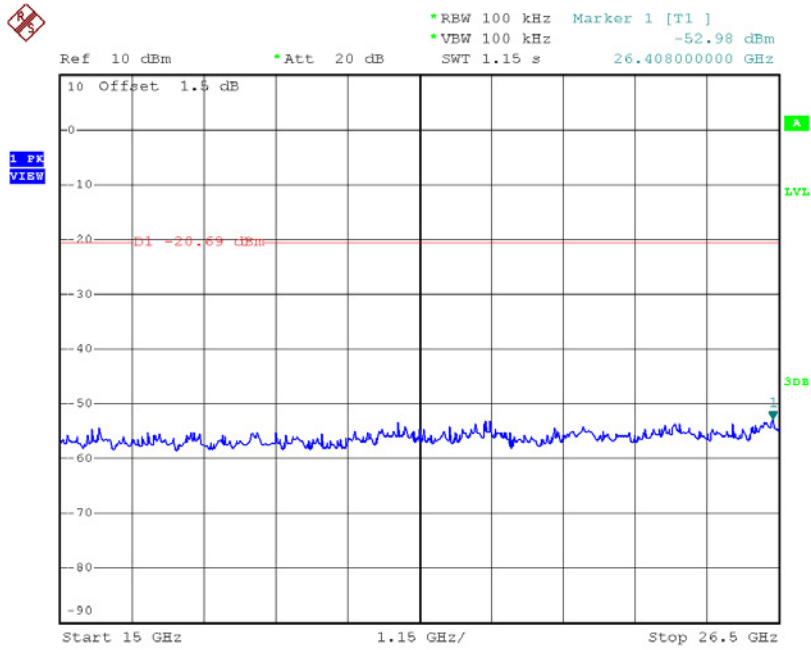

Date: 4.AUG.2016 21:09:18

CH39 (10 Harmonic of the frequency) _3Mbps

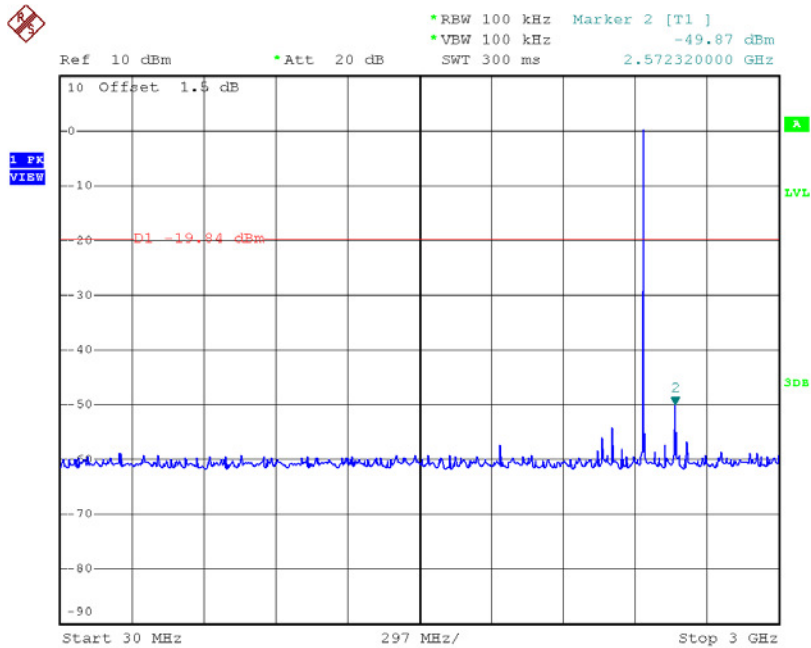

Date: 4.AUG.2016 21:09:59

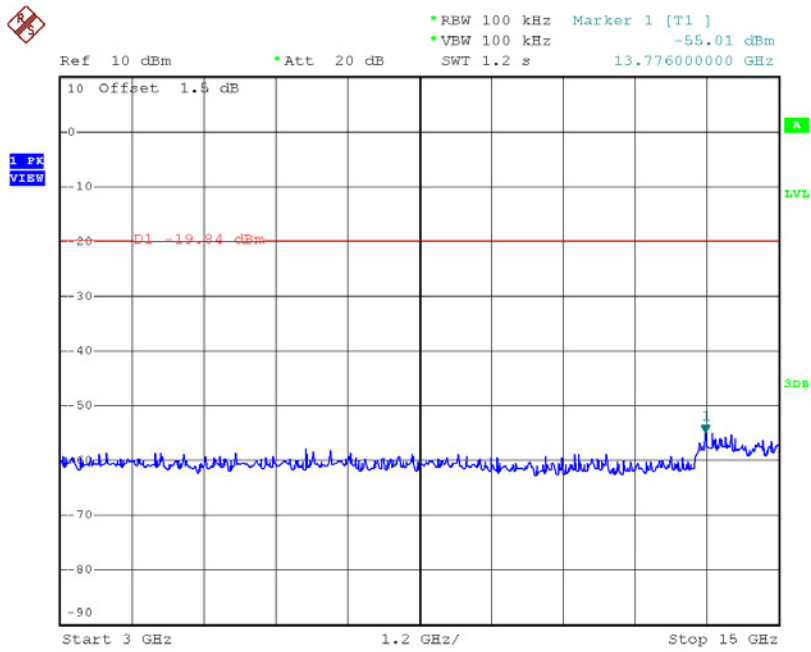

Date: 4.AUG.2016 21:10:08

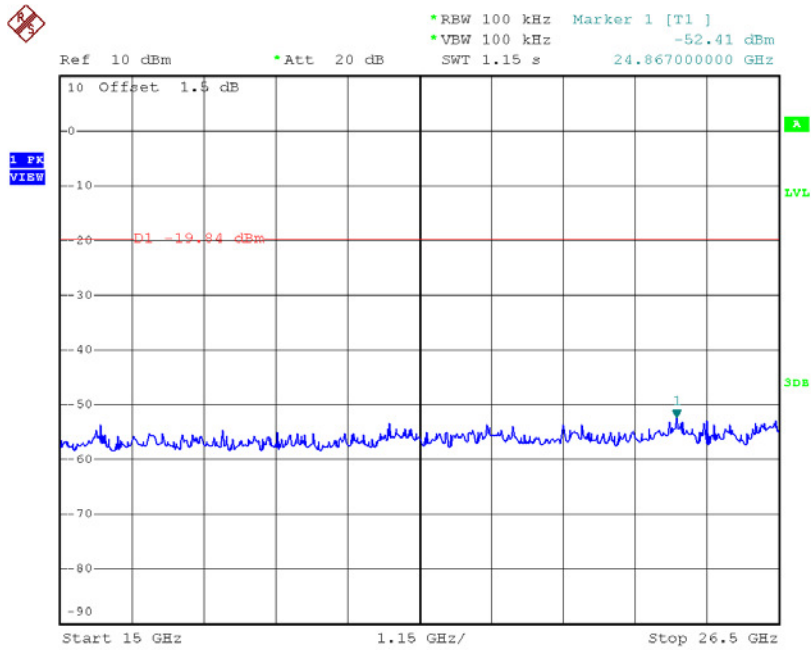

Date: 4.AUG.2016 21:10:17

CH78 (10 Harmonic of the frequency) _3Mbps

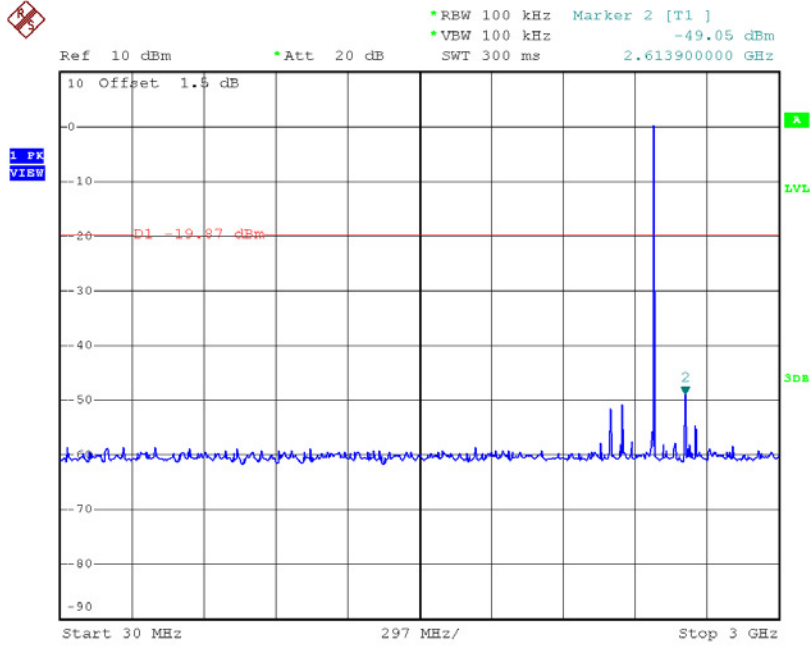

Date: 4.AUG.2016 21:12:19

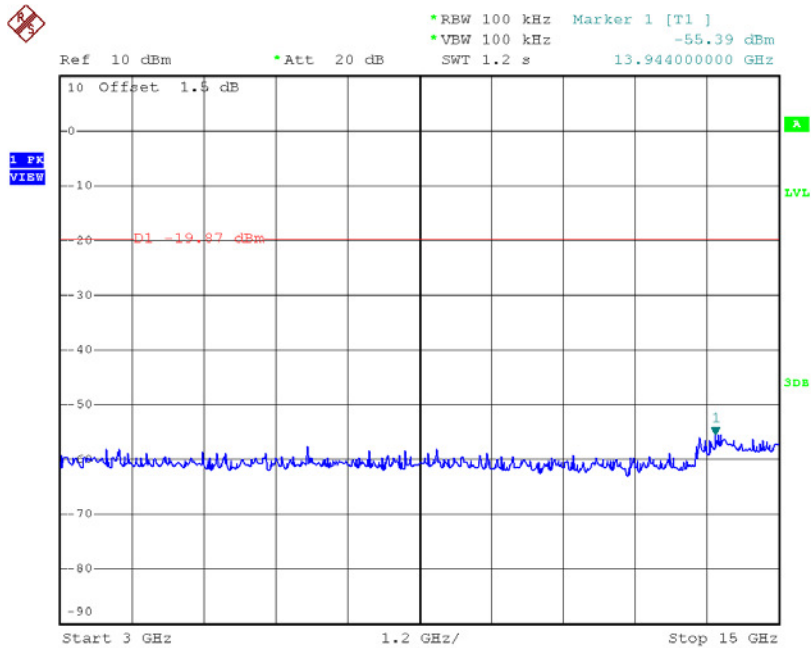

Date: 4.AUG.2016 21:12:28

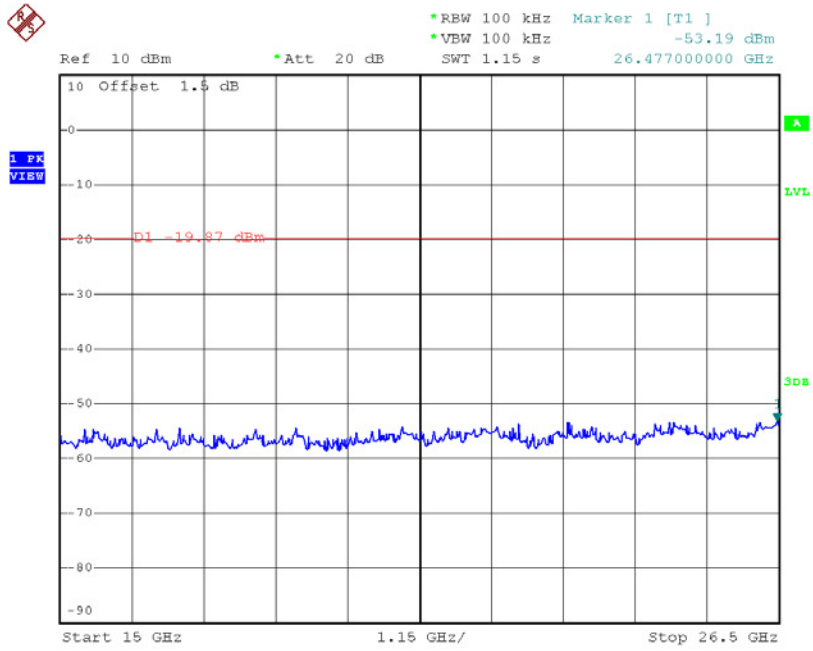

Date: 4.AUG.2016 21:12:37