

FCC PART 15C TEST REPORT FOR CERTIFICATION
On Behalf of

Razer Inc.

Notebook

Brand Name	Model No.
Razer	RZ09-0116

FCC ID: RWO-RZ090116

Prepared for : Razer Inc.
2035 Corte Del Nogal, Suite 101, Carlsbad CA 92011, USA

Prepared By : Audix Technology (Shenzhen) Co., Ltd.
No. 6, Ke Feng Rd., 52 Block,
Shenzhen Science & Industrial Park,
Nantou, Shenzhen, Guangdong, China

Tel: (0755) 26639496

Report Number : ACS-F13270
Date of Test : Feb.20~Mar.07, 2014
Date of Report : Mar.19, 2014

TABLE OF CONTENTS

<u>Description</u>	<u>Page</u>
1. SUMMARY OF STANDARDS AND RESULTS	1-1
1.1. Description of Standards and Results	1-1
2. GENERAL INFORMATION	2-1
2.1. Description of Device (EUT)	2-1
2.2. Test Information	2-3
2.3. Tested Supporting System Details	2-3
2.4. Block Diagram of Test Setup	2-3
2.5. Test Facility	2-4
2.6. Measurement Uncertainty (95% confidence levels, k=2).....	2-4
3. POWER LINE CONDUCTED EMISSION TEST.....	3-1
3.1. Test Equipments	3-1
3.2. Block Diagram of Test Setup	3-1
3.3. Power Line Conducted Emission Test Limits	3-1
3.4. Configuration of EUT on Test.....	3-2
3.5. Operating Condition of EUT	3-2
3.6. Test Procedure	3-2
3.7. Power Line Conducted Emission Test Results	3-2
4. RADIATED EMISSION TEST	4-1
4.1. Test Equipment.....	4-1
4.2. Block Diagram of Test Setup	4-2
4.3. Radiated Emission Limit	4-3
4.4. EUT Configuration on Test	4-3
4.5. Operating Condition of EUT	4-3
4.6. Test Procedure	4-4
4.7. Radiated Emission Test Results	4-4
5. BAND EDGE COMPLIANCE TEST	5-1
5.1. Test Equipment.....	5-1
5.2. Limit	5-1
5.3. Test Produce	5-1
5.4. Test Results	5-2
6. 20dB & 26dB Bandwidth Test	6-1
6.1. Test Equipment.....	6-1
6.2. Limit	6-1
6.3. Test Procedure	6-1
6.4. Test Results	6-1
7. OUTPUT POWER TEST	7-1
7.1. Test Equipment.....	7-1
7.2. Limit	7-1
7.3. Test Procedure	7-1
7.4. Test Results	7-2
8. POWER SPECTRAL DENSITY TEST	8-1
8.1. Test Equipment.....	8-1
8.2. Limit	8-1
8.3. Test Procedure	8-1
8.4. Test Results	8-2
9. PEAK EXCURSION MEASUREMENT	9-1
9.1. Test Equipment.....	9-1

9.2.	Limit	9-1
9.3.	Test Procedure	9-1
9.4.	Test Results	9-2
10.	FREQUENCY STABILITY MEASUREMENT	10-1
10.1.	Test Equipment.....	10-1
10.2.	Limit	10-1
10.3.	Test Procedure	10-1
10.4.	Test Result	10-2
11.	ANTENNA REQUIREMENT	11-8
11.1.	STANDARD APPLICABLE	11-8
11.2.	ANTENNA CONNECTED CONSTRUCTION	11-8
12.	DEVIATION TO TEST SPECIFICATIONS	12-1
13.	PHOTOGRAPH OF TEST.....	13-1
13.1.	Photos of Power Line Conducted Emission Test	13-1
13.2.	Photos of Radiated Emission Test.....	13-2

TEST REPORT CERTIFICATION

Applicant : Razer Inc.
 Manufacturer : Razer Inc.
 EUT Description : Notebook
 FCC ID : RWO-RZ090116

(A) MODEL NO. & BRAND NAME	Brand Name	Model No.
	Razer	RZ09-0116

(B) SERIAL NO. : N/A
 (C) POWER SUPPLY : AC 100-240V, 50/60Hz
 (D) TEST VOLTAGE : DC 19V From Adapter Input AC 120V/60Hz

Tested for comply with:
 FCC Rules and Regulations Part 15 Subpart C: 2012

Test procedure used:
 ANSI C63.10:2009
 KDB789033D01: KDB644545D01

The device described above is tested by AUDIX TECHNOLOGY (SHENZHEN) CO., LTD. to confirm comply with all the FCC Part 15 Subpart C requirements. The test results are contained in this test report and AUDIX TECHNOLOGY (SHENZHEN) CO., LTD. is assumed full responsibility for the accuracy and completeness of these tests. Also, this report shows that the Equipment Under Test (EUT) is to be technically compliant with the FCC and IC requirements. This report contains data that are not covered by the NVLAP accreditation.

This Report is made under FCC Part 2.1075. No modifications were required during testing to bring this product into compliance.

This report applies to above tested sample only. This report shall not be reproduced in part without written approval of AUDIX TECHNOLOGY (SHENZHEN) CO., LTD.

The report must not be used by the client to claim product certification, approval, or endorsement by NVLAP, NIST, or any agency of the federal government.

Date of Test : Feb.20~ Mar.07, 2014 Report of date: Mar.19, 2014

Prepared by : Aimee Xiang / Assistant
 Reviewed by : Sunny Lu / Assistant Manager

信華科技(深圳)有限公司
Audix Technology (Shenzhen) Co., Ltd.
EMC 部門報告專用章

Stamp only for EMC Dept. Report

Signature: David Jin 3.19

Approved & Authorized Signer : David Jin / Manager

1. SUMMARY OF STANDARDS AND RESULTS

1.1. Description of Standards and Results

The EUT have been tested according to the applicable standards as referenced below.

EMISSION		
Description of Test Item	Standard	Results
Power Line Conducted Emission	FCC Part 15: 15.207 ANSI C63.10: 2009	PASS
Radiated Emission	FCC Part 15: 15.209 ANSI C63.10: 2009	PASS
Band Edge Compliance	FCC Part 15: 15.247 ANSI C63.10: 2009	PASS
26dB Bandwidth Test	FCC Part 15: 15.407(a)	PASS
Output Power Test	FCC Part 15: 15.407(a)	PASS
Power Spectral Density Test	FCC Part 15: 15.407(a)	PASS
Peak Excursion	FCC Part 15: 15.407(a)	PASS
Frequency Stability	FCC Part 15: 15.407(g) ANSI C63.10: 2009	PASS
Antenna requirement	FCC Part 15: 15.203	PASS

2. GENERAL INFORMATION

2.1. Description of Device (EUT)

Product Name : Notebook

Model Number & Brand Name :	Brand Name	Model No.
	Razer	RZ09-0116

FCC ID : RWO-RZ090116

Radio : Bluetooth V3.0+EDR; Bluetooth V4.0; IEEE802.11 a/b/g/n/ac

Operation Frequency : IEEE 802.11a: 5180MHz—5240MHz, 5260MHz—5320MHz, 5500MHz—5700MHz; 5745MHz—5825MHz
 IEEE 802.11ac VHT20: 5180MHz—5240MHz, 5260MHz—5320MHz, 5500MHz—5700MHz; 5745MHz—5825MHz
 IEEE 802.11ac VHT40: 5190MHz—5230MHz, 5270MHz—5310MHz, 5510MHz—5710MHz; 5755MHz—5795MHz
 IEEE 802.11ac VHT80: 5210MHz, 5290MHz, 5530MHz—5690MHz; 5775MHz
 IEEE 802.11b: 2412MHz—2462MHz
 IEEE 802.11g: 2412MHz—2462MHz
 IEEE802.11nHT20: 2412MHz—2462MHz; 5180MHz—5240MHz, 5260MHz—5320MHz, 5500MHz—5700MHz; 5745MHz—5825MHz
 IEEE802.11nHT40: 2422MHz—2452MHz, 5190MHz—5230MHz, 5270MHz—5310MHz, 5510MHz—5670MHz; 5755MHz—5795MHz
 Bluetooth: 2402-2480MHz

Modulation Technology : IEEE 802.11b: DSSS(CCK, DQPSK, DBPSK)
 IEEE 802.11a/g: OFDM(64QAM, 16QAM, QPSK, BPSK)
 IEEE 802.11ac (VHT20), (VHT40), (VHT80): OFDM (16QAM, 64QAM, 256QAM, QPSK, BPSK)
 IEEE 802.11n HT20, HT40: OFDM (64QAM, 16QAM, QPSK, BPSK)
 Bluetooth V3.0+EDR: GFSK, $\pi/4$ QPSK, 8DPSK
 Bluetooth V4.0: GFSK

Antenna Assembly Gain : Antenna A:
 IFA Antenna,
 2.4GHz: 2.89dBi(max)
 5GHz: 3.96dBi(max)
 Antenna B:
 IFA Antenna,
 2.4GHz: 2.7dBi(max)
 5GHz: 4.59dBi(max)

Applicant : Razer Inc.
2035 Corte Del Nogal, Suite 101, Carlsbad CA 92011, USA

Manufacturer : Razer Inc.
2035 Corte Del Nogal, Suite 101, Carlsbad CA 92011, USA

Factory : BYD Precision Manufacture Co.,Ltd
No.3001, Baohe Road, Baolong Industrial, Longgang, Shenzhen, P.R.,
China

Power Adapter #1 : Manufacturer: Razer Systems Pte Ltd. M/N: RC30-0083
DC Cable: Unshielded, Detachable 2m

Power Adapter #2 : Manufacturer: Razer Inc. M/N: RC30-0099
DC Cable: Unshielded, Detachable 2m

Note: According to exploratory test, power adapter #2 has the worse case emission, so choose it for all test.

Date of Test : Feb.20~Mar.07, 2014

Date of Receipt : Feb.18, 2014

Sample Type : Prototype production

2.2. Test Information

A special test software was used to control EUT work in Continuous TX mode(100% duty cycle), and select test channel, wireless mode and data rate.

This device have two antennas , and those two antennas can not transmit simultaneously in 11a, 11b/g mode. According to exploratory test. Antenna A has Max output and radiated emission, so choose Antenna A for radiated emission and Band edge test in 11a/b/g /ac mode, test with two antenna transmit simultaneously in 11n mode .

2.3. Tested Supporting System Details

No.	Description	ACS No.	Manufacturer	Model	Serial Number	Approved type
1.	Headphone	ACS-EMC-EP01	OVANN	OV880V	N/A	<input type="checkbox"/> FCC ID <input type="checkbox"/> BSMI ID
		Cable: Shielded, Undetachabled, 4.0m				
2.	3D Monitor	--	SamSung	SA950	--	<input checked="" type="checkbox"/> CCC
		Adapter: M/N:AD-6314N DC Cable:Unshielded Undetachable 1.5m AC Cable: Unshielded Detachable 1.8m				
3.	HDD #1	ACS-EMC-HDD02	Terasys	F12-UF	A0100215-539 0018	<input checked="" type="checkbox"/> FCC DoC <input checked="" type="checkbox"/> BSMI ID: 4912A022
		Data Cable: Shielded, Detachabled, 1.8m				
4.	HDD #2	ACS-EMC-HDD03	Terasys	F12-UF	A0100215-539 0030	<input checked="" type="checkbox"/> FCC DoC <input checked="" type="checkbox"/> BSMI ID: 4912A022
		Data Cable: Shielded, Detachabled, 1.8m				
5.	HDD #3	ACS-EMC-HDD04	Terasys	F12-UF	A0100215-539 0002	<input checked="" type="checkbox"/> FCC DoC <input checked="" type="checkbox"/> BSMI ID: 4912A022
		Data Cable: Shielded, Detachabled, 1.8m				

2.4. Block Diagram of Test Setup

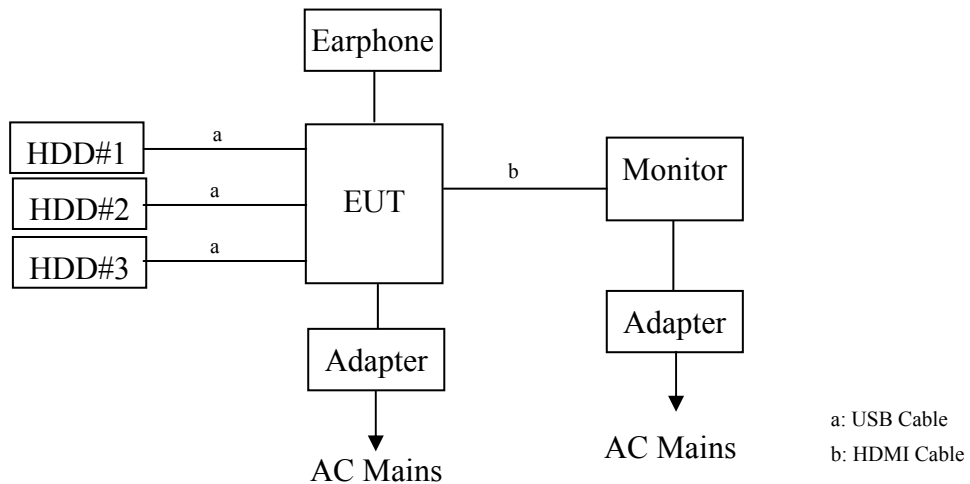

(EUT: Notebook)

2.5. Test Facility

Site Description

Name of Firm : Audix Technology (Shenzhen) Co., Ltd.
No. 6, Ke Feng Rd., 52 Block, Shenzhen
Science & Industrial Park, Nantou,
Shenzhen, Guangdong, China

3m Anechoic Chamber : Certificated by FCC, USA
Registration Number: 90454
Valid Date: Feb.22, 2015

3m & 10m Anechoic Chamber : Certificated by FCC, USA
Registration Number: 794232
Valid Date: Oct.31, 2015

EMC Lab. : Certificated by Industry Canada
Registration Number: IC 5183A-1
Valid Date: Jun.13, 2014

: Certificated by DAkkS, Germany
Registration No: D-PL-12151-01-00
Valid Date: Dec.15, 2016

Accredited by NVLAP, USA
NVLAP Code: 200372-0
Valid Date: Mar.31, 2014

2.6. Measurement Uncertainty (95% confidence levels, k=2)

Test Item	Uncertainty
Uncertainty for Conduction emission test in No. 1 Conduction	3.1 dB(150KHz to 30MHz)
Uncertainty for Radiation Emission test in 3m chamber	3.22 dB(30~200MHz, Polarize: H)
	3.23 dB(30~200MHz, Polarize: V)
	3.49 dB(200M~1GHz, Polarize: H)
	3.39 dB(200M~1GHz, Polarize: V)
Uncertainty for Radiation Emission test in 3m chamber (1GHz-18GHz)	4.97 dB(1~6GHz, Distance: 3m)
	4.99 dB(6~18GHz, Distance: 3m)
Uncertainty for Radiated Spurious Emission test in RF chamber	3.57 dB
Uncertainty for Conduction Spurious emission test	2.00 dB
Uncertainty for Output power test	0.73 dB
Uncertainty for Power density test	2.00 dB
Uncertainty for Frequency range test	7×10^{-8}
Uncertainty for Bandwidth test	83 kHz
Uncertainty for DC power test	0.038 %
Uncertainty for test site temperature and humidity	0.6°C
	3%

3. POWER LINE CONDUCTED EMISSION TEST

3.1. Test Equipments

Item	Equipment	Manufacturer	Model No.	Serial No.	Last Cal.	Cal. Interval
1.	1# Shielding Room	AUDIX	N/A	N/A	Apr.18,13	1 Year
2.	Test Receiver	Rohde & Schwarz	ESHS10	838693/001	Oct.31, 13	1 Year
3.	L.I.S.N.#1	Rohde & Schwarz	ESH2-Z5	834066/011	Oct.31, 13	1 Year
4.	L.I.S.N.#3	Kyoritsu	KNW-242C	8-1920-1	May.08, 13	1 Year
5.	Terminator	Hubersuhner	50Ω	No. 1	May.08, 13	1 Year
6.	Terminator	Hubersuhner	50Ω	No. 2	May.08, 13	1 Year
7.	RF Cable	Fujikura	3D-2W	No.1	May.08, 13	1 Year
8.	Coaxial Switch	Anritsu	MP59B	M50564	May.08, 13	1 Year
9.	Pulse Limiter		ESH3-Z2	100341	May.08, 13	1 Year
10.	MPEG2 Measurement Generator	Rohde & Schwarz	DVG	100319	Dec.11, 13	1 Year
11.	TV Transmitter	Rohde & Schwarz	SFQ	100521	May.08, 13	1 Year
12.	Signal Generator	HP	8648A	3625U00573	May.08, 13	1 Year
13.	Pattern Generator	Philips	PM5418	LO625020	May.08, 13	1 Year

3.2. Block Diagram of Test Setup

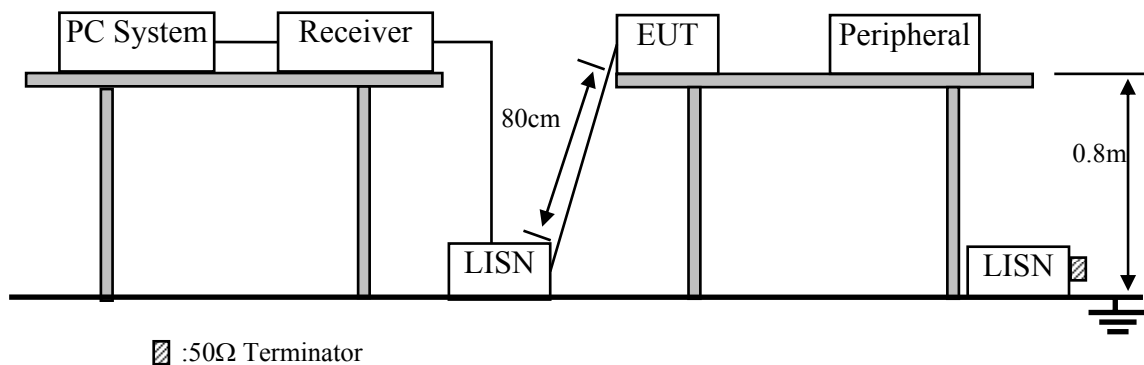

3.3. Power Line Conducted Emission Test Limits

Frequency	Maximum RF Line Voltage	
	Quasi-Peak Level dB(μV)	Average Level dB(μV)
150kHz ~ 500kHz	66 ~ 56*	56 ~ 46*
500kHz ~ 5MHz	56	46
5MHz ~ 30MHz	60	50

- Notes: 1. * Decreasing linearly with logarithm of frequency.
 2. The lower limit shall apply at the transition frequencies.

3.4. Configuration of EUT on Test

The following equipment are installed on Power Line Conducted Emission Test to meet the commission requirement and operating regulations in a manner which tends to maximize its emission characteristics in a normal application.

3.4.1. Notebook (EUT)

Model Number : RZ09-0116

Serial Number : N/A

3.4.2. Support Equipment: As Tested Supporting System Details, in Section 2.2.

3.5. Operating Condition of EUT

3.5.1. Setup the EUT and simulator as shown as Section 3.2.

3.5.2. Turned on the power of all equipment.

3.5.3. PC run test software to control EUT work in Tx mode.

3.6. Test Procedure

The EUT was placed on a non-metallic table, 80cm above the ground plane. The EUT Power connected to the power mains through a line impedance stabilization network (L.I.S.N. 1#). This provides a 50 ohm coupling impedance for the EUT (Please refer the block diagram of the test setup and photographs). The AC line are checked to find out the maximum conducted emission. In order to find the maximum emission levels, the relative positions of equipment and all of the interface cables shall be changed according to ANSI C63.10: 2009 on Conducted Emission Test.

The bandwidth of test receiver (R & S ESHS10) is set at 9kHz.

The frequency range from 150kHz to 30MHz is checked.

3.7. Power Line Conducted Emission Test Results

PASS. (All emissions not reported below are too low against the prescribed limits.)

5150-5250MHz:

Data: 16

File: D:\DATA\2014 Report Data\B\BYD\ACS14Q0218.EM6 (37)

Date: 2014-03-07

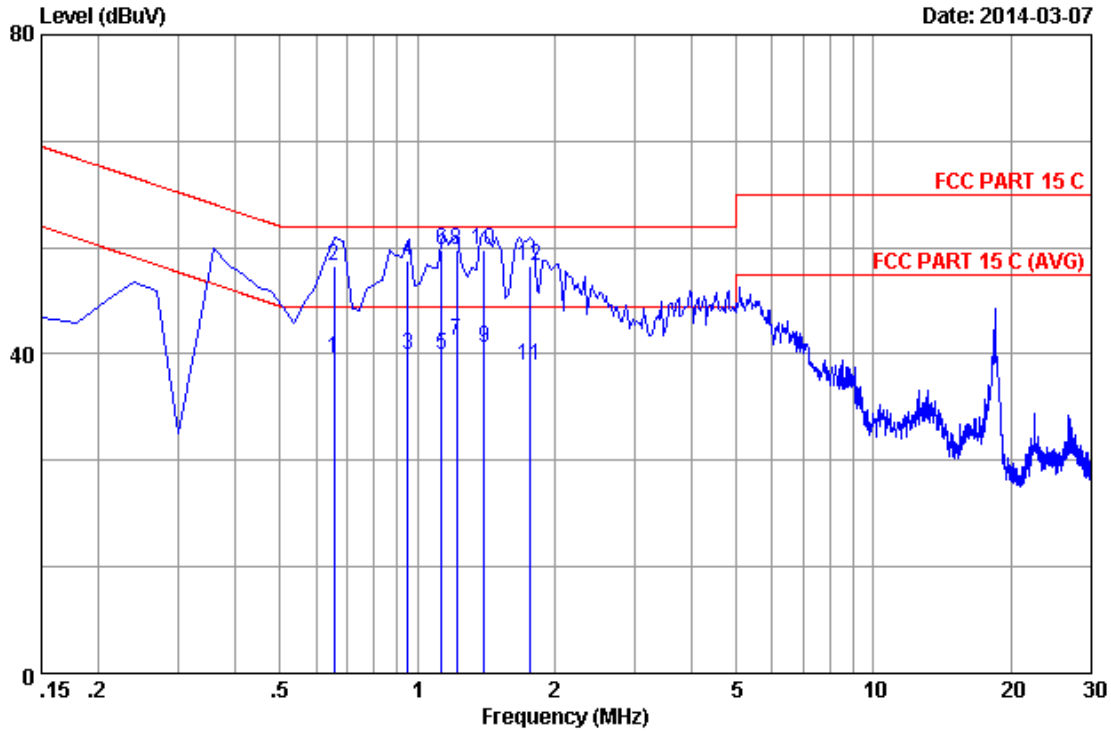

Site no :1#conduction Data No :16
 Dis./Ant. :2014 ESH2-Z5 LINE
 Limit :FCC PART 15 C
 Env./Ins. :25.3*C/50% Engineer :Kevin_Hu
 EUT :Notebook
 Power Rating :DC 19V From Adapter Input AC 120V/60Hz
 Test Mode :Tx Mode(WIFI 5.1G)
 M/N:RZ09-0116

No	Freq (MHz)	LISN Factor (dB)	Cable Loss (dB)	Reading (dBuV)	Emission Level (dBuV)	Limits (dBuV)	Margin (dB)	Remark
1	0.65700	0.16	9.89	29.40	39.45	46.00	6.55	Average
2	0.65700	0.16	9.89	40.90	50.95	56.00	5.05	QP
3	0.95500	0.17	9.89	29.80	39.86	46.00	6.14	Average
4	0.95500	0.17	9.89	41.60	51.66	56.00	4.34	QP
5	1.130	0.17	9.89	29.81	39.87	46.00	6.13	Average
6	1.130	0.17	9.89	42.91	52.97	56.00	3.03	QP
7	1.220	0.18	9.90	31.49	41.57	46.00	4.43	Average
8	1.220	0.18	9.90	42.89	52.97	56.00	3.03	QP
9	1.403	0.18	9.90	30.70	40.78	46.00	5.22	Average
10	1.403	0.18	9.90	43.00	53.08	56.00	2.92	QP
11	1.760	0.19	9.91	28.39	38.49	46.00	7.51	Average
12	1.760	0.19	9.91	40.89	50.99	56.00	5.01	QP

Remarks: 1.Emission Level=LISN Factor+Cable Loss(Include Pulse limiter)+Reading.
 2.If the average limit is met when using a quasi-peak detector.
 the EUT shall be deemed to meet both limits and measurement
 with average detector is unnecessary.

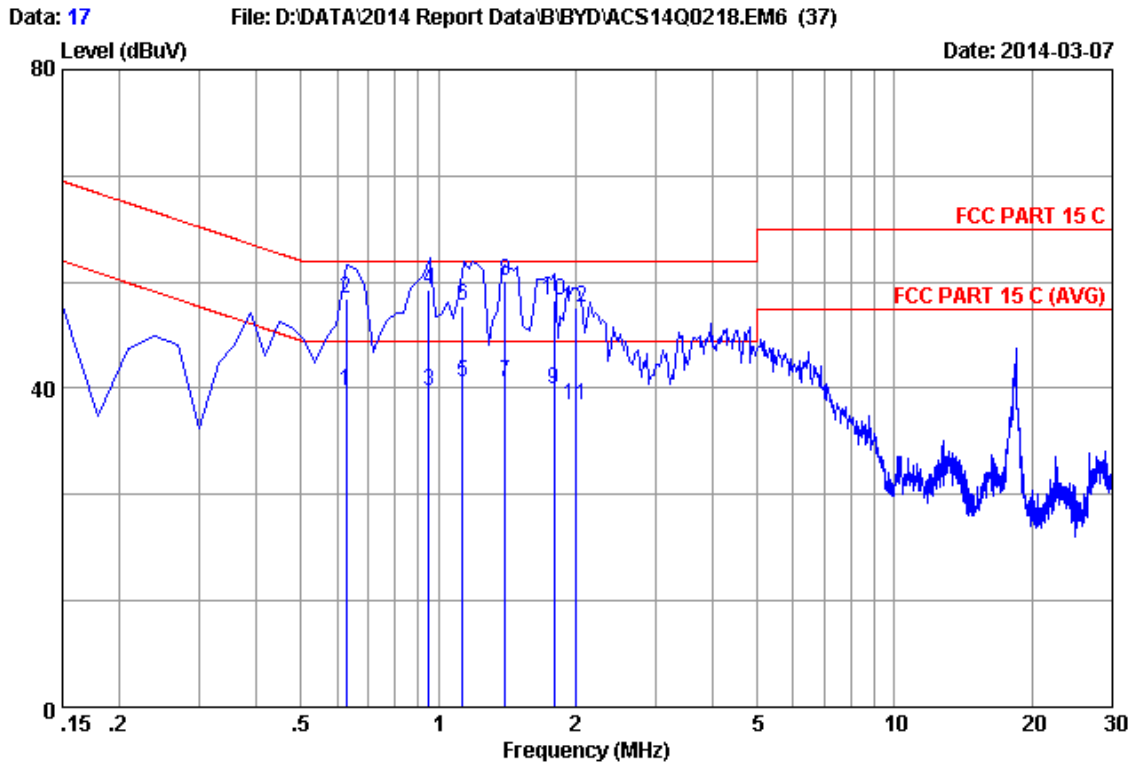

Site no :1#conduction Data No :17
 Dis./Ant. :2014 ESH2-Z5 NEUTRAL
 Limit :FCC PART 15 C
 Env./Ins. :25.3*C/50% Engineer :Kevin_Hu
 EUT :Notebook
 Power Rating :DC 19V From Adapter Input AC 120V/60Hz
 Test Mode :Tx Mode(WIFI 5.1G)
 M/N:RZ09-0116

No	Freq (MHz)	LISN Factor (dB)	Cable Loss (dB)	Reading (dBuV)	Emission Level (dBuV)	Limits (dBuV)	Margin (dB)	Remark
1	0.62700	0.15	9.89	29.70	39.74	46.00	6.26	Average
2	0.62700	0.15	9.89	41.30	51.34	56.00	4.66	QP
3	0.95500	0.17	9.89	29.70	39.76	46.00	6.24	Average
4	0.95500	0.17	9.89	42.40	52.46	56.00	3.54	QP
5	1.130	0.18	9.89	30.80	40.87	46.00	5.13	Average
6	1.130	0.18	9.89	40.30	50.37	56.00	5.63	QP
7	1.403	0.18	9.90	30.70	40.78	46.00	5.22	Average
8	1.403	0.18	9.90	43.50	53.58	56.00	2.42	QP
9	1.790	0.20	9.91	29.69	39.80	46.00	6.20	Average
10	1.790	0.20	9.91	40.89	51.00	56.00	5.00	QP
11	2.000	0.20	9.91	27.80	37.91	46.00	8.09	Average
12	2.000	0.20	9.91	40.10	50.21	56.00	5.79	QP

Remarks: 1.Emission Level=LISN Factor+Cable Loss(Include Pulse limiter)+Reading.
 2.If the average limit is met when using a quasi-peak detector, the EUT shall be deemed to meet both limits and measurement with average detector is unnecessary.

5250-5350MHz:

Data: 19

File: D:\DATA\2014 Report Data\B\BYD\ACS14Q0218.EM6 (37)

Date: 2014-03-07

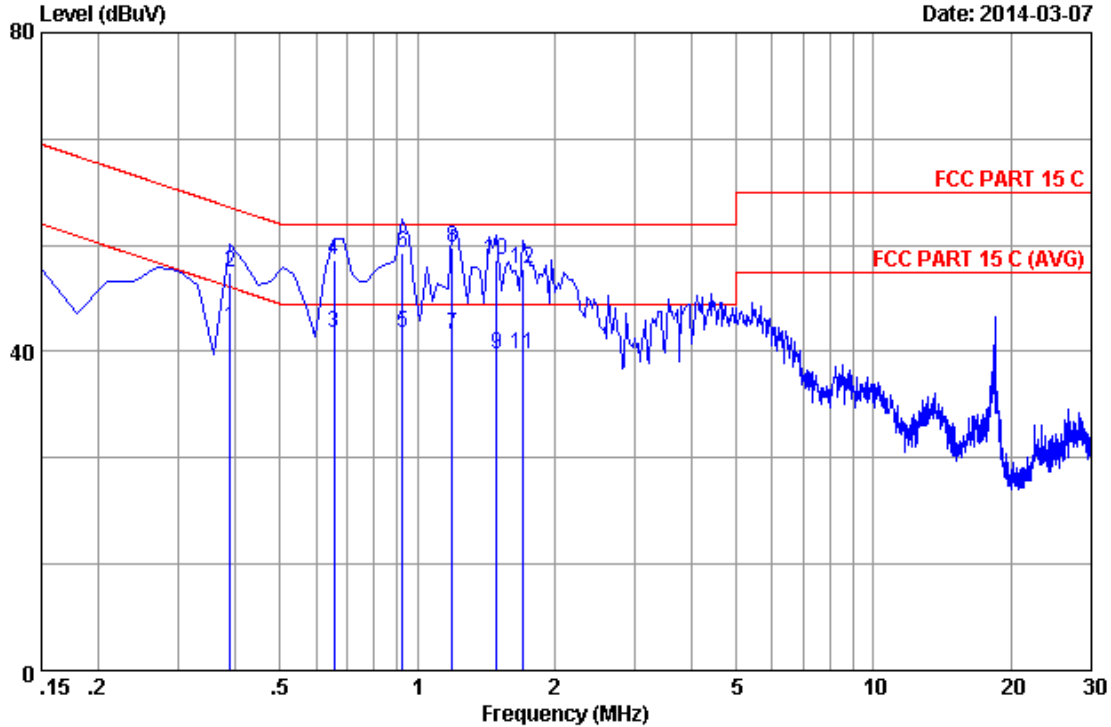

Site no :1#conduction Data No :19
 Dis./Ant. :2014 ESH2-Z5 LINE
 Limit :FCC PART 15 C
 Env./Ins. :25.3*C/50% Engineer :Kevin_Hu
 EUT :Notebook
 Power Rating :DC 19V From Adapter Input AC 120V/60Hz
 Test Mode :Tx Mode(WIFI 5.2G)
 M/N:RZ09-0116

No	Freq (MHz)	LISN Factor (dB)	Cable Loss (dB)	Reading (dBuV)	Emission Level (dBuV)	Limits (dBuV)	Margin (dB)	Remark
1	0.38800	0.14	9.88	32.90	42.92	48.11	5.19	Average
2	0.38800	0.14	9.88	39.80	49.82	58.11	8.29	QP
3	0.65700	0.16	9.89	32.40	42.45	46.00	3.55	Average
4	0.65700	0.16	9.89	41.50	51.55	56.00	4.45	QP
5	0.92600	0.17	9.89	32.30	42.36	46.00	3.64	Average
6	0.92600	0.17	9.89	42.40	52.46	56.00	3.54	QP
7	1.190	0.18	9.89	32.10	42.17	46.00	3.83	Average
8	1.190	0.18	9.89	42.90	52.97	56.00	3.03	QP
9	1.490	0.18	9.90	29.60	39.68	46.00	6.32	Average
10	1.490	0.18	9.90	41.50	51.58	56.00	4.42	QP
11	1.700	0.19	9.90	29.60	39.69	46.00	6.31	Average
12	1.700	0.19	9.90	40.30	50.39	56.00	5.61	QP

Remarks: 1.Emission Level=LISN Factor+Cable Loss(Include Pulse limiter)+Reading.
 2.If the average limit is met when using a quasi-peak detector, the EUT shall be deemed to meet both limits and measurement with average detector is unnecessary.

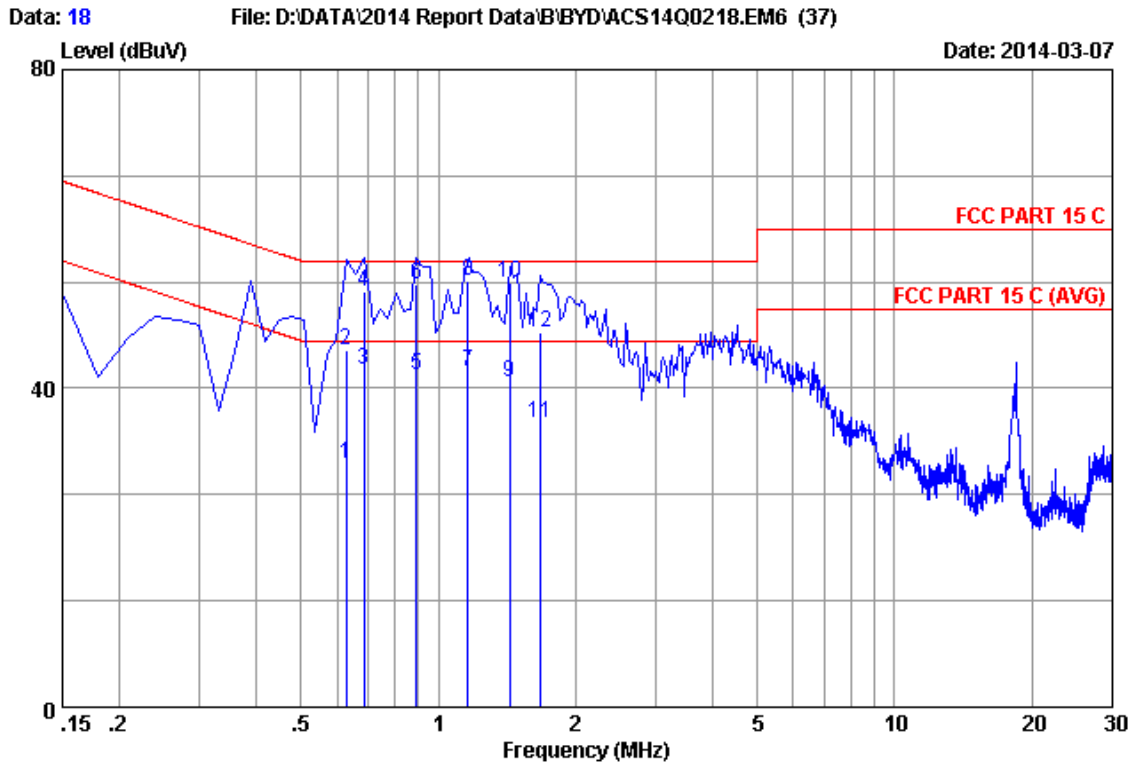

Site no :1#conduction Data No :18
 Dis./Ant. :2014 ESH2-Z5 NEUTRAL
 Limit :FCC PART 15 C
 Env./Ins. :25.3*C/50% Engineer :Kevin_Hu
 EUT :Notebook
 Power Rating :DC 19V From Adapter Input AC 120V/60Hz
 Test Mode :Tx Mode(WIFI 5.2G)
 M/N:RZ09-0116

No	Freq (MHz)	LISN Factor (dB)	Cable Loss (dB)	Reading (dBuV)	Emission Level (dBuV)	Limits (dBuV)	Margin (dB)	Remark
1	0.62700	0.15	9.89	20.58	30.62	46.00	15.38	Average
2	0.62700	0.15	9.89	34.80	44.84	56.00	11.16	QP
3	0.68700	0.15	9.89	32.30	42.34	46.00	3.66	Average
4	0.68700	0.15	9.89	42.10	52.14	56.00	3.86	QP
5	0.89600	0.16	9.89	31.70	41.75	46.00	4.25	Average
6	0.89600	0.16	9.89	43.00	53.05	56.00	2.95	QP
7	1.160	0.18	9.89	32.10	42.17	46.00	3.83	Average
8	1.160	0.18	9.89	43.50	53.57	56.00	2.43	QP
9	1.433	0.19	9.90	30.70	40.79	46.00	5.21	Average
10	1.433	0.19	9.90	43.10	53.19	56.00	2.81	QP
11	1.670	0.19	9.90	25.61	35.70	46.00	10.30	Average
12	1.670	0.19	9.90	36.91	47.00	56.00	9.00	QP

Remarks: 1.Emission Level=LISN Factor+Cable Loss(Include Pulse limiter)+Reading.
 2.If the average limit is met when using a quasi-peak detector, the EUT shall be deemed to meet both limits and measurement with average detector is unnecessary.

5470-5725MHz:

Data: 21 File: D:\DATA\2014 Report Data\B\BYD\ACS14Q0218.EM6 (37) Date: 2014-03-07

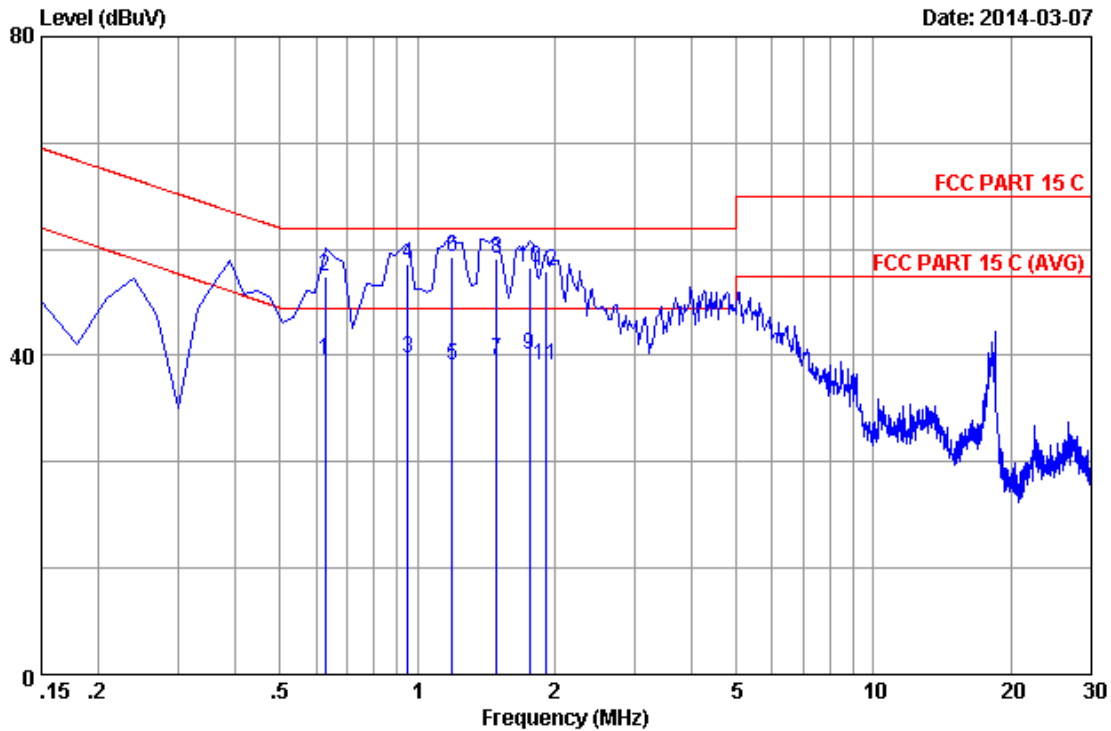

Site no :1#conduction Data No :21
 Dis./Ant. :2014 ESH2-Z5 LINE
 Limit :FCC PART 15 C
 Env./Ins. :25.3*C/50% Engineer :Kevin_Hu
 EUT :Notebook
 Power Rating :DC 19V From Adapter Input AC 120V/60Hz
 Test Mode :Tx Mode(WIFI 5.4G)
 M/N:RZ09-0116

No	Freq (MHz)	LISN Factor (dB)	Cable Loss (dB)	Reading (dBuV)	Emission Level (dBuV)	Limits (dBuV)	Margin (dB)	Remark
1	0.62700	0.16	9.89	29.39	39.44	46.00	6.56	Average
2	0.62700	0.16	9.89	39.79	49.84	56.00	6.16	QP
3	0.95500	0.17	9.89	29.70	39.76	46.00	6.24	Average
4	0.95500	0.17	9.89	41.50	51.56	56.00	4.44	QP
5	1.190	0.18	9.89	28.60	38.67	46.00	7.33	Average
6	1.190	0.18	9.89	42.40	52.47	56.00	3.53	QP
7	1.490	0.18	9.90	29.30	39.38	46.00	6.62	Average
8	1.490	0.18	9.90	42.10	52.18	56.00	3.82	QP
9	1.760	0.19	9.91	30.09	40.19	46.00	5.81	Average
10	1.760	0.19	9.91	40.99	51.09	56.00	4.91	QP
11	1.910	0.19	9.91	28.60	38.70	46.00	7.30	Average
12	1.910	0.19	9.91	40.60	50.70	56.00	5.30	QP

Remarks: 1.Emission Level=LISN Factor+Cable Loss(Include Pulse limiter)+Reading.
 2.If the average limit is met when using a quasi-peak detector, the EUT shall be deemed to meet both limits and measurement with average detector is unnecessary.

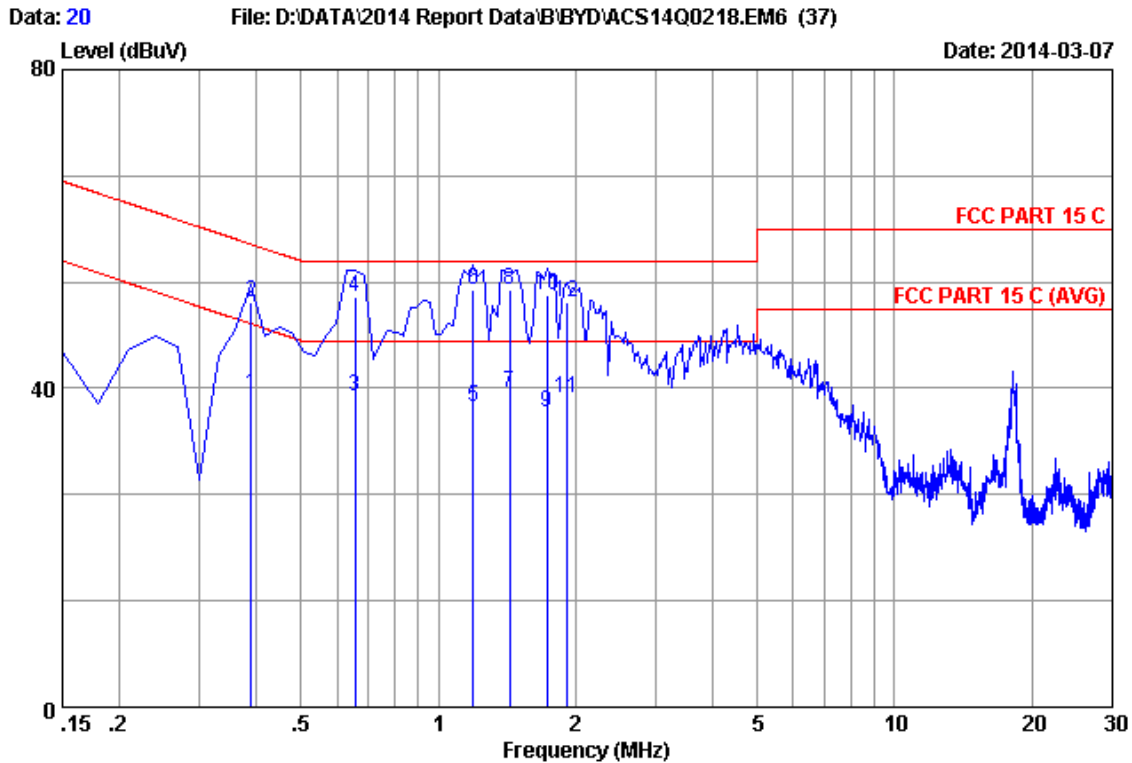

Site no :1#conduction Data No :20
 Dis./Ant. :2014 ESH2-Z5 NEUTRAL
 Limit :FCC PART 15 C
 Env./Ins. :25.3*C/50% Engineer :Kevin_Hu
 EUT :Notebook
 Power Rating :DC 19V From Adapter Input AC 120V/60Hz
 Test Mode :Tx Mode(WIFI 5.4G)
 M/N:RZ09-0116

No	Freq (MHz)	LISN Factor (dB)	Cable Loss (dB)	Reading (dBUV)	Emission Level (dBUV)	Limits (dBUV)	Margin (dB)	Remark
1	0.38800	0.14	9.88	29.10	39.12	48.11	8.99	Average
2	0.38800	0.14	9.88	40.70	50.72	58.11	7.39	QP
3	0.65700	0.15	9.89	28.90	38.94	46.00	7.06	Average
4	0.65700	0.15	9.89	41.40	51.44	56.00	4.56	QP
5	1.190	0.18	9.89	27.60	37.67	46.00	8.33	Average
6	1.190	0.18	9.89	42.20	52.27	56.00	3.73	QP
7	1.430	0.19	9.90	29.40	39.49	46.00	6.51	Average
8	1.430	0.19	9.90	42.30	52.39	56.00	3.61	QP
9	1.730	0.19	9.90	26.91	37.00	46.00	9.00	Average
10	1.730	0.19	9.90	41.61	51.70	56.00	4.30	QP
11	1.910	0.20	9.91	28.70	38.81	46.00	7.19	Average
12	1.910	0.20	9.91	40.60	50.71	56.00	5.29	QP

Remarks: 1.Emission Level=LISN Factor+Cable Loss(Include Pulse limiter)+Reading.
 2.If the average limit is met when using a quasi-peak detector, the EUT shall be deemed to meet both limits and measurement with average detector is unnecessary.

4. RADIATED EMISSION TEST

4.1. Test Equipment

4.1.1. For frequency range 30MHz~1000MHz (At Anechoic Chamber)

Item	Equipment	Manufacturer	Model No.	Serial No.	Last Cal.	Cal. Interval
1	3#Chamber	AUDIX	N/A	N/A	Nov.24, 13	1 Year
2	EMI Spectrum	Agilent	E4407B	MY41440292	May.08, 13	1 Year
3	Test Receiver	Rohde & Schwarz	ESVS10	834468/011	May.08, 13	1 Year
4	Amplifier	HP	8447D	2648A04738	May.08, 13	1 Year
5	Bilog Antenna	TESEQ	CBL6112D	35375	May.30, 13	1 Year
6	RF Cable	MIYAZAKI	CFD400-NL	3# Chamber No.1	May.08, 13	1 Year
7	Coaxial Switch	Anritsu	MP59B	M74389	May.08, 13	1 Year
8	MPEG2 Measurement Generator	Rohde & Schwarz	DVG	100319	Dec.11, 13	1 Year
9	TV Transmitter	Rohde & Schwarz	SFQ	100521	May.08, 13	1 Year
10	Signal Generator	HP	8648A	3625U00573	May.08, 13	1 Year
11	Pattern Generator	Philiphs	PM5418	LO625020	May.08, 13	1 Year

4.1.2. For frequency range 1GHz~40GHz (At Anechoic Chamber)

Item	Equipment	Manufacturer	Model No.	Serial No.	Last Cal.	Cal. Interval
1	3#Chamber	AUDIX	N/A	N/A	Nov.24, 13	1 Year
2	Spectrum Analyzer	Agilent	E4407B	MY41440292	May.08, 13	1 Year
3	Horn Antenna	EMCO	3115	9607-4877	Aug.27, 13	1 Year
4	Amplifier	Agilent	8449B	3008A00863	May.08, 13	1 Year
5	RF Cable	Hubersuhner	SUCOFLEX106	77977/6	May.08, 13	1 Year
6	RF Cable	Hubersuhner	SUCOFLEX106	28616/2	May.08, 13	1 Year
7	MPEG2 Measurement Generator	ROHDE&SC HWARZ	DVG	100319	Dec.11, 13	1 Year
8	TV Transmitter	ROHDE&SC HWARZ	SFQ	100521	May.08, 13	1 Year
9	Pattern Generator	Philiphs	PM5418	LO625020	May.08, 13	1 Year

4.2. Block Diagram of Test Setup

For frequency range 30MHz-1000MHz

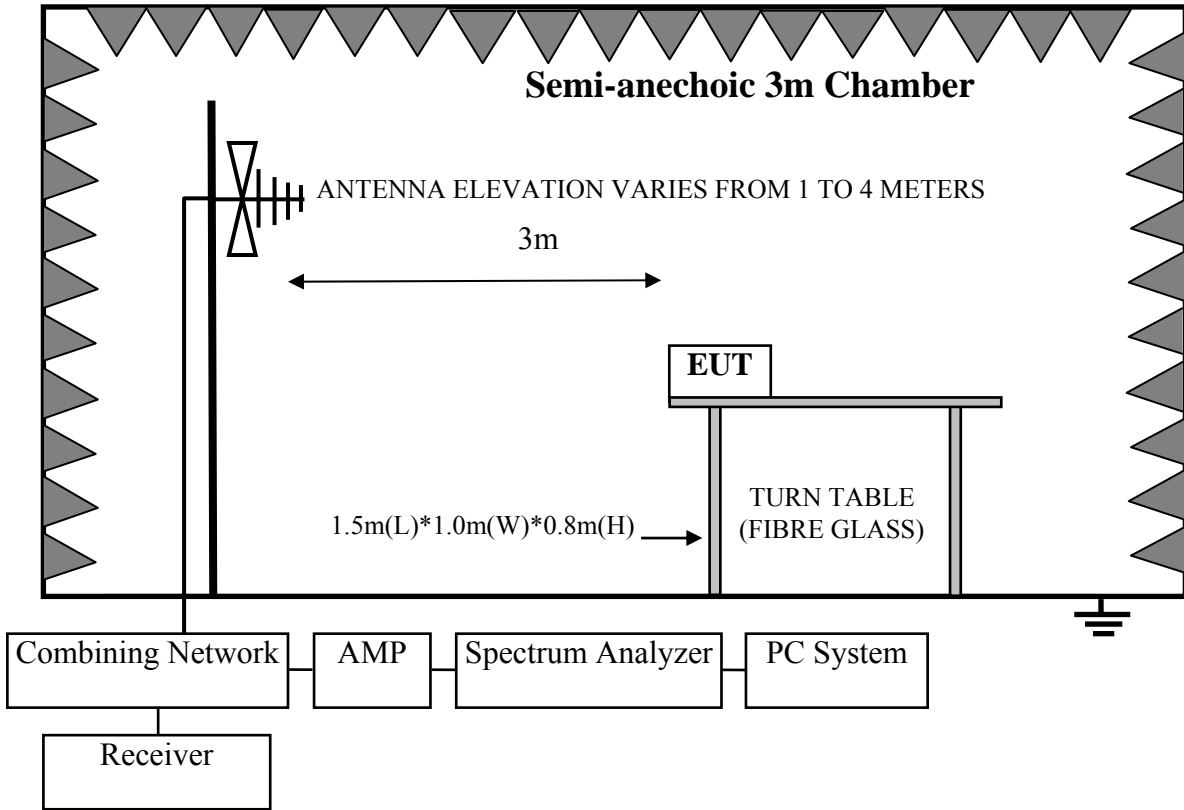

For frequency range 1GHz-40GHz

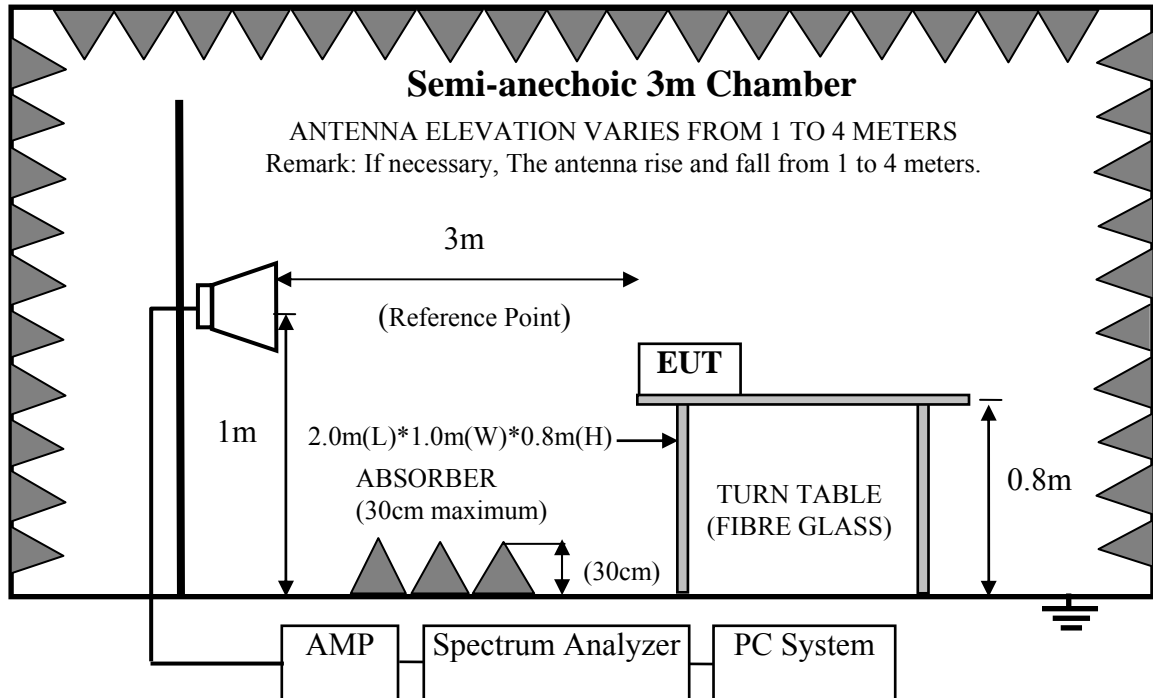

4.3. Radiated Emission Limit

For transmitters operating in the 5.15-5.25 GHz; 5.25-5.35GHz; 5.47-5.725GHz band: all emissions outside of those band shall not exceed an EIRP of -27 dBm/MHz.

Unwanted emissions below 1 GHz and those emissions appearing within 15.205 restricted frequency bands must comply with the general field strength limits set forth in Section 15.209

4.3.1. 15.209 limits

FREQUENCY MHz	DISTANCE Meters	FIELD STRENGTHS LIMIT	
		μV/m	dB(μV)/m
30 ~ 88	3	100	40.0
88 ~ 216	3	150	43.5
216 ~ 960	3	200	46.0
960 ~ 1000	3	500	54.0
Above 1000	3	74.0 dB(μV)/m (Peak) 54.0 dB(μV)/m (Average)	

Remark : (1) Emission level dBμV = 20 log Emission level μV/m

(2) The smaller limit shall apply at the cross point between two frequency bands.

(3) Distance is the distance in meters between the measuring instrument, antenna and the closest point of any part of the device or system.

4.3.2. 15.205 Restricted bands of operation

MHz	MHz	MHz	GHz
0.090 - 0.110	16.42 - 16.423	399.9 - 410	4.5 - 5.15
¹ 0.495 - 0.505	16.69475 - 16.69525	608 - 614	5.35 - 5.46
2.1735 - 2.1905	16.80425 - 16.80475	960 - 1240	7.25 - 7.75
4.125 - 4.128	25.5 - 25.67	1300 - 1427	8.025 - 8.5
4.17725 - 4.17775	37.5 - 38.25	1435 - 1626.5	9.0 - 9.2
4.20725 - 4.20775	73 - 74.6	1645.5 - 1646.5	9.3 - 9.5
6.215 - 6.218	74.8 - 75.2	1660 - 1710	10.6 - 12.7
6.26775 - 6.26825	108 - 121.94	1718.8 - 1722.2	13.25 - 13.4
6.31175 - 6.31225	123 - 138	2200 - 2300	14.47 - 14.5
8.291 - 8.294	149.9 - 150.05	2310 - 2390	15.35 - 16.2
8.362 - 8.366	156.52475 - 156.52525	2483.5 - 2500	17.7 - 21.4
8.37625 - 8.38675	156.7 - 156.9	2690 - 2900	22.01 - 23.12
8.41425 - 8.41475	162.0125 - 167.17	3260 - 3267	23.6 - 24.0
12.29 - 12.293	167.72 - 173.2	3332 - 3339	31.2 - 31.8
12.51975 - 12.52025	240 - 285	3345.8 - 3358	36.43 - 36.5
12.57675 - 12.57725	322 - 335.4	3600 - 4400	(²)

4.4. EUT Configuration on Test

The configurations of EUT are listed in Section 3.4.

4.5. Operating Condition of EUT

Same as Conducted Emission test that is listed in Section 3.5. except the test set up replaced by Section 4.2.

4.6. Test Procedure

EUT and its simulators are placed on a turn table, which is 0.8 meter high above ground. The turn table can rotate 360 degrees to determine the position of the maximum emission level. Power on the EUT and let it working in test mode, then test it. EUT is set 3 meters away from the receiving antenna, which is mounted on a antenna tower. The antenna can be moved up and down between 1 meter and 4 meters to find out the maximum emission level. Broadband antenna (calibrated bilog antenna) is used as receiving antenna. Both horizontal and vertical polarization of the antenna are set on test.

For emissions below 1GHz and those emissions appearing within 15.205 restricted frequency bands use below procedure:

The bandwidth of the EMI test receiver (R&S ESVS10) is set at 120kHz for frequency range from 30MHz to 1000 MHz.

The bandwidth of the Spectrum's VBW is set at 1MHz and RBW is set at 1MHz for peak emissions measurement above 1GHz and 1MHz RBW, 10Hz VBW for average emissions measure above 1GHz

For the emissions above 1GHz and not appearing within 15.205 restricted frequency bands use below procedure:

- (1).The maximum emission at 3m distance was measured and recorded with receive antenna in both vertical and horizontal by rotating the turntable and by lowering the receive antenna.
- (2).The EUT was then removed and replaced with a substitution antenna in the same position and the substitution antenna must have the same polarization with the receive antenna.
- (3). A signal which have the same frequency obtained in step 2 was fed to the substitution,the receive antenna was raised and lowered to obtain a maximum reading at the test receiver, the level of the signal generator was adjusted until the measured field strength level in step 2 was obtained, recorded the level of the signal generator.
- (4).Repeated step 4 with both antenna polarizations
- (5).The spurious emissions is equal to the power supplied by the signal generator and corrections due to the gain of the substitution antenna and the cable loss between the signal generator and the substitution antenna.
- (6).Per KDB789033 clause H 2)d).if the test distance is 3m,the $EIRP(dBm)=E(dBuV/m)-95.2$
Get the result of all unwanted emission outside the restricted band is less than the -27dBm/MHz.

4.7. Radiated Emission Test Results

PASS.

All the emissions from 30MHz to 1 GHz were comply with 15.209 limits.

No any emissions were found from 18GHz to 40GHz, So the Radiated emissions from 18GHz to 40GHz were not record.

All other emission comply with 15.407 (b)(1) requirements.

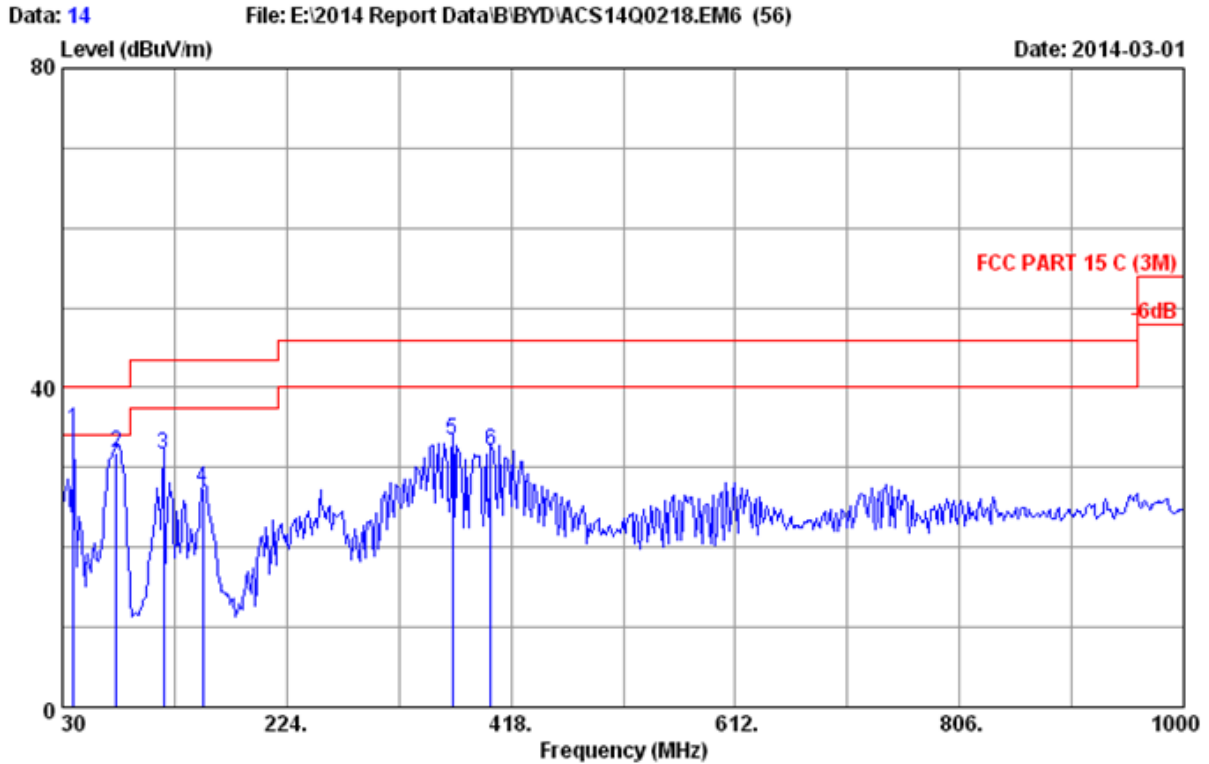

Site no. : 3m Chamber Data no. : 14
 Dis. / Ant. : 3m 2013 CBL6112D 35375 Ant. pol. : VERTICAL
 Limit : FCC PART 15 C (3M)
 Env. / Ins. : 24°C/34% Engineer : Donjon
 EUT : Notebook M/N:RZ09-0116
 Power rating : DC 19V Adapter Input AC 120V/60Hz
 Test Mode : TX Mode (WIFI5.1G)

No.	Freq. (MHz)	Ant. Factor (dB/m)	Cable Loss (dB)	Reading (dBuV)	Emission Level (dBuV/m)	Limits (dBuV/m)	Margin (dB)	Remark
1	39.700	14.26	1.00	19.39	34.65	40.00	5.35	QP
2	76.560	7.26	1.31	23.32	31.89	40.00	8.11	QP
3	117.300	12.70	1.48	17.44	31.62	43.50	11.88	QP
4	151.250	11.18	1.60	14.57	27.35	43.50	16.15	QP
5	367.560	15.70	2.37	15.26	33.33	46.00	12.67	QP
6	400.540	16.63	2.46	12.95	32.04	46.00	13.96	QP

Remarks: 1. Emission Level= Antenna Factor + Cable Loss + Reading.
 2. The emission levels that are 20dB below the official limit are not reported.

5150-5250MHz:

Frequency: 1GHz~18GHz

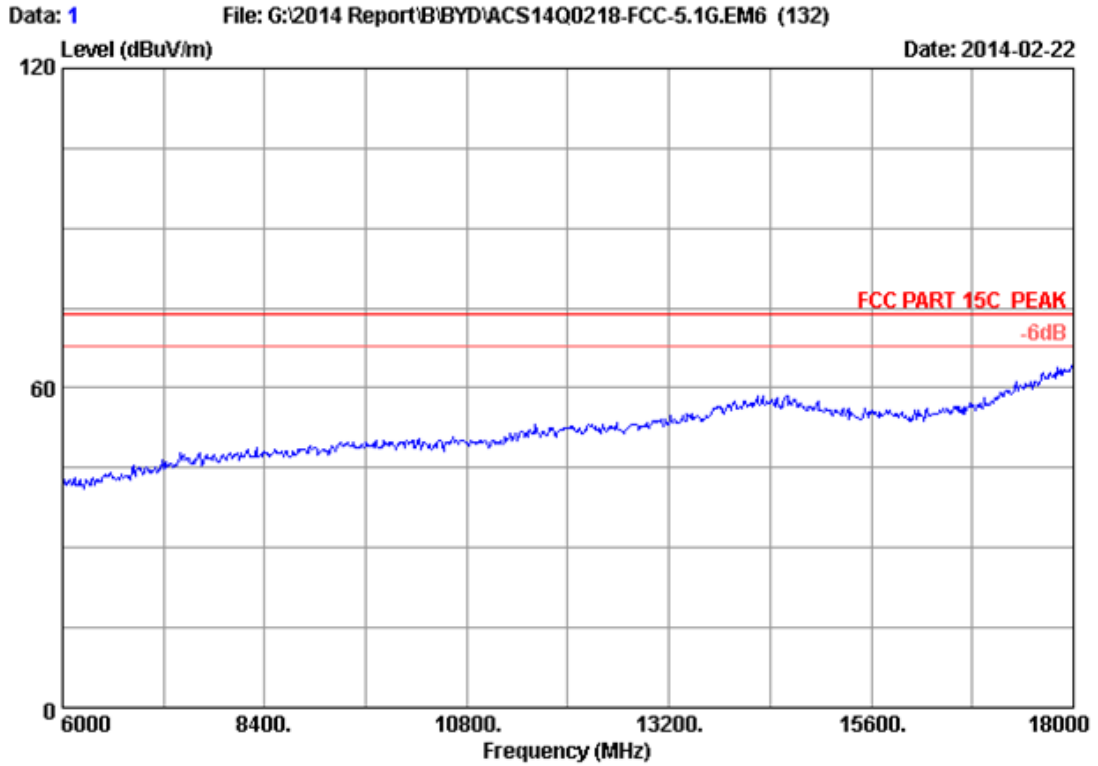

Site no. : 3m Chamber Data no. : 1
Dis. / Ant. : 3m 2013 3115 (4580) Ant. pol. : VERTICAL
Limit : FCC PART 15C PEAK
Env. / Ins. : 24°C/56% Engineer : Leo-Li
EUT : Notebook
Power Rating : DC 19V From Adapter Input AC 120V/60Hz
Test Mode : IEEE802.11a CH36 5180MHz Tx
M/N : R209-0116

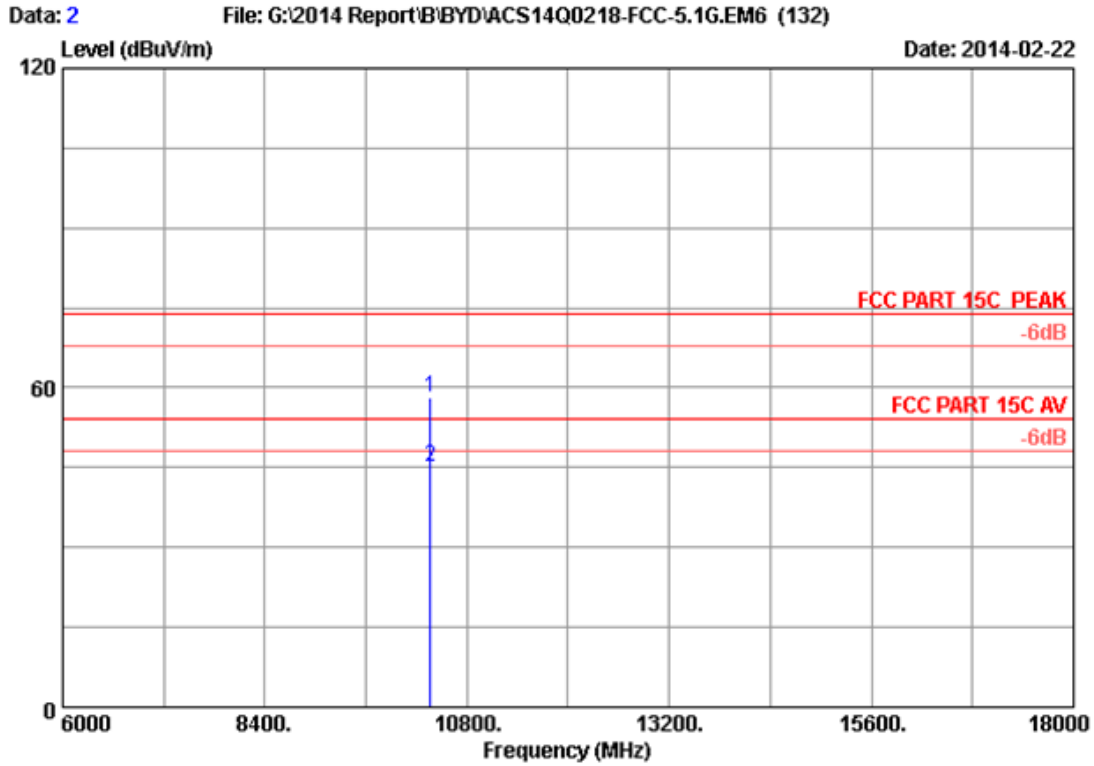

Site no. : 3m Chamber Data no. : 2
 Dis. / Ant. : 3m 2013 3115 (4580) Ant. pol. : VERTICAL
 Limit : FCC PART 15C PEAK
 Env. / Ins. : 24°C/56% Engineer : Leo-Li
 EUT : Notebook
 Power Rating : DC 19V From Adapter Input AC 120V/60Hz
 Test Mode : IEEE802.11a CH36 5180MHz Tx
 M/N : R209-0116

No.	Freq. (MHz)	Ant. Factor (dB/m)	Cable Loss (dB)	AMP factor (dB)	Reading (dBUV)	Emission Level (dBUV/m)	Limits (dBUV/m)	Margin (dB)	Remark
1	10360.000	38.14	12.64	35.45	42.74	58.07	74.00	15.93	Peak
2	10360.000	38.14	12.64	35.45	29.70	45.03	54.00	8.97	Average

Remarks: 1. EMISSION Level= Antenna Factor + Cable Loss + Reading - Amp Factor
 2. The emission levels that are 20dB below the official limit are not reported.

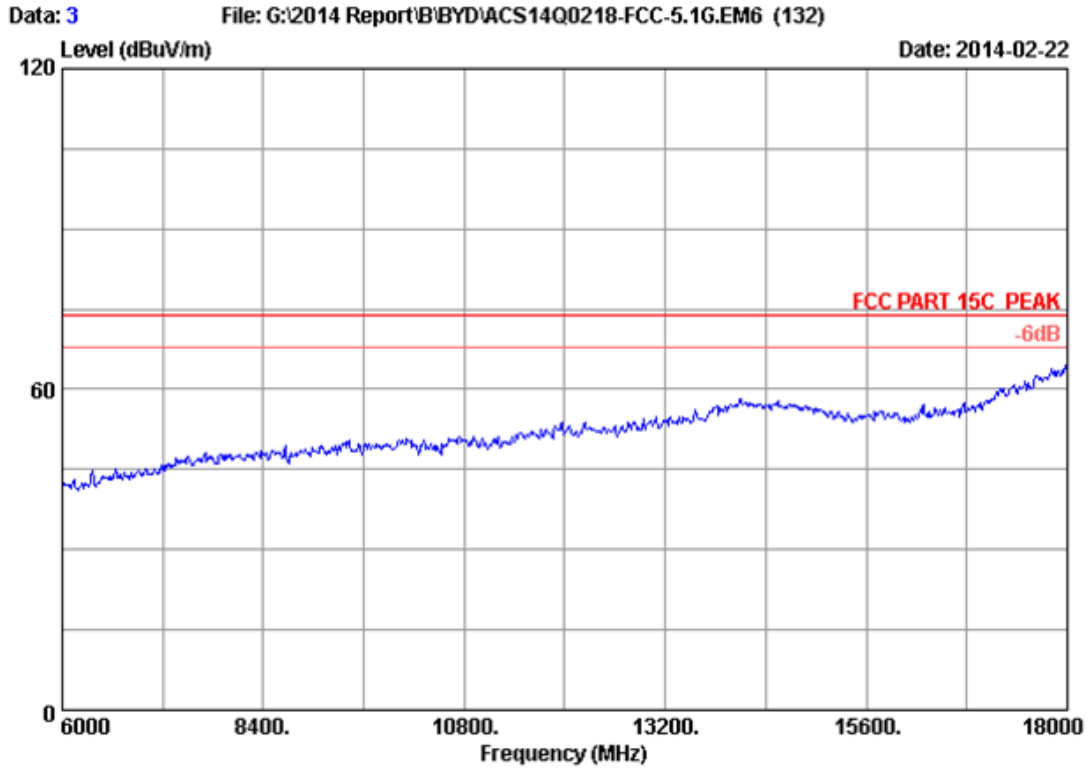

Site no. : 3m Chamber Data no. : 3
Dis. / Ant. : 3m 2013 3115 (4580) Ant. pol. : HORIZONTAL
Limit : FCC PART 15C PEAK
Env. / Ins. : 24°C/56% Engineer : Leo-Li
EUT : Notebook
Power Rating : DC 19V From Adapter Input AC 120V/60Hz
Test Mode : IEEE802.11a CH36 5180MHz Tx
M/N : R209-0116

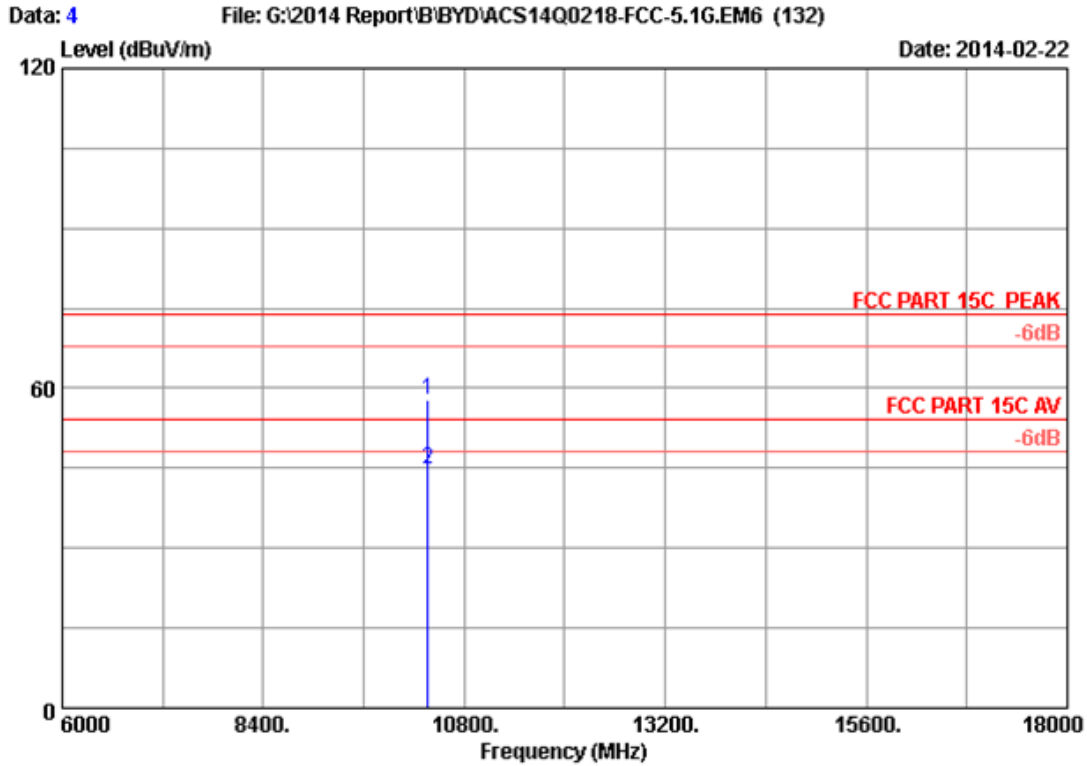

Site no. : 3m Chamber Data no. : 4
 Dis. / Ant. : 3m 2013 3115 (4580) Ant. pol. : HORIZONTAL
 Limit : FCC PART 15C PEAK
 Env. / Ins. : 24°C/56% Engineer : Leo-Li
 EUT : Notebook
 Power Rating : DC 19V From Adapter Input AC 120V/60Hz
 Test Mode : IEEE802.11a CH36 5180MHz Tx
 M/N : RZ09-0116

No.	Freq. (MHz)	Ant. Factor (dB/m)	Cable Loss (dB)	AMP factor (dB)	Reading (dBUV)	Emission Level (dBUV/m)	Limits (dBUV/m)	Margin (dB)	Remark
1	10360.000	38.14	12.64	35.45	42.59	57.92	74.00	16.08	Peak
2	10360.000	38.14	12.64	35.45	29.47	44.80	54.00	9.20	Average

Remarks: 1. Emission Level= Antenna Factor + Cable Loss + Reading - Amp Factor
 2. The emission levels that are 20dB below the official limit are not reported.

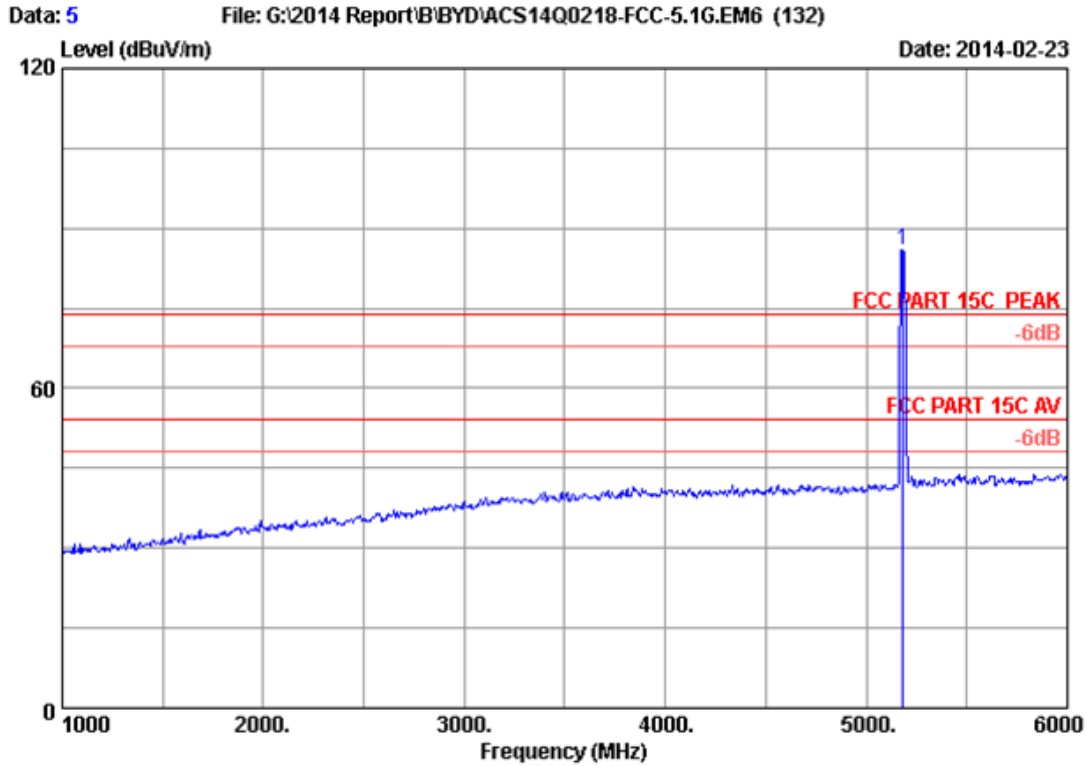

Site no. : 3m Chamber Data no. : 5
 Dis. / Ant. : 3m 2013 3115 (4580) Ant. pol. : VERTICAL
 Limit : FCC PART 15C PEAK
 Env. / Ins. : 24°C/56% Engineer : Leo-Li
 EUT : Notebook
 Power Rating : DC 19V From Adapter Input AC 120V/60Hz
 Test Mode : IEEE802.11a CH36 5180MHz Tx
 M/N : RZ09-0116

No.	Freq. (MHz)	Ant. Factor (dB/m)	Cable Loss (dB)	AMP factor (dB)	Reading (dBUV)	Emission Level (dBUV/m)	Limits (dBUV/m)	Margin (dB)	Remark
1	5180.000	33.49	8.95	35.70	79.32	86.06	74.00	-12.06	Peak

Remarks: 1. Emission Level= Antenna Factor + Cable Loss + Reading - Amp Factor
 2. The emission levels that are 20dB below the official limit are not reported.

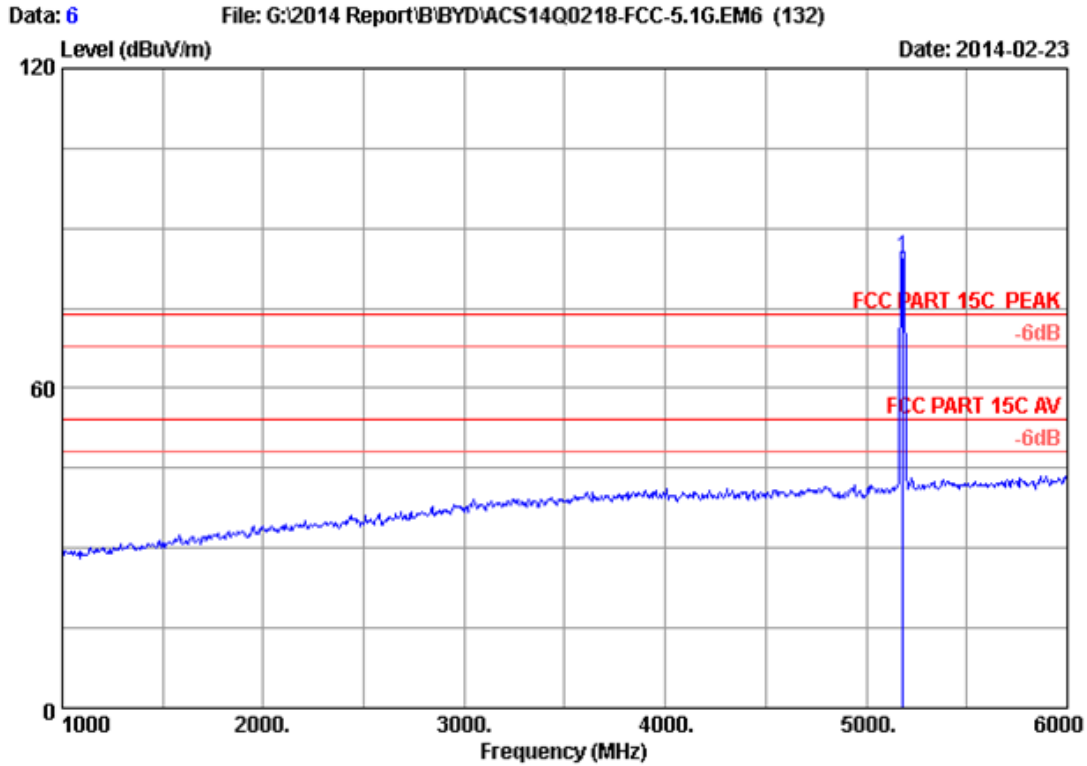

Site no. : 3m Chamber Data no. : 6
 Dis. / Ant. : 3m 2013 3115 (4580) Ant. pol. : HORIZONTAL
 Limit : FCC PART 15C PEAK
 Env. / Ins. : 24°C/56% Engineer : Leo-Li
 EUT : Notebook
 Power Rating : DC 19V From Adapter Input AC 120V/60Hz
 Test Mode : IEEE802.11a CH36 5180MHz Tx
 M/N : RZ09-0116

No.	Freq. (MHz)	Ant. Factor (dB/m)	Cable Loss (dB)	AMP factor (dB)	Reading (dBUV)	Emission Level (dBUV/m)	Limits (dBUV/m)	Margin (dB)	Remark
1	5180.000	33.49	8.95	35.70	77.89	84.63	74.00	-10.63	Peak

Remarks: 1. Emission Level= Antenna Factor + Cable Loss + Reading - Amp Factor
 2. The emission levels that are 20dB below the official limit are not reported.

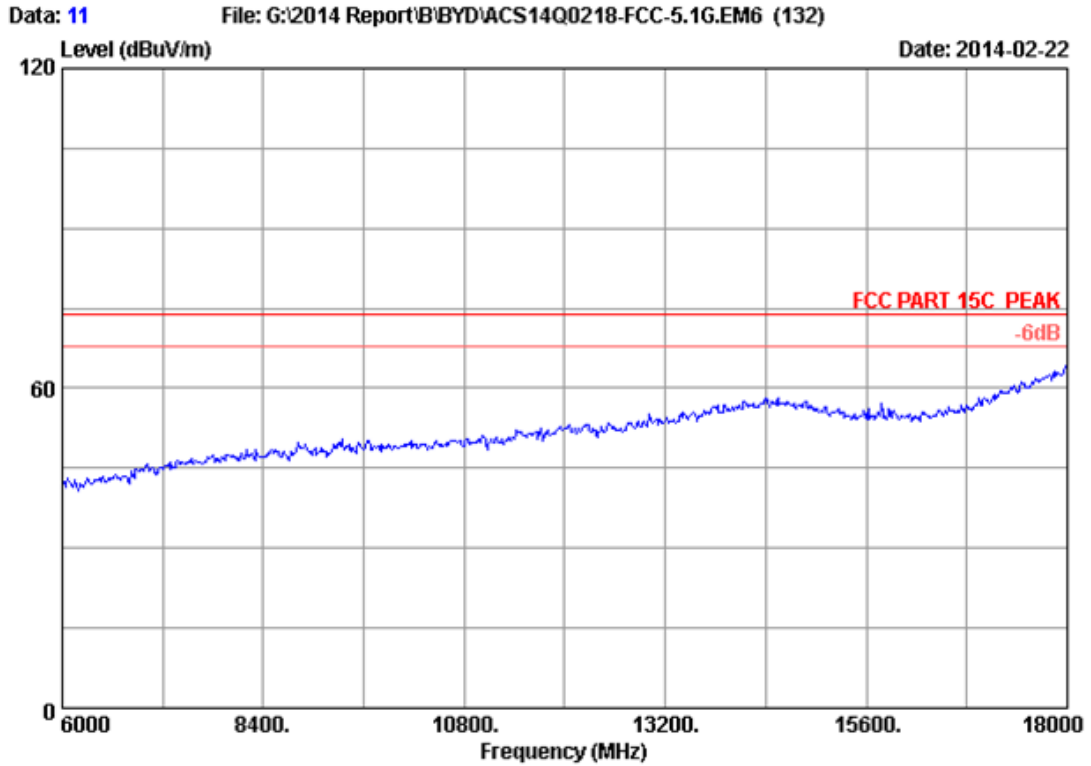

Site no. : 3m Chamber Data no. : 11
Dis. / Ant. : 3m 2013 3115 (4580) Ant. pol. : HORIZONTAL
Limit : FCC PART 15C PEAK
Env. / Ins. : 24°C/56% Engineer : Leo-Li
EUT : Notebook
Power Rating : DC 19V From Adapter Input AC 120V/60Hz
Test Mode : IEEE802.11a CH40 5200MHz Tx
M/N : RZ09-0116

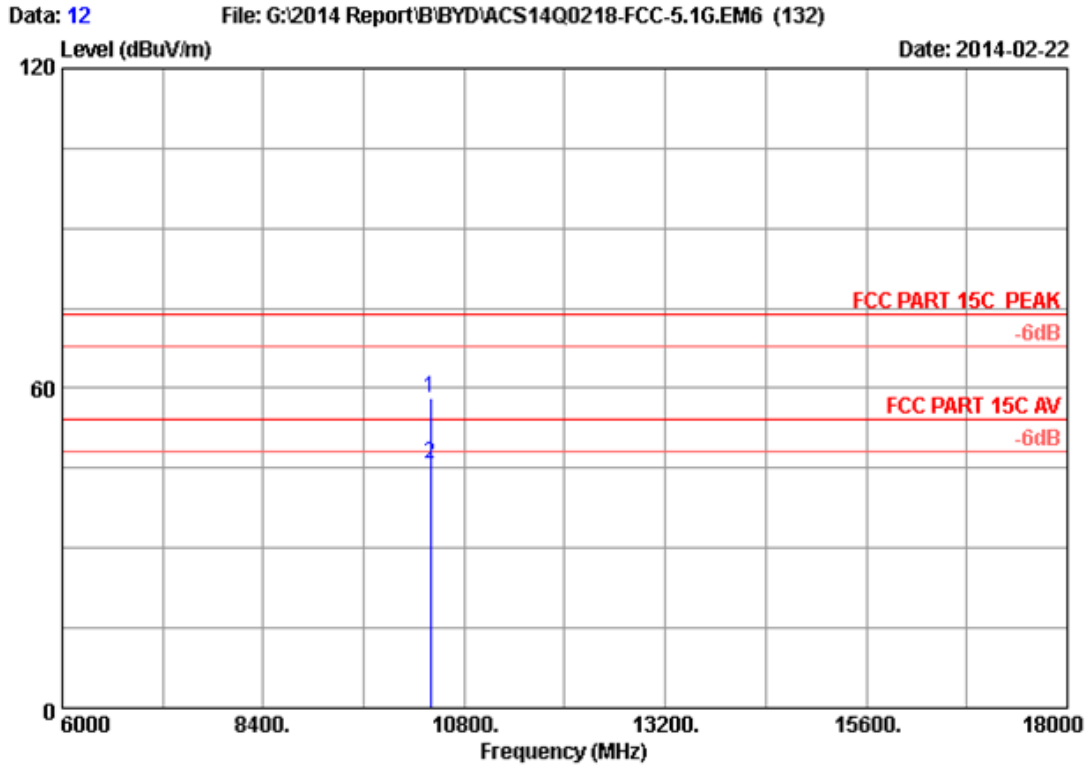

Site no. : 3m Chamber Data no. : 12
 Dis. / Ant. : 3m 2013 3115 (4580) Ant. pol. : HORIZONTAL
 Limit : FCC PART 15C PEAK
 Env. / Ins. : 24°C/56% Engineer : Leo-Li
 EUT : Notebook
 Power Rating : DC 19V From Adapter Input AC 120V/60Hz
 Test Mode : IEEE802.11a CH40 5200MHz Tx
 M/N : RZ09-0116

No.	Freq. (MHz)	Ant. Factor (dB/m)	Cable Loss (dB)	AMP factor (dB)	Reading (dBUV)	Emission Level (dBUV/m)	Limits (dBUV/m)	Margin (dB)	Remark
1	10400.000	38.16	12.66	35.44	42.64	58.02	74.00	15.98	Peak
2	10400.000	38.16	12.66	35.44	30.43	45.81	54.00	8.19	Average

Remarks: 1. Emission Level= Antenna Factor + Cable Loss + Reading - Amp Factor
 2. The emission levels that are 20dB below the official limit are not reported.

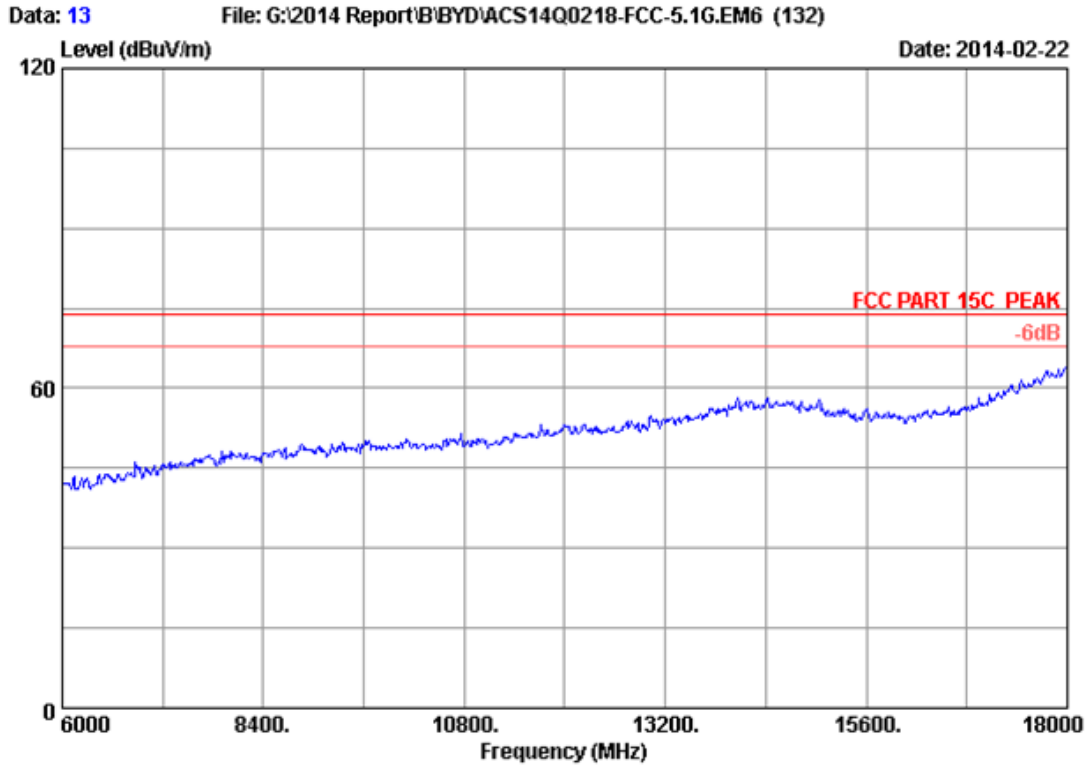

Site no. : 3m Chamber Data no. : 13
Dis. / Ant. : 3m 2013 3115 (4580) Ant. pol. : VERTICAL
Limit : FCC PART 15C PEAK
Env. / Ins. : 24°C/56% Engineer : Leo-Li
EUT : Notebook
Power Rating : DC 19V From Adapter Input AC 120V/60Hz
Test Mode : IEEE802.11a CH40 5200MHz Tx
M/N : RZ09-0116

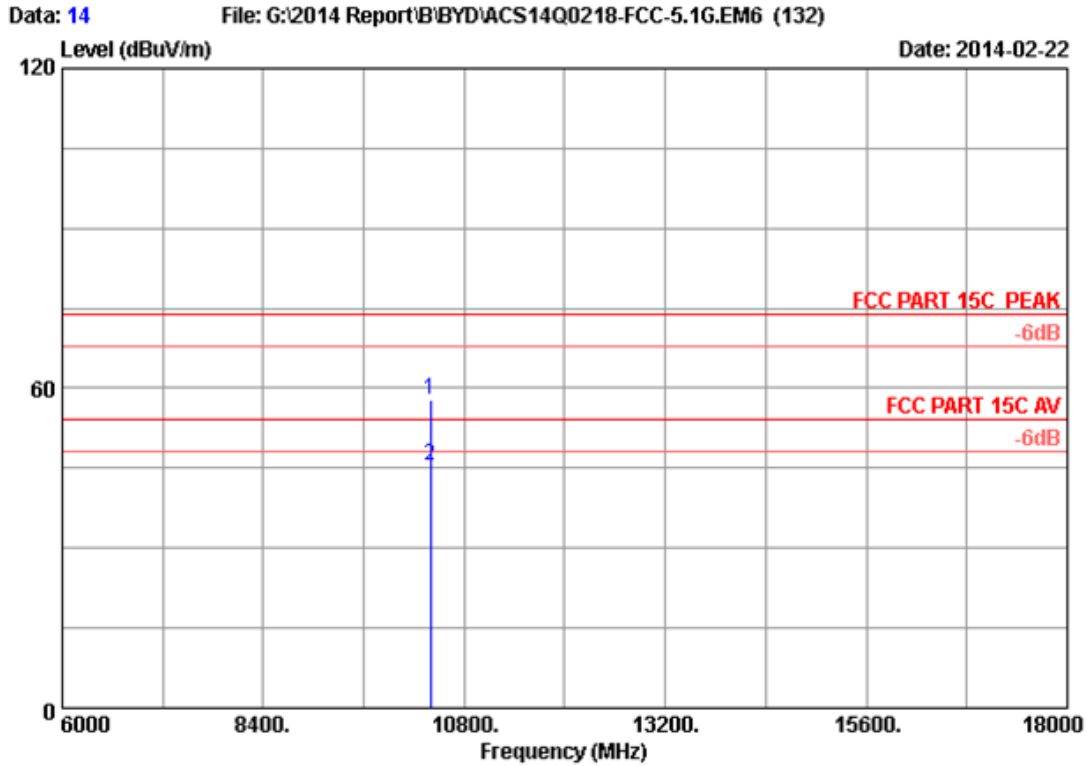

Site no. : 3m Chamber Data no. : 14
 Dis. / Ant. : 3m 2013 3115 (4580) Ant. pol. : VERTICAL
 Limit : FCC PART 15C PEAK
 Env. / Ins. : 24°C/56% Engineer : Leo-Li
 EUT : Notebook
 Power Rating : DC 19V From Adapter Input AC 120V/60Hz
 Test Mode : IEEE802.11a CH40 5200MHz Tx
 M/N : RZ09-0116

No.	Freq. (MHz)	Ant. Factor (dB/m)	Cable Loss (dB)	AMP factor (dB)	Reading (dBUV)	Emission Level (dBUV/m)	Limits (dBUV/m)	Margin (dB)	Remark
1	10400.000	38.16	12.66	35.44	42.61	57.99	74.00	16.01	Peak
2	10400.000	38.16	12.66	35.44	30.21	45.59	54.00	8.41	Average

Remarks: 1. Emission Level= Antenna Factor + Cable Loss + Reading - Amp Factor
 2. The emission levels that are 20dB below the official limit are not reported.

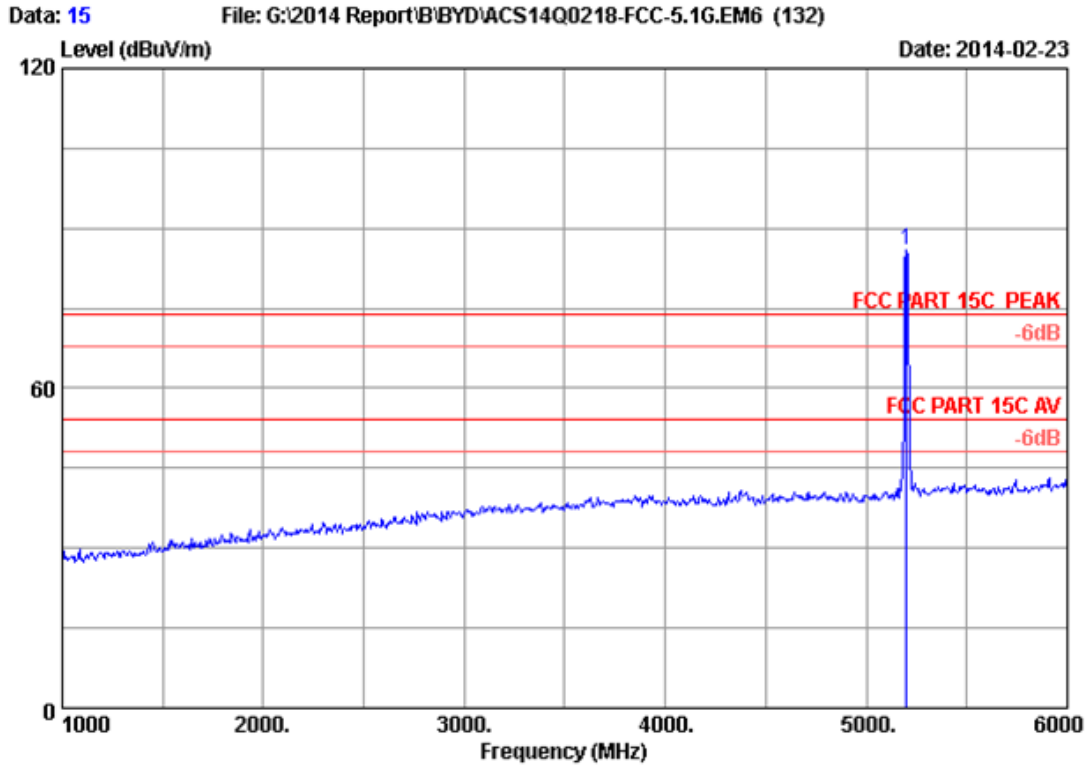

Site no. : 3m Chamber Data no. : 15
 Dis. / Ant. : 3m 2013 3115 (4580) Ant. pol. : HORIZONTAL
 Limit : FCC PART 15C PEAK
 Env. / Ins. : 24°C/56% Engineer : Leo-Li
 EUT : Notebook
 Power Rating : DC 19V From Adapter Input AC 120V/60Hz
 Test Mode : IEEE802.11a CH40 5200MHz Tx
 M/N : RZ09-0116

No.	Freq. (MHz)	Ant. Factor (dB/m)	Cable Loss (dB)	AMP factor (dB)	Reading (dBuV)	Emission Level (dBuV/m)	Limits (dBuV/m)	Margin (dB)	Remark
1	5200.000	33.52	8.97	35.70	79.02	85.81	74.00	-11.81	Peak

Remarks: 1. Emission Level= Antenna Factor + Cable Loss + Reading - Amp Factor
 2. The emission levels that are 20dB below the official limit are not reported.

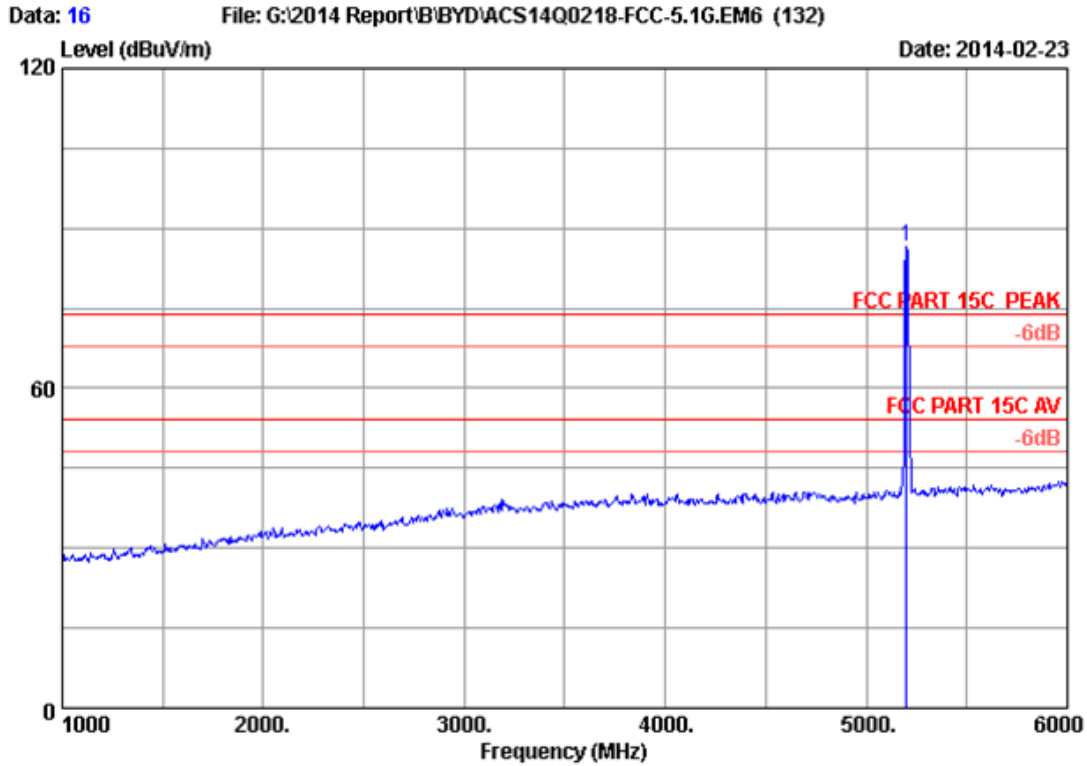

Site no. : 3m Chamber Data no. : 16
 Dis. / Ant. : 3m 2013 3115 (4580) Ant. pol. : VERTICAL
 Limit : FCC PART 15C PEAK
 Env. / Ins. : 24°C/56% Engineer : Leo-Li
 EUT : Notebook
 Power Rating : DC 19V From Adapter Input AC 120V/60Hz
 Test Mode : IEEE802.11a CH40 5200MHz Tx
 M/N : RZ09-0116

No.	Freq. (MHz)	Ant. Factor (dB/m)	Cable Loss (dB)	AMP factor (dB)	Reading (dBUV)	Emission Level (dBUV/m)	Limits (dBUV/m)	Margin (dB)	Remark
1	5200.000	33.52	8.97	35.70	79.88	86.67	74.00	-12.67	Peak

Remarks: 1. Emission Level= Antenna Factor + Cable Loss + Reading - Amp Factor
 2. The emission levels that are 20dB below the official limit are not reported.

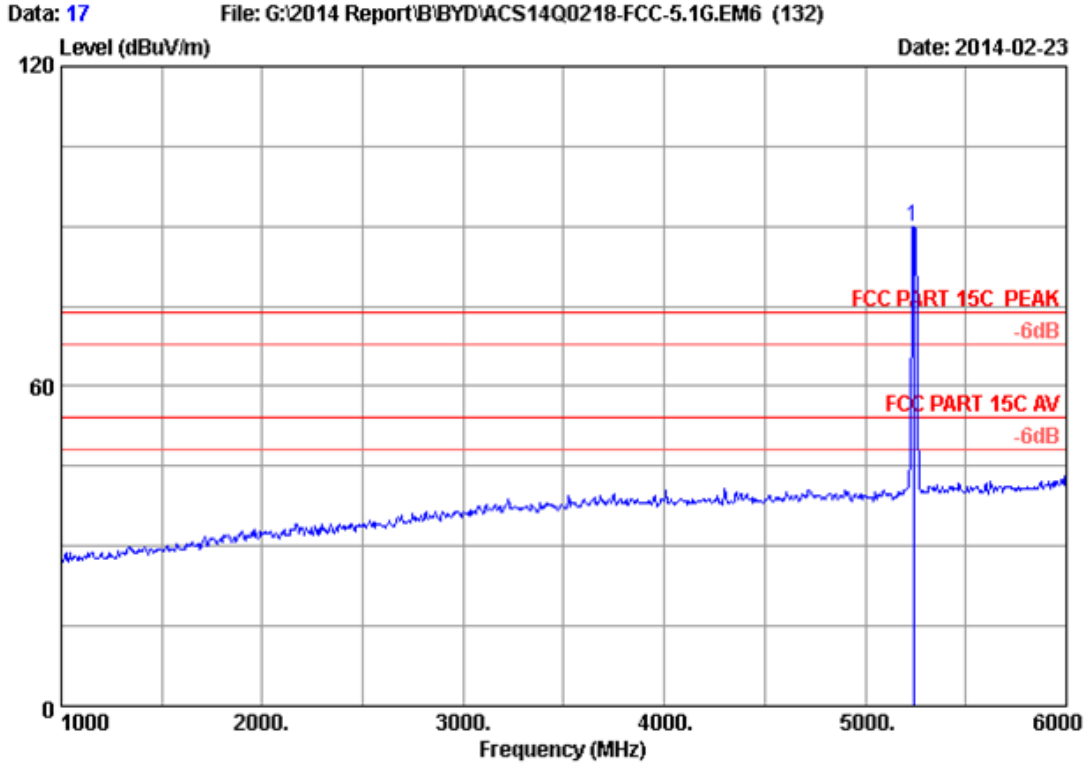

Site no. : 3m Chamber Data no. : 17
 Dis. / Ant. : 3m 2013 3115 (4580) Ant. pol. : VERTICAL
 Limit : FCC PART 15C PEAK
 Env. / Ins. : 24°C/56% Engineer : Leo-Li
 EUT : Notebook
 Power Rating : DC 19V From Adapter Input AC 120V/60Hz
 Test Mode : IEEE802.11a CH48 5240MHz Tx
 M/N : RZ09-0116

No.	Freq. (MHz)	Ant. Factor (dB/m)	Cable Loss (dB)	AMP factor (dB)	Reading (dBuV)	Emission Level (dBuV/m)	Limits (dBuV/m)	Margin (dB)	Remark
1	5240.000	33.58	9.02	35.70	83.16	90.06	74.00	-16.06	Peak

Remarks: 1. Emission Level= Antenna Factor + Cable Loss + Reading - Amp Factor
 2. The emission levels that are 20dB below the official limit are not reported.

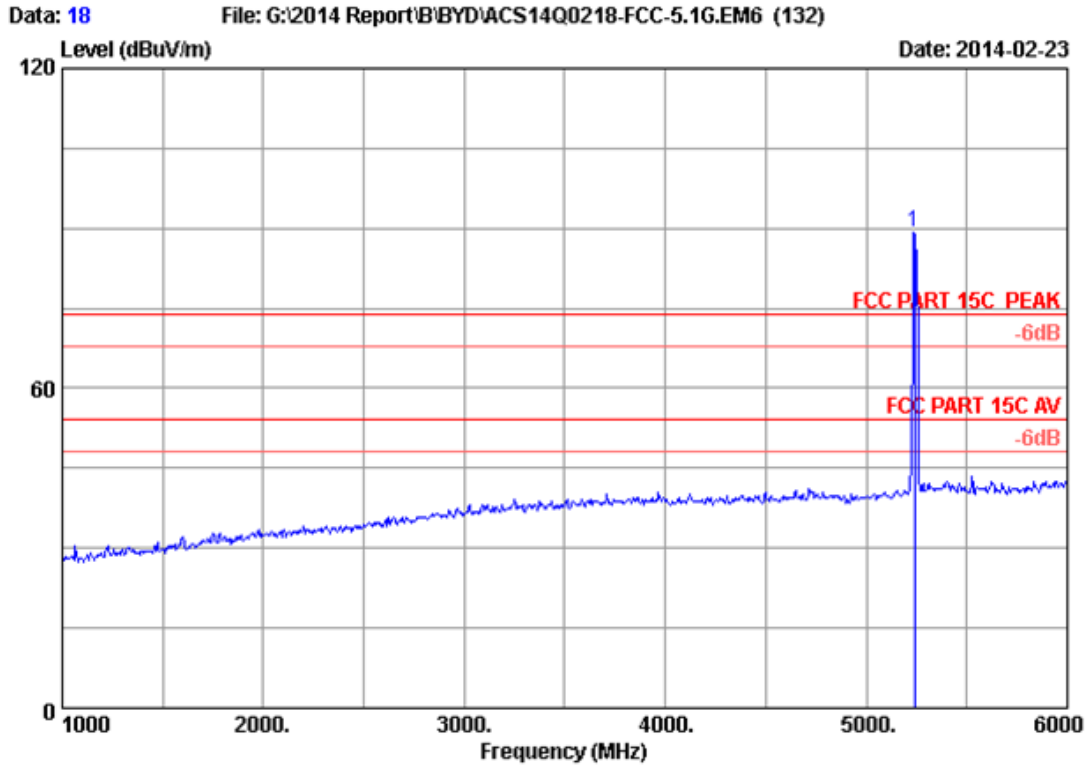

Site no. : 3m Chamber Data no. : 18
 Dis. / Ant. : 3m 2013 3115 (4580) Ant. pol. : HORIZONTAL
 Limit : FCC PART 15C PEAK
 Env. / Ins. : 24°C/56% Engineer : Leo-Li
 EUT : Notebook
 Power Rating : DC 19V From Adapter Input AC 120V/60Hz
 Test Mode : IEEE802.11a CH48 5240MHz Tx
 M/N : RZ09-0116

No.	Freq. (MHz)	Ant. Factor (dB/m)	Cable Loss (dB)	AMP factor (dB)	Reading (dBuV)	Emission Level (dBuV/m)	Limits (dBuV/m)	Margin (dB)	Remark
1	5240.000	33.58	9.02	35.70	82.44	89.34	74.00	-15.34	Peak

Remarks: 1. Emission Level= Antenna Factor + Cable Loss + Reading - Amp Factor
 2. The emission levels that are 20dB below the official limit are not reported.

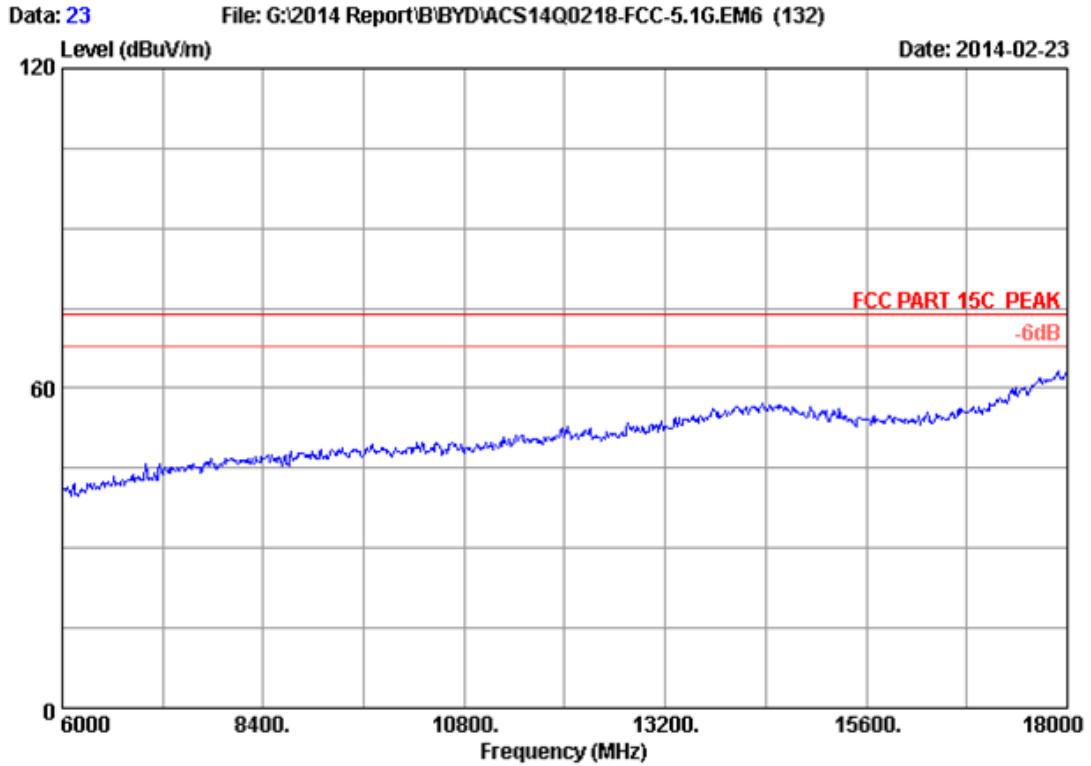

Site no. : 3m Chamber Data no. : 23
Dis. / Ant. : 3m 2013 3115 (4580) Ant. pol. : VERTICAL
Limit : FCC PART 15C PEAK
Env. / Ins. : 24°C/56% Engineer : Leo-Li
EUT : Notebook
Power Rating : DC 19V From Adapter Input AC 120V/60Hz
Test Mode : IEEE802.11a CH48 5240MHz Tx
M/N : RZ09-0116

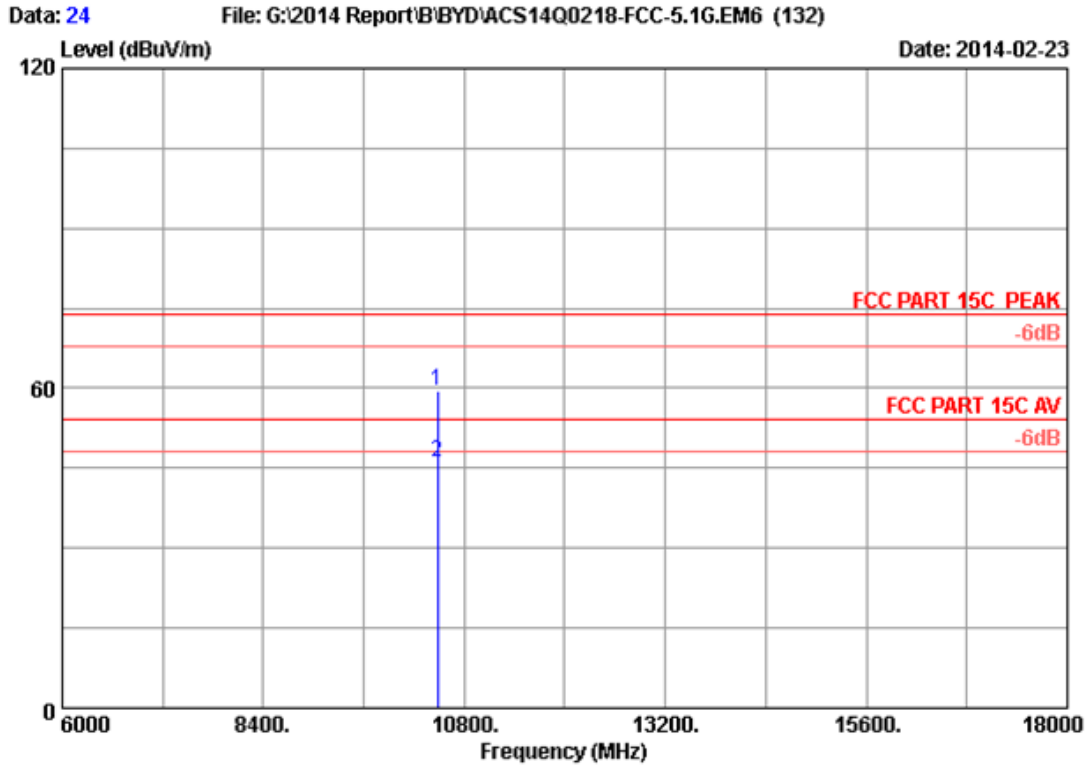

Site no. : 3m Chamber Data no. : 24
 Dis. / Ant. : 3m 2013 3115 (4580) Ant. pol. : VERTICAL
 Limit : FCC PART 15C PEAK
 Env. / Ins. : 24°C/56% Engineer : Leo-Li
 EUT : Notebook
 Power Rating : DC 19V From Adapter Input AC 120V/60Hz
 Test Mode : IEEE802.11a CH48 5240MHz Tx
 M/N : RZ09-0116

No.	Freq. (MHz)	Ant. Factor (dB/m)	Cable Loss (dB)	AMP factor (dB)	Reading (dBUV)	Emission Level (dBUV/m)	Limits (dBUV/m)	Margin (dB)	Remark
1	10480.000	38.19	12.70	35.43	44.11	59.57	74.00	14.43	Peak
2	10480.000	38.19	12.70	35.43	30.56	46.02	54.00	7.98	Average

Remarks: 1. Emission Level= Antenna Factor + Cable Loss + Reading - Amp Factor
 2. The emission levels that are 20dB below the official limit are not reported.

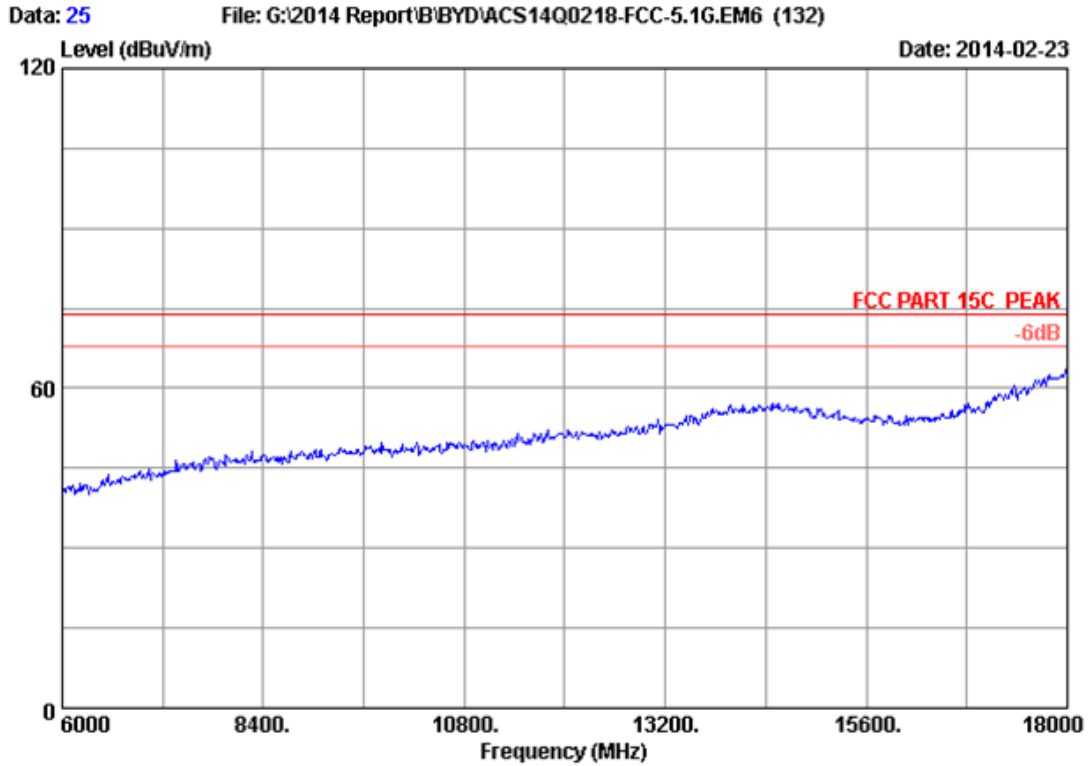

Site no. : 3m Chamber Data no. : 25
Dis. / Ant. : 3m 2013 3115 (4580) Ant. pol. : HORIZONTAL
Limit : FCC PART 15C PEAK
Env. / Ins. : 24°C/56% Engineer : Leo-Li
EUT : Notebook
Power Rating : DC 19V From Adapter Input AC 120V/60Hz
Test Mode : IEEE802.11a CH48 5240MHz Tx
M/N : RZ09-0116

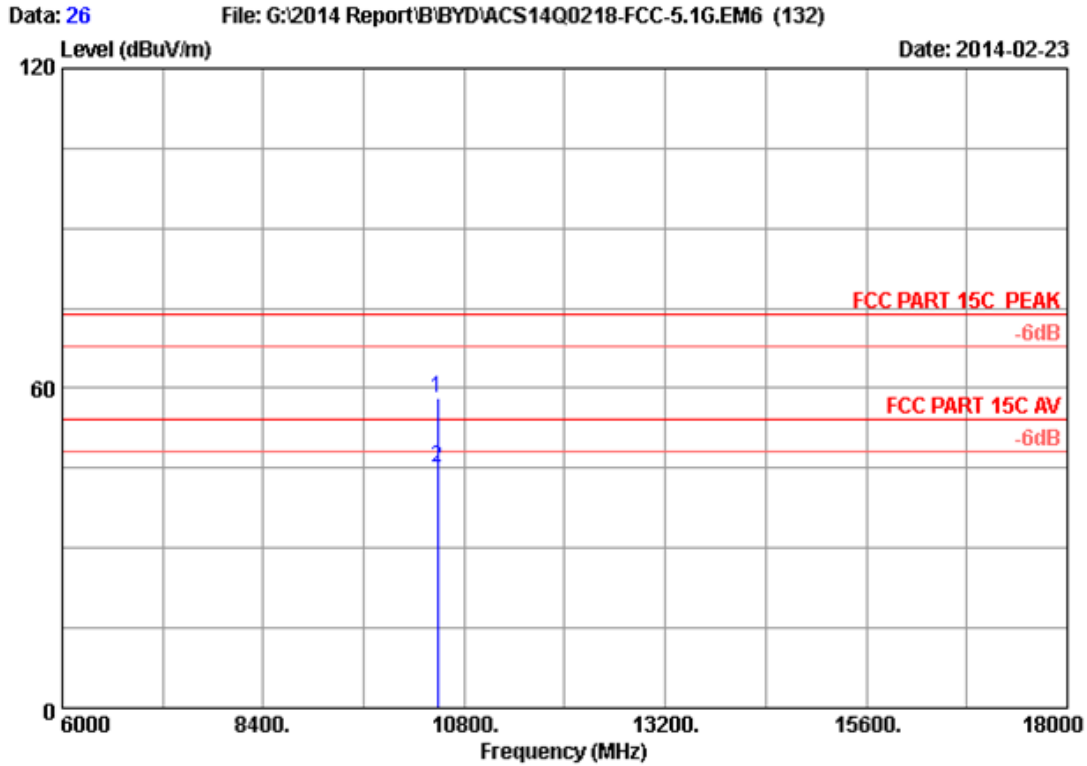

Site no. : 3m Chamber Data no. : 26
 Dis. / Ant. : 3m 2013 3115 (4580) Ant. pol. : HORIZONTAL
 Limit : FCC PART 15C PEAK
 Env. / Ins. : 24°C/56% Engineer : Leo-Li
 EUT : Notebook
 Power Rating : DC 19V From Adapter Input AC 120V/60Hz
 Test Mode : IEEE802.11a CH48 5240MHz Tx
 M/N : RZ09-0116

No.	Freq. (MHz)	Ant. Factor (dB/m)	Cable Loss (dB)	AMP factor (dB)	Reading (dBUV)	Emission Level (dBUV/m)	Limits (dBUV/m)	Margin (dB)	Remark
1	10480.000	38.19	12.70	35.43	42.70	58.16	74.00	15.84	Peak
2	10480.000	38.19	12.70	35.43	29.75	45.21	54.00	8.79	Average

Remarks: 1. Emission Level= Antenna Factor + Cable Loss + Reading - Amp Factor
 2. The emission levels that are 20dB below the official limit are not reported.

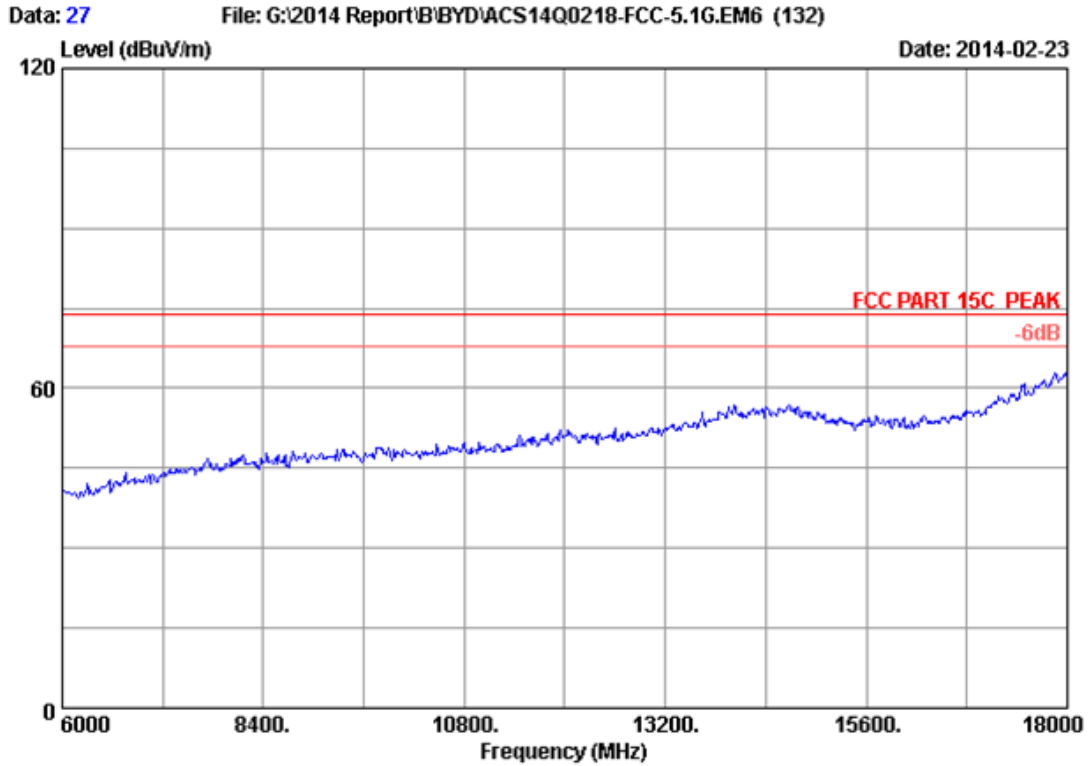

Site no. : 3m Chamber Data no. : 27
Dis. / Ant. : 3m 2013 3115 (4580) Ant. pol. : VERTICAL
Limit : FCC PART 15C PEAK
Env. / Ins. : 24°C/56% Engineer : Leo-Li
EUT : Notebook
Power Rating : DC 19V From Adapter Input AC 120V/60Hz
Test Mode : IEEE802.11nHT20 CH48 5240MHz Tx
M/N : RZ09-0116

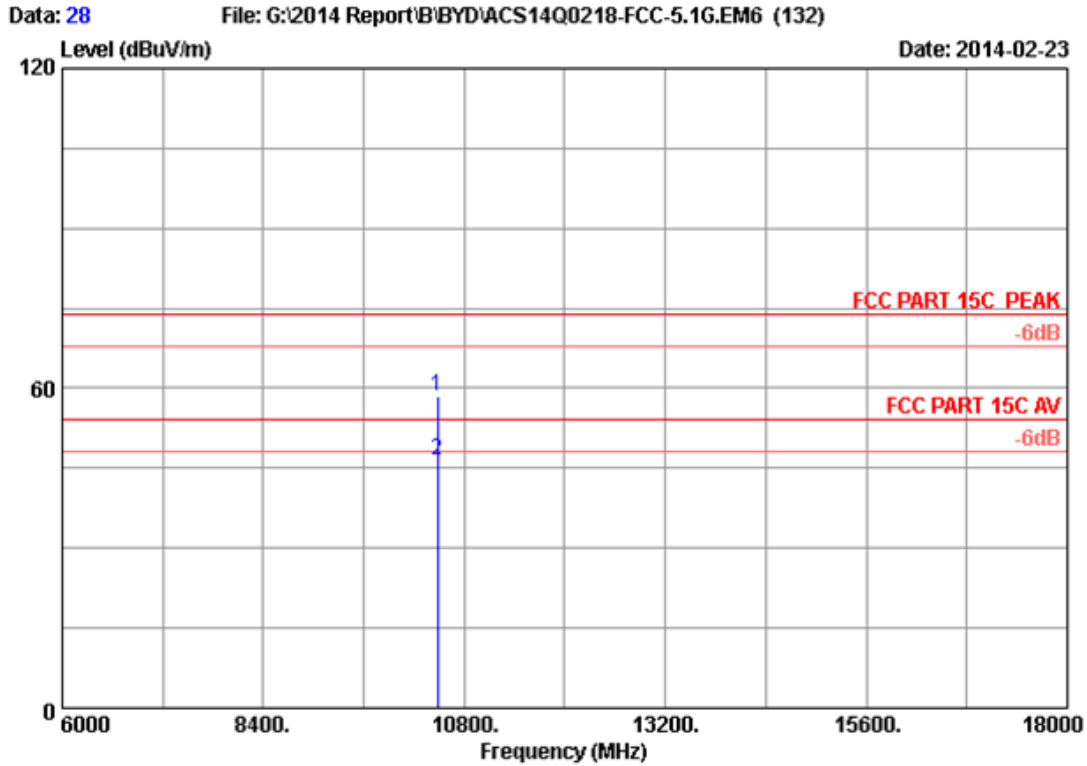

Site no. : 3m Chamber Data no. : 28
 Dis. / Ant. : 3m 2013 3115 (4580) Ant. pol. : VERTICAL
 Limit : FCC PART 15C PEAK
 Env. / Ins. : 24°C/56% Engineer : Leo-Li
 EUT : Notebook
 Power Rating : DC 19V From Adapter Input AC 120V/60Hz
 Test Mode : IEEE802.11nHT20 CH48 5240MHz Tx
 M/N : RZ09-0116

No.	Freq. (MHz)	Ant. Factor (dB/m)	Cable Loss (dB)	AMP factor (dB)	Reading (dBUV)	Emission Level (dBUV/m)	Limits (dBUV/m)	Margin (dB)	Remark
1	10480.000	38.19	12.70	35.43	43.04	58.50	74.00	15.50	Peak
2	10480.000	38.19	12.70	35.43	30.90	46.36	54.00	7.64	Average

Remarks: 1. Emission Level= Antenna Factor + Cable Loss + Reading - Amp Factor
 2. The emission levels that are 20dB below the official limit are not reported.

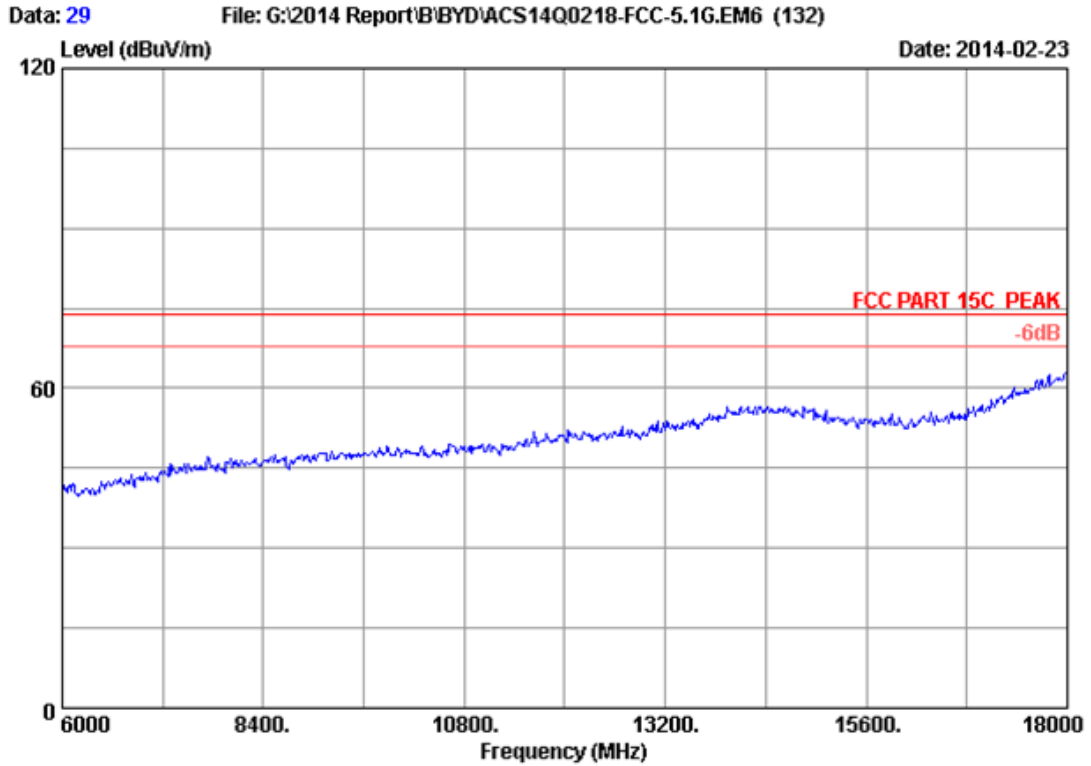

Site no. : 3m Chamber Data no. : 29
Dis. / Ant. : 3m 2013 3115 (4580) Ant. pol. : HORIZONTAL
Limit : FCC PART 15C PEAK
Env. / Ins. : 24°C/56% Engineer : Leo-Li
EUT : Notebook
Power Rating : DC 19V From Adapter Input AC 120V/60Hz
Test Mode : IEEE802.11nHT20 CH48 5240MHz Tx
M/N : RZ09-0116

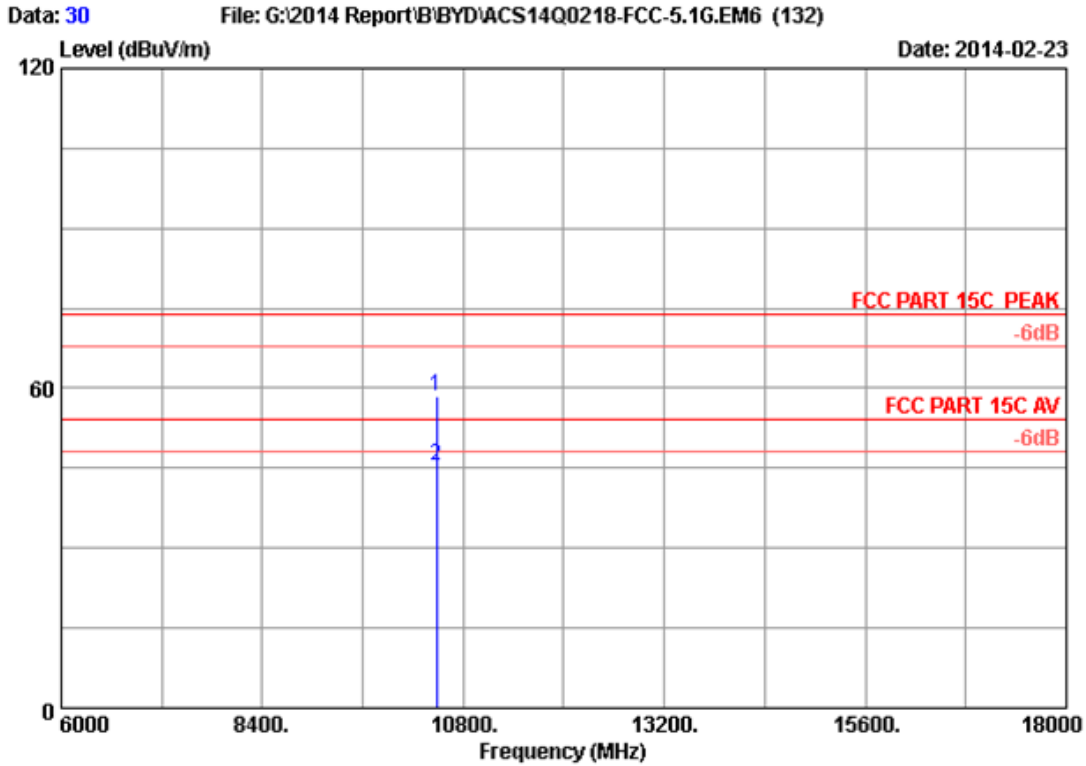

Site no. : 3m Chamber Data no. : 30
 Dis. / Ant. : 3m 2013 3115 (4580) Ant. pol. : HORIZONTAL
 Limit : FCC PART 15C PEAK
 Env. / Ins. : 24°C/56% Engineer : Leo-Li
 EUT : Notebook
 Power Rating : DC 19V From Adapter Input AC 120V/60Hz
 Test Mode : IEEE802.11nHT20 CH48 5240MHz Tx
 M/N : RZ09-0116

No.	Freq. (MHz)	Ant. Factor (dB/m)	Cable Loss (dB)	AMP factor (dB)	Reading (dBUV)	Emission Level (dBUV/m)	Limits (dBUV/m)	Margin (dB)	Remark
1	10480.000	38.19	12.70	35.43	43.07	58.53	74.00	15.47	Peak
2	10480.000	38.19	12.70	35.43	30.15	45.61	54.00	8.39	Average

Remarks: 1. Emission Level= Antenna Factor + Cable Loss + Reading - Amp Factor
 2. The emission levels that are 20dB below the official limit are not reported.

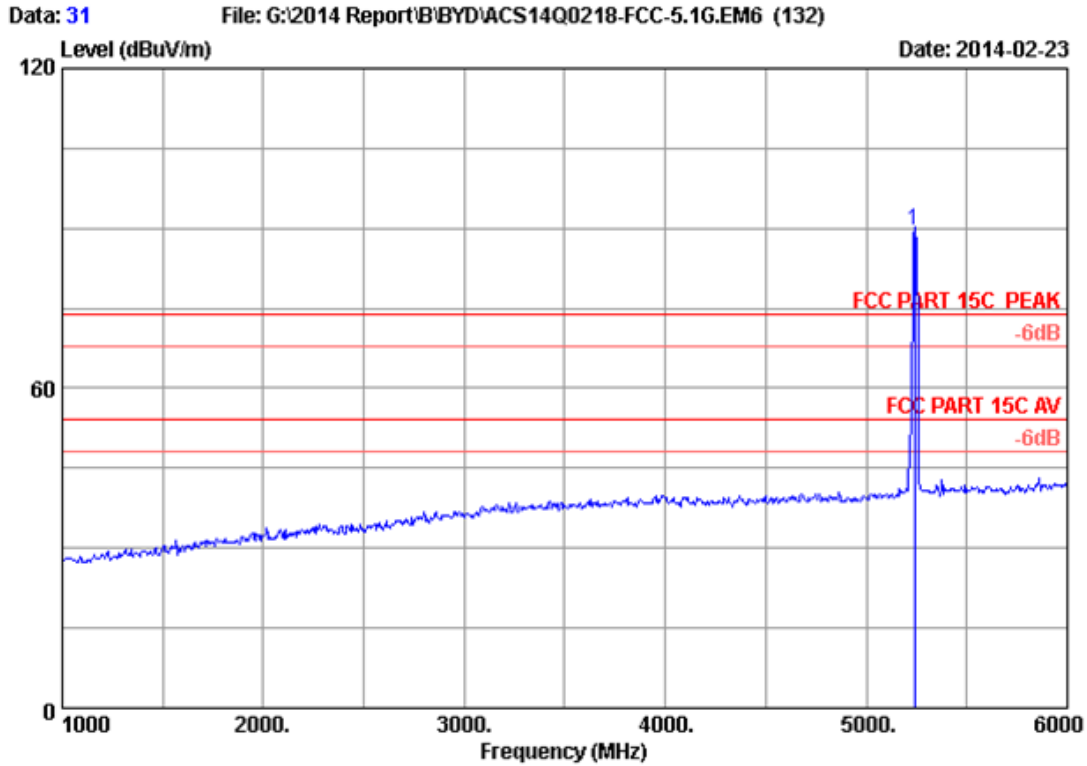

Site no. : 3m Chamber Data no. : 31
 Dis. / Ant. : 3m 2013 3115 (4580) Ant. pol. : VERTICAL
 Limit : FCC PART 15C PEAK
 Env. / Ins. : 24°C/56% Engineer : Leo-Li
 EUT : Notebook
 Power Rating : DC 19V From Adapter Input AC 120V/60Hz
 Test Mode : IEEE802.11nHT20 CH48 5240MHz Tx
 M/N : RZ09-0116

No.	Freq. (MHz)	Ant. Factor (dB/m)	Cable Loss (dB)	AMP factor (dB)	Reading (dBuV)	Emission Level (dBuV/m)	Limits (dBuV/m)	Margin (dB)	Remark
1	5240.000	33.58	9.02	35.70	82.61	89.51	74.00	-15.51	Peak

Remarks: 1. Emission Level= Antenna Factor + Cable Loss + Reading - Amp Factor
 2. The emission levels that are 20dB below the official limit are not reported.

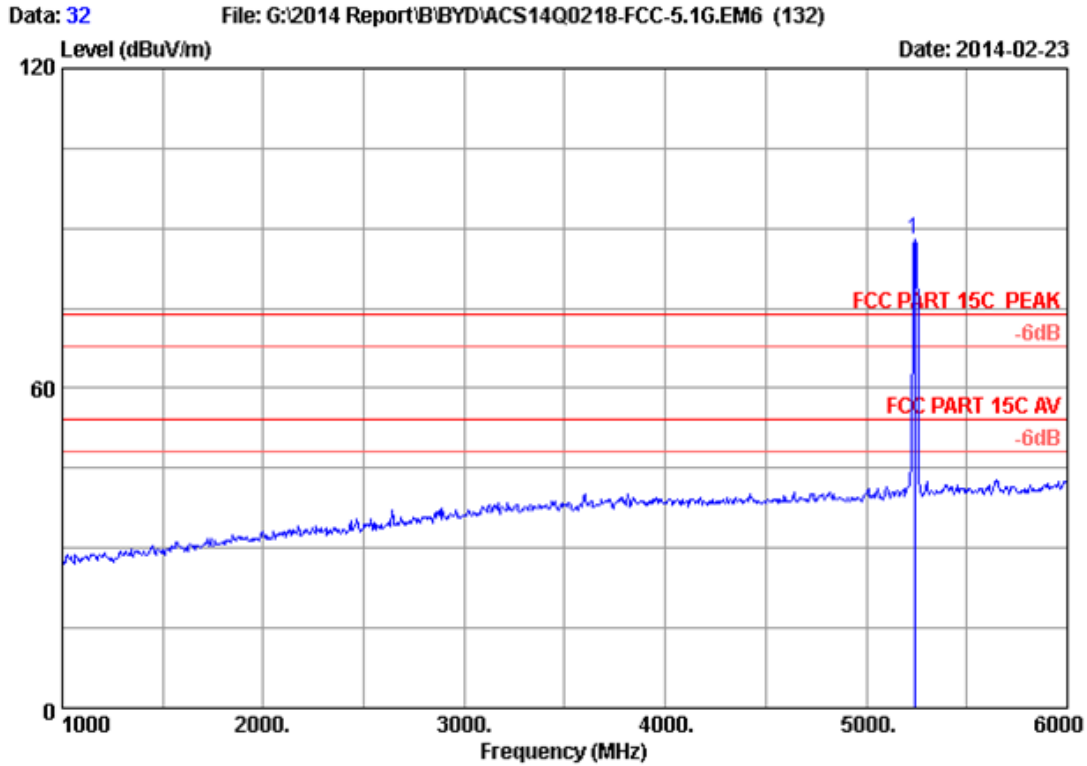

Site no. : 3m Chamber Data no. : 32
 Dis. / Ant. : 3m 2013 3115 (4580) Ant. pol. : HORIZONTAL
 Limit : FCC PART 15C PEAK
 Env. / Ins. : 24°C/56% Engineer : Leo-Li
 EUT : Notebook
 Power Rating : DC 19V From Adapter Input AC 120V/60Hz
 Test Mode : IEEE802.11nHT20 CH48 5240MHz Tx
 M/N : RZ09-0116

No.	Freq. (MHz)	Ant. Factor (dB/m)	Cable Loss (dB)	AMP factor (dB)	Reading (dBuV)	Emission Level (dBuV/m)	Limits (dBuV/m)	Margin (dB)	Remark
1	5240.000	33.58	9.02	35.70	81.16	88.06	74.00	-14.06	Peak

Remarks: 1. Emission Level= Antenna Factor + Cable Loss + Reading - Amp Factor
 2. The emission levels that are 20dB below the official limit are not reported.

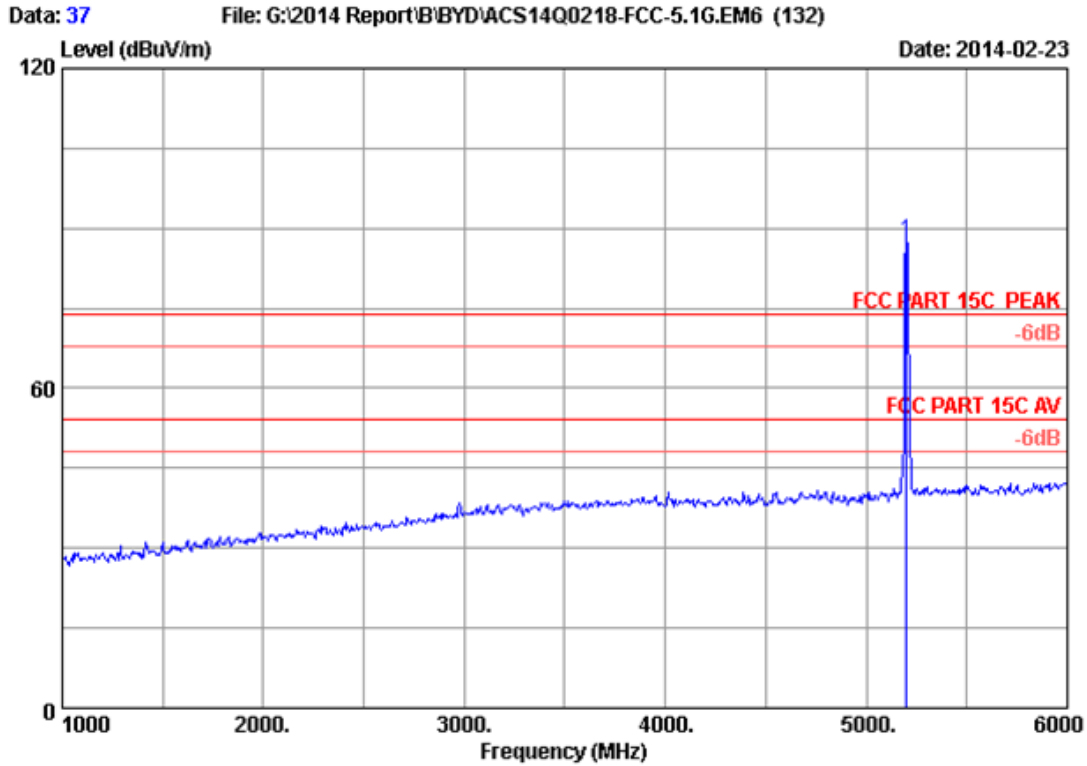

Site no. : 3m Chamber Data no. : 37
 Dis. / Ant. : 3m 2013 3115 (4580) Ant. pol. : VERTICAL
 Limit : FCC PART 15C PEAK
 Env. / Ins. : 24°C/56% Engineer : Leo-Li
 EUT : Notebook
 Power Rating : DC 19V From Adapter Input AC 120V/60Hz
 Test Mode : IEEE802.11nHT20 CH40 5200MHz Tx
 M/N : RZ09-0116

No.	Freq. (MHz)	Ant. Factor (dB/m)	Cable Loss (dB)	AMP factor (dB)	Reading (dBuV)	Emission Level (dBuV/m)	Limits (dBuV/m)	Margin (dB)	Remark
1	5200.000	33.52	8.97	35.70	80.65	87.44	74.00	-13.44	Peak

Remarks: 1. Emission Level= Antenna Factor + Cable Loss + Reading - Amp Factor
 2. The emission levels that are 20dB below the official limit are not reported.

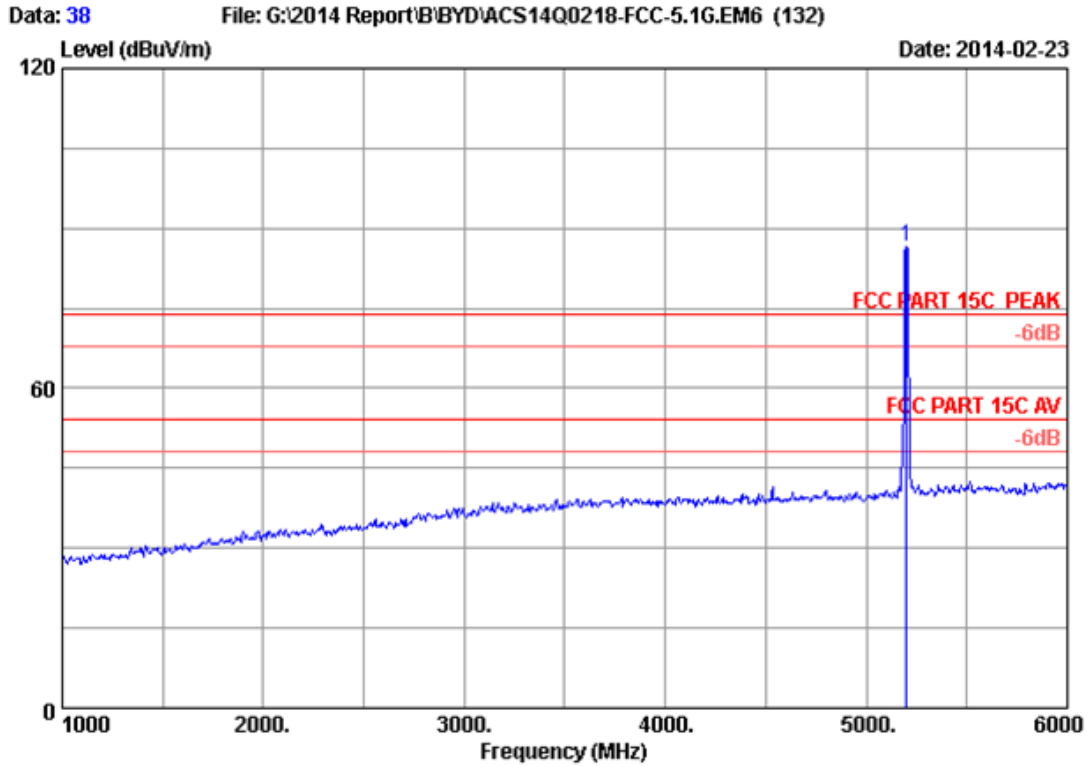

Site no. : 3m Chamber Data no. : 38
 Dis. / Ant. : 3m 2013 3115 (4580) Ant. pol. : HORIZONTAL
 Limit : FCC PART 15C PEAK
 Env. / Ins. : 24°C/56% Engineer : Leo-Li
 EUT : Notebook
 Power Rating : DC 19V From Adapter Input AC 120V/60Hz
 Test Mode : IEEE802.11nHT20 CH40 5200MHz Tx
 M/N : RZ09-0116

No.	Freq. (MHz)	Ant. Factor (dB/m)	Cable Loss (dB)	AMP factor (dB)	Reading (dBuV)	Emission Level (dBuV/m)	Limits (dBuV/m)	Margin (dB)	Remark
1	5200.000	33.52	8.97	35.70	79.82	86.61	74.00	-12.61	Peak

Remarks: 1. Emission Level= Antenna Factor + Cable Loss + Reading - Amp Factor
 2. The emission levels that are 20dB below the official limit are not reported.

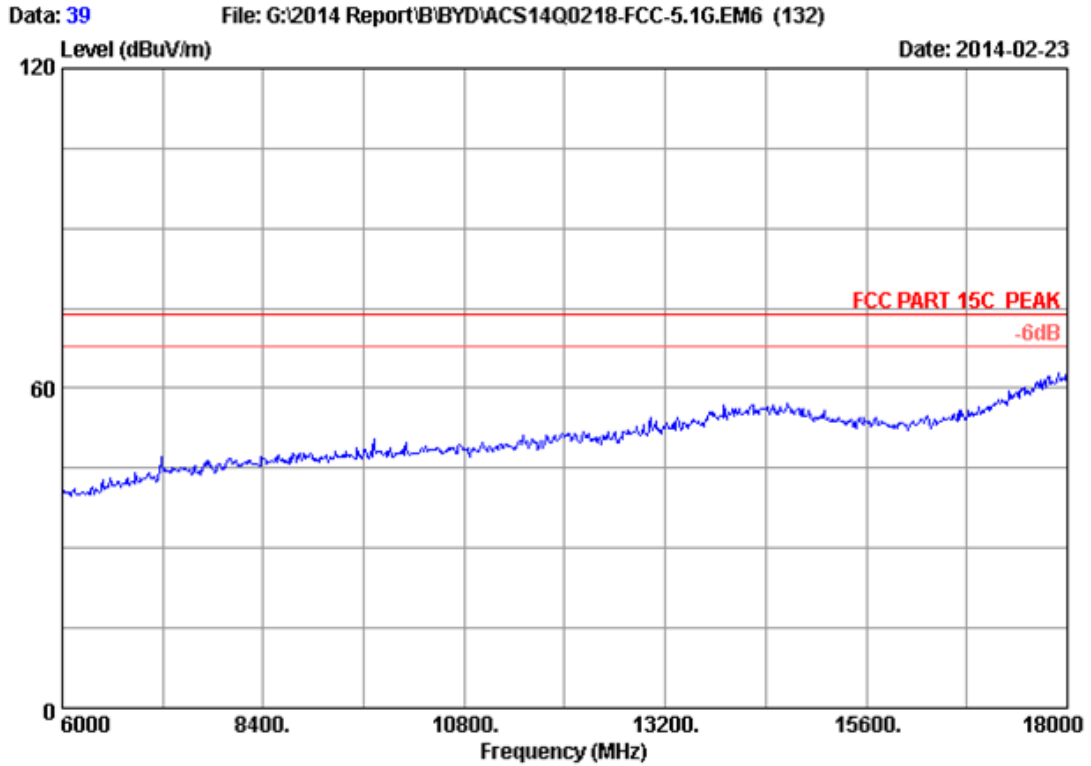

Site no. : 3m Chamber Data no. : 39
Dis. / Ant. : 3m 2013 3115 (4580) Ant. pol. : VERTICAL
Limit : FCC PART 15C PEAK
Env. / Ins. : 24°C/56% Engineer : Leo-Li
EUT : Notebook
Power Rating : DC 19V From Adapter Input AC 120V/60Hz
Test Mode : IEEE802.11nHT20 CH40 5200MHz Tx
M/N : RZ09-0116

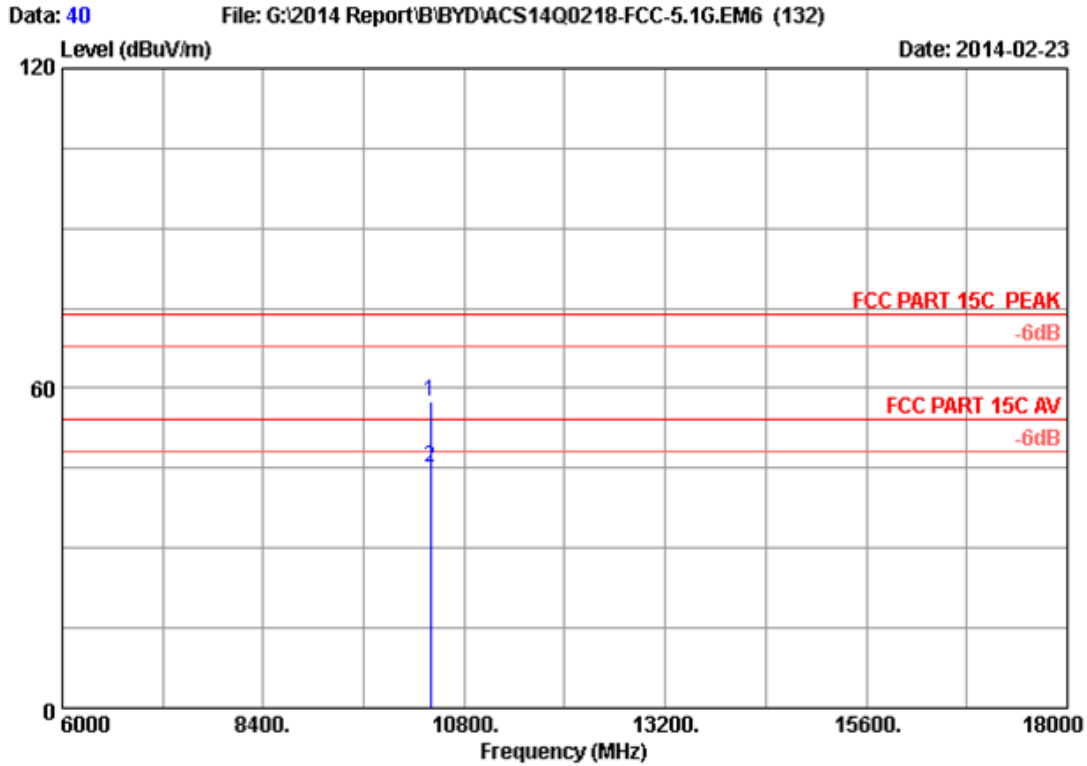

Site no. : 3m Chamber Data no. : 40
 Dis. / Ant. : 3m 2013 3115 (4580) Ant. pol. : VERTICAL
 Limit : FCC PART 15C PEAK
 Env. / Ins. : 24°C/56% Engineer : Leo-Li
 EUT : Notebook
 Power Rating : DC 19V From Adapter Input AC 120V/60Hz
 Test Mode : IEEE802.11nHT20 CH40 5200MHz Tx
 M/N : RZ09-0116

No.	Freq. (MHz)	Ant. Factor (dB/m)	Cable Loss (dB)	AMP factor (dB)	Reading (dBUV)	Emission Level (dBUV/m)	Limits (dBUV/m)	Margin (dB)	Remark
1	10400.000	38.16	12.66	35.44	42.23	57.61	74.00	16.39	Peak
2	10400.000	38.16	12.66	35.44	29.74	45.12	54.00	8.88	Average

Remarks: 1. Emission Level= Antenna Factor + Cable Loss + Reading - Amp Factor
 2. The emission levels that are 20dB below the official limit are not reported.

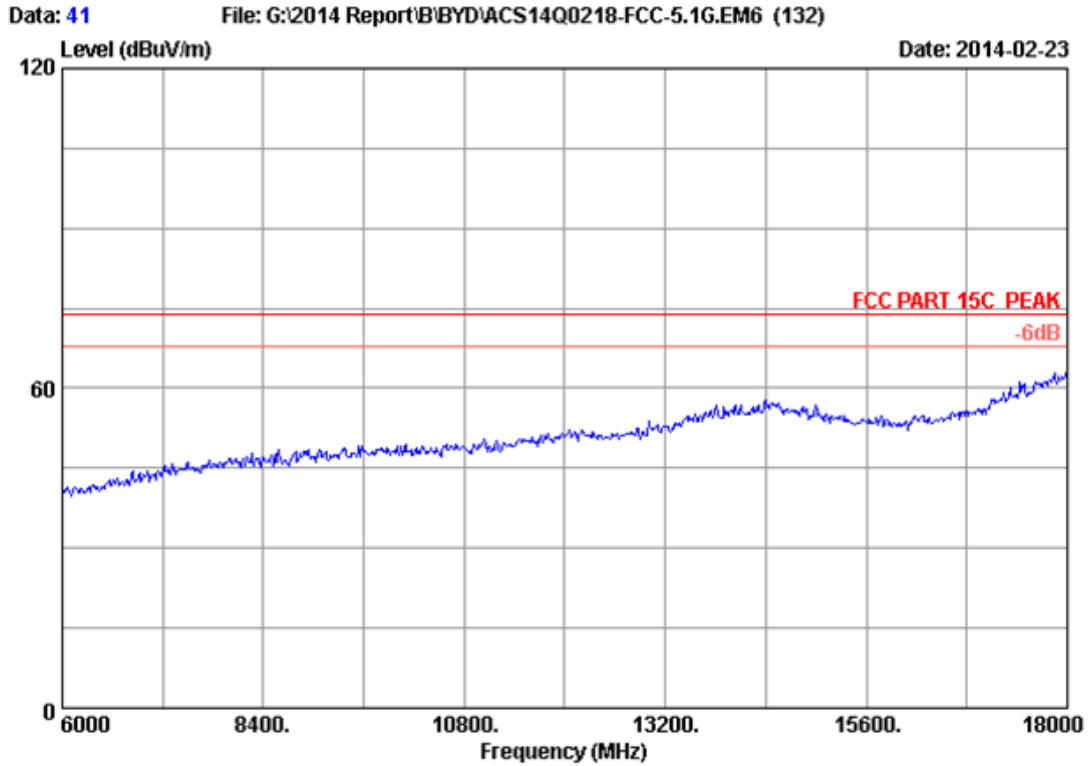

Site no. : 3m Chamber Data no. : 41
Dis. / Ant. : 3m 2013 3115 (4580) Ant. pol. : HORIZONTAL
Limit : FCC PART 15C PEAK
Env. / Ins. : 24°C/56% Engineer : Leo-Li
EUT : Notebook
Power Rating : DC 19V From Adapter Input AC 120V/60Hz
Test Mode : IEEE802.11nHT20 CH40 5200MHz Tx
M/N : RZ09-0116

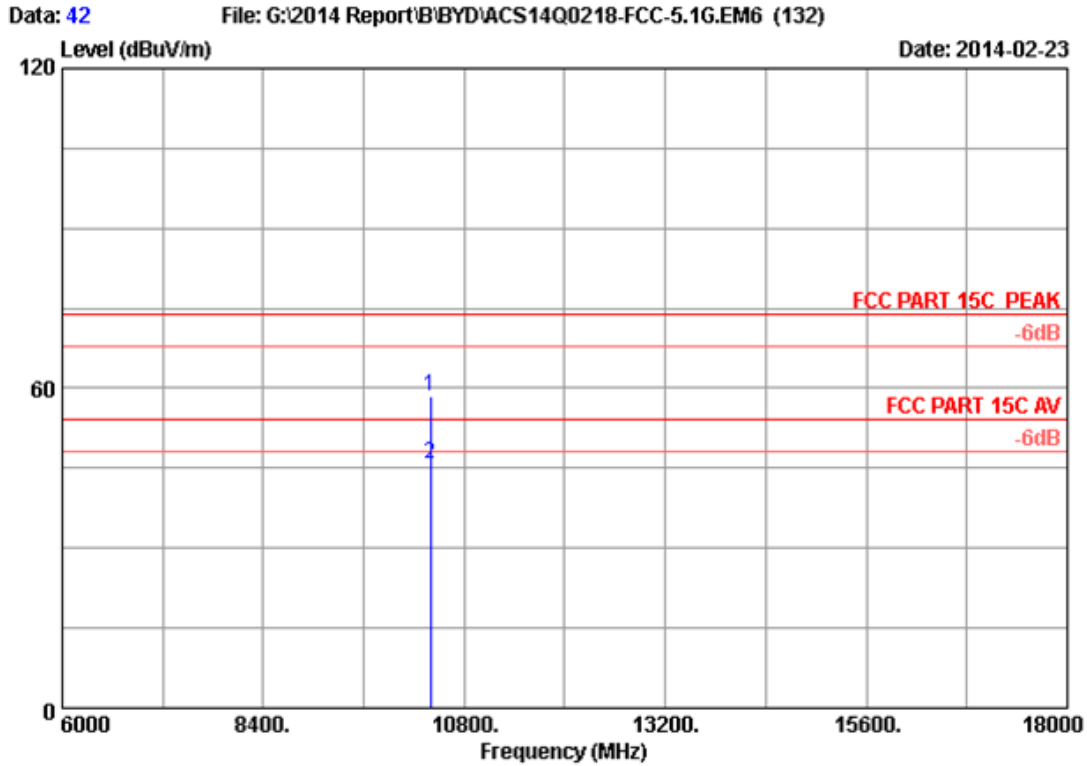

Site no. : 3m Chamber Data no. : 42
 Dis. / Ant. : 3m 2013 3115 (4580) Ant. pol. : HORIZONTAL
 Limit : FCC PART 15C PEAK
 Env. / Ins. : 24°C/56% Engineer : Leo-Li
 EUT : Notebook
 Power Rating : DC 19V From Adapter Input AC 120V/60Hz
 Test Mode : IEEE802.11nHT20 CH40 5200MHz Tx
 M/N : RZ09-0116

No.	Freq. (MHz)	Ant. Factor (dB/m)	Cable Loss (dB)	AMP factor (dB)	Reading (dBUV)	Emission Level (dBUV/m)	Limits (dBUV/m)	Margin (dB)	Remark
1	10400.000	38.16	12.66	35.44	43.27	58.65	74.00	15.35	Peak
2	10400.000	38.16	12.66	35.44	30.41	45.79	54.00	8.21	Average

Remarks: 1. Emission Level= Antenna Factor + Cable Loss + Reading - Amp Factor
 2. The emission levels that are 20dB below the official limit are not reported.

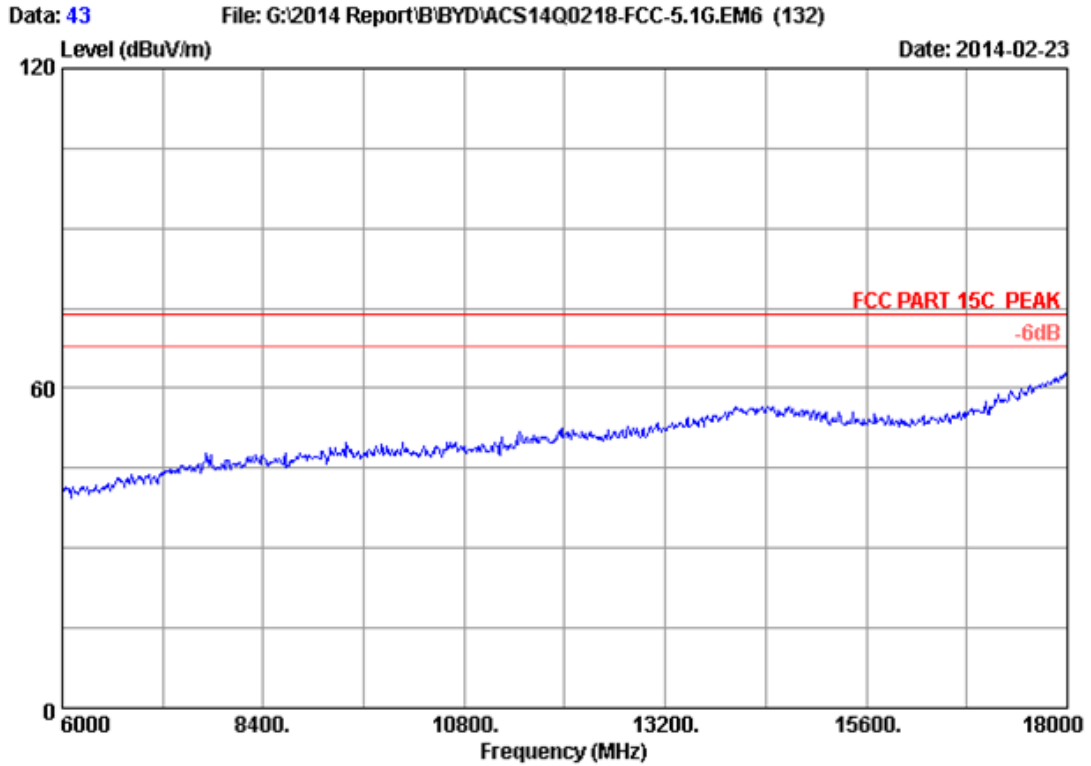

Site no. : 3m Chamber Data no. : 43
Dis. / Ant. : 3m 2013 3115 (4580) Ant. pol. : HORIZONTAL
Limit : FCC PART 15C PEAK
Env. / Ins. : 24°C/56% Engineer : Leo-Li
EUT : Notebook
Power Rating : DC 19V From Adapter Input AC 120V/60Hz
Test Mode : IEEE802.11nHT20 CH36 5180MHz Tx
M/N : RZ09-0116

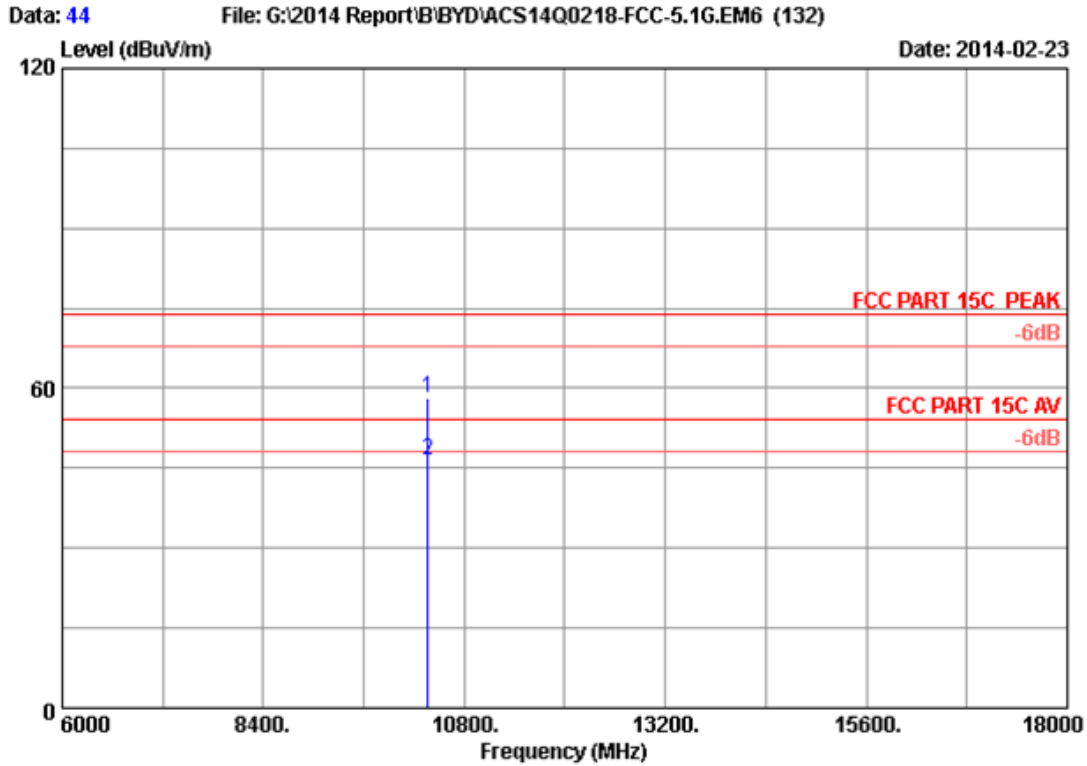

Site no. : 3m Chamber Data no. : 44
 Dis. / Ant. : 3m 2013 3115 (4580) Ant. pol. : HORIZONTAL
 Limit : FCC PART 15C PEAK
 Env. / Ins. : 24°C/56% Engineer : Leo-Li
 EUT : Notebook
 Power Rating : DC 19V From Adapter Input AC 120V/60Hz
 Test Mode : IEEE802.11nHT20 CH36 5180MHz Tx
 M/N : RZ09-0116

No.	Freq. (MHz)	Ant. Factor (dB/m)	Cable Loss (dB)	AMP factor (dB)	Reading (dBUV)	Emission Level (dBUV/m)	Limits (dBUV/m)	Margin (dB)	Remark
1	10360.000	38.14	12.64	35.45	42.70	58.03	74.00	15.97	Peak
2	10360.000	38.14	12.64	35.45	31.05	46.38	54.00	7.62	Average

Remarks: 1. Emission Level= Antenna Factor + Cable Loss + Reading - Amp Factor
 2. The emission levels that are 20dB below the official limit are not reported.

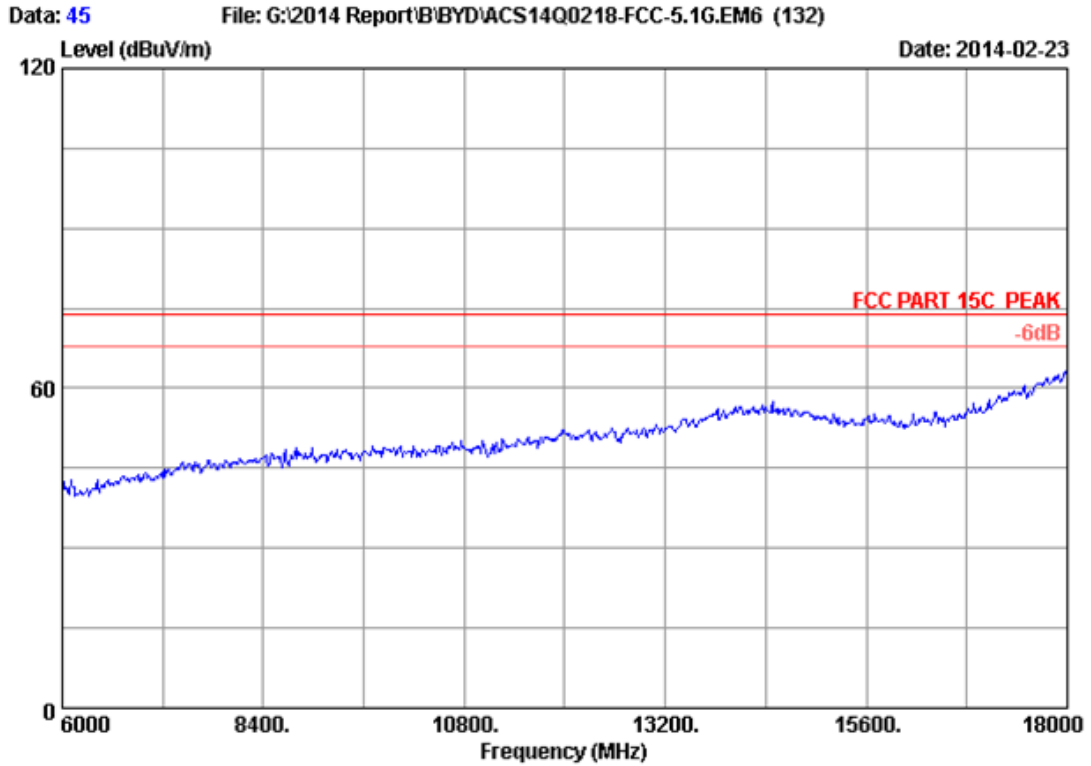

Site no. : 3m Chamber Data no. : 45
Dis. / Ant. : 3m 2013 3115 (4580) Ant. pol. : VERTICAL
Limit : FCC PART 15C PEAK
Env. / Ins. : 24°C/56% Engineer : Leo-Li
EUT : Notebook
Power Rating : DC 19V From Adapter Input AC 120V/60Hz
Test Mode : IEEE802.11nHT20 CH36 5180MHz Tx
M/N : RZ09-0116

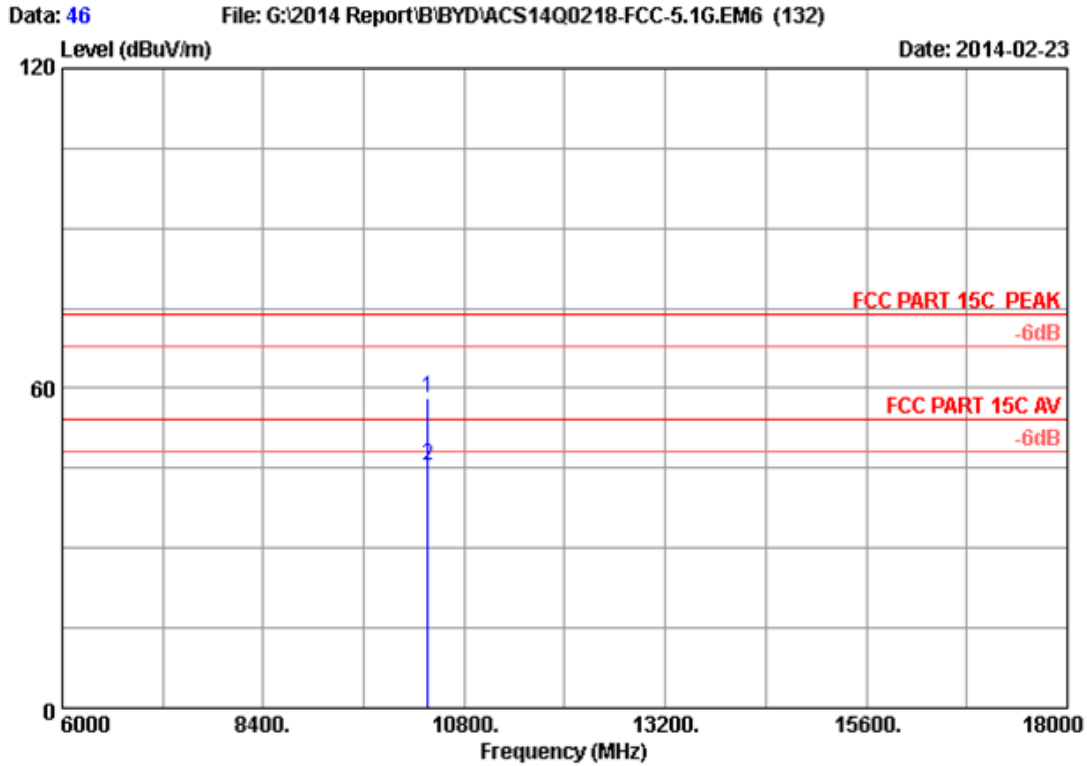

Site no. : 3m Chamber Data no. : 46
 Dis. / Ant. : 3m 2013 3115 (4580) Ant. pol. : VERTICAL
 Limit : FCC PART 15C PEAK
 Env. / Ins. : 24°C/56% Engineer : Leo-Li
 EUT : Notebook
 Power Rating : DC 19V From Adapter Input AC 120V/60Hz
 Test Mode : IEEE802.11nHT20 CH36 5180MHz Tx
 M/N : RZ09-0116

No.	Freq. (MHz)	Ant. Factor (dB/m)	Cable Loss (dB)	AMP factor (dB)	Reading (dBUV)	Emission Level (dBUV/m)	Limits (dBUV/m)	Margin (dB)	Remark
1	10360.000	38.14	12.64	35.45	42.70	58.03	74.00	15.97	Peak
2	10360.000	38.14	12.64	35.45	30.22	45.55	54.00	8.45	Average

Remarks: 1. Emission Level= Antenna Factor + Cable Loss + Reading - Amp Factor
 2. The emission levels that are 20dB below the official limit are not reported.

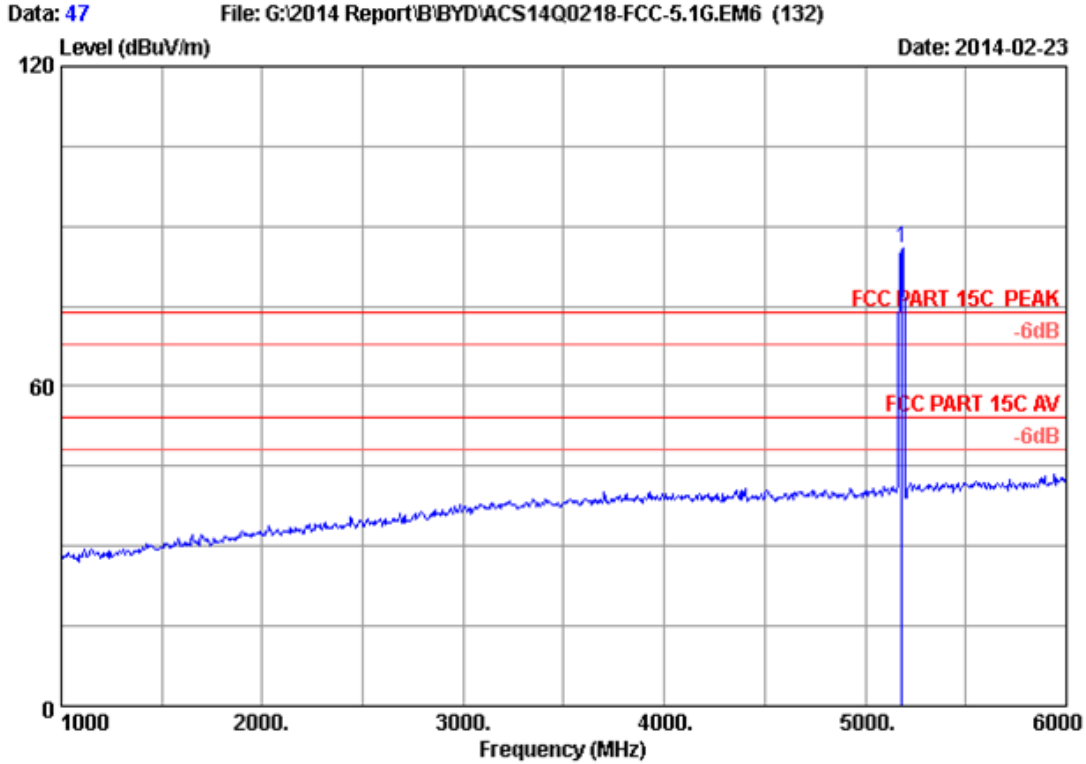

Site no. : 3m Chamber Data no. : 47
 Dis. / Ant. : 3m 2013 3115 (4580) Ant. pol. : VERTICAL
 Limit : FCC PART 15C PEAK
 Env. / Ins. : 24°C/56% Engineer : Leo-Li
 EUT : Notebook
 Power Rating : DC 19V From Adapter Input AC 120V/60Hz
 Test Mode : IEEE802.11nHT20 CH36 5180MHz Tx
 M/N : RZ09-0116

No.	Freq. (MHz)	Ant. Factor (dB/m)	Cable Loss (dB)	AMP factor (dB)	Reading (dBuV)	Emission Level (dBuV/m)	Limits (dBuV/m)	Margin (dB)	Remark
1	5180.000	33.49	8.95	35.70	79.01	85.75	74.00	-11.75	Peak

Remarks: 1. Emission Level= Antenna Factor + Cable Loss + Reading - Amp Factor
 2. The emission levels that are 20dB below the official limit are not reported.

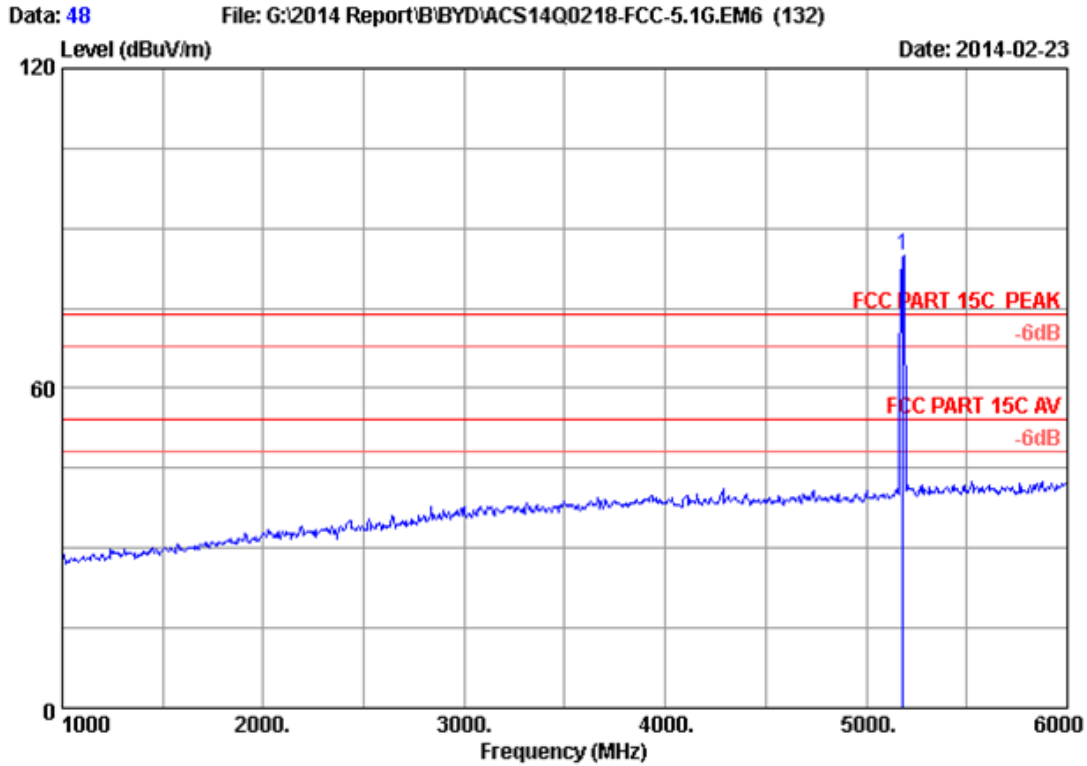

Site no. : 3m Chamber Data no. : 48
 Dis. / Ant. : 3m 2013 3115 (4580) Ant. pol. : HORIZONTAL
 Limit : FCC PART 15C PEAK
 Env. / Ins. : 24°C/56% Engineer : Leo-Li
 EUT : Notebook
 Power Rating : DC 19V From Adapter Input AC 120V/60Hz
 Test Mode : IEEE802.11nHT20 CH36 5180MHz Tx
 M/N : RZ09-0116

No.	Freq. (MHz)	Ant. Factor (dB/m)	Cable Loss (dB)	AMP factor (dB)	Reading (dBuV)	Emission Level (dBuV/m)	Limits (dBuV/m)	Margin (dB)	Remark
1	5180.000	33.49	8.95	35.70	78.28	85.02	74.00	-11.02	Peak

Remarks: 1. Emission Level= Antenna Factor + Cable Loss + Reading - Amp Factor
 2. The emission levels that are 20dB below the official limit are not reported.

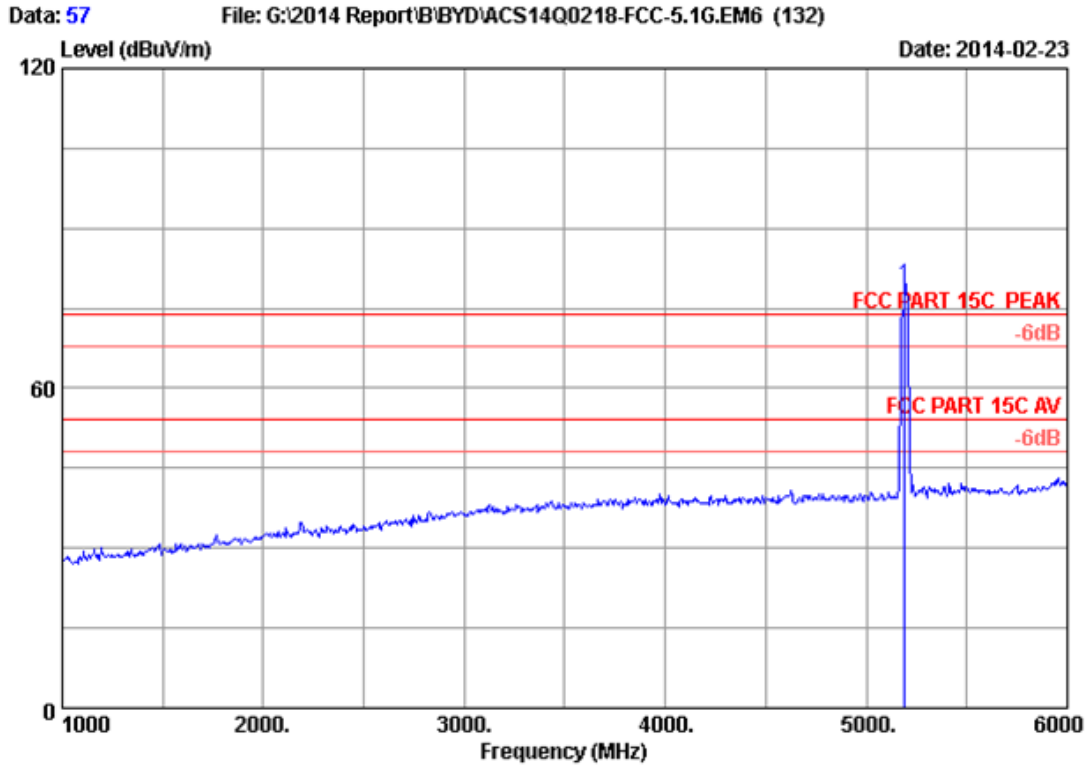

Site no. : 3m Chamber Data no. : 57
 Dis. / Ant. : 3m 2013 3115 (4580) Ant. pol. : HORIZONTAL
 Limit : FCC PART 15C PEAK
 Env. / Ins. : 24°C/56% Engineer : Leo-Li
 EUT : Notebook
 Power Rating : DC 19V From Adapter Input AC 120V/60Hz
 Test Mode : IEEE802.11nHT40 CH38 5190MHz Tx
 M/N : RZ09-0116

No.	Freq. (MHz)	Ant. Factor (dB/m)	Cable Loss (dB)	AMP factor (dB)	Reading (dBuV)	Emission Level (dBuV/m)	Limits (dBuV/m)	Margin (dB)	Remark
1	5190.000	33.50	8.96	35.70	72.62	79.38	74.00	-5.38	Peak

Remarks: 1. Emission Level= Antenna Factor + Cable Loss + Reading - Amp Factor
 2. The emission levels that are 20dB below the official limit are not reported.

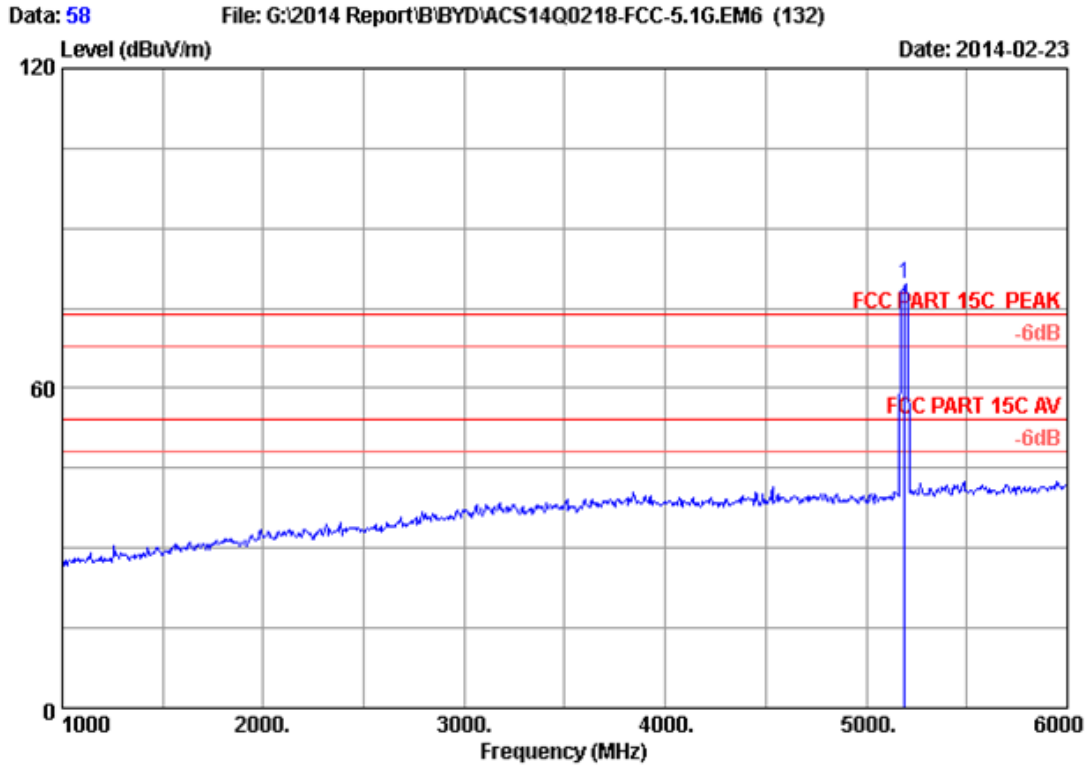

Site no. : 3m Chamber Data no. : 58
 Dis. / Ant. : 3m 2013 3115 (4580) Ant. pol. : VERTICAL
 Limit : FCC PART 15C PEAK
 Env. / Ins. : 24°C/56% Engineer : Leo-Li
 EUT : Notebook
 Power Rating : DC 19V From Adapter Input AC 120V/60Hz
 Test Mode : IEEE802.11nHT40 CH38 5190MHz Tx
 M/N : RZ09-0116

No.	Freq. (MHz)	Ant. Factor (dB/m)	Cable Loss (dB)	AMP factor (dB)	Reading (dBuV)	Emission Level (dBuV/m)	Limits (dBuV/m)	Margin (dB)	Remark
1	5190.000	33.50	8.96	35.70	72.64	79.40	74.00	-5.40	Peak

Remarks: 1. Emission Level= Antenna Factor + Cable Loss + Reading - Amp Factor
 2. The emission levels that are 20dB below the official limit are not reported.

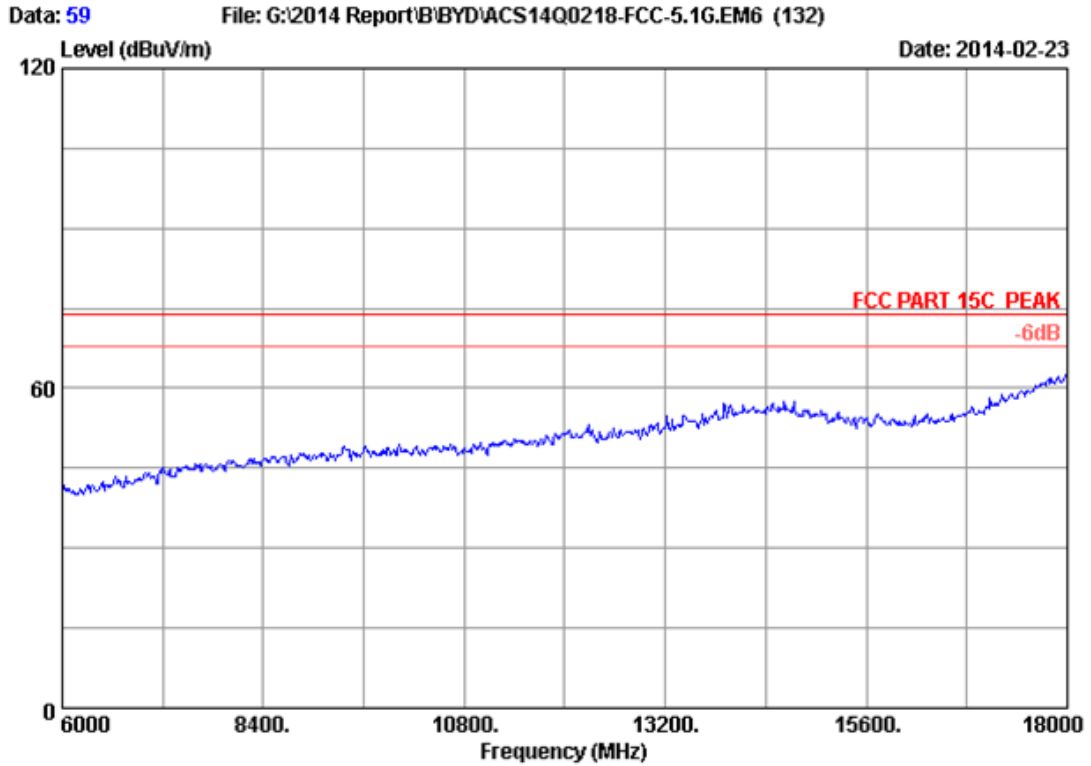

Site no. : 3m Chamber Data no. : 59
Dis. / Ant. : 3m 2013 3115 (4580) Ant. pol. : VERTICAL
Limit : FCC PART 15C PEAK
Env. / Ins. : 24°C/56% Engineer : Leo-Li
EUT : Notebook
Power Rating : DC 19V From Adapter Input AC 120V/60Hz
Test Mode : IEEE802.11nHT40 CH38 5190MHz Tx
M/N : RZ09-0116

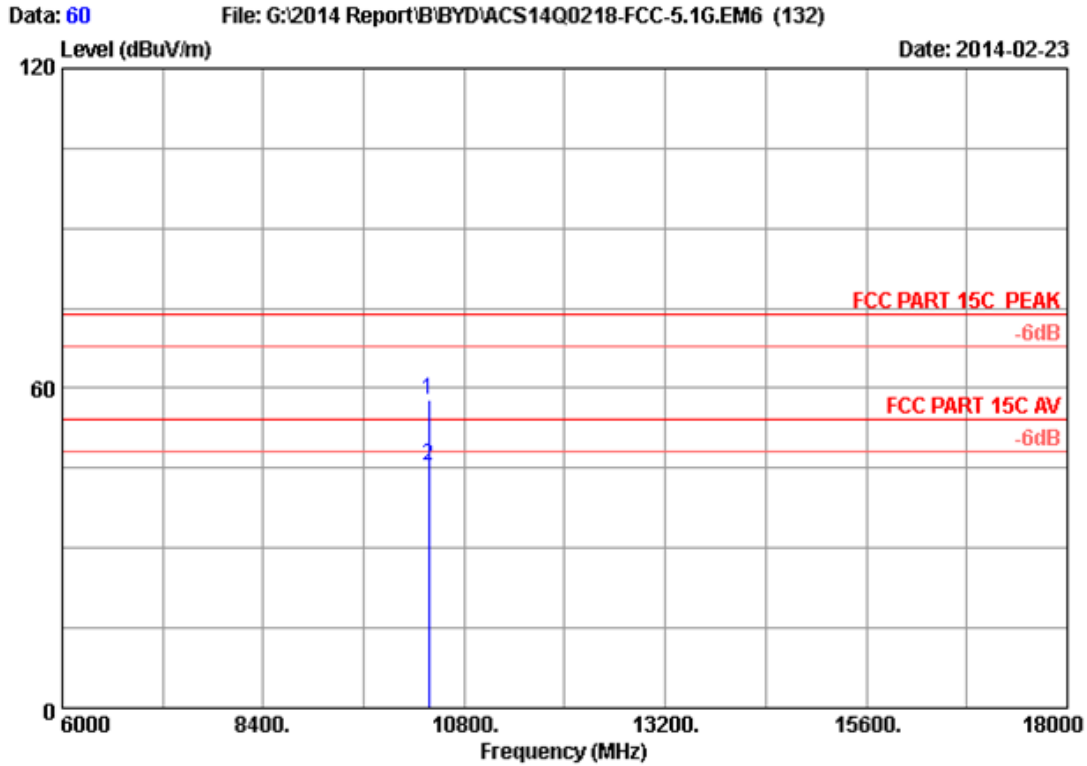

Site no. : 3m Chamber Data no. : 60
 Dis. / Ant. : 3m 2013 3115 (4580) Ant. pol. : VERTICAL
 Limit : FCC PART 15C PEAK
 Env. / Ins. : 24°C/56% Engineer : Leo-Li
 EUT : Notebook
 Power Rating : DC 19V From Adapter Input AC 120V/60Hz
 Test Mode : IEEE802.11nHT40 CH38 5190MHz Tx
 M/N : RZ09-0116

No.	Freq. (MHz)	Ant. Factor (dB/m)	Cable Loss (dB)	AMP factor (dB)	Reading (dBUV)	Emission Level (dBUV/m)	Limits (dBUV/m)	Margin (dB)	Remark
1	10380.000	38.15	12.65	35.44	42.42	57.78	74.00	16.22	Peak
2	10380.000	38.15	12.65	35.44	30.14	45.50	54.00	8.50	Average

Remarks: 1. Emission Level= Antenna Factor + Cable Loss + Reading - Amp Factor
 2. The emission levels that are 20dB below the official limit are not reported.

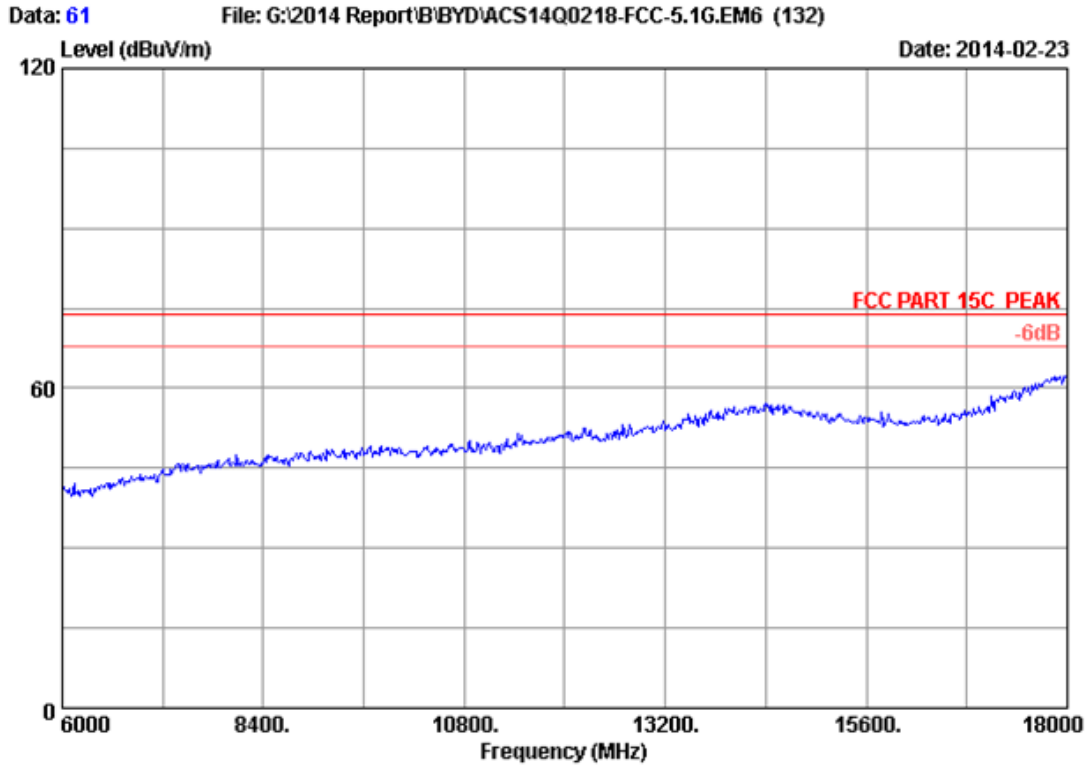

Site no. : 3m Chamber Data no. : 61
Dis. / Ant. : 3m 2013 3115 (4580) Ant. pol. : HORIZONTAL
Limit : FCC PART 15C PEAK
Env. / Ins. : 24°C/56% Engineer : Leo-Li
EUT : Notebook
Power Rating : DC 19V From Adapter Input AC 120V/60Hz
Test Mode : IEEE802.11nHT40 CH38 5190MHz Tx
M/N : RZ09-0116

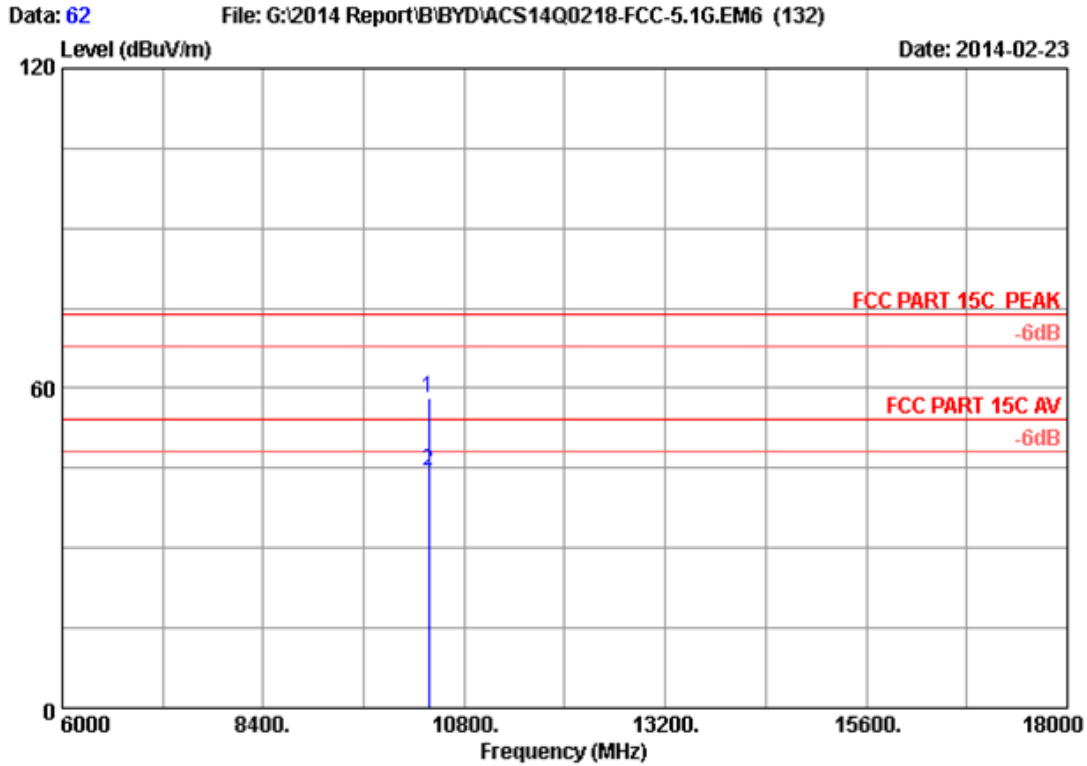

Site no. : 3m Chamber Data no. : 62
 Dis. / Ant. : 3m 2013 3115 (4580) Ant. pol. : HORIZONTAL
 Limit : FCC PART 15C PEAK
 Env. / Ins. : 24°C/56% Engineer : Leo-Li
 EUT : Notebook
 Power Rating : DC 19V From Adapter Input AC 120V/60Hz
 Test Mode : IEEE802.11nHT40 CH38 5190MHz Tx
 M/N : RZ09-0116

No.	Freq. (MHz)	Ant. Factor (dB/m)	Cable Loss (dB)	AMP factor (dB)	Reading (dBUV)	Emission Level (dBUV/m)	Limits (dBUV/m)	Margin (dB)	Remark
1	10380.000	38.15	12.65	35.44	42.82	58.18	74.00	15.82	Peak
2	10380.000	38.15	12.65	35.44	29.04	44.40	54.00	9.60	Average

Remarks: 1. Emission Level= Antenna Factor + Cable Loss + Reading - Amp Factor
 2. The emission levels that are 20dB below the official limit are not reported.

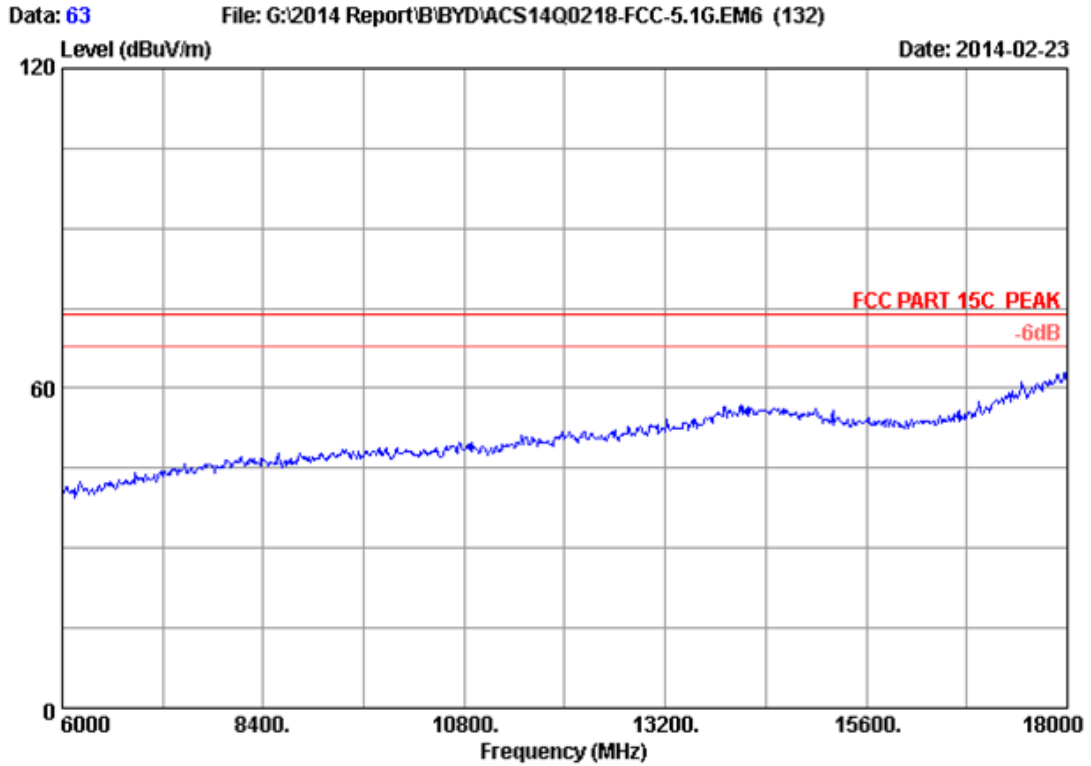

Site no. : 3m Chamber Data no. : 63
Dis. / Ant. : 3m 2013 3115 (4580) Ant. pol. : HORIZONTAL
Limit : FCC PART 15C PEAK
Env. / Ins. : 24°C/56% Engineer : Leo-Li
EUT : Notebook
Power Rating : DC 19V From Adapter Input AC 120V/60Hz
Test Mode : IEEE802.11nHT40 CH46 5230MHz Tx
M/N : RZ09-0116

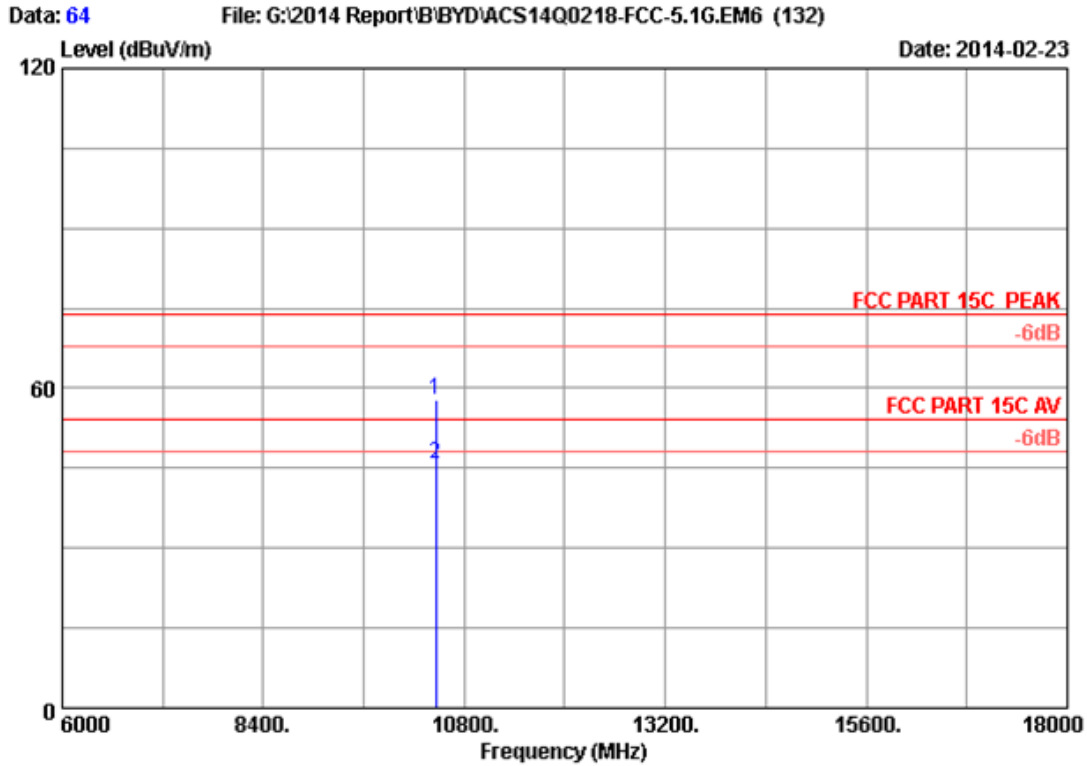

Site no. : 3m Chamber Data no. : 64
 Dis. / Ant. : 3m 2013 3115 (4580) Ant. pol. : HORIZONTAL
 Limit : FCC PART 15C PEAK
 Env. / Ins. : 24°C/56% Engineer : Leo-Li
 EUT : Notebook
 Power Rating : DC 19V From Adapter Input AC 120V/60Hz
 Test Mode : IEEE802.11nHT40 CH46 5230MHz Tx
 M/N : RZ09-0116

No.	Freq. (MHz)	Ant. Factor (dB/m)	Cable Loss (dB)	AMP factor (dB)	Reading (dBUV)	Emission Level (dBUV/m)	Limits (dBUV/m)	Margin (dB)	Remark
1	10460.000	38.18	12.69	35.43	42.54	57.98	74.00	16.02	Peak
2	10460.000	38.18	12.69	35.43	30.42	45.86	54.00	8.14	Average

Remarks: 1. Emission Level= Antenna Factor + Cable Loss + Reading - Amp Factor
 2. The emission levels that are 20dB below the official limit are not reported.

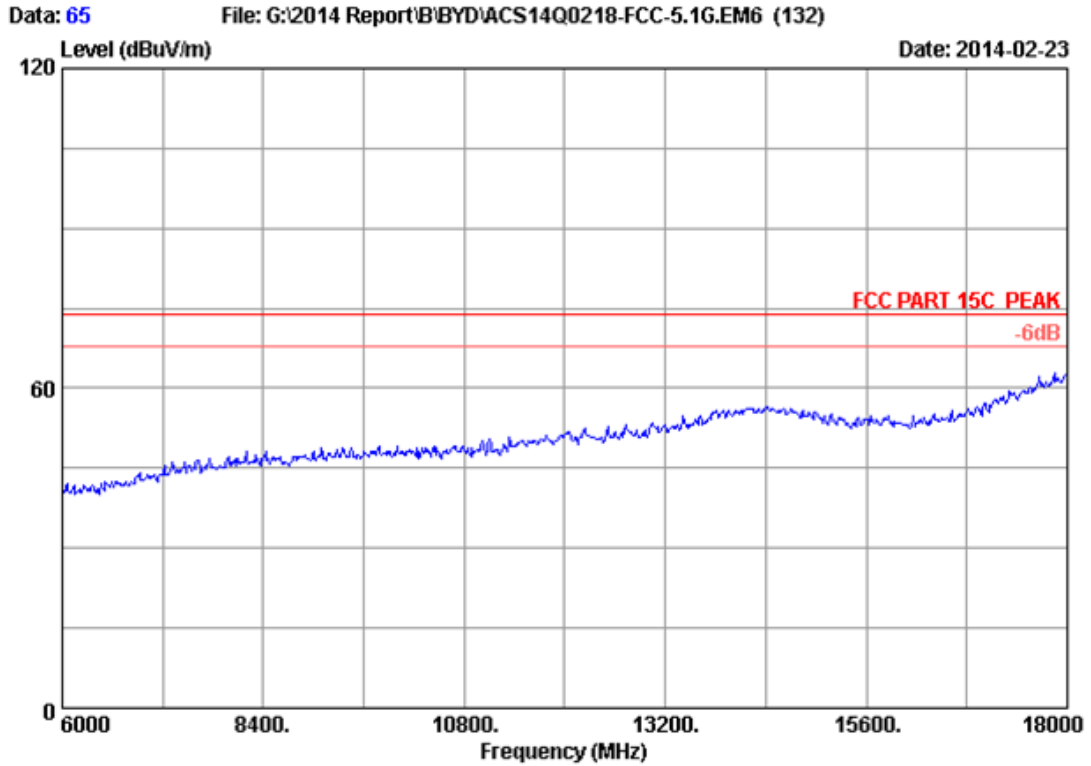

Site no. : 3m Chamber Data no. : 65
Dis. / Ant. : 3m 2013 3115 (4580) Ant. pol. : VERTICAL
Limit : FCC PART 15C PEAK
Env. / Ins. : 24°C/56% Engineer : Leo-Li
EUT : Notebook
Power Rating : DC 19V From Adapter Input AC 120V/60Hz
Test Mode : IEEE802.11nHT40 CH46 5230MHz Tx
M/N : RZ09-0116

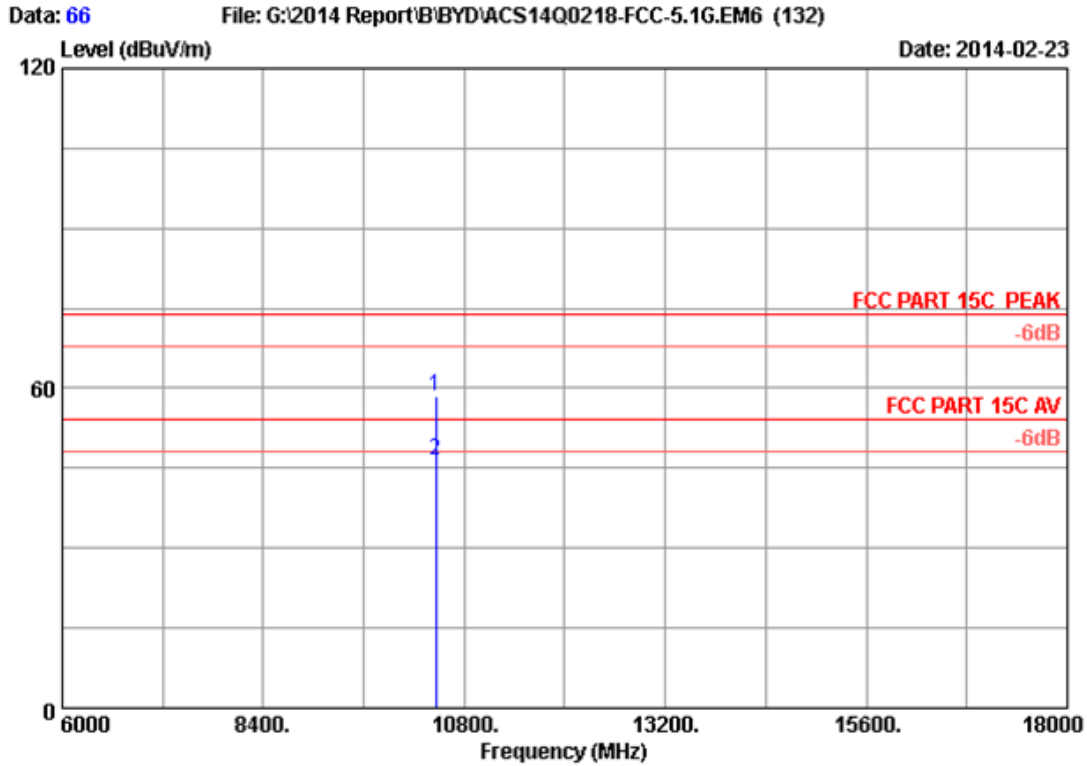

Site no. : 3m Chamber Data no. : 66
 Dis. / Ant. : 3m 2013 3115 (4580) Ant. pol. : VERTICAL
 Limit : FCC PART 15C PEAK
 Env. / Ins. : 24°C/56% Engineer : Leo-Li
 EUT : Notebook
 Power Rating : DC 19V From Adapter Input AC 120V/60Hz
 Test Mode : IEEE802.11nHT40 CH46 5230MHz Tx
 M/N : RZ09-0116

No.	Freq. (MHz)	Ant. Factor (dB/m)	Cable Loss (dB)	AMP factor (dB)	Reading (dBUV)	Emission Level (dBUV/m)	Limits (dBUV/m)	Margin (dB)	Remark
1	10460.000	38.18	12.69	35.43	43.10	58.54	74.00	15.46	Peak
2	10460.000	38.18	12.69	35.43	31.09	46.53	54.00	7.47	Average

Remarks: 1. Emission Level= Antenna Factor + Cable Loss + Reading - Amp Factor
 2. The emission levels that are 20dB below the official limit are not reported.

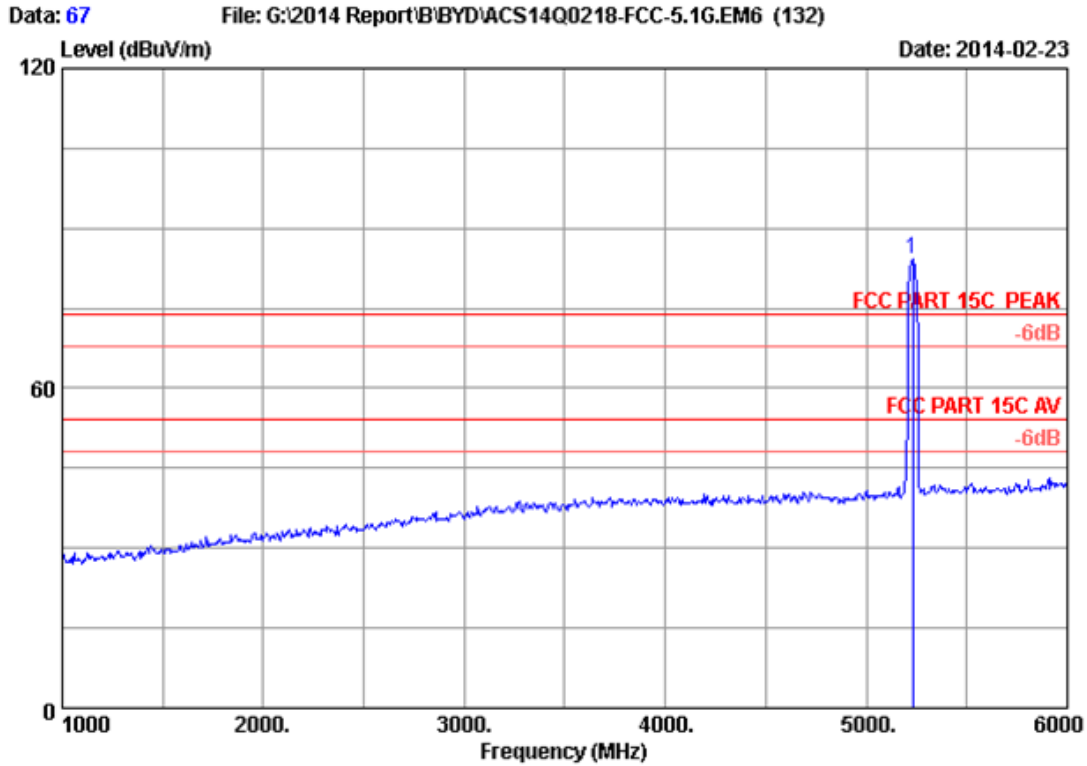

Site no. : 3m Chamber Data no. : 67
 Dis. / Ant. : 3m 2013 3115 (4580) Ant. pol. : VERTICAL
 Limit : FCC PART 15C PEAK
 Env. / Ins. : 24°C/56% Engineer : Leo-Li
 EUT : Notebook
 Power Rating : DC 19V From Adapter Input AC 120V/60Hz
 Test Mode : IEEE802.11nHT40 CH46 5230MHz Tx
 M/N : RZ09-0116

No.	Freq. (MHz)	Ant. Factor (dB/m)	Cable Loss (dB)	AMP factor (dB)	Reading (dBuV)	Emission Level (dBuV/m)	Limits (dBuV/m)	Margin (dB)	Remark
1	5230.000	33.57	9.01	35.70	77.29	84.17	74.00	-10.17	Peak

Remarks: 1. Emission Level= Antenna Factor + Cable Loss + Reading - Amp Factor
 2. The emission levels that are 20dB below the official limit are not reported.

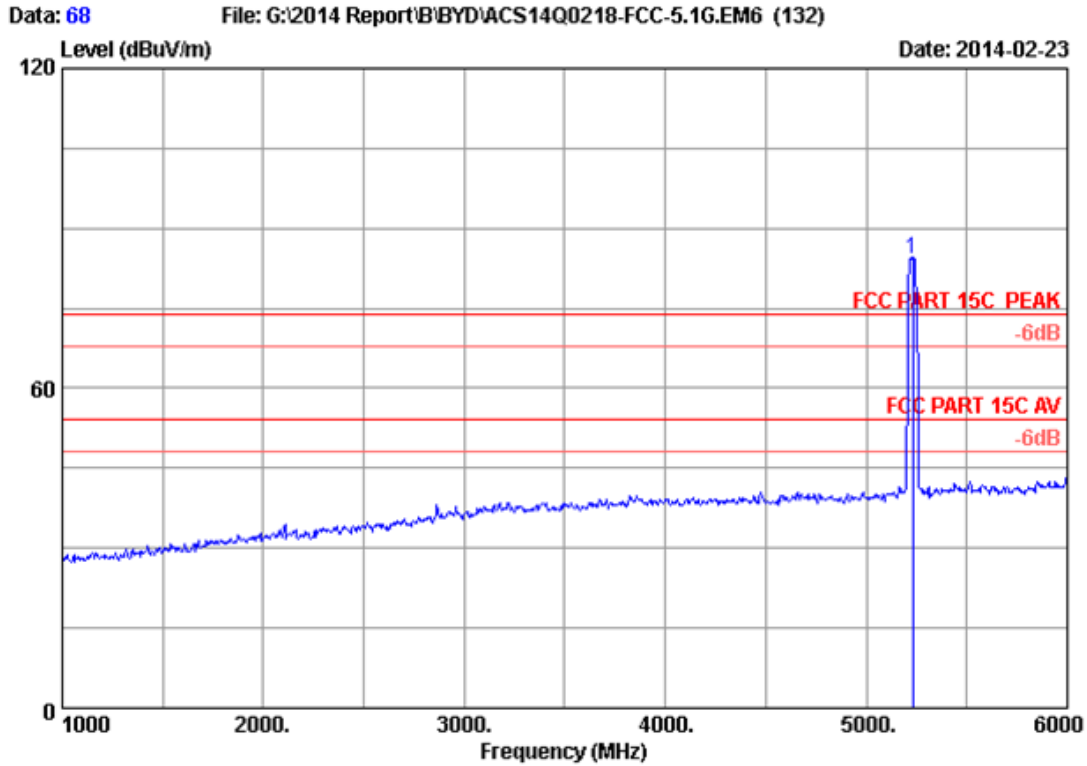

Site no. : 3m Chamber Data no. : 68
 Dis. / Ant. : 3m 2013 3115 (4580) Ant. pol. : HORIZONTAL
 Limit : FCC PART 15C PEAK
 Env. / Ins. : 24°C/56% Engineer : Leo-Li
 EUT : Notebook
 Power Rating : DC 19V From Adapter Input AC 120V/60Hz
 Test Mode : IEEE802.11nHT40 CH46 5230MHz Tx
 M/N : RZ09-0116

No.	Freq. (MHz)	Ant. Factor (dB/m)	Cable Loss (dB)	AMP factor (dB)	Reading (dBuV)	Emission Level (dBuV/m)	Limits (dBuV/m)	Margin (dB)	Remark
1	5230.000	33.57	9.01	35.70	77.30	84.18	74.00	-10.18	Peak

Remarks: 1. Emission Level= Antenna Factor + Cable Loss + Reading - Amp Factor
 2. The emission levels that are 20dB below the official limit are not reported.

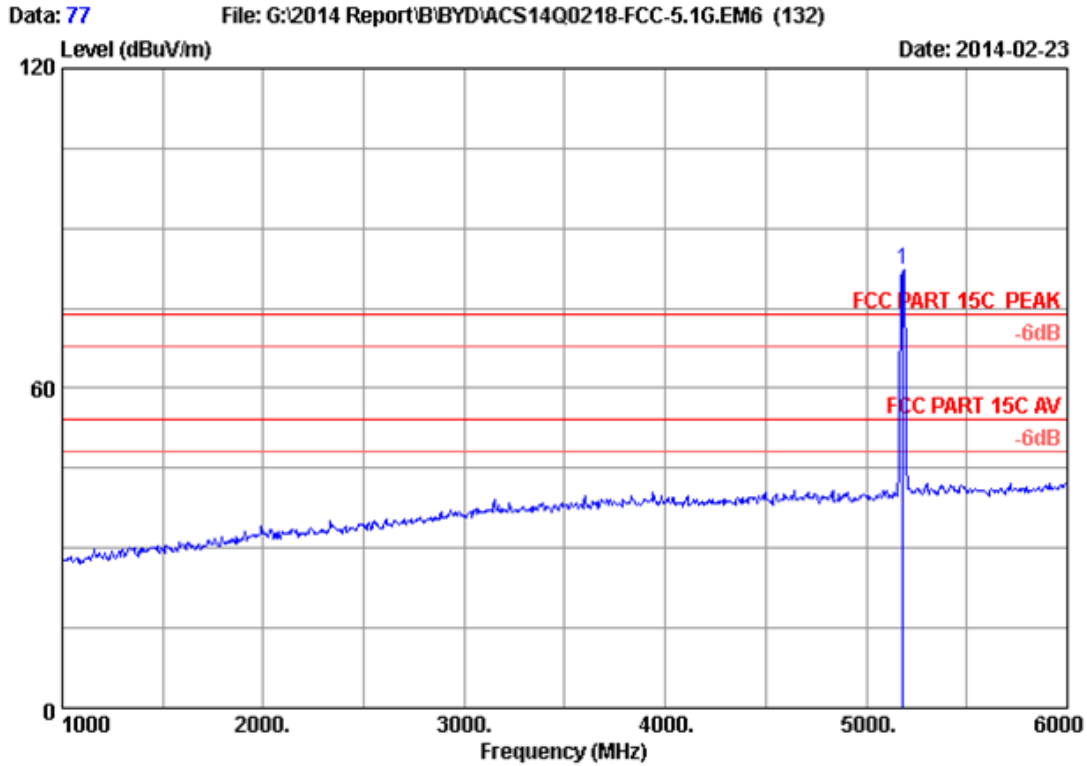

Site no. : 3m Chamber Data no. : 77
 Dis. / Ant. : 3m 2013 3115 (4580) Ant. pol. : HORIZONTAL
 Limit : FCC PART 15C PEAK
 Env. / Ins. : 24°C/56% Engineer : Leo-Li
 EUT : Notebook
 Power Rating : DC 19V From Adapter Input AC 120V/60Hz
 Test Mode : IEEE802.11ac VHT20 CH36 5180MHz Tx
 M/N : RZ09-0116

No.	Freq. (MHz)	Ant. Factor (dB/m)	Cable Loss (dB)	AMP factor (dB)	Reading (dBUV)	Emission Level (dBUV/m)	Limits (dBUV/m)	Margin (dB)	Remark
1	5180.000	33.49	8.95	35.70	75.49	82.23	74.00	-8.23	Peak

Remarks: 1. Emission Level= Antenna Factor + Cable Loss + Reading - Amp Factor
 2. The emission levels that are 20dB below the official limit are not reported.

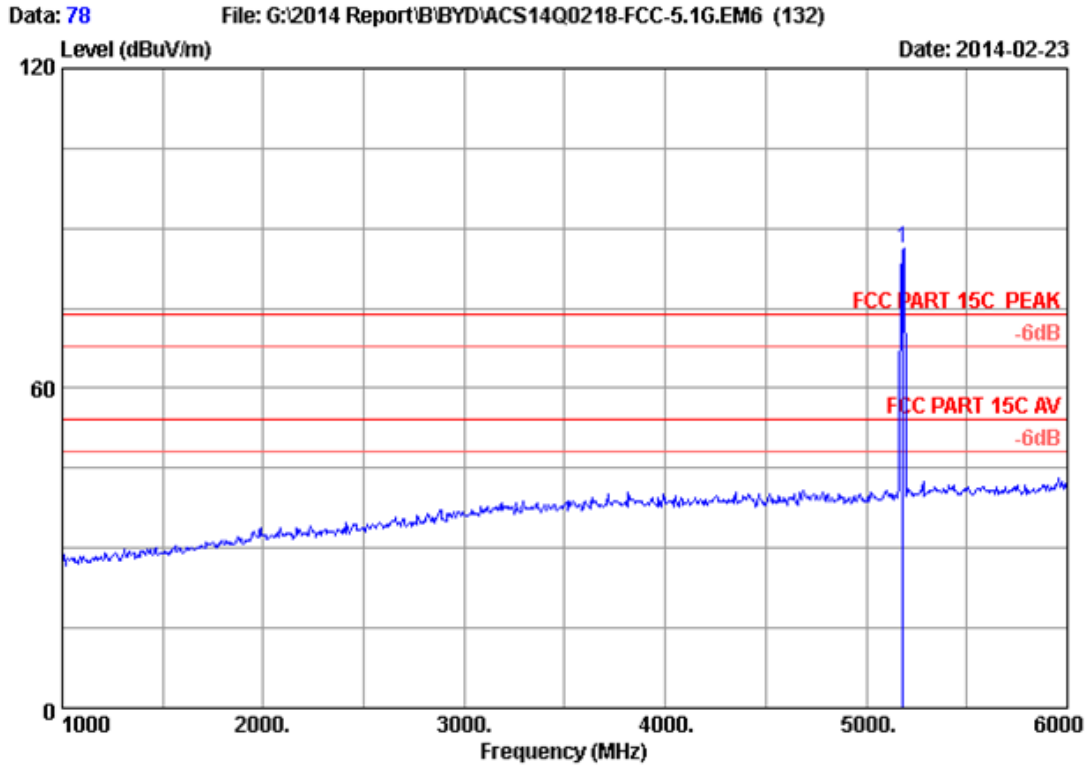

Site no. : 3m Chamber Data no. : 78
 Dis. / Ant. : 3m 2013 3115 (4580) Ant. pol. : VERTICAL
 Limit : FCC PART 15C PEAK
 Env. / Ins. : 24°C/56% Engineer : Leo-Li
 EUT : Notebook
 Power Rating : DC 19V From Adapter Input AC 120V/60Hz
 Test Mode : IEEE802.11ac VHT20 CH36 5180MHz Tx
 M/N : RZ09-0116

No.	Freq. (MHz)	Ant. Factor (dB/m)	Cable Loss (dB)	AMP factor (dB)	Reading (dBuV)	Emission Level (dBuV/m)	Limits (dBuV/m)	Margin (dB)	Remark
1	5180.000	33.49	8.95	35.70	79.41	86.15	74.00	-12.15	Peak

Remarks: 1. Emission Level= Antenna Factor + Cable Loss + Reading - Amp Factor
 2. The emission levels that are 20dB below the official limit are not reported.

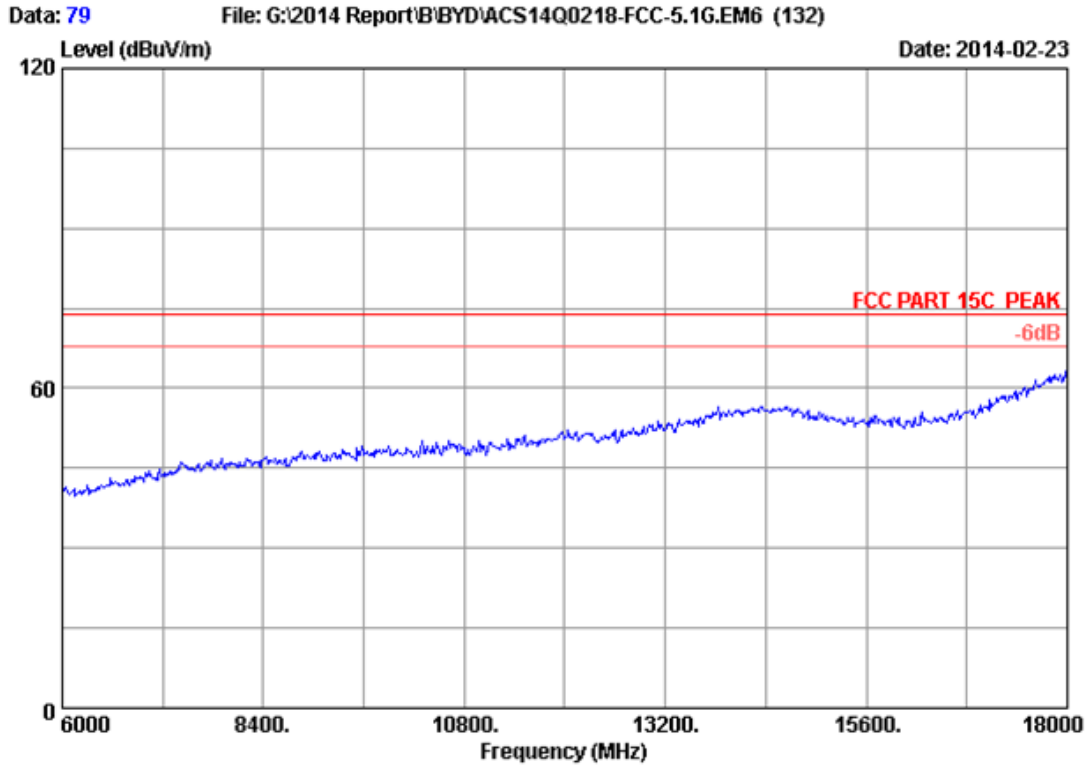

Site no. : 3m Chamber Data no. : 79
Dis. / Ant. : 3m 2013 3115 (4580) Ant. pol. : VERTICAL
Limit : FCC PART 15C PEAK
Env. / Ins. : 24°C/56% Engineer : Leo-Li
EUT : Notebook
Power Rating : DC 19V From Adapter Input AC 120V/60Hz
Test Mode : IEEE802.11ac VHT20 CH36 5180MHz Tx
M/N : RZ09-0116

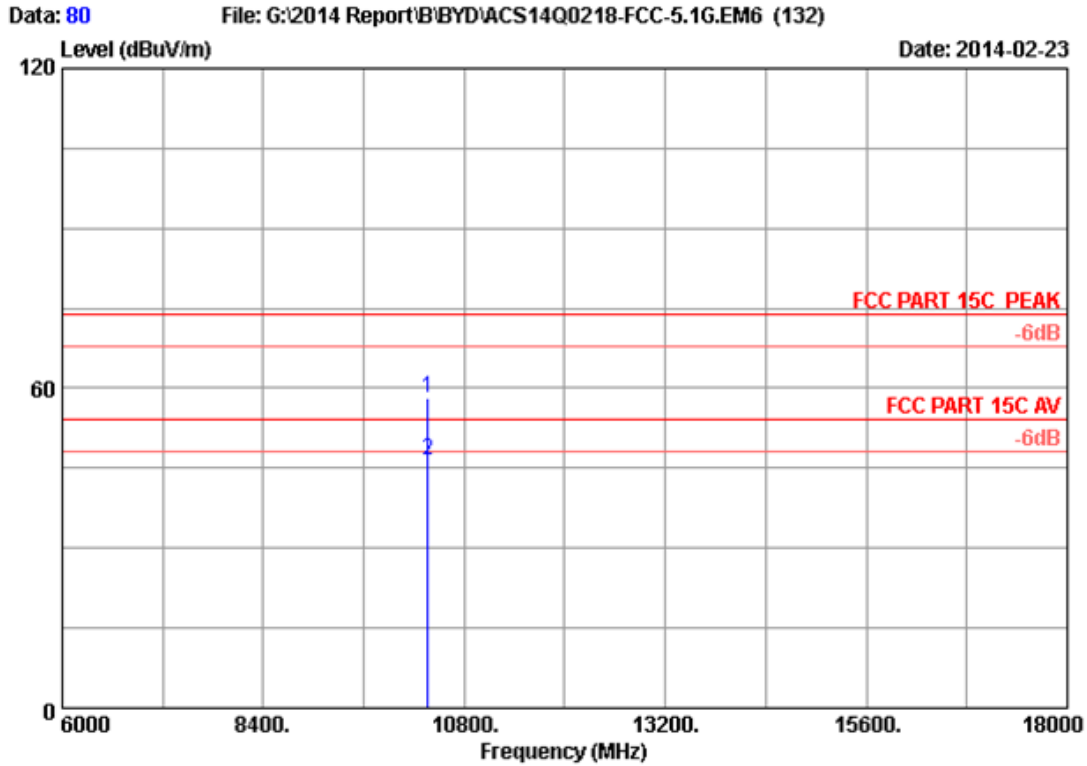

Site no. : 3m Chamber Data no. : 80
 Dis. / Ant. : 3m 2013 3115 (4580) Ant. pol. : VERTICAL
 Limit : FCC PART 15C PEAK
 Env. / Ins. : 24°C/56% Engineer : Leo-Li
 EUT : Notebook
 Power Rating : DC 19V From Adapter Input AC 120V/60Hz
 Test Mode : IEEE802.11ac VHT20 CH36 5180MHz Tx
 M/N : RZ09-0116

No.	Freq. (MHz)	Ant. Factor (dB/m)	Cable Loss (dB)	AMP factor (dB)	Reading (dBUV)	Emission Level (dBUV/m)	Limits (dBUV/m)	Margin (dB)	Remark
1	10360.000	38.14	12.64	35.45	42.87	58.20	74.00	15.80	Peak
2	10360.000	38.14	12.64	35.45	31.16	46.49	54.00	7.51	Average

Remarks: 1. Emission Level= Antenna Factor + Cable Loss + Reading - Amp Factor
 2. The emission levels that are 20dB below the official limit are not reported.

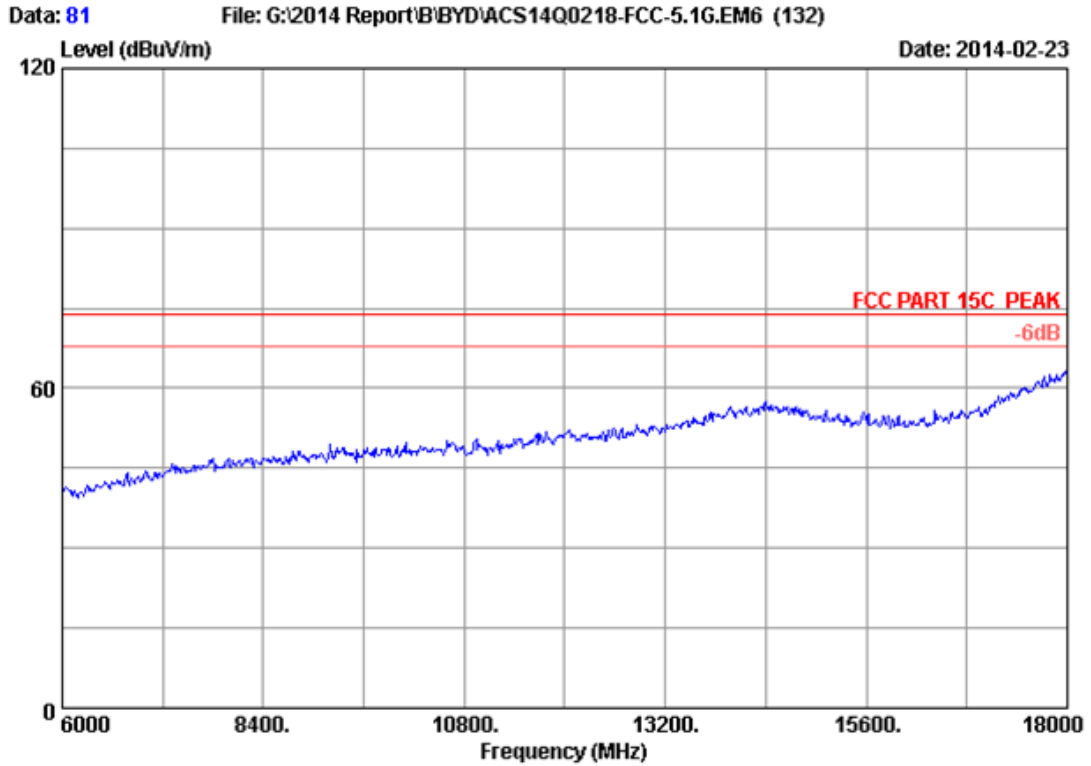

Site no. : 3m Chamber Data no. : 81
Dis. / Ant. : 3m 2013 3115 (4580) Ant. pol. : HORIZONTAL
Limit : FCC PART 15C PEAK
Env. / Ins. : 24°C/56% Engineer : Leo-Li
EUT : Notebook
Power Rating : DC 19V From Adapter Input AC 120V/60Hz
Test Mode : IEEE802.11ac VHT20 CH36 5180MHz Tx
M/N : RZ09-0116

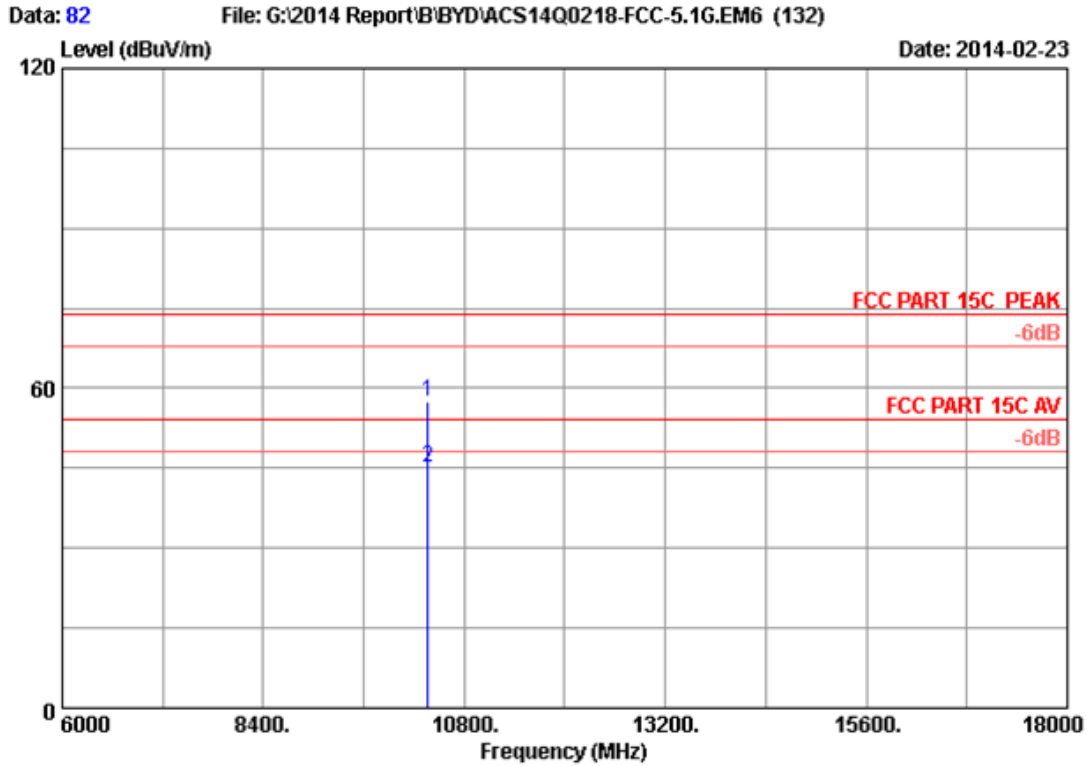

Site no. : 3m Chamber Data no. : 82
 Dis. / Ant. : 3m 2013 3115 (4580) Ant. pol. : HORIZONTAL
 Limit : FCC PART 15C PEAK
 Env. / Ins. : 24°C/56% Engineer : Leo-Li
 EUT : Notebook
 Power Rating : DC 19V From Adapter Input AC 120V/60Hz
 Test Mode : IEEE802.11ac VHT20 CH36 5180MHz Tx
 M/N : RZ09-0116

No.	Freq. (MHz)	Ant. Factor (dB/m)	Cable Loss (dB)	AMP factor (dB)	Reading (dBUV)	Emission Level (dBUV/m)	Limits (dBUV/m)	Margin (dB)	Remark
1	10360.000	38.14	12.64	35.45	42.09	57.42	74.00	16.58	Peak
2	10360.000	38.14	12.64	35.45	29.92	45.25	54.00	8.75	Average

Remarks: 1. Emission Level= Antenna Factor + Cable Loss + Reading - Amp Factor
 2. The emission levels that are 20dB below the official limit are not reported.

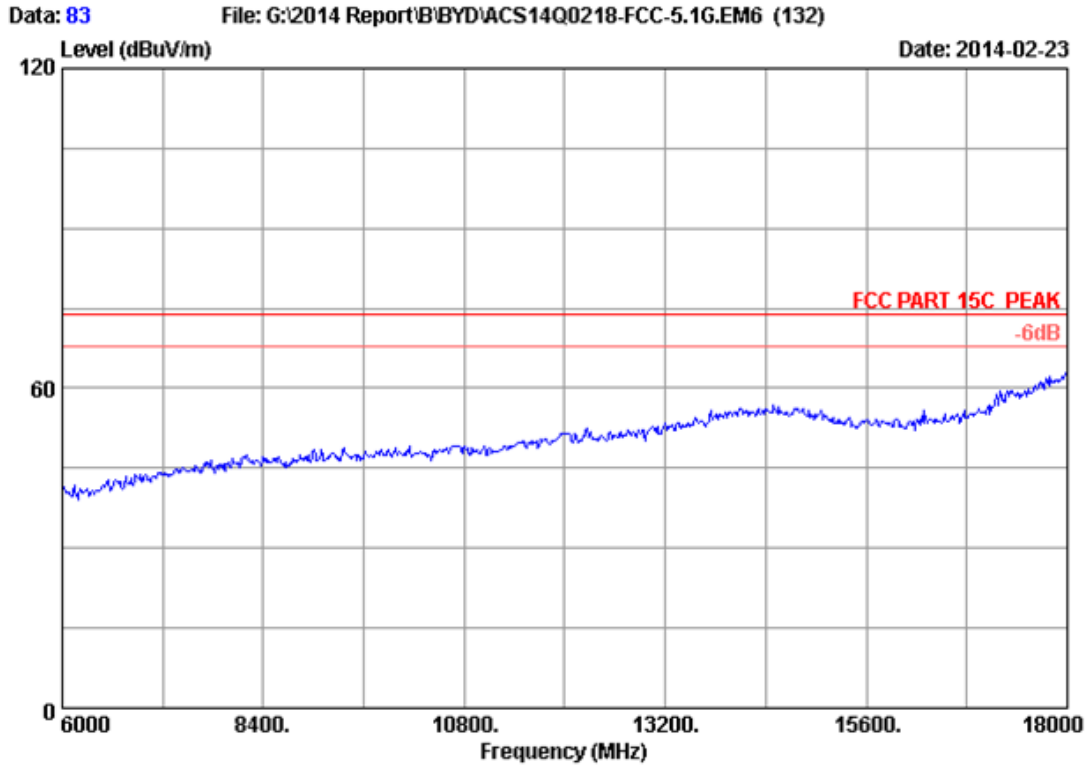

Site no. : 3m Chamber Data no. : 83
Dis. / Ant. : 3m 2013 3115 (4580) Ant. pol. : HORIZONTAL
Limit : FCC PART 15C PEAK
Env. / Ins. : 24°C/56% Engineer : Leo-Li
EUT : Notebook
Power Rating : DC 19V From Adapter Input AC 120V/60Hz
Test Mode : IEEE802.11ac VHT20 CH40 5200MHz Tx
M/N : RZ09-0116

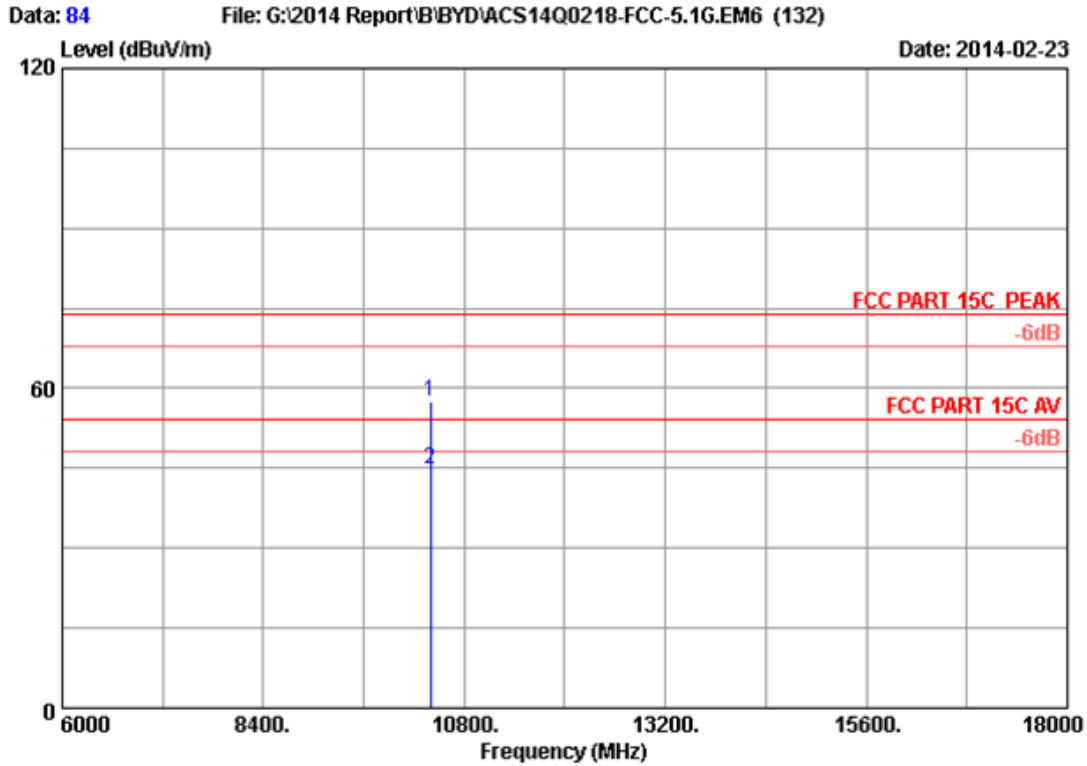

Site no. : 3m Chamber Data no. : 84
 Dis. / Ant. : 3m 2013 3115 (4580) Ant. pol. : HORIZONTAL
 Limit : FCC PART 15C PEAK
 Env. / Ins. : 24°C/56% Engineer : Leo-Li
 EUT : Notebook
 Power Rating : DC 19V From Adapter Input AC 120V/60Hz
 Test Mode : IEEE802.11ac VHT20 CH40 5200MHz Tx
 M/N : RZ09-0116

No.	Freq. (MHz)	Ant. Factor (dB/m)	Cable Loss (dB)	AMP factor (dB)	Reading (dBUV)	Emission Level (dBUV/m)	Limits (dBUV/m)	Margin (dB)	Remark
1	10400.000	38.16	12.66	35.44	42.18	57.56	74.00	16.44	Peak
2	10400.000	38.16	12.66	35.44	29.48	44.86	54.00	9.14	Average

Remarks: 1. Emission Level= Antenna Factor + Cable Loss + Reading - Amp Factor
 2. The emission levels that are 20dB below the official limit are not reported.

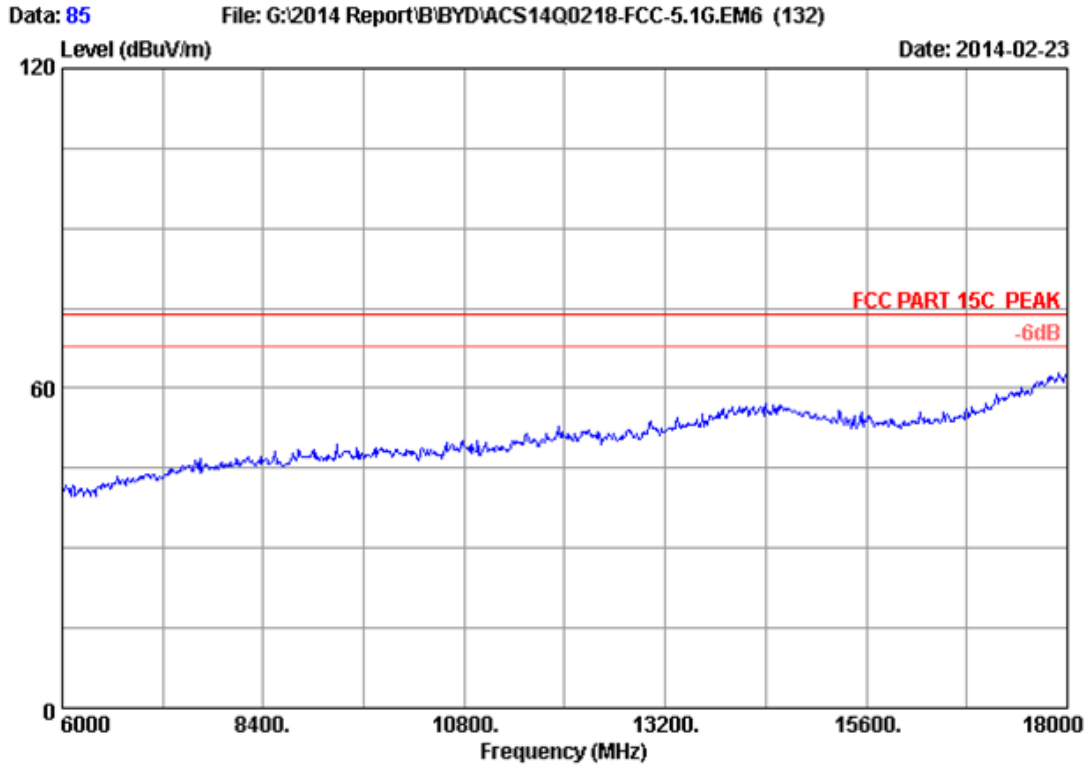

Site no. : 3m Chamber Data no. : 85
Dis. / Ant. : 3m 2013 3115 (4580) Ant. pol. : VERTICAL
Limit : FCC PART 15C PEAK
Env. / Ins. : 24°C/56% Engineer : Leo-Li
EUT : Notebook
Power Rating : DC 19V From Adapter Input AC 120V/60Hz
Test Mode : IEEE802.11ac VHT20 CH40 5200MHz Tx
M/N : RZ09-0116