



FCC Dynamic Frequency Selection Test Report

for

Razer Inc.

Notebook

Model No.: RZ09-0116

FCC ID: RWO-RZ090116

Brand: Razer

Prepared for : Razer Inc.

2035 Corte Del Nogal, Suite 101, Carlsbad CA
92011, USA

Prepared By : Audix Technology (Shenzhen) Co., Ltd.

No. 6, Ke Feng Rd., 52 Block,
Shenzhen Science & Industrial Park,
Nantou, Shenzhen, Guangdong, China

Tel: (0755) 26639496

Report Number : ACS-F14091

Date of Test : Mar.03, 2014

Date of Report ; Mar.19, 2014

TABLE OF CONTENTS

<u>Description</u>	<u>Page</u>
TEST REPORT VERIFICATION.....	3
1.SUMMARY OF MEASUREMENTS AND RESULTS	4
2.GENERAL INFORMATION.....	5
2.1.Description of Device (EUT).....	5
2.2.Support Equipment.....	7
2.3.Test Channel.....	7
2.4.Description of Test Facility.....	8
2.5.Measurement Uncertainty	8
3.TEST EQUIPMENT.....	9
4.WORKING MODES AND REQUIREMENT TEST ITEM.....	10
4.1.Applicability of DFS Requirements Prior To Use A Channel	10
4.2.Applicability of DFS Requirements During Normal Operation	10
5.DFS DETECTION THRESHOLOS AND RADAR TEST WAVEFORMS	11
5.1.Interference Threshold Value, Master or Client Incorporating In-Service Monitoring	11
5.2.Radar Test Waveform Minimum Step	11
5.3.Short Pulse Radar Test Waveforms	11
5.4.Long Pulse Radar Test Waveforms.....	12
5.5.Frequency Hopping Pulse Radar Test Waveforms	14
5.6.Conducted Calibration Setup	16
5.7.Radar Waveform Calibration Procedure.....	16
5.8.Calibration Deviation.....	16
5.9.Radar Waveform Calibration Result.....	17
6.TEST SETUP AND TEST RESULT.....	20
6.1.Test Setup.....	20
6.2.Channel Move Time, Channel Closing Transmission Time Measurement	24
7.PHOTOGRAPHS OF MEASUREMENT.....	38

TEST REPORT VERIFICATION

Applicant : Razer Inc.
Manufacturer : Razer Inc.
FCC ID : RWO-RZ090116
EUT Description : Notebook
(A) Model No. : RZ09-0116
(B) Serial No. : N/A
(C) Brand : Razer
(D) Power Supply : DC 19V
(E) Test Voltage : AC 120V, 60Hz (Via Adapter)

Measurement Standards Used:

FCC RULES AND REGULATIONS PART 15 Subpart E, Oct. 2012
(FCC CFR 47 Part 15E, §15.407)

The device described above was tested by Audix Technology (Shenzhen) Co., Ltd. to determine the maximum emission levels emanating from the device. The maximum emission levels were compared to the FCC Part 15 subpart E limits.

The measurement results are contained in this test report and Audix Technology (Shenzhen) Co., Ltd. is assumed full responsibility for the accuracy and completeness of these measurements. Also, this report shows that the EUT to be technically compliant with the requirements of FCC Part 15 standards.

This report applies to above tested sample only. This report shall not be reproduced in part without written approval of Audix Technology (Shenzhen) Co., Ltd.

Date of Test: Mar.03, 2014

Date of Report: Mar.19, 2014

Producer: Aimee Xiang

Reviewed: Sunny Lu

 (Aimee Xiang / Assistant)
Audix Technology (Shenzhen) Co., Ltd.
EMC 部門報告專用章

(Sunny Lu / Assistant Manager)

Stamp only for EMC Dept. Report

Signature: David Jin 3.19
(David Jin / Manager)

1. SUMMARY OF MEASUREMENTS AND RESULTS

The EUT has been tested according to the applicable standards as referenced below.

Description of Test Item	Results
Channel Availability Check Time	N/A
Channel Move Time	PASS
Non-Occupancy Period	PASS
Channel Closing Transmission Time	PASS
U-NII Detection Bandwidth	N/A
N/A is an abbreviation for Not Applicable, sine the product is client without radar detection function	

2. GENERAL INFORMATION

2.1. Description of Device (EUT)

Product	Notebook
Model Number	RZ09-0116
Serial Number	N/A
Brand Name	Razer
Applicant	Razer Inc. 2035 Corte Del Nogal, Suite 101, Carlsbad CA 92011, USA
Manufacturer	Razer Inc. 2035 Corte Del Nogal, Suite 101, Carlsbad CA 92011, USA
FCC ID	RWO-RZ090116
Fundamental Range	<p>802.11b/g: 2412MHz ~ 2462MHz 802.11a: 5180MHz ~ 5240MHz (UNII Band I) and 5260MHz ~ 5320MHz (UNII Band II) and 5500MHz ~ 5700MHz (UNII Band III) and 5745MHz ~ 5825MHz (UNII Band IV) UNII Band II & III (DFS, Slave without radar detection function) IEEE 802.11ac VHT20: 5180MHz—5240MHz, 5260MHz—5320MHz, 5500MHz—5700MHz; 5745MHz—5825MHz IEEE 802.11ac VHT40: 5190MHz—5230MHz, 5270MHz—5310MHz, 5510MHz—5710MHz; 5755MHz—5795MHz IEEE 802.11ac VHT80: 5210MHz, 5290MHz, 5530MHz—5690MHz; 5775MHz 802.11n-HT20: 2412MHz ~ 2462MHz and 5180MHz ~ 5240MHz (UNII Band I) and 5260MHz ~ 5320MHz (UNII Band II) and 5500MHz ~ 5700MHz (UNII Band III) and 5745MHz ~ 5825MHz (UNII Band IV) UNII Band II & III (DFS, Slave without radar detection function) 802.11n-HT40: 2422MHz ~ 2452MHz and 5190MHz ~ 5230MHz (UNII Band I) and 5270MHz ~ 5310MHz (UNII Band II) and 5510MHz ~ 5670MHz (UNII Band III) and 5755MHz ~ 5795MHz (UNII Band IV) UNII Band II & III (DFS, Slave without radar detection function) Bluetooth 4.0: 2402MHz ~ 2480MHz</p>

Radio Technology	<p>802.11b: DSSS Modulation (DBPSK/DQPSK/CCK) 802.11g: OFDM Modulation (BPSK/QPSK/16QAM/64QAM) 802.11a: OFDM Modulation (BPSK/QPSK/16QAM/64QAM) 802.11ac: OFDM Modulation (BPSK/QPSK/16QAM/64QAM, 256QAM) 802.11n: OFDM Modulation (MIMO) (BPSK/QPSK/16QAM/64QAM) Bluetooth: FHSS (GFSK,π/4DQPSK, 8-DPSK)</p>
Data Transfer Rate	<p>802.11b: 1/2/5.5/11Mbps 802.11a/g: 6/9/12/18/24/36/48/54Mbps 802.11n: up to 300Mbps Bluetooth: 1/2/3Mbps</p>
Antenna Gain	<p>Antenna A: IFA Antenna, 2.4GHz: 2.89dBi(max) 5GHz: 3.96dBi(max) Antenna B: IFA Antenna, 2.4GHz: 2.7dBi(max) 5GHz: 4.59dBi(max)</p>
Adapter #1	<p>Razer Systems Pte Ltd. M/N: RC30-0083 I/P: 100-240V~, 2A, 50/60Hz O/P: DC 19V, 7.9A</p>
Adapter #2	<p>Razer Inc. M/N: RC30-0099 I/P: 100-240V~, 2A, 50/60Hz O/P: DC 19V, 7.9A</p>
Date of Receipt of Sample	Feb.18, 2014
Date of Test	Mar.03, 2014

2.2. Support Equipment

Item	Manufacturer	Model	Remark
AP Server	CISCO	AIR-AP1262N-A-K9	FCC ID: LDK102073 IC:2461B-102073
AP Server	D-Link	DIR-815A1	NCC ID: CCAI10LP092AT0 FCC ID: KA2IR815A1 IC: 4216A-IR815A1

2.3. Test Channel

Frequency Band	Channel No.	Frequency
5260-5320MHz (UNII Band II)	20MHz	
	60	5300MHz
	40MHz	
	62	5310MHz
	80MHz	
	58	5290 MHz
5500-5700MHz (UNII Band IV)	20MHz	
	120	5600MHz
	40MHz	
	102	5510MHz
	80MHz	
	106	5530 MHz

2.4. Description of Test Facility

Name of Firm : **Audix Technology (Shenzhen) Co., Ltd.**
No. 6, Ke Feng Rd., 52 Block,
Shenzhen Science & Industrial Park,
Nantou, Shenzhen, Guangdong, China

Test Site : No. 6, Ke Feng Rd., 52 Block,
Shenzhen Science & Industrial Park,
Nantou, Shenzhen, Guangdong, China

NVLAP Lab. Code : 200372-0

2.5. Measurement Uncertainty

Test Item	Uncertainty
DFS Measurement	$\pm 0.5\text{ms}$
Threshold	$\pm 0.33\text{dB}$

3. TEST EQUIPMENT

Item	Type	Manufacturer	Model No.	Serial No.	Last Cal.	Next Cal.
1.	Vector Signal Generation	R&S	SMU200A	104893	Oct. 31, 13'	Oct. 31, 14'
2.	Spectrum Analyzer	R&S	FSV30	101181	Oct. 31, 13'	Oct. 31, 14'
3.	Attenuator (10dB) X2	Worken	WK0602-10	0120A02 208001S	N/A	N/A
4.	Attenuator (30 dB) X2	Worken	WK0602-30	0120A02 208002S	N/A	N/A

4. WORKING MODES AND REQUIREMENT TEST ITEM

4.1. Applicability of DFS Requirements Prior To Use A Channel

Requirement	Operational Mode		
	Master	Client without radar detection	Client with radar detection
Non-Occupancy Period	✓	Not required	✓
DFS Detection Threshold	✓	Not required	✓
Channel Availability Check Time	✓	Not required	Not required
Uniform Spreading	✓	Not required	Not required
U-NII Detection Bandwidth	✓	Not required	✓

4.2. Applicability of DFS Requirements During Normal Operation

Requirement	Operational Mode		
	Master	Client without radar detection	Client with radar detection
DFS Detection Threshold	✓	Not required	✓
Channel Closing Transmission Time	✓	✓	✓
Channel Move Time	✓	✓	✓
U-NII Detection Bandwidth	✓	Not required	✓

5. DFS DETECTION THRESHOLOS AND RADAR TEST

WAVEFORMS

5.1. Interference Threshold Value, Master or Client Incorporating In-Service Monitoring

Maximum Transmit Power	Value (See Notes 1 and 2)
≥ 200 milliwatt	-64dBm
< 200 milliwatt	-62dBm

Note 1: This is the level at the input of the receiver assuming a 0 dBi receive antenna.

Note 2: Throughout these test procedures an additional 1 dB has been added to the amplitude of the test transmission waveforms to account for variations in measurement equipment. This will ensure that the test signal is at or above the detection threshold level to trigger a DFS response.

The radar Detection Threshold, lowest antenna gain is the parameter of interference radar DFS detection threshold.

5.2. Radar Test Waveform Minimum Step

Step intervals of 0.1 microsecond for Pulse Width, 1 microsecond for PRI, 1MHz for chirp width and 1 for the number of pulses will be utilized for the random determination of specific test waveforms.

5.3. Short Pulse Radar Test Waveforms

Radar Type	Pulse Width (μsec)	PRI (μsec)	Number of Pulse	Minimum Percentage of Successful Detection	Minimum number of Trials
1	1	1428	18	60%	30
2	1-5	150-230	23-29	60%	30
3	6-10	200-500	16-18	60%	30
4	11-20	200-500	12-16	60%	30
Aggregate (Radar Types 1-4)				80%	120

A minimum of 30 unique waveforms are required for each of the short pulse radar type 2 through 4. For short pulse radar type 1, the same waveform is used a minimum of 30 times. If more than 30 waveforms are used for short pulse radar types 2 through 4, then each additional waveform must also be unique and not repeated from the previous waveforms. The aggregate is the average of the percentage of successful detections of short pulse radar types 1-4.

FCC Radar Types (1~4) System Diagram

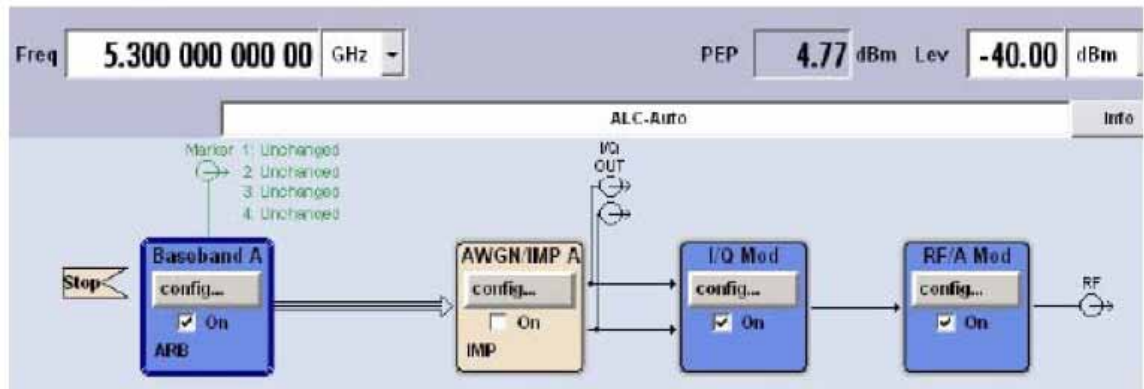

Used R&S SMU200A (Vector SG with two ARB)

B11: Base-band Generator with ARB (16M samples) and Digital Modulation

B13: Base-band Main Module

B106: frequency range (100 kHz to 6 GHz)

For selecting the waveform parameters from within the bounds of the signal type, system was random selection using uniform distribution.

5.4. Long Pulse Radar Test Waveforms

Radar Type	Pulse Width (μsec)	Chirp Width (MHz)	PRI (μsec)	Number of Pulse Per Burst	Number of Bursts	Minimum Percentage of Successful Detection	Minimum of Trials
5	50-100	5-20	1000-2000	1-3	8-20	80%	30

The parameters for this waveform are randomly chosen. Thirty unique waveforms are required for the Long Pulse radar test signal. If more 30 waveforms are used for the Long Pulse radar test signal, then each additional waveform must also be unique and not repeated from the previous waveforms. Each waveform is defined as following:

- (1) The transmission period for the Long Pulse Radar test signal is 12 seconds.
- (2) There are a total of 8 to 20 Bursts in the 12 second period, with the number of Bursts being randomly chosen. This number is Burst_Count.
- (3) Each Burst consists of 1 to 3 pulses, with the number of pulses being randomly chosen. Each Burst within the 12 second sequence may have a different number of pulses.
- (4) The pulse width is between 50 and 100 microseconds, with the pulse width being randomly chosen. Each pulse within a Burst will have the some pulse width. Pulses in different Bursts may have different pulse widths.
- (5) Each pulse has a linear FM chirp between 5 and 20MHz, with the chirp width being randomly chosen. Each pulse within a Burst will have the same chirp width. Pulses in different Burst may have different chirp widths. The chirp is centered on the pulse. For example, with a radar frequency of 5300MHz and a 20MHz chirped signal, the chirp starts at 5290MHz and ends at 5310MHz.

- (6) If more than one pulse is present in a Burst, the time between the pulses will be between 1000 and 2000 microseconds, with the time being randomly chosen. If three pulses are present in a Burst, the time between the first and second pulses is chosen independently of the time between the second and third pulses.
- (7) The 12 second transmission period is divided into even intervals. The number of intervals is equal to Burst_Count. Each interval is of length (12000000/Burst_Count) microseconds. Each interval contains one Burst. The start time for the Burst, relative to the beginning of the interval, is between 1 and [(12000000/Burst_Count)-(Total Burst length)+(One Random PRI interval)] microseconds, with the start time being randomly chosen. The step interval for the start time is 1 microsecond. The start time for each Burst is chosen independently.

A representative example of a Long Pulse radar test waveform:

- (1) The total test signal length is 12 seconds.
- (2) 8 Bursts are randomly generated for the Burst_Count.
- (3) Burst 1 has 2 randomly generated pulses.
- (4) The pulse width (for both pulses) is randomly selected to be 75 microseconds.
- (5) The PRI is randomly selected to be at 1213 microseconds.
- (6) Bursts 2 through 8 are generated using steps 3-5.
- (7) Each Burst is contained in even intervals of 1500000 microseconds. The starting location for Pulse 1. Burst 1 is randomly generated (1 to 1500000 minus the total Burst 1 length + 1 random PRI interval) at the 325001 microsecond step. Bursts 2 through 8 randomly fall in successive 1500000 microsecond intervals (i.e. Burst 2 falls in the 1500001-3000000 microsecond range).

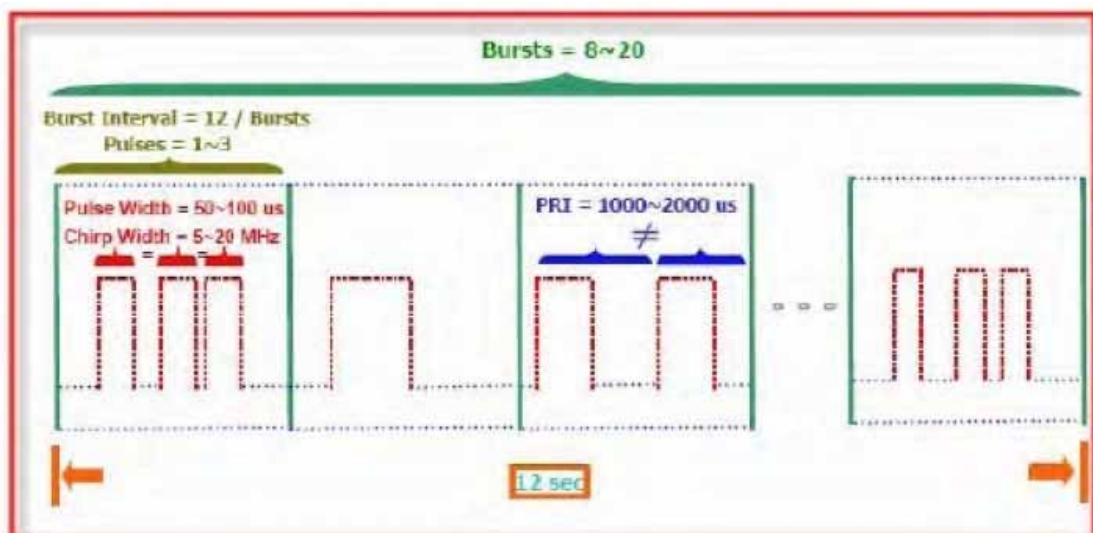

FCC Radar Types (5) System Diagram

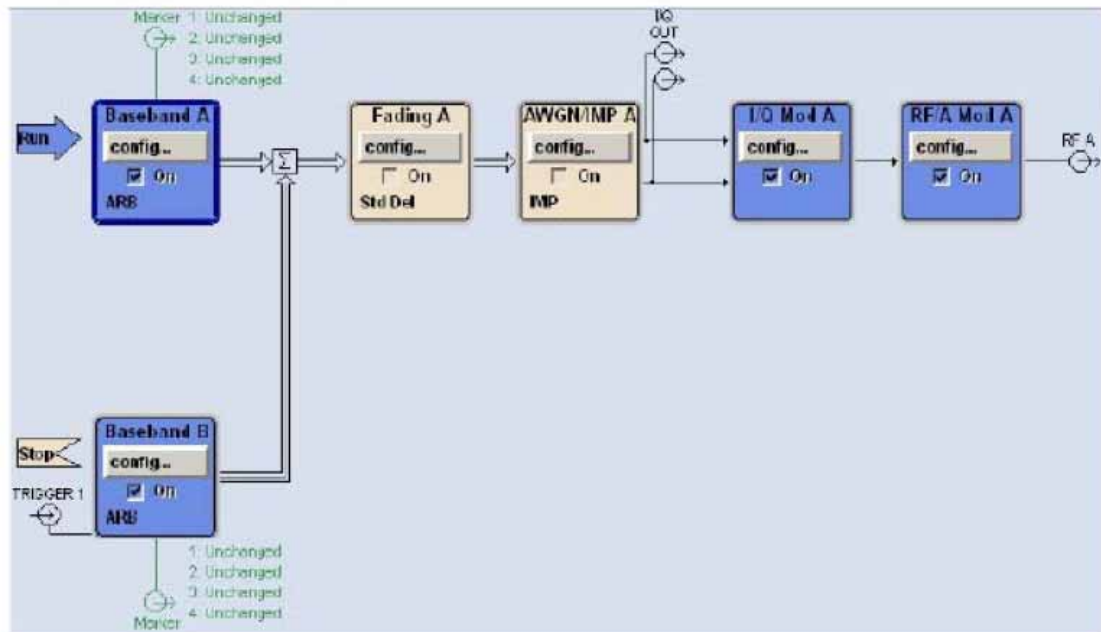

Used R&S SMU200A (Vector SG with two ARB)

Path A/Path B Two B11: Base-band Generator with ARB (16M samples) and Digital Modulation

B13: Base-band Main Module

B106: frequency range (100 kHz to 6 GHz)

For selecting the waveform parameters from within the bounds of the signal type, system was random selection using uniform distribution.

5.5. Frequency Hopping Pulse Radar Test Waveforms

Radar Type	Pulse Width (μsec)	PRI (μsec)	Pulses Per Hop	Hopping Rate (kHz)	Hopping Sequence Length (ms)	Minimum Percentage of Successful Detection	Minimum of Trials
6	1	333	9	0.333	300	70%	30

For the Frequency Hopping Radar Type, the same Burst parameters are used for each waveform. The hopping sequence is different for each waveform and a 100-length segment is selected from the hopping sequence defined by the following algorithm:

The first frequency in a hopping sequence is selected randomly from the group of 475 integer frequencies from 5250-5274MHz. Next, the frequency that was just chosen is removed from the group and a frequency is randomly selected from the remaining 474 frequencies in the group. This process continues until all 475 frequencies are chosen for the set. For selection of random frequency, the frequencies remaining within the group are always treated as equally likely.

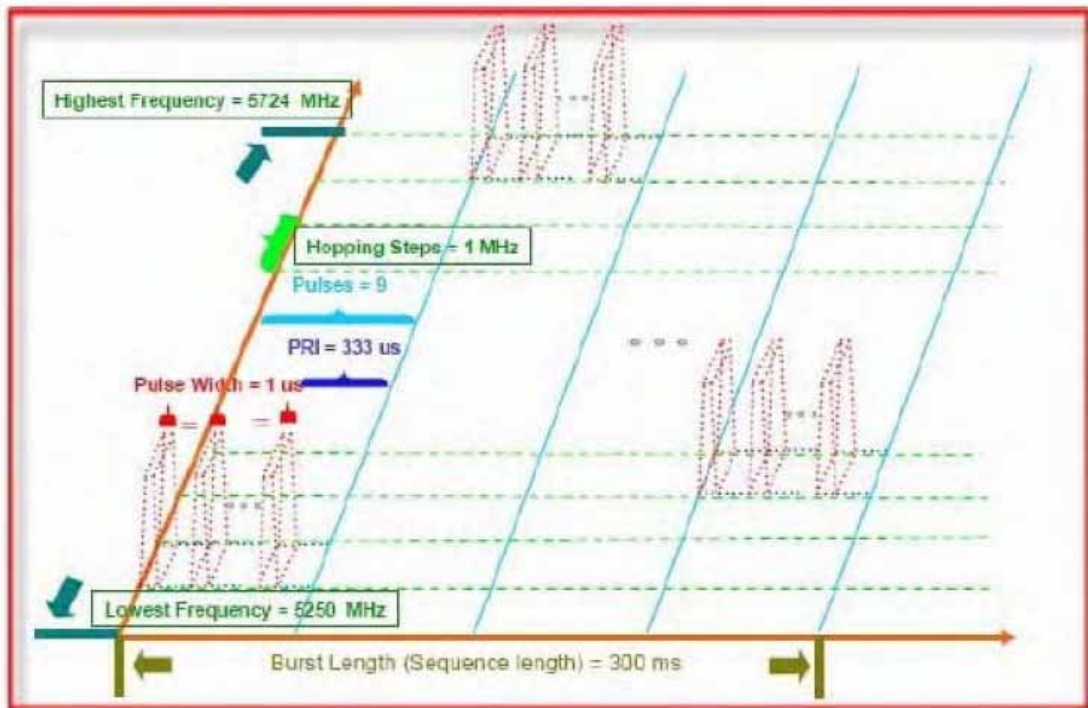

FCC Radar Types (6) System Diagram

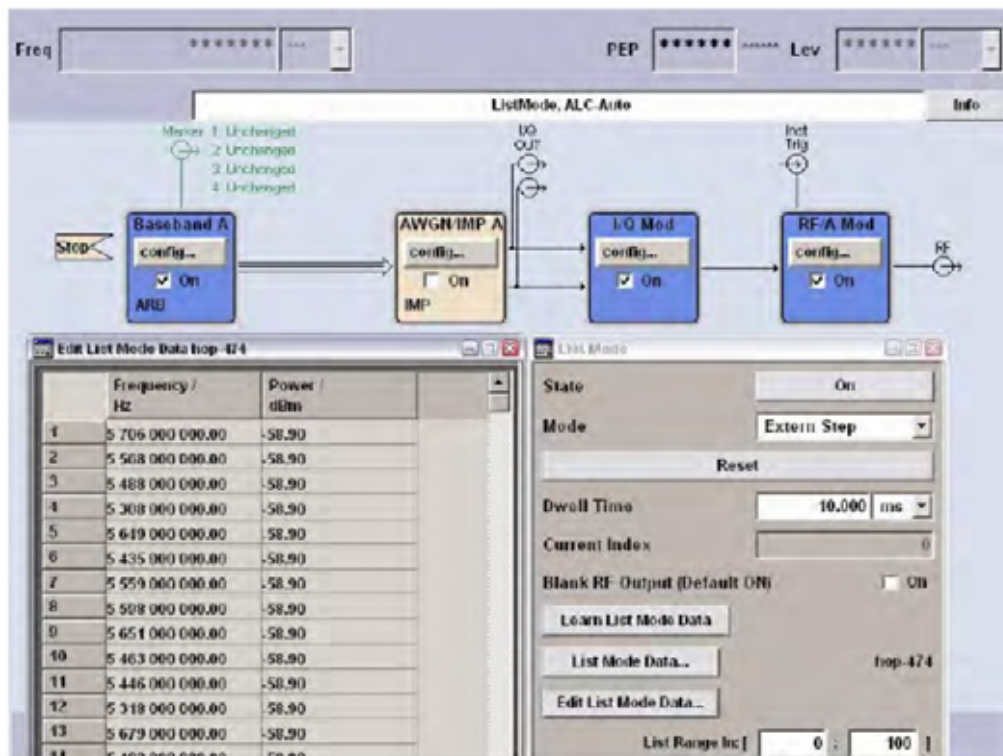

Used R&S SMU200A (Vector SG with two ARB)

B11: Base-band Generator with ARB (16M samples) and Digital Modulation

B13: Base-band Main Module

B106: frequency range (100 kHz to 6 GHz)

For selecting the waveform parameters from within the bounds of the signal type, system was random selection using uniform distribution.

5.6. Conducted Calibration Setup

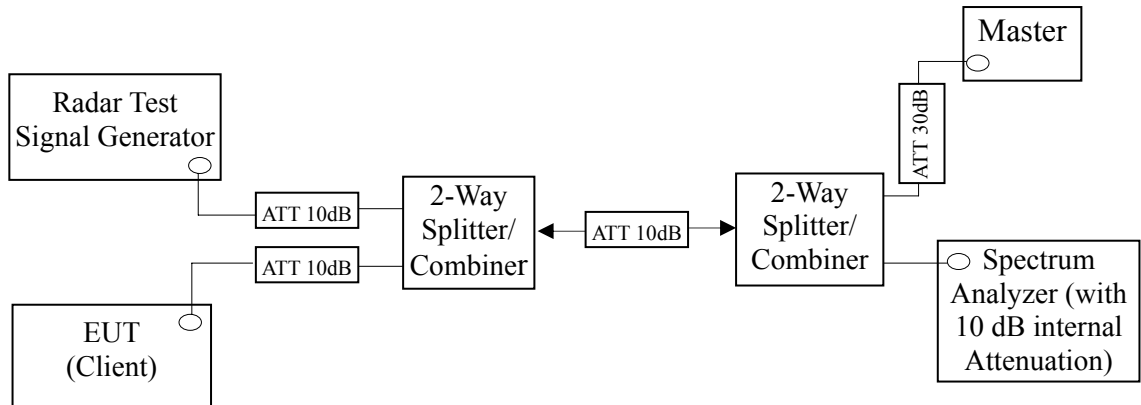

5.7. Radar Waveform Calibration Procedure

The measured frequency is 5280MHz & 5310MHz. The radar signal was the same as transmitted channels, and injected into the antenna port of AP (master) or Client Device with Radar Detection, measured the channel closing transmission time and channel move time. The calibrated conducted detection threshold level is set to -62dBm. The tested level is lower than required level hence it provides margin to the limit.

5.8. Calibration Deviation

There is no deviation with the original standard.

5.9. Radar Waveform Calibration Result

DFS detection threshold level and the burst of pulses on the Channel frequency
Band II
20MHz

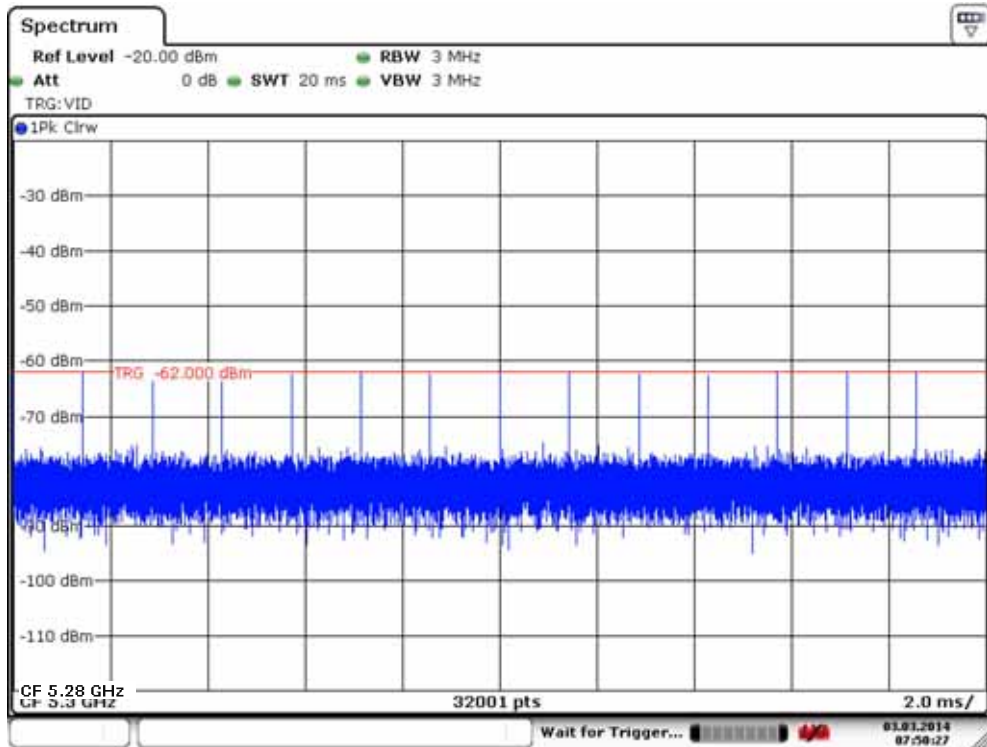

40MHz

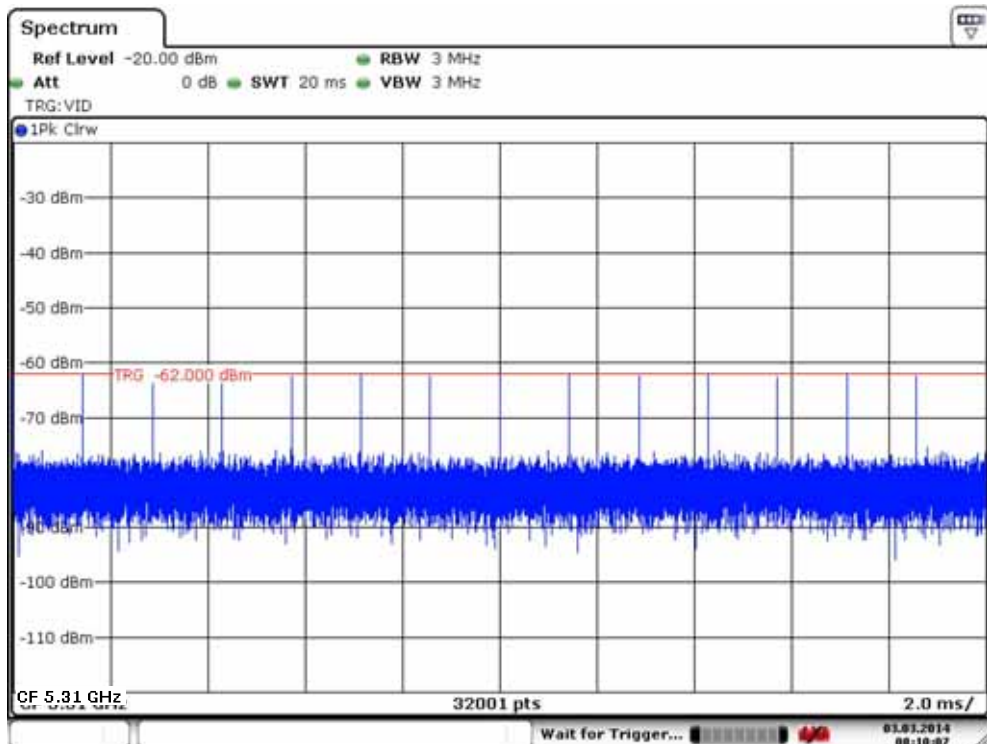

80MHz

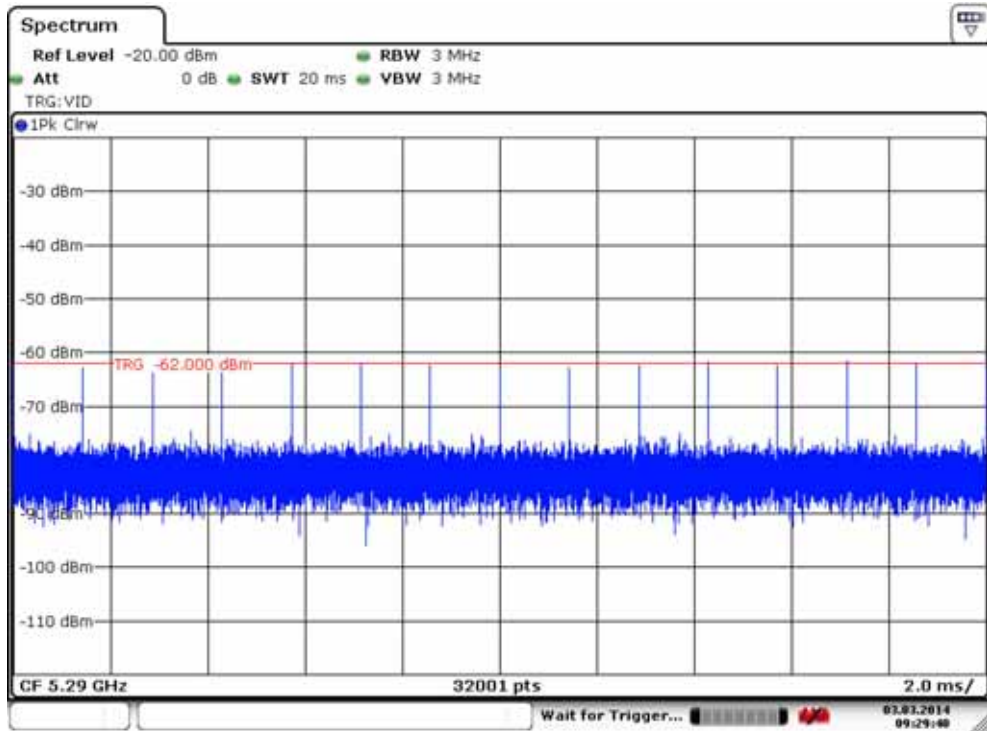

Date: 3.MAR.2014 09:29:39

Band IV 20MHz

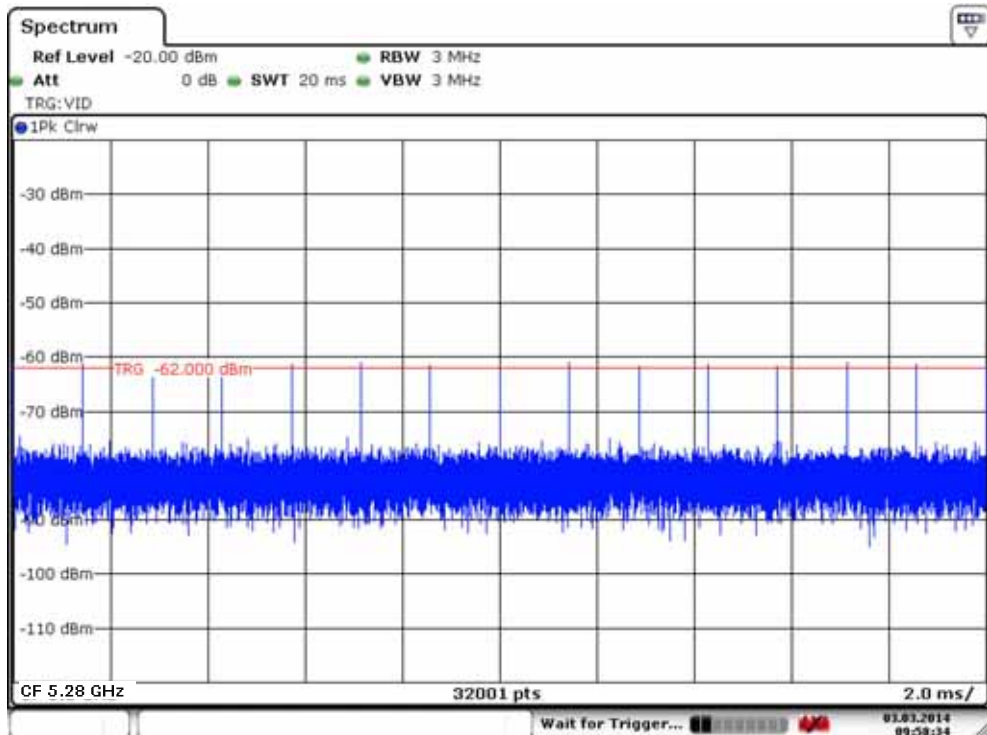

40MHz

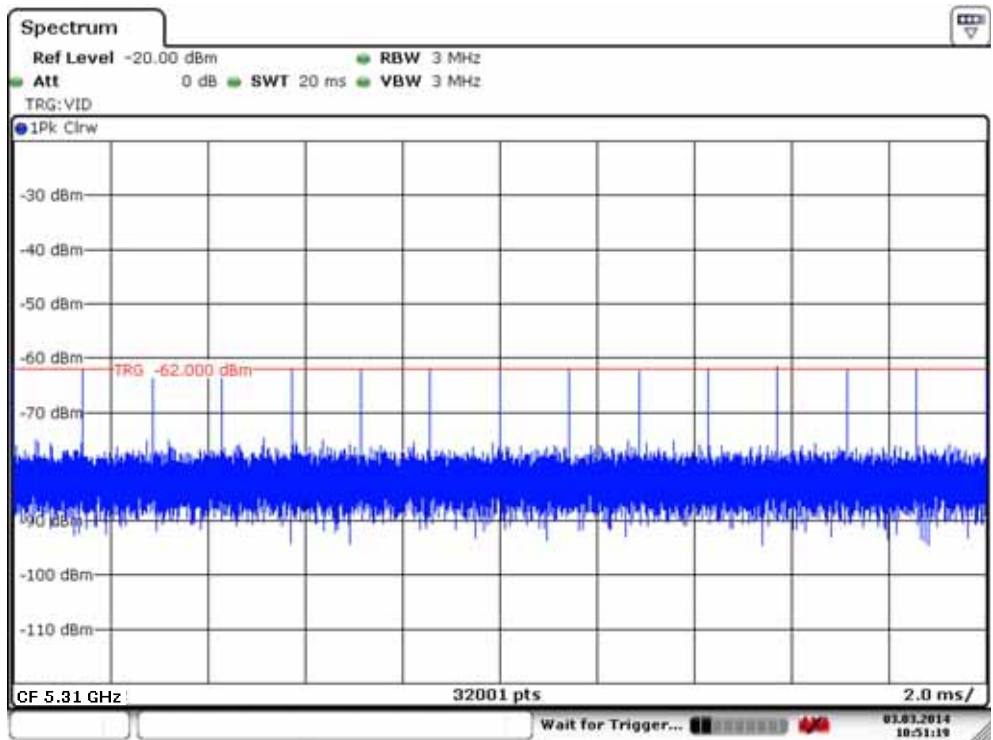

80MHz

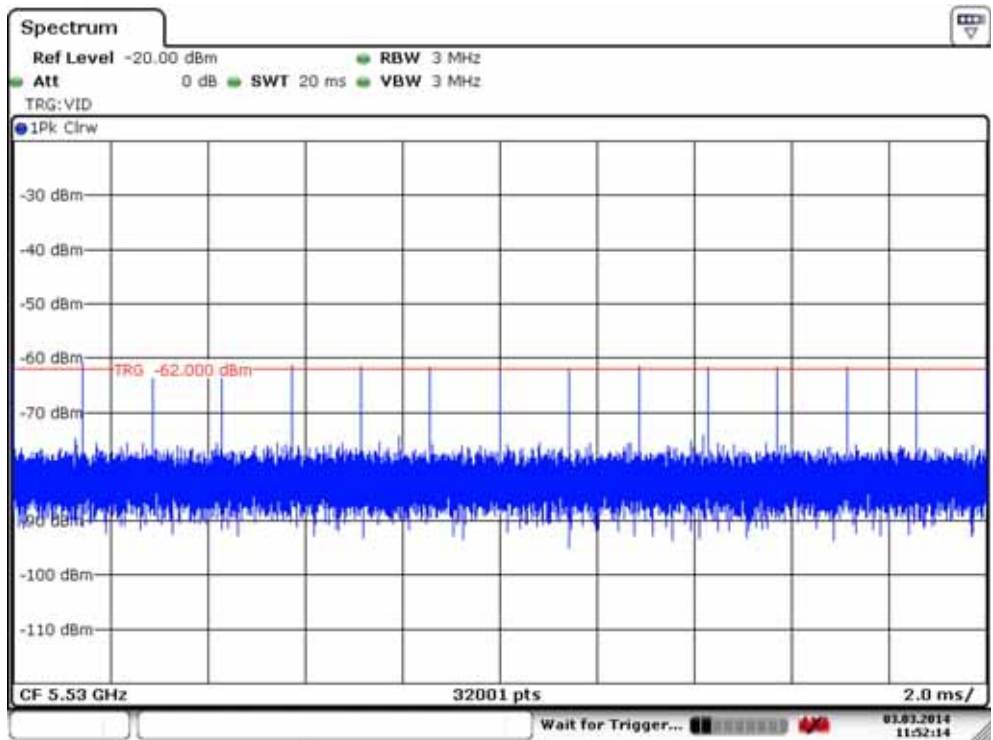

Date: 3.MAR.2014 11:52:13

6. TEST SETUP AND TEST RESULT

6.1. Test Setup

6.1.1. Test Setup Diagram

Following is the test setup for generated the radar waveforms and used to monitor UNII device.

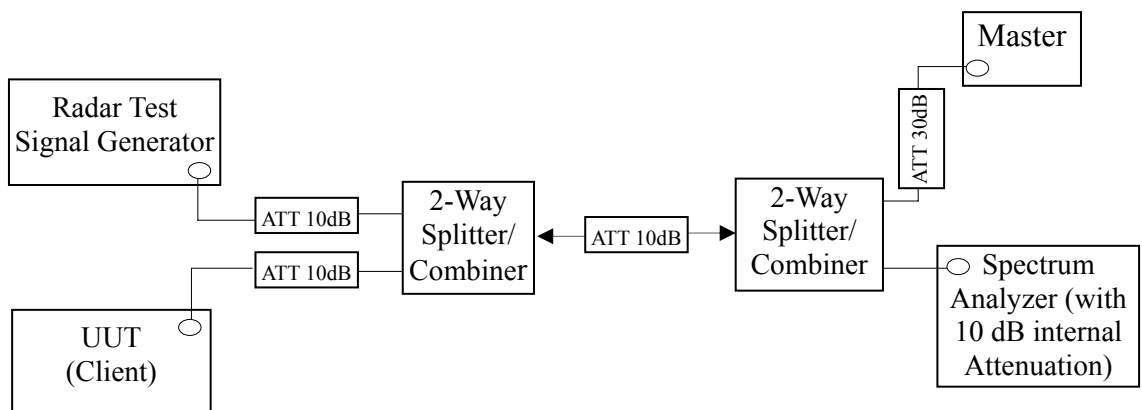

6.1.2. Test Setup Operation

System testing was performed with the designated MPEG test file that streams full motion video from the Access Point to Client in full motion video mode using the media player with the V2.61 Codec package. This file is used by IP and Frame based systems for loading the test channel during the in-service compliance testing of the U-NII device. The waveform parameters from within the bounds of the signal type are selected randomly using uniform distribution.

A spectrum analyzer is used as a monitor to verify that the EUT has vacated the Channel within the (Channel Closing Transmission Time and Channel Move Time, and does not transmit on a Channel during the Non-Occupancy Period after the detection and Channel move. It is also used to monitor EUT transmissions during the Channel Availability Check Time.

6.1.3. Test Setup for Data Traffic Plot

Test Date: Mar.03, 2014 Temperature: 21°C Humidity:56%

Band II 20MHz

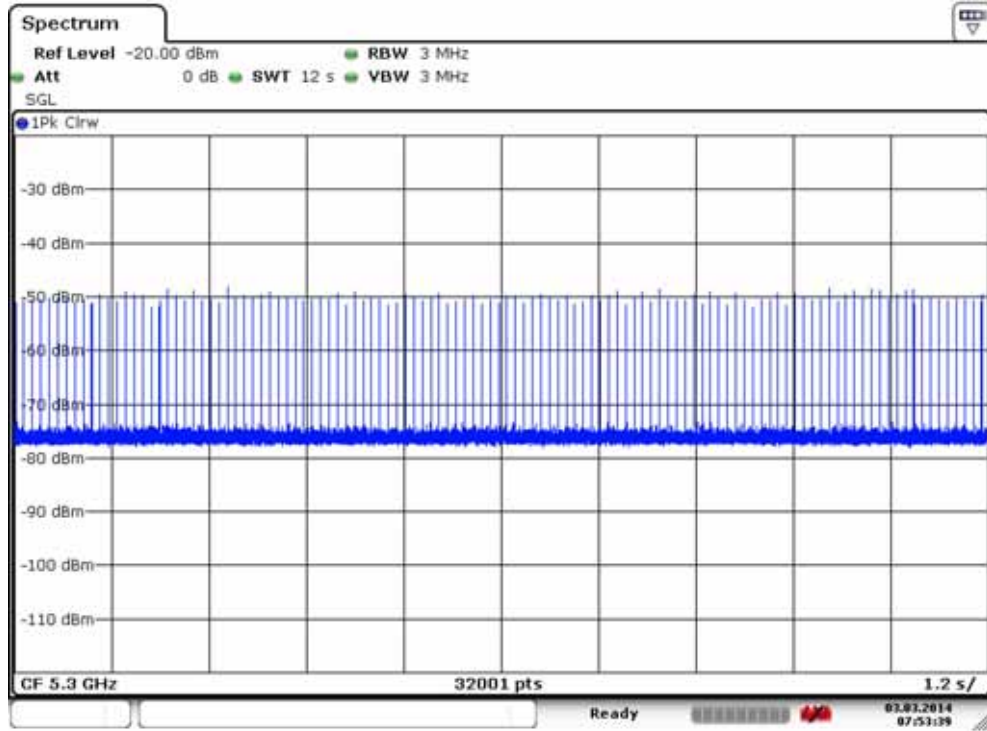

Date: 3.MAR.2014 07:53:39

40MHz

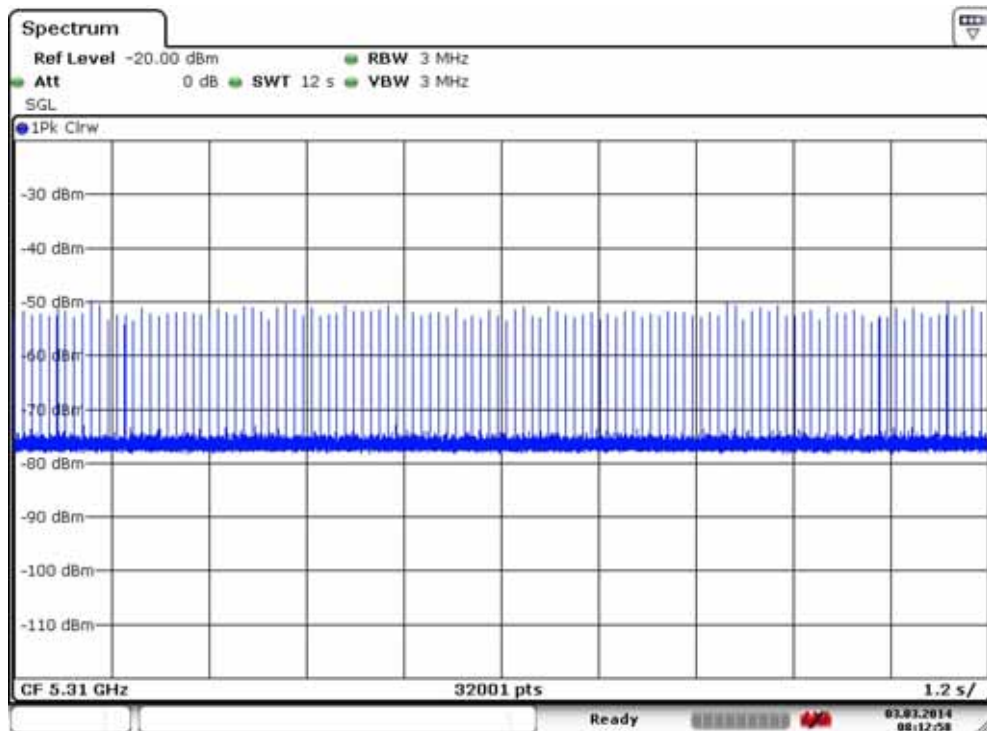

Date: 3.MAR.2014 08:12:57

80MHz

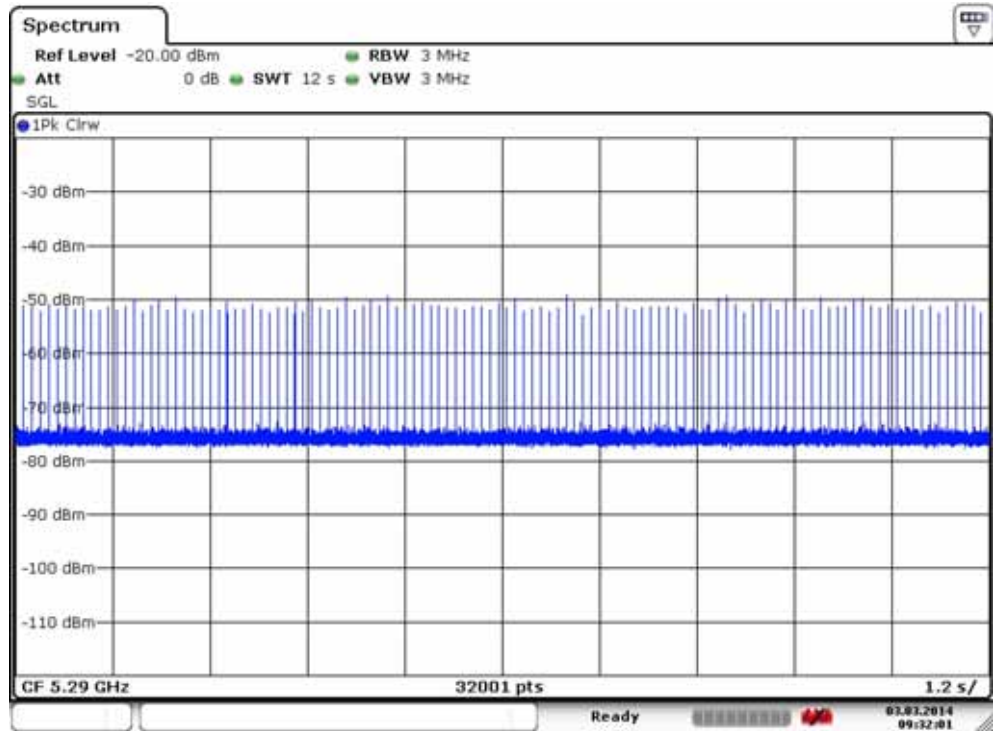

Date: 3.MAR.2014 09:32:00

Band IV 20MHz

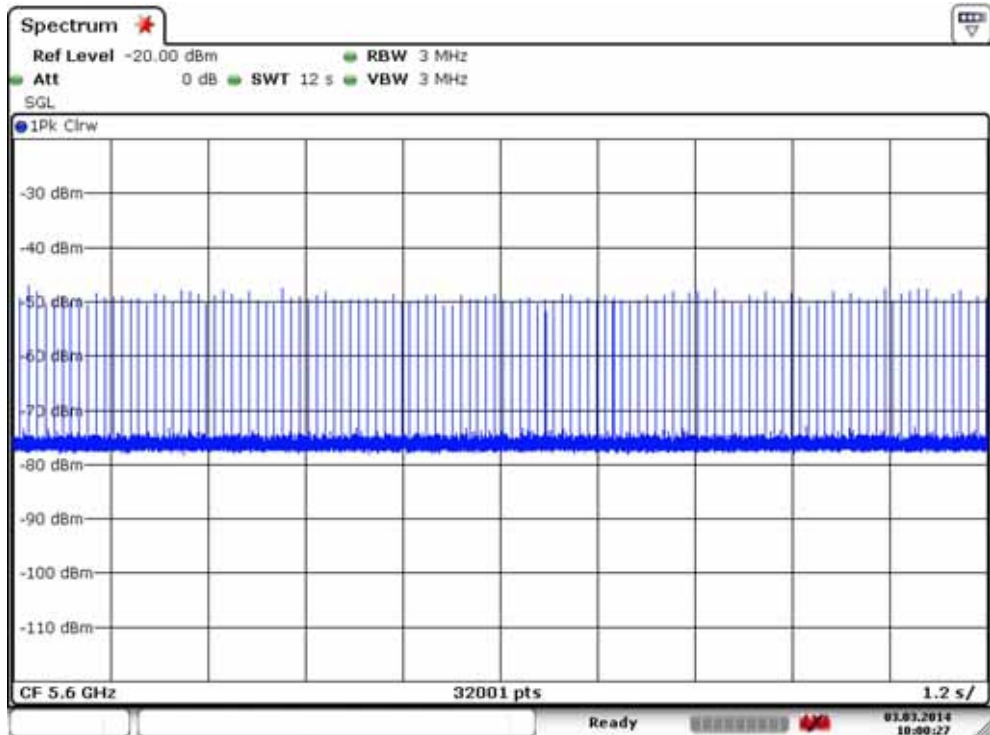

Date: 3.MAR.2014 10:00:26

40MHz

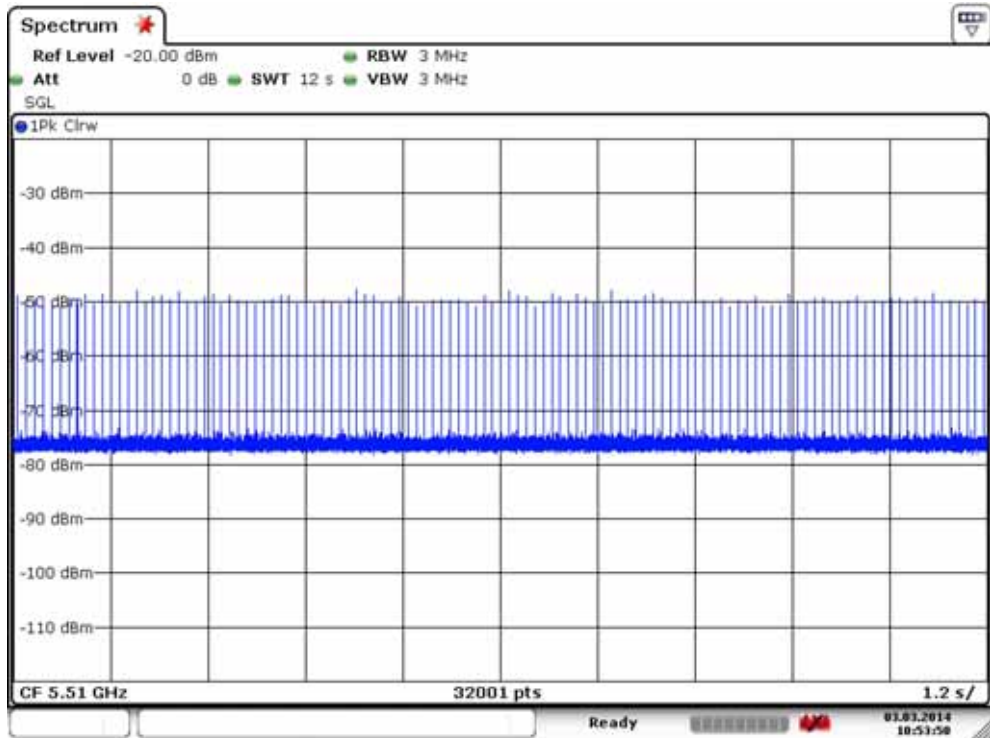

Date: 3.MAR.2014 10:53:49

80MHz

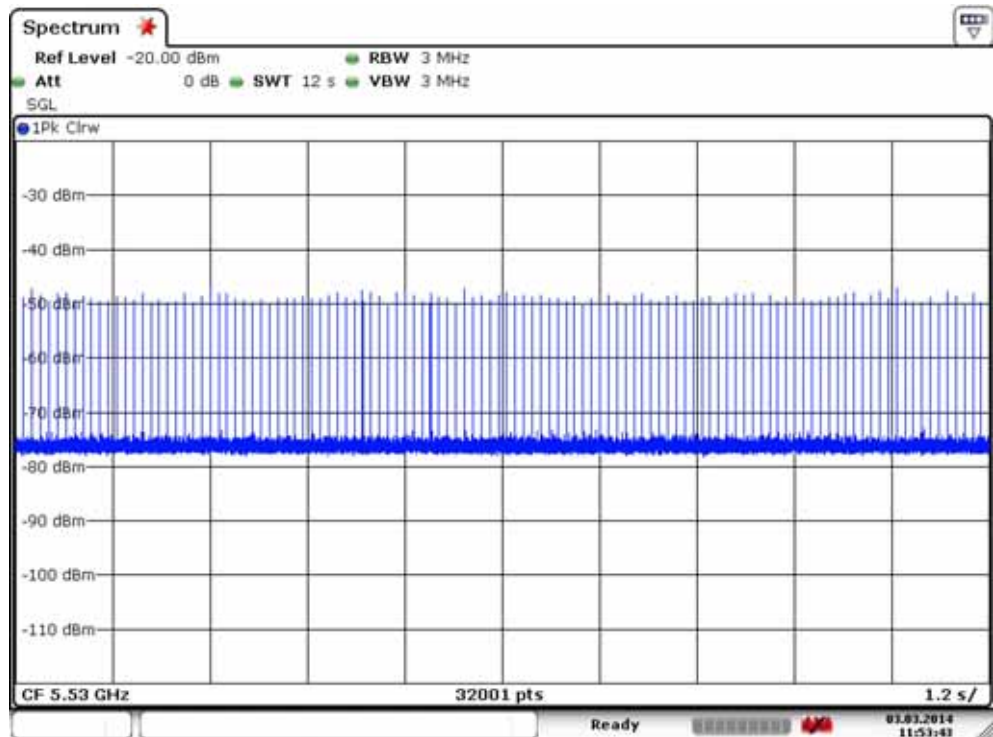

Date: 3.MAR.2014 11:53:42

6.2. Channel Move Time, Channel Closing Transmission Time Measurement

6.2.1. Limit

Parameter	Value
Channel Move Time	10 seconds See Note 1.
Channel Closing Transmission Time	200 milliseconds + an aggregate of 60 milliseconds over remaining 10 second period. See Notes 1 and 2.
<p>Note 1: The instant that the Channel Move Time and the Channel Closing Transmission Time begins is as follows:</p> <ul style="list-style-type: none">a. For the Short Pulse Radar Test Signals this instant is the end of the Burst.b. For the Frequency Hopping radar Test Signal, this instant is the end of the last radar Burst generated.c. For the Long Pulse Radar Test Signal this instant is the end of the 12 second period defining the Radar Waveform. <p>Note 2: The Channel Closing Transmission Time is comprised of 200 milliseconds starting at the beginning of the Channel Move Time plus any additional intermittent control signals required to facilitate a Channel move (an aggregate of 60 milliseconds) during the remainder of the 10 second period. The aggregate duration of control signals will not count quiet periods in between transmissions.</p>	

6.2.2. Test Procedures

- 6.2.2.1. When a radar Burst with a level equal to the DFS Detection Threshold + 1dB is generated on the operating channel of the U-NII device. A U-NII device operating as a Client Device will associate with the Master of channel. Stream the MPEG test file from the Master Device to the Client Device on the selected channel for entire period of the test. At time to the radar waveform generator sends a Burst of pulses for each of the radar types at Detection Threshold + 1dB.
- 6.2.2.2. Observe the transmissions of the EUT at the end of the radar Burst on the Operating channel. Measure and record the transmissions from the EUT during the observation time [Channel Move Time]. One 10 Second plot be reported for the short Pulse Radar type 1-4 and one for the Long Pulse Radar Type test in a 22 second plot. The plot for the Short Pulse Radar types start at the end of the radar burst. The Channel Move Time will be calculated based on the plot of the short Pulse Radar Type. The Long Pulse Radar Type plot show the device ceased transmissions within the 10 second window after detection has occurred. The plot for the Long Pulse Radar type should start at the beginning of the 12 second waveform.

6.2.3. Test Result

Applicability of DFS Requirement During Normal Operation

6.2.3.1. Channel Closing Transmission Time & Channel Move Time (PASS)

Test Mode: UNII Band II, 20MHz

Test Date: Mar.03, 2014

Temperature: 21°C

Humidity:56%

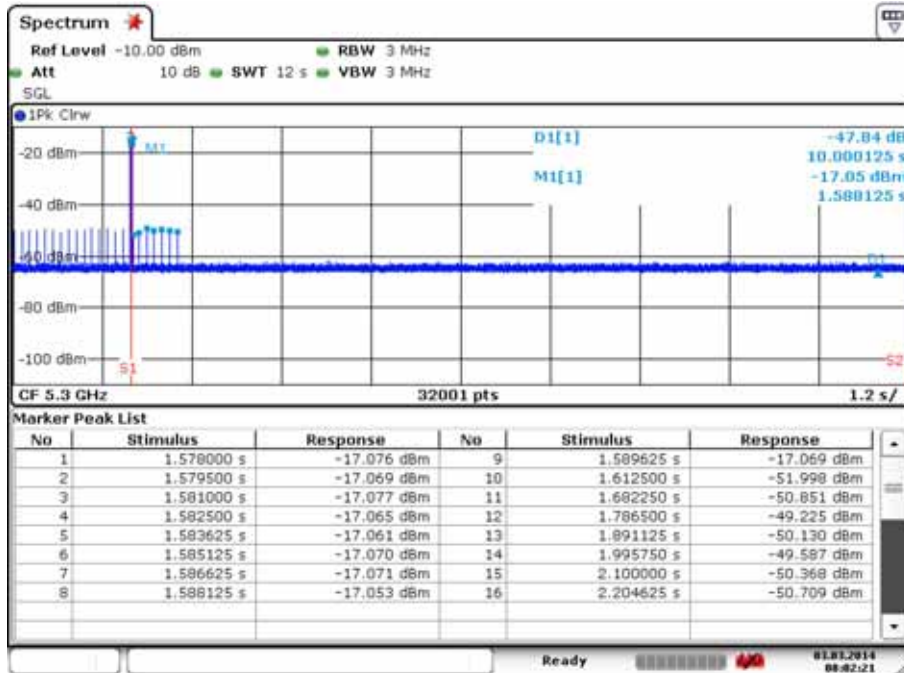

Date: 3.MAR.2014 08:02:21

Channel move time > 10 S

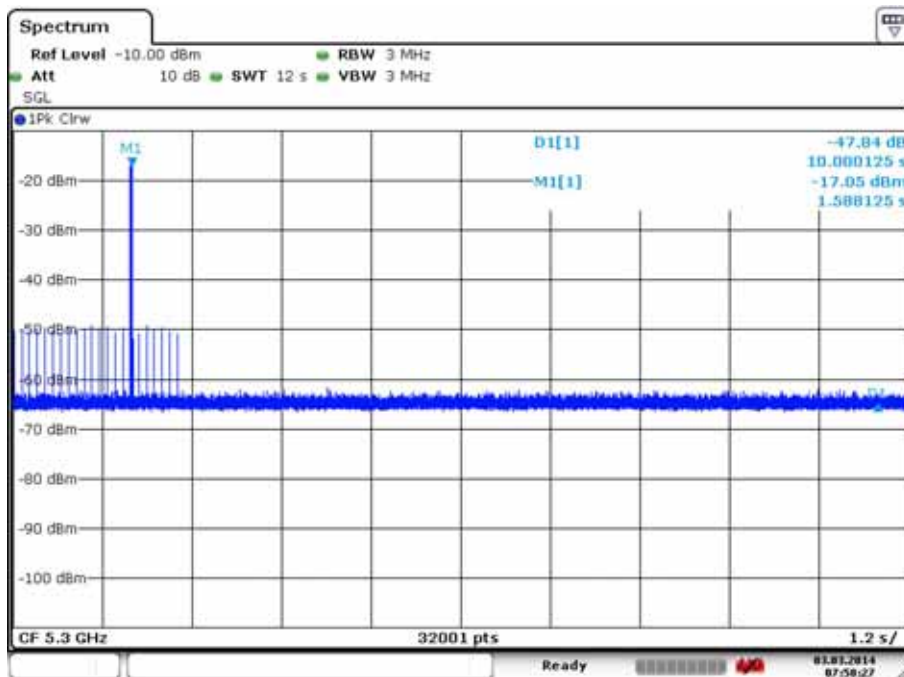

Date: 3.MAR.2014 07:58:26

Test Channel: CH 60, Test Frequency: 5300MHz

Channel Closing Transmission Time Calculated	
Sweep Time(S) sec	12
Sweep points (P)	32001
Number of Sweep points in 10 sec (N)	16
Channel Closing Time (C)	5.99 ms

Channel closing time is calculated from $C=N* \text{dwell}$; where dwell is the occupancy time per sweep point calculated by the formula: $\text{dwell}=S/P$. N is the number of sweep points indicating transmission after S1; where S1 is the radar signal detected.

Test Mode: UNII Band II, 40MHz

Test Date: Mar.03, 2014

Temperature: 21°C

Humidity:56%

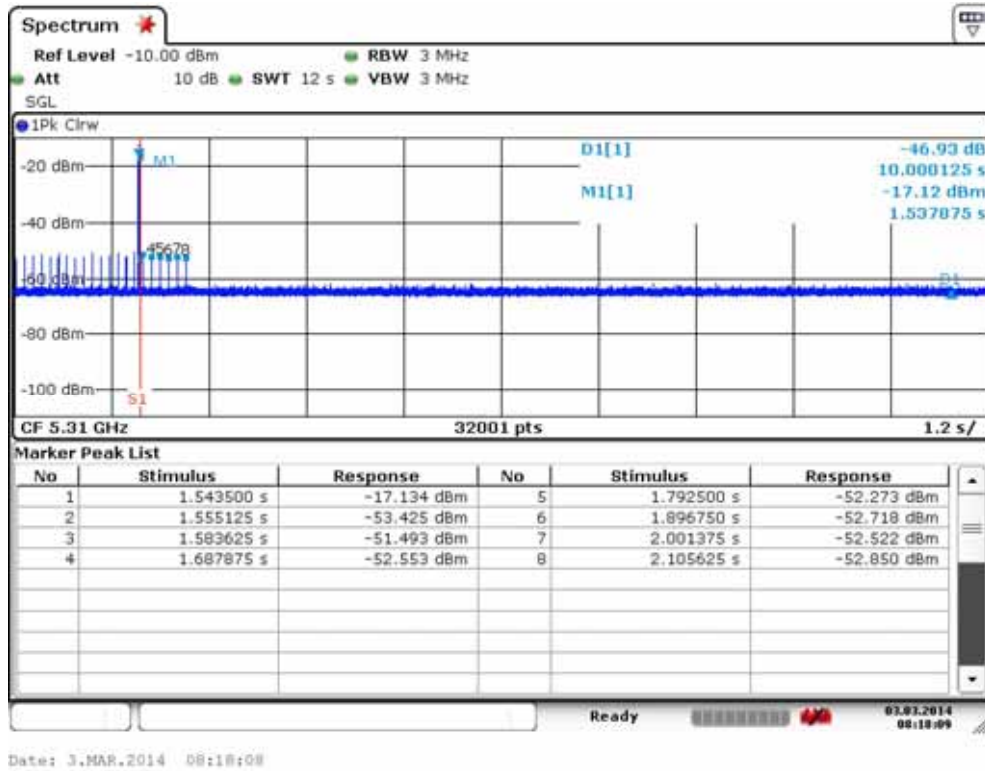

Channel move time > 10 S

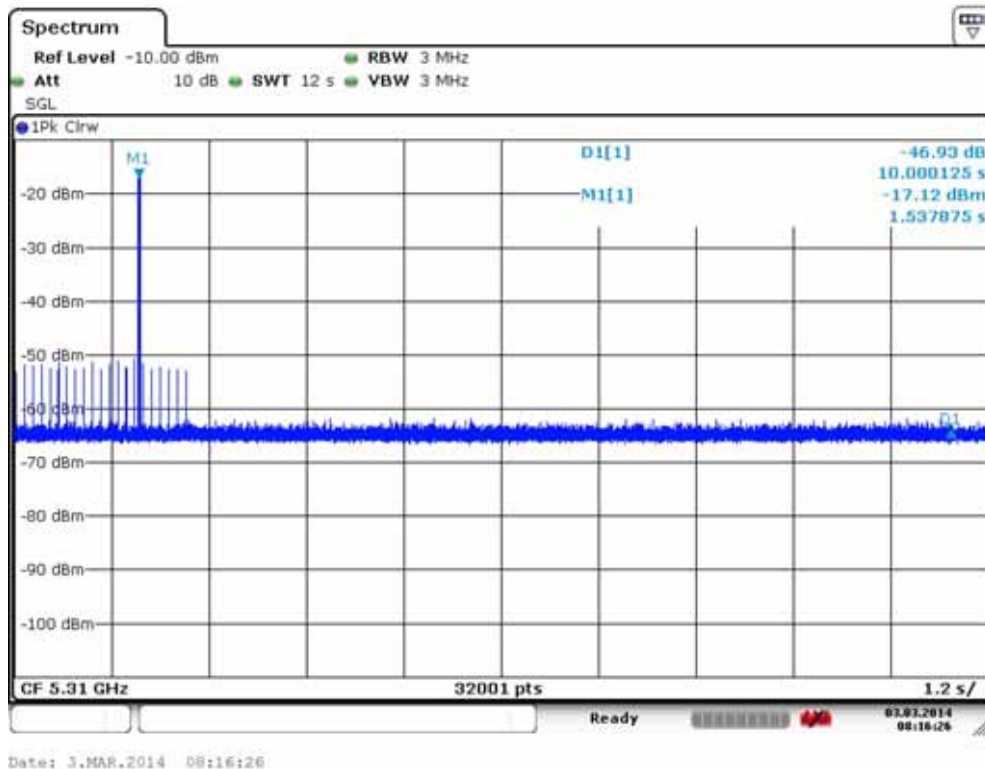

Test Channel: CH 62, Test Frequency: 5310MHz

Channel Closing Transmission Time Calculated	
Sweep Time(S) sec	12
Sweep points (P)	32001
Number of Sweep points in 10 sec (N)	8
Channel Closing Time (C)	2.99 ms

Channel closing time is calculated from $C=N* \text{dwell}$; where dwell is the occupancy time per sweep point calculated by the formula: $\text{dwell}=S/P$. N is the number of sweep points indicating transmission after S1; where S1 is the radar signal detected.

Test Mode: UNII Band II, 80MHz

Test Date: Mar.03, 2014

Temperature: 21°C

Humidity:56%

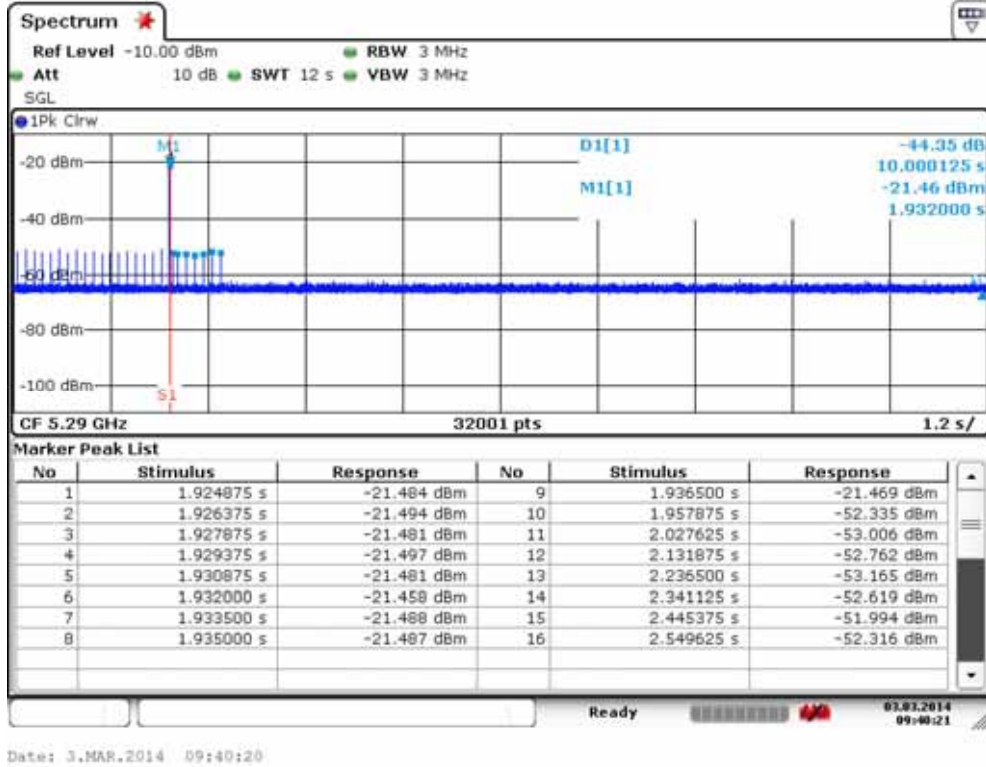

Date: 3.MAR.2014 09:40:20

Channel move time > 10 S

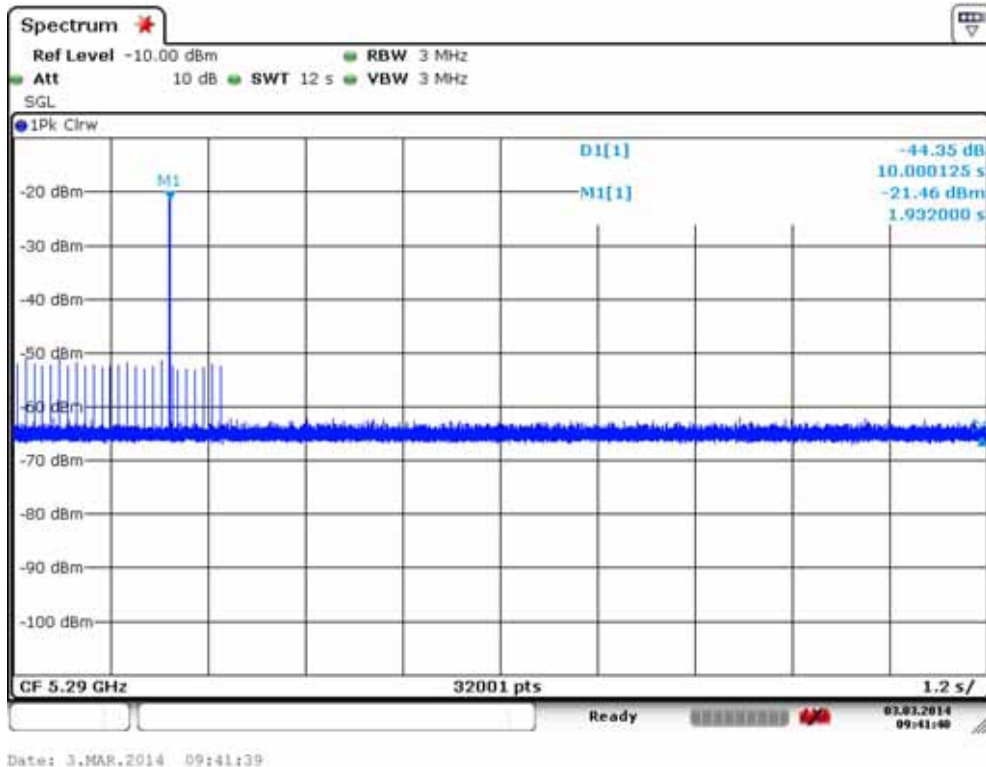

Date: 3.MAR.2014 09:41:39

Test Channel: CH 58, Test Frequency: 5290MHz

Channel Closing Transmission Time Calculated	
Sweep Time(S) sec	12
Sweep points (P)	32001
Number of Sweep points in 10 sec (N)	16
Channel Closing Time (C)	5.99 ms

Channel closing time is calculated from $C=N* \text{dwell}$; where dwell is the occupancy time per sweep point calculated by the formula: $\text{dwell}=S/P$. N is the number of sweep points indicating transmission after S1; where S1 is the radar signal detected.

Test Mode: UNII Band IV, 20MHz

Test Date: Mar.03, 2014

Temperature: 21°C

Humidity:56%

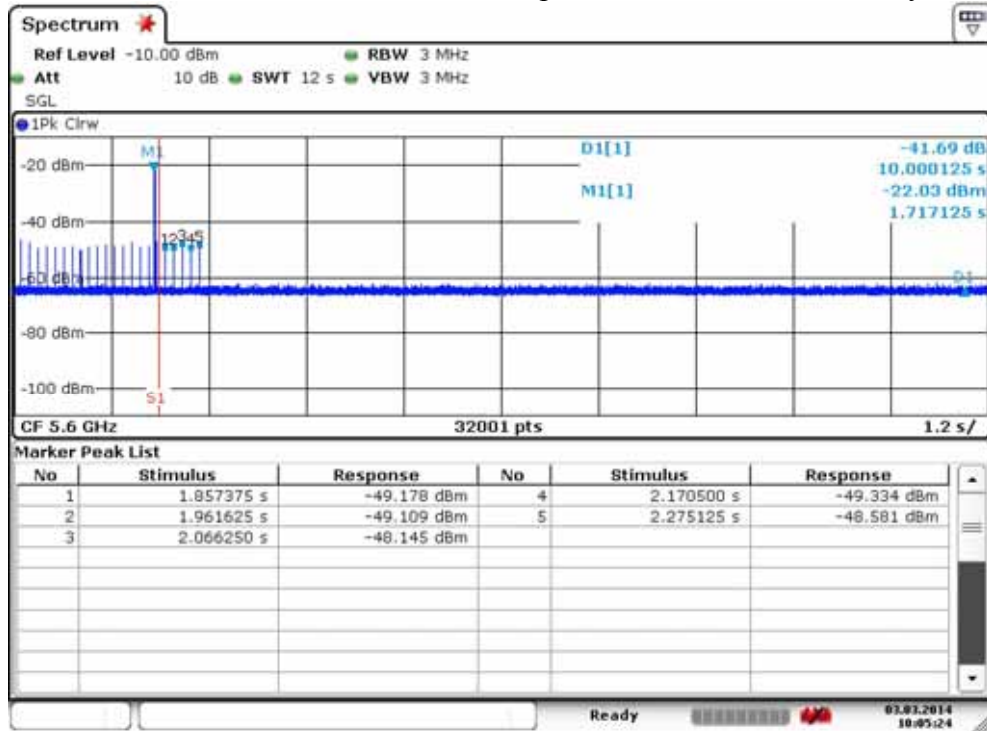

Date: 3.MAR.2014 10:05:23

Channel move time > 10 S

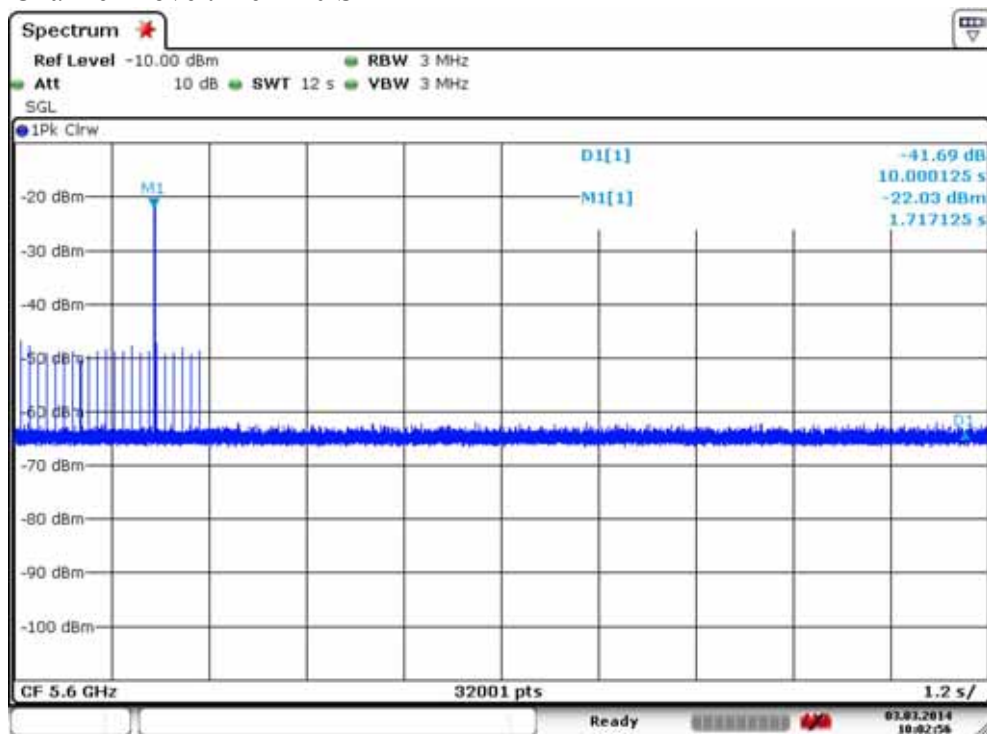

Date: 3.MAR.2014 10:02:55

Test Channel: CH 120, Test Frequency: 5600MHz

Channel Closing Transmission Time Calculated	
Sweep Time(S) sec	12
Sweep points (P)	32001
Number of Sweep points in 10 sec (N)	5
Channel Closing Time (C)	1.875 ms

Channel closing time is calculated from $C=N* \text{dwell}$; where dwell is the occupancy time per sweep point calculated by the formula: $\text{dwell}=S/P$. N is the number of sweep points indicating transmission after S1; where S1 is the radar signal detected.

Test Mode: UNII Band IV, 40MHz

Test Date: Mar.03, 2014

Temperature: 21°C

Humidity:56%

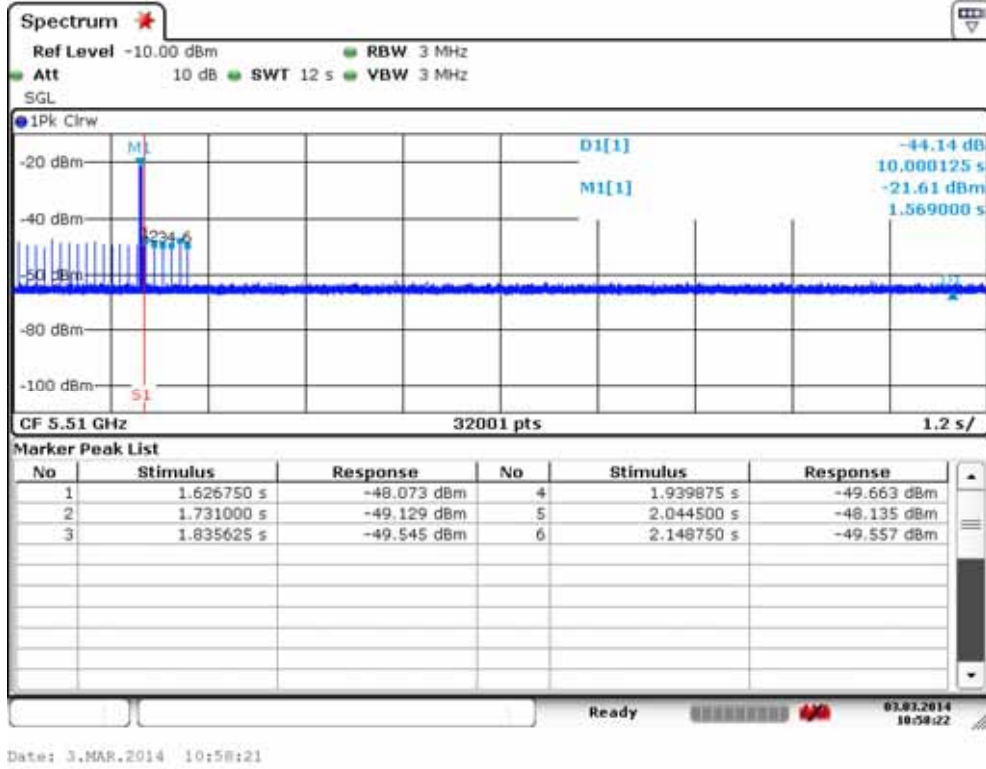

Channel move time > 10 S

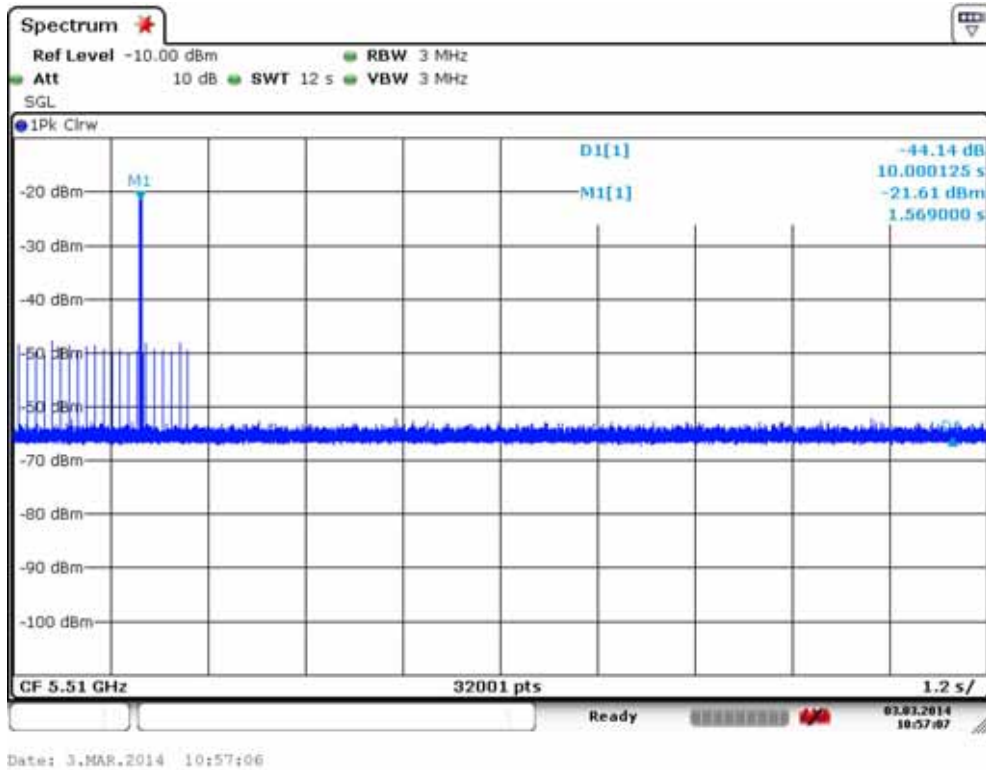

Test Channel: CH 102, Test Frequency: 5510MHz

Channel Closing Transmission Time Calculated	
Sweep Time(S) sec	12
Sweep points (P)	32001
Number of Sweep points in 10 sec (N)	6
Channel Closing Time (C)	2.249 ms

Channel closing time is calculated from $C=N* \text{dwell}$; where dwell is the occupancy time per sweep point calculated by the formula: $\text{dwell}=S/P$. N is the number of sweep points indicating transmission after S1; where S1 is the radar signal detected.

Test Mode: UNII Band IV, 80MHz

Test Date: Mar.03, 2014

Temperature: 21°C

Humidity:56%

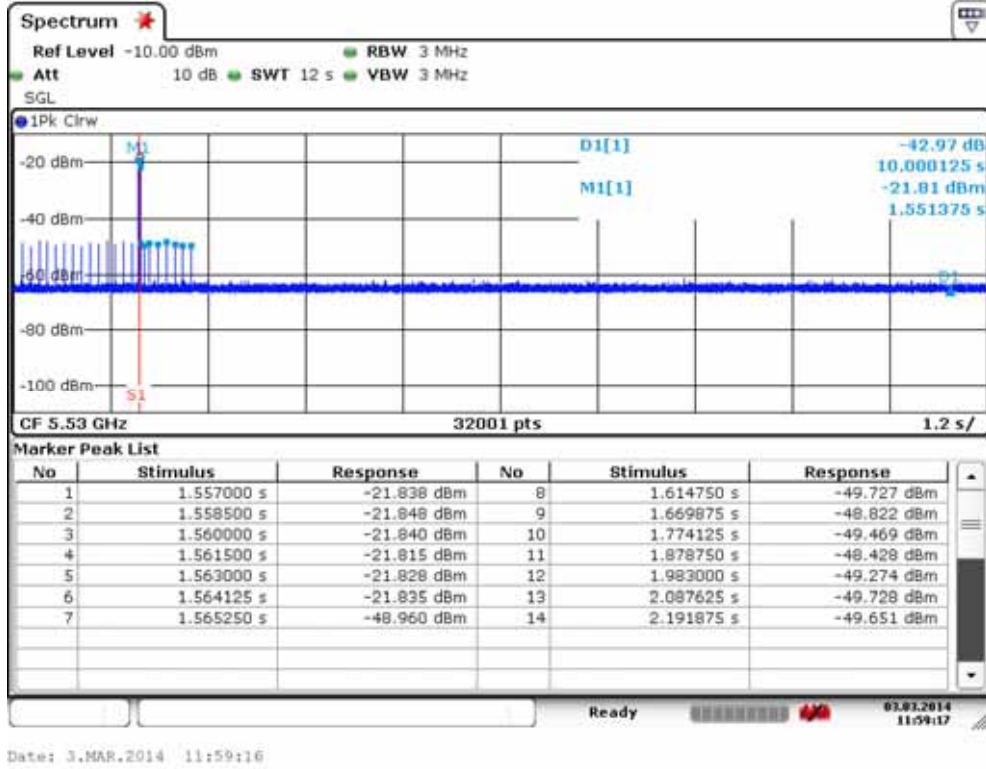

Channel move time > 10 S

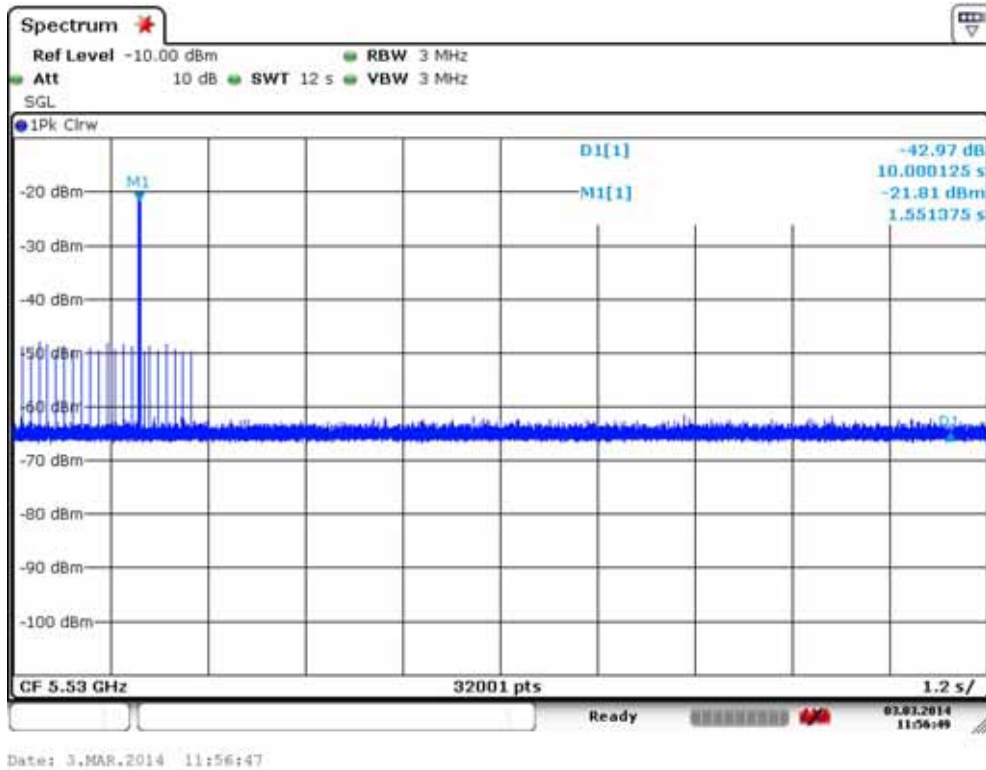

Test Channel: CH 106, Test Frequency: 5530MHz

Channel Closing Transmission Time Calculated	
Sweep Time(S) sec	12
Sweep points (P)	32001
Number of Sweep points in 10 sec (N)	14
Channel Closing Time (C)	5.249 ms

Channel closing time is calculated from $C=N* \text{dwell}$; where dwell is the occupancy time per sweep point calculated by the formula: $\text{dwell}=S/P$. N is the number of sweep points indicating transmission after S1; where S1 is the radar signal detected.