



FCC PART 15C TEST REPORT FOR CERTIFICATION

On Behalf of

Razer Inc.

Notebook

Brand Name	Model No.
Razer	RZ09-0116

FCC ID: RWO-RZ090116

Prepared for : Razer Inc.
2035 Corte Del Nogal, Suite 101, Carlsbad CA 92011,
USA

Prepared By : Audix Technology (Shenzhen) Co., Ltd.
No. 6, Ke Feng Rd., 52 Block,
Shenzhen Science & Industrial Park,
Nantou, Shenzhen, Guangdong, China

Tel: (0755) 26639496

Report Number : ACS-F13268
Date of Test : Feb.20~Mar.07, 2014
Date of Report : Mar.19, 2014

TABLE OF CONTENTS

Description	Page
1. SUMMARY OF STANDARDS AND RESULTS	1-1
1.1. Description of Standards and Results	1-1
2. GENERAL INFORMATION	2-1
2.1. Description of Device (EUT)	2-1
2.2. Tested Supporting System Details	2-3
2.3. Block Diagram of connection between EUT and simulators	2-3
2.4. Test information	2-4
2.5. Test Facility	2-4
2.6. Measurement Uncertainty (95% confidence levels, k=2)	2-5
3. POWER LINE CONDUCTED EMISSION MEASUREMENT	3-1
3.1. Test Equipment	3-1
3.2. Block Diagram of Test Setup	3-1
3.3. Power Line Conducted Emission Test Limits	3-1
3.4. Configuration of EUT on Test	3-2
3.5. Operating Condition of EUT	3-2
3.6. Test Procedure	3-2
3.7. Conducted Emission at Mains Terminals Test Results	3-2
4. RADIATED EMISSION MEASUREMENT	4-1
4.1. Test Equipment	4-1
4.2. Block Diagram of Test Setup	4-2
4.3. Radiated Emission Limit Standard: FCC 15.209	4-3
4.4. EUT Configuration on Test	4-3
4.5. Operating Condition of EUT	4-3
4.6. Test Procedure	4-3
4.7. Radiated Emission Test Results	4-4
5. CONDUCTED SPURIOUS EMISSIONS	5-1
5.1. Test Equipment	5-1
5.2. Limit	5-1
5.3. Test Procedure	5-1
5.4. Test result	5-1
6. 6dB BANDWIDTH TEST	6-1
6.1. Test Equipment	6-1
6.2. Limit	6-1
6.3. Test Procedure	6-1
6.4. Test Results	6-1
7. MAXIMUM PEAK OUTPUT POWER TEST	7-1
7.1. Test Equipment	7-1
7.2. Limit	7-1
7.3. Test Procedure	7-1
7.4. Test Results	7-1
8. BAND EDGE COMPLIANCE TEST	8-1
8.1. Test Equipment	8-1
8.2. Limit	8-1



8.3.	Test Produce	8-1
8.4.	Test Results	8-1
9.	POWER SPECTRAL DENSITY TEST	9-1
9.1.	Test Equipment	9-1
9.2.	Limit	9-1
9.3.	Test Procedure.....	9-1
9.4.	Test Results	9-2
10.	DEVIATION TO TEST SPECIFICATIONS.....	10-1
11.	HOTOGRAPH OF TEST	11-1
11.1.	Photos of Power Line Conducted Emission Test	11-1
11.2.	Photos of Radiated Emission Test.....	11-2



FCC ID:RWO-RZ090116

TEST REPORT CERTIFICATION

Applicant : Razer Inc.
Manufacturer : Razer Inc.
EUT Description : Notebook
FCC ID : RWO-RZ090116

Table with 2 columns: Brand Name, Model No. Row 1: Razer, RZ09-0116

(A) MODEL NO.& BRAND NAME : (B) SERIAL NO. : N/A
(C) POWER SUPPLY : AC 100-240V, 50/60Hz
(D) TEST VOLTAGE : DC 19V From Adapter Input AC 120V/60Hz

Tested for comply with:
FCC Rules and Regulations Part 15 Subpart C: 2012
Test procedure used:
ANSI C63.10:2009

The device described above is tested by AUDIX TECHNOLOGY (SHENZHEN) CO., LTD. to confirm comply with all the FCC Part 15 Subpart C requirements.

This Report is made under FCC Part 2.1075. No modifications were required during testing to bring this product into compliance.

This report applies to above tested sample only. This report shall not be reproduced in part without written approval of AUDIX TECHNOLOGY (SHENZHEN) CO., LTD.

The report must not be used by the client to claim product certification, approval, or endorsement by NVLAP, NIST, or any agency of the federal government.

Date of Test : Feb.20~ Mar.07, 2014 Report of date: Mar.19, 2014

Prepared by: Aimee Xiang / Assistant Reviewed by: Sunny Lu / Assistant Manager

Stamp only for EMC Dept. Report
Signature: David Jin 3.19
David Jin / Manager

Approved & Authorized Signer :

1. SUMMARY OF STANDARDS AND RESULTS

1.1. Description of Standards and Results

The EUT have been tested according to the applicable standards as referenced below.

EMISSION		
Description of Test Item	Standard	Results
Power Line Conducted Emission Test	FCC Part 15: 15.207 ANSI C63.10 :2009	PASS
Radiated Emission Test	FCC Part 15: 15.209 FCC Part 15: 15.247(d) ANSI C63.10 :2009	PASS
Conducted Spurious Emissions	FCC Part 15: 15.247(a)(1) ANSI C63.10 :2009	PASS
Carrier Frequency Separation Test	FCC Part 15: 15.247(a)(1) ANSI C63.10 :2009	PASS
6dB Bandwidth Test	FCC Part 15: 15.215 ANSI C63.10 :2009	PASS
Maximum Peak Output Power Test	FCC Part 15: 15.247(b)(1) ANSI C63.10 :2009	PASS
Band Edge Compliance Test	FCC Part 15: 15.247(d) ANSI C63.10 :2009	PASS
Power Spectral Density Test	FCC Part 15: 15.247(d) ANSI C63.10 :2009	PASS

2. GENERAL INFORMATION

2.1. Description of Device (EUT)

Product Name : Notebook

Model Number & Brand Name :	Brand Name	Model No.
	Razer	RZ09-0116

FCC ID : RWO-RZ090116

Radio : Bluetooth V3.0+EDR; Bluetooth V4.0; IEEE802.11 a/b/g/n/ac

Operation Frequency : IEEE 802.11a: 5180MHz—5240MHz, 5260MHz—5320MHz, 5500MHz—5700MHz; 5745MHz—5825MHz
 IEEE 802.11ac VHT20: 5180MHz—5240MHz, 5260MHz—5320MHz, 5500MHz—5700MHz; 5745MHz—5825MHz
 IEEE 802.11ac VHT40: 5190MHz—5230MHz, 5270MHz—5310MHz, 5510MHz—5710MHz; 5755MHz—5795MHz
 IEEE 802.11ac VHT80: 5210MHz, 5290MHz, 5530MHz—5690MHz; 5775MHz
 IEEE 802.11b: 2412MHz—2462MHz
 IEEE 802.11g: 2412MHz—2462MHz
 IEEE802.11nHT20: 2412MHz—2462MHz; 5180MHz—5240MHz, 5260MHz—5320MHz, 5500MHz—5700MHz; 5745MHz—5825MHz
 IEEE802.11nHT40: 2422MHz—2452MHz 5190MHz—5230MHz, 5270MHz—5310MHz, 5510MHz—5670MHz; 5755MHz—5795MHz
 Bluetooth: 2402-2480MHz

Modulation Technology : IEEE 802.11b: DSSS(CCK, DQPSK, DBPSK)
 IEEE 802.11a/g: OFDM(64QAM, 16QAM, QPSK, BPSK)
 IEEE 802.11ac VHT20, VHT40, VHT80: OFDM (16QAM, 64QAM, 256QAM, QPSK, BPSK)
 IEEE 802.11n HT20, HT40: OFDM (64QAM, 16QAM, QPSK, BPSK)
 Bluetooth V3.0+EDR: GFSK, $\pi/4$ DQPSK, 8DPSK
 Bluetooth V4.0: GFSK

Antenna Assembly Gain : Antenna A:
 IFA Antenna,
 2.4GHz: 2.89dBi(max)
 5GHz: 3.96dBi(max)
 Antenna B:
 IFA Antenna,
 2.4GHz: 2.7dBi(max)
 5GHz: 4.59dBi(max)

Applicant : Razer Inc.
2035 Corte Del Nogal, Suite 101, Carlsbad CA 92011, USA

Manufacturer : Razer Inc.
2035 Corte Del Nogal, Suite 101, Carlsbad CA 92011, USA

Factory : BYD Precision Manufacture Co.,Ltd
No.3001, Baohe Road, Baolong Industrial, Longgang, Shenzhen, P.R.,
China

Power Adapter #1 : Manufacturer: Razer Systems Pte Ltd. M/N: RC30-0083
DC Cable: Unshielded, Detachable 2m

Power Adapter #2 : Manufacturer: Razer Inc. M/N: RC30-0099
DC Cable: Unshielded, Detachable 2m

Note: According to exploratory test, power adapter #2 has the worse case
emission, so choose it for all test.

Date of Test : Feb.20~Mar.07, 2014

Date of Receipt : Feb.18, 2014

Sample Type : Prototype production

2.2. Tested Supporting System Details

No.	Description	ACS No.	Manufacturer	Model	Serial Number	Approved type
1.	Headphone	ACS-EMC-EP01	OVANN	OV880V	N/A	<input type="checkbox"/> FCC ID <input type="checkbox"/> BSMI ID
		Cable: Shielded, Undetachable, 4.0m				
2.	3D Monitor	--	SamSung	SA950	--	<input checked="" type="checkbox"/> CCC
		Adapter: M/N:AD-6314N DC Cable:Unshielded Undetachable 1.5m AC Cable: Unshielded Detachable 1.8m				
3.	HDD #1	ACS-EMC-HDD02	Terasys	F12-UF	A0100215-539 0018	<input checked="" type="checkbox"/> FCC DoC <input checked="" type="checkbox"/> BSMI ID: 4912A022
		Data Cable: Shielded, Detachable, 1.8m				
4.	HDD #2	ACS-EMC-HDD03	Terasys	F12-UF	A0100215-539 0030	<input checked="" type="checkbox"/> FCC DoC <input checked="" type="checkbox"/> BSMI ID: 4912A022
		Data Cable: Shielded, Detachable, 1.8m				
5.	HDD #3	ACS-EMC-HDD04	Terasys	F12-UF	A0100215-539 0002	<input checked="" type="checkbox"/> FCC DoC <input checked="" type="checkbox"/> BSMI ID: 4912A022
		Data Cable: Shielded, Detachable, 1.8m				

2.3. Block Diagram of connection between EUT and simulators

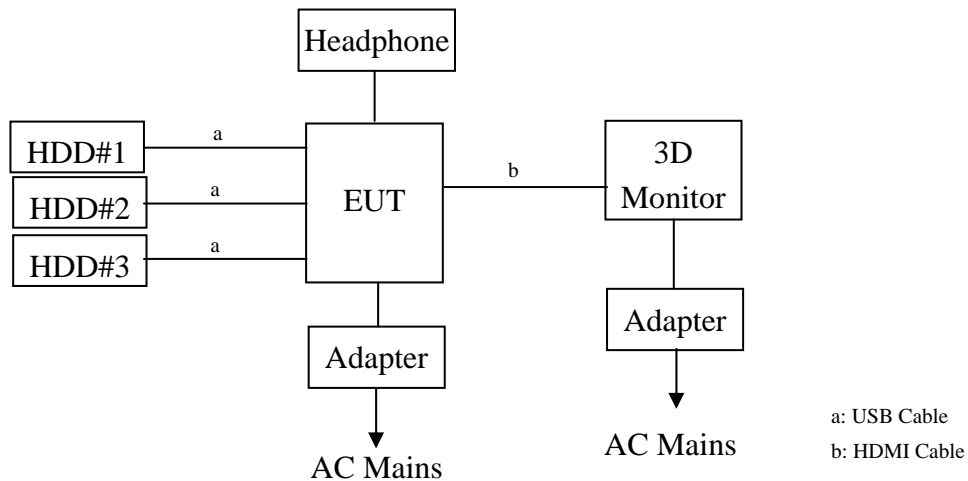

(EUT: Notebook)

2.4. Test information

The test software “bluesuite.exe” was used to control EUT work in Continuous TX mode, and select test channel.

Tested mode, channel, and data rate information			
Mode	data rate (Mbps)	Channel	Frequency (MHz)
Tx Mode GFSK modulation	1	Low :CH 0	2402
	1	Middle: CH19	2440
	1	High: CH39	2480

2.5. Test Facility

Site Description

Name of Firm : Audix Technology (Shenzhen) Co., Ltd.
No. 6, Ke Feng Rd., 52 Block, Shenzhen
Science & Industrial Park,Nantou,
Shenzhen, Guangdong, China

3m Anechoic Chamber : Certificated by FCC, USA
Registration Number: 90454
Valid Date: Feb.22, 2015

3m & 10m Anechoic Chamber : Certificated by FCC, USA
Registration Number: 794232
Valid Date: Oct.31, 2015

EMC Lab. : Certificated by Industry Canada
Registration Number: IC 5183A-1
Valid Date: Jun.13, 2014

Certificated by DAkkS, Germany
Registration No: D-PL-12151-01-00
Valid Date: Dec.15, 2016

Accredited by NVLAP, USA
NVLAP Code: 200372-0
Valid Date: Mar.31, 2014

2.6. Measurement Uncertainty (95% confidence levels, k=2)

Test Item	Uncertainty
Uncertainty for Conduction emission test in No. 1 Conduction	3.08dB(9KHz to 150KHz)
	3.1dB (150KHz to 30MHz)
Uncertainty for Radiation Emission test in 3m chamber	3.22 dB(30~200MHz, Polarize: H)
	3.23 dB(30~200MHz, Polarize: V)
	3.49 dB(200M~1GHz, Polarize: H)
	3.39 dB(200M~1GHz, Polarize: V)
Uncertainty for Radiation Emission test in 3m chamber (1GHz-18GHz)	4.97 dB (1~6GHz, Distance: 3m)
	4.99 dB (6~18GHz, Distance: 3m)
Uncertainty for Radiated Spurious Emission test in RF chamber	3.57 dB
Uncertainty for Conduction Spurious emission test	2.00 dB
Uncertainty for Output power test	0.73 dB
Uncertainty for Bandwidth test	83 kHz
Uncertainty for DC power test	0.038 %
Uncertainty for test site temperature and humidity	0.6°C
	3%

3. POWER LINE CONDUCTED EMISSION MEASUREMENT

3.1. Test Equipment

Item	Equipment	Manufacturer	Model No.	Serial No.	Last Cal.	Cal. Interval
1.	1# Shielding Room	AUDIX	N/A	N/A	Apr.18,13	1 Year
2.	Test Receiver	Rohde & Schwarz	ESHS10	838693/001	Oct.31, 13	1 Year
3.	L.I.S.N.#1	Rohde & Schwarz	ESH2-Z5	834066/011	Oct.31, 13	1 Year
4.	L.I.S.N.#3	Kyoritsu	KNW-242C	8-1920-1	May.08, 13	1 Year
5.	Terminator	Hubersuhner	50Ω	No. 1	May.08, 13	1 Year
6.	Terminator	Hubersuhner	50Ω	No. 2	May.08, 13	1 Year
7.	RF Cable	Fujikura	3D-2W	No.1	May.08, 13	1 Year
8.	Coaxial Switch	Anritsu	MP59B	M50564	May.08, 13	1 Year
9.	Pulse Limiter		ESH3-Z2	100341	May.08, 13	1 Year
10.	MPEG2 Measurement Generator	Rohde & Schwarz	DVG	100319	Dec.11, 13	1 Year
11.	TV Transmitter	Rohde & Schwarz	SFQ	100521	May.08, 13	1 Year
12.	Signal Generator	HP	8648A	3625U00573	May.08, 13	1 Year
13.	Pattern Generator	Philips	PM5418	LO625020	May.08, 13	1 Year

3.2. Block Diagram of Test Setup

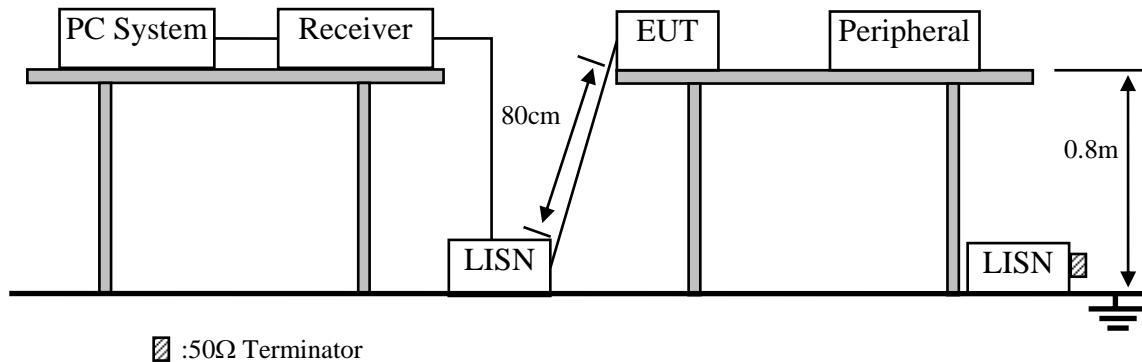

3.3. Power Line Conducted Emission Test Limits

Frequency	Maximum RF Line Voltage	
	Quasi-Peak Level dB(μV)	Average Level dB(μV)
150kHz ~ 500kHz	66 ~ 56*	56 ~ 46*
500kHz ~ 5MHz	56	46
5MHz ~ 30MHz	60	50

Notes: 1. * Decreasing linearly with logarithm of frequency.

2. The lower limit shall apply at the transition frequencies.

3.4. Configuration of EUT on Test

The following equipment are installed on Power Line Conducted Emission Test to meet the commission requirement and operating regulations in a manner which tends to maximize its emission characteristics in a normal application.

3.4.1. Notebook (EUT)

Model Number : RZ09-0116
Serial Number : N/A

3.5. Operating Condition of EUT

3.5.1. Setup the EUT and simulator as shown as Section 3.2.

3.5.2. Turn on the power of all equipment.

3.5.3. Let the EUT work in test mode (TX Mode) and measure it.

3.6. Test Procedure

The EUT was placed on a non-metallic table, 80cm above the ground plane. The EUT Power connected to the power mains through a line impedance stabilization network (L.I.S.N. 1#). this provided a 50-ohm coupling impedance for the EUT (Please refer to the block diagram of the test setup and photographs). Both sides of power line were checked for maximum conducted interference. In order to find the maximum emission, the relative positions of equipments and all of the interface cables were changed according to ANSI C63.4-2009 on conducted Emission test.

The bandwidth of test receiver (R&S TEST RECEIVER ESHS10) is set at 9kHz.

The frequency range from 150kHz to 30MHz is checked. The test result are reported on Section 3.7.

3.7. Conducted Emission at Mains Terminals Test Results

PASS. (All emissions not reported below are too low against the prescribed limits.)

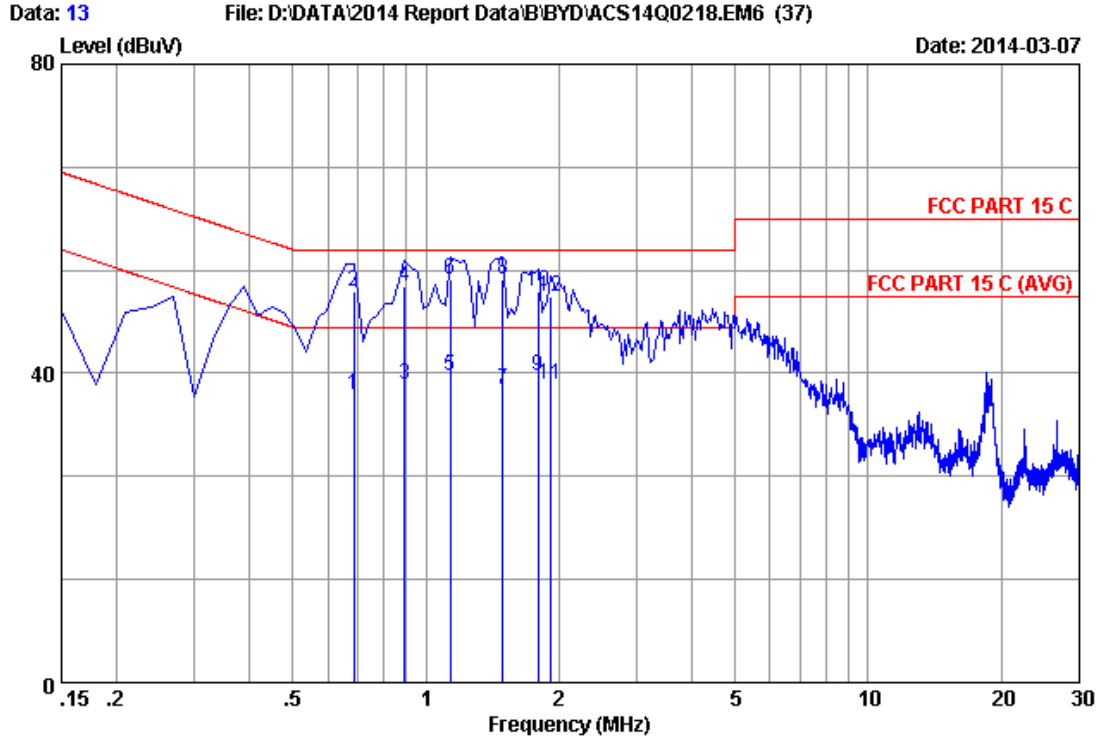

Site no :1#conduction Data No :13
 Dis./Ant. :2014 ESH2-25 LINE
 Limit :FCC PART 15 C
 Env./Ins. :25.3*C/50% Engineer :Kevin_Hu
 EUT :Notebook
 Power Rating :DC 19V From Adapter Input AC 120V/60Hz
 Test Mode :Tx Mode (BT4.0)
 M/N:RZ09-0116

No	Freq (MHz)	LISN Factor (dB)	Cable Loss (dB)	Reading (dBuV)	Emission Level (dBuV)	Limits (dBuV)	Margin (dB)	Remark
1	0.68700	0.16	9.89	27.20	37.25	46.00	8.75	Average
2	0.68700	0.16	9.89	40.50	50.55	56.00	5.45	QP
3	0.89600	0.17	9.89	28.60	38.66	46.00	7.34	Average
4	0.89600	0.17	9.89	41.30	51.36	56.00	4.64	QP
5	1.135	0.17	9.89	29.51	39.57	46.00	6.43	Average
6	1.135	0.17	9.89	42.01	52.07	56.00	3.93	QP
7	1.490	0.18	9.90	27.90	37.98	46.00	8.02	Average
8	1.490	0.18	9.90	42.00	52.08	56.00	3.92	QP
9	1.790	0.19	9.91	29.59	39.69	46.00	6.31	Average
10	1.790	0.19	9.91	40.49	50.59	56.00	5.41	QP
11	1.910	0.19	9.91	28.50	38.60	46.00	7.40	Average
12	1.910	0.19	9.91	39.80	49.90	56.00	6.10	QP

Remarks: 1.Emission Level=LISN Factor+Cable Loss(Include Pulse limiter)+Reading.
 2.If the average limit is met when using a quasi-peak detector, the EUT shall be deemed to meet both limits and measurement with average detector is unnecessary.

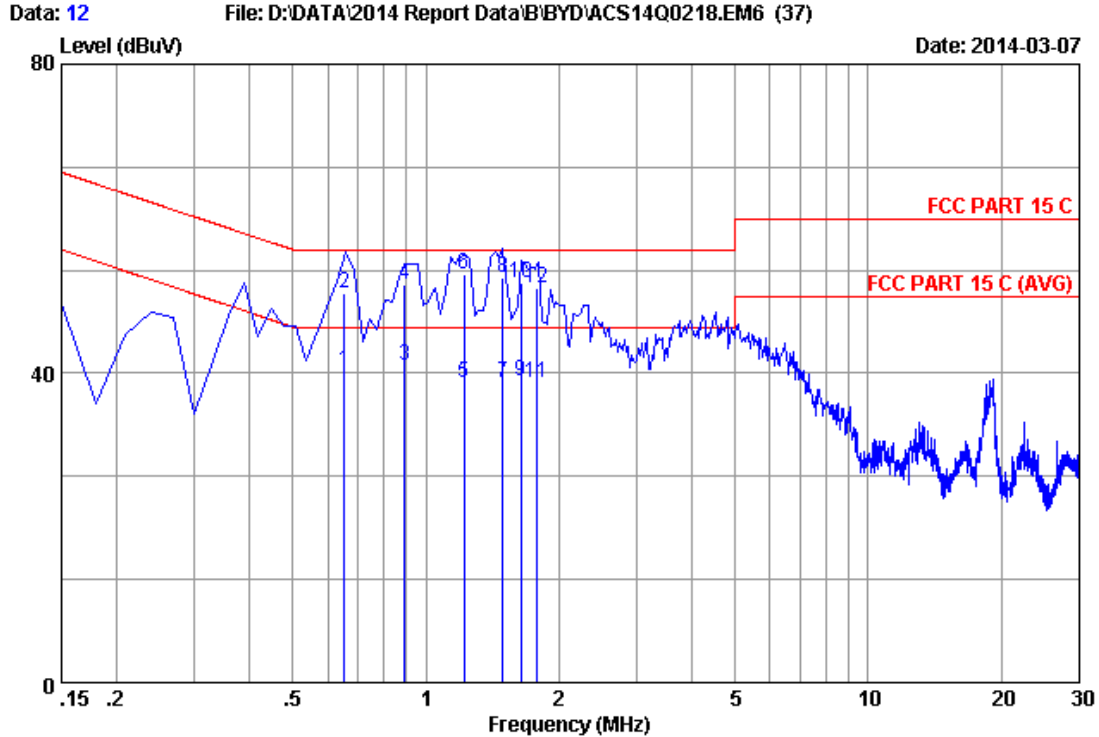

Site no :1#conduction Data No :12
 Dis./Ant. :2014 ESH2-Z5 NEUTRAL
 Limit :FCC PART 15 C
 Env./Ins. :25.3*C/50% Engineer :Kevin_Hu
 EUT :Notebook
 Power Rating :DC 19V From Adapter Input AC 120V/60Hz
 Test Mode :Tx Mode(BT4.0)
 M/N:RZ09-0116

No	Freq (MHz)	LISN Factor (dB)	Cable Loss (dB)	Reading (dBuV)	Emission Level (dBuV)	Limits (dBuV)	Margin (dB)	Remark
1	0.65300	0.15	9.89	30.30	40.34	46.00	5.66	Average
2	0.65300	0.15	9.89	40.30	50.34	56.00	5.66	QP
3	0.89600	0.16	9.89	30.90	40.95	46.00	5.05	Average
4	0.89600	0.16	9.89	41.40	51.45	56.00	4.55	QP
5	1.220	0.18	9.90	28.59	38.67	46.00	7.33	Average
6	1.220	0.18	9.90	42.79	52.87	56.00	3.13	QP
7	1.490	0.19	9.90	28.60	38.69	46.00	7.31	Average
8	1.490	0.19	9.90	42.30	52.39	56.00	3.61	QP
9	1.640	0.19	9.90	28.80	38.89	46.00	7.11	Average
10	1.640	0.19	9.90	41.50	51.59	56.00	4.41	QP
11	1.780	0.19	9.91	28.70	38.80	46.00	7.20	Average
12	1.780	0.19	9.91	40.90	51.00	56.00	5.00	QP

Remarks: 1.Emission Level=LISN Factor+Cable Loss(Include Pulse limiter)+Reading.
 2.If the average limit is met when using a quasi-peak detector, the EUT shall be deemed to meet both limits and measurement with average detector is unnecessary.

4. RADIATED EMISSION MEASUREMENT

4.1. Test Equipment

Frequency rang: 30~1000MHz

Item	Equipment	Manufacturer	Model No.	Serial No.	Last Cal.	Cal. Interval
1	3#Chamber	AUDIX	N/A	N/A	Nov.24, 13	1 Year
2	EMI Spectrum	Agilent	E4407B	MY41440292	May.08, 13	1 Year
3	Test Receiver	Rohde & Schwarz	ESVS10	834468/011	May.08, 13	1 Year
4	Amplifier	HP	8447D	2648A04738	May.08, 13	1 Year
5	Bilog Antenna	TESEQ	CBL6112D	35375	May.30, 13	1 Year
6	RF Cable	MIYAZAKI	CFD400-NL	3# Chamber No.1	May.08, 13	1 Year
7	Coaxial Switch	Anritsu	MP59B	M74389	May.08, 13	1 Year

Frequency rang: above 1000MHz

Item	Equipment	Manufacturer	Model No.	Serial No.	Last Cal.	Cal. Interval
1	Spectrum Analyzer	Agilent	E4407B	MY41440292	May.08, 13	1 Year
2	Horn Antenna	EMCO	3115	9510-4580	May.28, 13	1 Year
3	Amplifier	Agilent	8449B	3008A00863	May.08, 13	1 Year
4	RF Cable	Hubersuhner	SUCOFLEX106	77980/6	May.08, 13	1 Year
5	RF Cable	Hubersuhner	SUCOFLEX106	77977/6	May.08, 13	1 Year
6	Horn Antenna	EMCO	3116	00060089	Aug.28, 13	1 Year

4.2. Block Diagram of Test Setup
For frequency range 30MHz-1000MHz

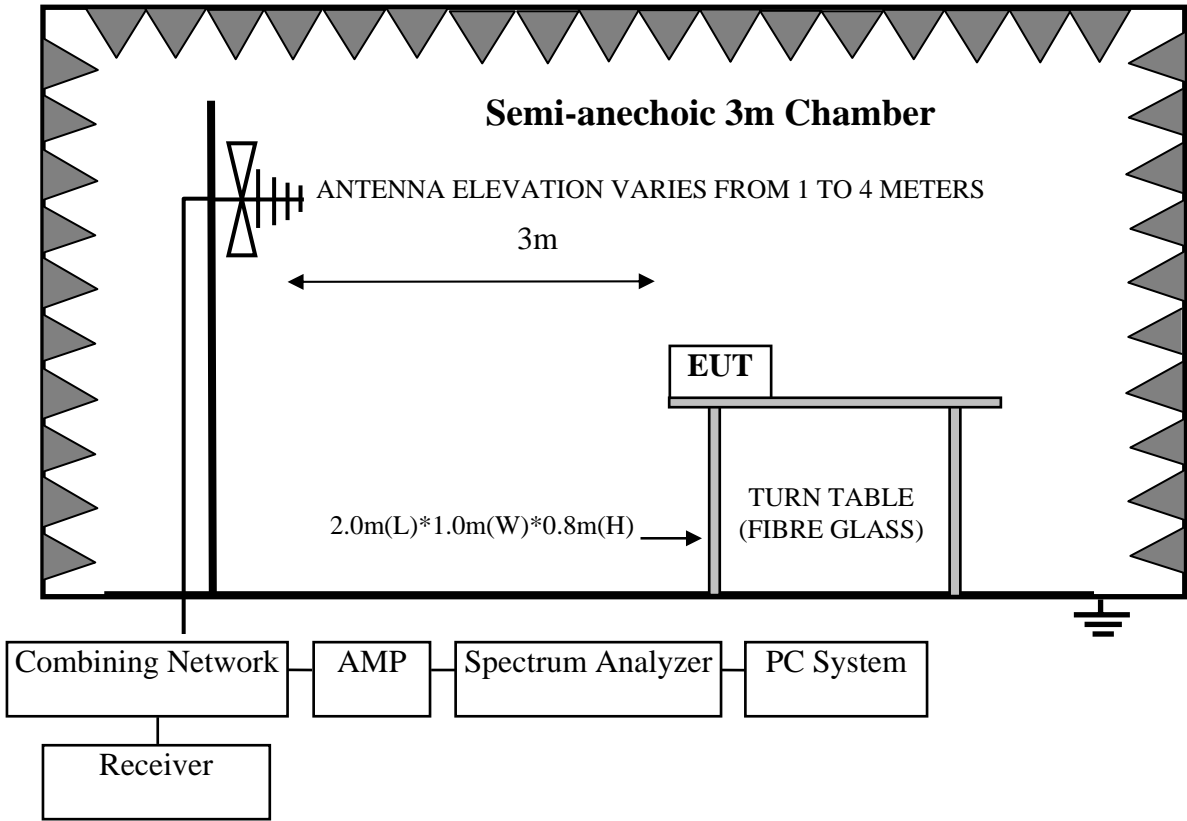

For frequency range 1GHz-25GHz

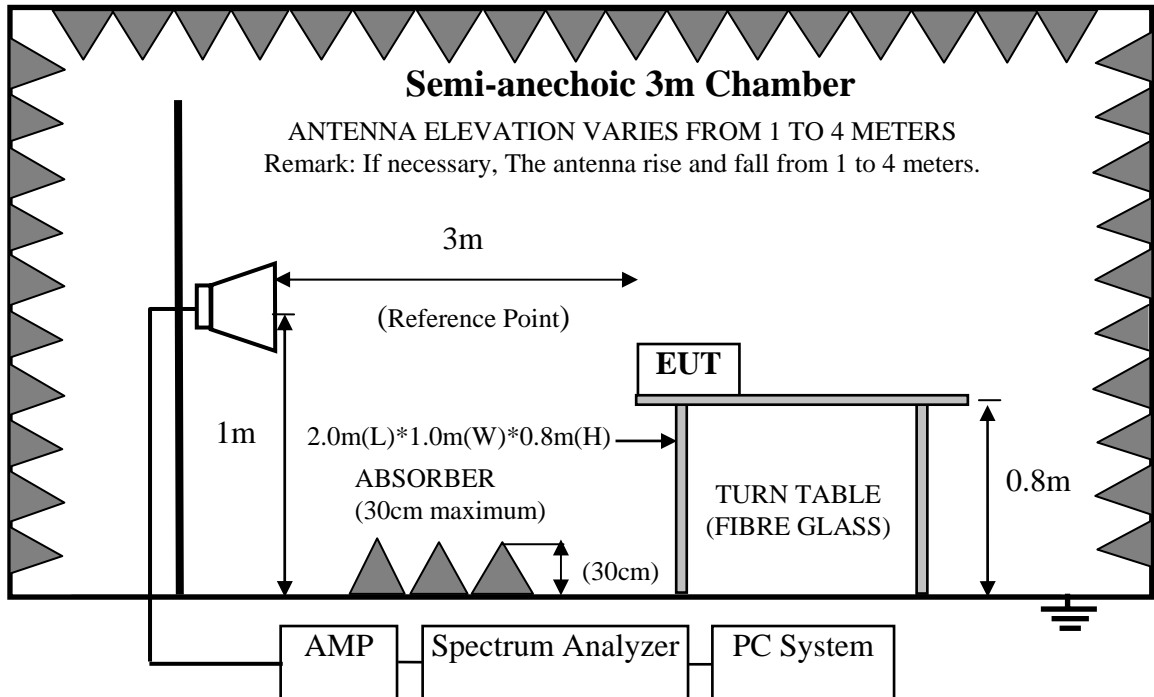

4.3.Radiated Emission Limit Standard: FCC 15.209

FREQUENCY MHz	DISTANCE Meters	FIELD STRENGTHS LIMIT	
		μV/m	dB(μV)/m
30 ~ 88	3	100	40.0
88 ~ 216	3	150	43.5
216 ~ 960	3	200	46.0
960 ~ 1000	3	500	54.0
Above 1000MHz	3	74.0 dB(μV)/m (Peak) 54.0 dB(μV)/m (Average)	

- Remark :
- (1) Emission level dBμV = 20 log Emission level μV/m
 - (2) The smaller limit shall apply at the cross point between two frequency bands.
 - (3) Distance is the distance in meters between the measuring instrument, antenna and the closest point of any part of the device or system.
 - (4) The emission limits shown in the above table are based on measurements employing a CISPR quasi-peak detector except for the frequency bands 9-90 kHz, 110-490 kHz and above 1000 MHz. Radiated emission limits in these three bands are based on measurements employing an average detector.

4.4.EUT Configuration on Test

The following equipment are installed on Radiated Emission Test to meet the commission requirements and operating regulations in a manner which tends to maximize its emission characteristics in normal application.

4.4.1. Notebook (EUT)

Model Number : RZ09-0116
 Serial Number : N/A

4.5.Operating Condition of EUT

- 4.5.1. Setup the EUT and simulator as shown as Section 3.2.
- 4.5.2. Turned on the power of all equipment.
- 4.5.3. Let EUT work in Tx mode.

4.6.Test Procedure

The EUT and its simulators are placed on a turn table, which is 0.8 meter high above ground. The turn table can rotate 360 degrees to determine the position of the maximum emission level. The EUT is set 3 meters away from the receiving antenna, which is mounted on a antenna tower. The antenna can be moved up and down between 1 meter and 4 meters to find out the maximum emission level. Broadband antenna (calibrated bilog antenna) is used as receiving antenna. Both horizontal and vertical polarization of the antenna is set on Test. In order to find the maximum emission levels, all of the interface cables must be manipulated according to ANSI C63.10-2009 on radiated emission Test.

This test was performed with EUT in X, Y, Z position, and the worse case was found when EUT in X position as the test photo indicated.

The bandwidth of the EMI test receiver (R&S ESVS10) is set at 120kHz for frequency range from 30MHz to 1000 MHz.

The bandwidth of the Spectrum's RBW is set at 1MHz and VBW is set at 3MHz for peak emissions measurement and RBW is set at 1MHz, VBW is set at 10Hz for average emission measurement above 1GHz.

The duty cycle of the test signal is 100%.

The frequency range from 30MHz to 10th harmonic (25GHz) are checked. and no any emissions were found from 18GHz to 25 GHz, So the radiated emissions from 18GHz to 25GHz were not record.

4.7.Radiated Emission Test Results

PASS.

Frequency: 30MHz~1GHz

Data: 5

File: E:\2014 Report Data\B\BYD\ACS1400218.EM6 (56)

Date: 2014-03-01

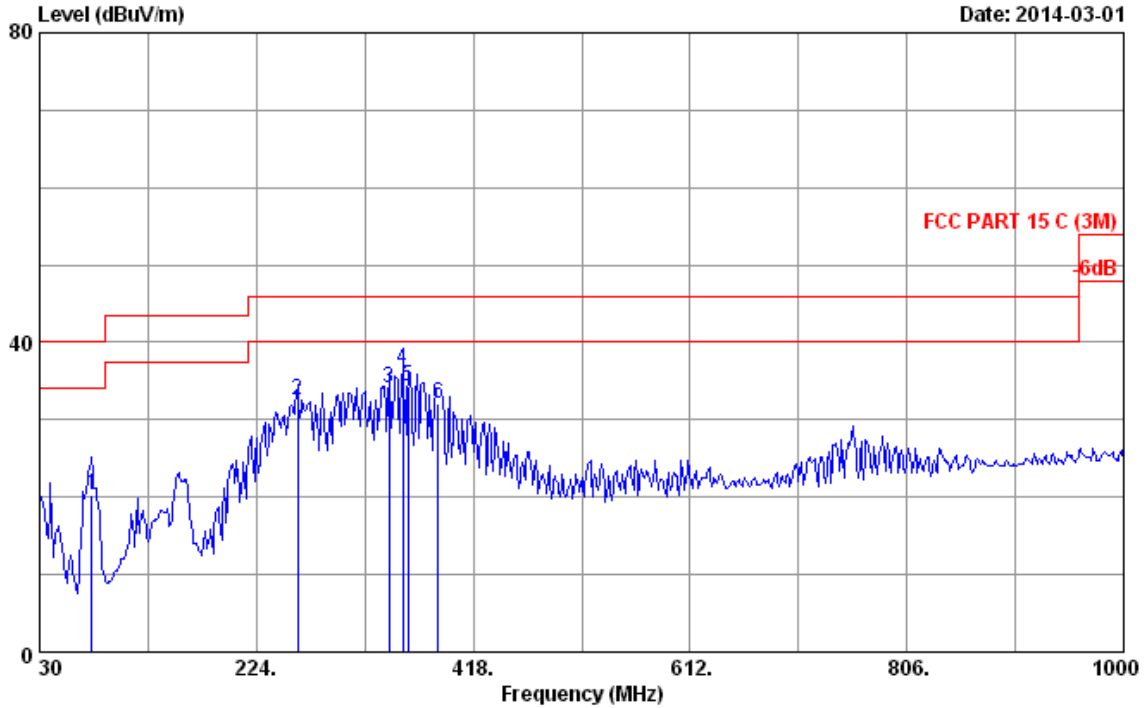

Site no. : 3m Chamber Data no. : 5
 Dis. / Ant. : 3m 2013 CBL6112D 35375 Ant. pol. : HORIZONTAL
 Limit : FCC PART 15 C (3M)
 Env. / Ins. : 24°C/34% Engineer : Donjon
 EUT : Notebook M/N:RZ09-0116
 Power rating : DC 19V Adapter Input AC 120V/60Hz
 Test Mode : TX Mode (BT4.0)

No.	Freq. (MHz)	Ant. Factor (dB/m)	Cable Loss (dB)	Reading (dBuV)	Emission Level (dBuV/m)	Limits (dBuV/m)	Margin (dB)	Remark
1	76.560	7.26	1.31	11.70	20.27	40.00	19.73	QP
2	260.860	14.00	2.02	16.41	32.43	46.00	13.57	QP
3	342.340	15.05	2.29	16.74	34.08	46.00	11.92	QP
4	354.950	15.60	2.33	18.53	36.46	46.00	9.54	QP
5	359.800	15.70	2.34	16.38	34.42	46.00	11.58	QP
6	386.960	16.08	2.42	13.57	32.07	46.00	13.93	QP

Remarks: 1. Emission Level= Antenna Factor + Cable Loss + Reading.
 2. The emission levels that are 20dB below the official limit are not reported.

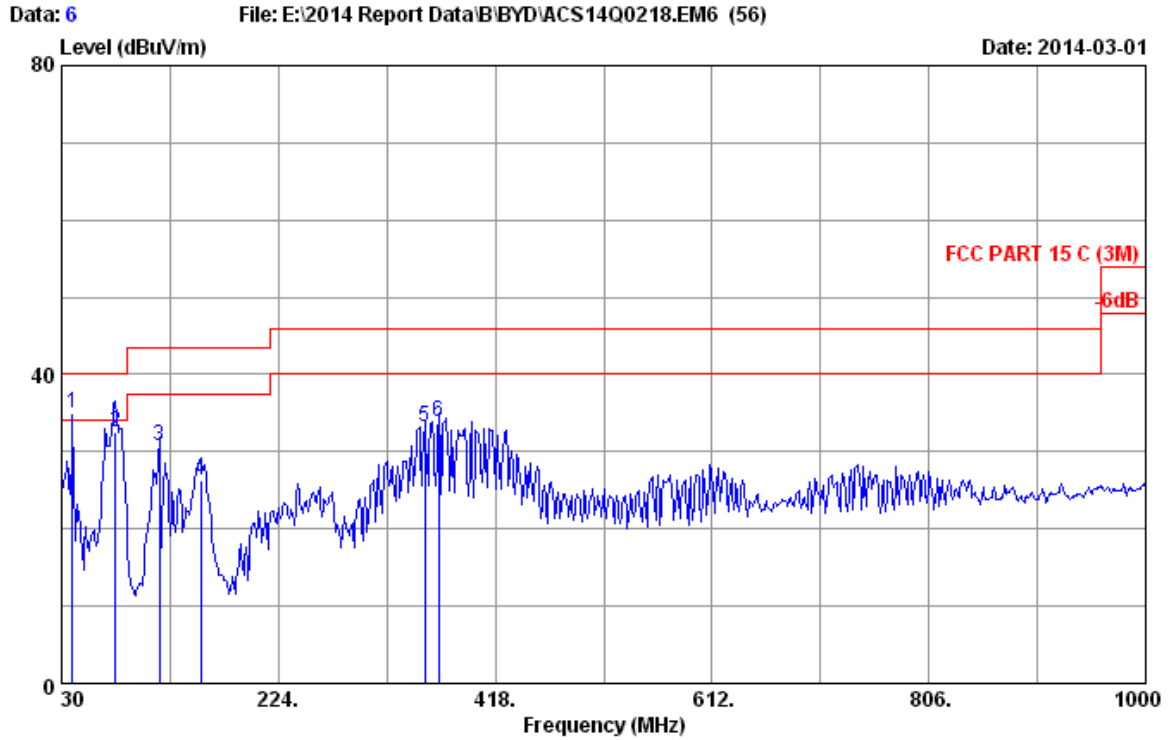

Site no. : 3m Chamber Data no. : 6
 Dis. / Ant. : 3m 2013 CBL6112D 35375 Ant. pol. : VERTICAL
 Limit : FCC PART 15 C (3M)
 Env. / Ins. : 24°C/34% Engineer : Donjon
 EUT : Notebook M/N:RZ09-0116
 Power rating : DC 19V Adapter Input AC 120V/60Hz
 Test Mode : TX Mode (BT4.0)

No.	Freq. (MHz)	Ant. Factor (dB/m)	Cable Loss (dB)	Reading (dBuV)	Emission Level (dBuV/m)	Limits (dBuV/m)	Margin (dB)	Remark
1	39.600	14.32	1.00	19.70	35.02	40.00	4.98	QP
2	78.500	7.45	1.32	23.73	32.50	40.00	7.50	QP
3	117.300	12.70	1.48	16.58	30.76	43.50	12.74	QP
4	154.160	11.09	1.62	13.55	26.26	43.50	17.24	QP
5	354.950	15.60	2.33	15.18	33.11	46.00	12.89	QP
6	367.560	15.70	2.37	15.88	33.95	46.00	12.05	QP

Remarks: 1. Emission Level= Antenna Factor + Cable Loss + Reading.
 2. The emission levels that are 20dB below the official limit are not reported.

Frequency: 1GHz~18GHz

Data: 5

File: G:\2014 Report\B\BYD\ACS14Q0218-FCC-BT4.0.EM6 (16)

Date: 2014-02-20

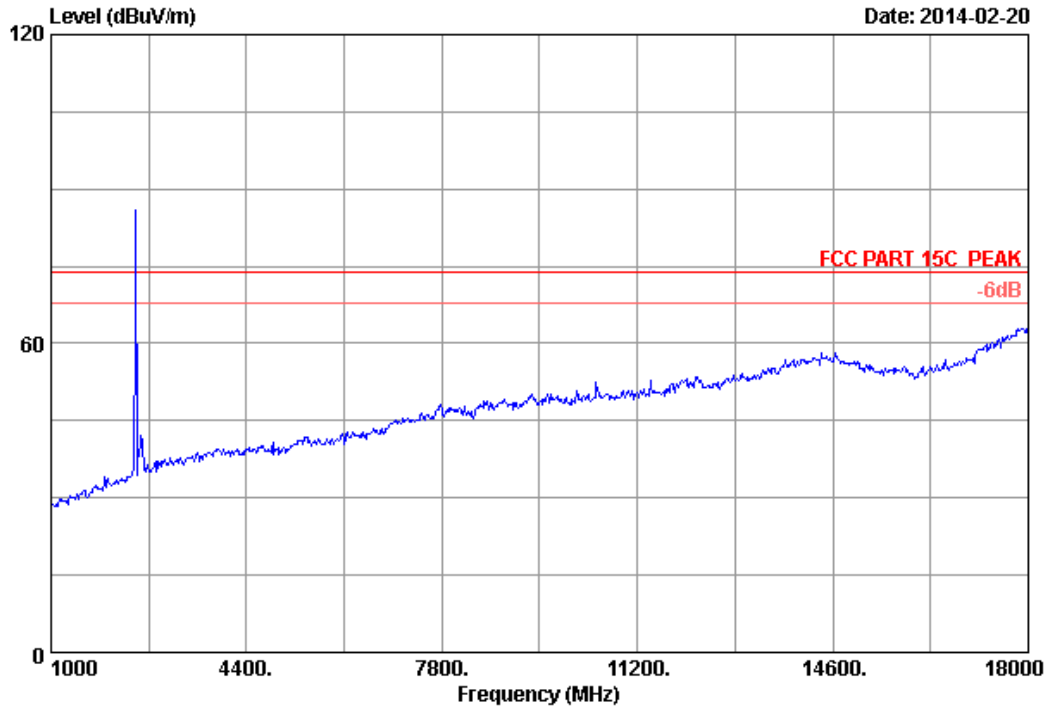

Site no. : 3m Chamber Data no. : 5
Dis. / Ant. : 3m 2013 3115 (4580) Ant. pol. : HORIZONTAL
Limit : FCC PART 15C PEAK
Env. / Ins. : 24°C/56% Engineer : Leo-Li
EUT : Notebook
Power Rating : DC 19V From Adapter Input AC 120V/60Hz
Test Mode : 2480MHz Tx Mode
M/N : R209-0116

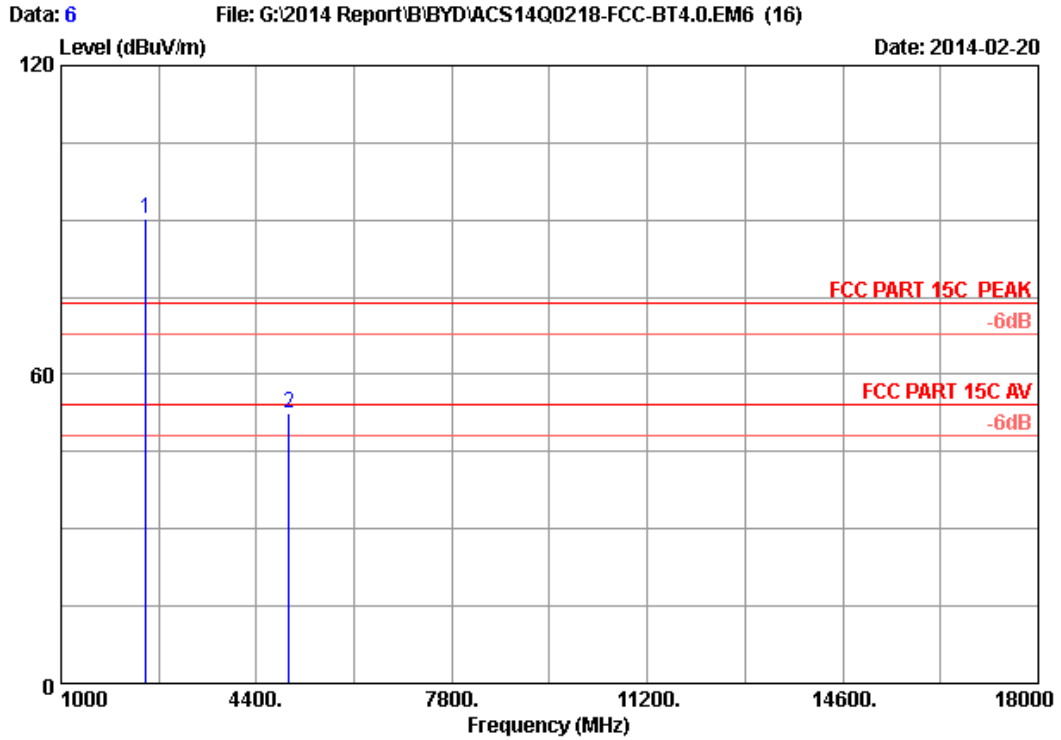

Site no. : 3m Chamber Data no. : 6
 Dis. / Ant. : 3m 2013 3115 (4580) Ant. pol. : HORIZONTAL
 Limit : FCC PART 15C PEAK
 Env. / Ins. : 24°C/56% Engineer : Leo-Li
 EUT : Notebook
 Power Rating : DC 19V From Adapter Input AC 120V/60Hz
 Test Mode : 2480MHz Tx Mode
 M/N : RZ09-0116

No.	Freq. (MHz)	Ant. Factor (dB/m)	Cable Loss (dB)	AMP factor (dB)	Reading (dBuV)	Emission Level (dBuV/m)	Limits (dBuV/m)	Margin (dB)	Remark
1	2480.000	28.36	5.91	35.70	91.58	90.15	74.00	-16.15	Peak
2	4960.000	33.13	8.72	35.70	46.39	52.54	74.00	21.46	Peak

Remarks: 1. Emission Level= Antenna Factor + Cable Loss + Reading - Amp Factor
 2. The emission levels that are 20dB below the official limit are not reported.

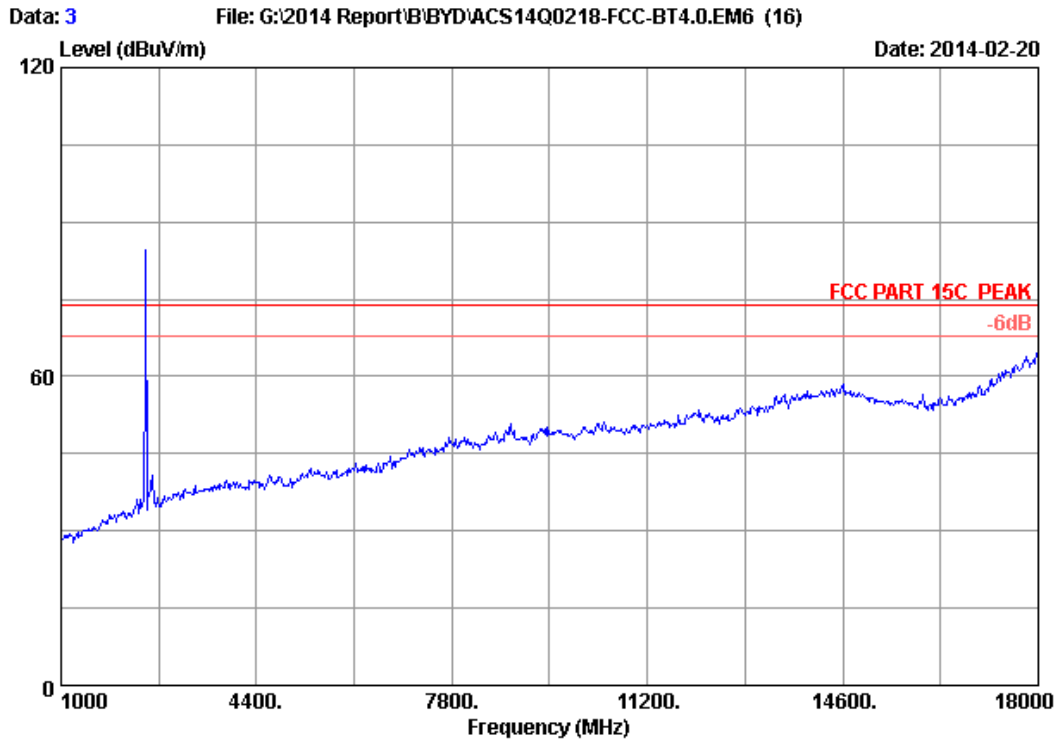

Site no. : 3m Chamber Data no. : 3
Dis. / Ant. : 3m 2013 3115 (4580) Ant. pol. : VERTICAL
Limit : FCC PART 15C PEAK
Env. / Ins. : 24°C/56% Engineer : Leo-Li
EUT : Notebook
Power Rating : DC 19V From Adapter Input AC 120V/60Hz
Test Mode : 2480MHz Tx Mode
M/N : RZ09-0116

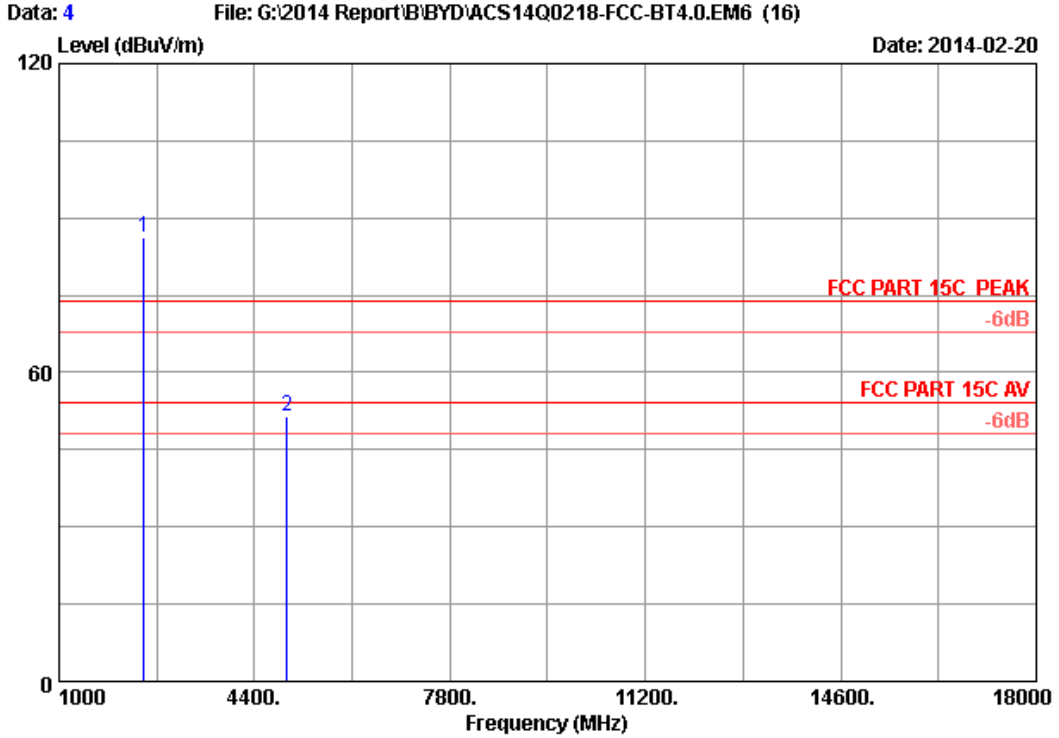

Site no. : 3m Chamber Data no. : 4
 Dis. / Ant. : 3m 2013 3115 (4580) Ant. pol. : VERTICAL
 Limit : FCC PART 15C PEAK
 Env. / Ins. : 24°C/56% Engineer : Leo-Li
 EUT : Notebook
 Power Rating : DC 19V From Adapter Input AC 120V/60Hz
 Test Mode : 2480MHz Tx Mode
 M/N : RZ09-0116

No.	Freq. (MHz)	Ant. Factor (dB/m)	Cable Loss (dB)	AMP factor (dB)	Reading (dBuV)	Emission Level (dBuV/m)	Limits (dBuV/m)	Margin (dB)	Remark
1	2480.000	28.36	5.91	35.70	87.59	86.16	74.00	-12.16	Peak
2	4960.000	33.13	8.72	35.70	45.39	51.54	74.00	22.46	Peak

Remarks: 1. Emission Level= Antenna Factor + Cable Loss + Reading - Amp Factor
 2. The emission levels that are 20dB below the official limit are not reported.

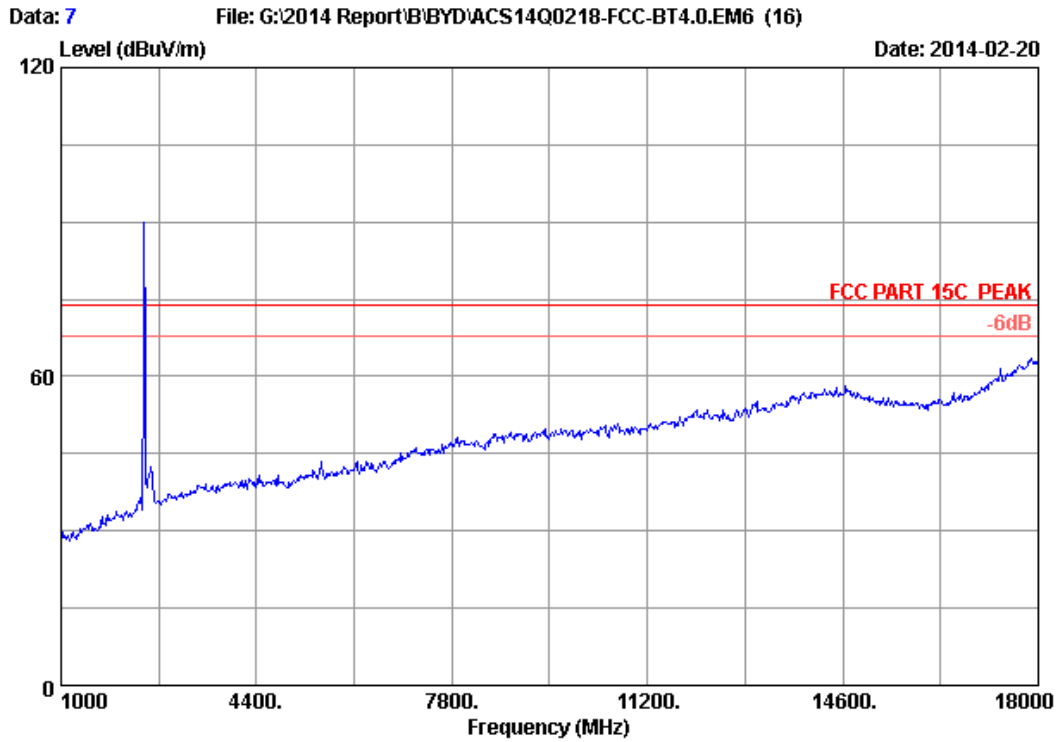

Site no. : 3m Chamber Data no. : 7
Dis. / Ant. : 3m 2013 3115 (4580) Ant. pol. : HORIZONTAL
Limit : FCC PART 15C PEAK
Env. / Ins. : 24°C/56% Engineer : Leo-Li
EUT : Notebook
Power Rating : DC 19V From Adapter Input AC 120V/60Hz
Test Mode : 2440MHz Tx Mode
M/N : RZ09-0116

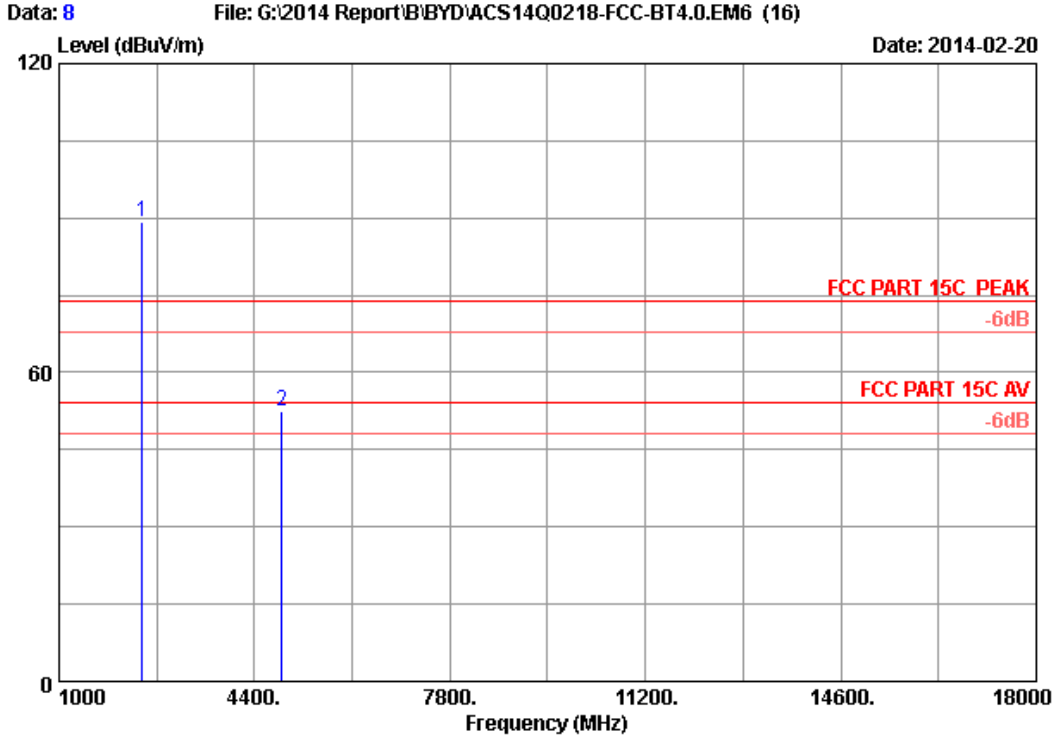

Site no. : 3m Chamber Data no. : 8
 Dis. / Ant. : 3m 2013 3115 (4580) Ant. pol. : HORIZONTAL
 Limit : FCC PART 15C PEAK
 Env. / Ins. : 24°C/56% Engineer : Leo-Li
 EUT : Notebook
 Power Rating : DC 19V From Adapter Input AC 120V/60Hz
 Test Mode : 2440MHz Tx Mode
 M/N : RZ09-0116

No.	Freq. (MHz)	Ant. Factor (dB/m)	Cable Loss (dB)	AMP factor (dB)	Reading (dBuV)	Emission Level (dBuV/m)	Limits (dBuV/m)	Margin (dB)	Remark
1	2440.000	28.27	5.86	35.70	90.90	89.33	74.00	-15.33	Peak
2	4880.000	32.98	8.64	35.70	46.64	52.56	74.00	21.44	Peak

Remarks: 1. Emission Level= Antenna Factor + Cable Loss + Reading - Amp Factor
 2. The emission levels that are 20dB below the official limit are not reported.

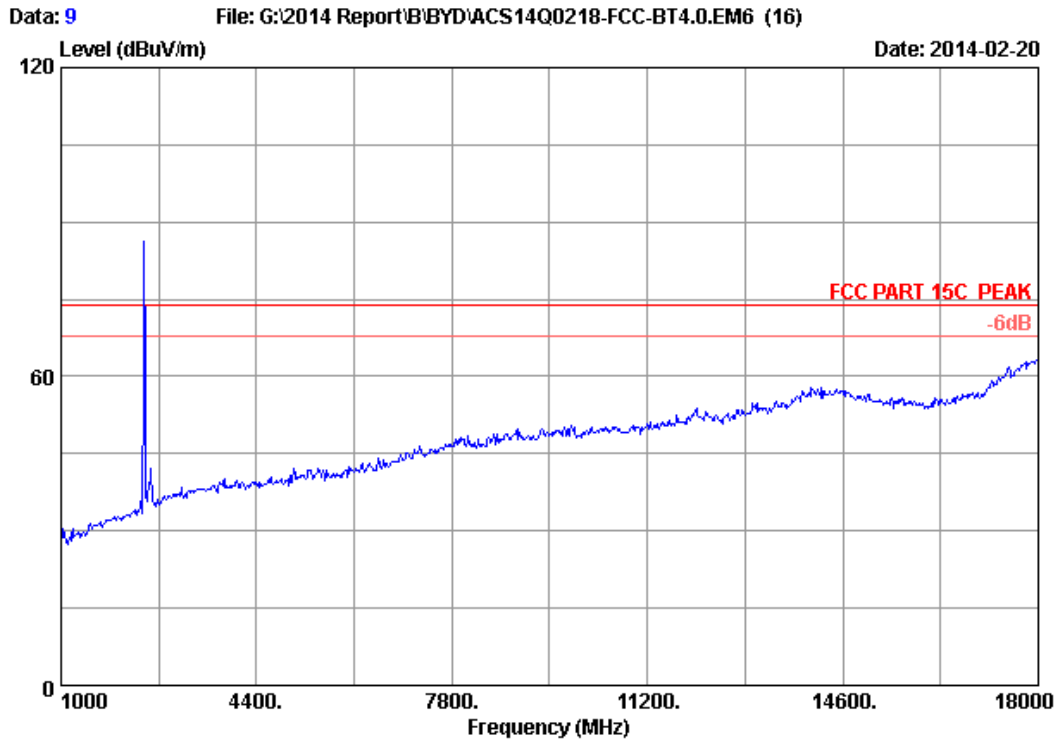

Site no. : 3m Chamber Data no. : 9
Dis. / Ant. : 3m 2013 3115 (4580) Ant. pol. : VERTICAL
Limit : FCC PART 15C PEAK
Env. / Ins. : 24°C/56% Engineer : Leo-Li
EUT : Notebook
Power Rating : DC 19V From Adapter Input AC 120V/60Hz
Test Mode : 2440MHz Tx Mode
M/N : RZ09-0116

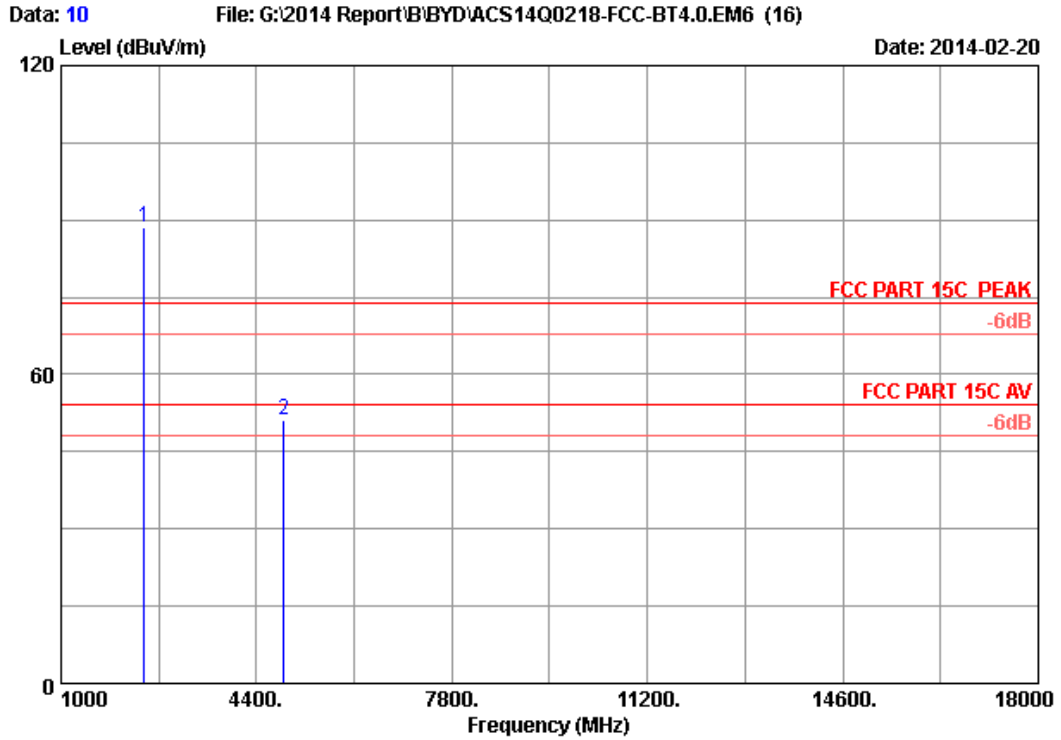

Site no. : 3m Chamber Data no. : 10
 Dis. / Ant. : 3m 2013 3115 (4580) Ant. pol. : VERTICAL
 Limit : FCC PART 15C PEAK
 Env. / Ins. : 24°C/56% Engineer : Leo-Li
 EUT : Notebook
 Power Rating : DC 19V From Adapter Input AC 120V/60Hz
 Test Mode : 2440MHz Tx Mode
 M/N : RZ09-0116

No.	Freq. (MHz)	Ant. Factor (dB/m)	Cable Loss (dB)	AMP factor (dB)	Reading (dBuV)	Emission Level (dBuV/m)	Limits (dBuV/m)	Margin (dB)	Remark
1	2440.000	28.27	5.86	35.70	90.25	88.68	74.00	-14.68	Peak
2	4880.000	32.98	8.64	35.70	45.37	51.29	74.00	22.71	Peak

Remarks: 1. Emission Level= Antenna Factor + Cable Loss + Reading - Amp Factor
 2. The emission levels that are 20dB below the official limit are not reported.

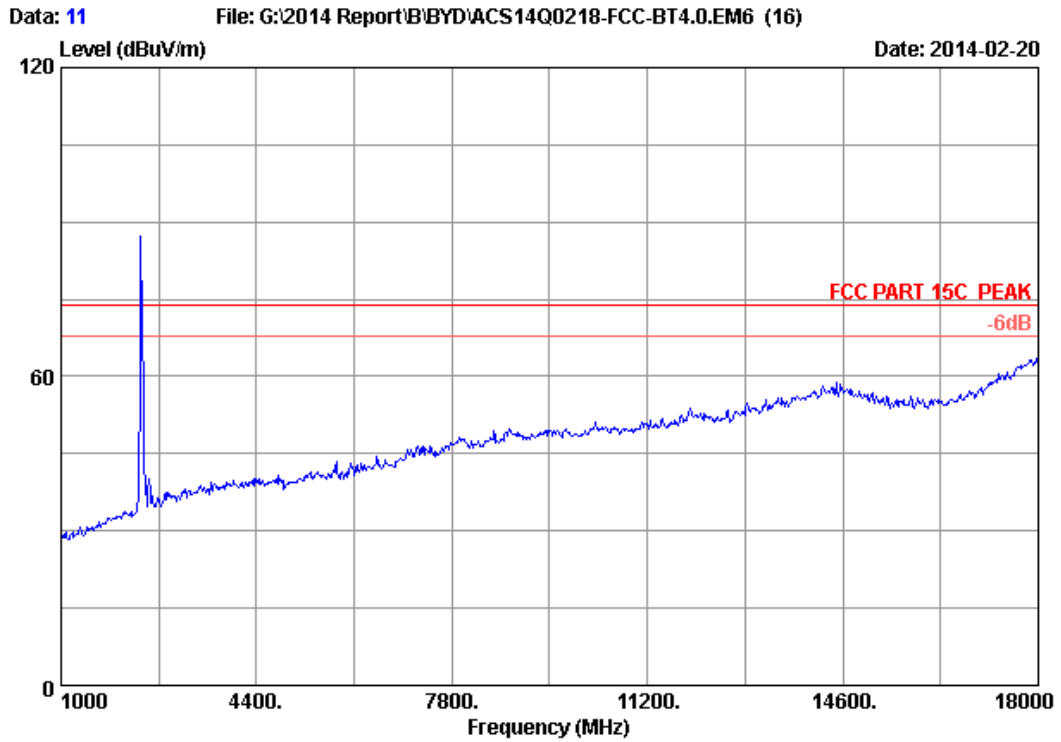

Site no. : 3m Chamber Data no. : 11
Dis. / Ant. : 3m 2013 3115 (4580) Ant. pol. : HORIZONTAL
Limit : FCC PART 15C PEAK
Env. / Ins. : 24°C/56% Engineer : Leo-Li
EUT : Notebook
Power Rating : DC 19V From Adapter Input AC 120V/60Hz
Test Mode : 2402MHz Tx Mode
M/N : RZ09-0116

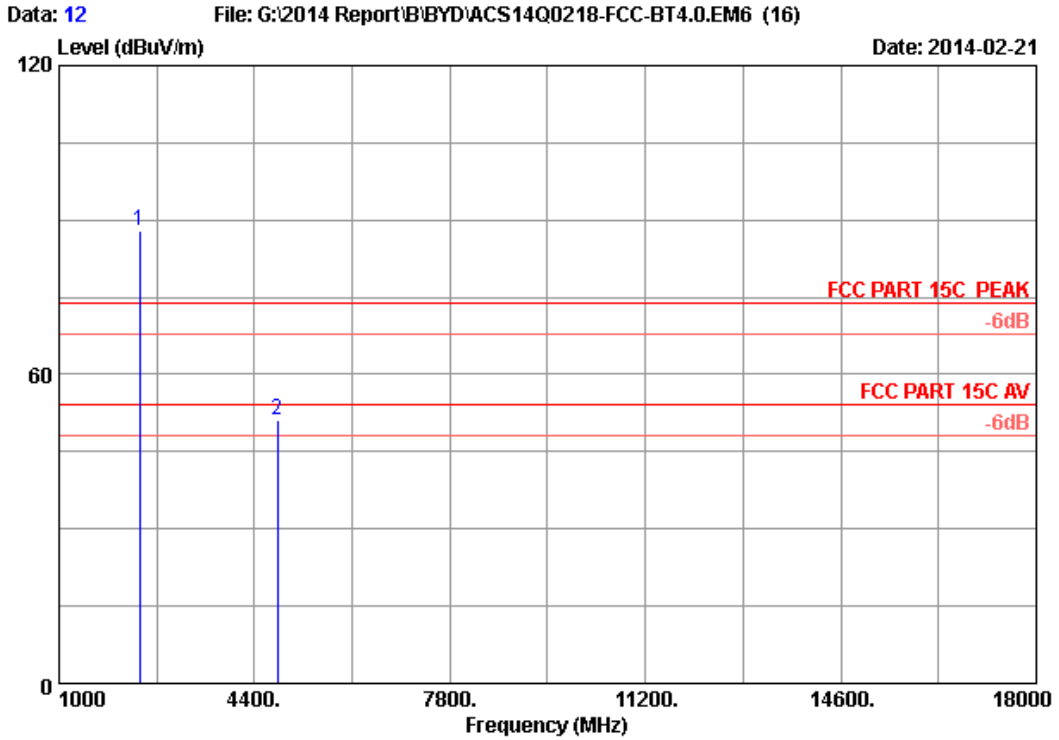

Site no. : 3m Chamber Data no. : 12
 Dis. / Ant. : 3m 2013 3115 (4580) Ant. pol. : HORIZONTAL
 Limit : FCC PART 15C PEAK
 Env. / Ins. : 24°C/56% Engineer : Leo-Li
 EUT : Notebook
 Power Rating : DC 19V From Adapter Input AC 120V/60Hz
 Test Mode : 2402MHz Tx Mode
 M/N : RZ09-0116

No.	Freq. (MHz)	Ant. Factor (dB/m)	Cable Loss (dB)	AMP factor (dB)	Reading (dBuV)	Emission Level (dBuV/m)	Limits (dBuV/m)	Margin (dB)	Remark
1	2402.000	28.18	5.80	35.70	89.69	87.97	74.00	-13.97	Peak
2	4804.000	32.85	8.56	35.70	45.39	51.10	74.00	22.90	Peak

Remarks: 1. Emission Level= Antenna Factor + Cable Loss + Reading - Amp Factor
 2. The emission levels that are 20dB below the official limit are not reported.

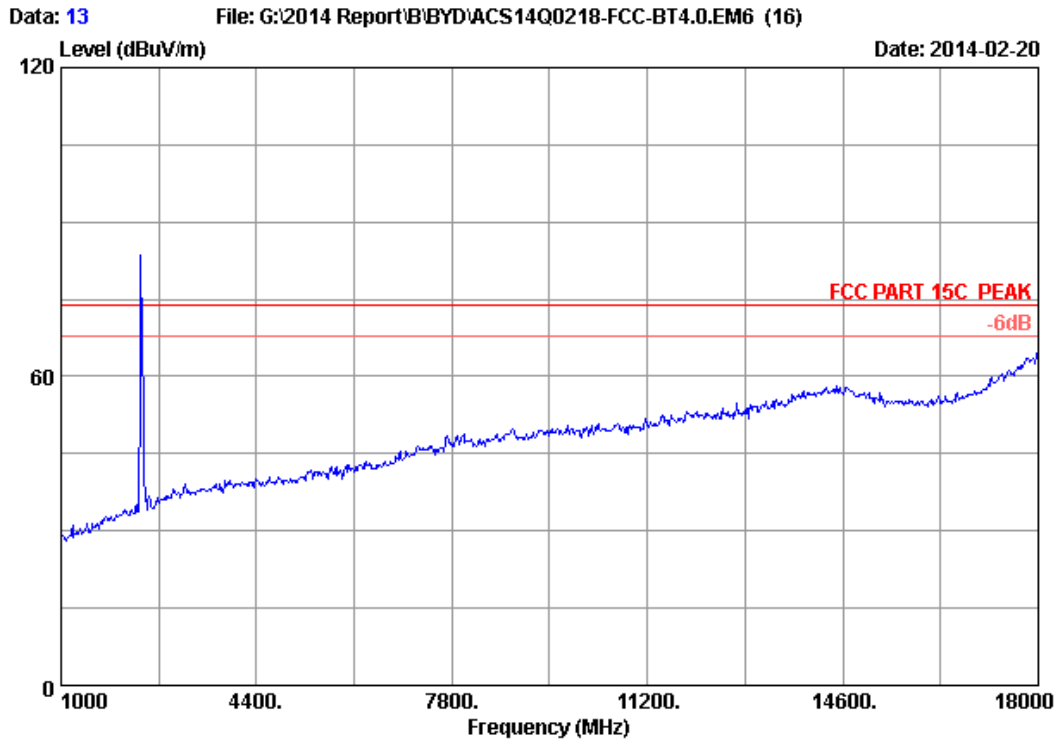

Site no. : 3m Chamber Data no. : 13
Dis. / Ant. : 3m 2013 3115 (4580) Ant. pol. : VERTICAL
Limit : FCC PART 15C PEAK
Env. / Ins. : 24°C/56% Engineer : Leo-Li
EUT : Notebook
Power Rating : DC 19V From Adapter Input AC 120V/60Hz
Test Mode : 2402MHz Tx Mode
M/N : RZ09-0116

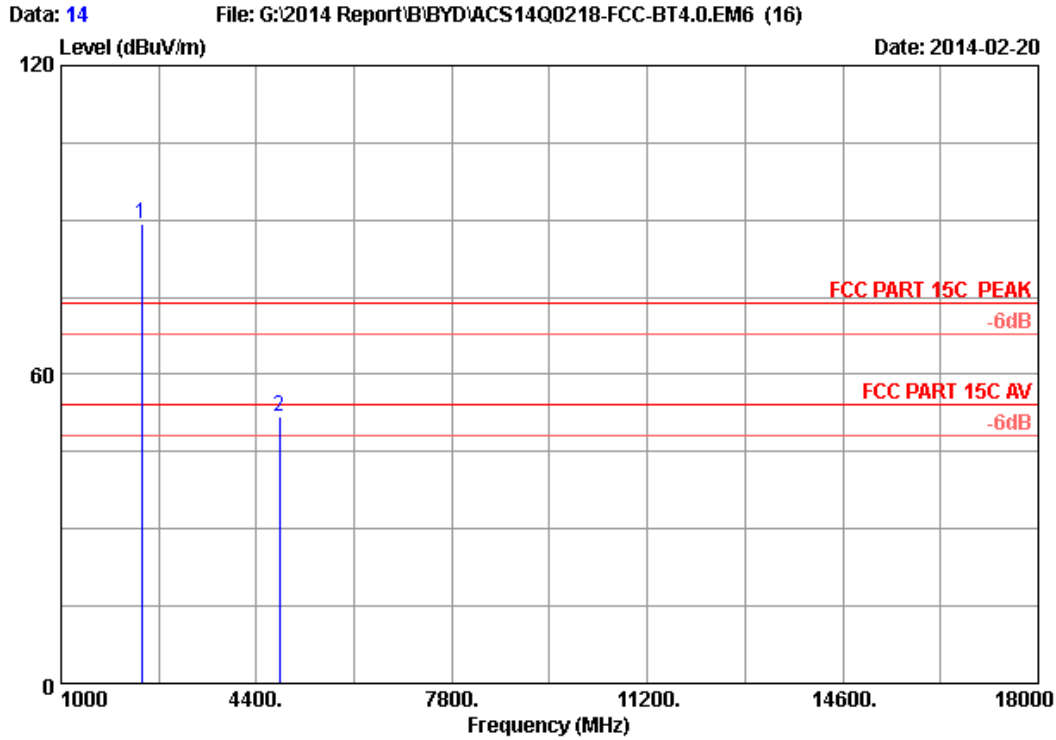

Site no. : 3m Chamber Data no. : 14
 Dis. / Ant. : 3m 2013 3115 (4580) Ant. pol. : VERTICAL
 Limit : FCC PART 15C PEAK
 Env. / Ins. : 24°C/56% Engineer : Leo-Li
 EUT : Notebook
 Power Rating : DC 19V From Adapter Input AC 120V/60Hz
 Test Mode : 2402MHz Tx Mode
 M/N : RZ09-0116

No.	Freq. (MHz)	Ant. Factor (dB/m)	Cable Loss (dB)	AMP factor (dB)	Reading (dBuV)	Emission Level (dBuV/m)	Limits (dBuV/m)	Margin (dB)	Remark
1	2402.000	28.18	5.80	35.70	90.87	89.15	74.00	-15.15	Peak
2	4804.000	32.85	8.56	35.70	45.97	51.68	74.00	22.32	Peak

Remarks: 1. Emission Level= Antenna Factor + Cable Loss + Reading - Amp Factor
 2. The emission levels that are 20dB below the official limit are not reported.

5. CONDUCTED SPURIOUS EMISSIONS

5.1. Test Equipment

Item	Equipment	Manufacturer	Model No.	Serial No.	Last Cal.	Cal. Interval
1.	Spectrum Analyzer	Agilent	N9030A	MY51380221	Oct.31, 13	1Year
2.	Attenuator	Agilent	8491B	MY39262165	May.08,13	1 Year
3.	RF Cable	Hubersuhner	SUCOFLEX102	28618/2	May.08,13	1Year

5.2. Limit

In any 100kHz bandwidth outside the frequency bands in which the spread spectrum intentional radiator is operating, the radio frequency power that is produced by the intentional radiator shall be at least 20dB below that in the 100kHz bandwidth within the band that contains the highest level of the desired power.

5.3. Test Procedure

The transmitter output was connected to a spectrum analyzer, The resolution bandwidth is set to 100 kHz, The video bandwidth is set to 300 kHz and measure all the emissions detected.

5.4. Test result

PASS (The testing data was attached in the next pages.)

GFSK
2402MHz

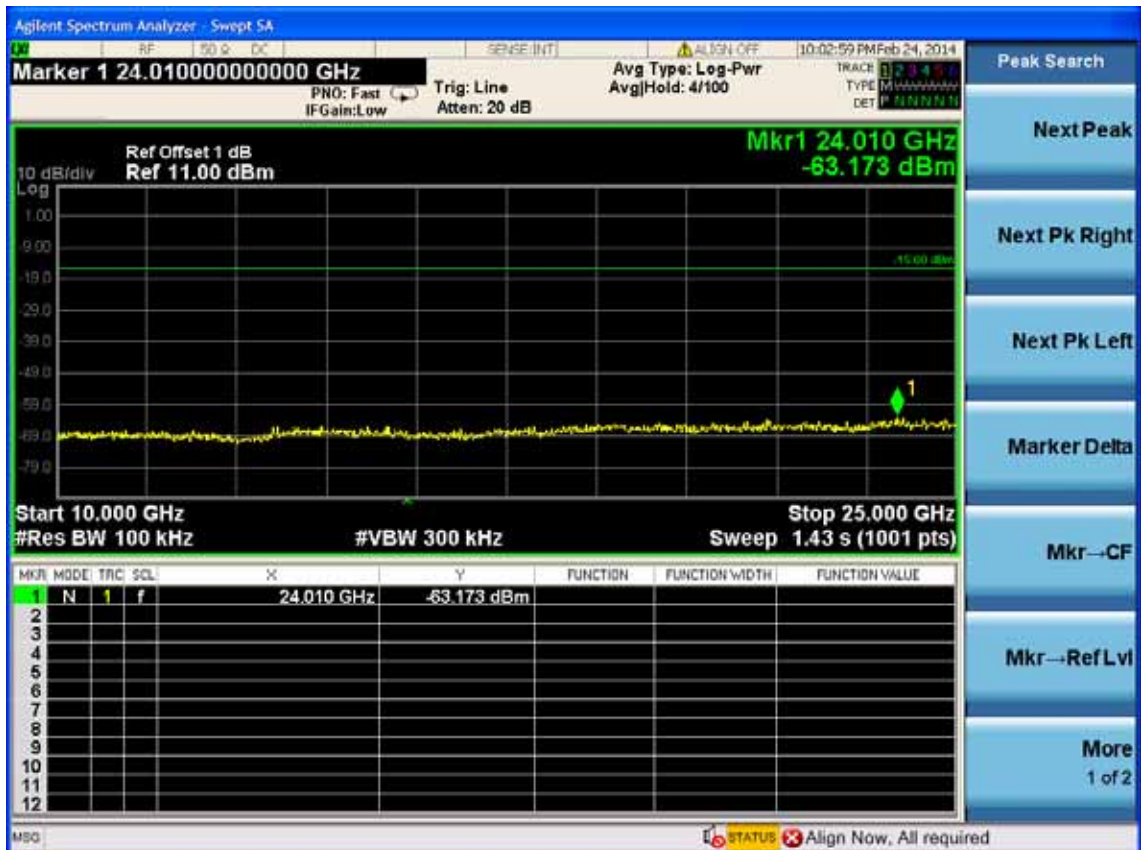
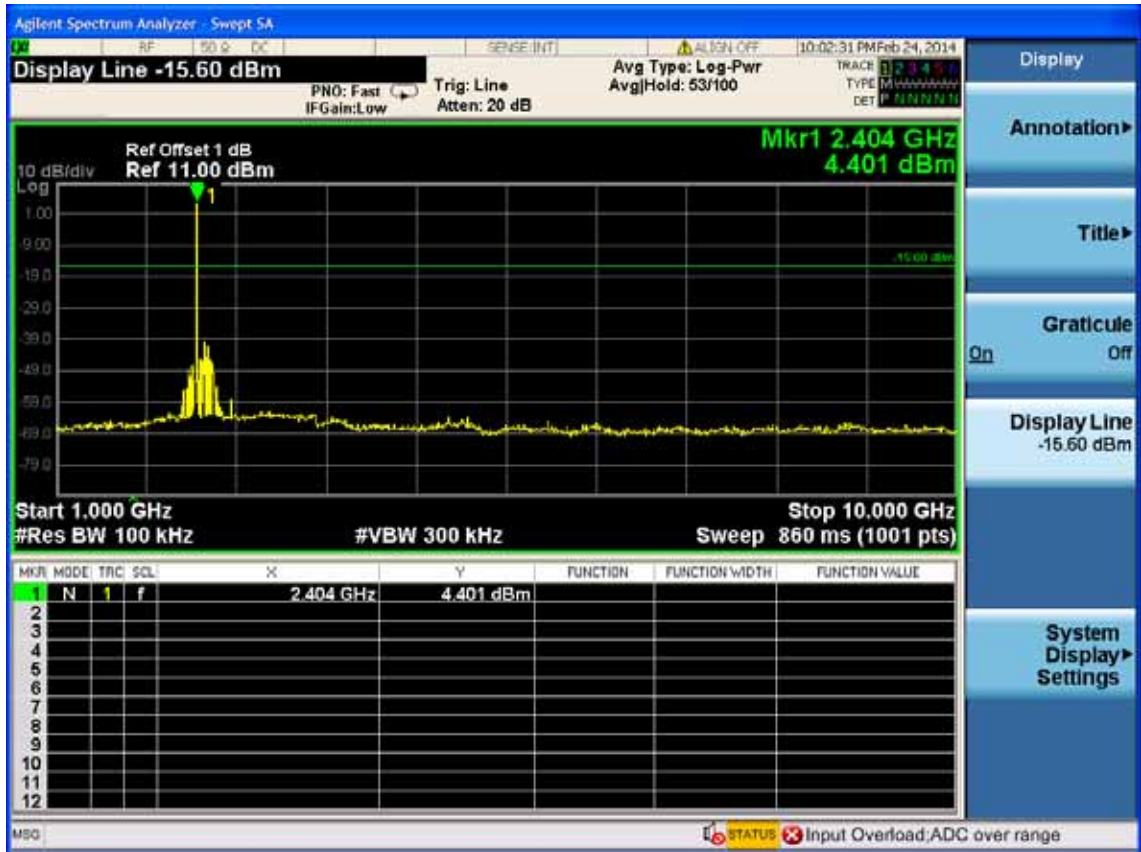

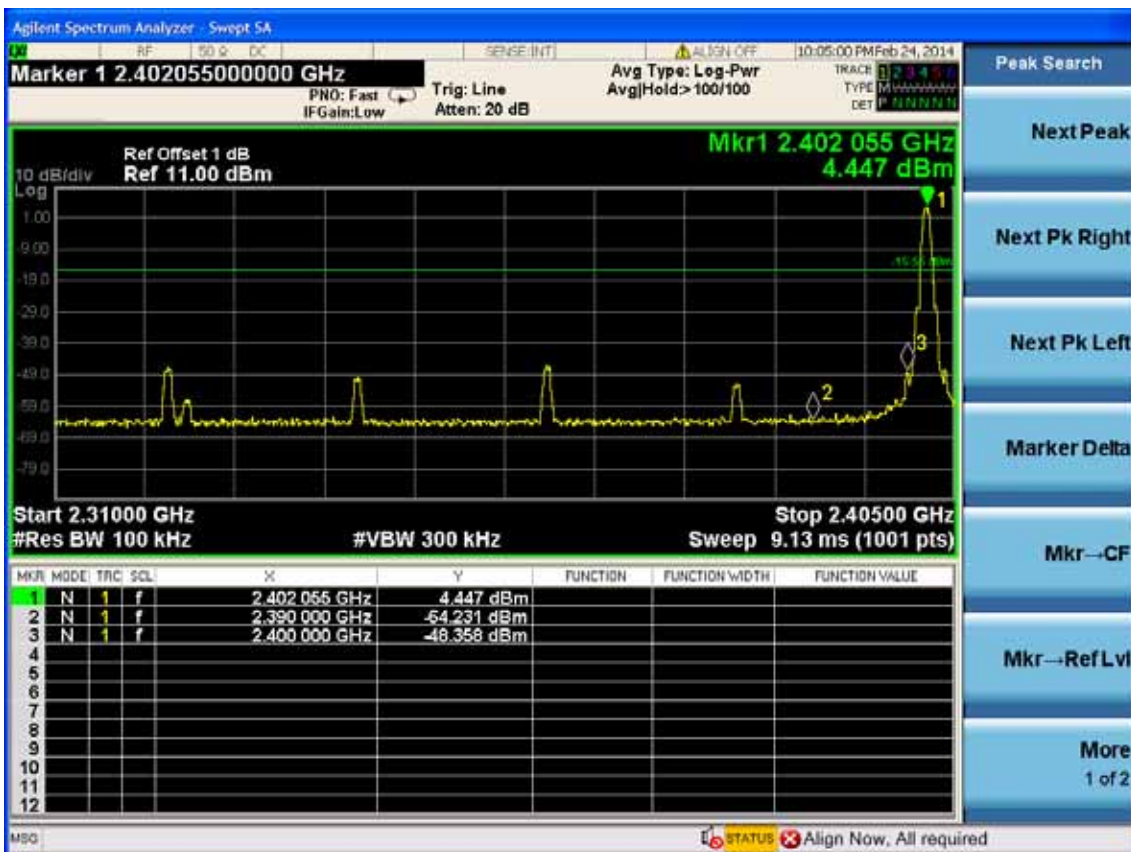
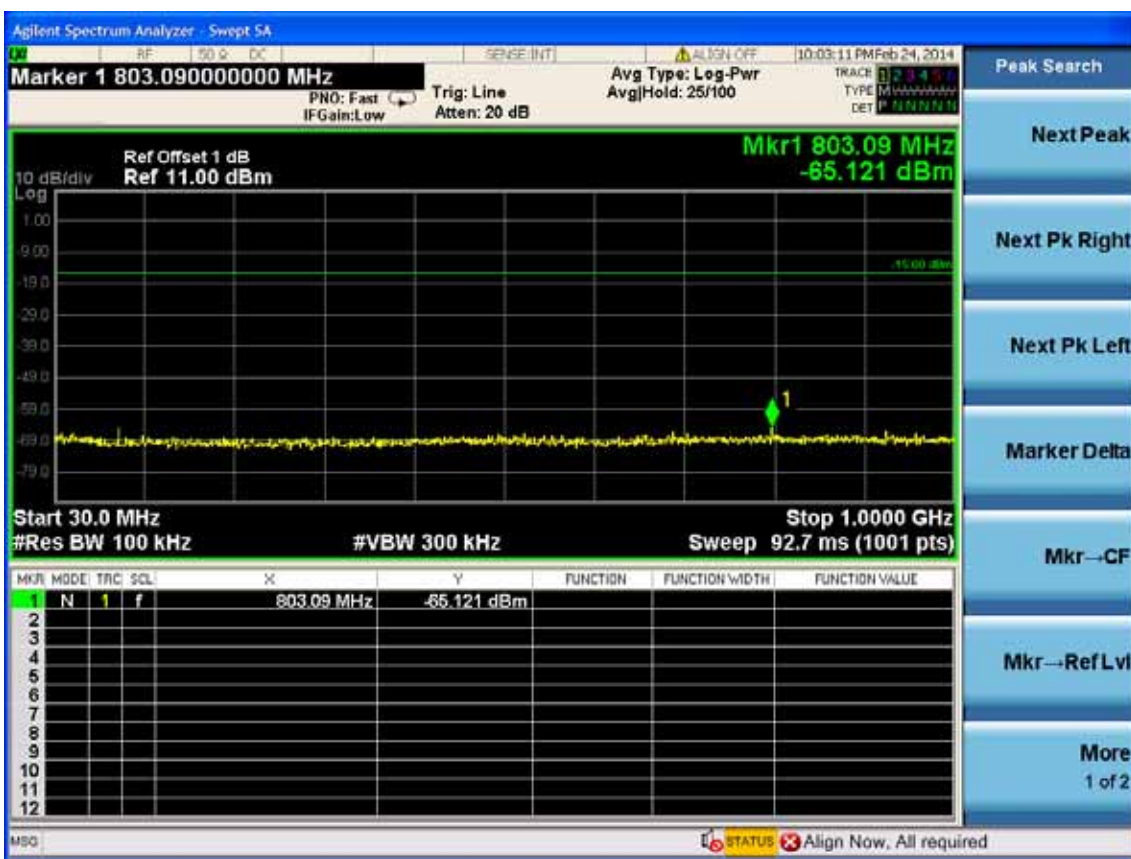

2440MHz

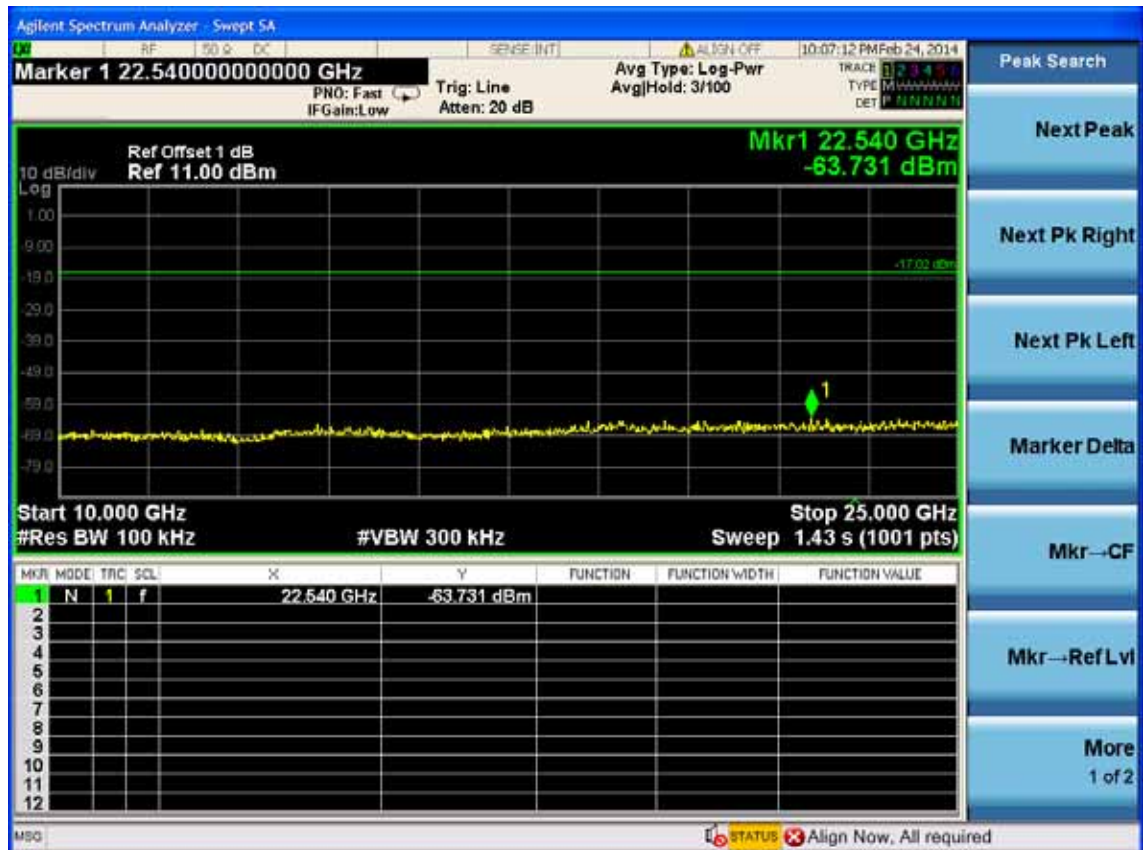
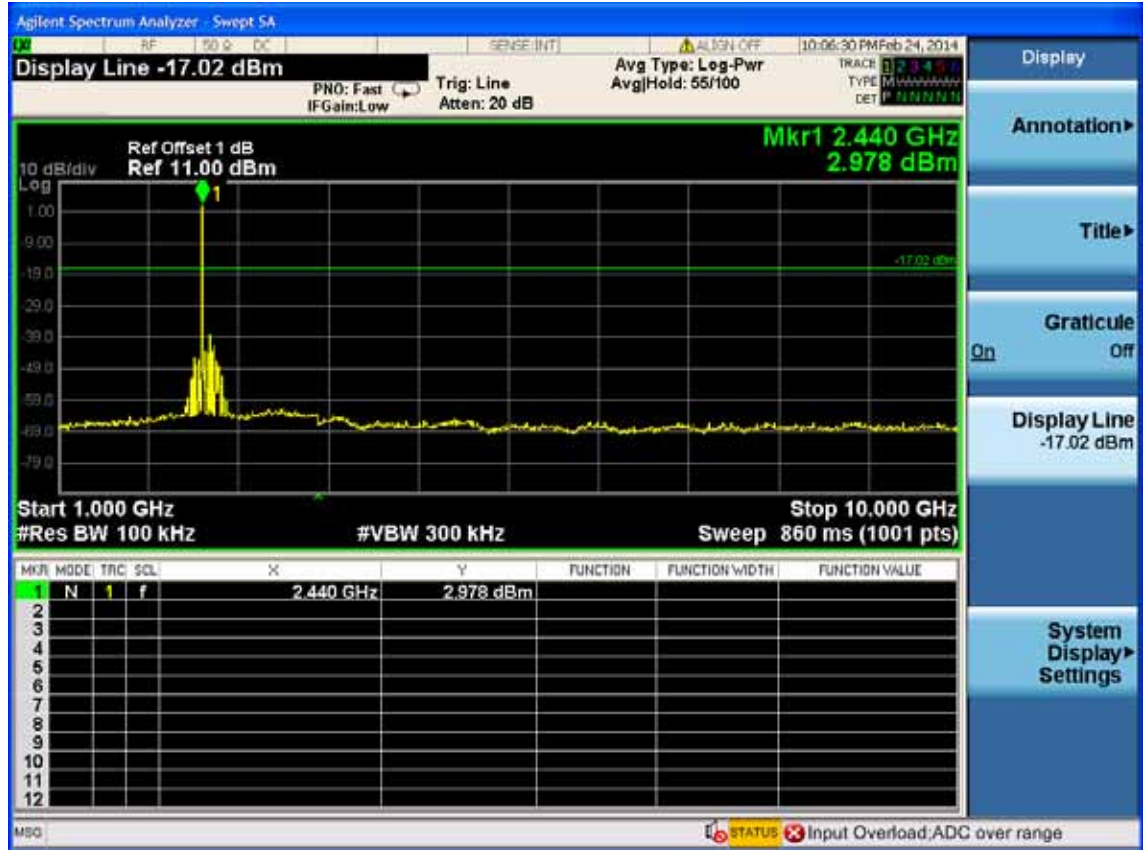

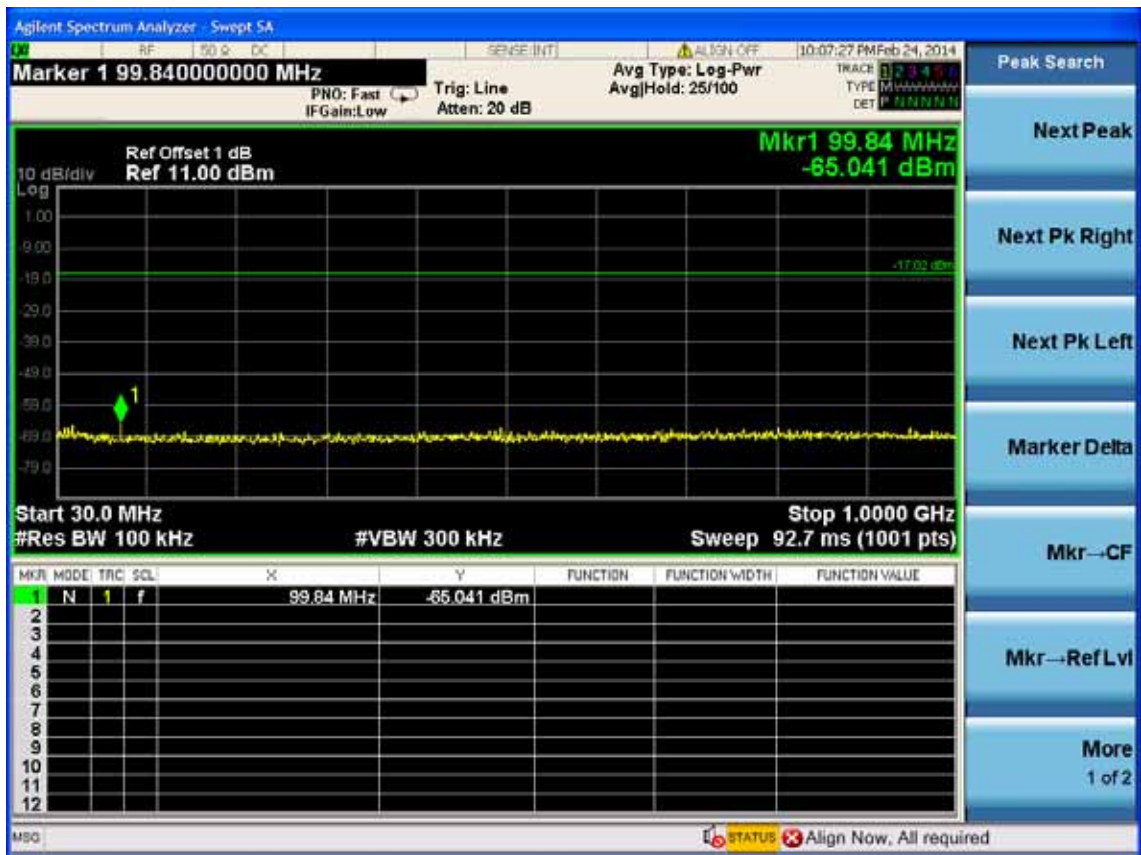

2480MHz

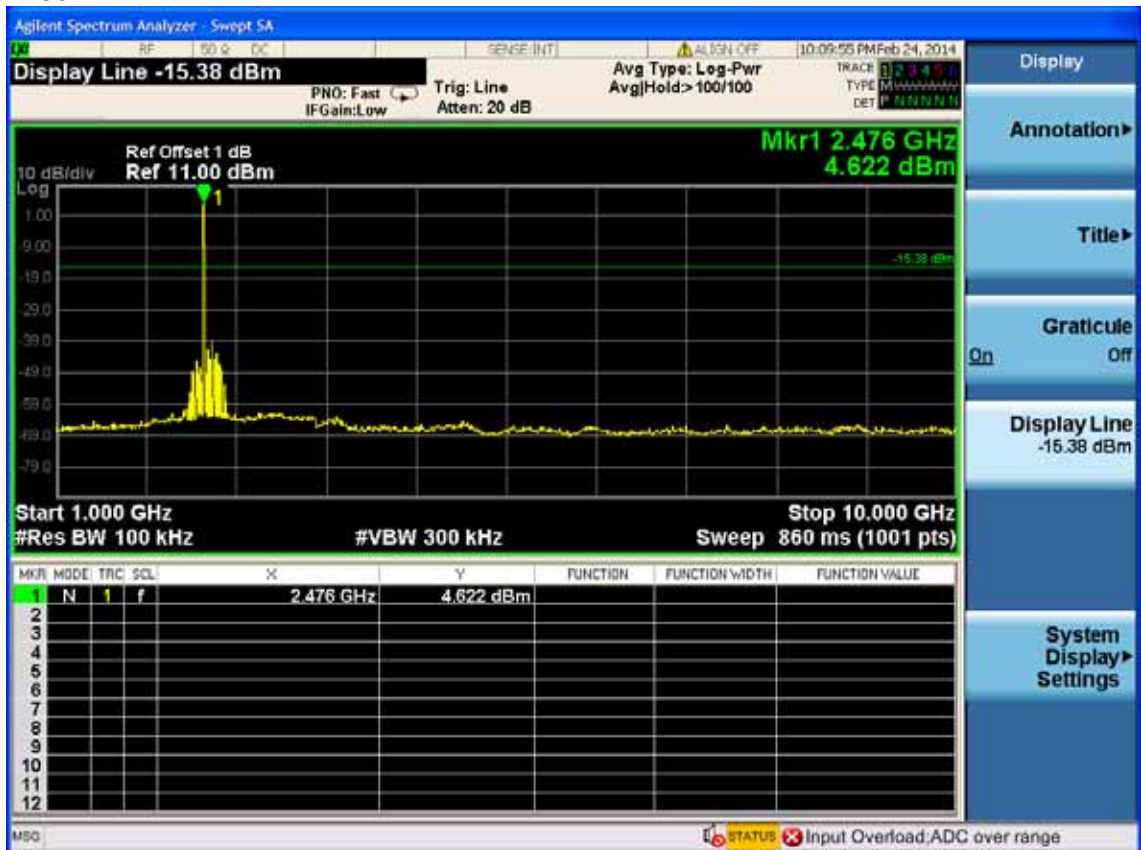

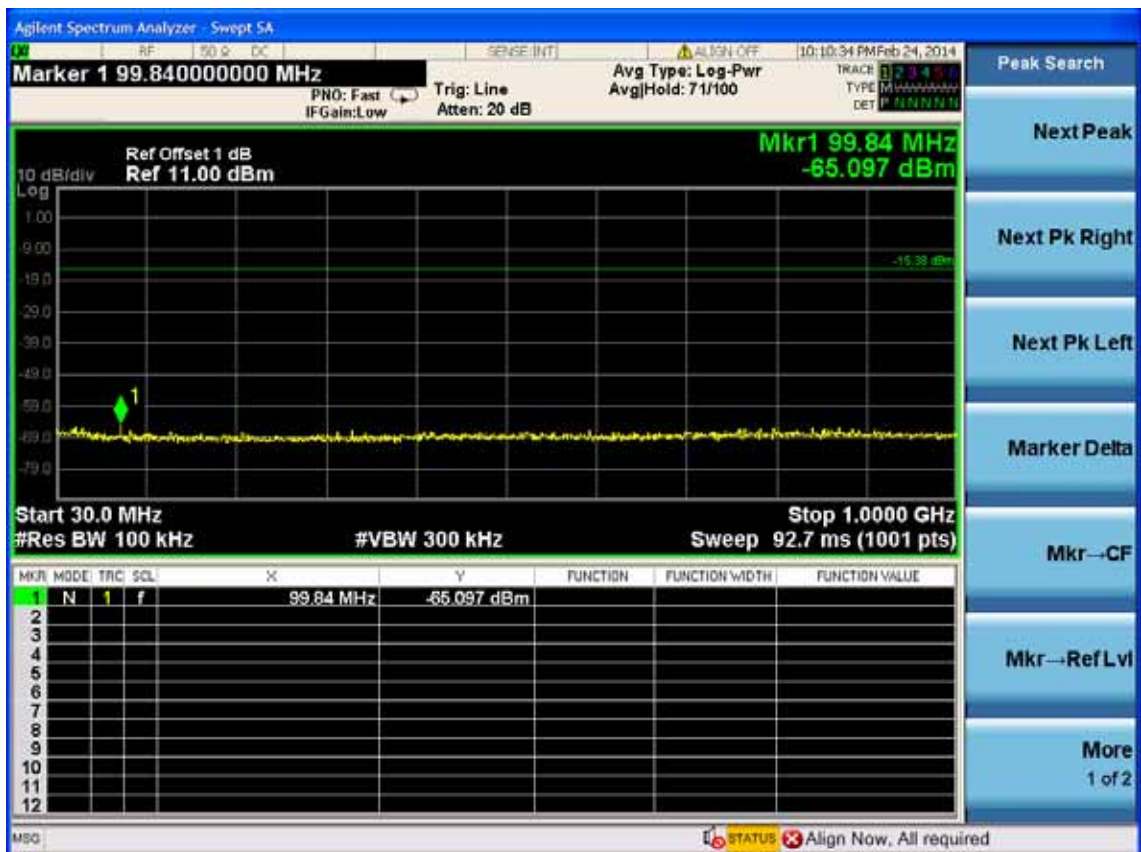
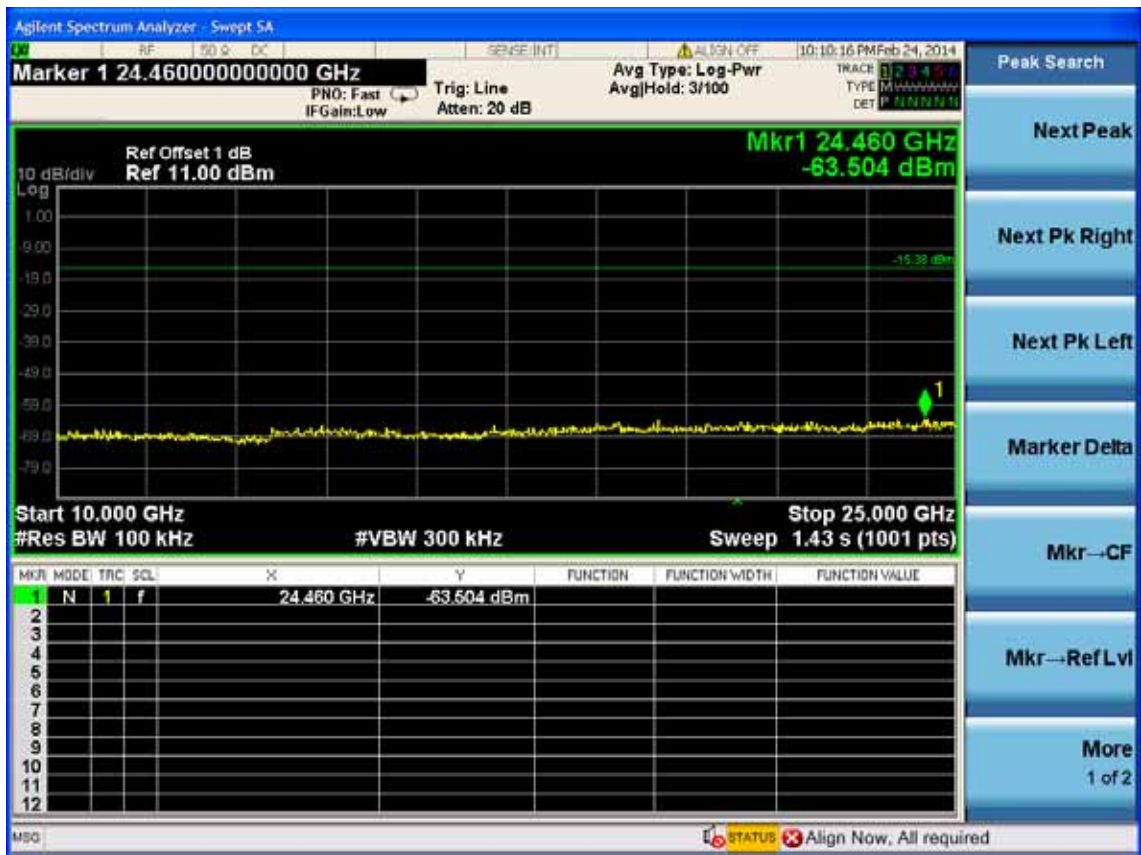

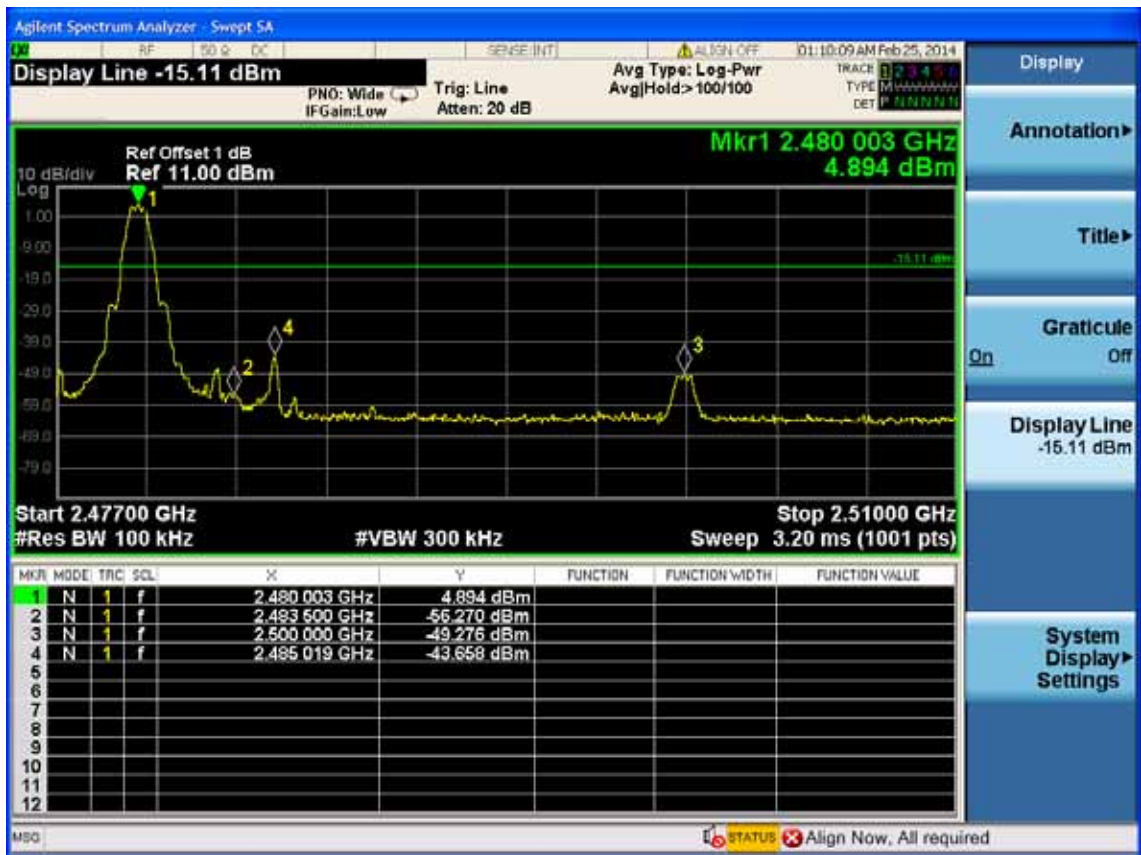

6. 6dB BANDWIDTH TEST

6.1. Test Equipment

Item	Equipment	Manufacturer	Model No.	Serial No.	Last Cal.	Cal. Interval
1.	Spectrum	Agilent	E4446A	US44300459	May.08, 13	1 Year
2.	Horn Antenna	EMCO	3115	9510-4580	May.28, 13	1 Year
3.	HF Cable	Hubersuhner	Sucoflex104	-	May.08, 13	1 Year

6.2. Limit

For direct sequence systems, the minimum 6dB bandwidth shall be at least 500kHz

6.3. Test Procedure

The transmitter output was connected to a spectrum analyzer, The bandwidth of the fundamental frequency was measured by spectrum analyzer with 30kHz RBW and 100KHz VBW. The 6dB bandwidth is defined as the total spectrum the power of which is higher than peak power minus 6dB.

6.4. Test Results

EUT: Notebook		
M/N: RZ09-0116		
Test date: 2014-02-24	Pressure: 102.1±1.0kpa	Humidity: 52.3±3.0%
Tested by: Leo-Li	Test site: RF site	Temperature: 23.2±0.6°C

Cable loss: 1.0 dB		Attenuator loss: 20 dB	
Test Mode	CH (MHz)	6 dB bandwidth (kHz)	Limit (KHz)
GFSK	2402	587.1	>500
	2440	592.9	>500
	2480	587.0	>500
Conclusion : PASS			

GFSK

Test Frequency: 2402MHz



Test Frequency: 2440MHz



Test Frequency: 2480MHz



7. MAXIMUM PEAK OUTPUT POWER TEST

7.1. Test Equipment

Item	Equipment	Manufacturer	Model No.	Serial No.	Last Cal.	Cal. Interval
1.	Spectrum Analyzer	Agilent	N9030A	MY51380221	Oct.31, 13	1 Year
2.	Amp	HP	8449B	3008A08495	May.08, 13	1 Year
3.	Horn Antenna	EMCO	3115	9510-4580	May.28, 13	1 Year
4.	HF Cable	Hubersuhne	Sucoflex104	-	May.08, 13	1 Year
5.	Power Meter	Anritsu	ML2487A	6K00002472	May.08, 13	1 Year
6.	Power Sensor	Anritsu	MA2491A	033005	May.08, 13	1 Year

7.2. Limit

For frequency hopping systems operating in the 2400-2483.5 MHz band employing at least 75 non-overlapping hopping channels, and all frequency hopping systems in the 5725-5850 MHz band: 1 watt. For all other frequency hopping systems in the 2400-2483.5 MHz band: 0.125 watts.

7.3. Test Procedure

Connected the EUT's antenna port to Power Sensor, and use power meter to test peak output power.

7.4. Test Results

EUT: Notebook			
M/N: RZ09-0116			
Test date: 2014-02-24		Pressure: 102.4±1.0kpa	Humidity: 52.6±3.0%
Tested by: Leo-Li		Test site: RF site	Temperature: 23.4±0.6°C
Cable loss: 1.0 dB		Attenuator loss: 20 dB	
Test Mode	Frequency (MHz)	Peak output Power (dBm)	Limit (dBm)
GFSK	2402	4.304	30
	2440	3.616	30
	2480	4.977	30
Conclusion: PASS			

8. BAND EDGE COMPLIANCE TEST

8.1. Test Equipment

Item	Equipment	Manufacturer	Model No.	Serial No.	Last Cal.	Cal. Interval
1.	Spectrum	Agilent	E4446A	US44300459	May.08, 13	1 Year
2.	Amp	HP	8449B	3008A08495	May.08, 13	1 Year
3.	Horn Antenna	EMCO	3115	9510-4580	May.28, 13	1 Year
4.	HF Cable	Hubersuhne	Sucoflex104	-	May.08, 13	1 Year

8.2. Limit

All the lower and upper band-edges emissions appearing within 2310MHz to 2390MHz and 2483.5MHz to 2500MHz restricted frequency bands shall not exceed the limits shown in 15.209, all the other emissions outside operation frequency band 2400MHz to 2483.5MHz shall be at least 20dB below the fundamental emissions, or comply with 15.209 limits.

8.3. Test Produce

For upper band emissions that are up to two bandwidths(2MHz) away (2483.5MHz to 2485.5MHz) from the band-edge use below produce:

1. Choose a spectrum analyzer span that encompasses both the peak of the fundamental emission and the band-edge emission under investigation. Set the analyzer RBW to 100KHz and with a video bandwidth 300KHz. Record the peak levels of the fundamental emission and the relevant band-edge emission, Observe the stored trace and measure the amplitude delta between the peak of the fundamental and the peak of the band-edge emission. This is not a field strength measurement, it is only a relative measurement to determine the amount by which the emission drops at the band edge relative to the highest fundamental emission level.
2. Subtract the delta measured in step (1) from the maximum field strengths measured in clause 4 .The resultant field strengths are then used to determine band-edge compliance as required by Section 15.205

For emissions above two bandwidths away from the band-edge use below produce:

1. The EUT is placed on a turntable, which is 0.8m above the ground plane and worked at highest radiated power.
2. The turntable was rotated for 360 degrees to determine the position of maximum emission level.
3. EUT is set 3m away from the receiving antenna, which is varied from 1m to 4m to find out the highest emission.
4. Set the spectrum analyzer in the following setting in order to capture the lower and upperband-edges of the emission:
 - (a) PEAK: RBW=1MHz ;VBW=3MHz, PK detector, Sweep Time=AUTO
 - (b) AV: RBW=1MHz, VBW= 10Hz, Sweep Time=AUTO

8.4. Test Results

Pass (The testing data was attached in the next pages.)

Note: If the PK measured levels comply with average limit, then the average level were deemed to comply with average limit.

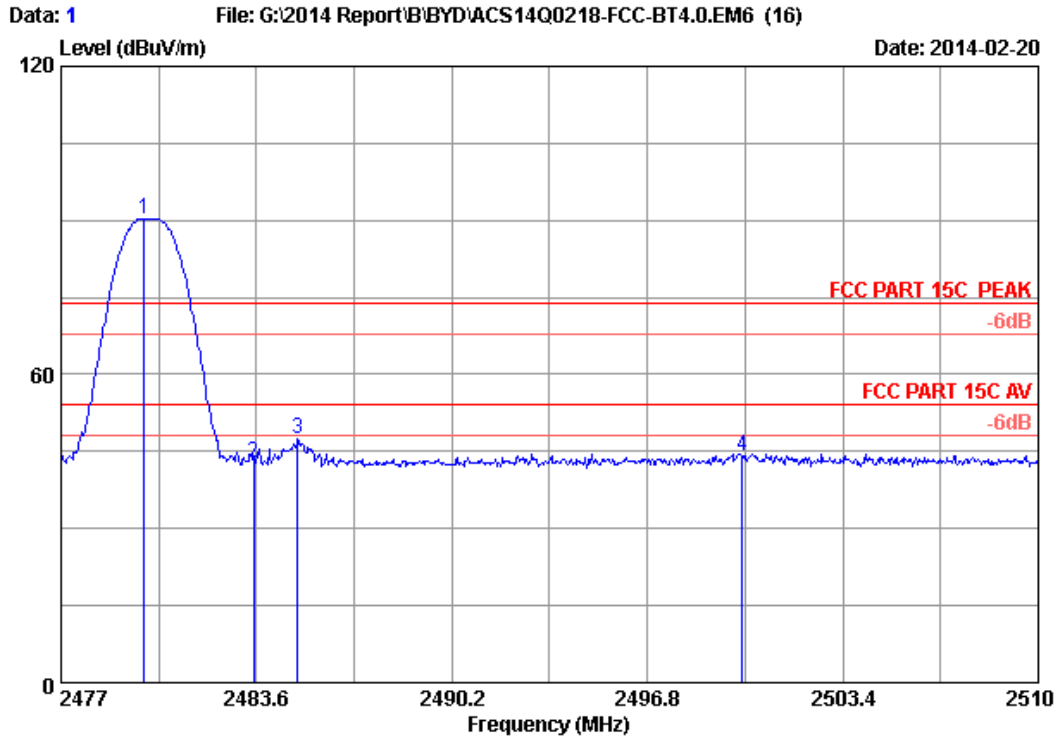

Site no. : 3m Chamber Data no. : 1
 Dis. / Ant. : 3m 2013 3115 (4580) Ant. pol. : HORIZONTAL
 Limit : FCC PART 15C PEAK
 Env. / Ins. : 24*C/56% Engineer : Leo-Li
 EUT : Notebook
 Power Rating : DC 19V From Adapter Input AC 120V/60Hz
 Test Mode : 2480MHz Tx Mode
 M/N : RZ09-0116

No.	Freq. (MHz)	Ant. Factor (dB/m)	Cable Loss (dB)	AMP factor (dB)	Reading (dBuV)	Emission Level (dBuV/m)	Limits (dBuV/m)	Margin (dB)	Remark
1	2479.805	28.36	5.91	35.70	91.71	90.28	74.00	-16.28	Peak
2	2483.500	28.36	5.92	35.70	44.37	42.95	74.00	31.05	Peak
3	2484.986	28.37	5.92	35.70	48.88	47.47	74.00	26.53	Peak
4	2500.000	28.40	5.94	35.70	45.36	44.00	74.00	30.00	Peak

Remarks: 1. Emission Level= Antenna Factor + Cable Loss + Reading - Amp Factor
 2. The emission levels that are 20dB below the official limit are not reported.

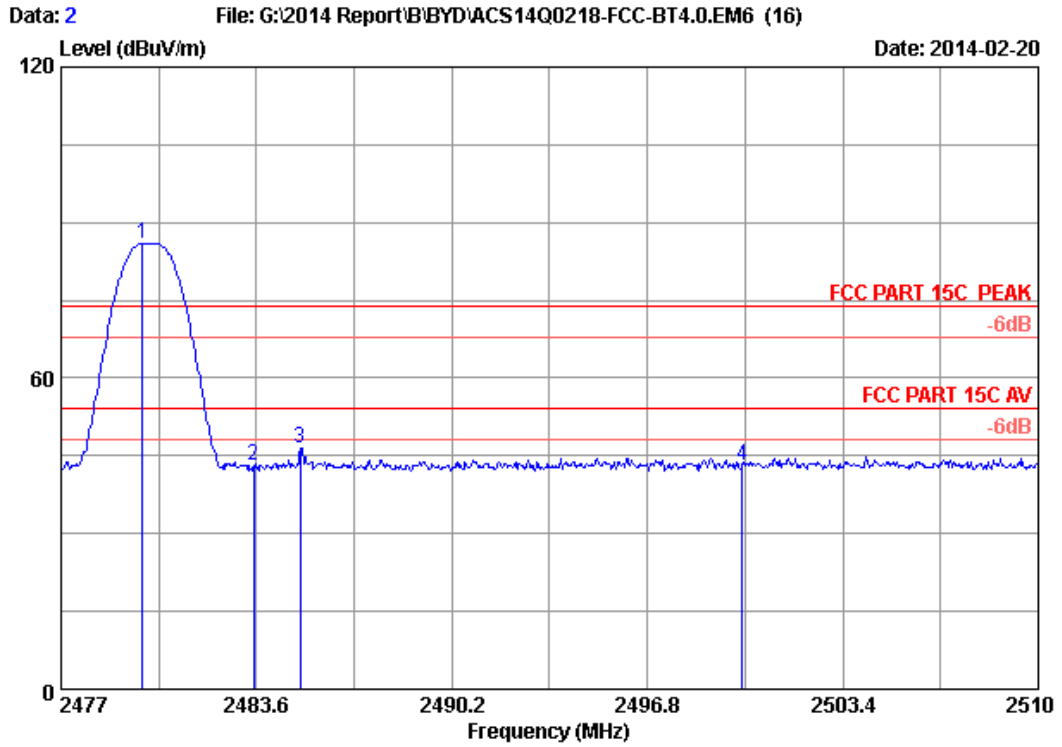

Site no. : 3m Chamber Data no. : 2
 Dis. / Ant. : 3m 2013 3115 (4580) Ant. pol. : VERTICAL
 Limit : FCC PART 15C PEAK
 Env. / Ins. : 24°C/56% Engineer : Leo-Li
 EUT : Notebook
 Power Rating : DC 19V From Adapter Input AC 120V/60Hz
 Test Mode : 2480MHz Tx Mode
 M/N : R209-0116

No.	Freq. (MHz)	Ant. Factor (dB/m)	Cable Loss (dB)	AMP factor (dB)	Reading (dBuV)	Emission Level (dBuV/m)	Limits (dBuV/m)	Margin (dB)	Remark
1	2479.739	28.36	5.91	35.70	87.33	85.90	74.00	-11.90	Peak
2	2483.500	28.36	5.92	35.70	44.60	43.18	74.00	30.82	Peak
3	2485.085	28.37	5.92	35.70	47.91	46.50	74.00	27.50	Peak
4	2500.000	28.40	5.94	35.70	44.32	42.96	74.00	31.04	Peak

Remarks: 1. Emission Level= Antenna Factor + Cable Loss + Reading - Amp Factor
 2. The emission levels that are 20dB below the official limit are not reported.

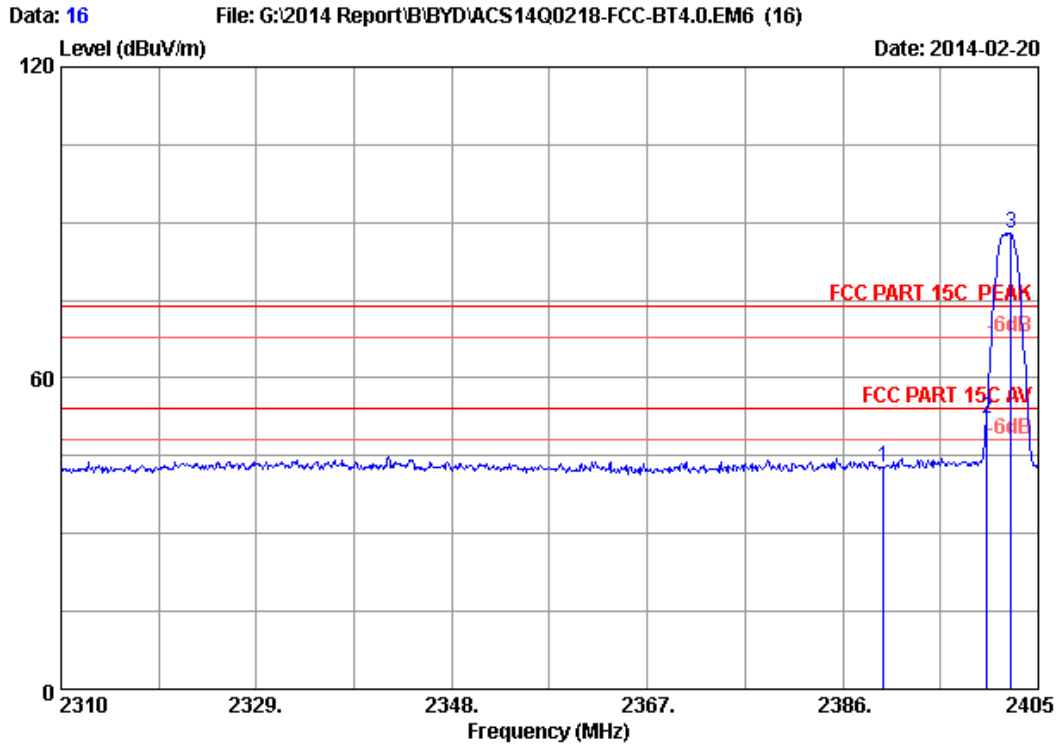

Site no. : 3m Chamber Data no. : 16
 Dis. / Ant. : 3m 2013 3115 (4580) Ant. pol. : HORIZONTAL
 Limit : FCC PART 15C PEAK
 Env. / Ins. : 24°C/56% Engineer : Leo-Li
 EUT : Notebook
 Power Rating : DC 19V From Adapter Input AC 120V/60Hz
 Test Mode : 2402MHz Tx Mode
 M/N : R209-0116

No.	Freq. (MHz)	Ant. Factor (dB/m)	Cable Loss (dB)	AMP factor (dB)	Reading (dBUV)	Emission Level (dBUV/m)	Limits (dBUV/m)	Margin (dB)	Remark
1	2390.000	28.16	5.78	35.70	44.57	42.81	74.00	31.19	Peak
2	2400.000	28.18	5.80	35.70	53.76	52.04	74.00	21.96	Peak
3	2402.340	28.19	5.80	35.70	89.52	87.81	74.00	-13.81	Peak

Remarks: 1. Emission Level= Antenna Factor + Cable Loss + Reading - Amp Factor
 2. The emission levels that are 20dB below the official limit are not reported.

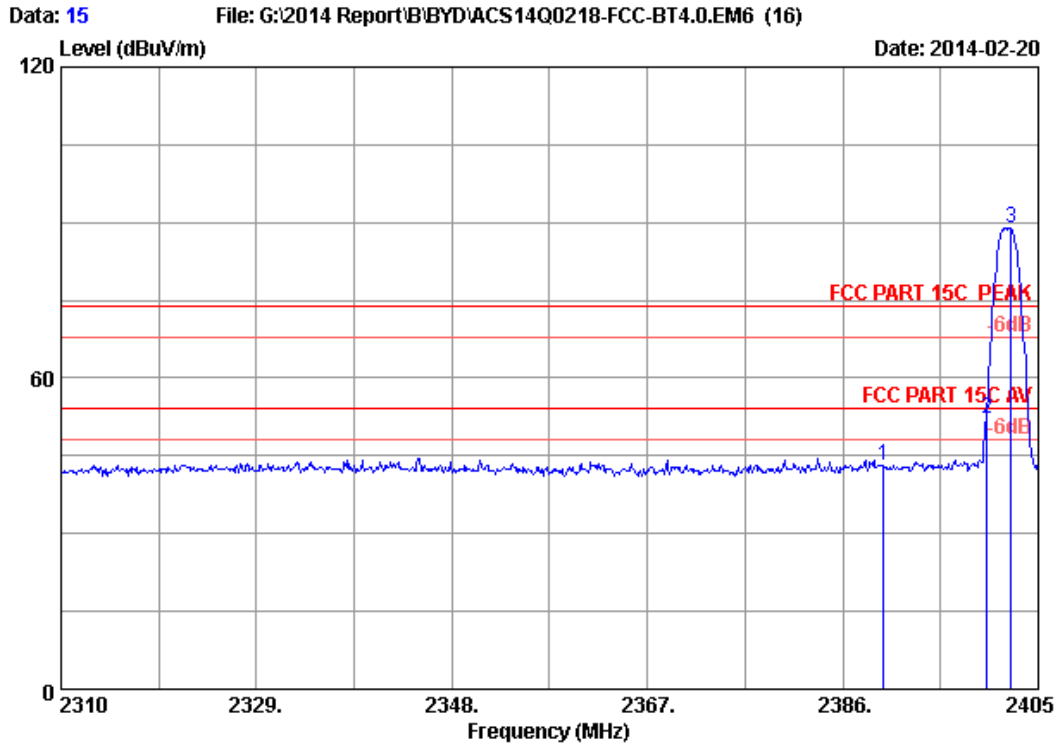

Site no. : 3m Chamber Data no. : 15
 Dis. / Ant. : 3m 2013 3115 (4580) Ant. pol. : VERTICAL
 Limit : FCC PART 15C PEAK
 Env. / Ins. : 24°C/56% Engineer : Leo-Li
 EUT : Notebook
 Power Rating : DC 19V From Adapter Input AC 120V/60Hz
 Test Mode : 2402MHz Tx Mode
 M/N : R209-0116

No.	Freq. (MHz)	Ant. Factor (dB/m)	Cable Loss (dB)	AMP factor (dB)	Reading (dBuV)	Emission Level (dBuV/m)	Limits (dBuV/m)	Margin (dB)	Remark
1	2390.000	28.16	5.78	35.70	44.89	43.13	74.00	30.87	Peak
2	2400.000	28.18	5.80	35.70	53.72	52.00	74.00	22.00	Peak
3	2402.340	28.19	5.80	35.70	90.53	88.82	74.00	-14.82	Peak

Remarks: 1. Emission Level= Antenna Factor + Cable Loss + Reading - Amp Factor
 2. The emission levels that are 20dB below the official limit are not reported.

9. POWER SPECTRAL DENSITY TEST

9.1. Test Equipment

Item	Equipment	Manufacturer	Model No.	Serial No.	Last Cal.	Cal. Interval
1.	Spectrum Analyzer	Agilent	N9030A	MY51380221	Oct.31, 13	1 Year
2.	Amp	HP	8449B	3008A08495	May.08, 13	1 Year
3.	Horn Antenna	EMCO	3115	9510-4580	May.28, 13	1 Year
4.	HF Cable	Hubersuhne	Sucoflex104	-	May.08, 13	1 Year

9.2. Limit

For digitally modulated systems, the power spectral density conducted from the intentional radiator to the antenna shall not be greater than 8dBm in any 3kHz band during any time interval of continuous transmission.

9.3. Test Procedure

1. Connected the EUT's antenna port to spectrum analyzer device by 20dB attenuator.
2. Set the test frequency as center frequency, Set RBW=3KHz, VBW=10KHz, Span large enough capture the entire frequency, Read out maximum peak level frequency
3. Set the frequency read from produce 2 as center frequency, then set the span=300KHz, Sweep time=Span/RBW, Then Max hold, read out each mode and each chain's Power density.

Note: The cable loss and attenuator loss were offset into measure device as an amplitude

9.4. Test Results

EUT: Notebook		
M/N: RZ09-0116		
Test date: 2014-02-24	Pressure: 101.4±1.0kpa	Humidity: 52.3±3.0%
Tested by: Leo-Li	Test site: RF site	Temperature: 23.5±0.6°C

Cable loss: 1 dB		Attenuator loss: 20 dB	
Test Mode	CH (MHz)	Power density (dBm/3KHz)	Limit (dBm/3KHz)
GFSK	2402	-11.256	8
	2440	-11.160	8
	2480	-9.806	8
Conclusion : PASS			

Test Frequency: 2402MHz

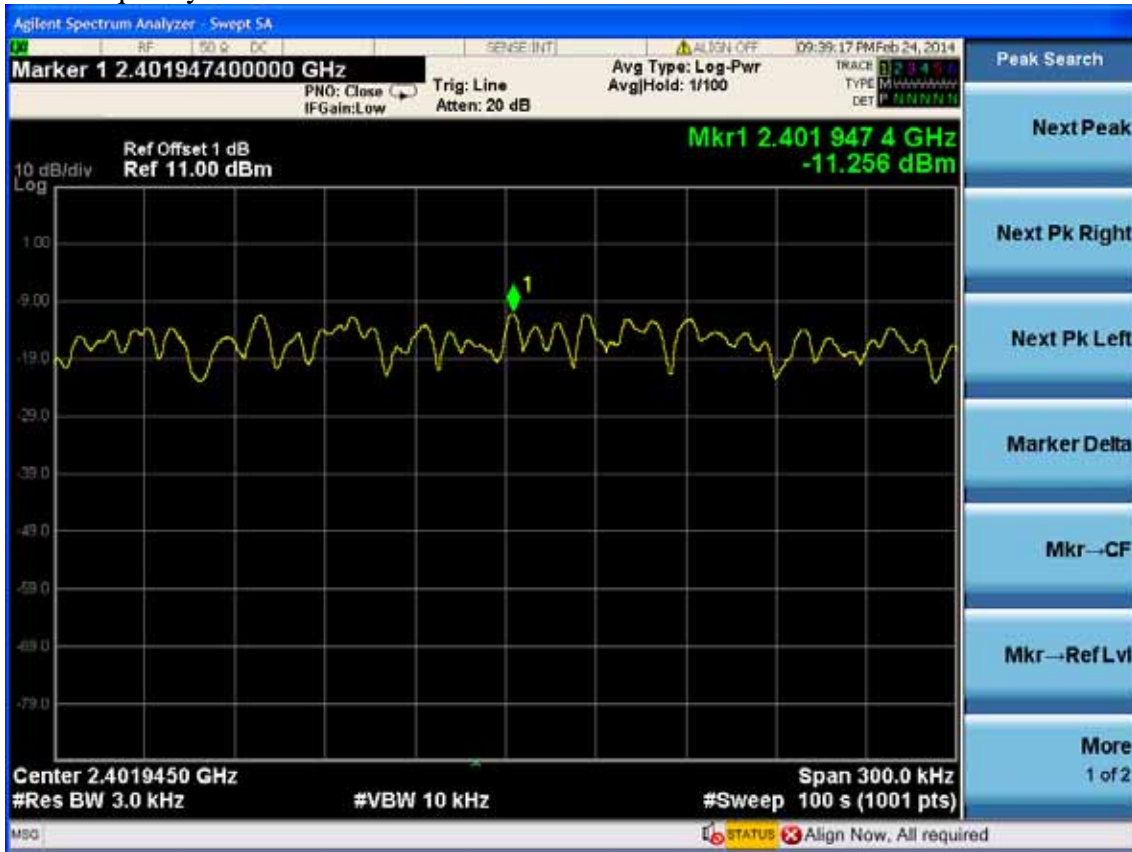

Test Frequency: 2440MHz

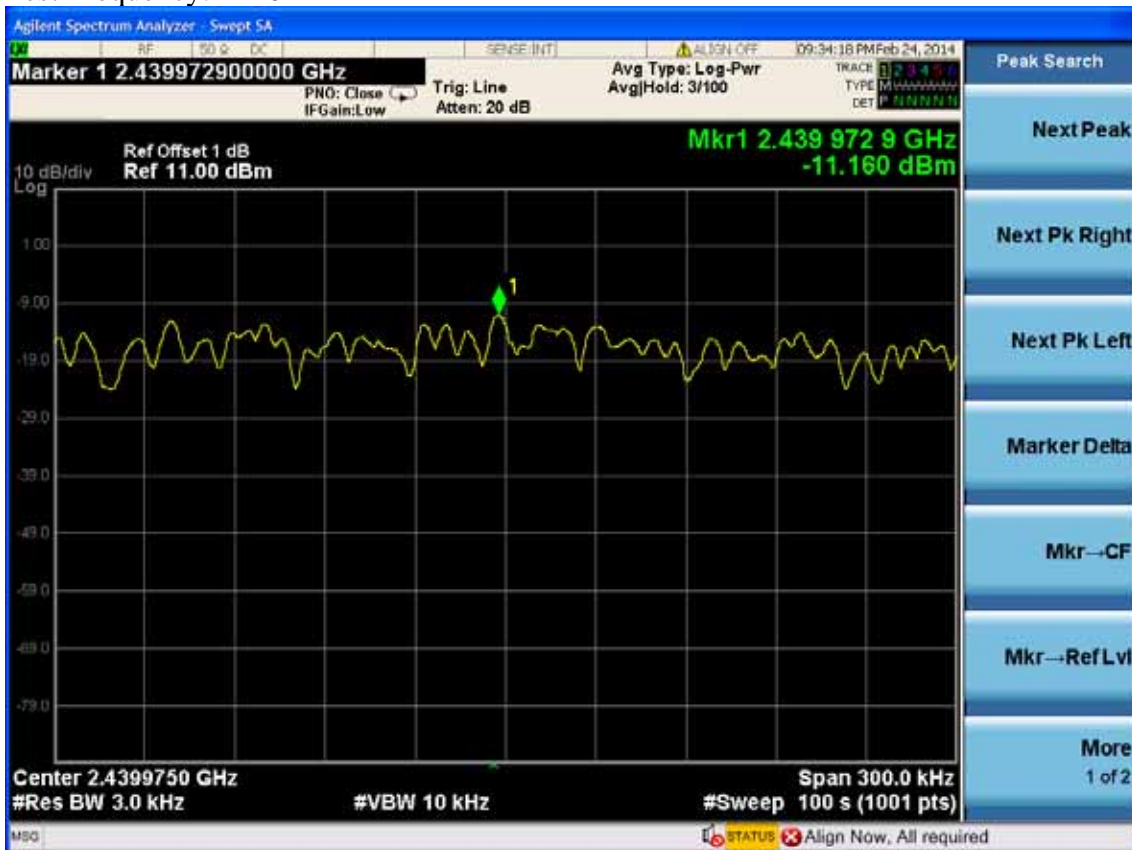

Test Frequency: 2480MHz

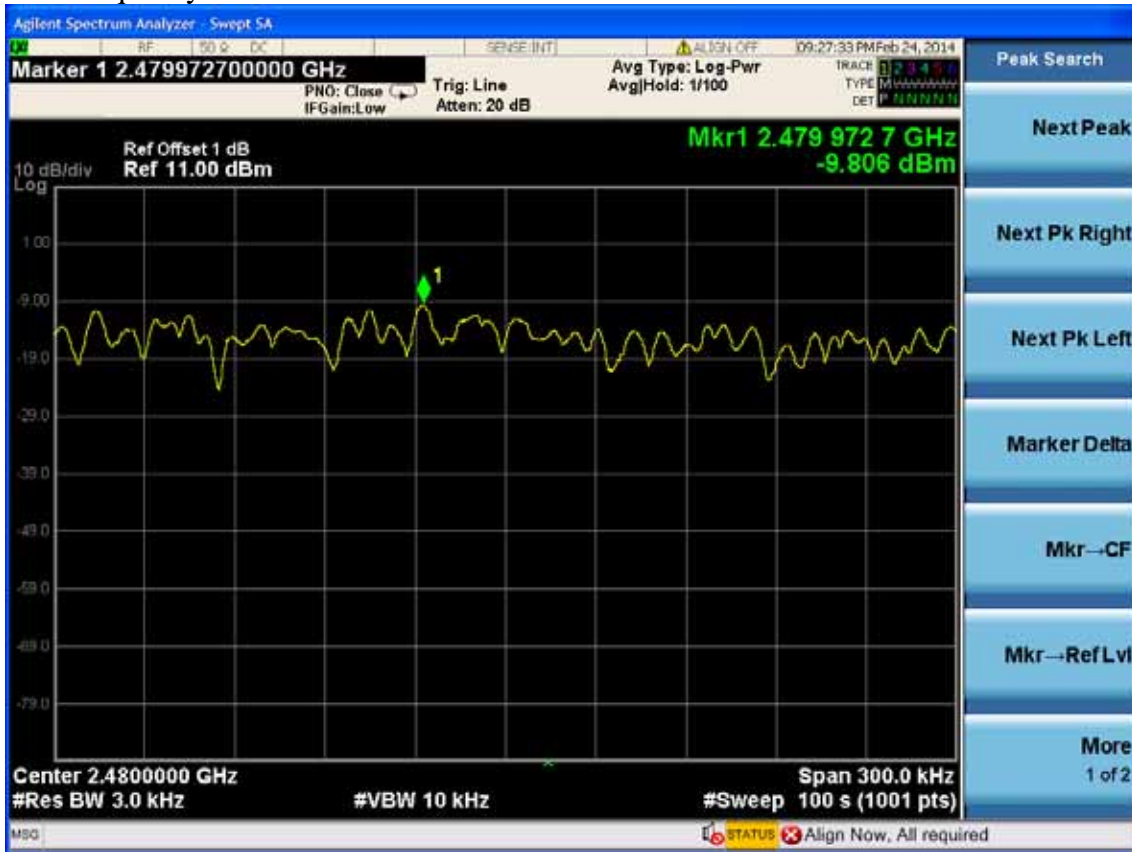

10.DEVIATION TO TEST SPECIFICATIONS

[NONE]