



# ANT Test Report

**Antenna Type: PCB Antenna**

**Project No.** : 2206E021  
**Product Type** : **PCB Antenna**  
**Brand Name** : Razer  
**Test Model** : RZ06-0471  
**Date of Receipt** : 2022-6-30  
**Date of Test** : 2022-6-30  
**Issued Date** : 2022-6-30  
**Report Version** : R00  
**Test Sample** : Razer  
**Standard(s)** : Test Plan for Wireless Device Over-the-Air Performance v3.8.2  
**Applicant** : Razer Inc.  
**Address** : 9 Pasteur, Suite 100, Irvine, CA92618, USA  
**Manufacturer** : Razer (Asia-Pacific) Pte.,Ltd.  
**Address** : 1 one-north Crescent, #02-01, Singapore 138538

The above equipment has been tested and found compliance with the requirement of the relative standards by BTL Inc.



---

**Prepared by :**



---

**Approved by :**

Add: No. 3 Jinshagang 1st Rd. Shixia, Dalang Town Dongguan City, Guangdong 523792 People's Republic of China

Tel: +86-769-8318-3000

Web: [www.newbtl.com](http://www.newbtl.com)

**Declaration**

**BTL** represents to the client that testing is done in accordance with standard procedures as applicable and that test instruments used has been calibrated with standards traceable to international standard(s) and/or national standard(s).

**BTL's** reports apply only to the specific samples tested under conditions. It is manufacture's responsibility to ensure that additional production units of this model are manufactured with the identical electrical and mechanical components. **BTL** shall have no liability for any declarations, inferences or generalizations drawn by the client or others from **BTL** issued reports.

The report must not be used by the client to claim product certification, approval, or endorsement by NIST, A2LA, or any agency of the U.S. Government.

This report is the confidential property of the client. As a mutual protection to the clients, the public and ourselves, the test report shall not be reproduced, except in full, without our written approval.

**BTL's** laboratory quality assurance procedures are in compliance with the **ISO/IEC 17025** requirements, and accredited by the conformity assessment authorities listed in this test report.

**BTL** is not responsible for the sampling stage, so the results only apply to the sample as received.

The information, data and test plan are provided by manufacturer which may affect the validity of results, so it is manufacturer's responsibility to ensure that the apparatus meets the essential requirements of applied standards and in all the possible configurations as representative of its intended use.

**Limitation**

For the use of the authority's logo is limited unless the Test Standard(s)/Scope(s)/Item(s) mentioned in this test report is (are) included in the conformity assessment authorities acceptance respective.

Please note that the measurement uncertainty is provided for informational purpose only and are not use in determining the Pass/Fail results.

## Table of Contents

<b>REPORT ISSUED HISTORY.....</b>	<b>5</b>
<b>TEST FACILITY &amp; CONTACT INFORMATION.....</b>	
<b>. PHYSICAL LAYOUT AND SITE DESCRIPTION.....</b>	<b>6</b>
WIRELESS MOBILE DEVICE TEST LABORATORY.....	6
ANECHOIC CHAMBER.....	6
MULTI AXIS POSITIONING SYSTEM (MAPS™).....	6
QUIET ZONE.....	7
EMCO MODEL 3165-01 ABSORBER NESTED DUAL-POLARIZED DUAL-VIVALDI ARRAY ANTENNA.....	7
EMCO-3102 CIRCULARLY POLARIZED COMMUNICATION ANTENNAS.....	7
TEST EQUIPMENT.....	7
EMQUEST SOFTWARE.....	7
<b>2.4G GAIN &amp; PATTERN.....</b>	<b>8</b>
<b>. TEST EQUIPMENT LIST.....</b>	<b>17</b>
TEST EQUIPMENT USED FOR MEASURING.....	17
<b>. PHOTOGRAPH.....</b>	<b>18</b>
EUT SETUP PHOTO.....	18

## REPORT ISSUED HISTORY

Report No.	Version	Description	Issued Date	Note
BTL-ANT-2206E021	R00	Original Report.	2022-6-30	-

## **. PHYSICAL LAYOUT AND SITE DESCRIPTION**

### **WIRELESS MOBILE DEVICE TEST LABORATORY**

All tests were performed in BTL Inc. state-of-the-art Wireless Mobile Device Test Laboratory consisting of a rectangular anechoic chamber equipped with a multi-axis positioning system (MAPS), a dual polarized quad-ridge waveguide horn, and two EMCO-3102 circularly polarized communication antennas. A base station simulator is used to establish communication with the EUT and place it in the proper mode, and a spectrum analyzer and RF switch combination is used for measuring the signal from the EUT at each position and polarization. BTL Inc.'s EMQuest EMQ-100 Pattern Measurement Software is used for data acquisition, post-processing, and generation of the required output

### **ANECHOIC CHAMBER**

The anechoic chamber is a rectangular anechoic chamber designed and built by ETS-Lindgren with the following nominal dimensions

Length:	5.1 m (200 in)
Width:	5.1 m (200 in)
Height:	5.1 m (200 in)

The anechoic chamber consists of a shielded enclosure constructed of rigid, steel-clad, wood core modular panels with steel framing. The chamber is treated with ETS-Lindgren's microwave absorber, utilizing both pyramidal and wedge shaped absorber. Lighting in the chamber is RF-filtered and consists of two (2) incandescent lamps mounted in recessed waveguide vents in the chamber ceiling. The chamber is forced air ventilated to maintain it at the same ambient as the surrounding facility. A single leaf swing type shielded door is provided for equipment and personnel access into the chamber. The Anechoic Chamber is capable of meeting RF attenuation levels of over 100 dB throughout the frequency range of 30 MHz to 18 GHz, so that testing performed within the chamber does not interfere with other testing activities at the facility, and vice-versa. Power is supplied on separate circuits to the chamber and control area. All power filters provide a minimum of 100 dB attenuation over a frequency range of 14 kHz to 18 GHz when tested per MIL STD 220A

### **MULTI AXIS POSITIONING SYSTEM (MAPS™)**

The MAPS™ positioning system is capable of rotating the article under test (AUT) on on phi axes with full 360 degree angular range on each axis, Theta has 23 antennas simultaneously capturing data, while keeping the AUT on the center of both axes. Under normal conditions it provides 0.1 degree positioning accuracy. In conjunction with the EMQ-100 Pattern Measurement Software, it can perform positioning for data acquisition in both continuous and stepped movement modes.

The MAPS™ utilizes different support structures for the second axis based on the required load. This allows the use of a light-duty support for free-space testing to minimize the effect of the support on the measurement. A stronger medium-duty support is used for the SAM phantom head testing. During the SAM head test, the support structure is largely shadowed by the phantom so that its effects are negligible. The electrically driven MAPS™ does not introduce conducted or radiated electrical noise above the ambient levels existing with the chamber. MAPS™ rotation is controlled by an EMCO Model 2090 Multi-device Controller with IEEE-488 data/control for automation

A 50 centimeter diameter by 50 centimeter tall cylindrical quiet zone volume was qualified for each axis of the MAPS and polarization of the receive antenna per an internal test plan that encompasses the requirements of the Cellular Telecommunications & Internet Association (CTIA) Method of Measurement for CTIA Test Plan for Wireless Device Over-the-Air Performance, Revision 3.8.2, published in April, 2019

### **EMCO MODEL 3165-01 ABSORBER NESTED DUAL-POLARIZED DUAL-VIVALDI ARRAY ANTENNA**

The apex of the anechoic chamber is equipped with an EMCO Model 3165-01 Absorber Nested Dual-Polarized Dual-Vivaldi Array Antenna. This antenna is designed for wireless test applications and covers all currently known wireless service frequencies. The antenna has two orthogonally placed input feeds that permit simultaneous measurements for dual polarizations. The antenna can be used for both linearly and circularly polarized waves (with the addition of a quadrature hybrid coupler) over a very broad frequency range.

### **EMCO-3102 CIRCULARLY POLARIZED COMMUNICATION ANTENNAS**

To the top of the MAPS and the side of the chamber are each fitted with a broadband circularly polarized communication antenna (EMCO Model 3102 Conical Log Spiral) to provide a relatively low loss link to the base station simulator in any position. A 60-dB limited amplifier is installed to stabilize the uplink radio signal to MT8821C RF port. This feature provides a very robust radio-link between the mobile phone and the Radio Communication Tester. Therefore, the TRP/TIS measurement can be conducted without dropping the links

### **TEST EQUIPMENT**

The test was performed using the following additional test equipment:

- 2.7.1. Anritsu MS46522B 2.4G/5G Gain

### **EMQUEST SOFTWARE**

BTL Inc.'s EMQuest pattern measurement software is used to automate the data acquisition process and provides all post-processing calculations and data output required by the CTIA. Its parameterized test configuration system and conscientiously validated design helps to insure repeatable and correct results. Safeguards prevent data tampering and insure that the original "raw" measured data is always available for review



### 2.4G GAIN & PATTERN #1 LEFT

Frequency (MHz)	Efficiency (%)	Gain (dBi)
2400	43.40	2.23
2410	44.87	2.32
2420	44.02	2.53
2430	41.87	1.97
2440	41.83	1.70
2450	43.07	2.25
2460	43.75	1.94
2470	42.27	1.58
2480	42.72	2.24
2490	45.03	2.15
2500	48.91	2.10



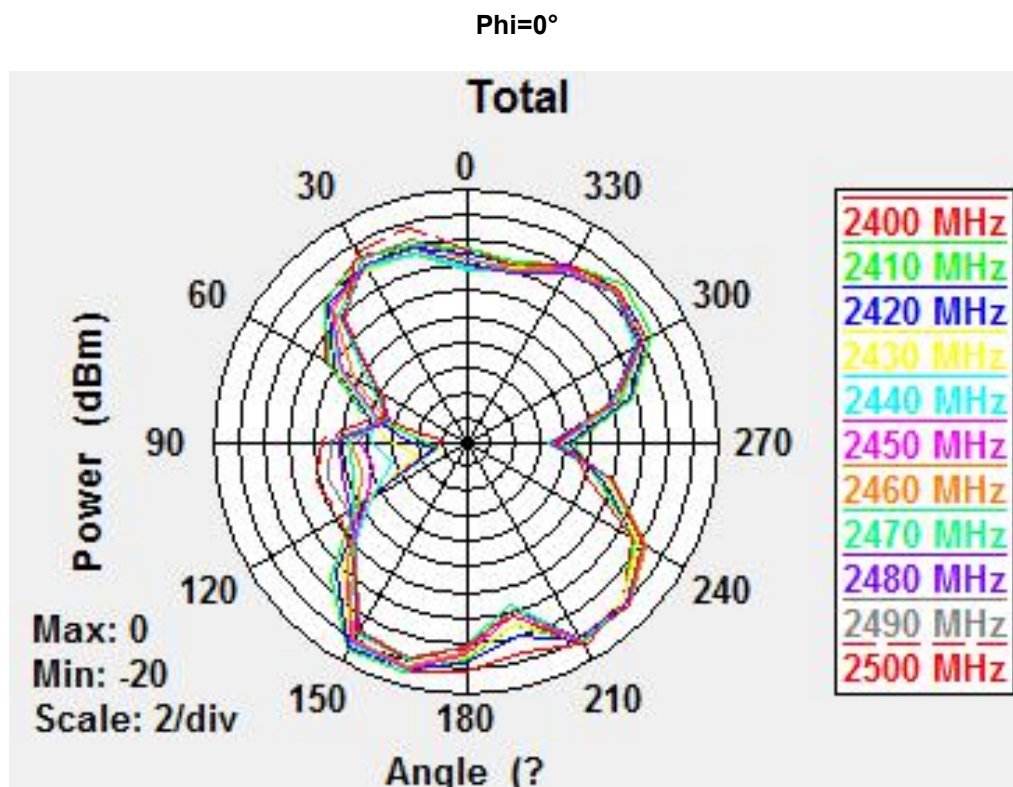
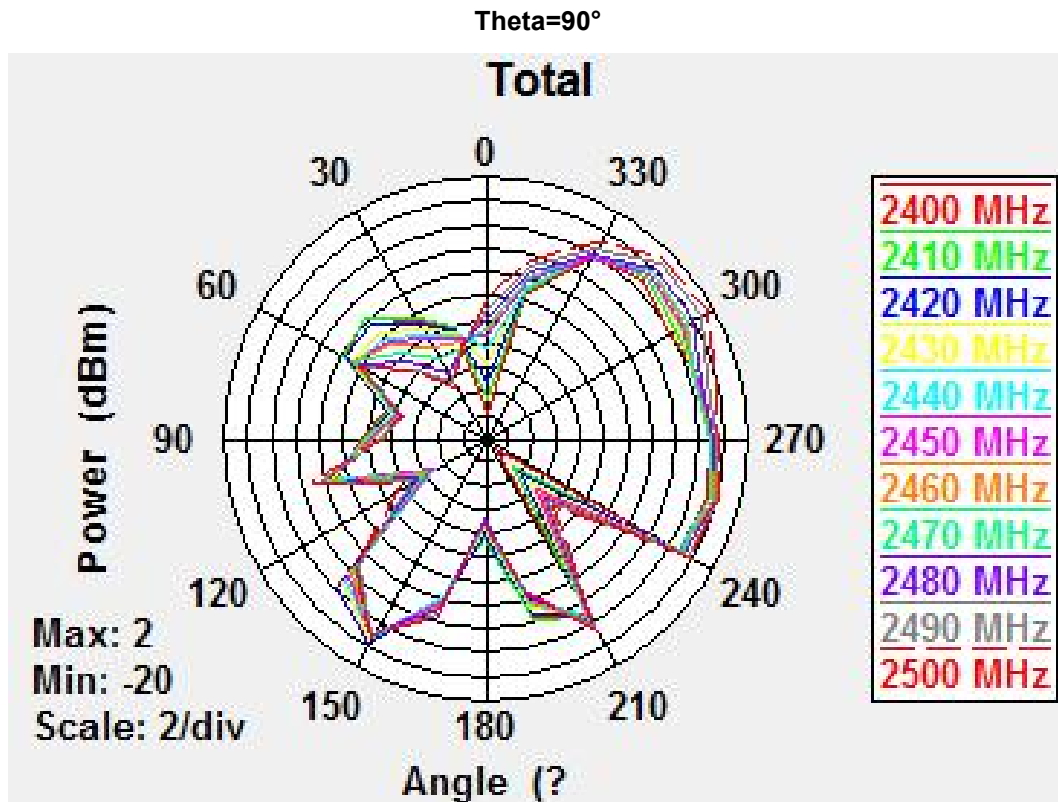

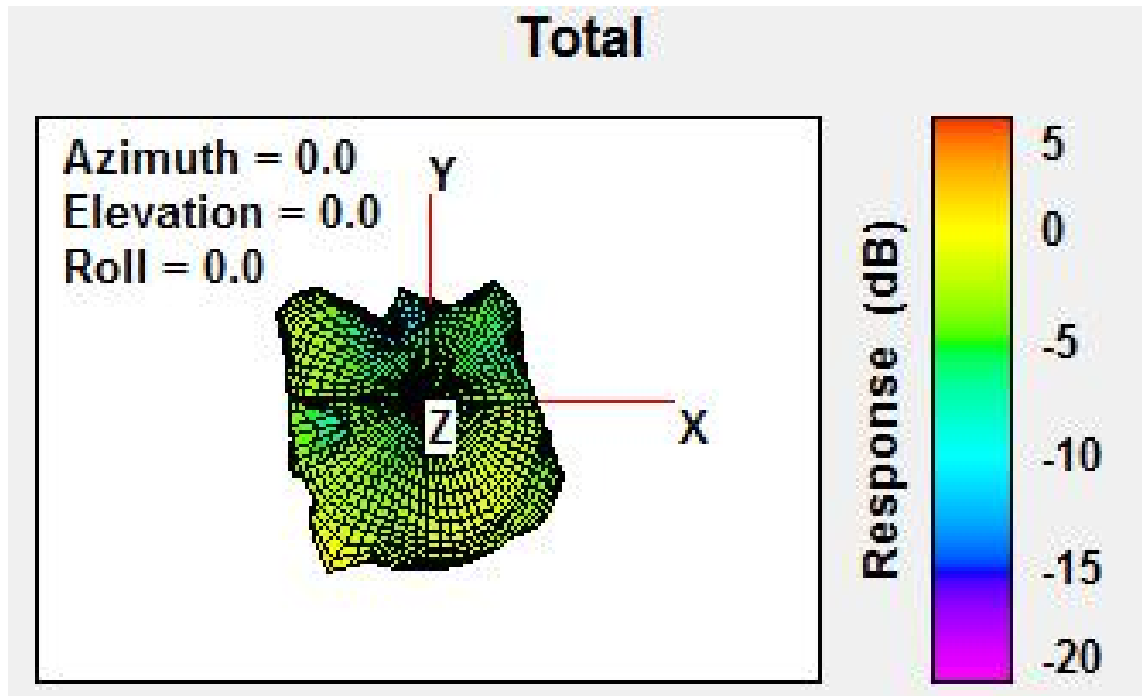
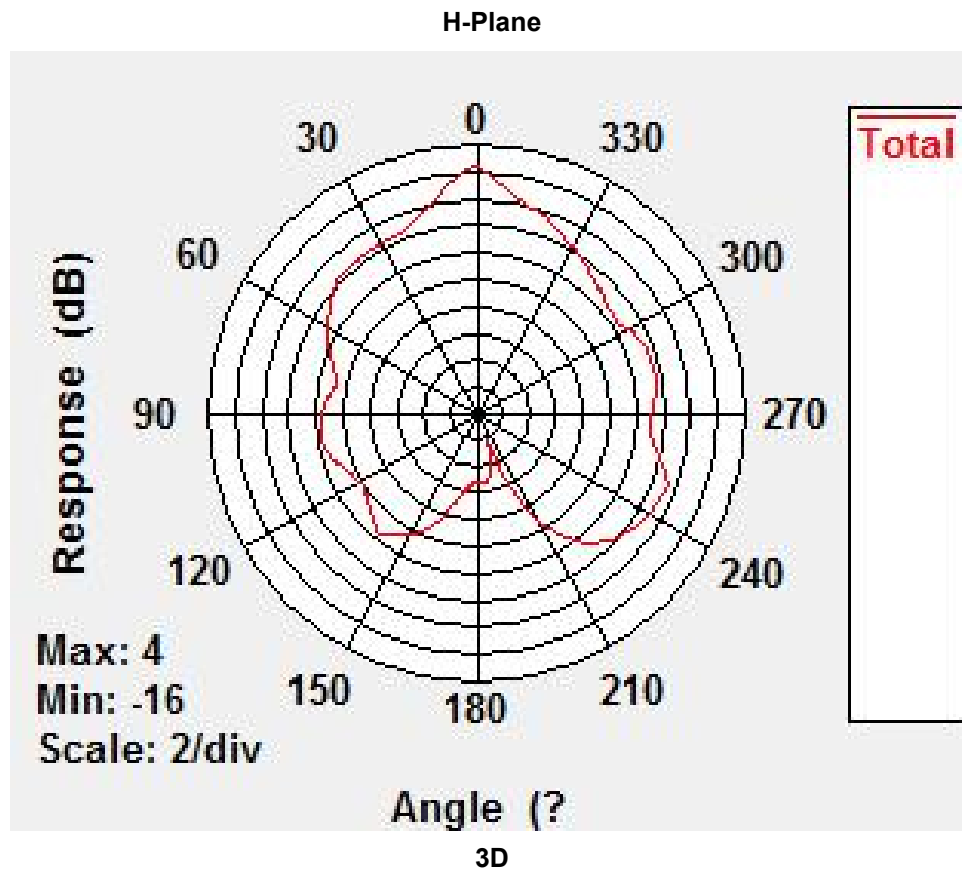

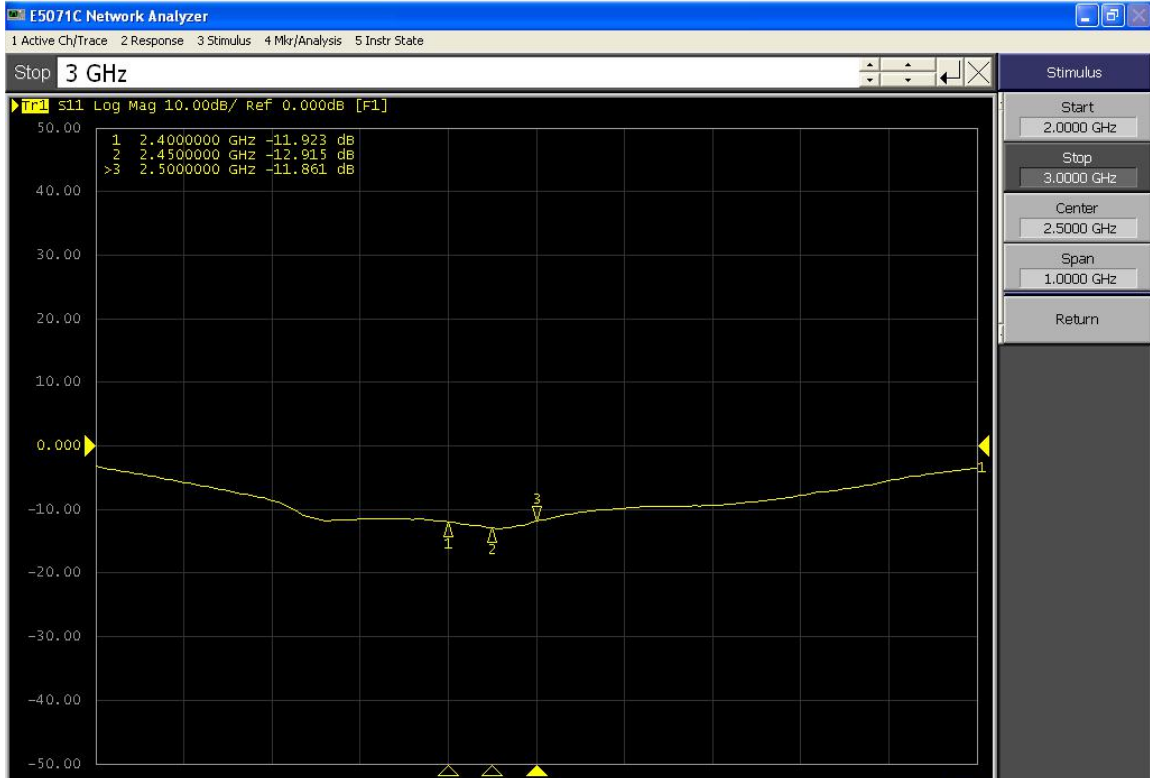

S11

**2.4G GAIN & PATTERN #1 RIGHT**

Frequency (MHz)	Efficiency (%)	Gain (dBi)
2400	46.81	1.35
2410	48.37	1.45
2420	47.26	0.88
2430	44.82	0.85
2440	44.73	1.08
2450	46.28	0.94
2460	47.65	1.70
2470	46.45	1.81
2480	47.03	1.19
2490	50.01	2.07
2500	54.84	2.90

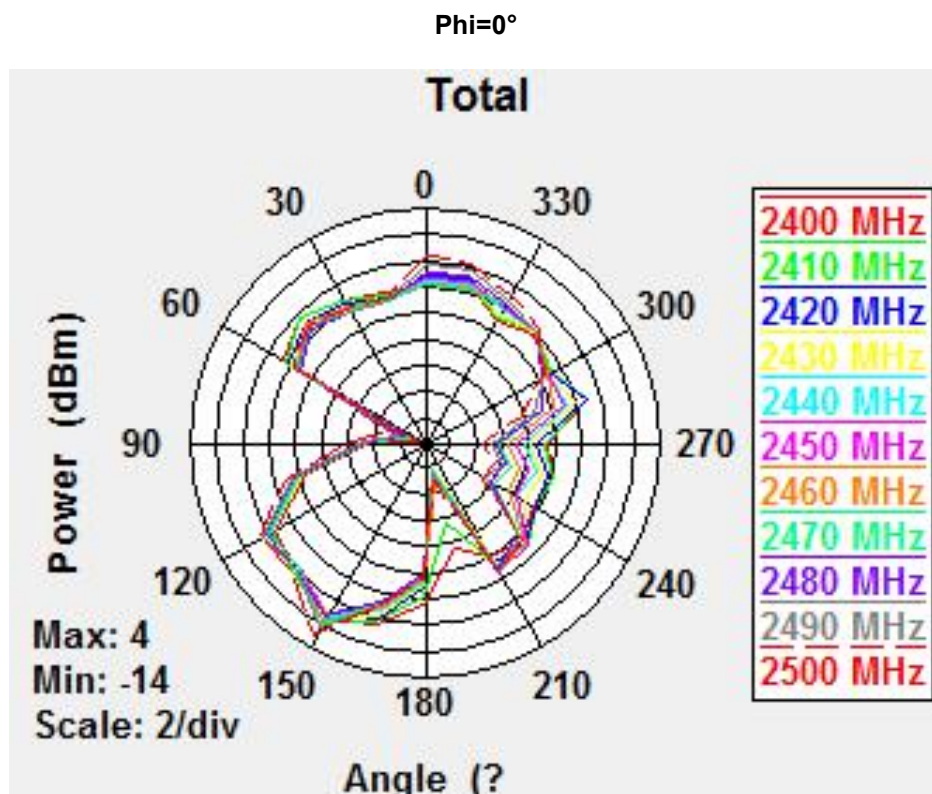
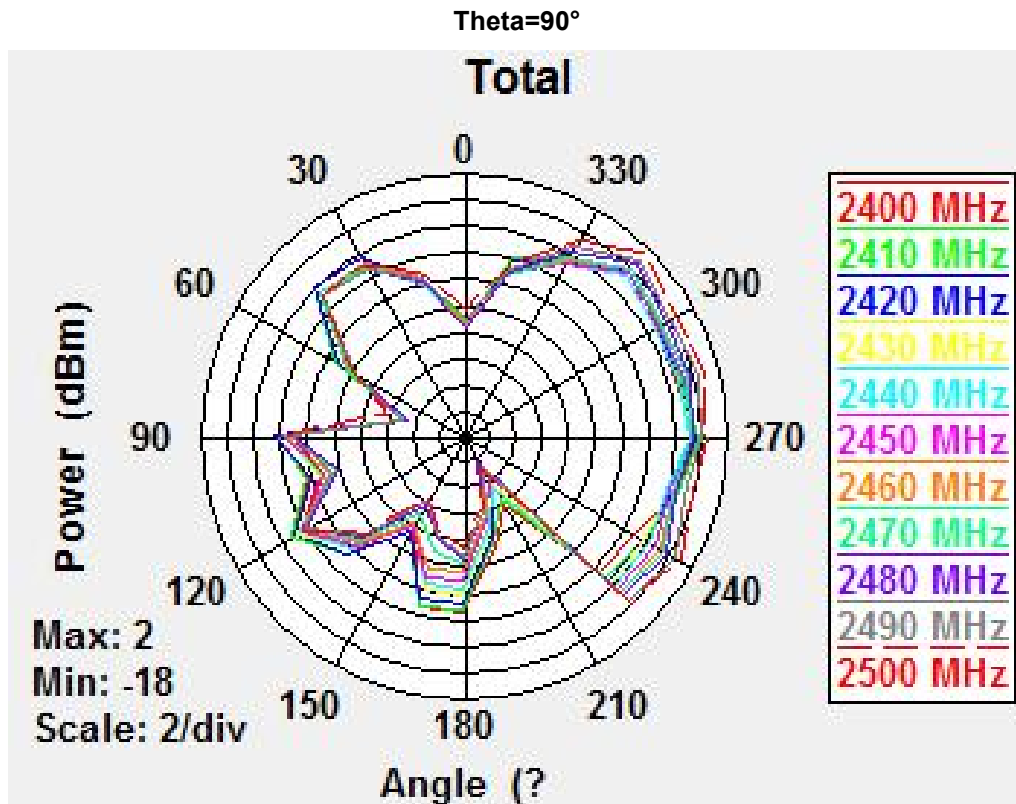

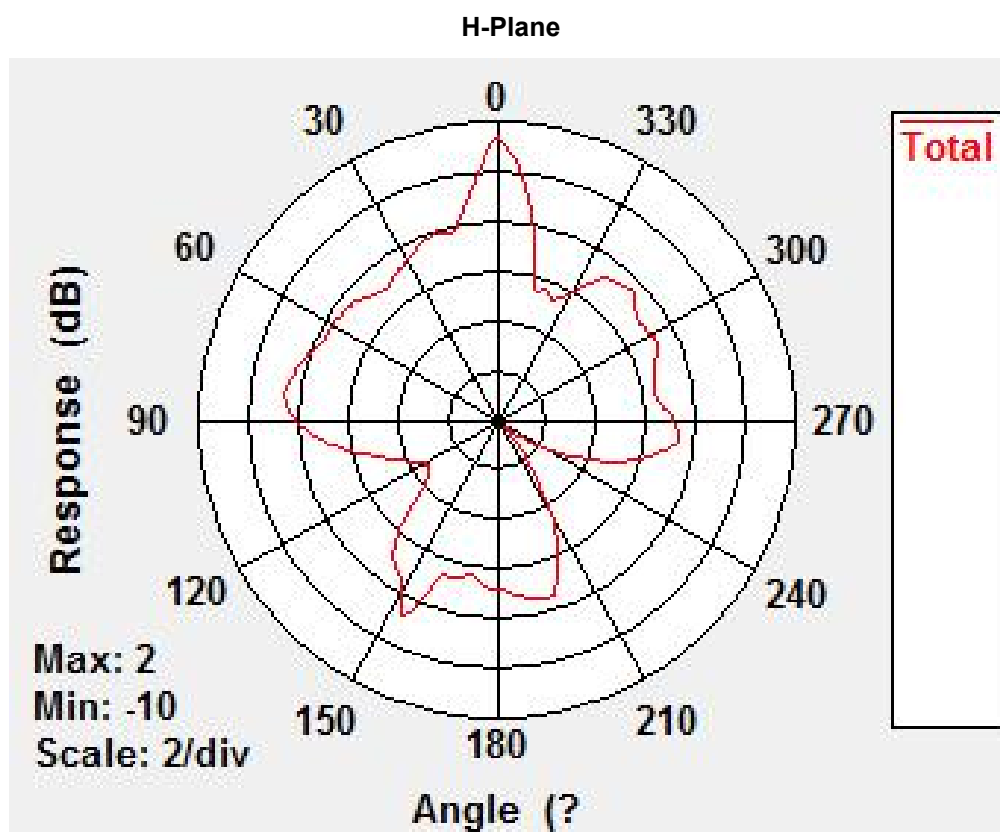

3D

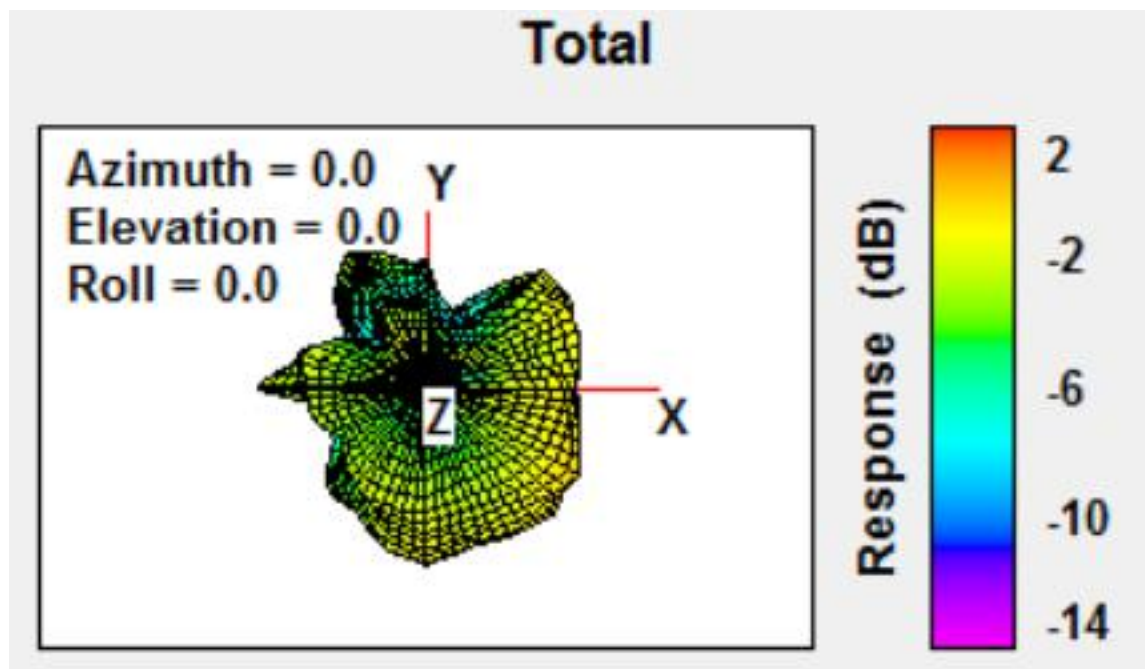

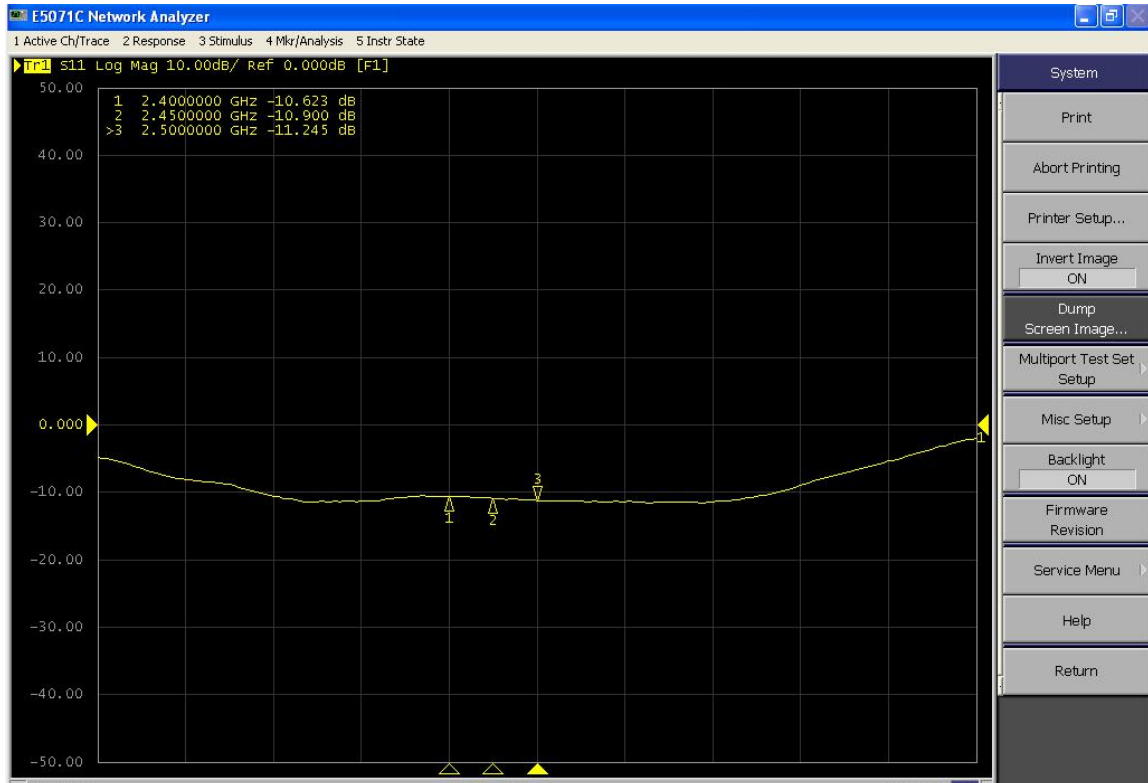

S11

**Measurement Uncertainty**

The expanded measurement uncertainties ( $k = 2$ ) for the results reported above have been determined to be as follows

Passive Measurement (dB)		
Test Configuration	2400-2500MHZ	5000-6000MHZ
Free Space	1.17	1.04



**. TEST EQUIPMENT LIST****TEST EQUIPMENT USED FOR MEASURING**

DESCRIPTION	MANUF.	MODEL NO.	SERIAL NO.
Vector Network Analyzer	Anritsu	MS46522B	1538101
System amplifier module	ETS	SAM-01	N/A
Anechoic Chamber	ETS	AMS-8923	CT001542-1305