

# FCC Radio Test Report

## FCC ID: RWO-RZ0603090R

This report concerns: **Original Grant**

**Project No.** : 1907C051  
**Equipment** : Gaming Controller  
**Brand Name** : RAZER  
**Test Model** : RZ06-03090R  
**Series Model** : RZ06-03090RXX-XXXX (X: Can Be: A~Z, 0~9)  
**Applicant** : Razer Inc.  
**Address** : 201 3rd Street, Suite 900, San Francisco, CA 94103 USA  
**Manufacturer** : Razer (Asia-Pacific) Pte.,Ltd.  
**Address** : 514 Chai Chee Lane, #07-01-06, Singapore 469029  
**Factory** : RAZER TECHNOLOGY AND DEVELOPMENT (SHENZHEN) CO., LTD  
**Address** : East Wing, 3rd Floor, Block 2, Phase 1 of Vision Shenzhen Business Park Keji South Road, Hi-Tech Industrial Park, Shenzhen 518057, China  
**Date of Receipt** : Jul. 05, 2019  
**Date of Test** : Jul. 08, 2019 ~ Aug. 05, 2019  
**Issued Date** : Sep. 27, 2019  
**Report Version** : R00  
**Test Sample** : Engineering Sample No.: DG1907088 for conducted, DG19070913 for radiated.  
**Standard(s)** : FCC Part15, Subpart C (15.247)  
ANSI C63.10-2013  
KDB 558074 D01 15.247 Meas Guidance V05r02

The above equipment has been tested and found compliance with the requirement of the relative standards by BTL Inc.



Prepared by : Kai Xu

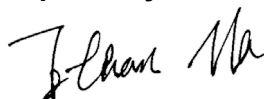

Approved by : Ethan Ma



Certificate #5123.02

Add: No.3, Jinshagang 1st Road, Shixia, Dalang Town, Dongguan, Guangdong, China.

Tel: +86-769-8318-3000

Web: [www.newbtl.com](http://www.newbtl.com)

**Declaration**

**BTL** represents to the client that testing is done in accordance with standard procedures as applicable and that test instruments used has been calibrated with standards traceable to international standard(s) and/or national standard(s).

**BTL's** reports apply only to the specific samples tested under conditions. It is manufacture's responsibility to ensure that additional production units of this model are manufactured with the identical electrical and mechanical components. **BTL** shall have no liability for any declarations, inferences or generalizations drawn by the client or others from **BTL** issued reports.

The report must not be used by the client to claim product certification, approval, or endorsement by NVLAP, NIST, A2LA, or any agency of the U.S. Government.

This report is the confidential property of the client. As a mutual protection to the clients, the public and ourselves, the test report shall not be reproduced, except in full, without our written approval.

**BTL's** laboratory quality assurance procedures are in compliance with the **ISO/IEC 17025** requirements, and accredited by the conformity assessment authorities listed in this test report.

**BTL** is not responsible for the sampling stage, so the results only apply to the sample as received.

The information, data and test plan are provided by manufacturer which may affect the validity of results, so it is manufacturer's responsibility to ensure that the apparatus meets the essential requirements of applied standards and in all the possible configurations as representative of its intended use.

**Limitation**

For the use of the authority's logo is limited unless the Test Standard(s)/Scope(s)/Item(s) mentioned in this test report is (are) included in the conformity assessment authorities acceptance respective.

Please note that the measurement uncertainty is provided for informational purpose only and are not use in determining the Pass/Fail results.

<b>Table of Contents</b>	<b>Page</b>
<b>REPORT ISSUED HISTORY</b>	<b>5</b>
<b>1 . SUMMARY OF TEST RESULTS</b>	<b>6</b>
1.1 TEST FACILITY	7
1.2 MEASUREMENT UNCERTAINTY	7
1.3 TEST ENVIRONMENT CONDITIONS	7
<b>2 . GENERAL INFORMATION</b>	<b>8</b>
2.1 GENERAL DESCRIPTION OF EUT	8
2.2 DESCRIPTION OF TEST MODES	10
2.3 PARAMETERS OF TEST SOFTWARE	10
2.4 BLOCK DIAGRAM SHOWING THE CONFIGURATION OF SYSTEM TESTED	11
2.5 SUPPORT UNITS	11
<b>3 . AC POWER LINE CONDUCTED EMISSIONS TEST</b>	<b>12</b>
3.1 LIMIT	12
3.2 TEST PROCEDURE	12
3.3 DEVIATION FROM TEST STANDARD	12
3.4 TEST SETUP	13
3.5 EUT OPERATING CONDITIONS	13
3.6 TEST RESULTS	13
<b>4 . RADIATED EMISSION TEST</b>	<b>14</b>
4.1 LIMIT	14
4.2 TEST PROCEDURE	15
4.3 DEVIATION FROM TEST STANDARD	15
4.4 TEST SETUP	16
4.5 EUT OPERATING CONDITIONS	17
4.6 TEST RESULT - 9 KHZ TO 30 MHZ	17
4.7 TEST RESULT - 30 MHZ TO 1000 MHZ	17
4.8 TEST RESULT - ABOVE 1000 MHZ	17
<b>5 . BANDWIDTH TEST</b>	<b>18</b>
5.1 LIMIT	18
5.2 TEST PROCEDURE	18
5.3 DEVIATION FROM STANDARD	18
5.4 TEST SETUP	18
5.5 EUT OPERATION CONDITIONS	18

<b>Table of Contents</b>	<b>Page</b>
5.6 TEST RESULTS	18
<b>6 . MAXIMUM OUTPUT POWER</b>	<b>19</b>
6.1 LIMIT	19
6.2 TEST PROCEDURE	19
6.3 DEVIATION FROM STANDARD	19
6.4 TEST SETUP	19
6.5 EUT OPERATION CONDITIONS	19
6.6 TEST RESULTS	19
<b>7 . CONDUCTED SPURIOUS EMISSION</b>	<b>20</b>
7.1 LIMIT	20
7.2 TEST PROCEDURE	20
7.3 DEVIATION FROM STANDARD	20
7.4 TEST SETUP	20
7.5 EUT OPERATION CONDITIONS	20
7.6 TEST RESULTS	20
<b>8 . POWER SPECTRAL DENSITY TEST</b>	<b>21</b>
8.1 LIMIT	21
8.2 TEST PROCEDURE	21
8.3 DEVIATION FROM STANDARD	21
8.4 TEST SETUP	21
8.5 EUT OPERATION CONDITIONS	21
8.6 TEST RESULTS	21
<b>9 . MEASUREMENT INSTRUMENTS LIST</b>	<b>22</b>
<b>APPENDIX A - AC POWER LINE CONDUCTED EMISSIONS</b>	<b>24</b>
<b>APPENDIX B - RADIATED EMISSION - 9 KHZ TO 30 MHZ</b>	<b>27</b>
<b>APPENDIX C - RADIATED EMISSION - 30 MHZ TO 1000 MHZ</b>	<b>32</b>
<b>APPENDIX D - RADIATED EMISSION - ABOVE 1000 MHZ</b>	<b>35</b>
<b>APPENDIX E - BANDWIDTH</b>	<b>60</b>
<b>APPENDIX F - MAXIMUM OUTPUT POWER</b>	<b>62</b>
<b>APPENDIX G - CONDUCTED SPURIOUS EMISSION</b>	<b>64</b>
<b>APPENDIX H - POWER SPECTRAL DENSITY</b>	<b>67</b>

**REPORT ISSUED HISTORY**

Report Version	Description	Issued Date
R00	Original Issue.	Sep. 27, 2019

## 1. SUMMARY OF TEST RESULTS

Test procedures according to the technical standard(s):

FCC Part15, Subpart C (15.247)				
Standard(s) Section	Test Item	Test Result	Judgment	Remark
15.207	AC Power Line Conducted Emissions	APPENDIX A	PASS	-----
15.247(d) 15.205(a) 15.209(a)	Radiated Emissions	APPENDIX B APPENDIX C APPENDIX D	PASS	-----
15.247(a)(2)	Bandwidth	APPENDIX E	PASS	-----
15.247(b)(3)	Maximum Output Power	APPENDIX F	PASS	-----
15.247(d)	Conducted Spurious Emission	APPENDIX G	PASS	-----
15.247(e)	Power Spectral Density	APPENDIX H	PASS	-----
15.203	Antenna Requirement	-----	PASS	Note(2)

Note:

- (1) "N/A" denotes test is not applicable to this device.
- (2) The device what use a permanently attached antenna were considered sufficient to comply with the provisions of 15.203.

### 1.1 TEST FACILITY

The test facilities used to collect the test data in this report is at the location of No.3, Jinshagang 1st Road, Shixia, Dalang Town, Dongguan, Guangdong, China.

BTL's Test Firm Registration Number for FCC: 357015

BTL's Designation Number for FCC: CN1240

### 1.2 MEASUREMENT UNCERTAINTY

ISO/IEC 17025 requires that an estimate of the measurement uncertainties associated with the emissions test results be included in the report. The measurement uncertainties given below are based on a 95% confidence level (based on a coverage factor (k=2))

The BTL measurement uncertainty as below table:

#### A. AC power line conducted emissions Measurement:

Test Site	Method	Measurement Frequency Range	U, (dB)
DG-C02	CISPR	150 kHz ~ 30 MHz	2.32

#### B. Radiated emissions Measurement:

Test Site	Method	Measurement Frequency Range	Ant. H / V	U, (dB)
DG-CB03	CISPR	9KHz ~ 30MHz	V	3.79
		9KHz ~ 30MHz	H	3.57
		30MHz ~ 200MHz	V	4.88
		30MHz ~ 200MHz	H	4.14
		200MHz ~ 1,000MHz	V	4.62
		200MHz ~ 1,000MHz	H	4.80
		1GHz ~ 6GHz	-	4.58
		6GHz ~ 18GHz	-	5.18
		18GHz ~ 26.5 GHz	-	3.80
		26.5GHz ~ 40 GHz	-	4.30

Note: Unless specifically mentioned, the uncertainty of measurement has not been taken into account to declare the compliance or non-compliance to the specification.

### 1.3 TEST ENVIRONMENT CONDITIONS

Test Item	Temperature	Humidity	Test Voltage	Tested By
AC Power Line Conducted Emissions	27°C	53%	DC 5V	Robin Zhuang
Radiated Emissions-9K-30MHz	25°C	60%	DC 5V	Robin Zhuang
Radiated Emissions-30 MHz to 1GHz	24°C	68%	DC 5V	Bert Xu
Radiated Emissions-Above 1000 MHz	24°C	68%	DC 5V	Bert Xu
Bandwidth	27°C	53%	DC 3.7V	Jonas Chen
Maximum Output Power	27°C	53%	DC 3.7V	Jonas Chen
Conducted Spurious Emission	27°C	53%	DC 3.7V	Jonas Chen
Power Spectral Density	27°C	53%	DC 3.7V	Jonas Chen

## 2. GENERAL INFORMATION

### 2.1 GENERAL DESCRIPTION OF EUT

Equipment	Gaming Controller
Brand Name	RAZER
Test Model	RZ06-03090R
Series Model	RZ06-03090RXX-XXXX (X: Can Be: A~Z, 0~9)
Model Difference(s)	RZ06-0309 consists of left controller RZ06-03090L and right controller RZ06-03090R.
Hardware Version	DVT
Software Version	v80.0.0
Power Source	1# Supplied from USB port. 2# Supplied from battery. Model: FT442631P
Power Rating	1# DC 5V 500mA 2# DC 3.7V 370mAh 1.369Wh
Operation Frequency	2402 MHz ~ 2480 MHz
Modulation Technology	GFSK
Bit Rate of Transmitter	1/2Mbps
Max. Output Power	5.17 dBm (0.0033 W) for 1Mbps 5.17 dBm (0.0033 W) for 2Mbps

Note:

1. For a more detailed features description, please refer to the manufacturer's specifications or the user's manual.



## 2. Channel List:

Channel	Frequency (MHz)	Channel	Frequency (MHz)
00	2402	20	2442
01	2404	21	2444
02	2406	22	2446
03	2408	23	2448
04	2410	24	2450
05	2412	25	2452
06	2414	26	2454
07	2416	27	2456
08	2418	28	2458
09	2420	29	2460
10	2422	30	2462
11	2424	31	2464
12	2426	32	2466
13	2428	33	2468
14	2430	34	2470
15	2432	35	2472
16	2434	36	2474
17	2436	37	2476
18	2438	38	2478
19	2440	39	2480

## 3. Table for Filed Antenna:

Ant.	Brand	P/N	Antenna Type	Connector	Gain (dBi)
1		2065130001	Internal	N/A	3.60

## 2.2 DESCRIPTION OF TEST MODES

The test system was pre-tested based on the consideration of all possible combinations of EUT operation mode.

Pretest Mode	Description
Mode 1	TX Mode NOTE (1)
Mode 2	TX Mode Channel 39 _2Mbps

Following mode(s) as (were) found to be the worst case(s) and selected for the final test.

<b>AC power line conducted emissions test</b>	
Final Test Mode	Description
Mode 2	TX Mode Channel 39 _2Mbps

<b>Radiated emissions test - Below 1GHz</b>	
Final Test Mode	Description
Mode 2	TX Mode Channel 39 _2Mbps

<b>Radiated emissions test - Above 1GHz</b>	
Final Test Mode	Description
Mode 1	TX Mode NOTE (1)

<b>Conducted test</b>	
Final Test Mode	Description
Mode 1	TX Mode NOTE (1)

Note:

- (1) The measurements are performed at the high, middle, low available channels.
- (2) For radiated emission above 1 GHz test, 1GHz~26.5GHz have been pre-tested and in this report only recorded the worst case. The remaining spurious points are all below the limit value of 20dB.

## 2.3 PARAMETERS OF TEST SOFTWARE

During testing channel & power controlling software provided by the customer was used to control the operating channel as well as the output power level. The RF output power selection is for the setting of RF output power expected by the customer and is going to be fixed on the firmware of the final end product power parameters of BT LE

Test Software	N/A		
Frequency (MHz)	2402	2440	2480
1Mbps	N/A	N/A	N/A
2Mbps	N/A	N/A	N/A

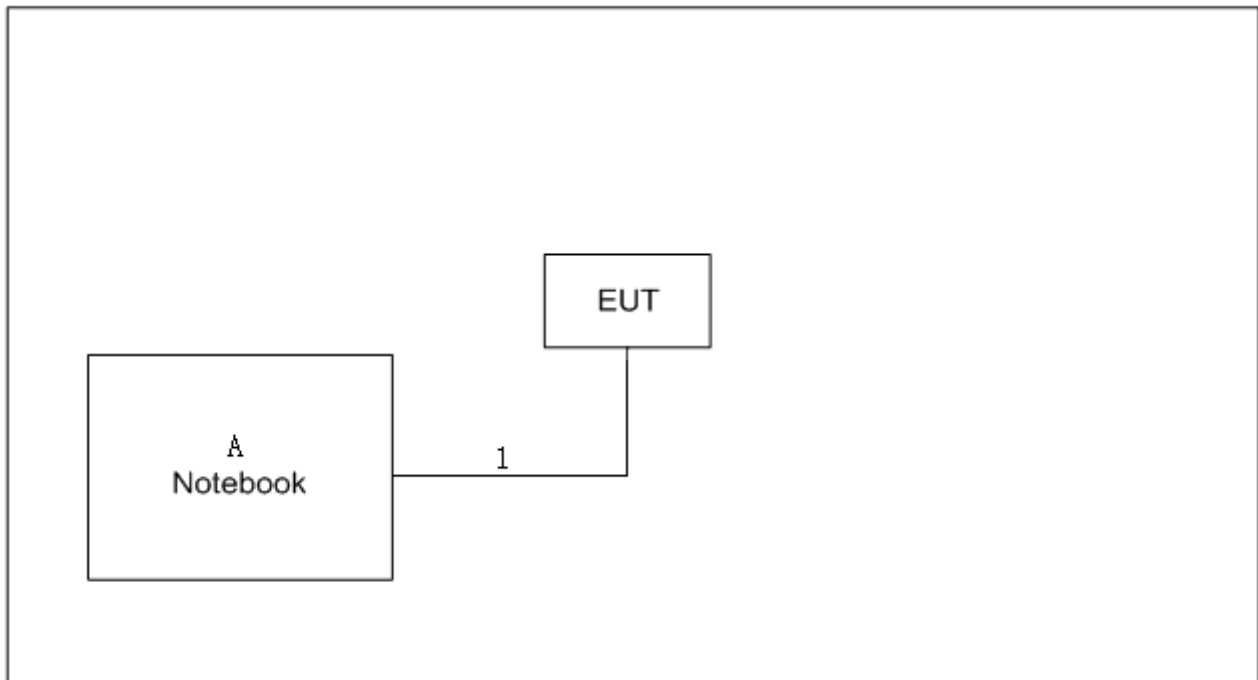
**2.4 BLOCK DIAGRAM SHOWING THE CONFIGURATION OF SYSTEM TESTED****2.5 SUPPORT UNITS**

Item	Equipment	Brand	Model No.	Series No.
A	Notebook	Dell	Inspiron 15-7559	N/A

Item	Cable Type	Shielded Type	Ferrite Core	Length
1	USB Cable	NO	NO	0.8m

### 3. AC POWER LINE CONDUCTED EMISSIONS TEST

#### 3.1 LIMIT

Frequency of Emission (MHz)	Limit (dB $\mu$ V)	
	Quasi-peak	Average
0.15 - 0.50	66 to 56*	56 to 46*
0.50 - 5.0	56	46
5.0 - 30.0	60	50

Note:

- (1) The tighter limit applies at the band edges.
- (2) The limit of " \* " marked band means the limitation decreases linearly with the logarithm of the frequency in the range.

The following table is the setting of the receiver

Receiver Parameters	Setting
Attenuation	10 dB
Start Frequency	0.15 MHz
Stop Frequency	30 MHz
IF Bandwidth	9 kHz

#### 3.2 TEST PROCEDURE

- a. The EUT was placed 0.8 meters from the horizontal ground plane with EUT being connected to the power mains through a line impedance stabilization network (LISN). All other support equipment powered from additional LISN(s). The LISN provide 50 Ohm/ 50uH of coupling impedance for the measuring instrument.
- b. Interconnecting cables that hang closer than 40 cm to the ground plane shall be folded back and forth in the center forming a bundle 30 to 40 cm long.
- c. I/O cables that are not connected to a peripheral shall be bundled in the center. The end of the cable may be terminated, if required, using the correct terminating impedance. The overall length shall not exceed 1 m.
- d. LISN at least 80 cm from nearest part of EUT chassis.
- e. For the actual test configuration, please refer to the related Item –EUT Test Photos.

#### 3.3 DEVIATION FROM TEST STANDARD

No deviation

### 3.4 TEST SETUP

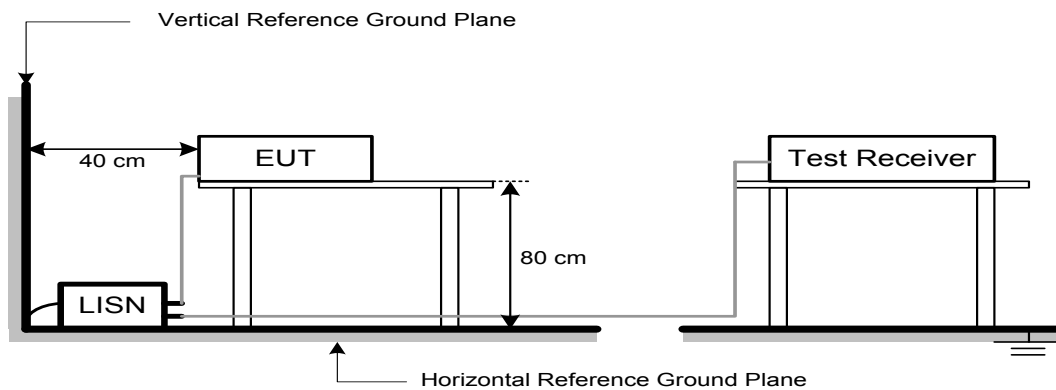

### 3.5 EUT OPERATING CONDITIONS

The EUT was configured for testing in a typical fashion (as a customer would normally use it). The EUT has been programmed to continuously transmit during test. This operating condition was tested and used to collect the included data.

### 3.6 TEST RESULTS

Please refer to the APPENDIX A.

Remark:

- (1) All readings are QP Mode value unless otherwise stated AVG in column of 'Note'. If the QP Mode Measured value compliance with the QP Limits and lower than AVG Limits, the EUT shall be deemed to meet both QP & AVG Limits and then only QP Mode was measured, but AVG Mode didn't perform. In this case, a "\*" marked in AVG Mode column of Interference Voltage Measured.
- (2) Measuring frequency range from 150 kHz to 30 MHz.

## 4. RADIATED EMISSION TEST

### 4.1 LIMIT

In case the emission fall within the restricted band specified on 15.205(a), then the 15.209(a) limit in the table below has to be followed.

#### LIMITS OF RADIATED EMISSION MEASUREMENT (9 kHz-1000 MHz)

Frequency (MHz)	Field Strength (microvolts/meter)	Measurement Distance (meters)
0.009-0.490	2400/F(kHz)	300
0.490-1.705	24000/F(kHz)	30
1.705-30.0	30	30
30-88	100	3
88-216	150	3
216-960	200	3
Above 960	500	3

#### LIMITS OF RADIATED EMISSION MEASUREMENT (Above 1000 MHz)

Frequency (MHz)	(dBuV/m at 3 m)	
	Peak	Average
Above 1000	74	54

Note:

- (1) The limit for radiated test was performed according to FCC PART 15C.
- (2) The tighter limit applies at the band edges.
- (3) Emission level (dBuV/m)=20log Emission level (uV/m).

Spectrum Parameter	Setting
Attenuation	Auto
Start Frequency	1000 MHz
Stop Frequency	10th carrier harmonic
RBW / VBW (Emission in restricted band)	RBW 1 MHz VBW 3 MHz peak detector for Pk value RMS detector for AV value

Receiver Parameter	Setting
Attenuation	Auto
Start ~ Stop Frequency	9 kHz~90 kHz for PK/AVG detector
Start ~ Stop Frequency	90 kHz~110 kHz for QP detector
Start ~ Stop Frequency	110 kHz~490 kHz for PK/AVG detector
Start ~ Stop Frequency	490 kHz~30 MHz for QP detector
Start ~ Stop Frequency	30 MHz~1000 MHz for QP detector

#### 4.2 TEST PROCEDURE

- a. The measuring distance of 3 m shall be used for measurements. The EUT was placed on the top of a rotating table 0.8 meter above the ground at a 3 meter semi-anechoic chamber. The table was rotated 360 degrees to determine the position of the highest radiation.(below 1 GHz)
- b. The measuring distance of 3 m shall be used for measurements. The EUT was placed on the top of a rotating table 1.5 meter above the ground at a 3 meter semi-anechoic chamber. The table was rotated 360 degrees to determine the position of the highest radiation.(above 1 GHz)
- c. The height of the equipment or of the substitution antenna shall be 0.8m or 1.5m; the height of the test antenna shall vary between 1 m to 4 m. Both horizontal and vertical polarizations of the antenna are set to make the measurement.
- d. For each suspected emission, the EUT was arranged to its worst case and then the antenna was tuned to heights find the maximum reading (used Bore sight function).
- e. The receiver system was set to peak and average detect function and specified bandwidth with maximum hold mode when the test frequency is above 1 GHz.
- f. The initial step in collecting radiated emission data is a receiver peak detector mode pre-scanning the measurement frequency range. Significant peaks are then marked and then Quasi Peak detector mode re-measured.
- g. All readings are Peak unless otherwise stated QP in column of Note. Peak denotes that the Peak reading compliance with the QP Limits and then QP Mode measurement didn't perform. (below 1 GHz)
- h. All readings are Peak Mode value unless otherwise stated AVG in column of Note. If the Peak Mode Measured value compliance with the Peak Limits and lower than AVG Limits, the EUT shall be deemed to meet both Peak & AVG Limits and then only Peak Mode was measured, but AVG Mode didn't perform. (above 1 GHz)
- i. For the actual test configuration, please refer to the related Item –EUT Test Photos.

#### 4.3 DEVIATION FROM TEST STANDARD

No deviation

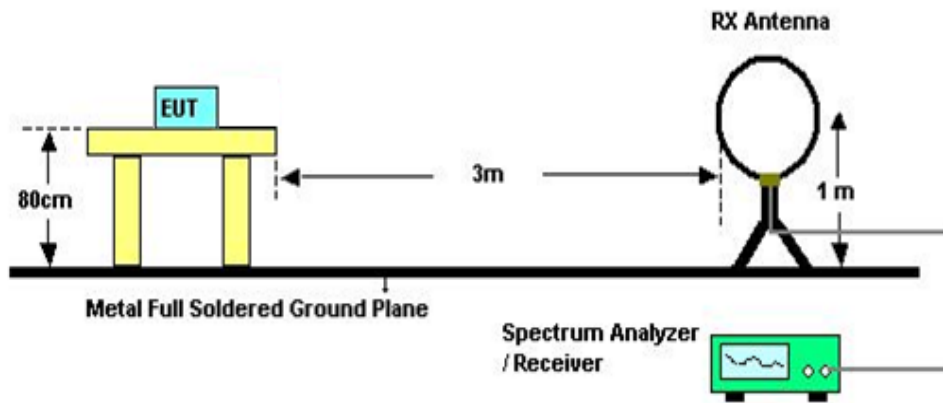
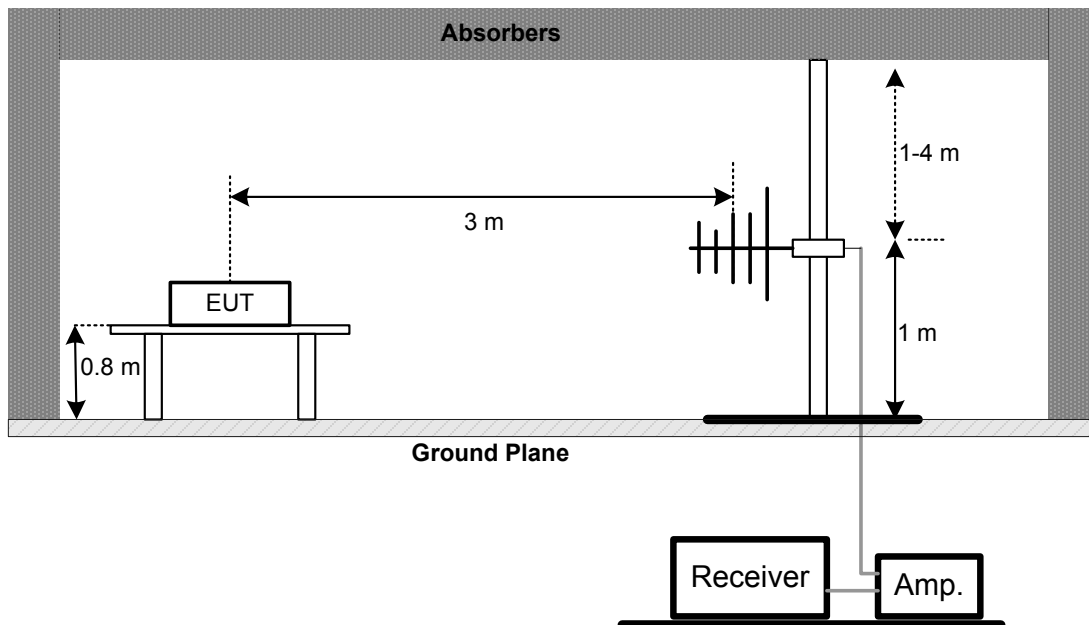
**4.4 TEST SETUP****9 kHz-30 MHz****30 MHz to 1 GHz**



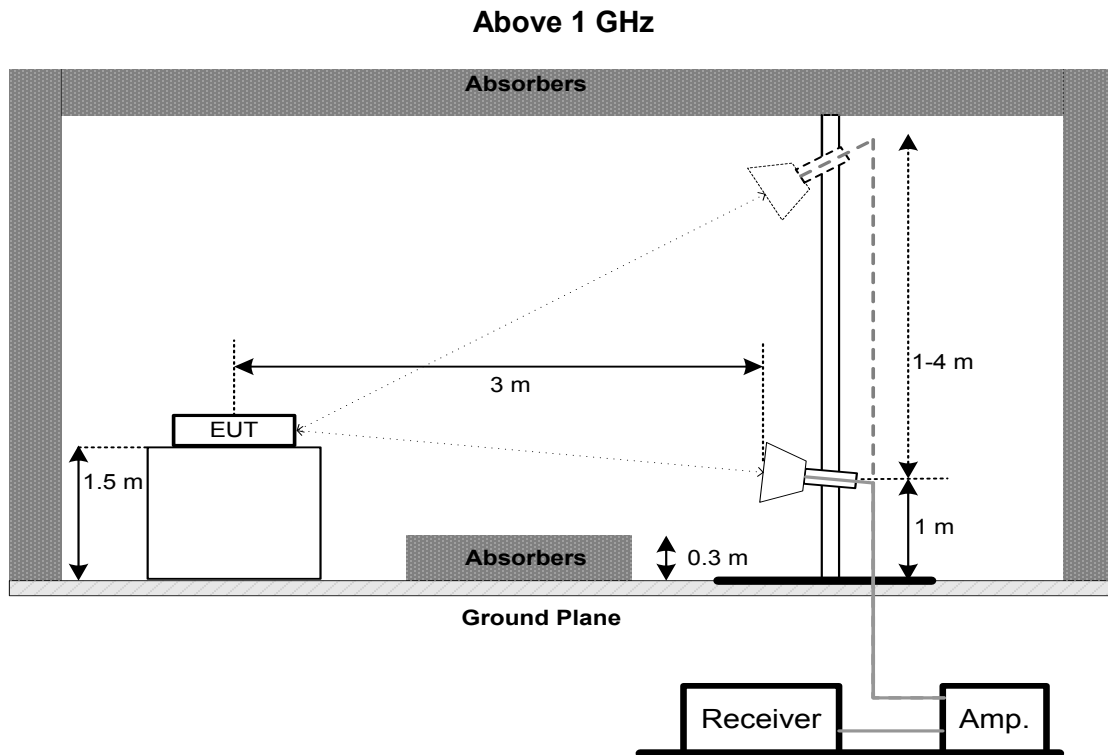

#### 4.5 EUT OPERATING CONDITIONS

The EUT was programmed to be in continuously transmitting mode.

#### 4.6 TEST RESULT - 9 kHz TO 30 MHz

Please refer to the APPENDIX B

Remark:

- (1) Distance extrapolation factor =  $40 \log (\text{specific distance} / \text{test distance})$  (dB).
- (2) Limit line = specific limits (dBuV) + distance extrapolation factor.

#### 4.7 TEST RESULT - 30 MHz TO 1000 MHz

Please refer to the APPENDIX C.

#### 4.8 TEST RESULT - ABOVE 1000 MHz

Please refer to the APPENDIX D.

Remark:

- (1) No limit: This is fundamental signal, the judgment is not applicable.  
For fundamental signal judgment was referred to Peak output test.

**5. BANDWIDTH TEST**

**5.1 LIMIT**

FCC Part15, Subpart C (15.247)		
Section	Test Item	Limit
15.247(a)(2)	Bandwidth	$\geq 500$ kHz (6 dB bandwidth)

**5.2 TEST PROCEDURE**

- a. The EUT was directly connected to the spectrum analyzer and antenna output port as show in the block diagram below.
- b. Spectrum Setting : RBW= 100 kHz, VBW=300 kHz, Sweep time = 2.5 ms.

**5.3 DEVIATION FROM STANDARD**

No deviation.

**5.4 TEST SETUP**

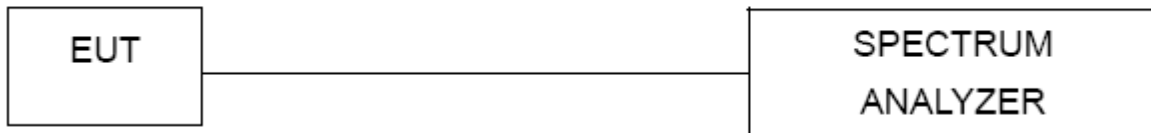

**5.5 EUT OPERATION CONDITIONS**

The EUT tested system was configured as the statements of 4.5 unless otherwise a special operating condition is specified in the follows during the testing.

**5.6 TEST RESULTS**

Please refer to the APPENDIX E.

## 6. MAXIMUM OUTPUT POWER

### 6.1 LIMIT

FCC Part15, Subpart C (15.247)		
Section	Test Item	Limit
15.247(b)(3)	Maximum Output Power	1 watt or 30 dBm

### 6.2 TEST PROCEDURE

- a. The EUT was directly connected to the spectrum analyzer and antenna output port as show in the block diagram below.
- b. The maximum conducted output power was performed in accordance with method 11.9.1.1 of ANSI C63.10-2013.

### 6.3 DEVIATION FROM STANDARD

No deviation.

### 6.4 TEST SETUP



### 6.5 EUT OPERATION CONDITIONS

The EUT tested system was configured as the statements of 4.5 unless otherwise a special operating condition is specified in the follows during the testing.

### 6.6 TEST RESULTS

Please refer to the APPENDIX F.

## 7. CONDUCTED SPURIOUS EMISSION

### 7.1 LIMIT

In any 100 kHz bandwidth outside the frequency band in which the spread spectrum or digitally modulated intentional radiator is operating, the radio frequency power that is produced by the intentional radiator shall be at least 20 dB below that in the 100 kHz bandwidth within the band that contains the highest level of the desired power, based on either an RF conducted or a radiated measurement, provided the transmitter demonstrates compliance with the peak Output Power limits. If the transmitter complies with the Output Power limits based on the use of RMS averaging over a time interval, as permitted under paragraph (b)(3) of this section, the attenuation required under this paragraph shall be 30 dB instead of 20 dB. Attenuation below the general limits specified in Section 15.209(a) is not required.

### 7.2 TEST PROCEDURE

- a. The EUT was directly connected to the spectrum analyzer and antenna output port as show in the block diagram below.
- b. Spectrum Setting : RBW= 100 kHz, VBW=300 kHz, Sweep time = 10 ms.

### 7.3 DEVIATION FROM STANDARD

No deviation.

### 7.4 TEST SETUP

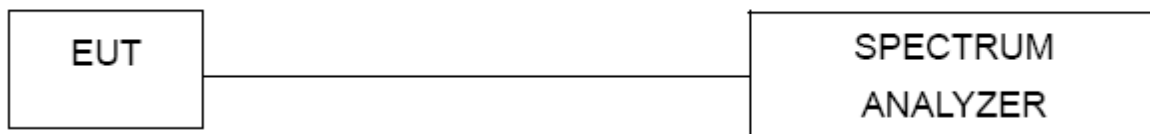

### 7.5 EUT OPERATION CONDITIONS

The EUT tested system was configured as the statements of 4.5 unless otherwise a special operating condition is specified in the follows during the testing.

### 7.6 TEST RESULTS

Please refer to the APPENDIX G.

## 8. POWER SPECTRAL DENSITY TEST

### 8.1 LIMIT

FCC Part15, Subpart C (15.247)		
Section	Test Item	Limit
15.247(e)	Power Spectral Density	8 dBm (in any 3 kHz)

### 8.2 TEST PROCEDURE

- a. The EUT was directly connected to the spectrum analyzer and antenna output port as show in the block diagram below.
- b. Spectrum Setting: RBW=3 kHz, VBW=10 kHz, Sweep time = auto.

### 8.3 DEVIATION FROM STANDARD

No deviation.

### 8.4 TEST SETUP



### 8.5 EUT OPERATION CONDITIONS

The EUT tested system was configured as the statements of 4.5 unless otherwise a special operating condition is specified in the follows during the testing.

### 8.6 TEST RESULTS

Please refer to the APPENDIX H.

**9. MEASUREMENT INSTRUMENTS LIST**

AC Power Line Conducted Emissions					
Item	Kind of Equipment	Manufacturer	Type No.	Serial No.	Calibrated until
1	EMI Test Receiver	R&S	ESCI	100382	Mar. 10, 2020
2	LISN	EMCO	3816/2	52765	Mar. 10, 2020
3	50ohm Terminator	SHX	TF5-3	15041305	Mar. 10, 2020
4	Artificial-Mains Network	SCHWARZBEC K	NSLK 8127	8127685	Mar. 10, 2020
5	TRANSIENT LIMITER	EM	EM-7600	772	Mar. 10, 2020
6	Measurement Software	Farad	EZ-EMC Ver.NB-03A1-01	N/A	N/A
7	Cable	N/A	RG223	12m	Mar. 12, 2020

Radiated Emissions - 9 kHz to 30 MHz					
Item	Kind of Equipment	Manufacturer	Type No.	Serial No.	Calibrated until
1	Loop Antenna	EM	EM-6876-1	230	Jan. 15, 2020
2	Cable	N/A	RG 213/U	C-102	May 31, 2020
3	EMI Test Receiver	R&S	ESCI	100895	Mar. 10, 2020
4	Measurement Software	Farad	EZ-EMC Ver.NB-03A1-01	N/A	N/A

Radiated Emissions - 30 MHz to 1 GHz					
Item	Kind of Equipment	Manufacturer	Type No.	Serial No.	Calibrated until
1	Antenna	Schwarzbeck	VULB9160	9160-3232	Mar. 09, 2020
2	Amplifier	HP	8447D	2944A09673	Aug. 11, 2019
3	Receiver	Agilent	N9038A	MY52130039	Aug. 11, 2019
4	Cable	emci	LMR-400(30MHz-1GHz)(8m+5m)	N/A	May 24, 2020
5	Controller	CT	SC100	N/A	N/A
6	Controller	MF	MF-7802	MF780208416	N/A
7	Measurement Software	Farad	EZ-EMC Ver.NB-03A1-01	N/A	N/A

Radiated Emissions - Above 1 GHz					
Item	Kind of Equipment	Manufacturer	Type No.	Serial No.	Calibrated until
1	Double Ridged Guide Antenna	ETS	3115	75789	Mar. 09, 2020
2	Broad-Band Horn Antenna	Schwarzbeck	BBHA 9170	9170319	Jun. 23, 2020
3	Amplifier	Agilent	8449B	3008A02333	Mar. 10, 2020
4	Microwave Preamplifier With Adaptor	EMC INSTRUMENT	EMC2654045	980039 & HA01	Mar. 10, 2020
5	Receiver	Agilent	N9038A	MY52130039	Aug. 11, 2019
6	Controller	CT	SC100	N/A	N/A
7	Controller	MF	MF-7802	MF780208416	N/A
8	Cable	mitron	B10-01-01-12M	18072744	Jun. 29, 2020
9	Measurement Software	Farad	EZ-EMC Ver.NB-03A1-01	N/A	N/A

<b>Bandwidth</b>					
Item	Kind of Equipment	Manufacturer	Type No.	Serial No.	Calibrated until
1	Spectrum Analyzer	R&S	FSP40	100185	Aug. 11, 2019

<b>Maximum Output Power</b>					
Item	Kind of Equipment	Manufacturer	Type No.	Serial No.	Calibrated until
1	Spectrum Analyzer	R&S	FSP40	100185	Aug. 11, 2019

<b>Antenna Conducted Spurious Emissions</b>					
Item	Kind of Equipment	Manufacturer	Type No.	Serial No.	Calibrated until
1	Spectrum Analyzer	R&S	FSP40	100185	Aug. 11, 2019

<b>Power Spectral Density</b>					
Item	Kind of Equipment	Manufacturer	Type No.	Serial No.	Calibrated until
1	Spectrum Analyzer	R&S	FSP40	100185	Aug. 11, 2019

Remark: "N/A" denotes no model name, serial no. or calibration specified.

All calibration period of equipment list is one year.

## **APPENDIX A - AC POWER LINE CONDUCTED EMISSIONS**



Test Mode: TX Mode Channel 39 \_2Mbps

### Line

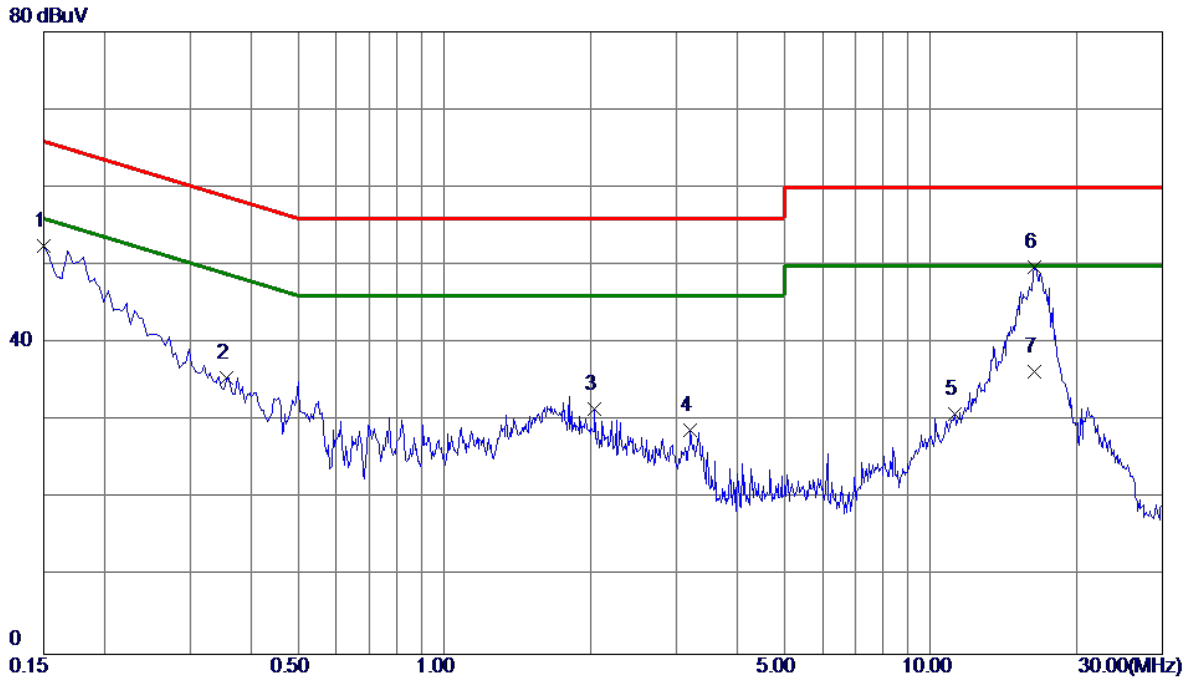

No.	Freq. MHz	Reading Level dBuV	Correct Factor dB	Measure ment dBuV	Limit dBuV	Margin dB	Detector	Comment
1	0.1500	42.66	9.82	52.48	66.00	-13.52	Peak	
2	0.3570	25.72	9.85	35.57	58.80	-23.23	Peak	
3	2.0400	21.49	10.00	31.49	56.00	-24.51	Peak	
4	3.2100	18.70	10.07	28.77	56.00	-27.23	Peak	
5	11.2514	20.35	10.56	30.91	60.00	-29.09	Peak	
6 *	16.3455	38.86	10.86	49.72	60.00	-10.28	Peak	
7	16.3455	25.40	10.86	36.26	50.00	-13.74	AVG	

**REMARKS:**

- (1) Measurement Value = Reading Level + Correct Factor.
- (2) Margin Level = Measurement Value - Limit Value.

Test Mode: TX Mode Channel 39 \_2Mbps

## Neutral

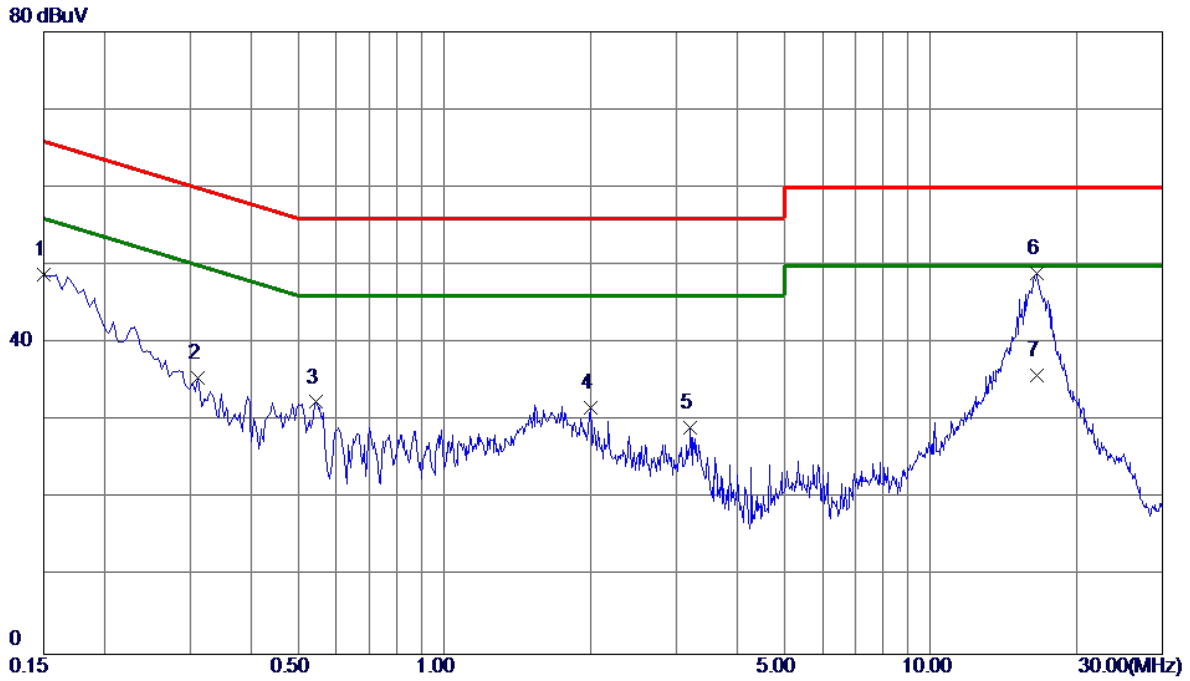

No.	Freq. MHz	Reading Level dBuV	Correct Factor dB	Measure ment dBuV	Limit dBuV	Margin dB	Detector	Comment
1	0.1500	38.88	9.91	48.79	66.00	-17.21	Peak	
2	0.3120	25.63	9.96	35.59	59.92	-24.33	Peak	
3	0.5460	22.37	10.03	32.40	56.00	-23.60	Peak	
4	1.9950	21.53	10.19	31.72	56.00	-24.28	Peak	
5	3.2100	18.87	10.26	29.13	56.00	-26.87	Peak	
6 *	16.5885	37.73	11.21	48.94	60.00	-11.06	Peak	
7	16.5885	24.69	11.21	35.90	50.00	-14.10	AVG	

**REMARKS:**

- (1) Measurement Value = Reading Level + Correct Factor.
- (2) Margin Level = Measurement Value - Limit Value.

## **APPENDIX B - RADIATED EMISSION - 9 KHZ TO 30 MHZ**

Test Mode: TX Mode Channel 39 \_2Mbps

**Ant 0°**

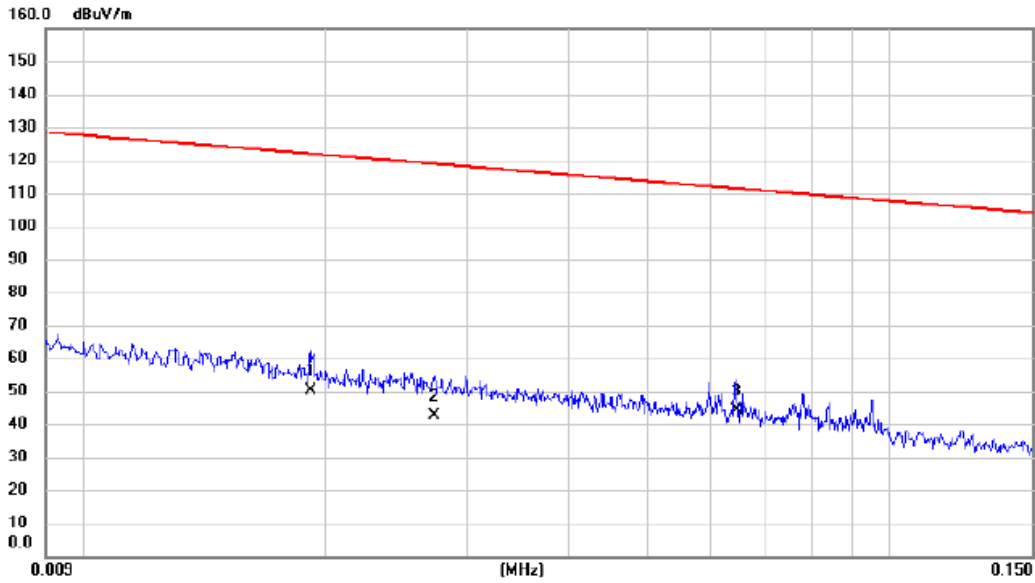

No.	Mk.	Freq. MHz	Reading Level dBuV	Correct Factor dB	Measure- ment dBuV/m	Limit dBuV/m	Margin dB	Detector	Comment
1		0.0192	36.10	14.06	50.16	121.94	-71.78	AVG	
2		0.0273	28.70	13.84	42.54	118.88	-76.34	AVG	
3	*	0.0645	30.50	13.70	44.20	111.41	-67.21	AVG	

**REMARKS:**

- (1) Measurement Value = Reading Level + Correct Factor.
- (2) Margin Level = Measurement Value - Limit Value.

Test Mode: TX Mode Channel 39 \_2Mbps

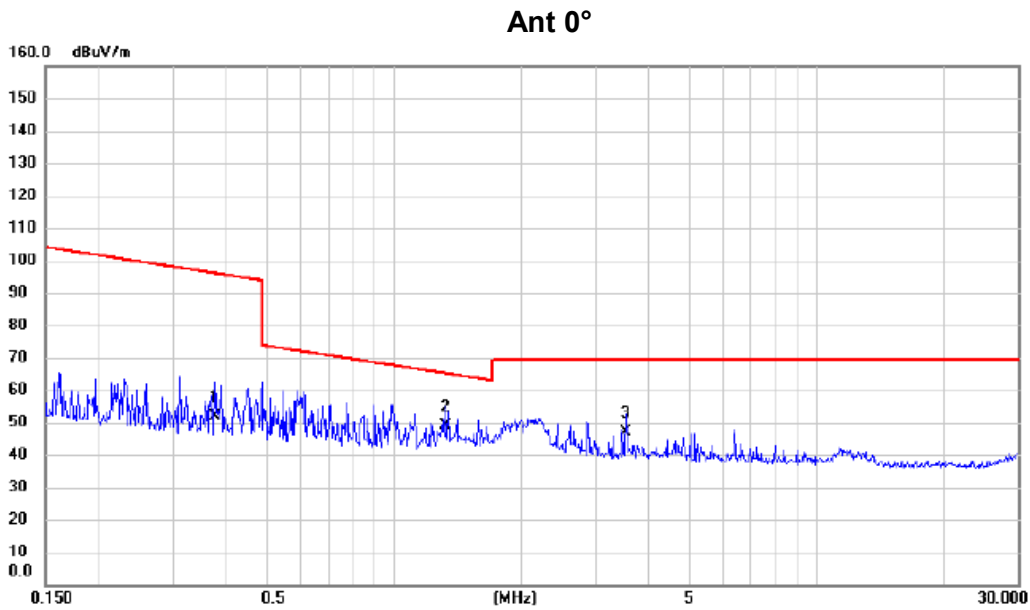

No.	Mk.	Freq. MHz	Reading Level dBuV	Correct Factor dB	Measure- ment dBuV/m	Limit dBuV/m	Margin dB	Detector	Comment
1		0.3771	38.60	13.35	51.95	96.08	-44.13	AVG	
2	*	1.3308	36.90	12.27	49.17	65.12	-15.95	QP	
3		3.5466	36.10	11.08	47.18	69.54	-22.36	QP	

**REMARKS:**

- (1) Measurement Value = Reading Level + Correct Factor.
- (2) Margin Level = Measurement Value - Limit Value.

Test Mode: TX Mode Channel 39 \_2Mbps

**Ant 90°**

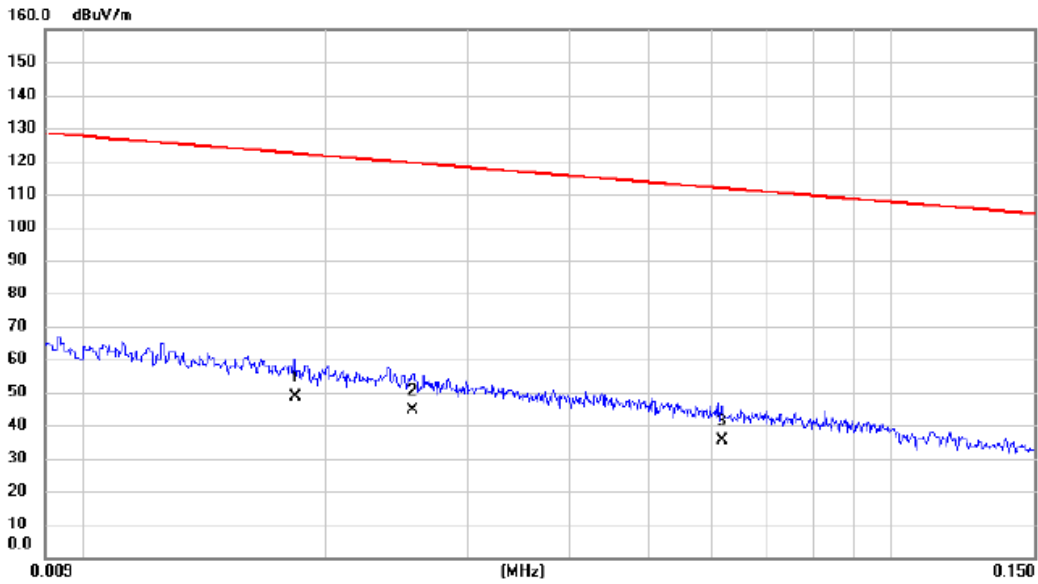

No.	Mk.	Freq. MHz	Reading Level dBuV	Correct Factor dB	Measure- ment dBuV/m	Limit dBuV/m	Margin dB	Detector	Comment
1	*	0.0183	34.20	14.33	48.53	122.36	-73.83	AVG	
2		0.0256	30.80	13.84	44.64	119.44	-74.80	AVG	
3		0.0618	21.50	13.74	35.24	111.79	-76.55	AVG	

**REMARKS:**

- (1) Measurement Value = Reading Level + Correct Factor.
- (2) Margin Level = Measurement Value - Limit Value.

Test Mode: TX Mode Channel 39 \_2Mbps

**Ant 90°**

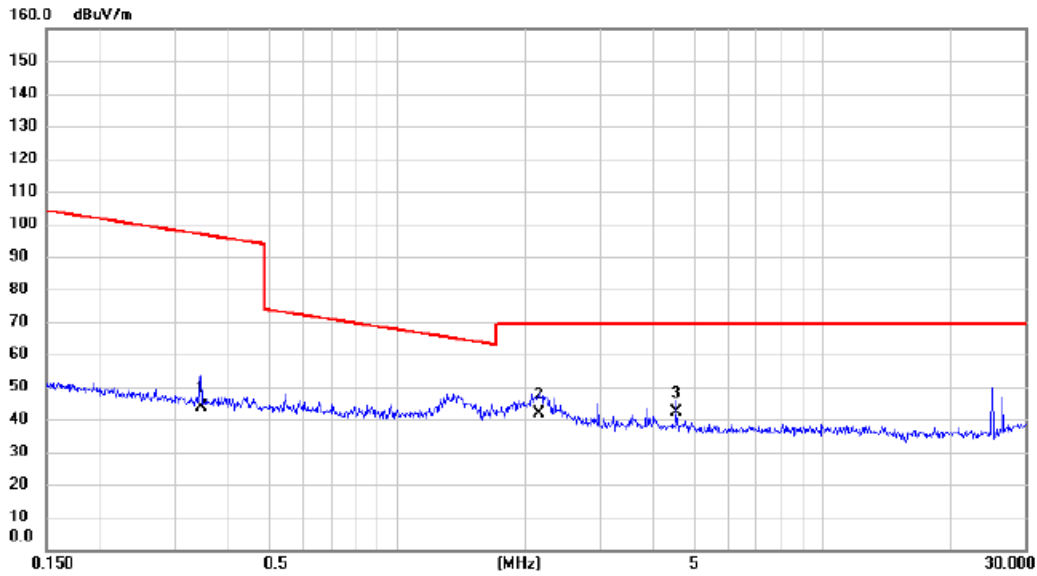

No. Mk.	Freq. MHz	Reading Level dBuV	Correct Factor dB	Measure- ment dBuV/m	Limit dBuV/m	Margin dB	Detector	Comment
1	0.3465	30.50	13.43	43.93	96.81	-52.88	AVG	
2	2.1552	30.20	11.73	41.93	69.54	-27.61	QP	
3 *	4.5254	31.40	10.90	42.30	69.54	-27.24	QP	

**REMARKS:**

- (1) Measurement Value = Reading Level + Correct Factor.
- (2) Margin Level = Measurement Value - Limit Value.

## **APPENDIX C - RADIATED EMISSION - 30 MHZ TO 1000 MHZ**



Test Mode: TX Mode Channel 39 \_2Mbps

### Vertical

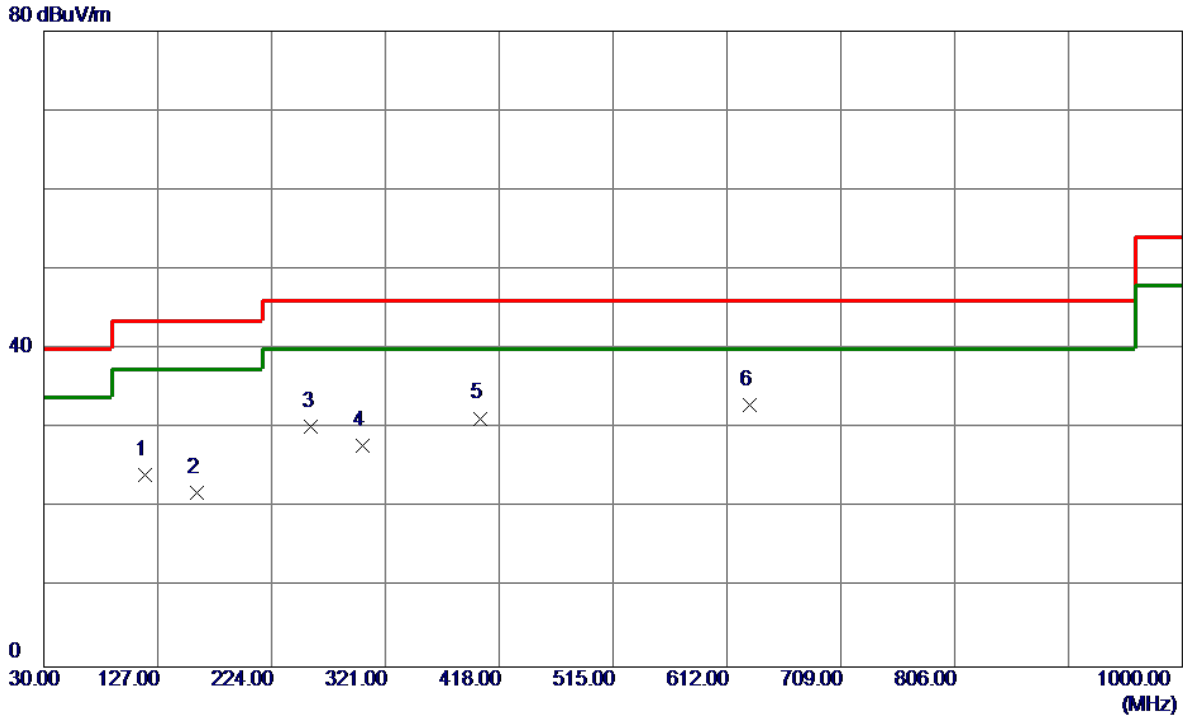

No.	Freq. MHz	Reading Level dBuV/m	Correct Factor dB	Measure ment dBuV/m	Limit dBuV/m	Margin dB	Detector	Comment
1	116.3300	37.73	-13.58	24.15	43.50	-19.35	Peak	
2	159.9800	32.98	-11.00	21.98	43.50	-21.52	Peak	
3	257.9500	43.05	-12.87	30.18	46.00	-15.82	Peak	
4	301.1150	39.37	-11.46	27.91	46.00	-18.09	Peak	
5	401.5100	40.70	-9.42	31.28	46.00	-14.72	Peak	
6 *	630.9150	37.99	-5.08	32.91	46.00	-13.09	Peak	

**REMARKS:**

- (1) Measurement Value = Reading Level + Correct Factor.
- (2) Margin Level = Measurement Value - Limit Value.

Test Mode: TX Mode Channel 39 \_2Mbps

### Horizontal

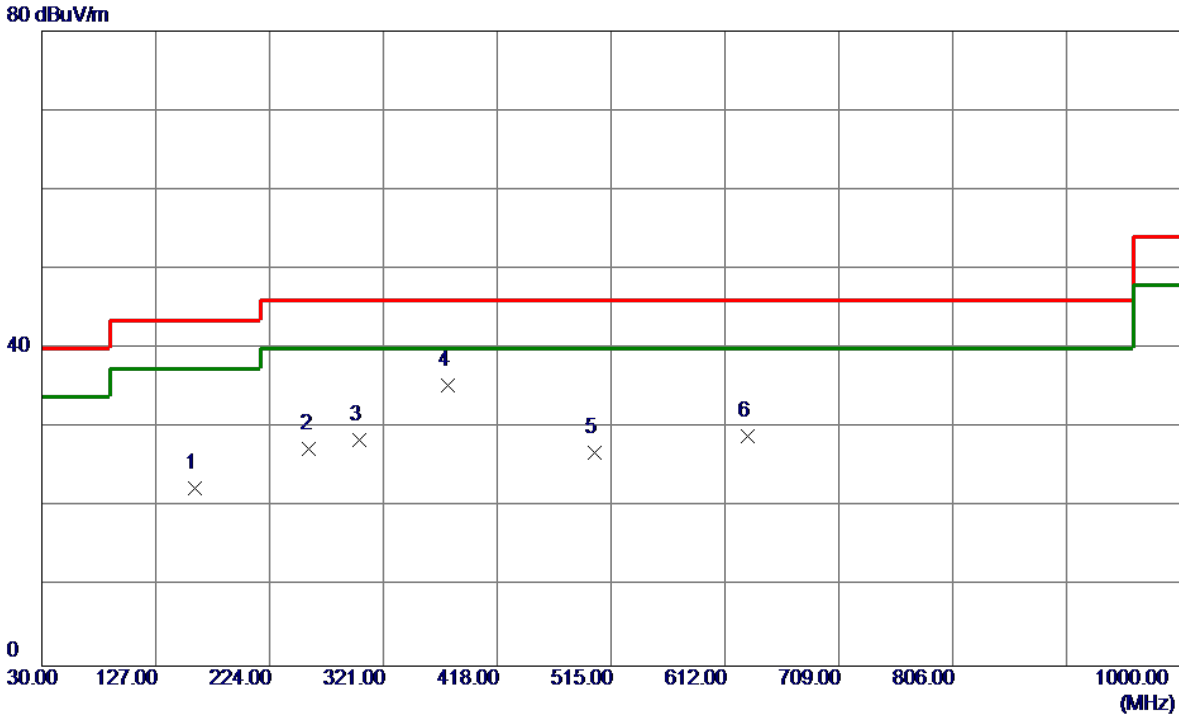

No.	Freq. MHz	Reading Level dBuV/m	Correct Factor dB	Measure ment dBuV/m	Limit dBuV/m	Margin dB	Detector	Comment
1	159.9800	33.38	-11.00	22.38	43.50	-21.12	Peak	
2	257.9500	40.30	-12.87	27.43	46.00	-18.57	Peak	
3	300.6300	40.02	-11.47	28.55	46.00	-17.45	Peak	
4 *	375.8050	45.37	-10.04	35.33	46.00	-10.67	Peak	
5	501.4200	34.59	-7.67	26.92	46.00	-19.08	Peak	
6	631.8850	33.97	-5.06	28.91	46.00	-17.09	Peak	

**REMARKS:**

- (1) Measurement Value = Reading Level + Correct Factor.
- (2) Margin Level = Measurement Value - Limit Value.

## **APPENDIX D - RADIATED EMISSION - ABOVE 1000 MHZ**

Test Mode : TX 2402 MHz \_CH00\_1Mbps

### Vertical

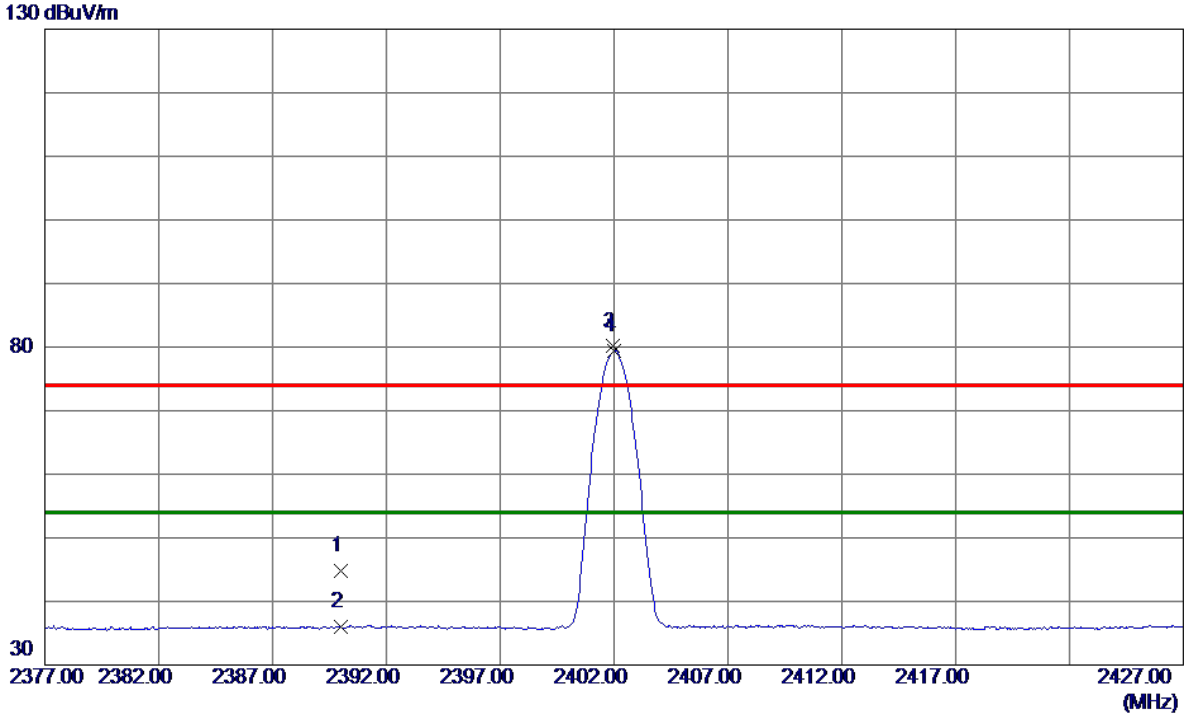

No.	Freq. MHz	Reading Level dBuV/m	Correct Factor dB	Measure ment dBuV/m	Limit dBuV/m	Margin dB	Detector	Comment
1	2390.0000	38.23	6.53	44.76	74.00	-29.24	Peak	
2	2390.0000	29.43	6.53	35.96	54.00	-18.04	AVG	
3	2401.9500	73.58	6.52	80.10	74.00	6.10	Peak	No Limit
4 *	2402.0250	72.91	6.52	79.43	54.00	25.43	AVG	No Limit

**REMARKS:**

(1) Measurement Value = Reading Level + Correct Factor.

(2) Margin Level = Measurement Value - Limit Value.

Test Mode : TX 2402 MHz \_CH00\_1Mbps

### Vertical

80 dBuV/m

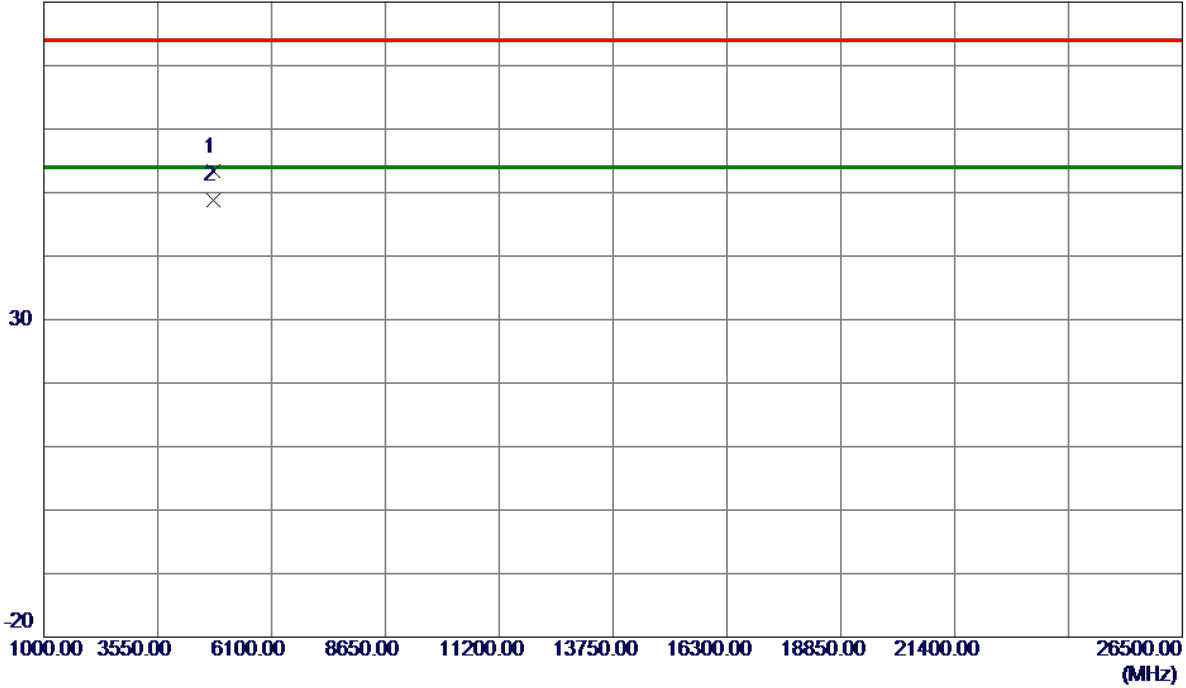

No.	Freq. MHz	Reading Level dBuV/m	Correct Factor dB	Measure ment dBuV/m	Limit dBuV/m	Margin dB	Detector	Comment
1	4803.4700	49.93	3.37	53.30	74.00	-20.70	Peak	
2 *	4803.8350	45.35	3.37	48.72	54.00	-5.28	AVG	

**REMARKS:**

- (1) Measurement Value = Reading Level + Correct Factor.
- (2) Margin Level = Measurement Value - Limit Value.

Test Mode : TX 2402 MHz \_CH00\_1Mbps

### Horizontal

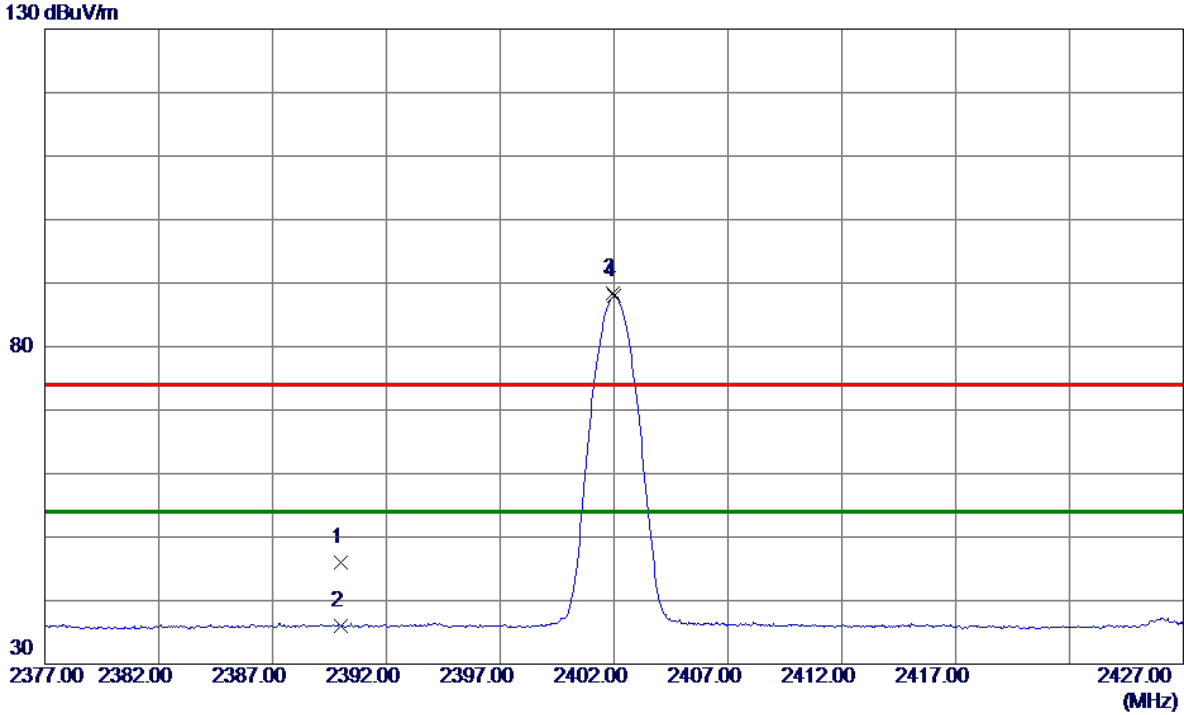

No.	Freq. MHz	Reading Level dBuV/m	Correct Factor dB	Measure ment dBuV/m	Limit dBuV/m	Margin dB	Detector	Comment
1	2390.0000	39.46	6.53	45.99	74.00	-28.01	Peak	
2	2390.0000	29.54	6.53	36.07	54.00	-17.93	AVG	
3	2401.9500	81.97	6.52	88.49	74.00	14.49	Peak	No Limit
4 *	2402.0250	81.39	6.52	87.91	54.00	33.91	AVG	No Limit

**REMARKS:**

- (1) Measurement Value = Reading Level + Correct Factor.
- (2) Margin Level = Measurement Value - Limit Value.

Test Mode : TX 2402 MHz \_CH00\_1Mbps

### Horizontal

80 dBuV/m

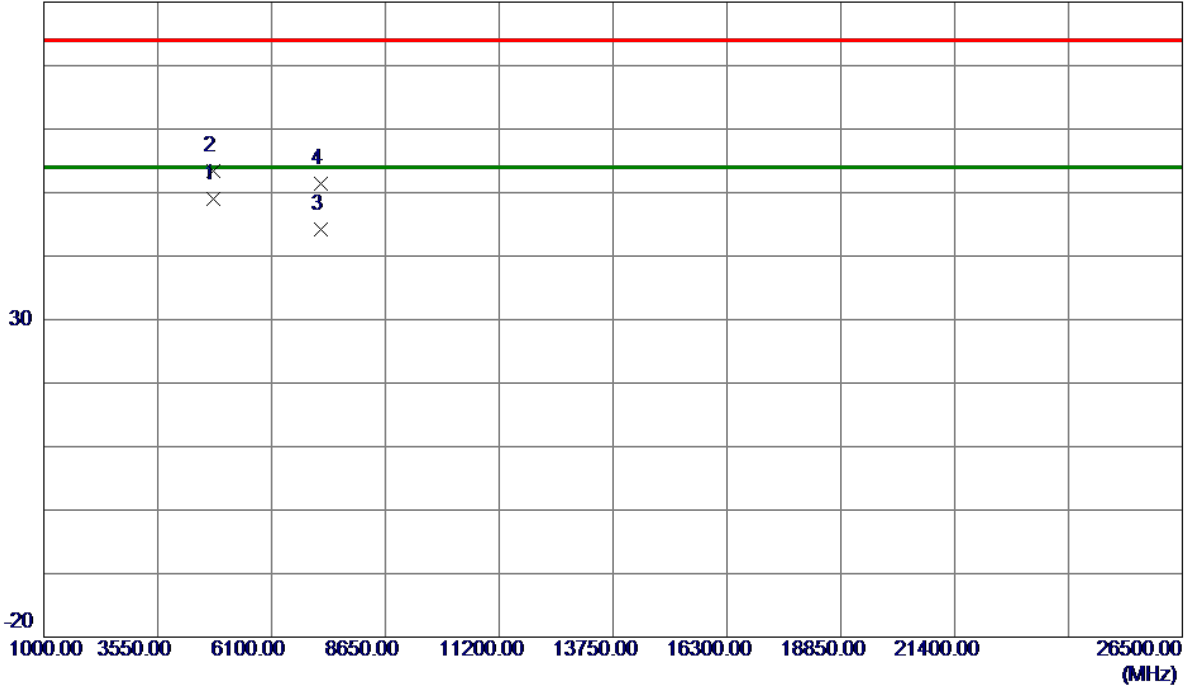

No.	Freq. MHz	Reading Level dBuV/m	Correct Factor dB	Measurement dBuV/m	Limit dBuV/m	Margin dB	Detector	Comment
1 *	4803.9100	45.63	3.37	49.00	54.00	-5.00	AVG	
2	4804.4950	50.11	3.37	53.48	74.00	-20.52	Peak	
3	7205.3450	35.13	9.07	44.20	54.00	-9.80	AVG	
4	7206.7620	42.31	9.08	51.39	74.00	-22.61	Peak	

**REMARKS:**

- (1) Measurement Value = Reading Level + Correct Factor.
- (2) Margin Level = Measurement Value - Limit Value.

Test Mode : TX 2440 MHz \_CH19\_1Mbps

### Vertical

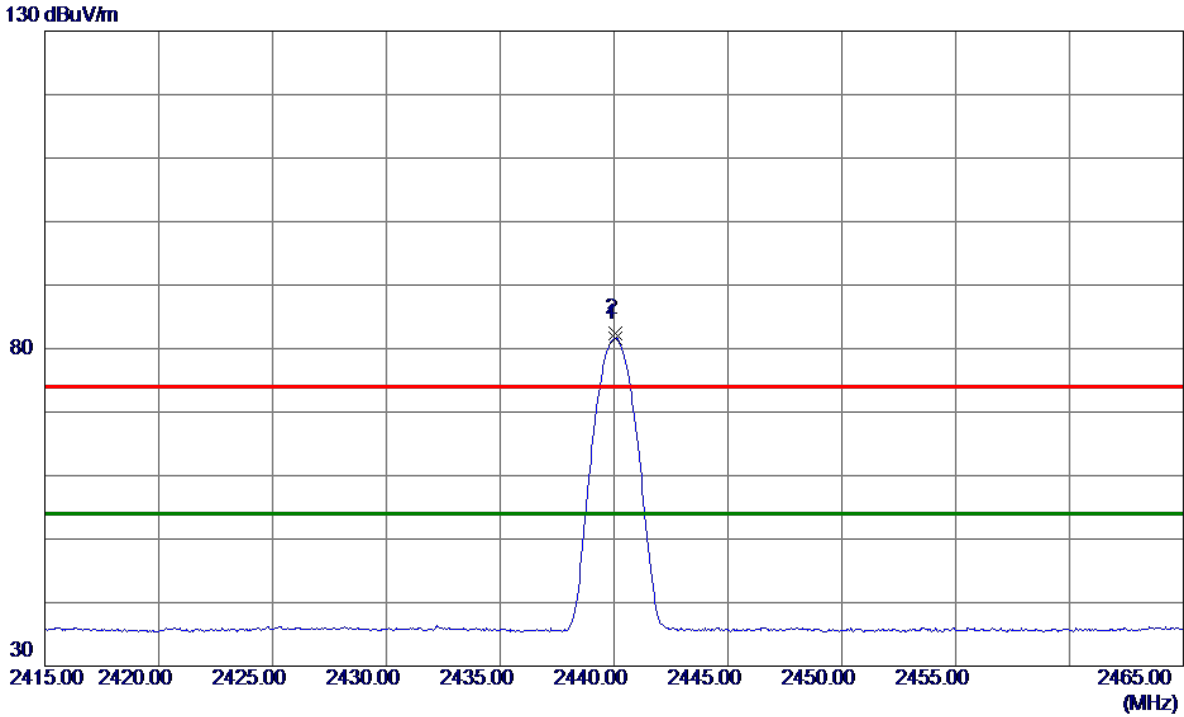

No.	Freq. MHz	Reading Level dBuV/m	Correct Factor dB	Measure ment dBuV/m	Limit dBuV/m	Margin dB	Detector	Comment
1 *	2440.0500	75.20	6.47	81.67	54.00	27.67	AVG	No Limit
2	2440.0750	76.01	6.47	82.48	74.00	8.48	Peak	No Limit

**REMARKS:**

- (1) Measurement Value = Reading Level + Correct Factor.
- (2) Margin Level = Measurement Value - Limit Value.



Test Mode : TX 2440 MHz \_CH19\_ 1Mbps

### Vertical

80 dBuV/m

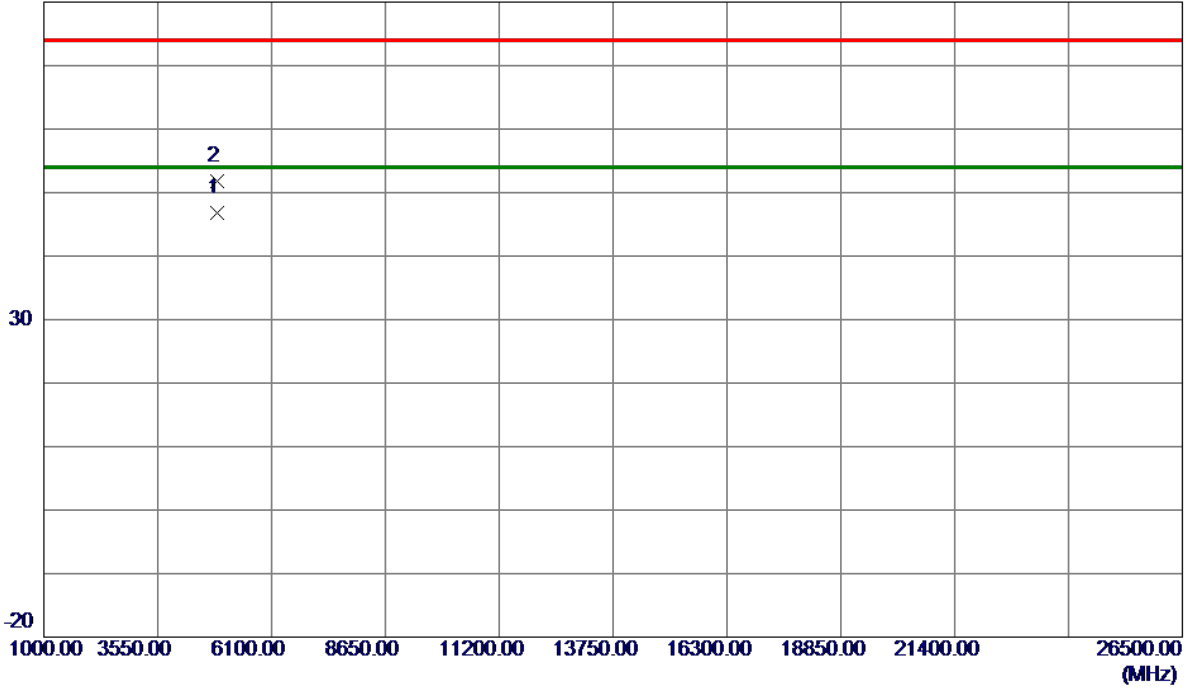

No.	Freq. MHz	Reading Level dBuV/m	Correct Factor dB	Measure ment dBuV/m	Limit dBuV/m	Margin dB	Detector	Comment
1 *	4879.9770	43.12	3.60	46.72	54.00	-7.28	AVG	
2	4880.5379	48.11	3.60	51.71	74.00	-22.29	Peak	

**REMARKS:**

- (1) Measurement Value = Reading Level + Correct Factor.
- (2) Margin Level = Measurement Value - Limit Value.

Test Mode : TX 2440 MHz \_CH19\_ 1Mbps

### Horizontal

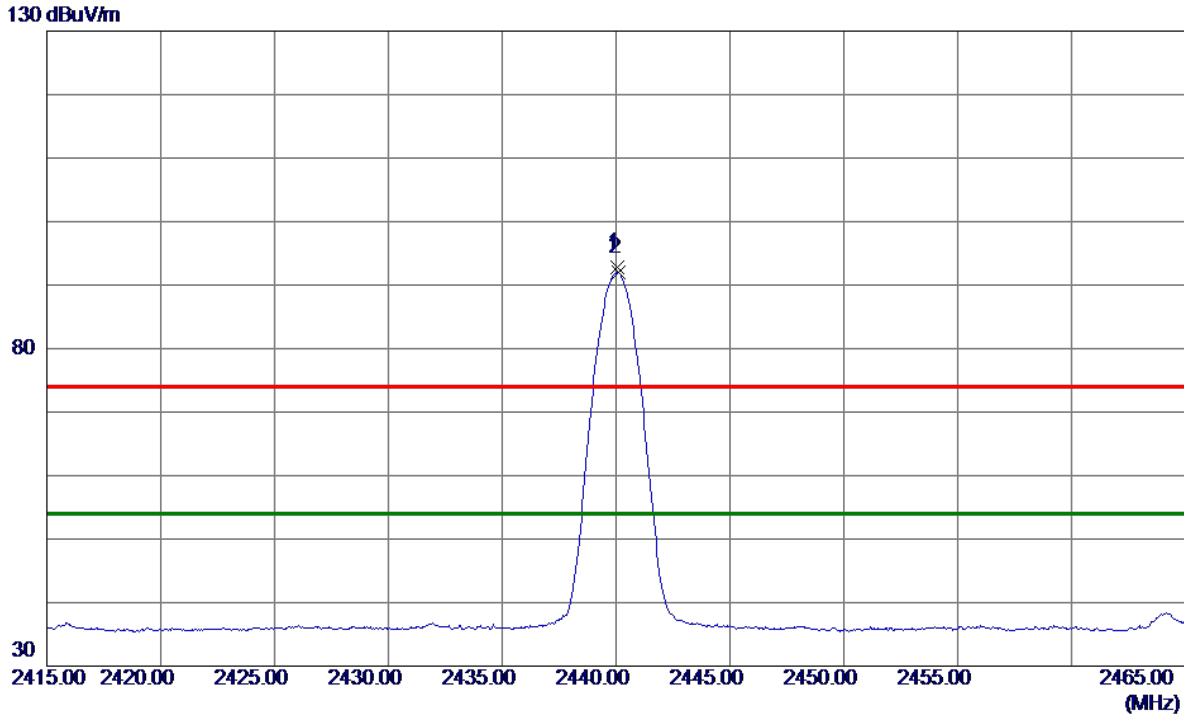

No.	Freq. MHz	Reading Level dBuV/m	Correct Factor dB	Measure ment dBuV/m	Limit dBuV/m	Margin dB	Detector	Comment
1	2440.0750	86.34	6.47	92.81	74.00	18.81	Peak	No Limit
2 *	2440.1000	85.53	6.47	92.00	54.00	38.00	AVG	No Limit

**REMARKS:**

- (1) Measurement Value = Reading Level + Correct Factor.
- (2) Margin Level = Measurement Value - Limit Value.

Test Mode : TX 2440 MHz \_CH19\_ 1Mbps

### Horizontal

80 dBuV/m

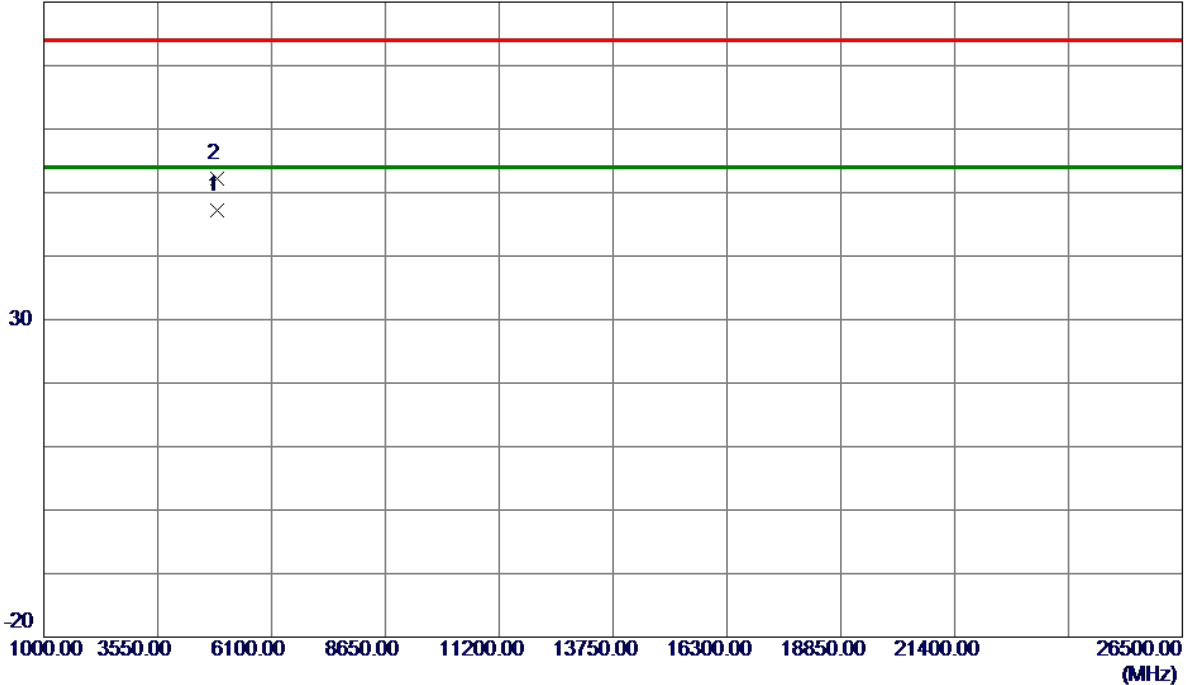

No.	Freq. MHz	Reading Level dBuV/m	Correct Factor dB	Measure ment dBuV/m	Limit dBuV/m	Margin dB	Detector	Comment
1 *	4879.9250	43.67	3.60	47.27	54.00	-6.73	AVG	
2	4880.4600	48.55	3.60	52.15	74.00	-21.85	Peak	

**REMARKS:**

- (1) Measurement Value = Reading Level + Correct Factor.
- (2) Margin Level = Measurement Value - Limit Value.

Test Mode : TX 2480 MHz \_CH39\_1Mbps

### Vertical

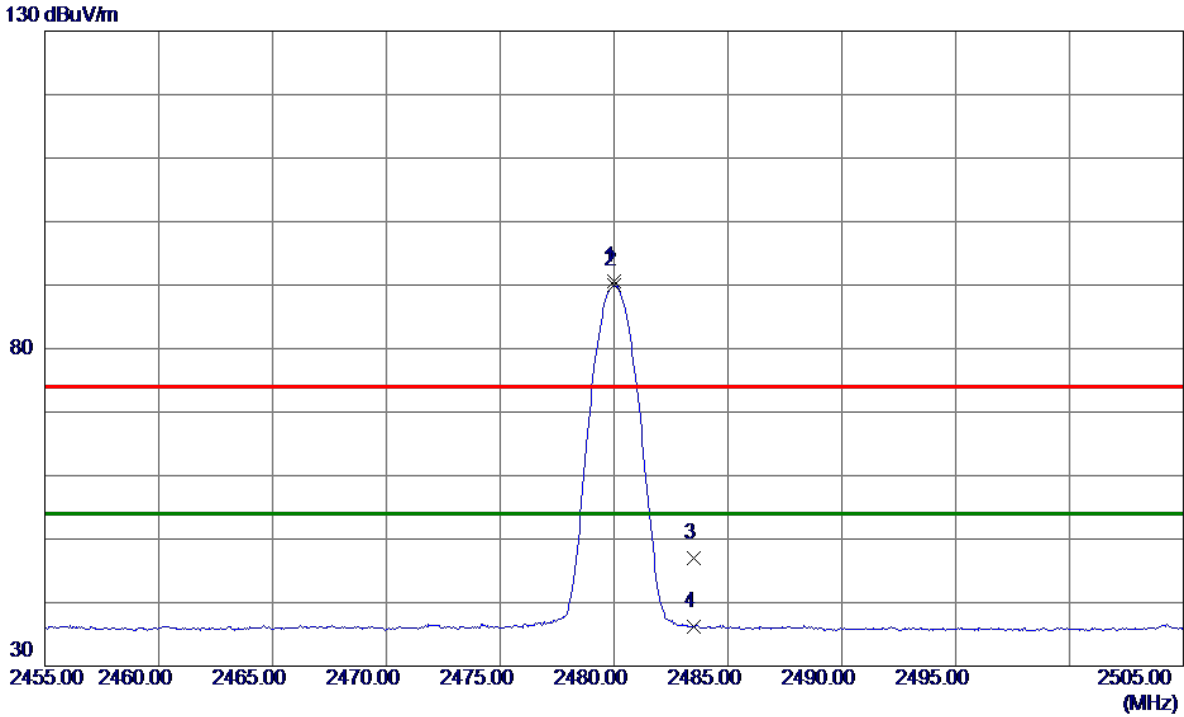

No.	Freq. MHz	Reading Level dBuV/m	Correct Factor dB	Measure ment dBuV/m	Limit dBuV/m	Margin dB	Detector	Comment
1	2479.9750	84.16	6.43	90.59	74.00	16.59	Peak	No Limit
2 *	2480.0250	83.48	6.43	89.91	54.00	35.91	AVG	No Limit
3	2483.5000	40.51	6.42	46.93	74.00	-27.07	Peak	
4	2483.5000	29.73	6.42	36.15	54.00	-17.85	AVG	

**REMARKS:**

- (1) Measurement Value = Reading Level + Correct Factor.
- (2) Margin Level = Measurement Value - Limit Value.

Test Mode : TX 2480 MHz \_CH39\_ 1Mbps

### Vertical

80 dBuV/m

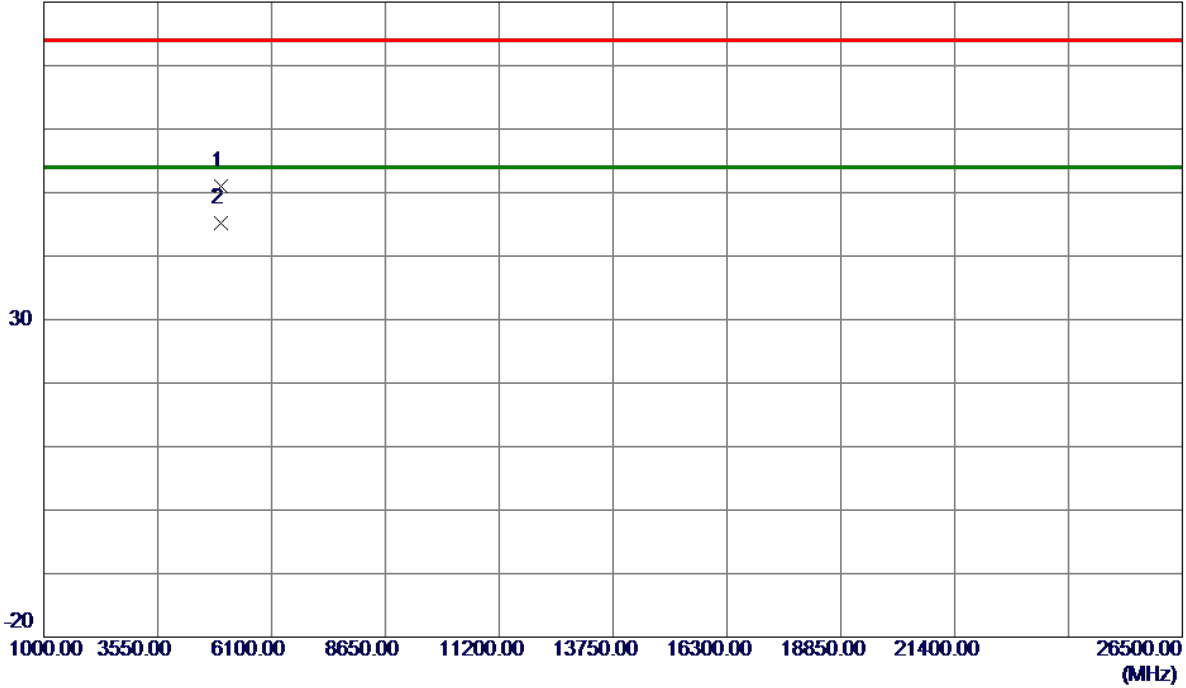

No.	Freq. MHz	Reading Level dBuV/m	Correct Factor dB	Measure ment dBuV/m	Limit dBuV/m	Margin dB	Detector	Comment
1	4959.5150	47.13	3.84	50.97	74.00	-23.03	Peak	
2 *	4959.9770	41.28	3.84	45.12	54.00	-8.88	AVG	

**REMARKS:**

- (1) Measurement Value = Reading Level + Correct Factor.
- (2) Margin Level = Measurement Value - Limit Value.

Test Mode : TX 2480 MHz \_CH39\_1Mbps

### Horizontal

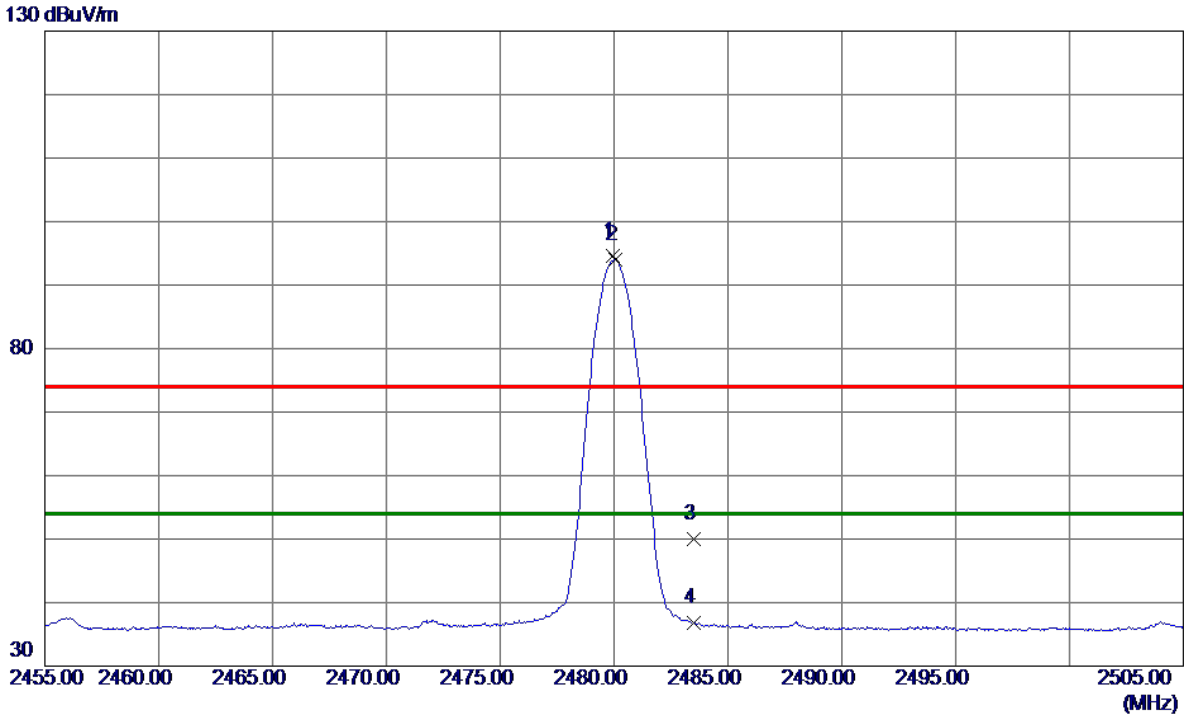

No.	Freq. MHz	Reading Level dBuV/m	Correct Factor dB	Measure ment dBuV/m	Limit dBuV/m	Margin dB	Detector	Comment
1	2479.9250	88.23	6.43	94.66	74.00	20.66	Peak	No Limit
2 *	2480.0500	87.56	6.43	93.99	54.00	39.99	AVG	No Limit
3	2483.5000	43.55	6.42	49.97	74.00	-24.03	Peak	
4	2483.5000	30.33	6.42	36.75	54.00	-17.25	AVG	

**REMARKS:**

- (1) Measurement Value = Reading Level + Correct Factor.
- (2) Margin Level = Measurement Value - Limit Value.

Test Mode : TX 2480 MHz \_CH39\_ 1Mbps

### Horizontal

80 dBuV/m

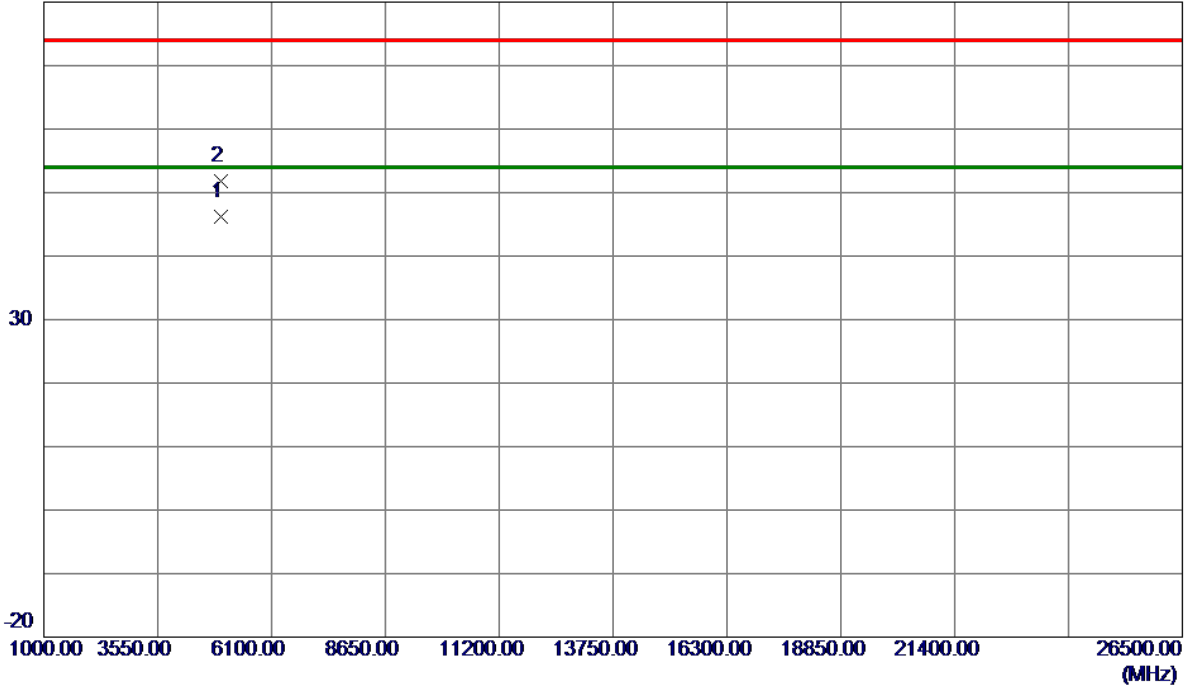

No.	Freq. MHz	Reading Level dBuV/m	Correct Factor dB	Measure ment dBuV/m	Limit dBuV/m	Margin dB	Detector	Comment
1 *	4960.1250	42.38	3.84	46.22	54.00	-7.78	AVG	
2	4960.4580	47.92	3.84	51.76	74.00	-22.24	Peak	

**REMARKS:**

- (1) Measurement Value = Reading Level + Correct Factor.
- (2) Margin Level = Measurement Value - Limit Value.

Test Mode : TX 2402 MHz \_CH00\_2Mbps

### Vertical

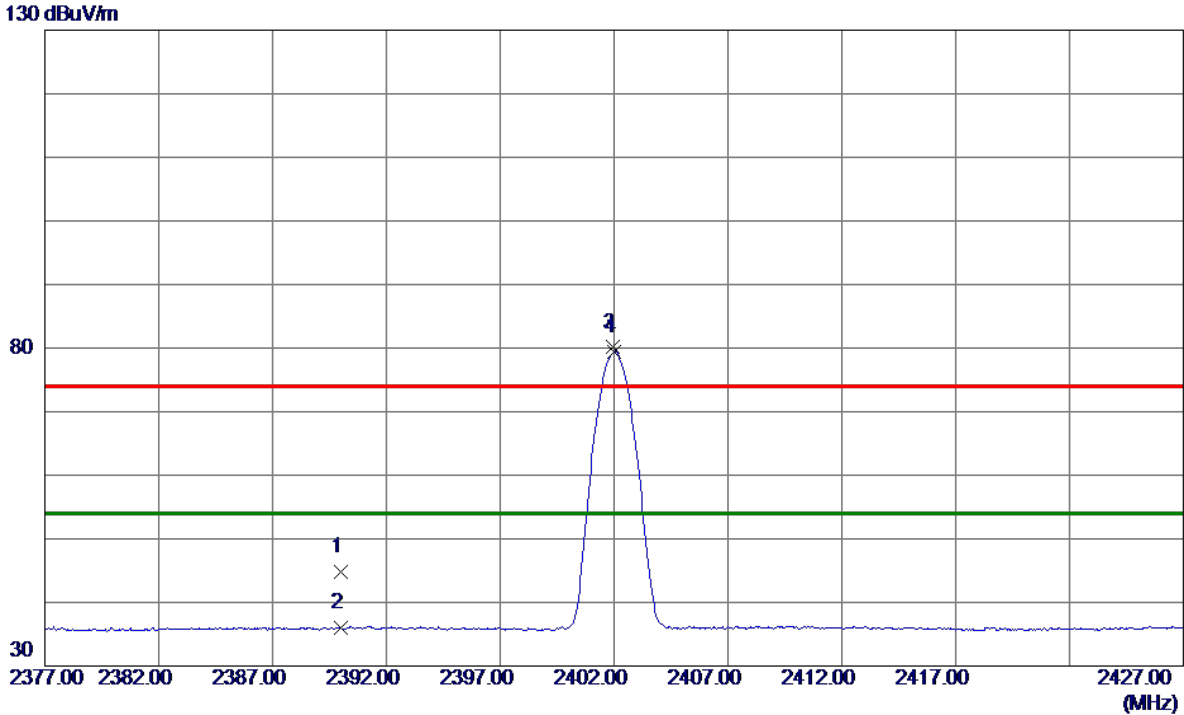

No.	Freq. MHz	Reading Level dBuV/m	Correct Factor dB	Measure ment dBuV/m	Limit dBuV/m	Margin dB	Detector	Comment
1	2390.0000	38.23	6.53	44.76	74.00	-29.24	Peak	
2	2390.0000	29.43	6.53	35.96	54.00	-18.04	AVG	
3	2401.9500	73.58	6.52	80.10	74.00	6.10	Peak	No Limit
4 *	2402.0250	72.91	6.52	79.43	54.00	25.43	AVG	No Limit

**REMARKS:**

(1) Measurement Value = Reading Level + Correct Factor.

(2) Margin Level = Measurement Value - Limit Value.



Test Mode : TX 2402 MHz \_CH00\_2Mbps

### Vertical

80 dBuV/m

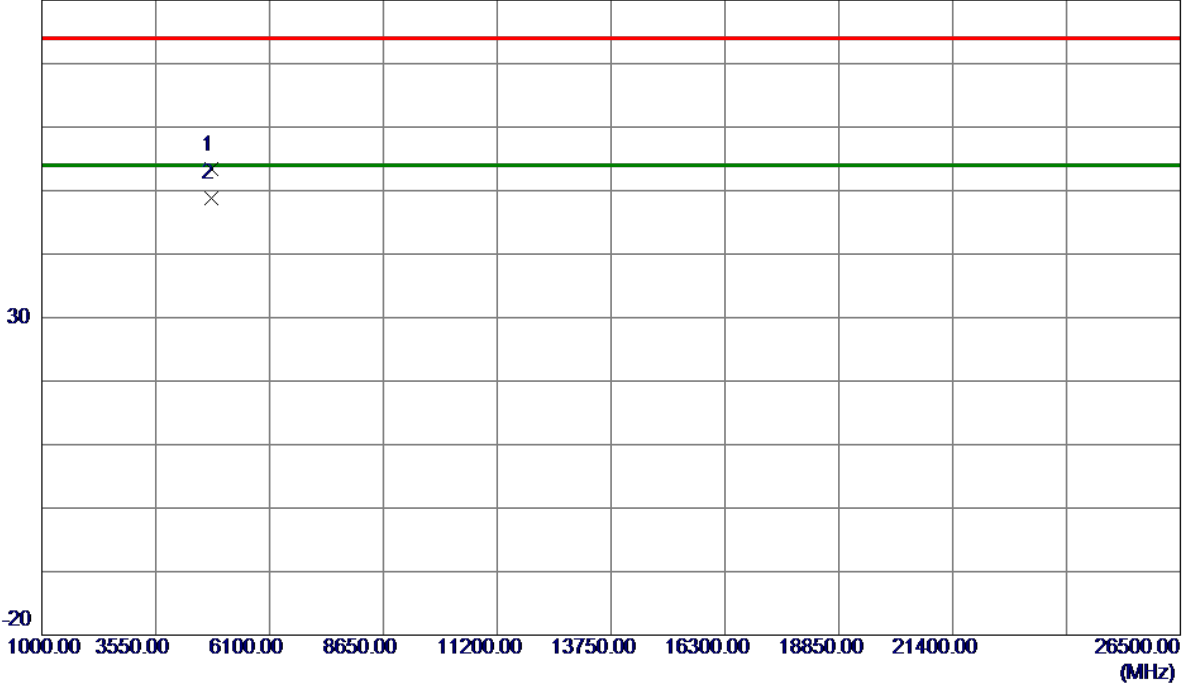

No.	Freq. MHz	Reading Level dBuV/m	Correct Factor dB	Measure ment dBuV/m	Limit dBuV/m	Margin dB	Detector	Comment
1	4803.4700	49.93	3.37	53.30	74.00	-20.70	Peak	
2 *	4803.8350	45.35	3.37	48.72	54.00	-5.28	AVG	

**REMARKS:**

- (1) Measurement Value = Reading Level + Correct Factor.
- (2) Margin Level = Measurement Value - Limit Value.

Test Mode : TX 2402 MHz \_CH00\_2Mbps

### Horizontal

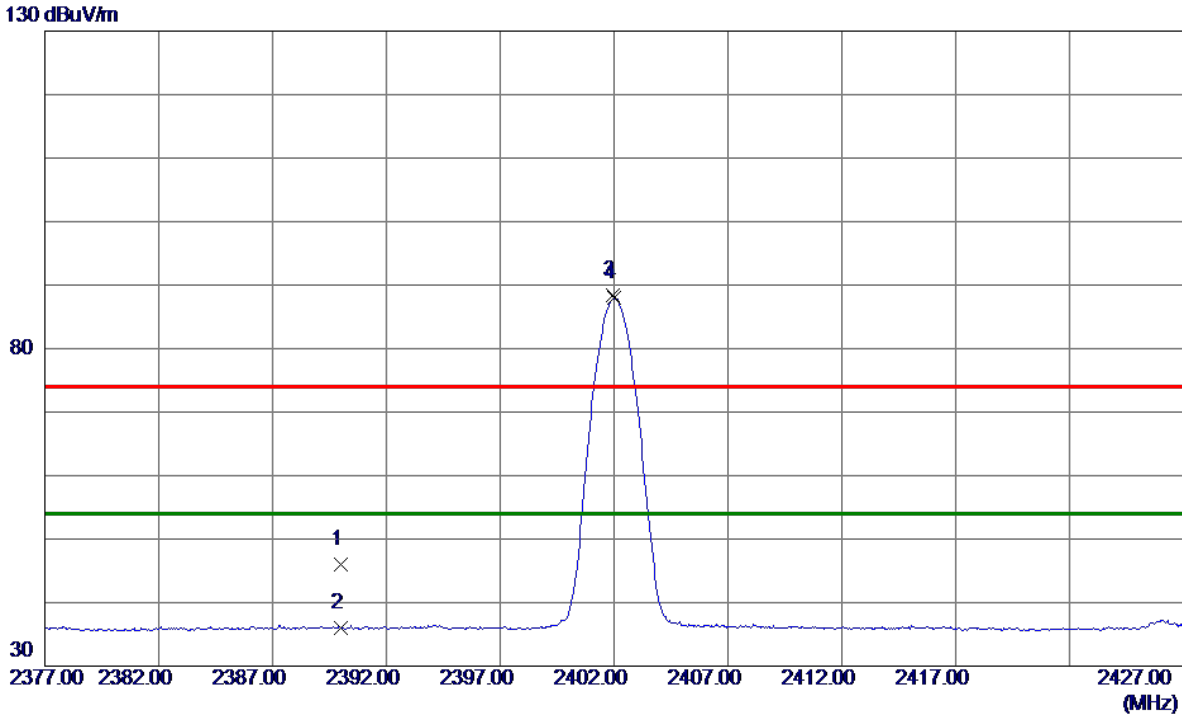

No.	Freq. MHz	Reading Level dBuV/m	Correct Factor dB	Measure ment dBuV/m	Limit dBuV/m	Margin dB	Detector	Comment
1	2390.0000	39.46	6.53	45.99	74.00	-28.01	Peak	
2	2390.0000	29.54	6.53	36.07	54.00	-17.93	AVG	
3	2401.9500	81.97	6.52	88.49	74.00	14.49	Peak	No Limit
4 *	2402.0250	81.39	6.52	87.91	54.00	33.91	AVG	No Limit

**REMARKS:**

- (1) Measurement Value = Reading Level + Correct Factor.
- (2) Margin Level = Measurement Value - Limit Value.

Test Mode : TX 2402 MHz \_CH00\_2Mbps

### Horizontal

80 dBuV/m

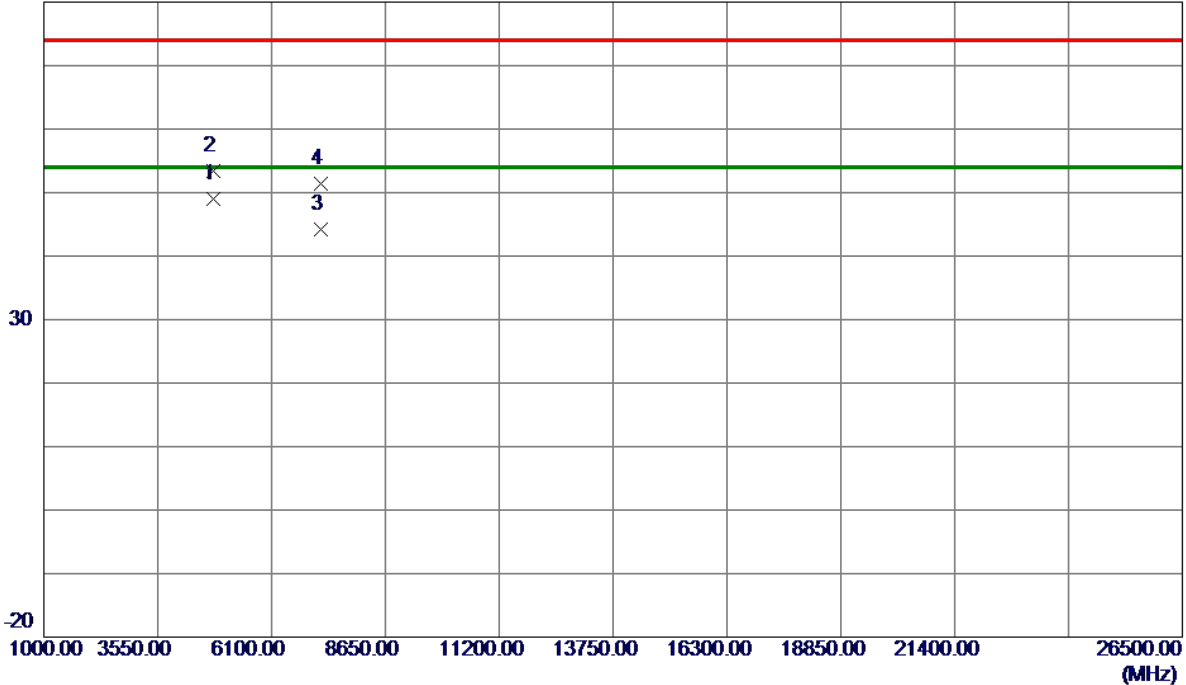

No.	Freq. MHz	Reading Level dBuV/m	Correct Factor dB	Measurement dBuV/m	Limit dBuV/m	Margin dB	Detector	Comment
1 *	4803.9100	45.63	3.37	49.00	54.00	-5.00	AVG	
2	4804.4950	50.11	3.37	53.48	74.00	-20.52	Peak	
3	7205.3450	35.13	9.07	44.20	54.00	-9.80	AVG	
4	7206.7620	42.31	9.08	51.39	74.00	-22.61	Peak	

**REMARKS:**

- (1) Measurement Value = Reading Level + Correct Factor.
- (2) Margin Level = Measurement Value - Limit Value.

Test Mode : TX 2440 MHz \_CH19\_2Mbps

### Vertical

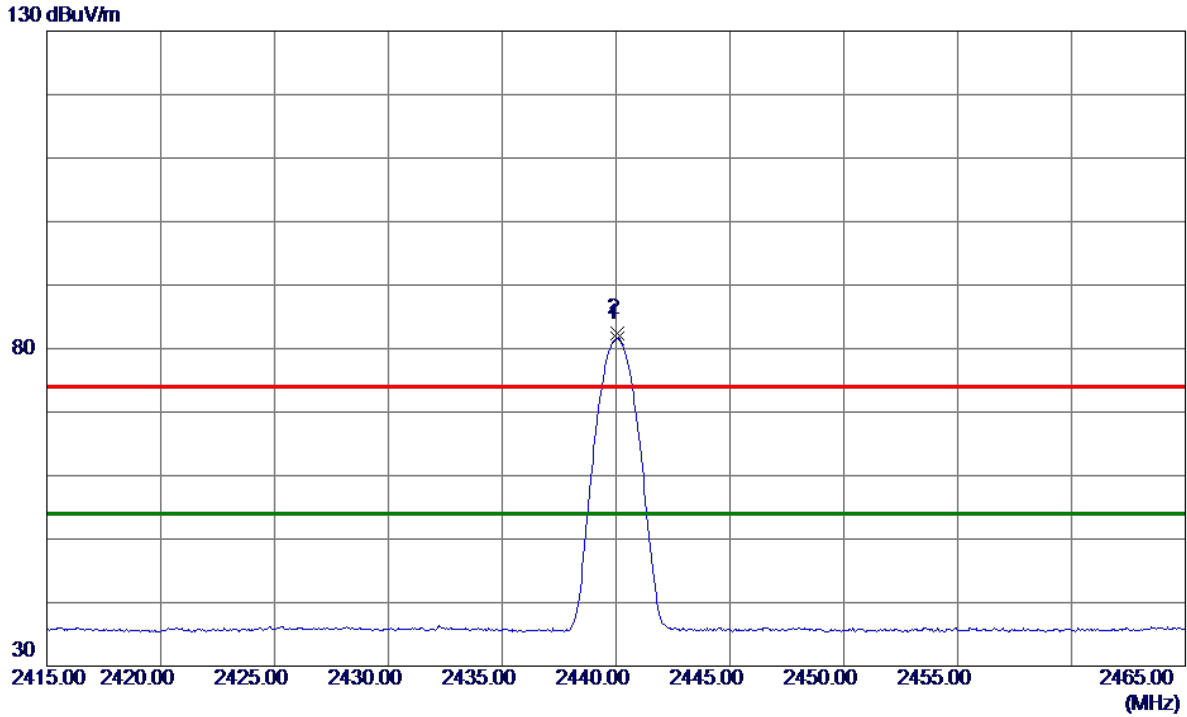

No.	Freq. MHz	Reading Level dBuV/m	Correct Factor dB	Measure ment dBuV/m	Limit dBuV/m	Margin dB	Detector	Comment
1 *	2440.0500	75.20	6.47	81.67	54.00	27.67	AVG	No Limit
2	2440.0750	76.01	6.47	82.48	74.00	8.48	Peak	No Limit

**REMARKS:**

- (1) Measurement Value = Reading Level + Correct Factor.
- (2) Margin Level = Measurement Value - Limit Value.

Test Mode : TX 2440 MHz \_CH19\_ 2Mbps

### Vertical

80 dBuV/m

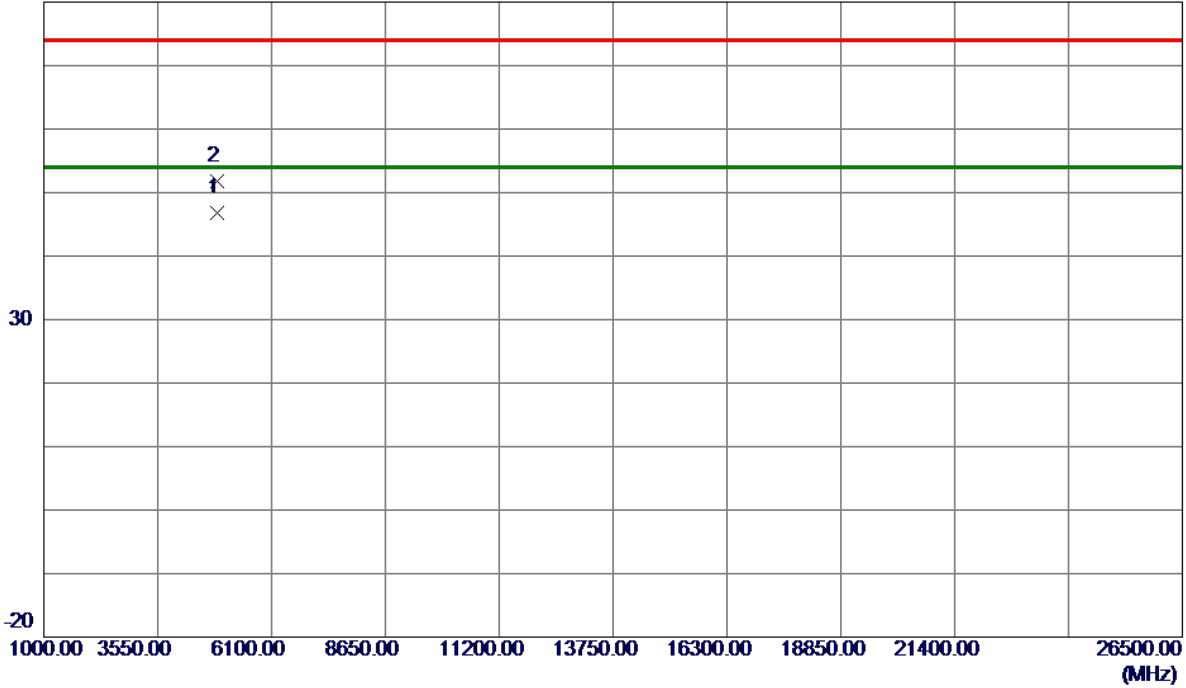

No.	Freq. MHz	Reading Level dBuV/m	Correct Factor dB	Measure ment dBuV/m	Limit dBuV/m	Margin dB	Detector	Comment
1 *	4879.9770	43.12	3.60	46.72	54.00	-7.28	AVG	
2	4880.5379	48.11	3.60	51.71	74.00	-22.29	Peak	

**REMARKS:**

- (1) Measurement Value = Reading Level + Correct Factor.
- (2) Margin Level = Measurement Value - Limit Value.

Test Mode : TX 2440 MHz \_CH19\_ 2Mbps

### Horizontal

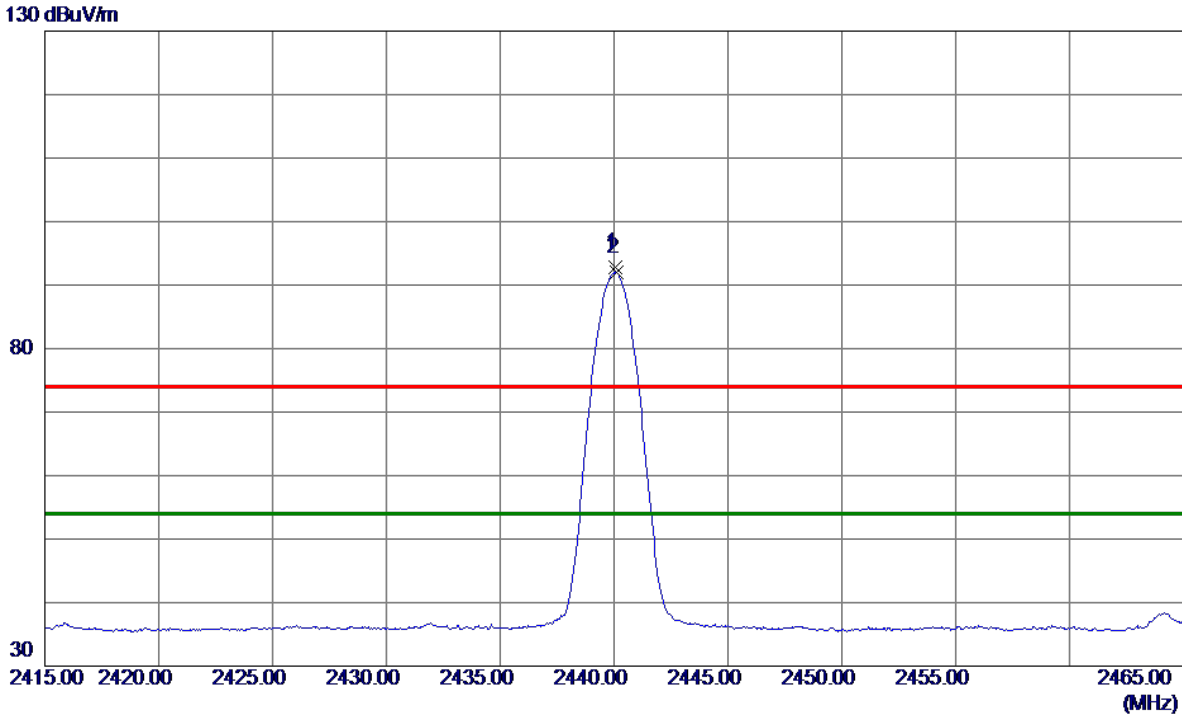

No.	Freq. MHz	Reading Level dBuV/m	Correct Factor dB	Measure ment dBuV/m	Limit dBuV/m	Margin dB	Detector	Comment
1	2440.0750	86.34	6.47	92.81	74.00	18.81	Peak	No Limit
2 *	2440.1000	85.53	6.47	92.00	54.00	38.00	AVG	No Limit

**REMARKS:**

- (1) Measurement Value = Reading Level + Correct Factor.
- (2) Margin Level = Measurement Value - Limit Value.

Test Mode : TX 2440 MHz \_CH19\_ 2Mbps

### Horizontal

80 dBuV/m

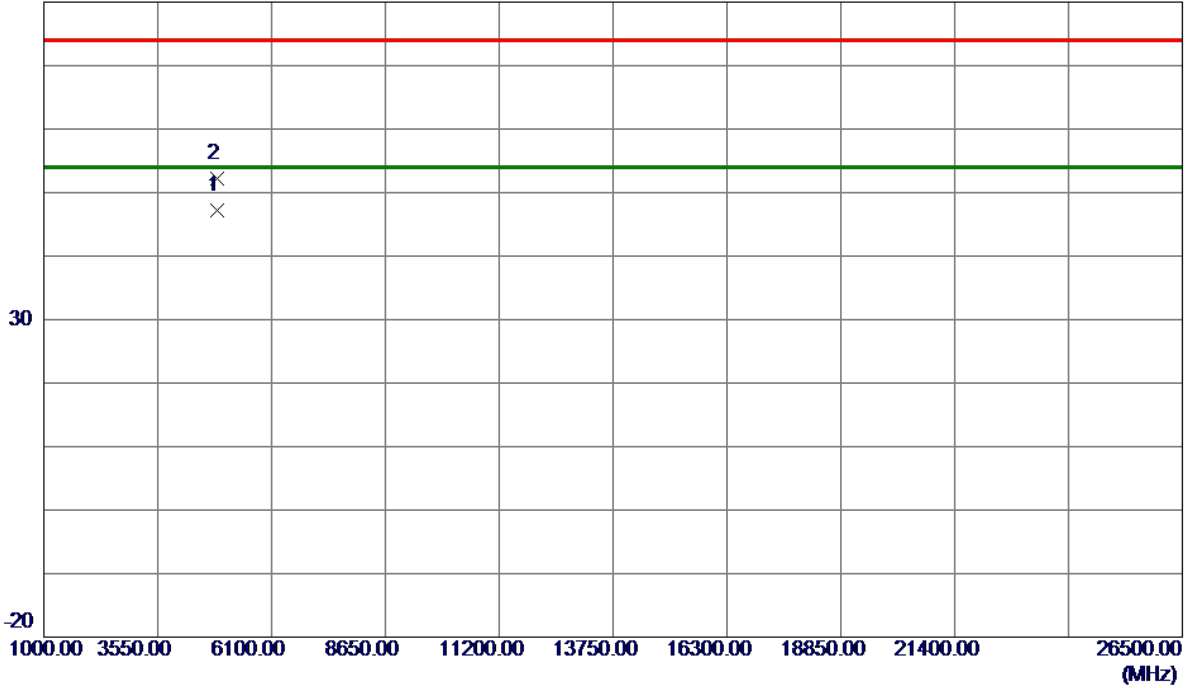

No.	Freq. MHz	Reading Level dBuV/m	Correct Factor dB	Measure ment dBuV/m	Limit dBuV/m	Margin dB	Detector	Comment
1 *	4879.9250	43.67	3.60	47.27	54.00	-6.73	AVG	
2	4880.4600	48.55	3.60	52.15	74.00	-21.85	Peak	

**REMARKS:**

- (1) Measurement Value = Reading Level + Correct Factor.
- (2) Margin Level = Measurement Value - Limit Value.

Test Mode : TX 2480 MHz \_CH39\_2Mbps

### Vertical

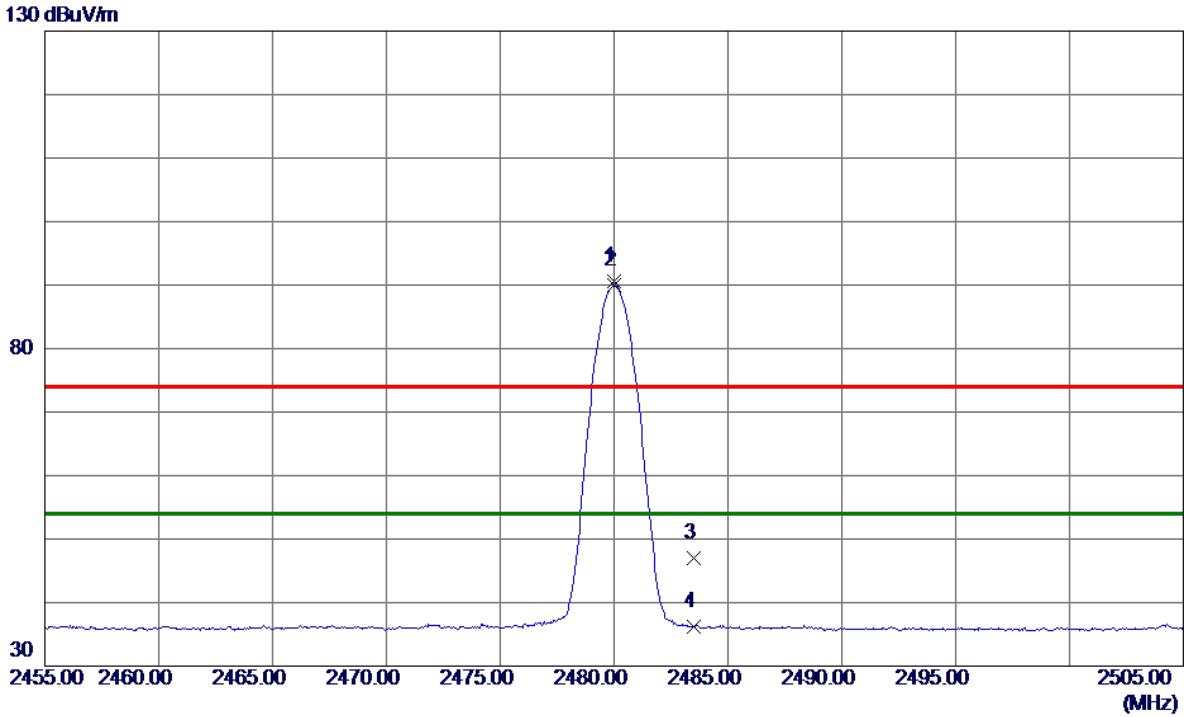

No.	Freq. MHz	Reading Level dBuV/m	Correct Factor dB	Measure ment dBuV/m	Limit dBuV/m	Margin dB	Detector	Comment
1	2479.9750	84.16	6.43	90.59	74.00	16.59	Peak	No Limit
2 *	2480.0250	83.48	6.43	89.91	54.00	35.91	AVG	No Limit
3	2483.5000	40.51	6.42	46.93	74.00	-27.07	Peak	
4	2483.5000	29.73	6.42	36.15	54.00	-17.85	AVG	

**REMARKS:**

- (1) Measurement Value = Reading Level + Correct Factor.
- (2) Margin Level = Measurement Value - Limit Value.



Test Mode : TX 2480 MHz \_CH39\_2Mbps

### Vertical

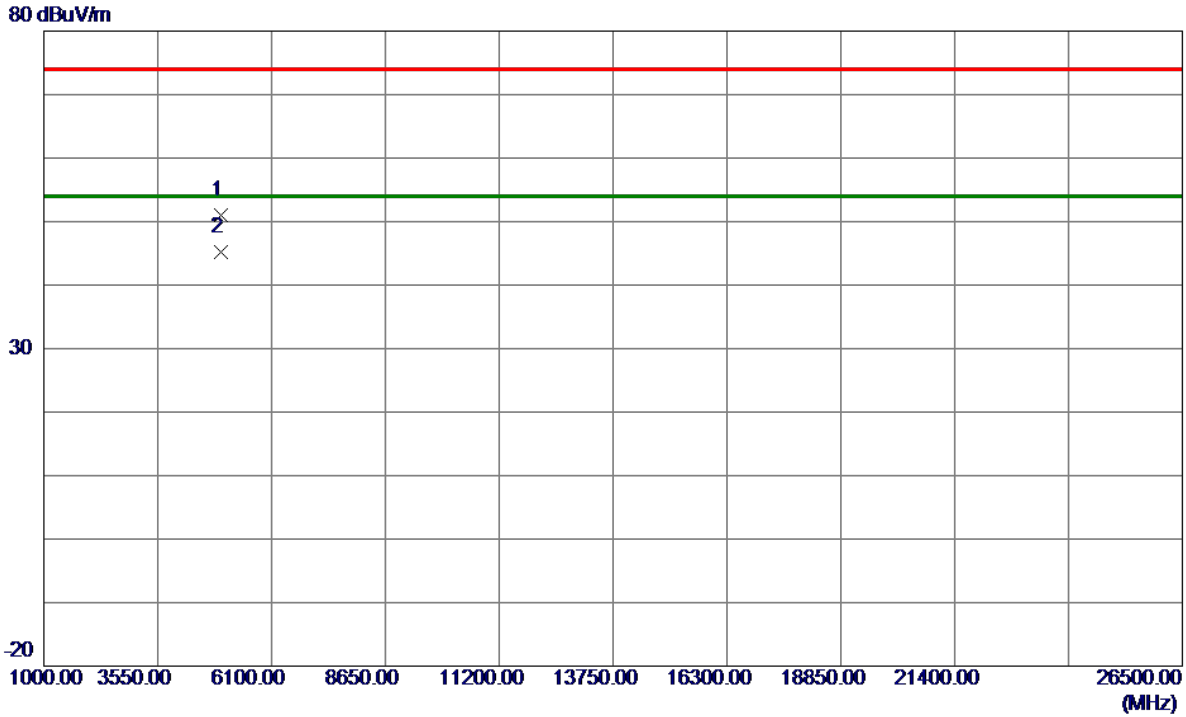

No.	Freq. MHz	Reading Level dBuV/m	Correct Factor dB	Measure ment dBuV/m	Limit dBuV/m	Margin dB	Detector	Comment
1	4959.5150	47.13	3.84	50.97	74.00	-23.03	Peak	
2 *	4959.9770	41.28	3.84	45.12	54.00	-8.88	AVG	

REMARKS:  
 (1) Measurement Value = Reading Level + Correct Factor.  
 (2) Margin Level = Measurement Value - Limit Value.

Test Mode : TX 2480 MHz \_CH39\_2Mbps

### Horizontal

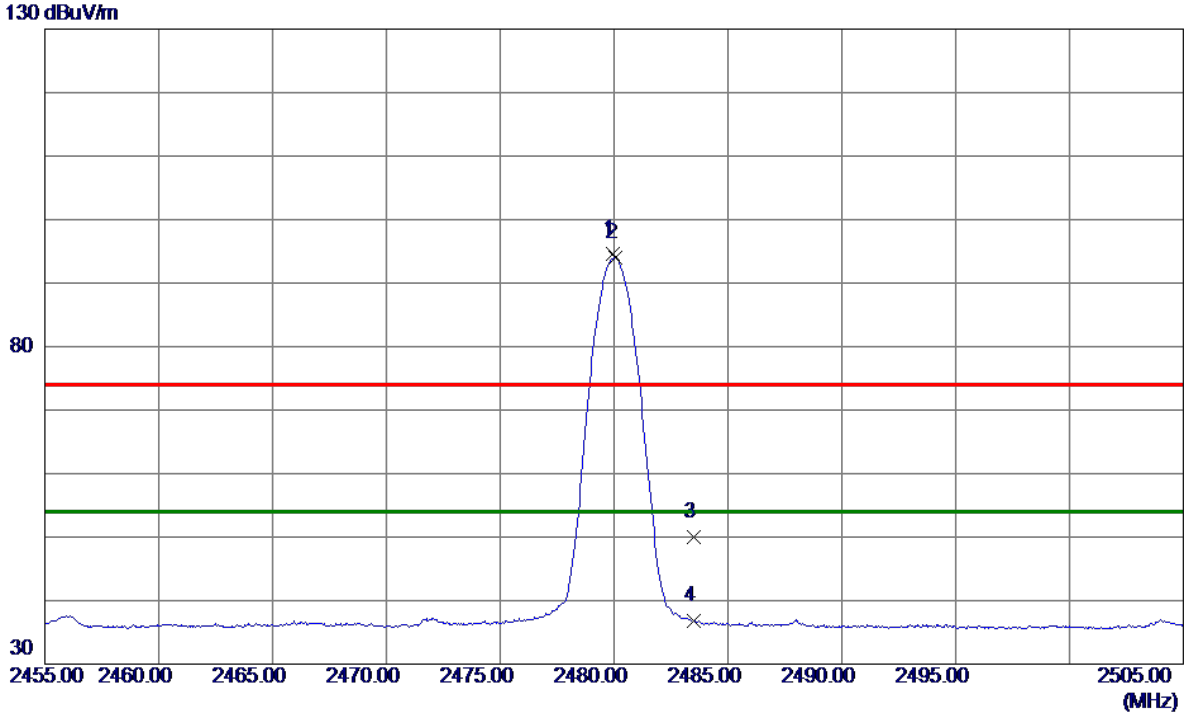

No.	Freq. MHz	Reading Level dBuV/m	Correct Factor dB	Measure ment dBuV/m	Limit dBuV/m	Margin dB	Detector	Comment
1	2479.9250	88.23	6.43	94.66	74.00	20.66	Peak	No Limit
2 *	2480.0500	87.56	6.43	93.99	54.00	39.99	AVG	No Limit
3	2483.5000	43.55	6.42	49.97	74.00	-24.03	Peak	
4	2483.5000	30.33	6.42	36.75	54.00	-17.25	AVG	

**REMARKS:**

- (1) Measurement Value = Reading Level + Correct Factor.
- (2) Margin Level = Measurement Value - Limit Value.

Test Mode : TX 2480 MHz \_CH39\_2Mbps

### Horizontal

80 dBuV/m

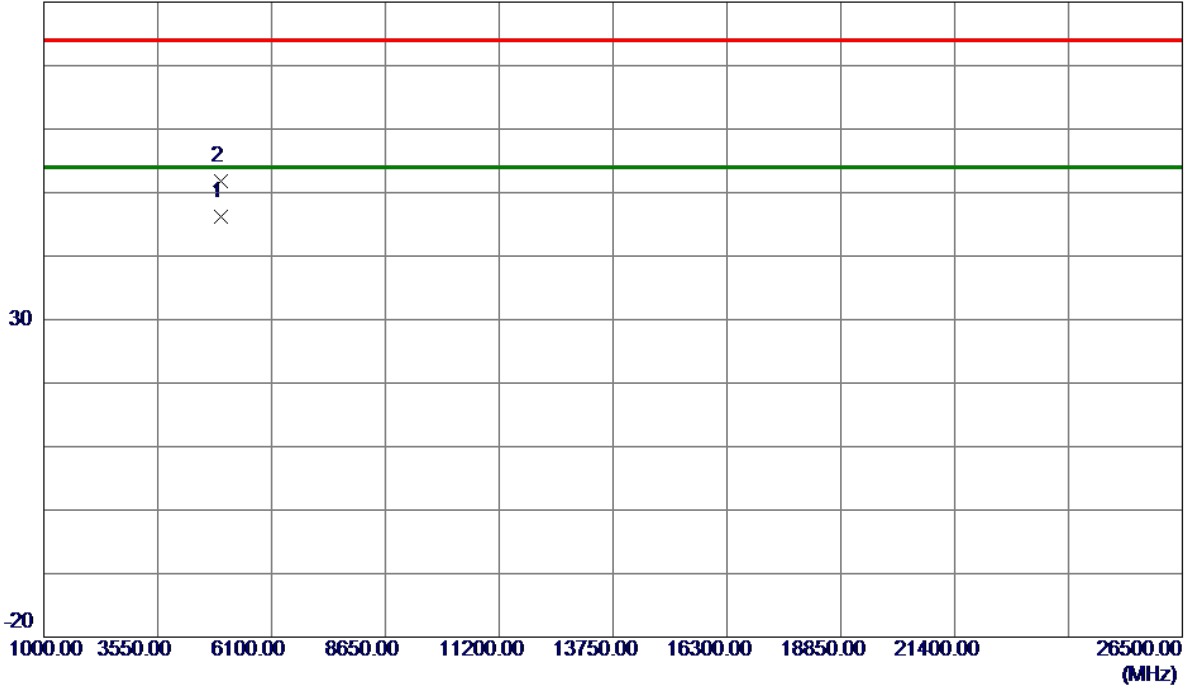

No.	Freq. MHz	Reading Level dBuV/m	Correct Factor dB	Measure ment dBuV/m	Limit dBuV/m	Margin dB	Detector	Comment
1 *	4960.1250	42.38	3.84	46.22	54.00	-7.78	AVG	
2	4960.4580	47.92	3.84	51.76	74.00	-22.24	Peak	

**REMARKS:**

- (1) Measurement Value = Reading Level + Correct Factor.
- (2) Margin Level = Measurement Value - Limit Value.

## APPENDIX E - BANDWIDTH

Test Mode: CH00, CH19, CH39 - 1Mbps

Channel	Frequency (MHz)	6 dB Bandwidth (MHz)	99 % Emission Bandwidth (MHz)	6 dB Bandwidth Min. Limit (kHz)	Test Result
00	2402	0.691	1.072	500	Pass
19	2440	0.698	1.072	500	Pass
39	2480	0.714	1.076	500	Pass

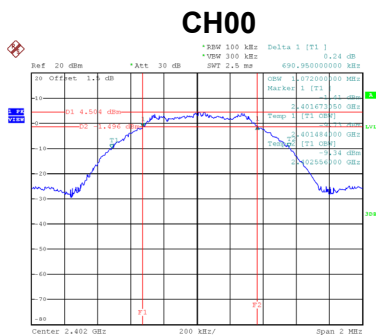

Date: 18\_JUL\_2019 21:59:49

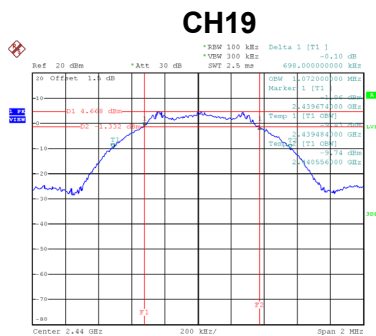

Date: 18\_JUL\_2019 22:01:13

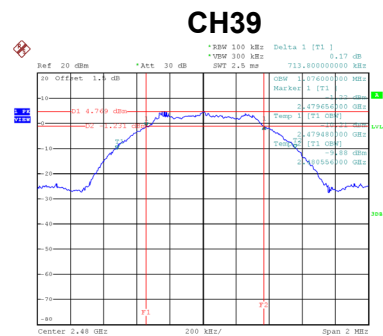

Date: 18\_JUL\_2019 22:02:48

Test Mode: CH00, CH19, CH39 - 2Mbps

Channel	Frequency (MHz)	6 dB Bandwidth (MHz)	99 % Emission Bandwidth (MHz)	6 dB Bandwidth Min. Limit (kHz)	Test Result
00	2402	1.152	2.080	500	Pass
19	2440	1.208	2.080	500	Pass
39	2480	1.200	2.112	500	Pass

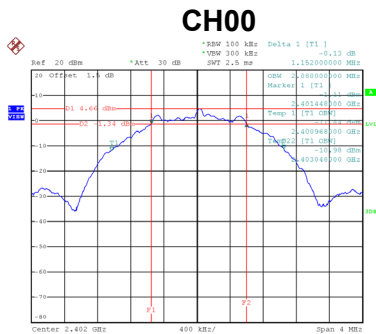

Date: 18\_JUL\_2019 22:14:34

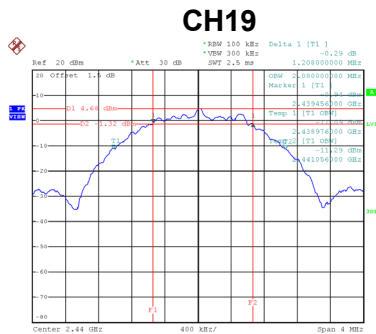

Date: 18\_JUL\_2019 22:16:51

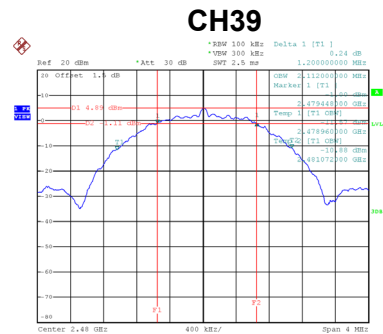

Date: 18\_JUL\_2019 22:18:48

## APPENDIX F - MAXIMUM OUTPUT POWER

Test Mode :	CH00, CH19 , CH39 - 1Mbps
-------------	---------------------------

Frequency (MHz)	Output Power (dBm)	Output Power (W)	Max. Limit (dBm)	Max. Limit (W)	Test Result
2402	4.97	0.0031	30.00	1.00	Pass
2440	4.99	0.0032	30.00	1.00	Pass
2480	5.17	0.0033	30.00	1.00	Pass

Test Mode :	CH00, CH19 , CH39 - 2Mbps
-------------	---------------------------

Frequency (MHz)	Output Power (dBm)	Output Power (W)	Max. Limit (dBm)	Max. Limit (W)	Test Result
2402	4.98	0.0031	30.00	1.00	Pass
2440	5.03	0.0032	30.00	1.00	Pass
2480	5.17	0.0033	30.00	1.00	Pass

## **APPENDIX G - CONDUCTED SPURIOUS EMISSION**



Test Mode : CH00, CH19 , CH39 - 1Mbps

### Bandedge- CH00 (Lower)

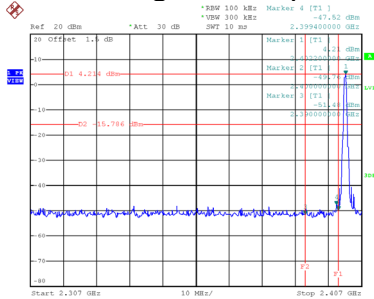

Date: 18\_JUL.2019 21:59:57

### Bandedge CH39 (Upper)

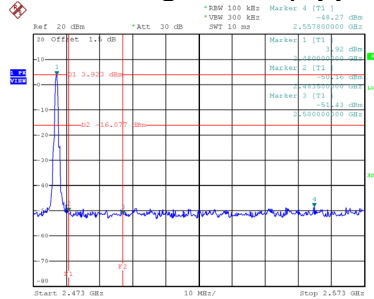

Date: 18\_JUL.2019 22:02:56

### CH00 – 10th Harmonic of the fundamental frequency

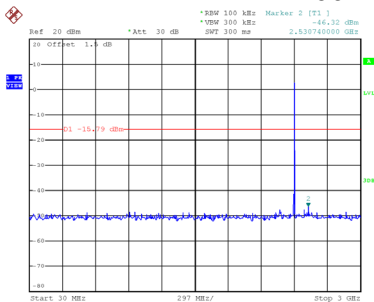

Date: 18\_JUL.2019 22:00:11

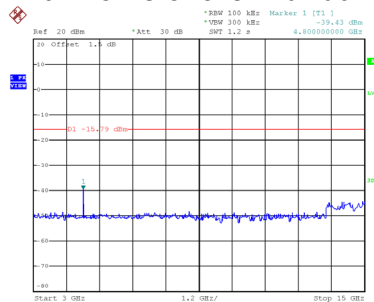

Date: 18\_JUL.2019 22:00:18

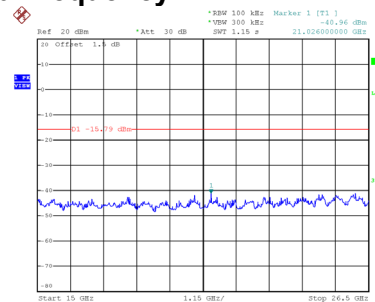

Date: 18\_JUL.2019 22:00:26

### CH19 – 10th Harmonic of the fundamental frequency

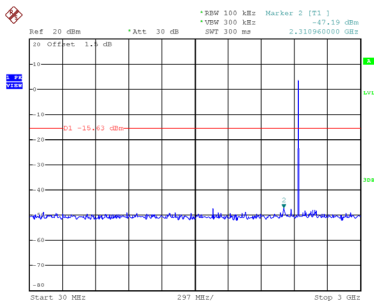

Date: 18\_JUL.2019 22:01:34

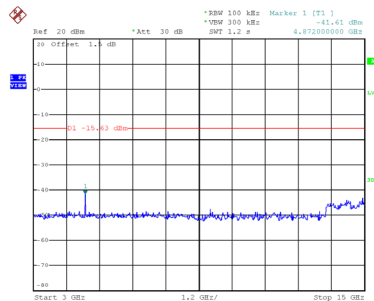

Date: 18\_JUL.2019 22:01:42

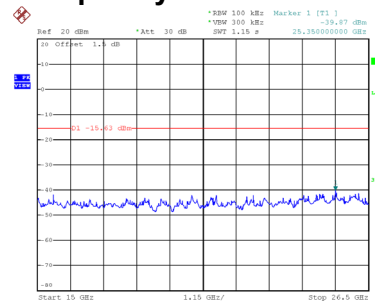

Date: 18\_JUL.2019 22:01:50

### CH39 – 10th Harmonic of the fundamental frequency

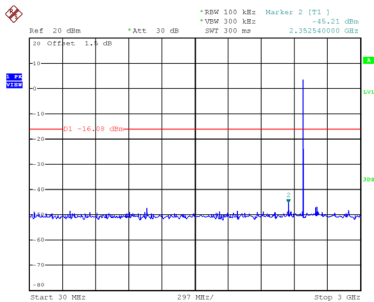

Date: 18\_JUL.2019 22:03:09

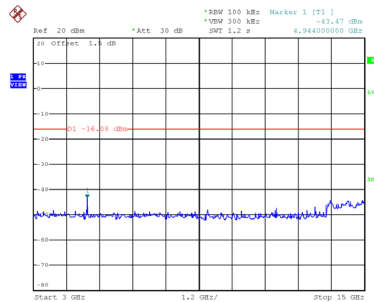

Date: 18\_JUL.2019 22:03:17

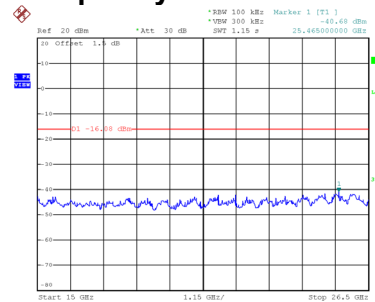

Date: 18\_JUL.2019 22:03:25

Test Mode : CH00, CH19, CH39 - 2Mbps

### Bandedge- CH00 (Lower)

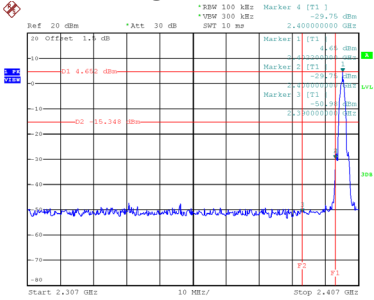

Date: 18\_JUL.2019 22:09:45

### Bandedge CH39 (Upper)

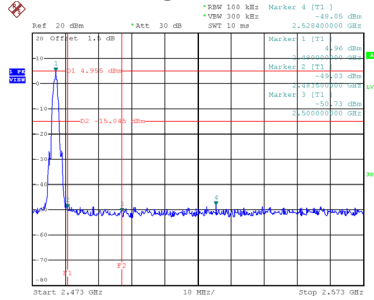

Date: 18\_JUL.2019 22:11:11

### CH00 – 10th Harmonic of the fundamental frequency

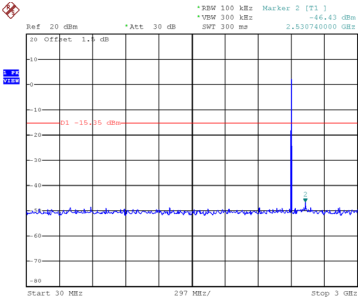

Date: 18\_JUL.2019 22:09:58

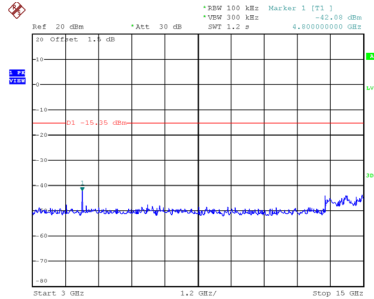

Date: 18\_JUL.2019 22:10:06

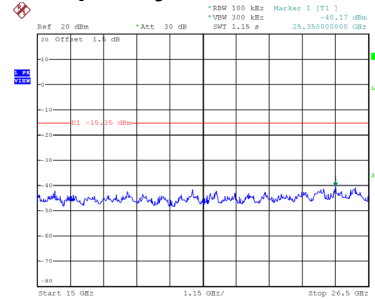

Date: 18\_JUL.2019 22:10:14

### CH19 – 10th Harmonic of the fundamental frequency

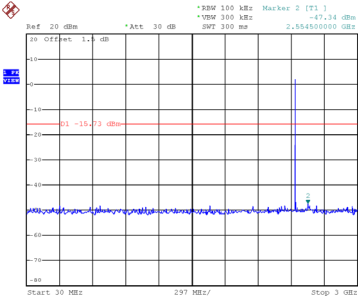

Date: 18\_JUL.2019 22:10:40

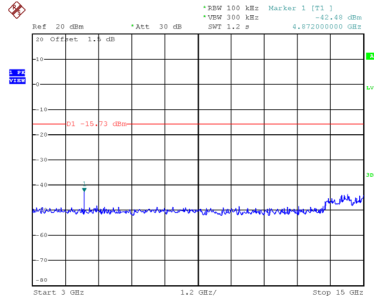

Date: 18\_JUL.2019 22:10:48

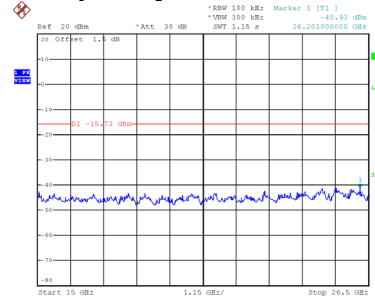

Date: 18\_JUL.2019 22:10:56

### CH39 – 10th Harmonic of the fundamental frequency

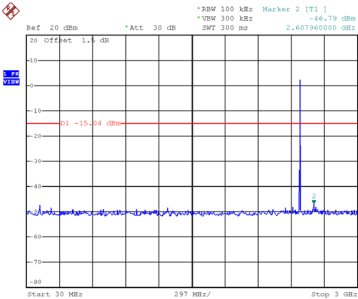

Date: 18\_JUL.2019 22:11:25

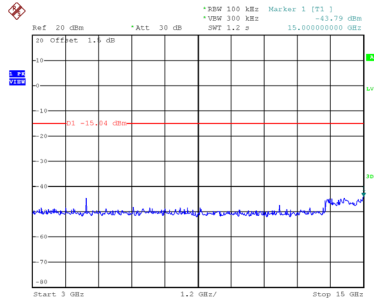

Date: 18\_JUL.2019 22:11:32

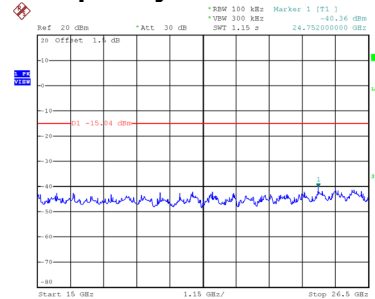

Date: 18\_JUL.2019 22:11:40

## APPENDIX H - POWER SPECTRAL DENSITY

Test Mode: CH00, CH19 , CH39 - 1Mbps

Channel	Frequency (MHz)	Power Spectral Density (dBm/3 kHz)	Max. Limit (dBm/3 kHz)	Test Result
00	2402	-10.170	8.00	Pass
19	2440	-9.140	8.00	Pass
39	2480	-7.390	8.00	Pass

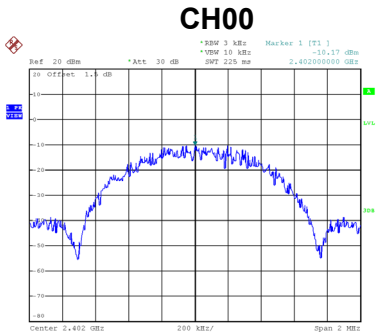

Date: 18\_JUL.2019 22:00:32

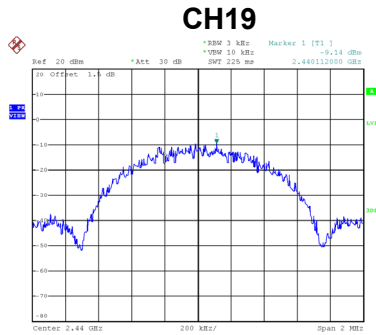

Date: 18\_JUL.2019 22:01:56

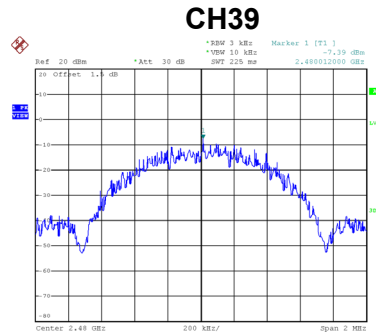

Date: 18\_JUL.2019 22:03:31

Test Mode: CH00, CH19 , CH39 - 2Mbps

Channel	Frequency (MHz)	Power Spectral Density (dBm/3 kHz)	Max. Limit (dBm/3 kHz)	Test Result
00	2402	-11.320	8.00	Pass
19	2440	-11.490	8.00	Pass
39	2480	-11.850	8.00	Pass

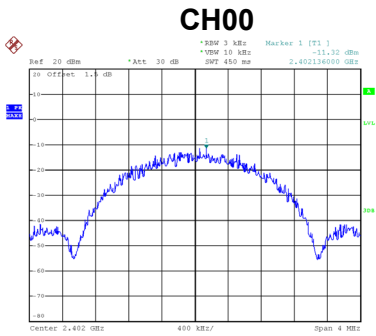

Date: 18\_JUL.2019 22:20:31

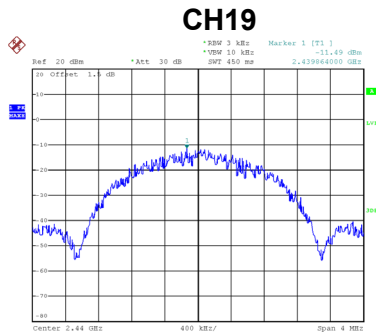

Date: 18\_JUL.2019 22:22:13

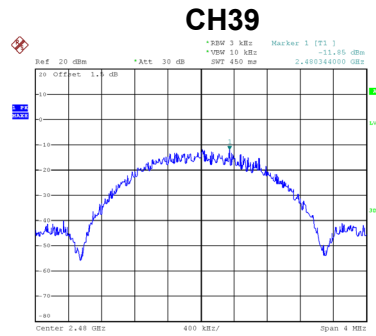

Date: 18\_JUL.2019 22:22:57

End of Test Report