

FCC Radio Test Report

FCC ID: RWO-RZ040379

This report concerns: Original Grant

Project No. : 2111C002
Equipment : Wireless Headset
Brand Name : RAZER
Test Model : RZ04-0379
Series Model : RZ04-0379XXXX-XXXX (X can be 0-9 or A-Z)
Applicant : Razer Inc.
Address : 9 Pasteur, Suite 100, Irvine, CA92618, USA
Manufacturer : Razer (Asia-Pacific) Pte.,Ltd.
Address : 1 one-north Crescent, #02-01 Singapore 138538
Factory : RAZER TECHNOLOGY AND DEVELOPMENT (SHENZHEN) CO., LTD
Address : East Wing, 3rd Floor, Block 2, Phase 1 of Vision Shenzhen Business Park Keji South Road, Hi-Tech Industrial Park, Shenzhen 518057, China
Date of Receipt : Nov. 01, 2021
Date of Test : Nov. 02, 2021 ~ Nov. 22, 2021
Issued Date : Dec. 09, 2021
Report Version : R00
Test Sample : Sample No.: DG2021110192 for conducted, DG2021110191 for radiated.
Standard(s) : FCC CFR Title 47, Part 15, Subpart C
FCC KDB 558074 D01 15.247 Meas Guidance v05r02
ANSI C63.10-2013

The above equipment has been tested and found compliance with the requirement of the relative standards by BTL Inc.

Vincent Tan

Prepared by : Vincent Tan

Welly Zhou

Approved by : Welly Zhou



TESTING CERT #5123.02

Add: No. 3 Jinshagang 1st Rd. Shixia, Dalang Town, Dongguan City, Guangdong, People's Republic of China

Tel: +86-769-8318-3000

Web: www.newbtl.com

Declaration

BTL represents to the client that testing is done in accordance with standard procedures as applicable and that test instruments used has been calibrated with standards traceable to international standard(s) and/or national standard(s).

BTL's reports apply only to the specific samples tested under conditions. It is manufacture's responsibility to ensure that additional production units of this model are manufactured with the identical electrical and mechanical components. **BTL** shall have no liability for any declarations, inferences or generalizations drawn by the client or others from **BTL** issued reports.

The report must not be used by the client to claim product certification, approval, or endorsement by NVLAP, NIST, A2LA, or any agency of the U.S. Government.

This report is the confidential property of the client. As a mutual protection to the clients, the public and ourselves, the test report shall not be reproduced, except in full, without our written approval.

BTL's laboratory quality assurance procedures are in compliance with the **ISO/IEC 17025** requirements, and accredited by the conformity assessment authorities listed in this test report.

BTL is not responsible for the sampling stage, so the results only apply to the sample as received.

The information, data and test plan are provided by manufacturer which may affect the validity of results, so it is manufacturer's responsibility to ensure that the apparatus meets the essential requirements of applied standards and in all the possible configurations as representative of its intended use.

Limitation

For the use of the authority's logo is limited unless the Test Standard(s)/Scope(s)/Item(s) mentioned in this test report is (are) included in the conformity assessment authorities acceptance respective.

Please note that the measurement uncertainty is provided for informational purpose only and are not use in determining the Pass/Fail results.

Table of Contents	Page
REPORT ISSUED HISTORY	6
1 . SUMMARY OF TEST RESULTS	7
1.1 TEST FACILITY	8
1.2 MEASUREMENT UNCERTAINTY	8
1.3 TEST ENVIRONMENT CONDITIONS	9
2 . GENERAL INFORMATION	10
2.1 GENERAL DESCRIPTION OF EUT	10
2.2 DESCRIPTION OF TEST MODES	12
2.3 PARAMETERS OF TEST SOFTWARE	13
2.4 BLOCK DIAGRAM SHOWING THE CONFIGURATION OF SYSTEM TESTED	14
2.5 SUPPORT UNITS	15
3 . AC POWER LINE CONDUCTED EMISSIONS	16
3.1 LIMIT	16
3.2 TEST PROCEDURE	16
3.3 DEVIATION FROM TEST STANDARD	16
3.4 TEST SETUP	17
3.5 EUT OPERATING CONDITIONS	17
3.6 TEST RESULTS	17
4 . RADIATED EMISSIONS	18
4.1 LIMIT	18
4.2 TEST PROCEDURE	19
4.3 DEVIATION FROM TEST STANDARD	20
4.4 TEST SETUP	20
4.5 EUT OPERATING CONDITIONS	21
4.6 TEST RESULTS - 9 KHZ TO 30 MHZ	21
4.7 TEST RESULTS - 30 MHZ TO 1000 MHZ	21
4.8 TEST RESULTS - ABOVE 1000 MHZ	21
5 . NUMBER OF HOPPING FREQUENCY	22
5.1 LIMIT	22
5.2 TEST PROCEDURE	22
5.3 DEVIATION FROM STANDARD	22
5.4 TEST SETUP	22
5.5 EUT OPERATION CONDITIONS	22

Table of Contents**Page**

5.6 TEST RESULTS	22
6 . AVERAGE TIME OF OCCUPANCY	23
6.1 LIMIT	23
6.2 TEST PROCEDURE	23
6.3 DEVIATION FROM STANDARD	23
6.4 TEST SETUP	23
6.5 EUT OPERATION CONDITIONS	23
6.6 TEST RESULTS	23
7 . HOPPING CHANNEL SEPARATION	24
7.1 LIMIT	24
7.2 TEST PROCEDURE	24
7.3 DEVIATION FROM STANDARD	24
7.4 TEST SETUP	24
7.5 EUT OPERATION CONDITIONS	24
7.6 TEST RESULTS	24
8 . BANDWIDTH	25
8.1 LIMIT	25
8.2 TEST PROCEDURE	25
8.3 DEVIATION FROM STANDARD	25
8.4 TEST SETUP	25
8.5 EUT OPERATION CONDITIONS	25
8.6 TEST RESULTS	25
9 . MAXIMUM OUTPUT POWER	26
9.1 LIMIT	26
9.2 TEST PROCEDURE	26
9.3 DEVIATION FROM STANDARD	26
9.4 TEST SETUP	26
9.5 EUT OPERATION CONDITIONS	26
9.6 TEST RESULTS	26
10 . CONDUCTED SPURIOUS EMISSION	27
10.1 LIMIT	27
10.2 TEST PROCEDURE	27
10.3 DEVIATION FROM STANDARD	27
10.4 TEST SETUP	27

Table of Contents	Page
10.5 EUT OPERATION CONDITIONS	27
10.6 TEST RESULTS	27
11 . MEASUREMENT INSTRUMENTS LIST	28
APPENDIX A - AC POWER LINE CONDUCTED EMISSIONS	30
APPENDIX B - RADIATED EMISSION - 9 KHZ TO 30 MHZ	33
APPENDIX C - RADIATED EMISSION - 30 MHZ TO 1000 MHZ	38
APPENDIX D - RADIATED EMISSION - ABOVE 1000 MHZ	41
APPENDIX E - NUMBER OF HOPPING FREQUENCY	66
APPENDIX F - AVERAGE TIME OF OCCUPANCY	68
APPENDIX G - HOPPING CHANNEL SEPARATION	73
APPENDIX H - BANDWIDTH	75
APPENDIX I - MAXIMUM OUTPUT POWER	77
APPENDIX J - CONDUCTED SPURIOUS EMISSION	81
APPENDIX K - DECLARATION FOR BLUETOOTH DEVICE	86

REPORT ISSUED HISTORY

Report Version	Description	Issued Date
R00	Original Issue.	Dec. 09, 2021

1. SUMMARY OF TEST RESULTS

Test procedures according to the technical standard(s):

FCC CFR Title 47, Part 15, Subpart C				
Standard(s) Section	Test Item	Test Result	Judgment	Remark
15.207	AC Power Line Conducted Emissions	APPENDIX A	PASS	-----
15.247(d) 15.205(a) 15.209(a)	Radiated Emission	APPENDIX B APPENDIX C APPENDIX D	PASS	-----
15.247 (a)(1)(iii)	Number of Hopping Frequency	APPENDIX E	PASS	-----
15.247 (a)(1)(iii)	Average Time of Occupancy	APPENDIX F	PASS	-----
15.247(a)(1)	Hopping Channel Separation	APPENDIX G	PASS	-----
15.247(a)(1)	Bandwidth	APPENDIX H	PASS	-----
15.247(a)(1)	Maximum Output Power	APPENDIX I	PASS	-----
15.247(d)	Conducted Spurious Emission	APPENDIX J	PASS	-----
15.203	Antenna Requirement	-----	PASS	Note(2)

Note:

- (1) "N/A" denotes test is not applicable in this test report
- (2) The device what use a permanently attached antenna were considered sufficient to comply with the provisions of 15.203.

1.1 TEST FACILITY

The test facilities used to collect the test data in this report is at the location of No. 3 Jinshagang 1st Rd. Shixia, Dalang Town, Dongguan City, Guangdong, People's Republic of China.

BTL's Registration Number for FCC: 357015

BTL's Designation Number for FCC: CN1240

1.2 MEASUREMENT UNCERTAINTY

ISO/IEC 17025 requires that an estimate of the measurement uncertainties associated with the emissions test results be included in the report. The measurement uncertainties given below are based on a 95% confidence level (based on a coverage factor (k=2))

The BTL measurement uncertainty as below table:

A. AC power line conducted emissions test:

Test Site	Method	Measurement Frequency Range	U, (dB)
DG-C02	CISPR	150kHz ~ 30MHz	2.60

B. Radiated emissions test:

Test Site	Method	Measurement Frequency Range	Ant. H / V	U, (dB)
DG-CB01	CISPR	9kHz ~ 30MHz	-	2.36
DG-CB03	CISPR	30MHz ~ 200MHz	V	4.36
		30MHz ~ 200MHz	H	3.32
		200MHz ~ 1,000MHz	V	4.08
		200MHz ~ 1,000MHz	H	3.96
		1GHz ~ 6GHz	-	3.80
		6GHz ~ 18GHz	-	4.82
		18GHz ~ 26.5GHz	-	3.62
		26.5GHz ~ 40GHz	-	4.00

C. Other Measurement:

Test Item	Uncertainty
Conducted Spurious Emission	±2.71 dB
Hopping Channel Separation	±53.46 Hz
Maximum Output Power	±0.95 dB
Number of Hopping Frequency	±53.46 Hz
Bandwidth	±3.8 %
Temperature	±0.08 °C
Humidity	±1.5%

Note: Unless specifically mentioned, the uncertainty of measurement has not been taken into account to declare the compliance or non-compliance to the specification.

1.3 TEST ENVIRONMENT CONDITIONS

Test Item	Temperature	Humidity	Test Voltage	Tested By
AC Power Line Conducted Emissions	23°C	65%	AC 120V/60Hz	Aries Tang
Radiated Emissions-9 kHz to 30 MHz	25°C	55%	DC 5V	Sparrow Liu
Radiated Emissions-30 MHz to 1000 MHz	22°C	49%	DC 5V	Kwok Guo
Radiated Emissions-Above 1000 MHz	23°C	39%	DC 5V	Kwok Guo Chen Mo
Number of Hopping Frequency	24°C	46%	DC 5V	King Huang
Average Time of Occupancy	24°C	46%	DC 5V	King Huang
Hopping Channel Separation	24°C	46%	DC 5V	King Huang
Bandwidth	24°C	46%	DC 5V	King Huang
Maximum Output Power	24°C	46%	DC 5V	King Huang
Conducted Spurious Emission	24°C	46%	DC 5V	King Huang

2. GENERAL INFORMATION

2.1 GENERAL DESCRIPTION OF EUT

Equipment	Wireless Headset
Brand Name	RAZER
Test Model	RZ04-0379
Series Model	RZ04-0379XXXX-XXXX (X can be 0-9 or A-Z)
Model Difference(s)	The system model number is RZ04-0379XXXX-XXXX, this system consists of Wireless Headset (Model: RZ04-0379) and USB Wireless Transceiver (Model: RC30-0378), X can be 0-9 or A-Z.
Power Source	1# Supplied from PC USB port. 2# Supplied from battery. Model: 553450PN2
Power Rating	1# DC 5V 2# DC 3.7V 1200mAh/4.44Wh
Operation Frequency	2402 MHz ~ 2480 MHz
Modulation Type	GFSK, $\pi/4$ -DQPSK, 8-DPSK
Bit Rate of Transmitter	1Mbps, 2Mbps, 3Mbps
Max. Peak Output Power	3Mbps: 10.81 dBm (0.0121 W)
Max. Average Output Power	1Mbps: 8.80 dBm (0.0076 W)

Note:

1. For a more detailed features description, please refer to the manufacturer's specifications or the user's manual.

2. Channel List:

Channel	Frequency (MHz)	Channel	Frequency (MHz)	Channel	Frequency (MHz)
00	2402	27	2429	54	2456
01	2403	28	2430	55	2457
02	2404	29	2431	56	2458
03	2405	30	2432	57	2459
04	2406	31	2433	58	2460
05	2407	32	2434	59	2461
06	2408	33	2435	60	2462
07	2409	34	2436	61	2463
08	2410	35	2437	62	2464
09	2411	36	2438	63	2465
10	2412	37	2439	64	2466
11	2413	38	2440	65	2467
12	2414	39	2441	66	2468
13	2415	40	2442	67	2469
14	2416	41	2443	68	2470
15	2417	42	2444	69	2471
16	2418	43	2445	70	2472
17	2419	44	2446	71	2473
18	2420	45	2447	72	2474
19	2421	46	2448	73	2475
20	2422	47	2449	74	2476
21	2423	48	2450	75	2477
22	2424	49	2451	76	2478
23	2425	50	2452	77	2479
24	2426	51	2453	78	2480
25	2427	52	2454		
26	2428	53	2455		

3. Table for Filed Antenna:

Ant.	Brand	Model Name	Antenna Type	Connector	Gain (dBi)
1	Innovation	N/A	PCB	N/A	4.18

Note: The antenna gain is provided by the manufacturer.

2.2 DESCRIPTION OF TEST MODES

The test system was pre-tested based on the consideration of all possible combinations of EUT operation mode.

Pretest Mode	Description
Mode 1	TX Mode_1Mbps Channel 00/39/78
Mode 2	TX Mode_2Mbps Channel 00/39/78
Mode 3	TX Mode_3Mbps Channel 00/39/78
Mode 4	TX Mode_3Mbps Channel 00

Following mode(s) was (were) found to be the worst case(s) and selected for the final test.

AC power line conducted emissions test	
Final Test Mode	Description
Mode 4	TX Mode_3Mbps Channel 00

Radiated emissions test - Below 1GHz	
Final Test Mode	Description
Mode 4	TX Mode_3Mbps Channel 00

Radiated emissions test - Above 1GHz	
Final Test Mode	Description
Mode 1	TX Mode_1Mbps Channel 00/39/78
Mode 3	TX Mode_3Mbps Channel 00/39/78

Maximum Output Power	
Final Test Mode	Description
Mode 1	TX Mode_1Mbps Channel 00/39/78
Mode 2	TX Mode_2Mbps Channel 00/39/78
Mode 3	TX Mode_3Mbps Channel 00/39/78

Other Conducted test	
Final Test Mode	Description
Mode 1	TX Mode_1Mbps Channel 00/39/78
Mode 3	TX Mode_3Mbps Channel 00/39/78

Note:

- (1) The measurements for Output Power were tested with DH1/3/5 during 1Mbps, 2Mbps and 3Mbps, the worst case were 1Mbps (DH5) and 3Mbps (DH5), only worst case were documented for other test items except Average Time of Occupancy.
- (2) For radiated emission above 1 GHz test, the spurious points of 1GHz~26.5GHz have been pre-tested and in this report only recorded the worst case. The remaining spurious points are all below the limit value of 20dB.
- (3) For AC power line conducted emissions and radiated spurious emissions below 1 GHz test, the 3Mbps Channel 00 is found to be the worst case and recorded.
- (4) The product supports 2.4G Hopping technology and Bluetooth technology at the same time, and the technology used is similar to that of Bluetooth. The chip and fixed frequency software used at the same time are the same. The difference is that when the product does not work with Bluetooth technology, it needs to be used with a dongle. So only tested one of Bluetooth technology and hopping technology.

2.3 PARAMETERS OF TEST SOFTWARE

During testing, channel & power controlling software provided by the customer was used to control the operating channel as well as the output power level.

Test Software Version	AWRDLABV2(1.2.9.7)		
Frequency (MHz)	2402	2441	2480
1Mbps	0x02	0x02	0x02
2Mbps	0x02	0x02	0x02
3Mbps	0x02	0x02	0x02

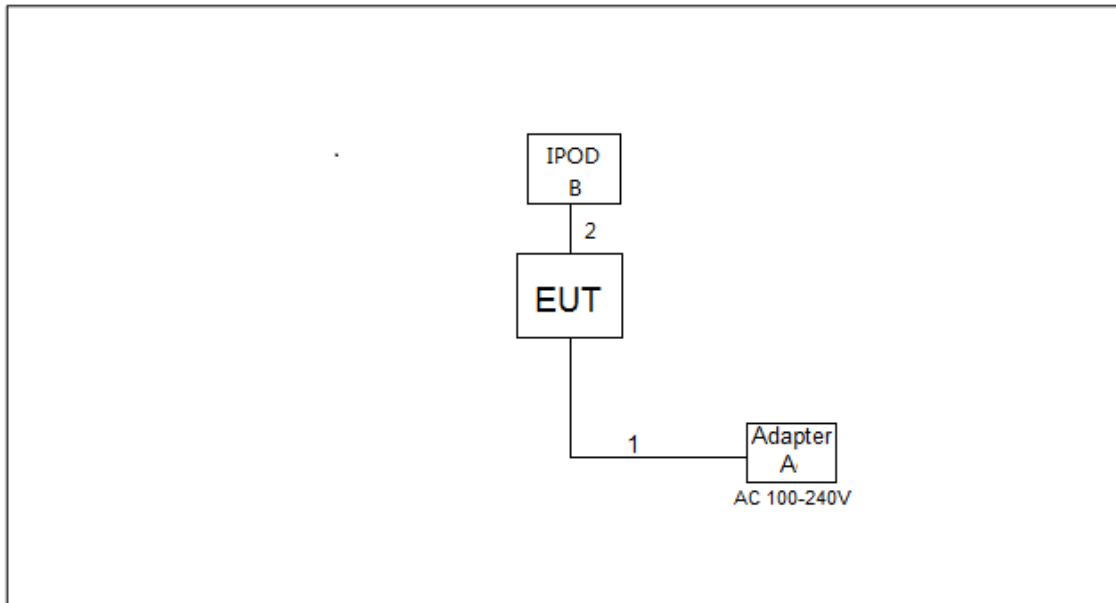
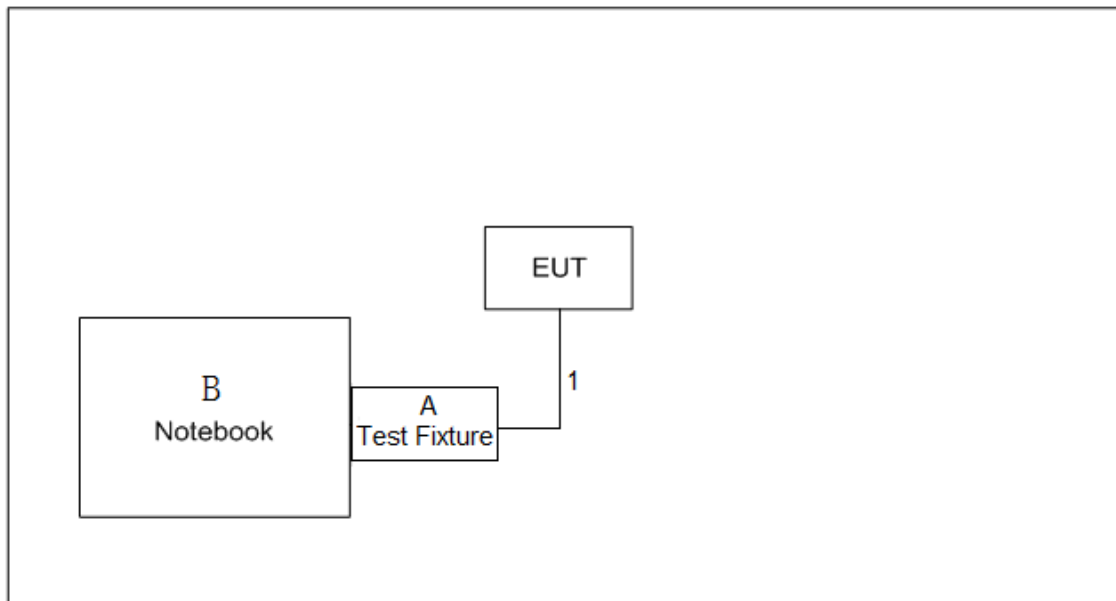
2.4 BLOCK DIAGRAM SHOWING THE CONFIGURATION OF SYSTEM TESTED**For AC power line conducted emissions test****For Radiated emissions test**

2.5 SUPPORT UNITS

For AC power line conducted emissions test

Item	Equipment	Brand	Model No.	Series No.
A	Adapter	HUAWEI	N/A	N/A
B	IPOD	APPLE	A1574	CCQTJ1N3GGK8

Item	Cable Type	Shielded Type	Ferrite Core	Length
1	USB Cable	NO	NO	1m
2	Audio Cable	YES	NO	1.2m

For Radiated emissions test

Item	Equipment	Brand	Model No.	Series No.	Note
A	Test Fixture	N/A	N/A	N/A	-
B	Notebook	Lenovo	Pro 13	N/A	9 kHz to 30 MHz
		Honor	14SER5 3500	N/A	Above 30 MHz

Item	Cable Type	Shielded Type	Ferrite Core	Length
1	Data Cable	NO	NO	0.2m

3. AC POWER LINE CONDUCTED EMISSIONS

3.1 LIMIT

Frequency of Emission (MHz)	Limit (dB μ V)	
	Quasi-peak	Average
0.15 - 0.5	66 to 56*	56 to 46*
0.5 - 5.0	56	46
5.0 - 30.0	60	50

Note:

- (1) The tighter limit applies at the band edges.
- (2) The limit of " * " marked band means the limitation decreases linearly with the logarithm of the frequency in the range.

3.2 TEST PROCEDURE

- a. The EUT was placed 0.8 meters from the horizontal ground plane with EUT being connected to the power mains through a line impedance stabilization network (LISN). All other support equipment powered from additional LISN(s). The LISN provide 50 Ohm/ 50uH of coupling impedance for the measuring instrument.
- b. Interconnecting cables that hang closer than 40 cm to the ground plane shall be folded back and forth in the center forming a bundle 30 to 40 cm long.
- c. I/O cables that are not connected to a peripheral shall be bundled in the center. The end of the cable may be terminated, if required, using the correct terminating impedance. The overall length shall not exceed 1 m.
- d. LISN at least 80 cm from nearest part of EUT chassis.
- e. For the actual test configuration, please refer to the related Item –EUT Test Photos.

The following table is the setting of the receiver:

Receiver Parameters	Setting
Start Frequency	0.15 MHz
Stop Frequency	30 MHz
IF Bandwidth	9 kHz

3.3 DEVIATION FROM TEST STANDARD

No deviation.

3.4 TEST SETUP

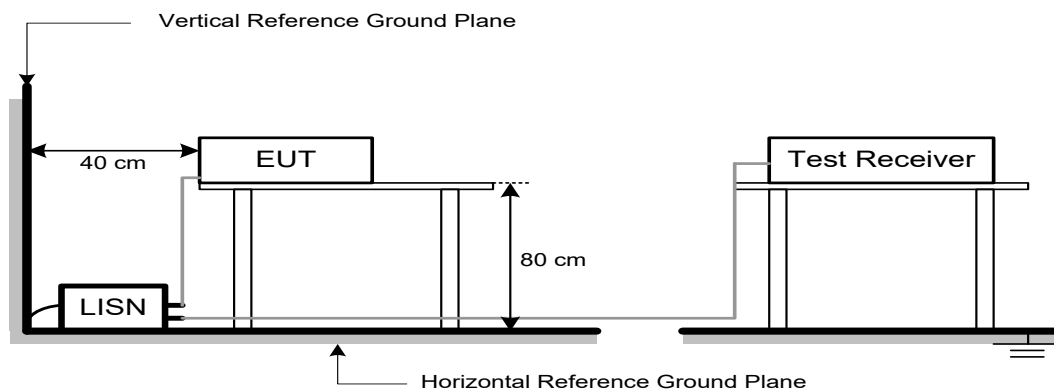

3.5 EUT OPERATING CONDITIONS

The EUT was configured for testing in a typical function (as a customer would normally use it), EUT was programmed to be in continuously transmitting data or hopping on mode.

3.6 TEST RESULTS

Please refer to the APPENDIX A.

Remark:

- (1) All readings are QP Mode value unless otherwise stated AVG in column of 『Note』 . If the QP Mode Measured value compliance with the QP Limits and lower than AVG Limits, the EUT shall be deemed to meet both QP & AVG Limits and then only QP Mode was measured, but AVG Mode didn't perform in this case, a "*" marked in AVG Mode column of Interference Voltage Measured.
- (2) Measuring frequency range from 150 kHz to 30 MHz.

4. RADIATED EMISSIONS

4.1 LIMIT

In case the emission fall within the restricted band specified on 15.205(a), then the 15.209(a) limit in the table below has to be followed.

LIMITS OF RADIATED EMISSION MEASUREMENT (9 kHz-1000 MHz)

Frequency (MHz)	Field Strength (microvolts/meter)	Measurement Distance (meters)
0.009-0.490	2400/F(kHz)	300
0.490-1.705	24000/F(kHz)	30
1.705-30.0	30	30
30-88	100	3
88-216	150	3
216-960	200	3
Above 960	500	3

LIMITS OF RADIATED EMISSION MEASUREMENT (Above 1000 MHz)

Frequency (MHz)	(dBuV/m at 3 m)	
	Peak	Average
Above 1000	74	54

Note:

- (1) The limit for radiated test was performed according to FCC CFR Title 47, Part 15, Subpart C.
- (2) The tighter limit applies at the band edges.
- (3) Emission level (dBuV/m)=20log Emission level (uV/m).

4.2 TEST PROCEDURE

- a. The measuring distance of 3 m shall be used for measurements. The EUT was placed on the top of a rotating table 0.8 meter above the ground at a 3 meter semi-anechoic chamber. The table was rotated 360 degrees to determine the position of the highest radiation.(below 1 GHz)
- b. The measuring distance of 3 m shall be used for measurements. The EUT was placed on the top of a rotating table 1.5 meter above the ground at a 3 meter semi-anechoic chamber. The table was rotated 360 degrees to determine the position of the highest radiation.(above 1 GHz)
- c. The height of the equipment or of the substitution antenna shall be 0.8m or 1.5m; the height of the test antenna shall vary between 1 m to 4 m. Both horizontal and vertical polarizations of the antenna are set to make the measurement.
- d. For each suspected emission, the EUT was arranged to its worst case and then the antenna was tuned to heights find the maximum reading (used Bore sight function).
- e. The receiver system was set to peak and average detect function and specified bandwidth with maximum hold mode when the test frequency is above 1 GHz.
- f. The initial step in collecting radiated emission data is a receiver peak detector mode pre-scanning the measurement frequency range. Significant peaks are then marked and then Quasi Peak detector mode re-measured.
- g. All readings are Peak unless otherwise stated QP in column of Note. Peak denotes that the Peak reading compliance with the QP Limits and then QP Mode measurement didn't perform.
(below 1 GHz)
- h. All readings are Peak Mode value unless otherwise stated AVG in column of Note. If the Peak Mode Measured value compliance with the Peak Limits and lower than AVG Limits, the EUT shall be deemed to meet both Peak & AVG Limits and then only Peak Mode was measured, but AVG Mode didn't perform. (above 1 GHz)
- i. For the actual test configuration, please refer to the related Item –EUT Test Photos.

The following table is the setting of the receiver:

Spectrum Parameters	Setting
Start ~ Stop Frequency	9 kHz~150 kHz for RBW 200 Hz
Start ~ Stop Frequency	0.15 MHz~30 MHz for RBW 9 kHz
Start ~ Stop Frequency	30 MHz~1000 MHz for RBW 100 kHz

Spectrum Parameters	Setting
Start Frequency	1000 MHz
Stop Frequency	10th carrier harmonic
RBW / VBW (Emission in restricted band)	1 MHz / 3 MHz for PK value 1 MHz / 1/T Hz for AVG value

Spectrum Parameters	Setting
Start ~ Stop Frequency	9 kHz~90 kHz for PK/AVG detector
Start ~ Stop Frequency	90 kHz~110 kHz for QP detector
Start ~ Stop Frequency	110 kHz~490 kHz for PK/AVG detector
Start ~ Stop Frequency	490 kHz~30 MHz for QP detector
Start ~ Stop Frequency	30 MHz~1000 MHz for QP detector
Start ~ Stop Frequency	1 GHz~26.5 GHz for PK/AVG detector

4.3 DEVIATION FROM TEST STANDARD

No deviation.

4.4 TEST SETUP

9 kHz to 30 MHz

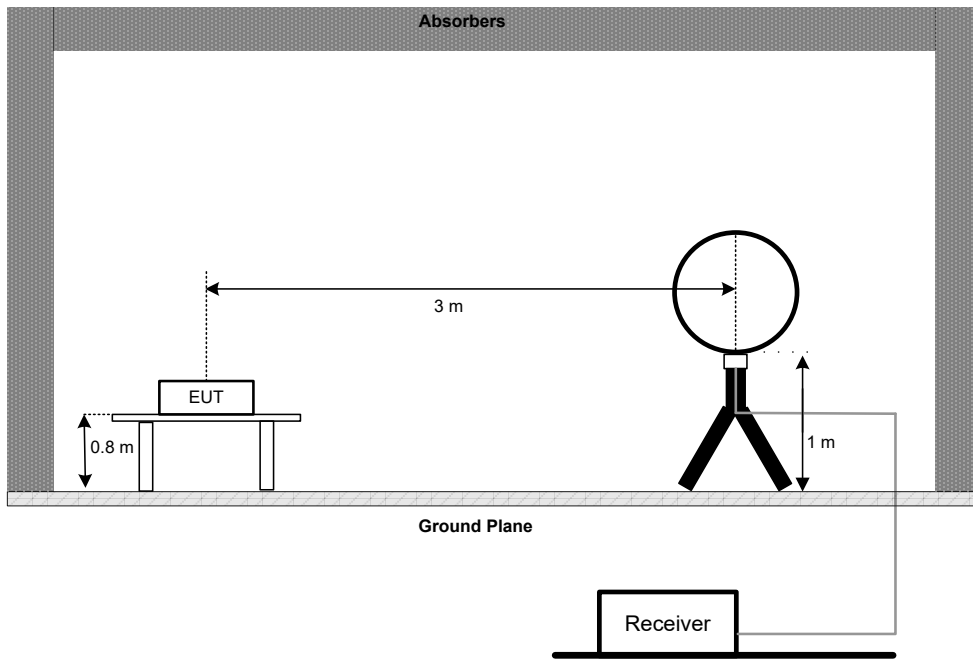

30 MHz to 1 GHz

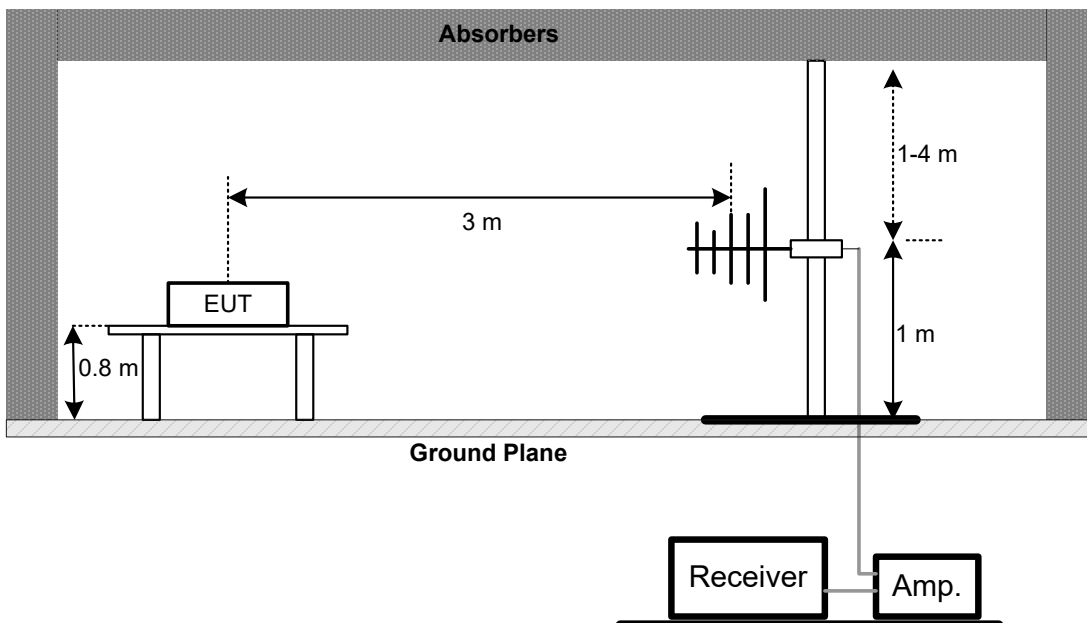

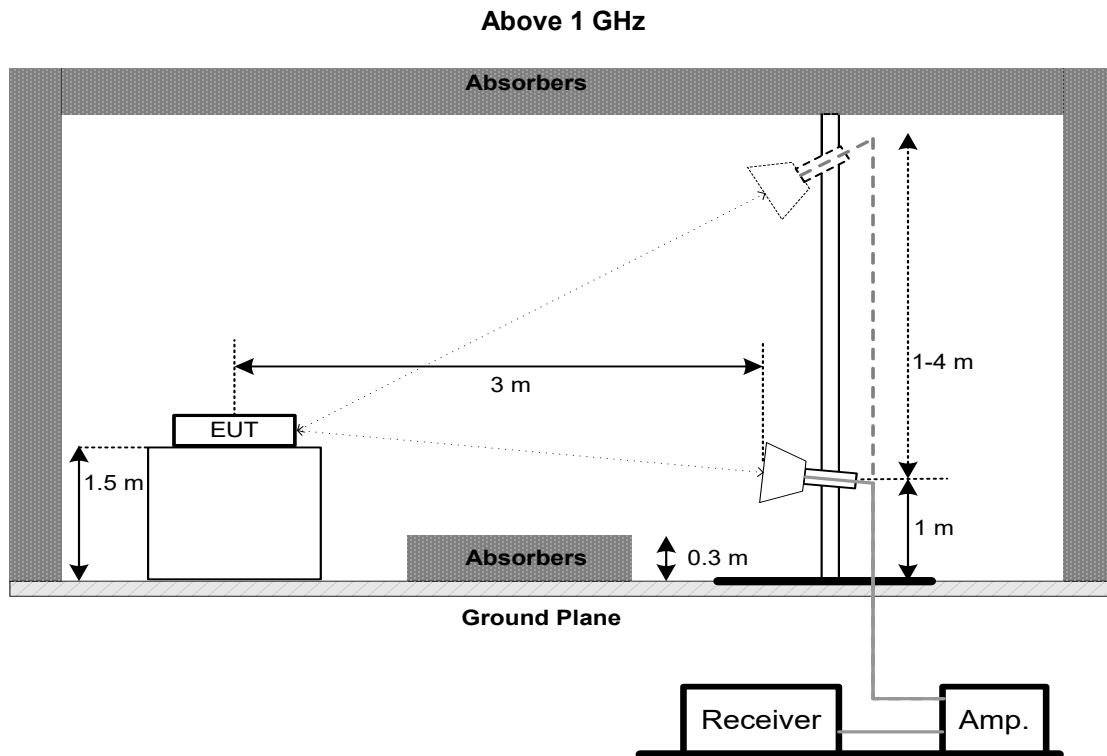

4.5 EUT OPERATING CONDITIONS

The EUT was programmed to be in continuously transmitting mode.

4.6 TEST RESULTS - 9 kHz TO 30 MHz

Please refer to the APPENDIX B.

Remark:

- (1) Distance extrapolation factor = $40 \log (\text{specific distance} / \text{test distance})$ (dB).
- (2) Limit line = specific limits (dBuV) + distance extrapolation factor.

4.7 TEST RESULTS - 30 MHz TO 1000 MHz

Please refer to the APPENDIX C.

4.8 TEST RESULTS - ABOVE 1000 MHz

Please refer to the APPENDIX D.

Remark:

- (1) No limit: This is fundamental signal, the judgment is not applicable.
For fundamental signal judgment was referred to Peak output test.

5. NUMBER OF HOPPING FREQUENCY

5.1 LIMIT

Section	Test Item	Limit
FCC 15.247(a)(1)(iii)	Number of Hopping Frequency	15

5.2 TEST PROCEDURE

- The EUT was directly connected to the spectrum analyzer and antenna output port as show in the block diagram below.
- The following table is the setting of the spectrum analyzer:

Spectrum Parameters	Setting
Span Frequency	> Operating Frequency Range
RBW	100 kHz
VBW	100 kHz
Detector	Peak
Trace	Max Hold
Sweep Time	Auto

5.3 DEVIATION FROM STANDARD

No deviation.

5.4 TEST SETUP



5.5 EUT OPERATION CONDITIONS

The EUT was programmed to be in continuously transmitting mode.

5.6 TEST RESULTS

Please refer to the APPENDIX E.

6. AVERAGE TIME OF OCCUPANCY

6.1 LIMIT

Section	Test Item	Limit
FCC 15.247(a)(1)(iii)	Average Time of Occupancy	0.4sec

6.2 TEST PROCEDURE

- Set the EUT for DH1, DH3 and DH5 packet transmitting.
- Measure the maximum time duration of one single pulse.
- DH1 Packet permit maximum $1600 / 79 / 2 = 10.12$ hops per second in each channel (1 time slot TX, 1 time slot RX). So, the dwell time is the time duration of the pulse times $10.12 \times 31.6 = 320$ within 31.6 seconds.
- DH3 Packet permit maximum $1600 / 79 / 4 = 5.06$ hops per second in each channel (3 time slots TX, 1 time slot RX). So, the dwell time is the time duration of the pulse times $5.06 \times 31.6 = 160$ within 31.6 seconds.
- DH5 Packet permit maximum $1600 / 79 / 6 = 3.37$ hops per second in each channel (5 time slots TX, 1 time slot RX). So, the dwell time is the time duration of the pulse times $3.37 \times 31.6 = 106.6$ within 31.6 seconds.
- The EUT was directly connected to the spectrum analyzer and antenna output port as show in the block diagram below.
- The following table is the setting of the spectrum analyzer:

Spectrum Parameters	Setting
Span Frequency	0 MHz
RBW	1 MHz
VBW	1 MHz
Detector	Peak
Trace	Max Hold
Sweep Time	As necessary to capture the entire dwell time per hopping channel

6.3 DEVIATION FROM STANDARD

No deviation.

6.4 TEST SETUP



6.5 EUT OPERATION CONDITIONS

The EUT was programmed to be in continuously transmitting mode.

6.6 TEST RESULTS

Please refer to the APPENDIX F.

7. HOPPING CHANNEL SEPARATION

7.1 LIMIT

Frequency hopping systems operating in the 2400-2483.5 MHz band may have hopping channel carrier frequencies that are separated by 25 kHz or two-thirds of the 20 dB bandwidth of the hopping channel, whichever is greater, provided the systems operate with an output power no greater than 125 mW.

7.2 TEST PROCEDURE

- a. The EUT was directly connected to the spectrum analyzer and antenna output port as show in the block diagram below.
- b. The following table is the setting of the spectrum analyzer:

Spectrum Parameters	Setting
Span Frequency	Wide enough to capture the peaks of two adjacent channels
RBW	30 kHz
VBW	100 kHz
Detector	Peak
Trace	Max Hold
Sweep Time	Auto

7.3 DEVIATION FROM STANDARD

No deviation.

7.4 TEST SETUP

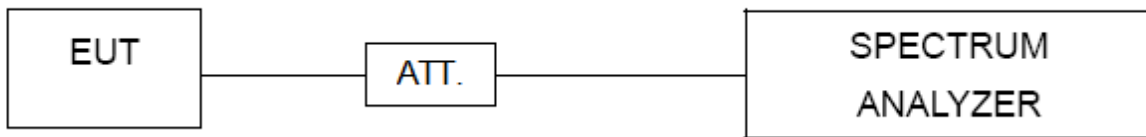

7.5 EUT OPERATION CONDITIONS

The EUT was programmed to be in continuously transmitting mode.

7.6 TEST RESULTS

Please refer to the APPENDIX G.

8. BANDWIDTH

8.1 LIMIT

Section	Test Item
FCC 15.247(a)(1)	Bandwidth

8.2 TEST PROCEDURE

- The EUT was directly connected to the spectrum analyzer and antenna output port as show in the block diagram below.
- The following table is the setting of the spectrum analyzer:

Spectrum Parameters	Setting
Span Frequency	> Measurement Bandwidth
RBW	30 kHz
VBW	100 kHz
Detector	Peak
Trace	Max Hold
Sweep Time	Auto

8.3 DEVIATION FROM STANDARD

No deviation.

8.4 TEST SETUP



8.5 EUT OPERATION CONDITIONS

The EUT was programmed to be in continuously transmitting mode.

8.6 TEST RESULTS

Please refer to the APPENDIX H.

9. MAXIMUM OUTPUT POWER

9.1 LIMIT

Section	Test Item	Limit
FCC 15.247(a)(1)	Maximum Output Power	0.1250 Watt or 20.97 dBm

Note: Frequency hopping systems operating in the 2400-2483.5 MHz band may have hopping channel carrier frequencies that are separated by 25 kHz or two-thirds of the 20 dB bandwidth of the hopping channel, whichever is greater, provided the systems operate with an output power no greater than 125 mW.

9.2 TEST PROCEDURE

- The EUT was directly connected to the spectrum analyzer and antenna output port as show in the block diagram below.
- The following table is the setting of the spectrum analyzer:

Spectrum Parameters	Setting
Span Frequency	Approximately five times the 20 dB bandwidth, centered on a hopping channel.
RBW	3 MHz
VBW	3 MHz
Detector	Peak/RMS
Trace	Max Hold
Sweep Time	Auto

9.3 DEVIATION FROM STANDARD

No deviation.

9.4 TEST SETUP

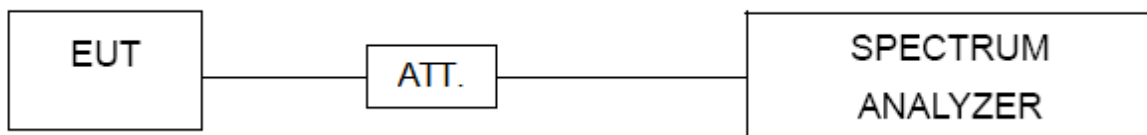

9.5 EUT OPERATION CONDITIONS

The EUT was programmed to be in continuously transmitting mode.

9.6 TEST RESULTS

Please refer to the APPENDIX I.

10. CONDUCTED SPURIOUS EMISSION

10.1 LIMIT

In any 100 kHz bandwidth outside the frequency band in which the spread spectrum or digitally modulated intentional radiator is operating, the radio frequency power that is produced by the intentional radiator shall be at least 20 dB below that in the 100 kHz bandwidth within the band that contains the highest level of the desired power, based on either an RF conducted or a radiated measurement, provided the transmitter demonstrates compliance with the peak Output Power limits. If the transmitter complies with the Output Power limits based on the use of RMS averaging over a time interval, as permitted under paragraph (b)(3) of this section, the attenuation required under this paragraph shall be 30 dB instead of 20 dB. Attenuation below the general limits specified in Section 15.209(a) is not required.

10.2 TEST PROCEDURE

- a. The EUT was directly connected to the spectrum analyzer and antenna output port as show in the block diagram below.
- b. The following table is the setting of the spectrum analyzer:

Spectrum Parameters	Setting
Start Frequency	30 MHz
Stop Frequency	26.5 GHz
RBW	100 kHz
VBW	100 kHz
Detector	Peak
Trace	Max Hold
Sweep Time	Auto

10.3 DEVIATION FROM STANDARD

No deviation.

10.4 TEST SETUP

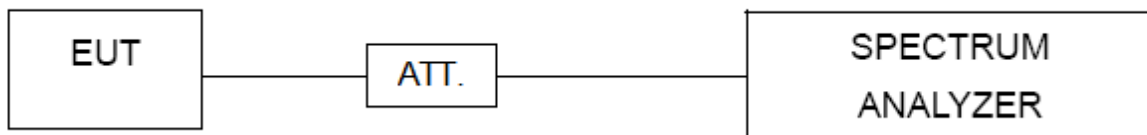

10.5 EUT OPERATION CONDITIONS

The EUT was programmed to be in continuously transmitting mode.

10.6 TEST RESULTS

Please refer to the APPENDIX J.

11. MEASUREMENT INSTRUMENTS LIST

AC Power Line Conducted Emissions					
Item	Kind of Equipment	Manufacturer	Type No.	Serial No.	Calibrated until
1	EMI Test Receiver	R&S	ESCI	100382	Feb. 28, 2022
2	LISN	EMCO	3816/2	52765	Feb. 27, 2022
3	TWO-LINE V-NETWORK	R&S	ENV216	101447	Feb. 27, 2022
4	50Ω Terminator	SHX	TF5-3	15041305	Feb. 27, 2022
5	Measurement Software	Farad	EZ-EMC Ver.NB-03A1-01	N/A	N/A
6	Cable	N/A	RG223	12m	Mar. 09, 2022
7	643 Shield Room	ETS	6*4*3	N/A	N/A

Radiated Emissions - 9 kHz to 30 MHz					
Item	Kind of Equipment	Manufacturer	Type No.	Serial No.	Calibrated until
1	MXE EMI Receiver	Keysight	N9038A	MY56400091	Feb. 27, 2022
2*	Active Loop Antenna	R&S	HFH2-Z2	830749/020	Aug. 23, 2024
3	Cable	N/A	RG 213/U(9kHz~1GHz)	N/A	May 27, 2022
4	Measurement Software	Farad	EZ-EMC Ver.NB-03A1-01	N/A	N/A
5	966 Chamber Room	ETS	9*6*6	N/A	Jul. 17, 2022

Radiated Emissions - 30 MHz to 1 GHz					
Item	Kind of Equipment	Manufacturer	Type No.	Serial No.	Calibrated until
1	Antenna	Schwarzbeck	VULB9160	9160-3232	Mar. 15, 2022
2	Amplifier	HP	8447D	2944A08742	Feb. 28, 2022
3	Cable	emci	LMR-400	N/A	Nov. 30, 2022
4	Controller	CT	SC100	N/A	N/A
5	Controller	MF	MF-7802	MF780208416	N/A
6	Receiver	Agilent	N9038A	MY52130039	Mar. 19, 2022
7	Measurement Software	Farad	EZ-EMC Ver.NB-03A1-01	N/A	N/A
8	966 Chamber Room	RM	9*6*6	N/A	Jul. 24, 2022

Radiated Emissions - Above 1 GHz					
Item	Kind of Equipment	Manufacturer	Type No.	Serial No.	Calibrated until
1	Double Ridged Horn Antenna	ARA	DRG-118A	16554	Apr. 21, 2022
2	Broad-Band Horn Antenna	Schwarzbeck	BBHA 9170	9170319	Jun. 30, 2022
3	Amplifier	Agilent	8449B	3008A02584	Jul. 10, 2022
4	Controller	CT	SC100	N/A	N/A
5	Controller	MF	MF-7802	MF780208416	N/A
6	Receiver	Agilent	N9038A	MY52130039	Mar. 19, 2022
7	EXA Spectrum Analyzer	Keysight	N9010A	MY56480488	Feb. 28, 2022
8	Low Noise Amplifier	CONNPHY	CLN-18G40G-4330 -K	619413	Jul. 16, 2022
9	Cable	N/A	A81-SMAMSMAM- 12.5M	N/A	Oct. 15, 2022
10	Cable	Talent microwave	A40-2.92M2.92M-2. 5M	N/A	Nov. 30, 2021
11	Filter	STI	STI15-9912	N/A	Jul. 10, 2022
12	Measurement Software	Farad	EZ-EMC Ver.NB-03A1-01	N/A	N/A
13	966 Chamber Room	RM	9*6*6	N/A	Jul. 24, 2022

**Number of Hopping Frequency &
 Average Time of Occupancy &
 Hopping Channel Separation &
 Bandwidth &
 Maximum Output Power &
 Conducted Spurious Emission**

Item	Kind of Equipment	Manufacturer	Type No.	Serial No.	Calibrated until
1	Spectrum Analyzer	R&S	FSP40	100185	Jul. 10, 2022
2	Attenuator	WOKEN	6SM3502	VAS1214NL	Feb. 07, 2022
3	RF Cable	Tongkaichuan	N/A	N/A	N/A
4	DC Block	Mini	N/A	N/A	N/A

Remark "N/A" denotes no model name, serial no. or calibration specified.

"*" calibration period of equipment list is three year.

Except * item, all calibration period of equipment list is one year.

APPENDIX A - AC POWER LINE CONDUCTED EMISSIONS

Test Mode	TX Mode_3Mbps Channel 00	Phase	Line
-----------	--------------------------	-------	------

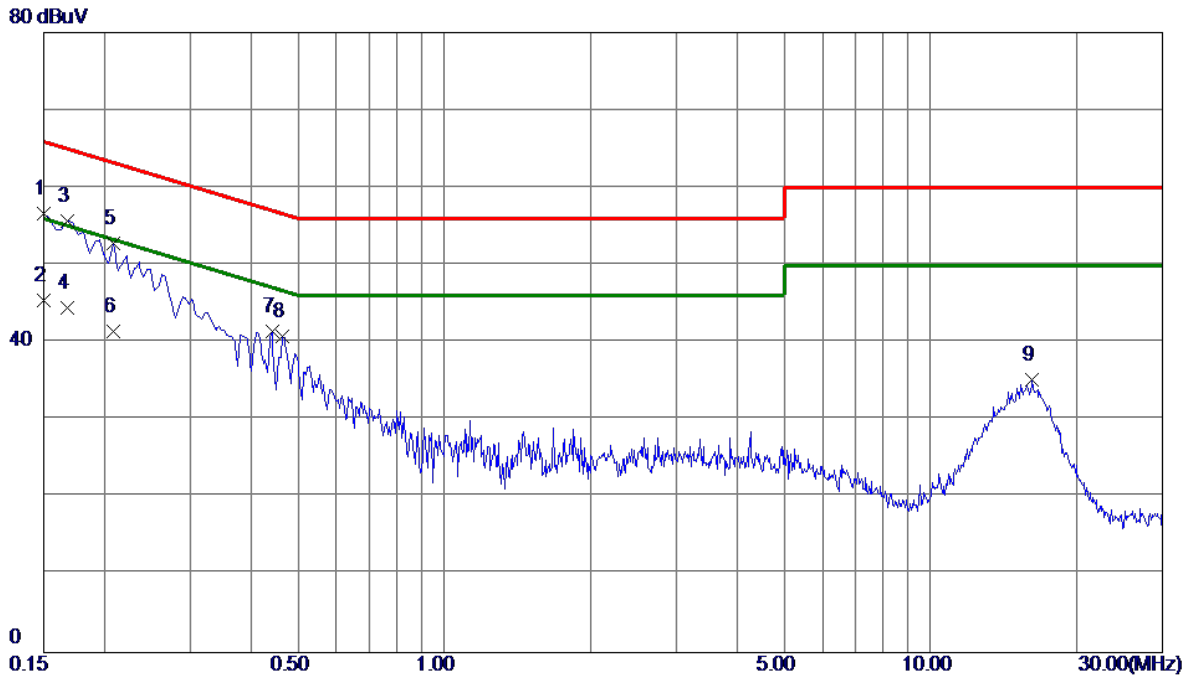

No.	Freq. MHz	Reading Level dBuV	Correct Factor dB	Measure ment dBuV	Limit dBuV	Margin dB	Detector	Comment
1	0.1500	46.87	9.78	56.65	66.00	-9.35	Peak	
2	0.1500	35.60	9.78	45.38	56.00	-10.62	AVG	
3 *	0.1680	45.95	9.79	55.74	65.06	-9.32	Peak	
4	0.1680	34.70	9.79	44.49	55.06	-10.57	AVG	
5	0.2085	42.98	9.82	52.80	63.26	-10.46	Peak	
6	0.2085	31.60	9.82	41.42	53.26	-11.84	AVG	
7	0.4425	31.65	9.86	41.51	57.01	-15.50	Peak	
8	0.4650	30.87	9.86	40.73	56.60	-15.87	Peak	
9	16.2150	24.44	10.71	35.15	60.00	-24.85	Peak	

REMARKS:

- (1) Measurement Value = Reading Level + Correct Factor.
- (2) Margin Level = Measurement Value - Limit Value.

Test Mode	TX Mode_3Mbps Channel 00	Phase	Neutral
-----------	--------------------------	-------	---------

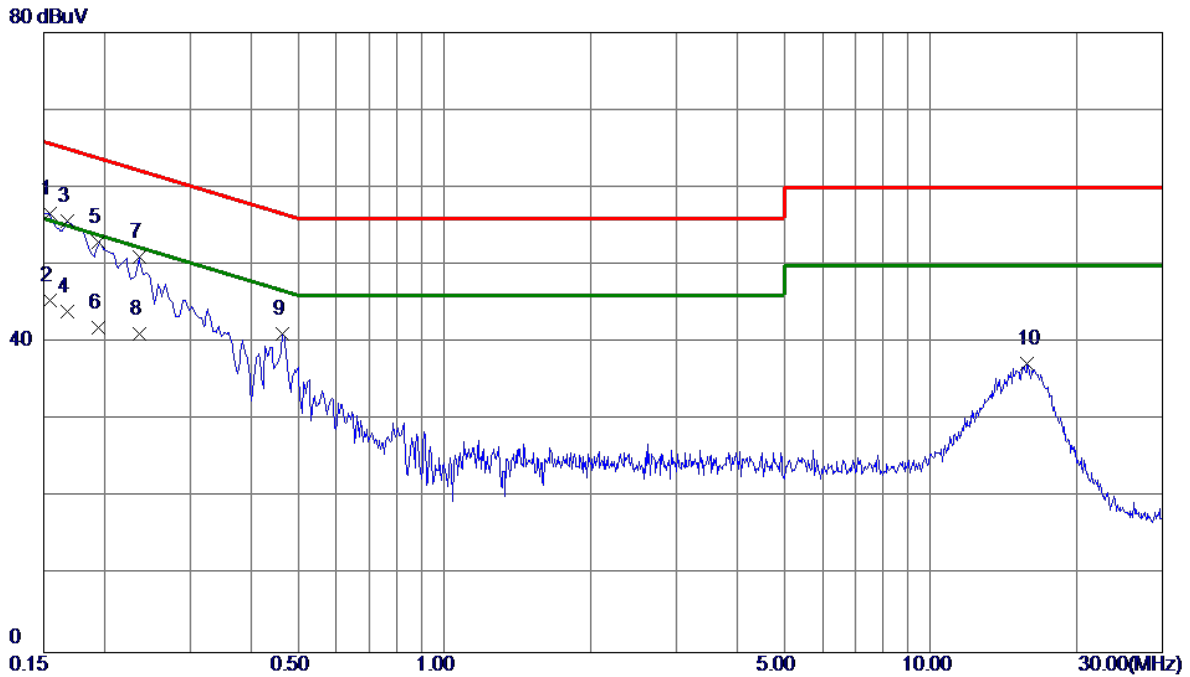

No.	Freq. MHz	Reading Level dBuV	Correct Factor dB	Measure ment dBuV	Limit dBuV	Margin dB	Detector	Comment
1 *	0.1545	46.81	9.82	56.63	65.75	-9.12	Peak	
2	0.1545	35.60	9.82	45.42	55.75	-10.33	AVG	
3	0.1680	45.78	9.84	55.62	65.06	-9.44	Peak	
4	0.1680	34.20	9.84	44.04	55.06	-11.02	AVG	
5	0.1949	43.17	9.85	53.02	63.83	-10.81	Peak	
6	0.1949	32.10	9.85	41.95	53.83	-11.88	AVG	
7	0.2355	41.16	9.86	51.02	62.25	-11.23	Peak	
8	0.2355	31.20	9.86	41.06	52.25	-11.19	AVG	
9	0.4650	31.13	9.93	41.06	56.60	-15.54	Peak	
10	15.8055	26.49	10.77	37.26	60.00	-22.74	Peak	

REMARKS:

- (1) Measurement Value = Reading Level + Correct Factor.
- (2) Margin Level = Measurement Value - Limit Value.

APPENDIX B - RADIATED EMISSION - 9 KHZ TO 30 MHZ

Test Mode	TX Mode_3Mbps Channel 00	Polarization	Ant 0°
-----------	--------------------------	--------------	--------

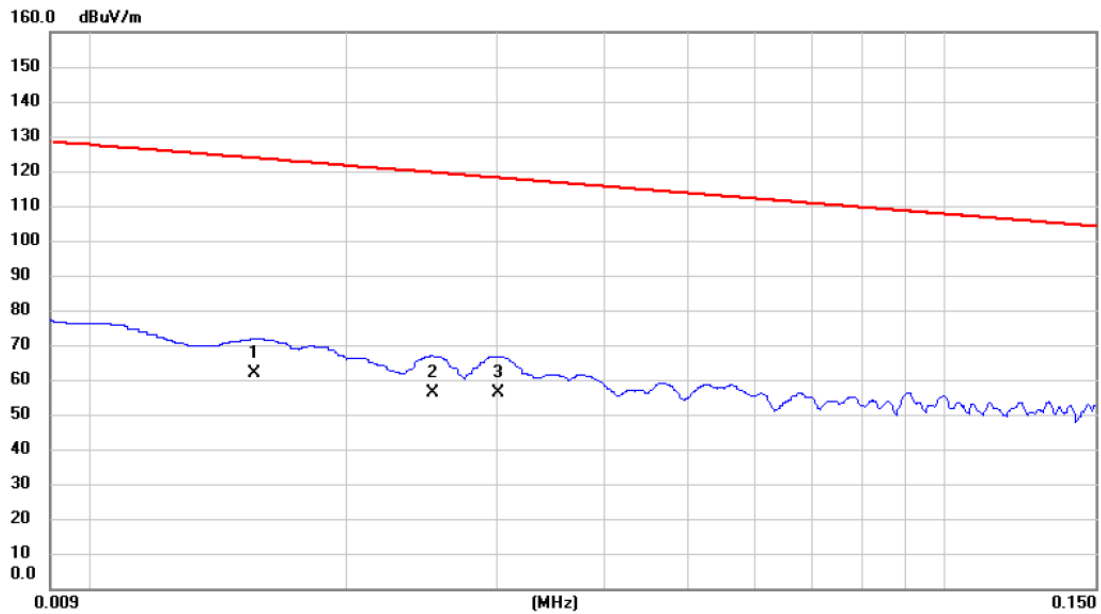

No.	Mk.	Freq.	Reading Level	Correct Factor	Measurement	Limit	Margin	Antenna Height	Table Degree	
		MHz	dBuV	dB	dBuV/m	dBuV/m	dB	cm	degree	Comment
1		0.0156	47.26	14.46	61.72	123.74	-62.02			AVG
2		0.0252	43.21	12.96	56.17	119.58	-63.41			AVG
3	*	0.0301	43.21	12.83	56.04	118.03	-61.99			AVG

REMARKS:

(1) Measurement Value = Reading Level + Correct Factor.

(2) Margin Level = Measurement Value - Limit Value.

Test Mode	TX Mode_3Mbps Channel 00	Polarization	Ant 0°
-----------	--------------------------	--------------	--------

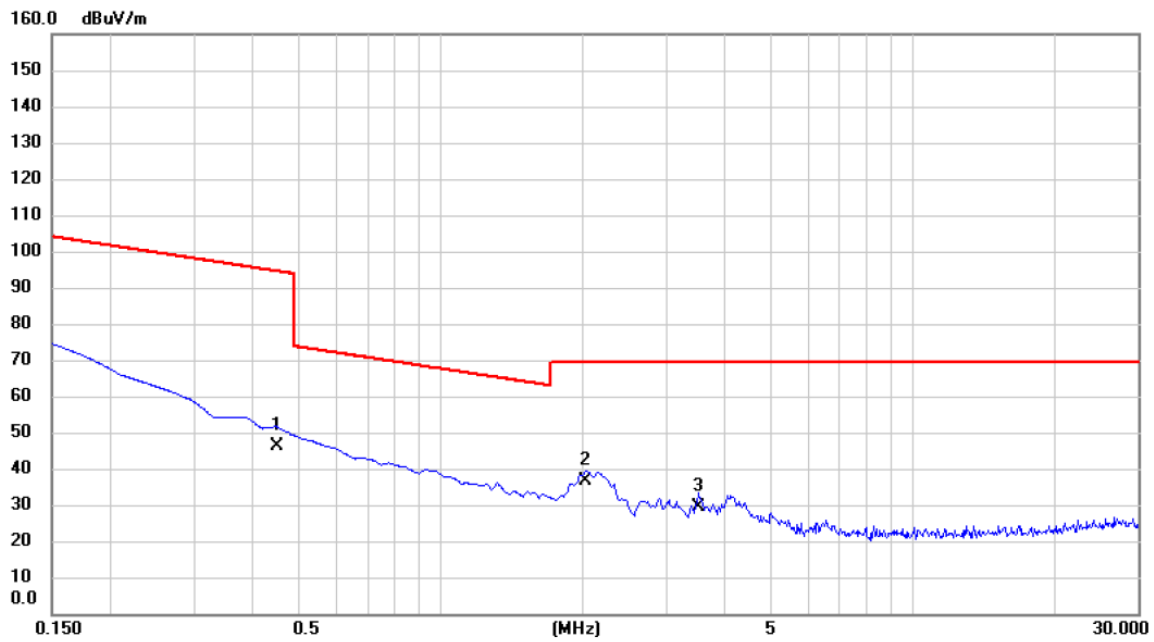

No.	Mk.	Freq.	Reading Level	Correct Factor	Measurement	Limit	Margin	Detector	Comment
		MHz	dBuV	dB	dBuV/m	dBuV/m	dB		
1		0.4485	34.21	11.93	46.14	94.57	-48.43	AVG	
2	*	2.0305	25.32	11.13	36.45	69.54	-33.09	QP	
3		3.5231	18.65	10.60	29.25	69.54	-40.29	QP	

REMARKS:

- (1) Measurement Value = Reading Level + Correct Factor.
- (2) Margin Level = Measurement Value - Limit Value.

Test Mode	TX Mode_3Mbps Channel 00	Polarization	Ant 90°
-----------	--------------------------	--------------	---------

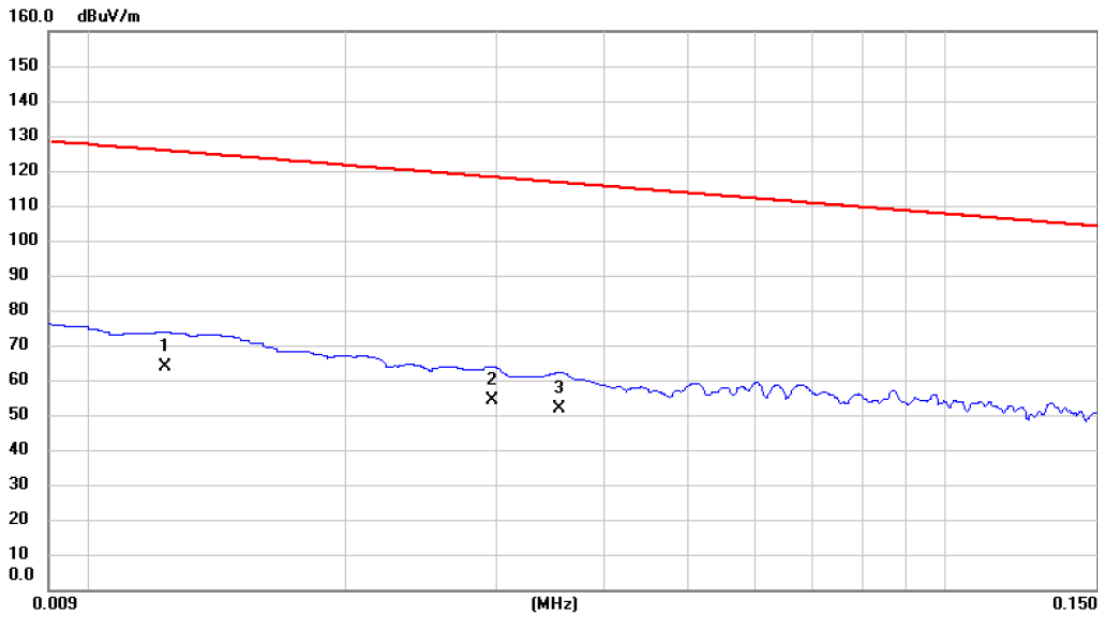

No.	Mk.	Freq.	Reading Level	Correct Factor	Measurement	Limit	Margin	Antenna Height	Table Degree	
		MHz	dBuV	dB	dBuV/m	dBuV/m	dB	cm	degree	Comment
1	*	0.0123	48.18	15.49	63.67	125.81	-62.14	AVG		
2		0.0296	41.32	12.84	54.16	118.18	-64.02	AVG		
3		0.0354	39.21	12.69	51.90	116.62	-64.72	AVG		

REMARKS:

- (1) Measurement Value = Reading Level + Correct Factor.
- (2) Margin Level = Measurement Value - Limit Value.

Test Mode	TX Mode_3Mbps Channel 00	Polarization	Ant 90°
-----------	--------------------------	--------------	---------

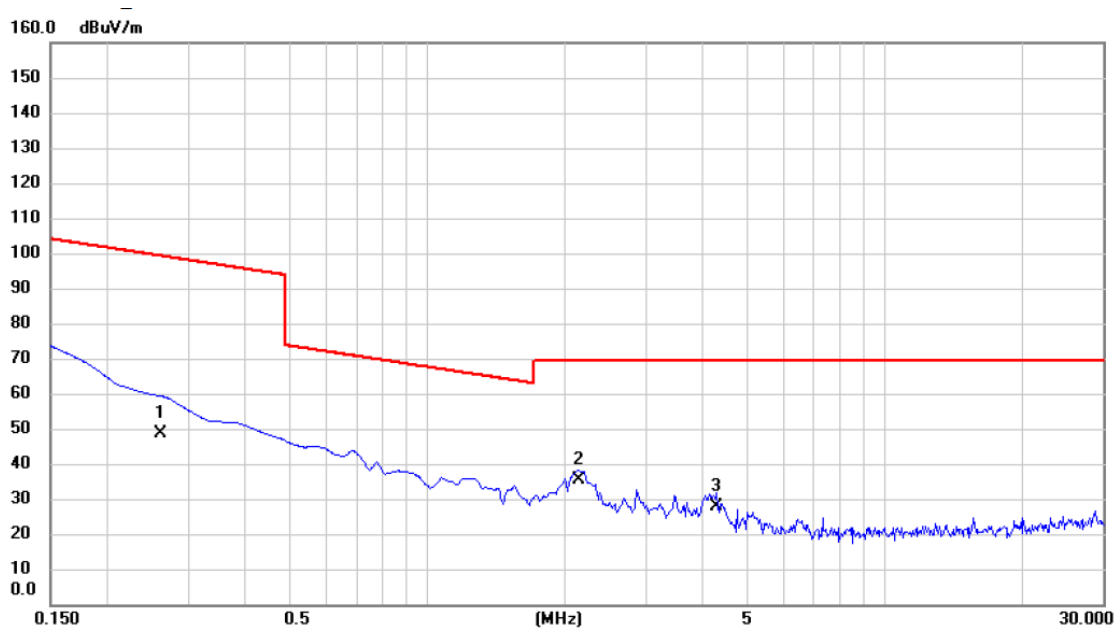

No.	Mk.	Freq.	Reading Level	Correct Factor	Measurement	Limit	Margin	Antenna Height	Table Degree	
		MHz	dBuV	dB	dBuV/m	dBuV/m	dB	cm	degree	Comment
1		0.2615	36.21	12.48	48.69	99.26	-50.57			AVG
2	*	2.1500	24.36	11.06	35.42	69.54	-34.12			QP
3		4.2991	17.26	10.67	27.93	69.54	-41.61			QP

REMARKS:

- (1) Measurement Value = Reading Level + Correct Factor.
- (2) Margin Level = Measurement Value - Limit Value.

APPENDIX C - RADIATED EMISSION - 30 MHZ TO 1000 MHZ

Test Mode	TX Mode_3Mbps Channel 00	Polarization	Vertical
-----------	--------------------------	--------------	----------

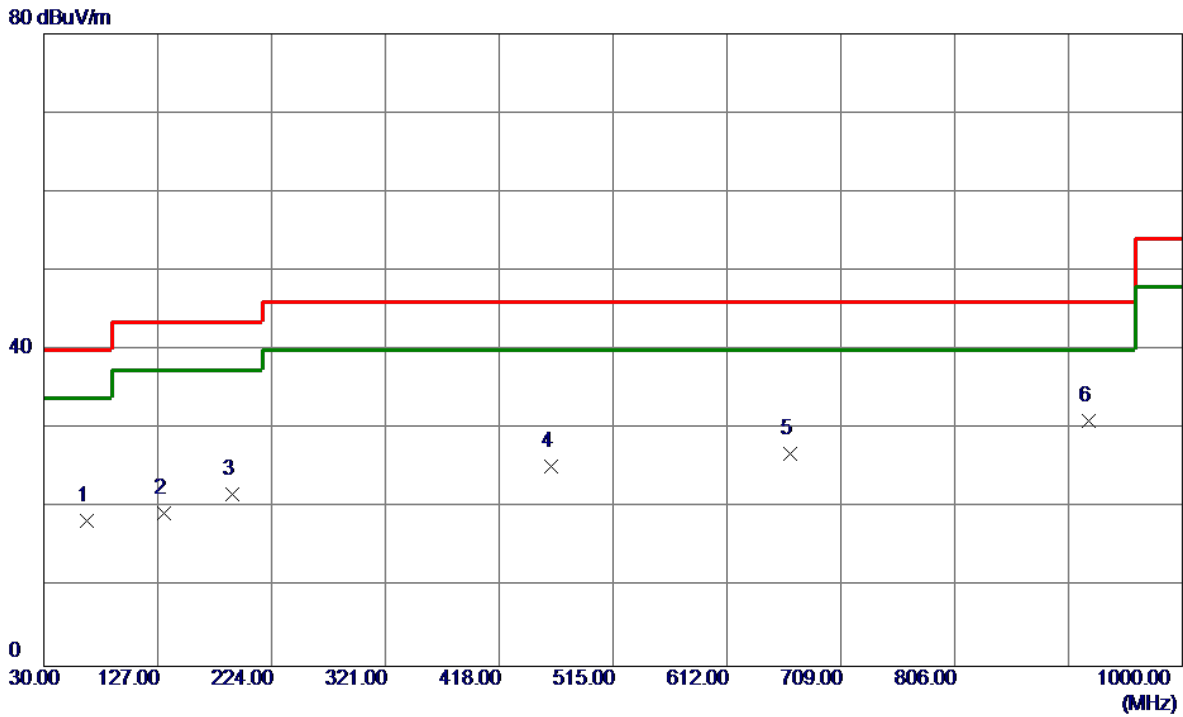

No.	Freq. MHz	Reading Level dBuV/m	Correct Factor dB	Measure ment dBuV/m	Limit dBuV/m	Margin dB	Detector	Comment
1	66.8600	34.05	-15.59	18.46	40.00	-21.54	Peak	
2	132.3350	32.73	-13.34	19.39	43.50	-24.11	Peak	
3	190.5350	36.87	-15.04	21.83	43.50	-21.67	Peak	
4	462.6200	32.68	-7.40	25.28	46.00	-20.72	Peak	
5	665.8350	30.61	-3.77	26.84	46.00	-19.16	Peak	
6 *	920.4600	30.18	0.79	30.97	46.00	-15.03	Peak	

REMARKS:

- (1) Measurement Value = Reading Level + Correct Factor.
- (2) Margin Level = Measurement Value - Limit Value.

Test Mode	TX Mode_3Mbps Channel 00	Polarization	Horizontal
-----------	--------------------------	--------------	------------

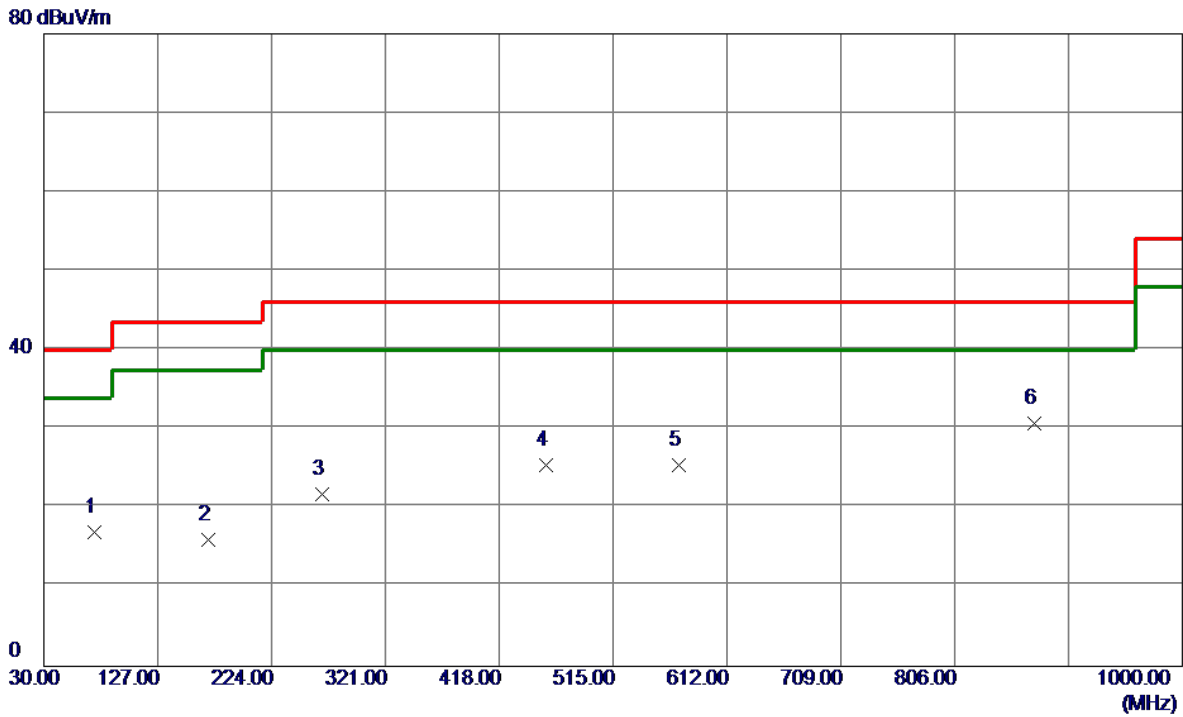

No.	Freq. MHz	Reading Level dBuV/m	Correct Factor dB	Measure ment dBuV/m	Limit dBuV/m	Margin dB	Detector	Comment
1	72.6800	33.85	-16.82	17.03	40.00	-22.97	Peak	
2	170.1649	28.68	-12.67	16.01	43.50	-27.49	Peak	
3	266.6800	34.21	-12.40	21.81	46.00	-24.19	Peak	
4	457.7700	32.97	-7.48	25.49	46.00	-20.51	Peak	
5	570.7750	31.10	-5.62	25.48	46.00	-20.52	Peak	
6 *	873.9000	30.98	-0.33	30.65	46.00	-15.35	Peak	

REMARKS:

- (1) Measurement Value = Reading Level + Correct Factor.
- (2) Margin Level = Measurement Value - Limit Value.

APPENDIX D - RADIATED EMISSION - ABOVE 1000 MHZ

Test Mode	TX 2402 MHz_CH00_1Mbps	Polarization	Vertical
-----------	------------------------	--------------	----------

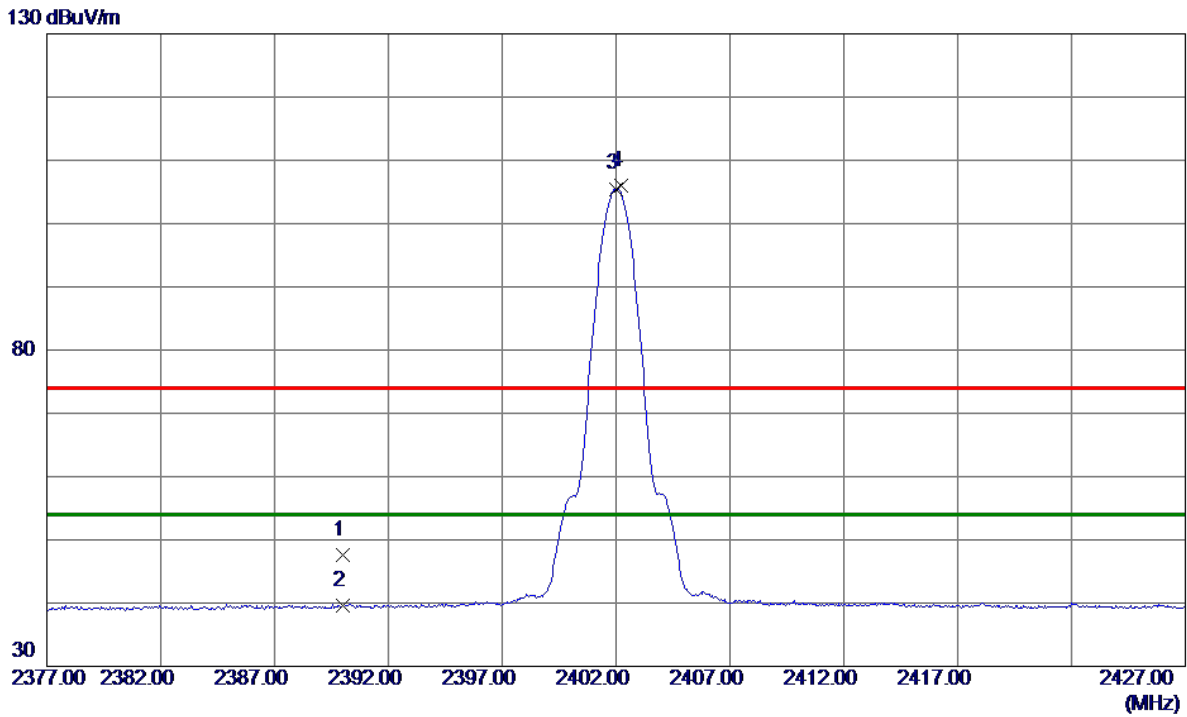

No.	Freq. MHz	Reading Level dBuV/m	Correct Factor dB	Measure ment dBuV/m	Limit dBuV/m	Margin dB	Detector	Comment
1	2390.0000	39.30	8.31	47.61	74.00	-26.39	Peak	
2	2390.0000	31.35	8.31	39.66	54.00	-14.34	AVG	
3 *	2402.0000	97.18	8.32	105.50	54.00	51.50	AVG	No Limit
4	2402.2000	97.58	8.32	105.90	74.00	31.90	Peak	No Limit

REMARKS:

- (1) Measurement Value = Reading Level + Correct Factor.
- (2) Margin Level = Measurement Value - Limit Value.

Test Mode	TX 2402 MHz_CH00_1Mbps	Polarization	Vertical
-----------	------------------------	--------------	----------

80 dBuV/m

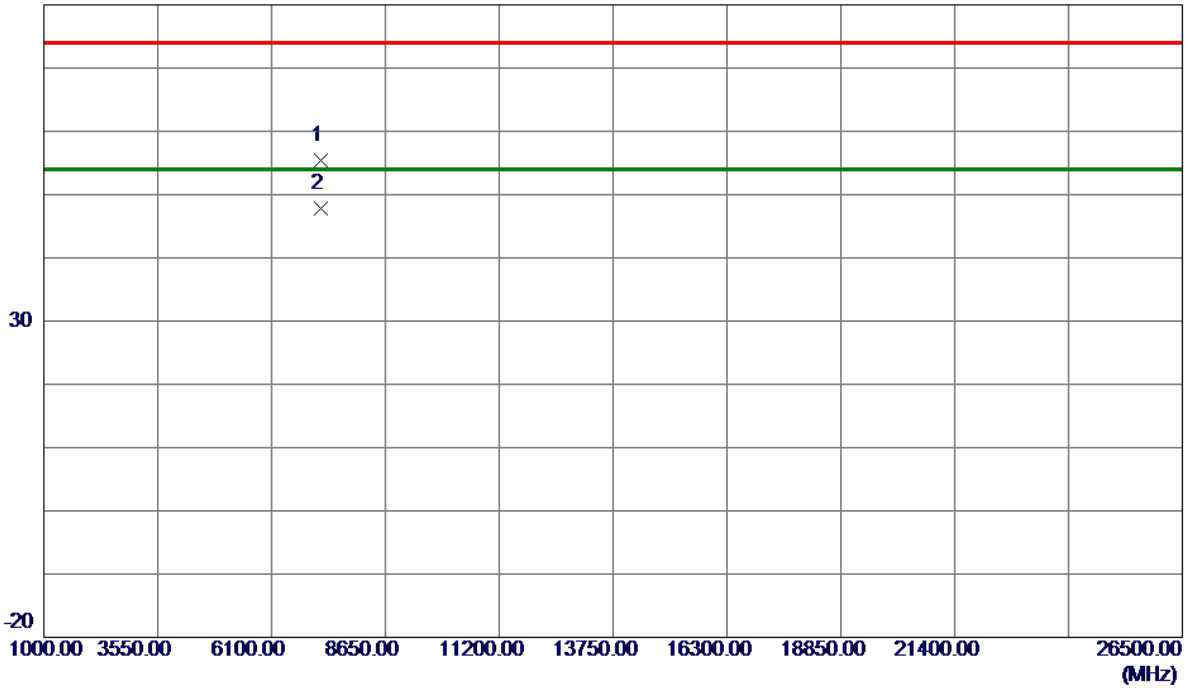

No.	Freq. MHz	Reading Level dBuV/m	Correct Factor dB	Measure ment dBuV/m	Limit dBuV/m	Margin dB	Detector	Comment
1	7206.0500	44.90	10.56	55.46	74.00	-18.54	Peak	
2 *	7206.1370	37.21	10.56	47.77	54.00	-6.23	AVG	

REMARKS:

- (1) Measurement Value = Reading Level + Correct Factor.
- (2) Margin Level = Measurement Value - Limit Value.

Test Mode	TX 2402 MHz_CH00_1Mbps	Polarization	Horizontal
-----------	------------------------	--------------	------------

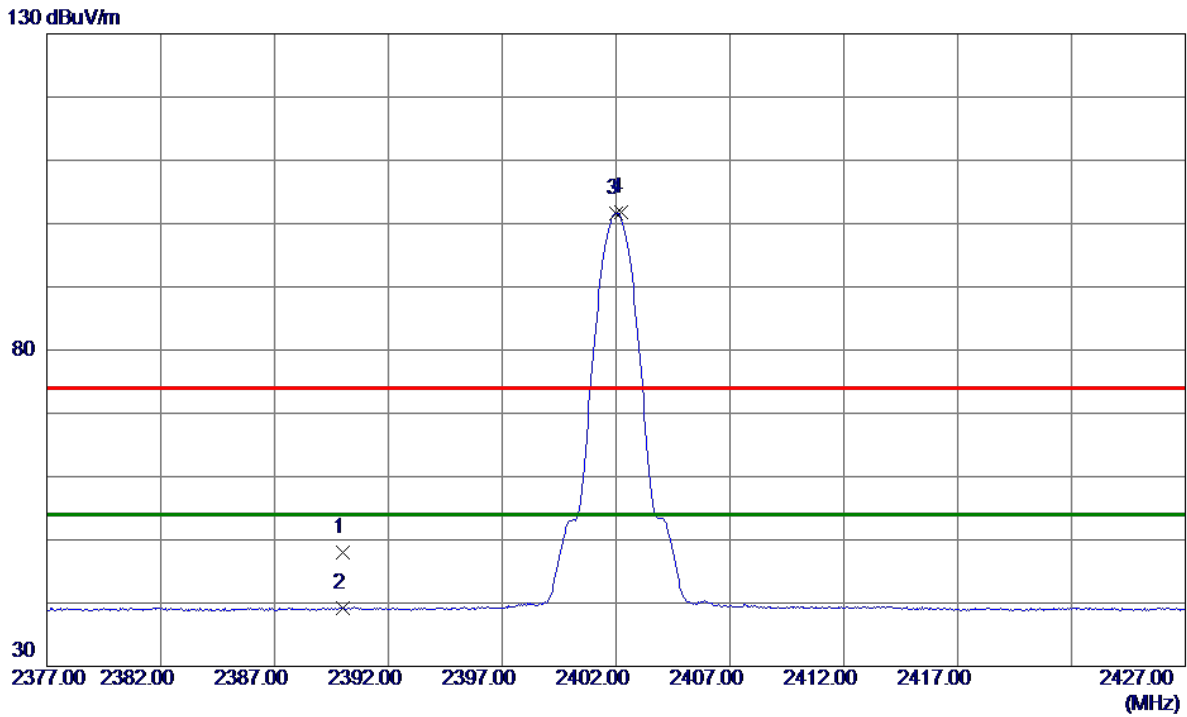

No.	Freq. MHz	Reading Level dBuV/m	Correct Factor dB	Measure ment dBuV/m	Limit dBuV/m	Margin dB	Detector	Comment
1	2390.0000	39.73	8.31	48.04	74.00	-25.96	Peak	
2	2390.0000	30.84	8.31	39.15	54.00	-14.85	AVG	
3 *	2402.0000	93.31	8.32	101.63	54.00	47.63	AVG	No Limit
4	2402.2000	93.57	8.32	101.89	74.00	27.89	Peak	No Limit

REMARKS:

- (1) Measurement Value = Reading Level + Correct Factor.
- (2) Margin Level = Measurement Value - Limit Value.

Test Mode	TX 2402 MHz_CH00_1Mbps	Polarization	Horizontal
-----------	------------------------	--------------	------------

80 dBuV/m

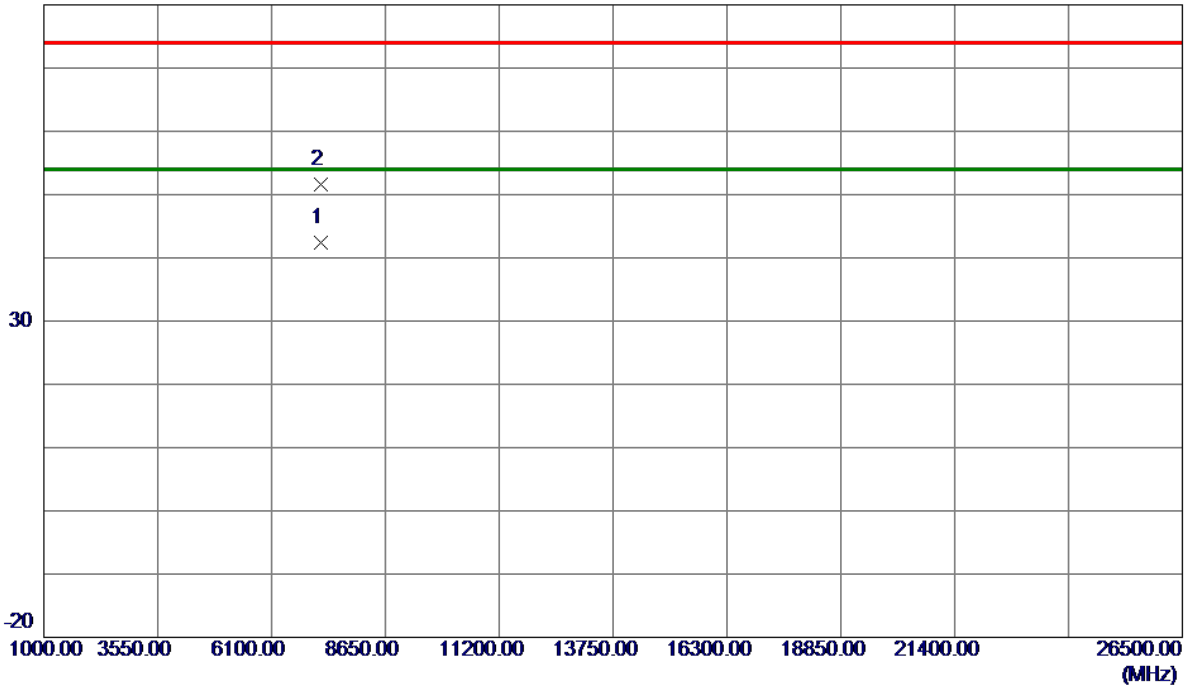

No.	Freq. MHz	Reading Level dBuV/m	Correct Factor dB	Measure ment dBuV/m	Limit dBuV/m	Margin dB	Detector	Comment
1 *	7205.9100	31.91	10.56	42.47	54.00	-11.53	AVG	
2	7206.2970	41.11	10.56	51.67	74.00	-22.33	Peak	

REMARKS:

- (1) Measurement Value = Reading Level + Correct Factor.
- (2) Margin Level = Measurement Value - Limit Value.

Test Mode	TX 2441 MHz_CH39_1Mbps	Polarization	Vertical
-----------	------------------------	--------------	----------

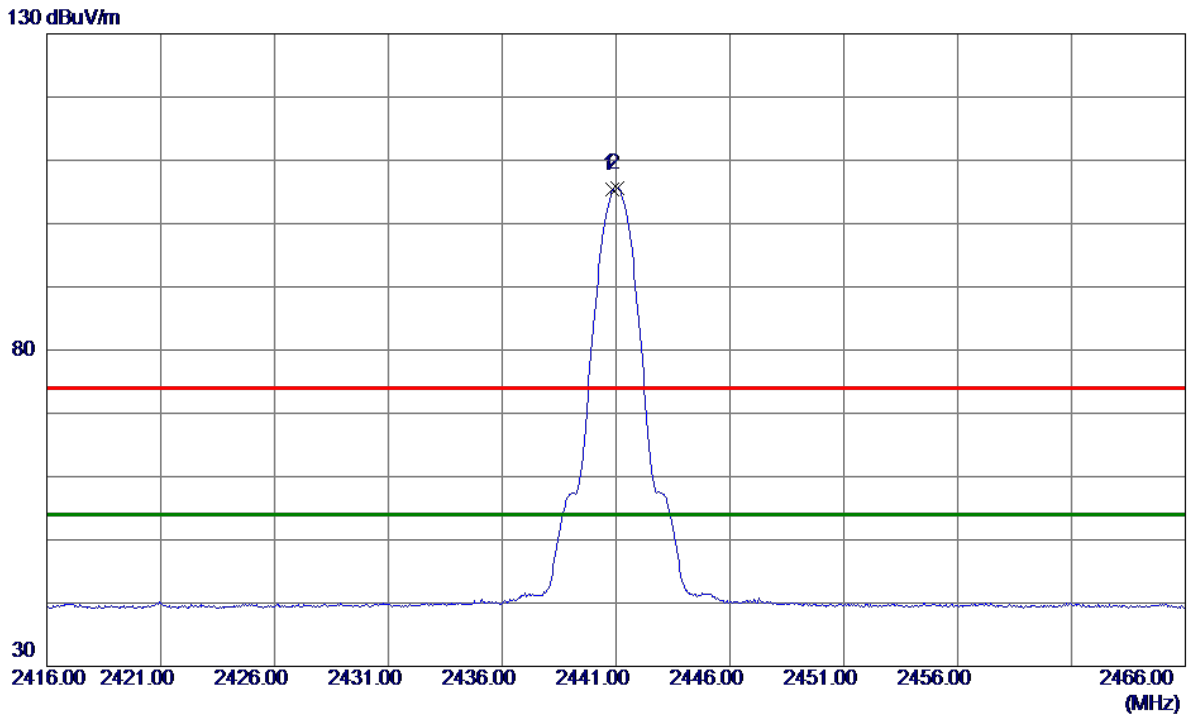

No.	Freq. MHz	Reading Level dBuV/m	Correct Factor dB	Measure ment dBuV/m	Limit dBuV/m	Margin dB	Detector	Comment
1	2440.8500	96.97	8.37	105.34	74.00	31.34	Peak	No Limit
2 *	2441.0500	97.29	8.37	105.66	54.00	51.66	AVG	No Limit

REMARKS:

- (1) Measurement Value = Reading Level + Correct Factor.
- (2) Margin Level = Measurement Value - Limit Value.

Test Mode	TX 2441 MHz _CH39_1Mbps	Polarization	Vertical
-----------	-------------------------	--------------	----------

80 dBuV/m

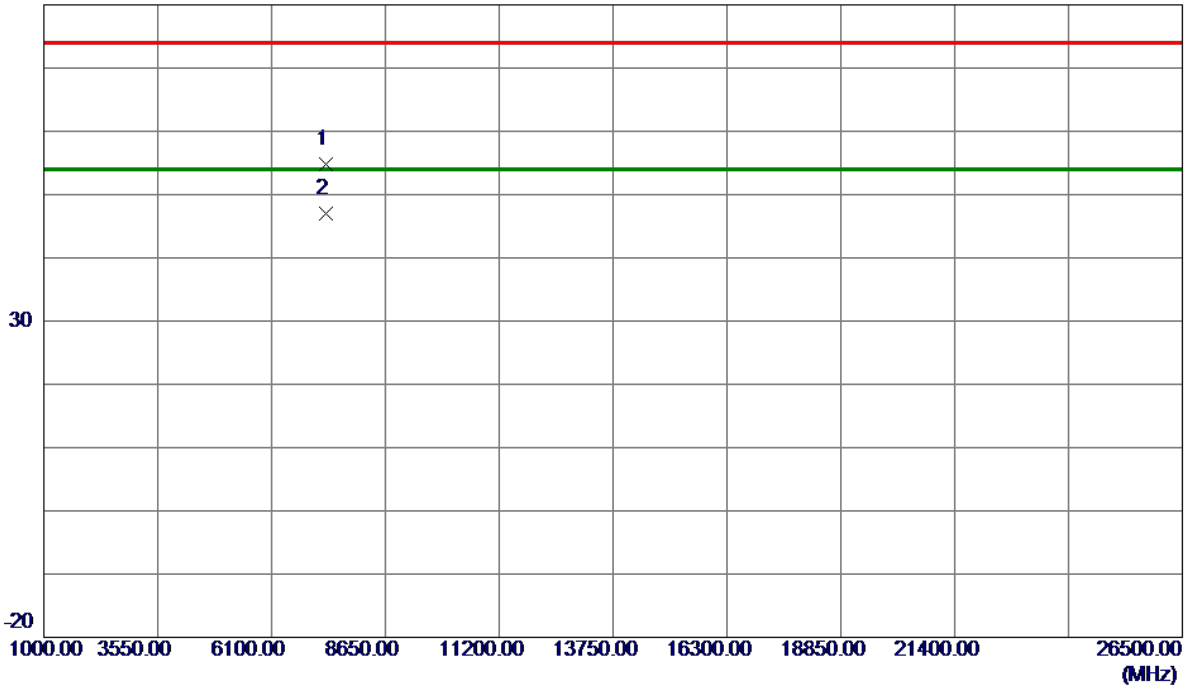

No.	Freq. MHz	Reading Level dBuV/m	Correct Factor dB	Measure ment dBuV/m	Limit dBuV/m	Margin dB	Detector	Comment
1	7322.5380	44.02	10.71	54.73	74.00	-19.27	Peak	
2 *	7322.9650	36.31	10.71	47.02	54.00	-6.98	AVG	

REMARKS:

- (1) Measurement Value = Reading Level + Correct Factor.
- (2) Margin Level = Measurement Value - Limit Value.

Test Mode	TX 2441 MHz _CH39_1Mbps	Polarization	Horizontal
-----------	-------------------------	--------------	------------

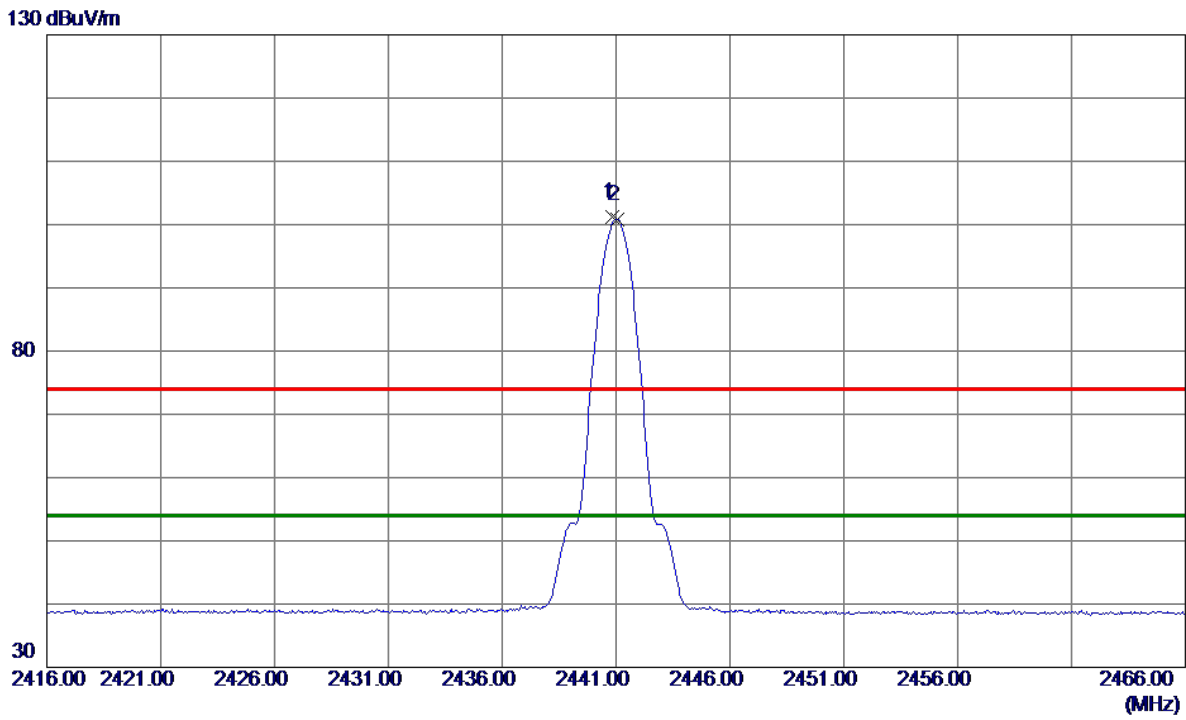

No.	Freq. MHz	Reading Level dBuV/m	Correct Factor dB	Measure ment dBuV/m	Limit dBuV/m	Margin dB	Detector	Comment
1	2440.8500	92.82	8.37	101.19	74.00	27.19	Peak	No Limit
2 *	2441.0500	92.42	8.37	100.79	54.00	46.79	AVG	No Limit

REMARKS:

- (1) Measurement Value = Reading Level + Correct Factor.
- (2) Margin Level = Measurement Value - Limit Value.

Test Mode	TX 2441 MHz _CH39_1Mbps	Polarization	Horizontal
-----------	-------------------------	--------------	------------

80 dBuV/m

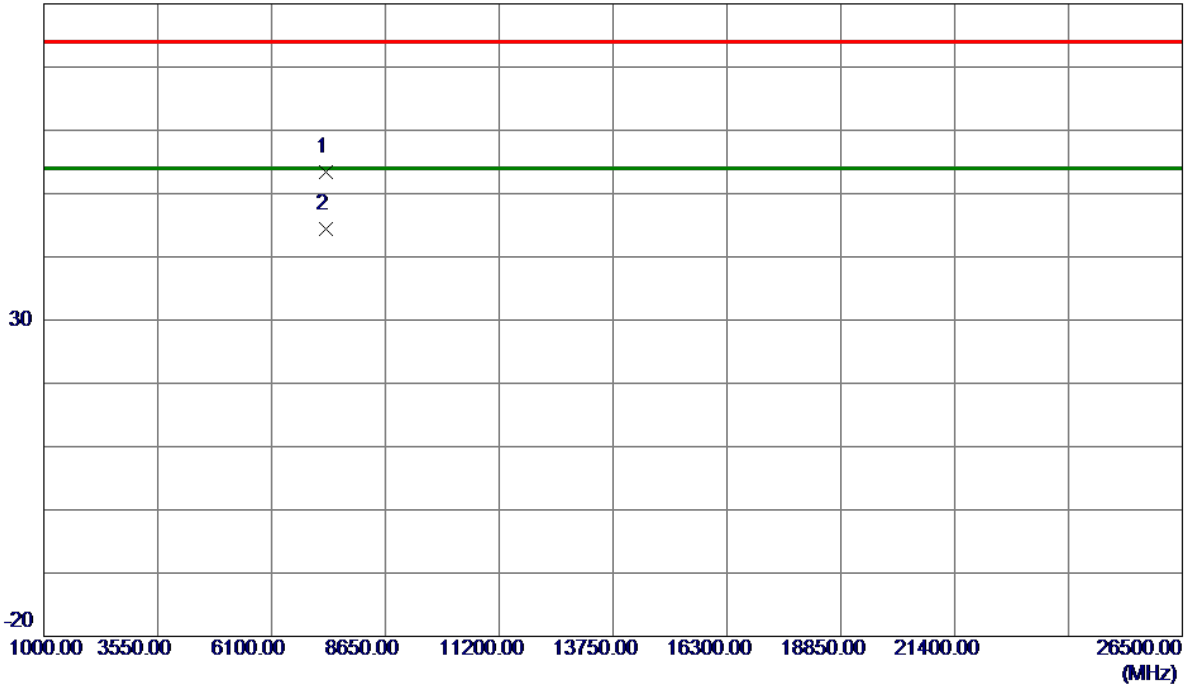

No.	Freq. MHz	Reading Level dBuV/m	Correct Factor dB	Measure ment dBuV/m	Limit dBuV/m	Margin dB	Detector	Comment
1	7322.6150	42.74	10.71	53.45	74.00	-20.55	Peak	
2 *	7322.9430	33.75	10.71	44.46	54.00	-9.54	AVG	

REMARKS:

- (1) Measurement Value = Reading Level + Correct Factor.
- (2) Margin Level = Measurement Value - Limit Value.

Test Mode	TX 2480 MHz_CH78_1Mbps	Polarization	Vertical
-----------	------------------------	--------------	----------

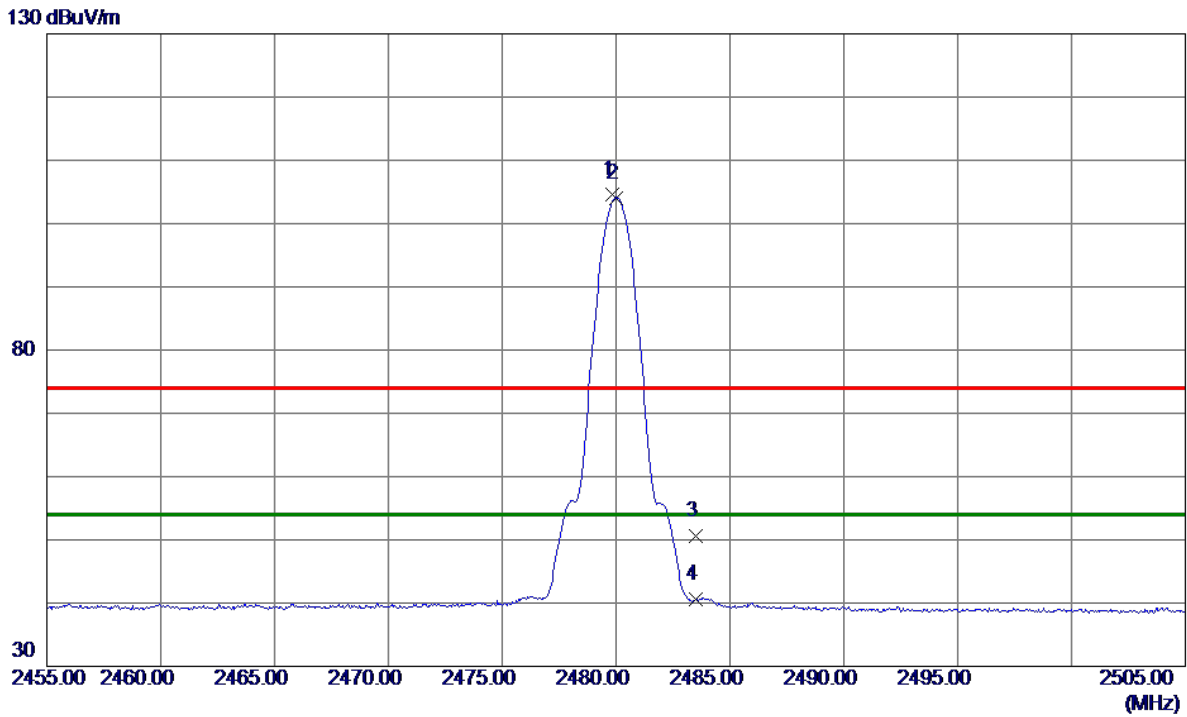

No.	Freq. MHz	Reading Level dBuV/m	Correct Factor dB	Measure ment dBuV/m	Limit dBuV/m	Margin dB	Detector	Comment
1	2479.8500	96.10	8.42	104.52	74.00	30.52	Peak	No Limit
2 *	2480.0000	95.68	8.42	104.10	54.00	50.10	AVG	No Limit
3	2483.5000	42.19	8.42	50.61	74.00	-23.39	Peak	
4	2483.5000	32.15	8.42	40.57	54.00	-13.43	AVG	

REMARKS:

- (1) Measurement Value = Reading Level + Correct Factor.
- (2) Margin Level = Measurement Value - Limit Value.

Test Mode	TX 2480 MHz _CH78_1Mbps	Polarization	Vertical
-----------	-------------------------	--------------	----------

80 dBuV/m

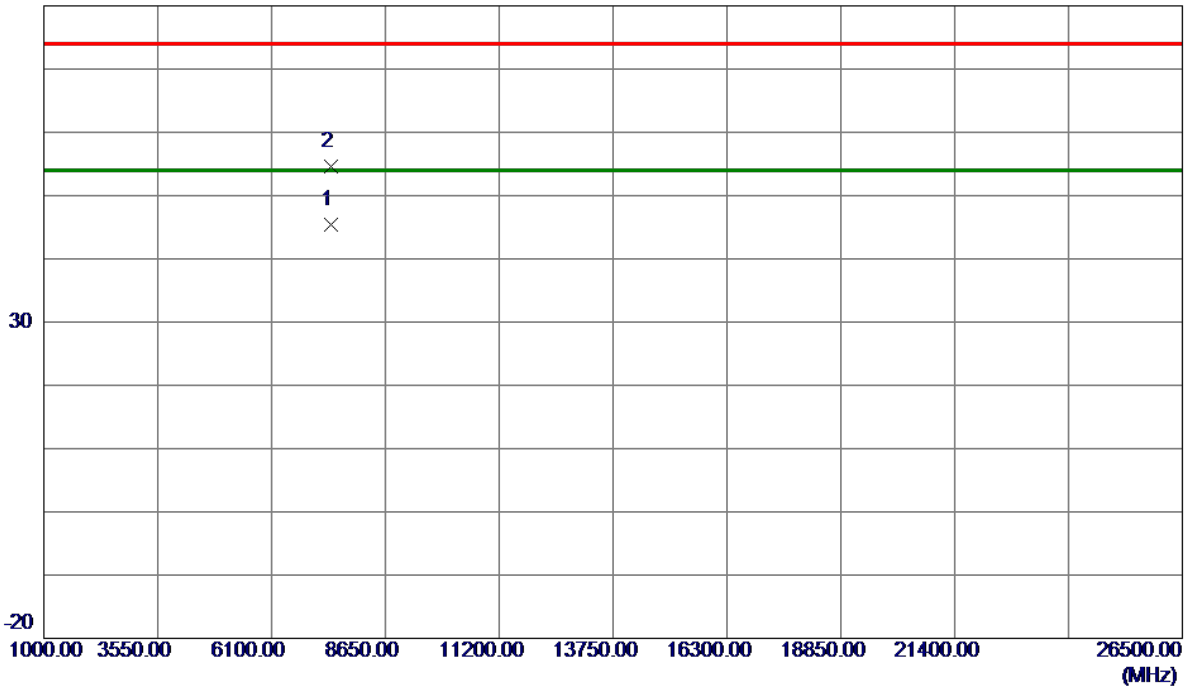

No.	Freq. MHz	Reading Level dBuV/m	Correct Factor dB	Measure ment dBuV/m	Limit dBuV/m	Margin dB	Detector	Comment
1 *	7439.9380	34.62	10.86	45.48	54.00	-8.52	AVG	
2	7440.4500	43.74	10.86	54.60	74.00	-19.40	Peak	

REMARKS:

- (1) Measurement Value = Reading Level + Correct Factor.
- (2) Margin Level = Measurement Value - Limit Value.

Test Mode	TX 2480 MHz _CH78_1Mbps	Polarization	Horizontal
-----------	-------------------------	--------------	------------

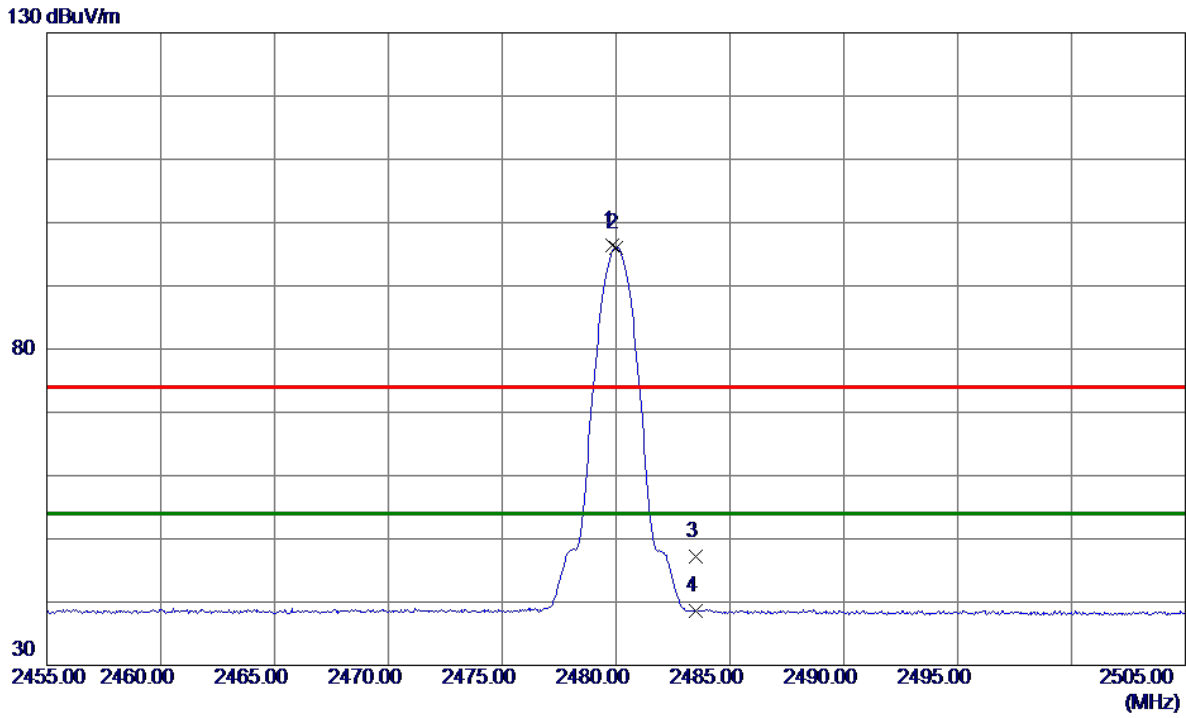

No.	Freq. MHz	Reading Level dBuV/m	Correct Factor dB	Measure ment dBuV/m	Limit dBuV/m	Margin dB	Detector	Comment
1	2479.8500	88.02	8.42	96.44	74.00	22.44	Peak	No Limit
2 *	2480.0000	87.61	8.42	96.03	54.00	42.03	AVG	No Limit
3	2483.5000	38.81	8.42	47.23	74.00	-26.77	Peak	
4	2483.5000	30.21	8.42	38.63	54.00	-15.37	AVG	

REMARKS:

- (1) Measurement Value = Reading Level + Correct Factor.
- (2) Margin Level = Measurement Value - Limit Value.

Test Mode	TX 2480 MHz _CH78_1Mbps	Polarization	Horizontal
-----------	-------------------------	--------------	------------

80 dBuV/m

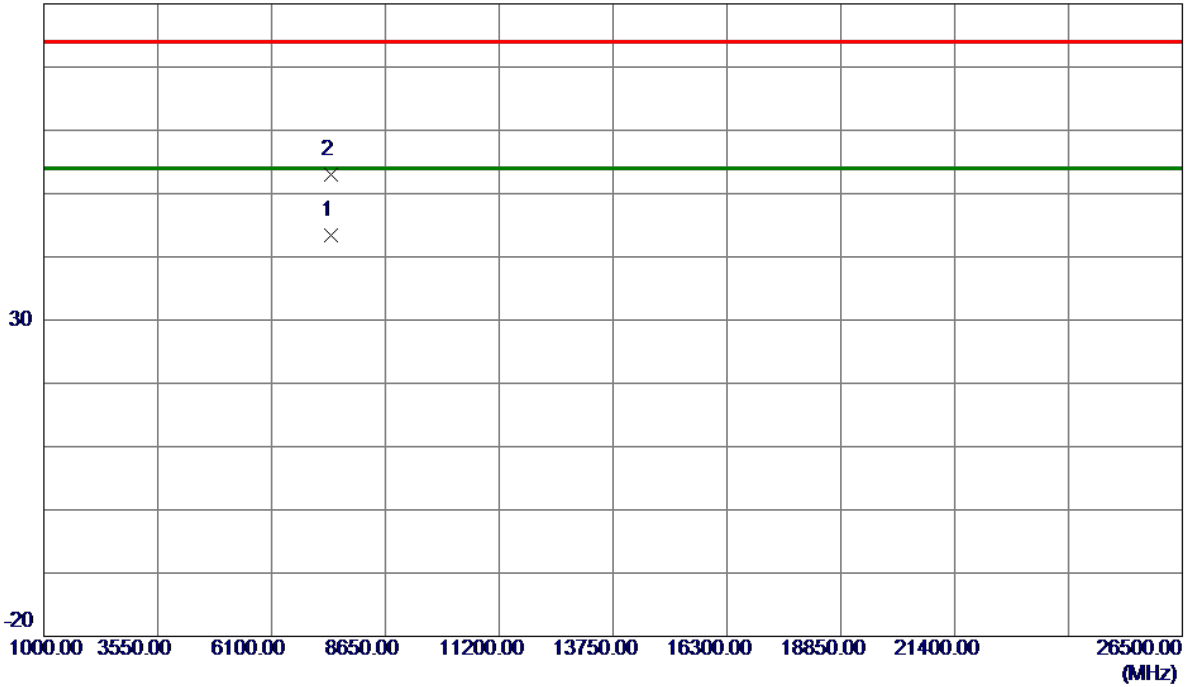

No.	Freq. MHz	Reading Level dBuV/m	Correct Factor dB	Measure ment dBuV/m	Limit dBuV/m	Margin dB	Detector	Comment
1 *	7440.0200	32.51	10.86	43.37	54.00	-10.63	AVG	
2	7440.0630	42.13	10.86	52.99	74.00	-21.01	Peak	

REMARKS:

- (1) Measurement Value = Reading Level + Correct Factor.
- (2) Margin Level = Measurement Value - Limit Value.

Test Mode	TX 2402 MHz_CH00_3Mbps	Polarization	Vertical
-----------	------------------------	--------------	----------

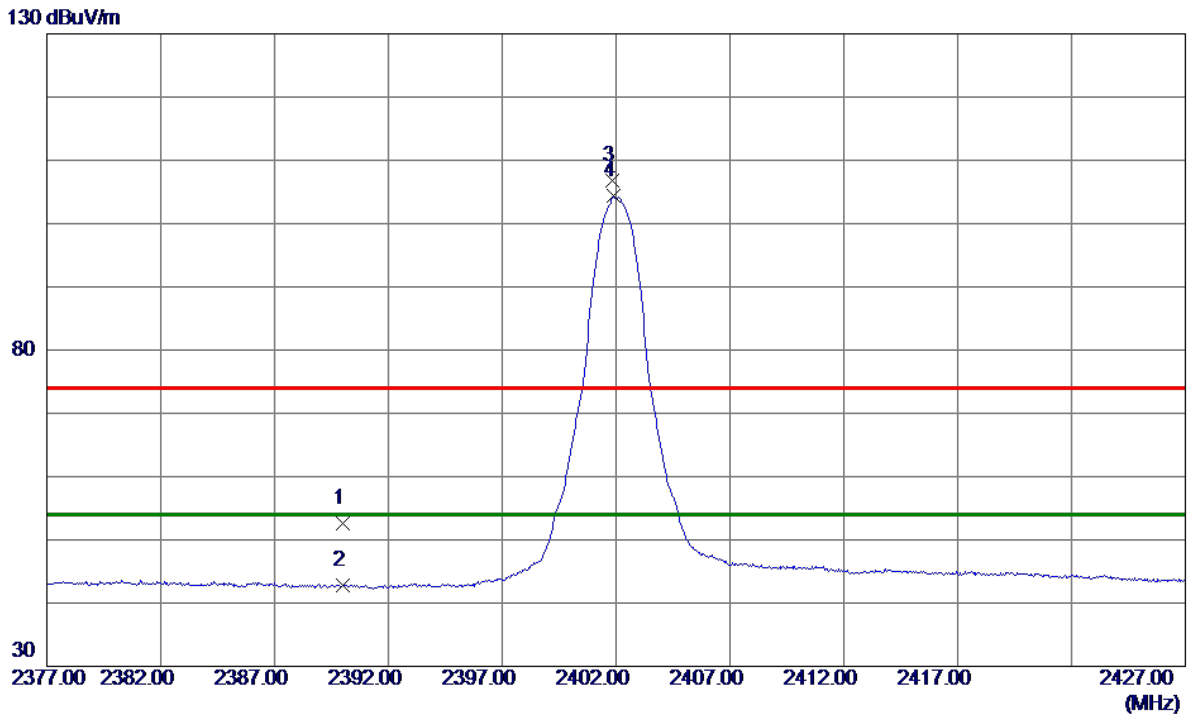

No.	Freq. MHz	Reading Level dBuV/m	Correct Factor dB	Measure ment dBuV/m	Limit dBuV/m	Margin dB	Detector	Comment
1	2390.0000	44.33	8.31	52.64	74.00	-21.36	Peak	
2	2390.0000	34.46	8.31	42.77	54.00	-11.23	AVG	
3	2401.8500	98.40	8.32	106.72	74.00	32.72	Peak	No Limit
4 *	2401.9000	96.06	8.32	104.38	54.00	50.38	AVG	No Limit

REMARKS:

- (1) Measurement Value = Reading Level + Correct Factor.
- (2) Margin Level = Measurement Value - Limit Value.

Test Mode	TX 2402 MHz_CH00_3Mbps	Polarization	Vertical
-----------	------------------------	--------------	----------

80 dBuV/m

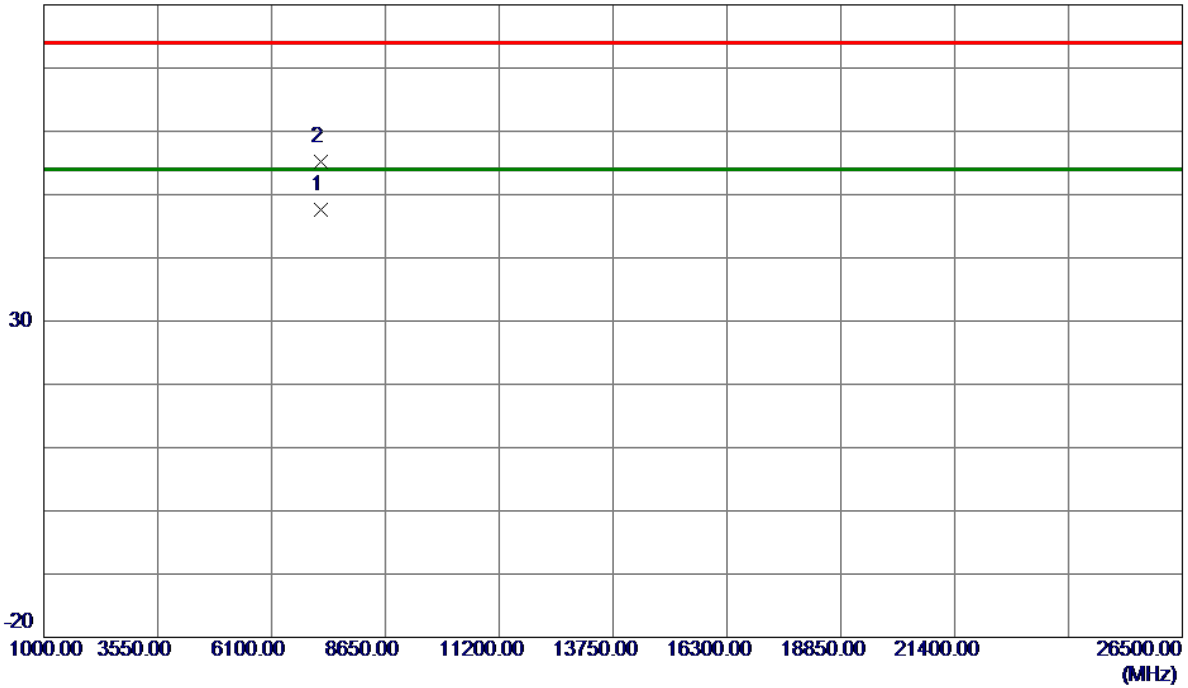

No.	Freq. MHz	Reading Level dBuV/m	Correct Factor dB	Measure ment dBuV/m	Limit dBuV/m	Margin dB	Detector	Comment
1 *	7206.1020	37.03	10.56	47.59	54.00	-6.41	AVG	
2	7206.2850	44.57	10.56	55.13	74.00	-18.87	Peak	

REMARKS:

- (1) Measurement Value = Reading Level + Correct Factor.
- (2) Margin Level = Measurement Value - Limit Value.

Test Mode	TX 2402 MHz_CH00_3Mbps	Polarization	Horizontal
-----------	------------------------	--------------	------------

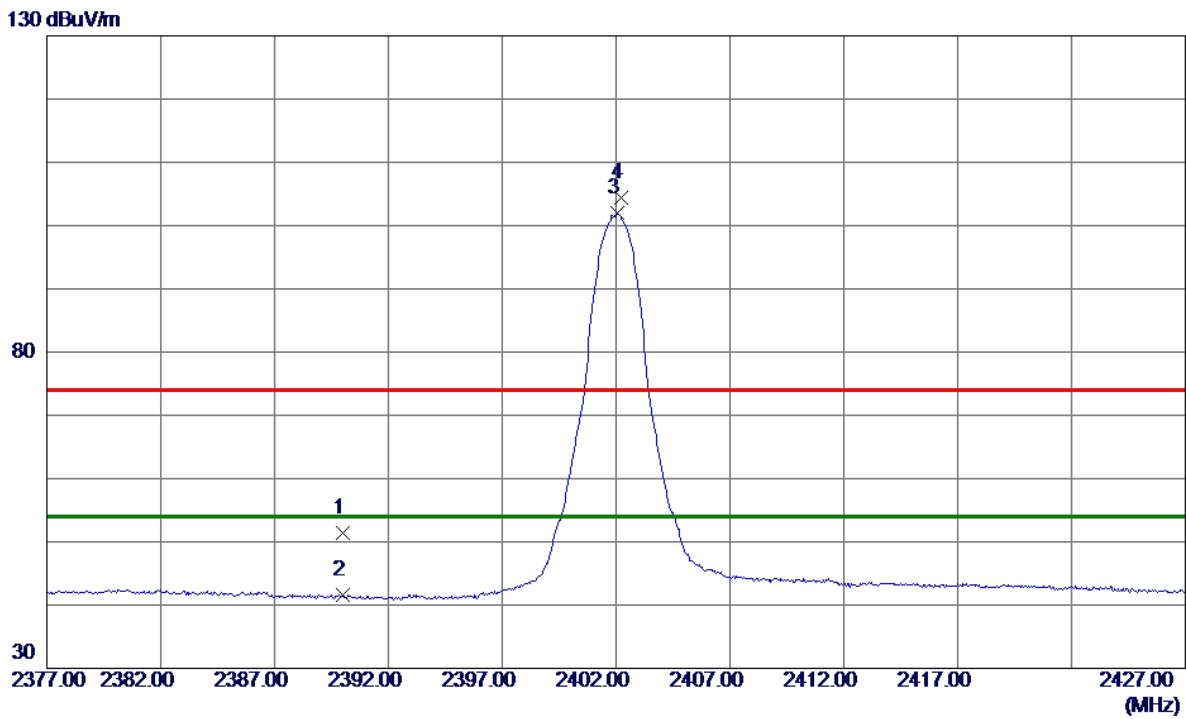

No.	Freq. MHz	Reading Level dBuV/m	Correct Factor dB	Measure ment dBuV/m	Limit dBuV/m	Margin dB	Detector	Comment
1	2390.0000	43.15	8.31	51.46	74.00	-22.54	Peak	
2	2390.0000	33.20	8.31	41.51	54.00	-12.49	AVG	
3 *	2402.0500	93.74	8.32	102.06	54.00	48.06	AVG	No Limit
4	2402.2000	96.02	8.32	104.34	74.00	30.34	Peak	No Limit

REMARKS:

- (1) Measurement Value = Reading Level + Correct Factor.
- (2) Margin Level = Measurement Value - Limit Value.

Test Mode	TX 2402 MHz_CH00_3Mbps	Polarization	Horizontal
-----------	------------------------	--------------	------------

80 dBuV/m

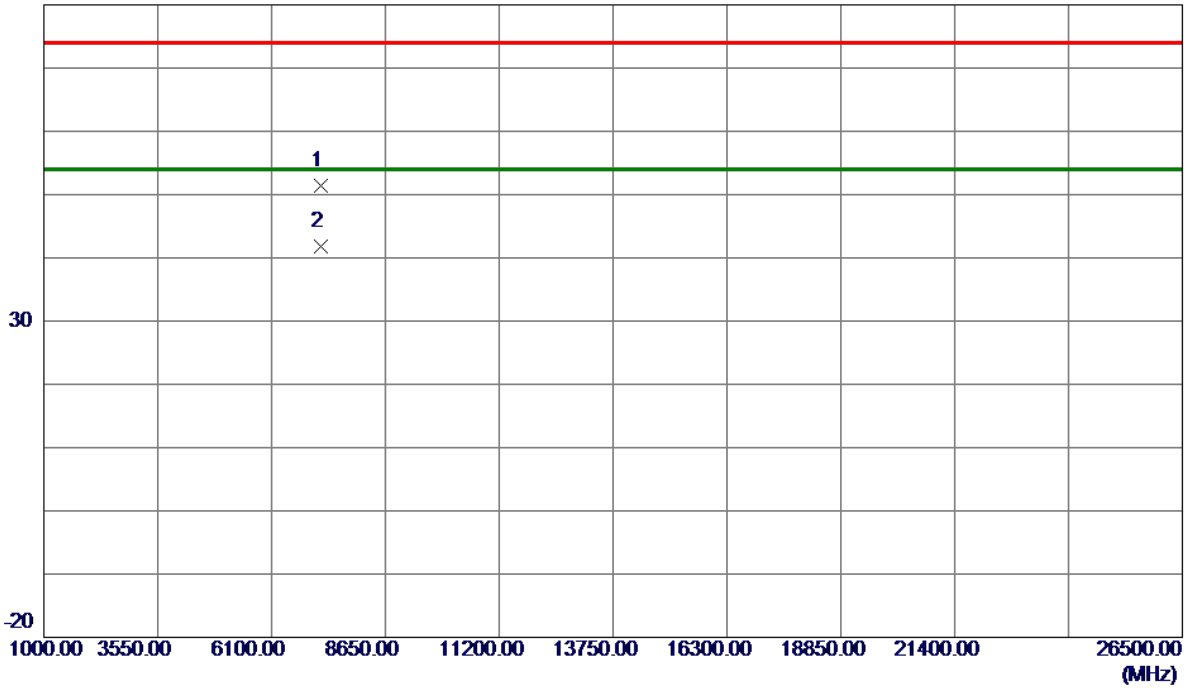

No.	Freq. MHz	Reading Level dBuV/m	Correct Factor dB	Measure ment dBuV/m	Limit dBuV/m	Margin dB	Detector	Comment
1	7205.2550	40.83	10.56	51.39	74.00	-22.61	Peak	
2 *	7205.8850	31.18	10.56	41.74	54.00	-12.26	AVG	

REMARKS:

- (1) Measurement Value = Reading Level + Correct Factor.
- (2) Margin Level = Measurement Value - Limit Value.

Test Mode	TX 2441 MHz_CH39_3Mbps	Polarization	Vertical
-----------	------------------------	--------------	----------

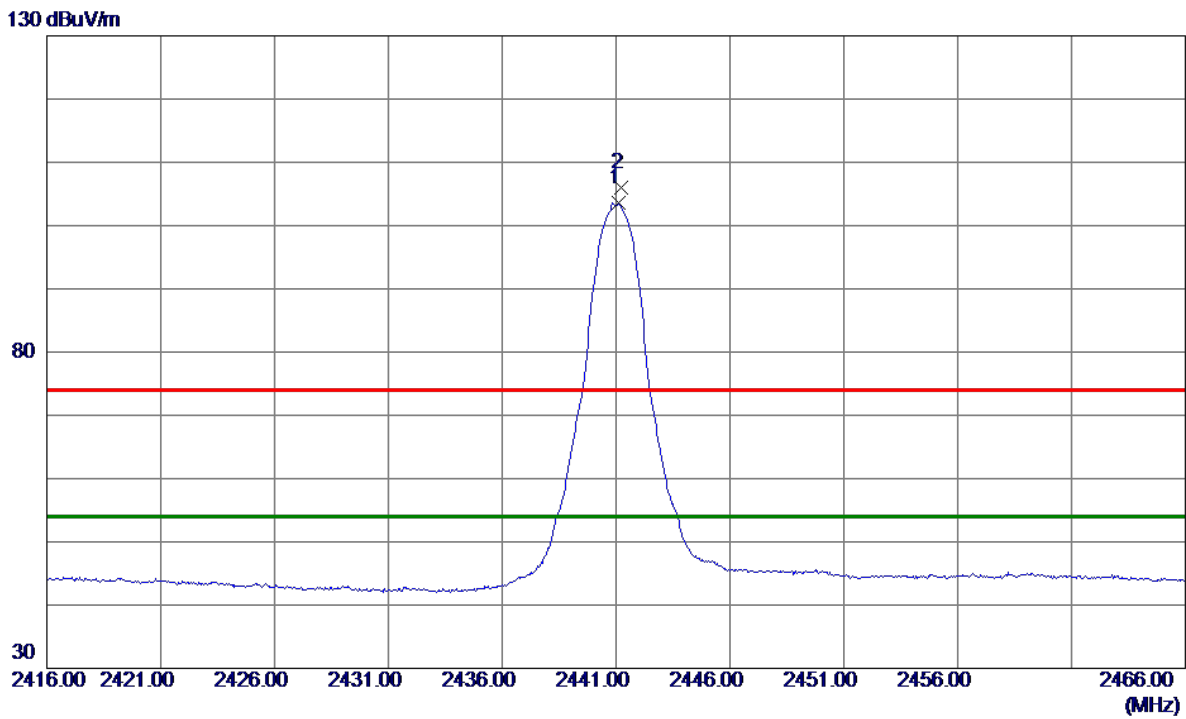

No.	Freq. MHz	Reading Level dBuV/m	Correct Factor dB	Measure ment dBuV/m	Limit dBuV/m	Margin dB	Detector	Comment
1 *	2441.1000	95.19	8.37	103.56	54.00	49.56	AVG	No Limit
2	2441.2000	97.58	8.37	105.95	74.00	31.95	Peak	No Limit

REMARKS:

- (1) Measurement Value = Reading Level + Correct Factor.
- (2) Margin Level = Measurement Value - Limit Value.

Test Mode	TX 2441 MHz _CH39_3Mbps	Polarization	Vertical
-----------	-------------------------	--------------	----------

80 dBuV/m

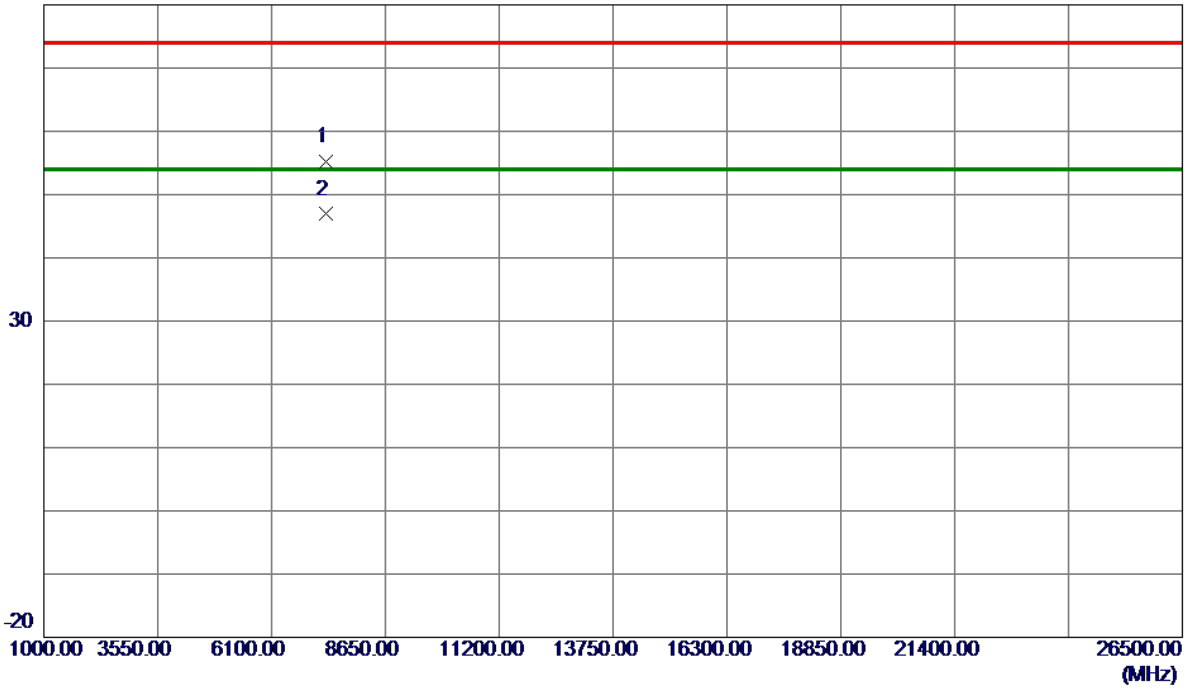

No.	Freq. MHz	Reading Level dBuV/m	Correct Factor dB	Measure ment dBuV/m	Limit dBuV/m	Margin dB	Detector	Comment
1	7322.6350	44.57	10.71	55.28	74.00	-18.72	Peak	
2 *	7323.1180	36.19	10.71	46.90	54.00	-7.10	AVG	

REMARKS:

- (1) Measurement Value = Reading Level + Correct Factor.
- (2) Margin Level = Measurement Value - Limit Value.

Test Mode	TX 2441 MHz _CH39_3Mbps	Polarization	Horizontal
-----------	-------------------------	--------------	------------

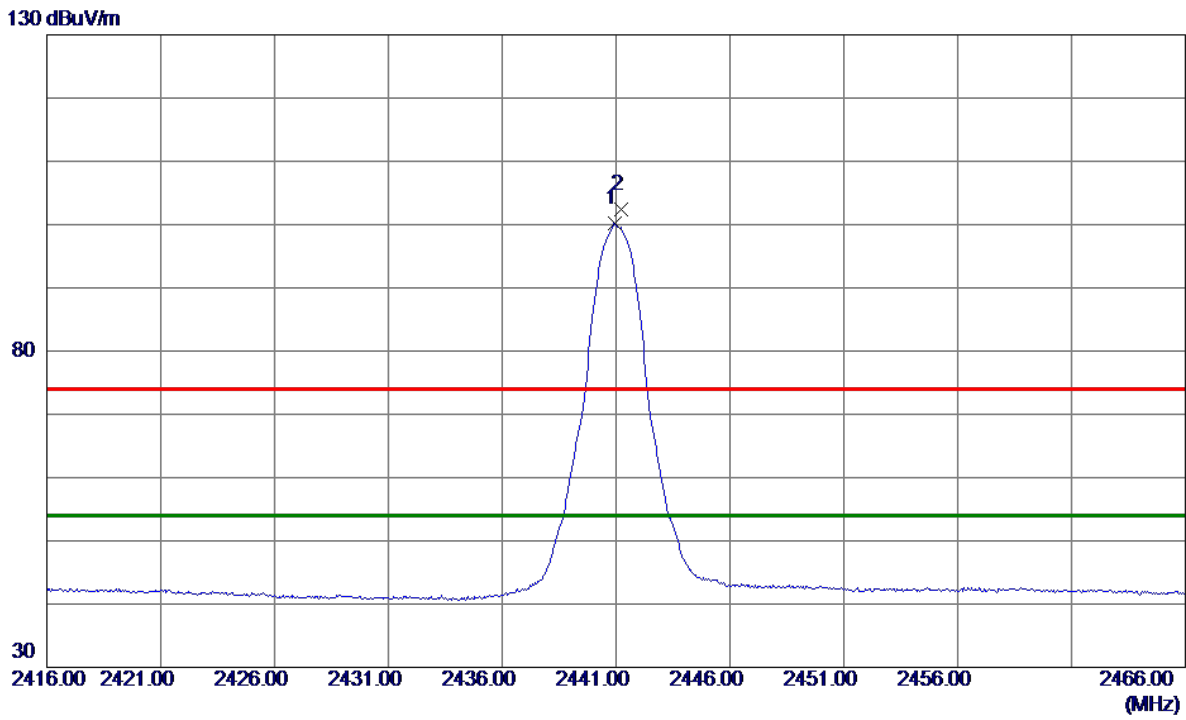

No.	Freq. MHz	Reading Level dBuV/m	Correct Factor dB	Measure ment dBuV/m	Limit dBuV/m	Margin dB	Detector	Comment
1 *	2440.9500	91.86	8.37	100.23	54.00	46.23	AVG	No Limit
2	2441.2000	94.01	8.37	102.38	74.00	28.38	Peak	No Limit

REMARKS:

- (1) Measurement Value = Reading Level + Correct Factor.
- (2) Margin Level = Measurement Value - Limit Value.

Test Mode	TX 2441 MHz _CH39_3Mbps	Polarization	Horizontal
-----------	-------------------------	--------------	------------

80 dBuV/m

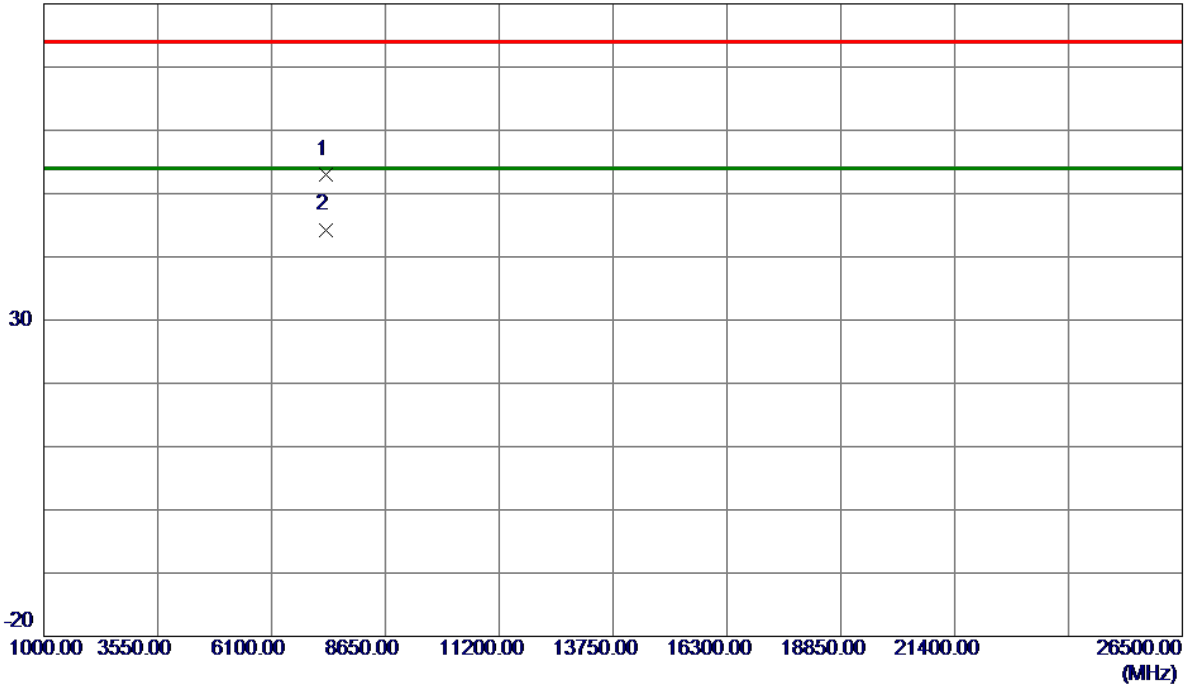

No.	Freq. MHz	Reading Level dBuV/m	Correct Factor dB	Measure ment dBuV/m	Limit dBuV/m	Margin dB	Detector	Comment
1	7322.4750	42.24	10.71	52.95	74.00	-21.05	Peak	
2 *	7322.9980	33.59	10.71	44.30	54.00	-9.70	AVG	

REMARKS:

- (1) Measurement Value = Reading Level + Correct Factor.
- (2) Margin Level = Measurement Value - Limit Value.

Test Mode	TX 2480 MHz_CH78_3Mbps	Polarization	Vertical
-----------	------------------------	--------------	----------

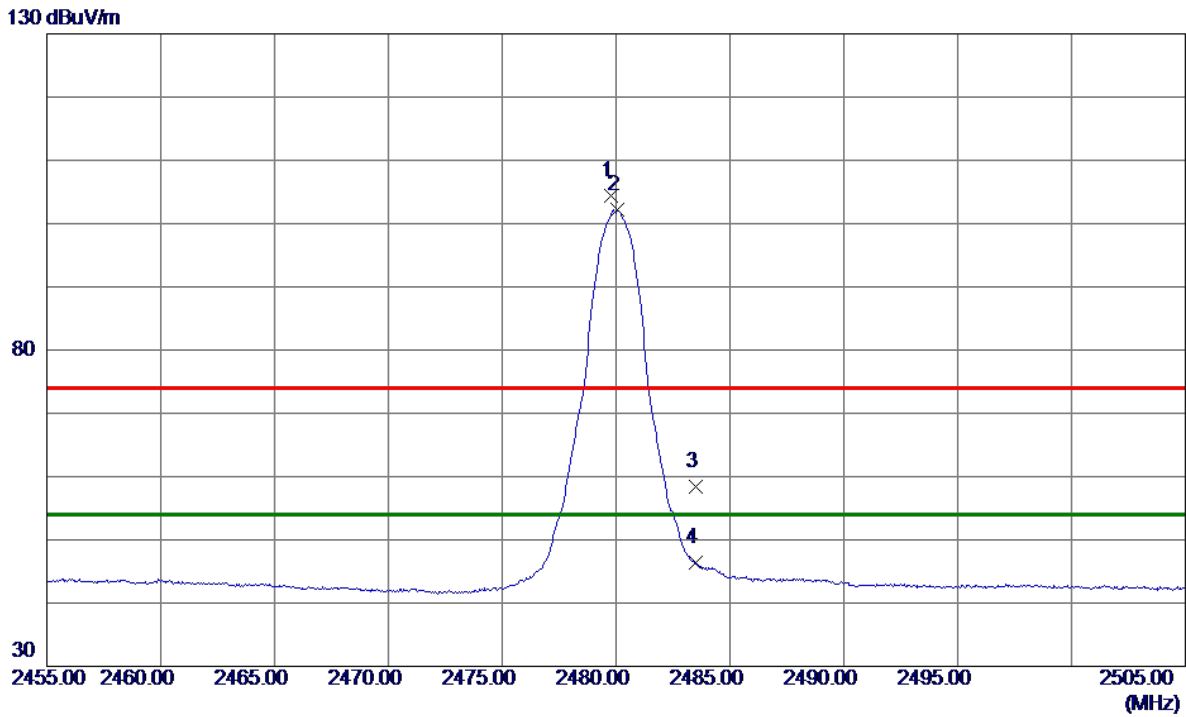

No.	Freq. MHz	Reading Level dBuV/m	Correct Factor dB	Measure ment dBuV/m	Limit dBuV/m	Margin dB	Detector	Comment
1	2479.8000	96.02	8.42	104.44	74.00	30.44	Peak	No Limit
2 *	2480.0500	93.81	8.42	102.23	54.00	48.23	AVG	No Limit
3	2483.5000	49.98	8.42	58.40	74.00	-15.60	Peak	
4	2483.5000	38.02	8.42	46.44	54.00	-7.56	AVG	

REMARKS:

- (1) Measurement Value = Reading Level + Correct Factor.
- (2) Margin Level = Measurement Value - Limit Value.

Test Mode	TX 2480 MHz _CH78_3Mbps	Polarization	Vertical
-----------	-------------------------	--------------	----------

80 dBuV/m

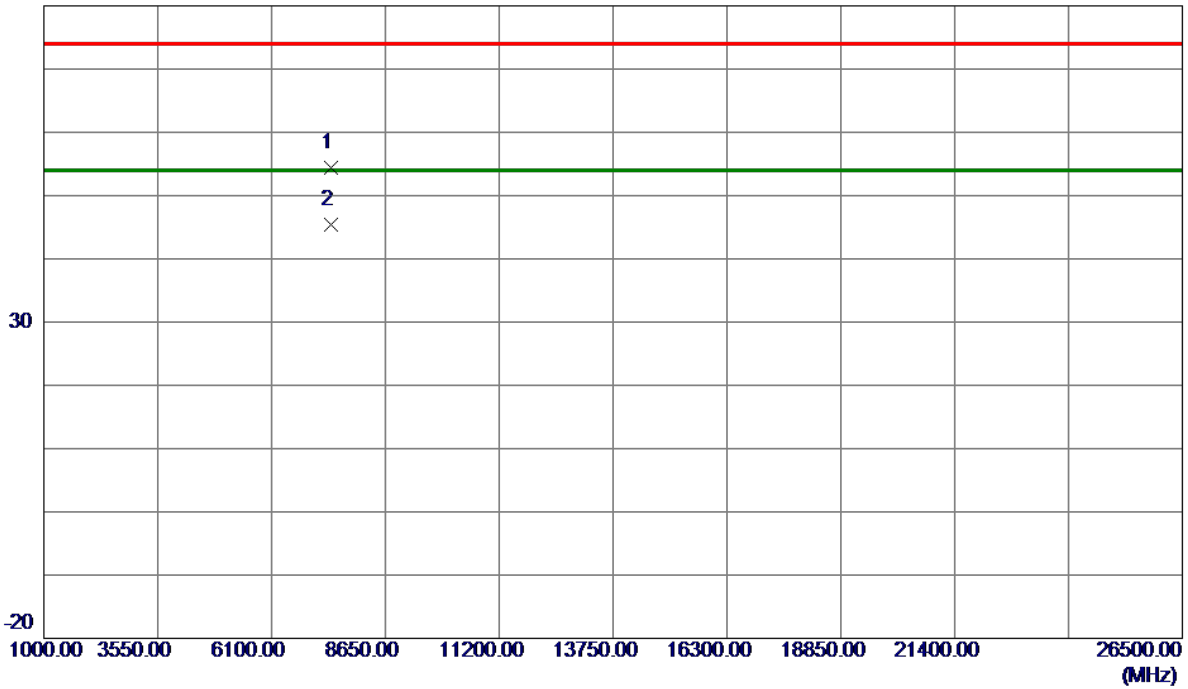

No.	Freq. MHz	Reading Level dBuV/m	Correct Factor dB	Measure ment dBuV/m	Limit dBuV/m	Margin dB	Detector	Comment
1	7439.5920	43.55	10.86	54.41	74.00	-19.59	Peak	
2 *	7440.0630	34.51	10.86	45.37	54.00	-8.63	AVG	

REMARKS:

- (1) Measurement Value = Reading Level + Correct Factor.
- (2) Margin Level = Measurement Value - Limit Value.

Test Mode	TX 2480 MHz _CH78_3Mbps	Polarization	Horizontal
-----------	-------------------------	--------------	------------

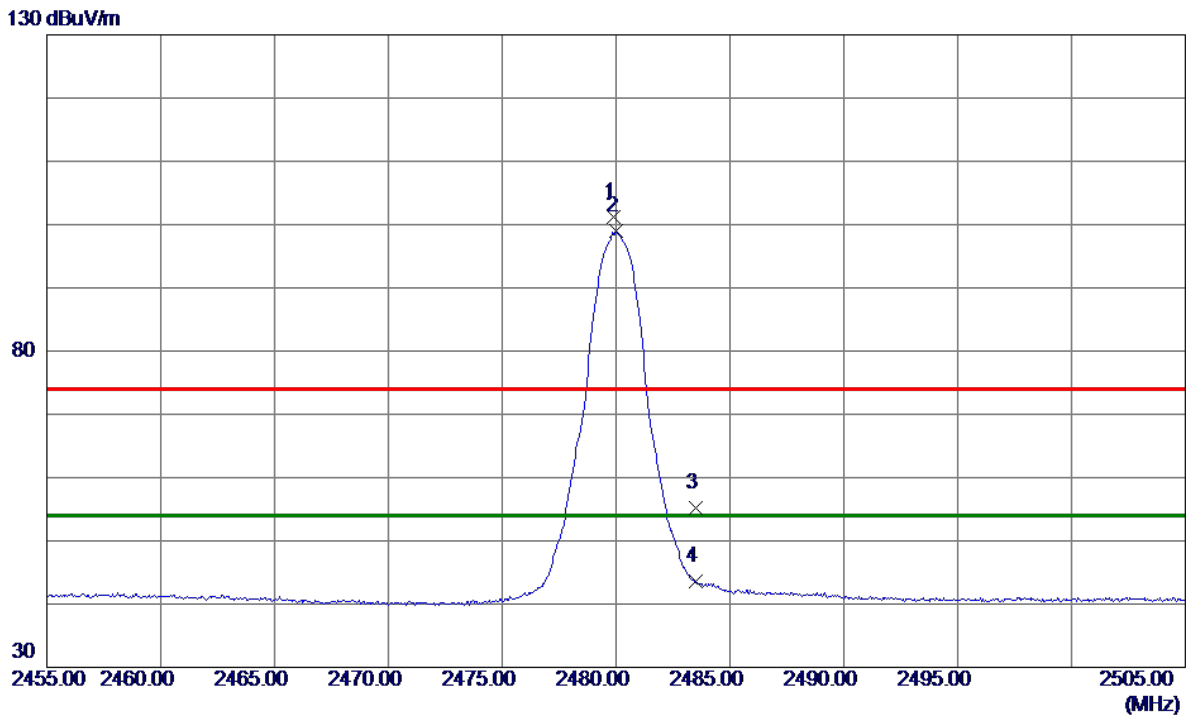

No.	Freq. MHz	Reading Level dBuV/m	Correct Factor dB	Measure ment dBuV/m	Limit dBuV/m	Margin dB	Detector	Comment
1	2479.9000	92.70	8.42	101.12	74.00	27.12	Peak	No Limit
2 *	2480.0000	90.55	8.42	98.97	54.00	44.97	AVG	No Limit
3	2483.5000	46.83	8.42	55.25	74.00	-18.75	Peak	
4	2483.5000	35.20	8.42	43.62	54.00	-10.38	AVG	

REMARKS:

- (1) Measurement Value = Reading Level + Correct Factor.
- (2) Margin Level = Measurement Value - Limit Value.

Test Mode	TX 2480 MHz _CH78_3Mbps	Polarization	Horizontal
-----------	-------------------------	--------------	------------

80 dBuV/m

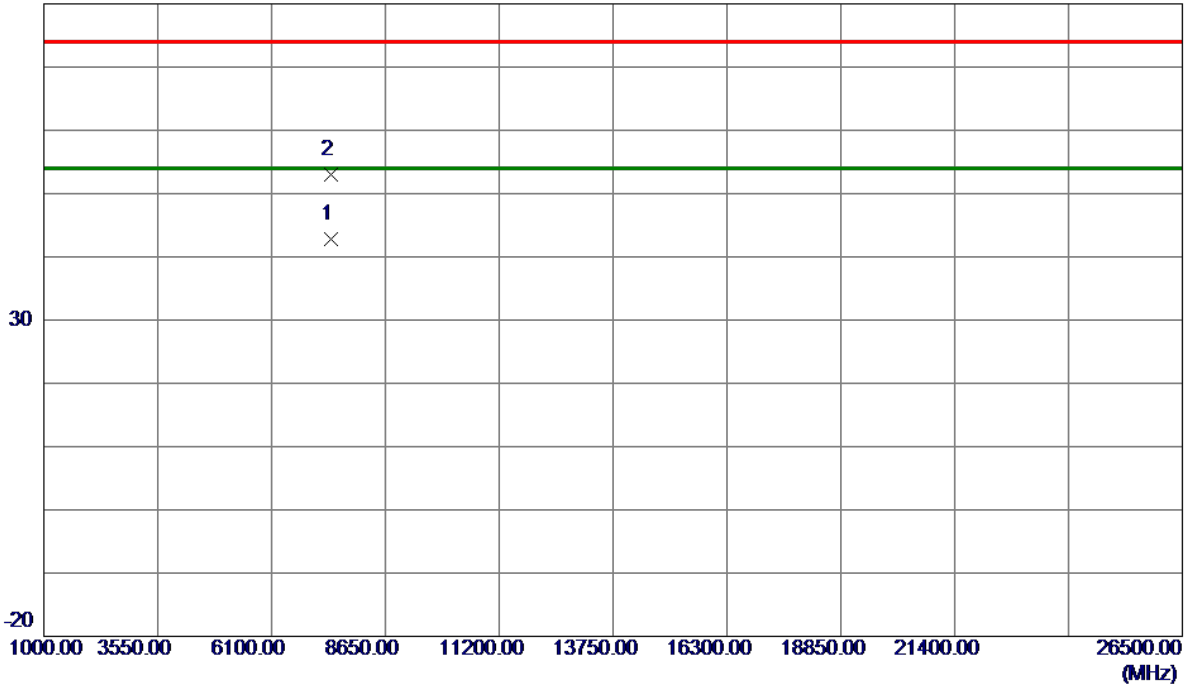

No.	Freq. MHz	Reading Level dBuV/m	Correct Factor dB	Measure ment dBuV/m	Limit dBuV/m	Margin dB	Detector	Comment
1 *	7439.8630	32.01	10.86	42.87	54.00	-11.13	AVG	
2	7440.6180	42.07	10.86	52.93	74.00	-21.07	Peak	

REMARKS:

- (1) Measurement Value = Reading Level + Correct Factor.
- (2) Margin Level = Measurement Value - Limit Value.

APPENDIX E - NUMBER OF HOPPING FREQUENCY

Test Mode:	TX Mode_1Mbps
------------	---------------

Test Mode	Hopping Mode_1Mbps	Limit	Test Result
Number of Hopping Frequency	79	15	Pass

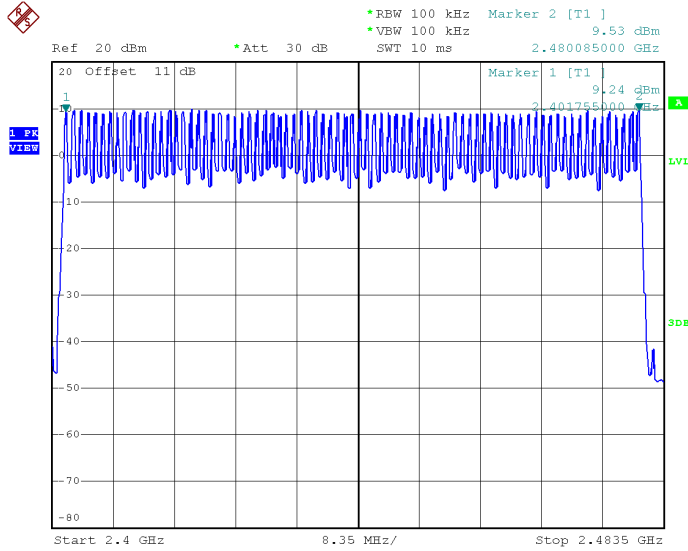

Date: 6.NOV.2021 14:57:23

Test Mode:	TX Mode_3Mbps
------------	---------------

Test Mode	Hopping Mode_3Mbps	Limit	Test Result
Number of Hopping Frequency	79	15	Pass

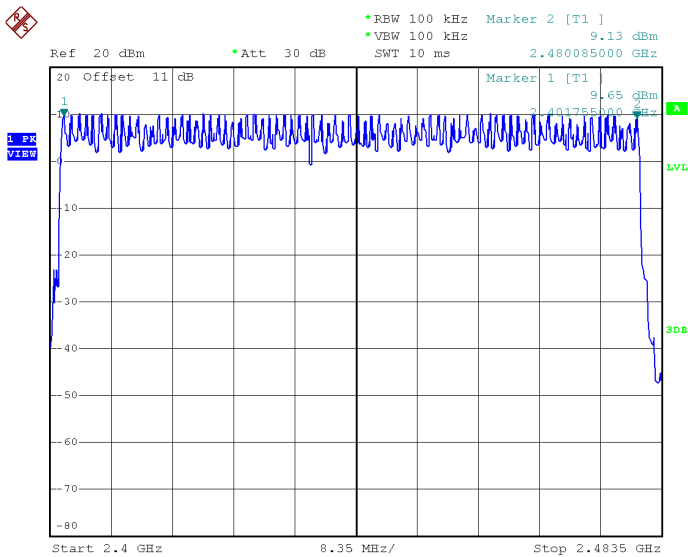

Date: 6.NOV.2021 15:16:50

APPENDIX F - AVERAGE TIME OF OCCUPANCY

Test Mode	Hopping Mode_1Mbps
-----------	--------------------

Data Packet	Frequency (MHz)	Pulse Duration (ms)	Dwell Time (s)	Limits (s)	Test Result
DH1	2402	0.3950	0.1264	0.4000	Pass
DH3	2402	1.6600	0.2656	0.4000	Pass
DH5	2402	2.9200	0.3115	0.4000	Pass
DH1	2441	0.3950	0.1264	0.4000	Pass
DH3	2441	1.6600	0.2656	0.4000	Pass
DH5	2441	2.9200	0.3115	0.4000	Pass
DH1	2480	0.3950	0.1264	0.4000	Pass
DH3	2480	1.6600	0.2656	0.4000	Pass
DH5	2480	2.9200	0.3115	0.4000	Pass

Test Mode	AFH Mode_1Mbps
-----------	----------------

Data Packet	Frequency (MHz)	Pulse Duration (ms)	Dwell Time (s)	Limits (s)	Test Result
DH1	2402	0.3950	0.0632	0.4000	Pass
DH3	2402	1.6600	0.1328	0.4000	Pass
DH5	2402	2.9200	0.1558	0.4000	Pass
DH1	2441	0.3950	0.0632	0.4000	Pass
DH3	2441	1.6600	0.1328	0.4000	Pass
DH5	2441	2.9200	0.1558	0.4000	Pass
DH1	2480	0.3950	0.0632	0.4000	Pass
DH3	2480	1.6600	0.1328	0.4000	Pass
DH5	2480	2.9200	0.1558	0.4000	Pass

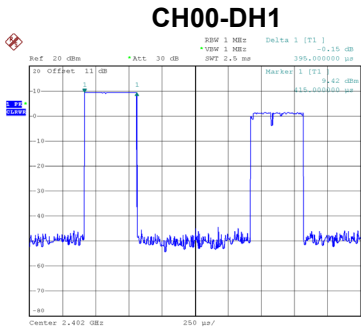

Date: 6.NOV.2021 14:49:56

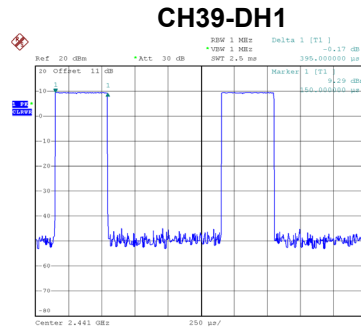

Date: 6.NOV.2021 14:51:02

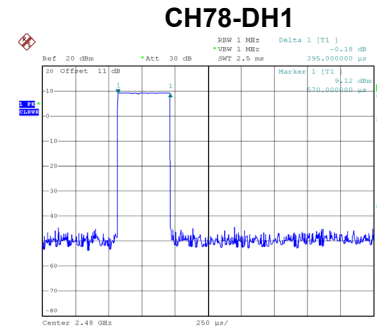

Date: 6.NOV.2021 14:51:36

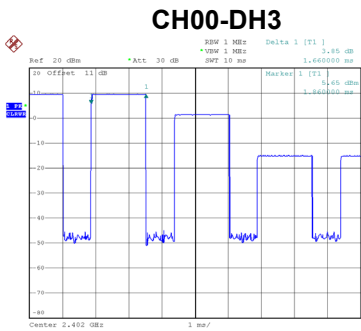

Date: 6.NOV.2021 15:02:16

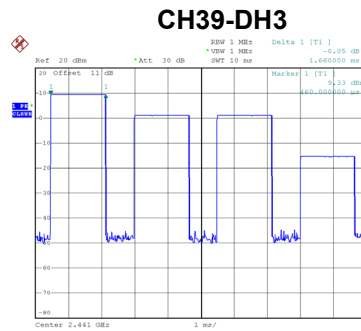

Date: 6.NOV.2021 15:02:28

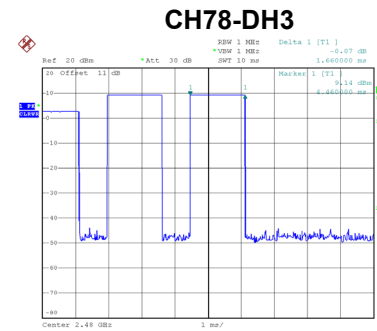

Date: 6.NOV.2021 15:02:33

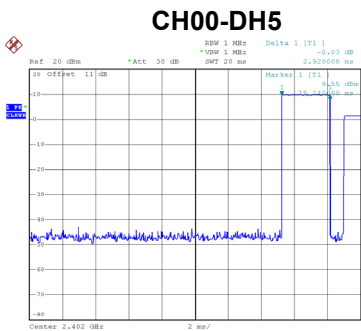

Date: 6.NOV.2021 15:02:48

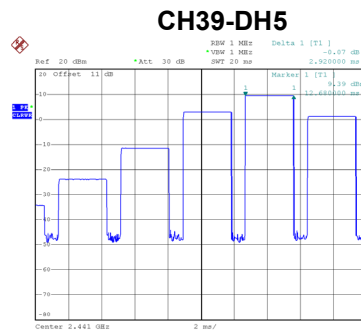

Date: 6.NOV.2021 15:02:53

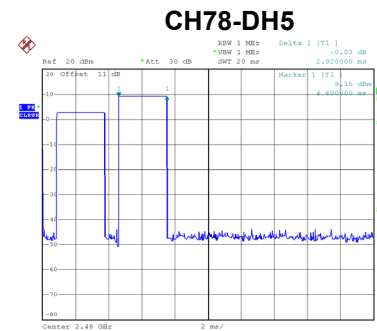

Date: 6.NOV.2021 15:03:11

Test Mode	Hopping Mode_3Mbps
-----------	--------------------

Data Packet	Frequency (MHz)	Pulse Duration (ms)	Dwell Time (s)	Limits (s)	Test Result
3DH1	2402	0.4050	0.1296	0.4000	Pass
3DH3	2402	1.6600	0.2656	0.4000	Pass
3DH5	2402	2.9200	0.3115	0.4000	Pass
3DH1	2441	0.4050	0.1296	0.4000	Pass
3DH3	2441	1.6400	0.2624	0.4000	Pass
3DH5	2441	2.8800	0.3072	0.4000	Pass
3DH1	2480	0.4050	0.1296	0.4000	Pass
3DH3	2480	1.6400	0.2624	0.4000	Pass
3DH5	2480	2.8800	0.3072	0.4000	Pass

Test Mode	AFH Mode_3Mbps
-----------	----------------

Data Packet	Frequency (MHz)	Pulse Duration (ms)	Dwell Time (s)	Limits (s)	Test Result
3DH1	2402	0.4050	0.0648	0.4000	Pass
3DH3	2402	1.6600	0.1328	0.4000	Pass
3DH5	2402	2.9200	0.1558	0.4000	Pass
3DH1	2441	0.4050	0.0648	0.4000	Pass
3DH3	2441	1.6400	0.1312	0.4000	Pass
3DH5	2441	2.8800	0.1536	0.4000	Pass
3DH1	2480	0.4050	0.0648	0.4000	Pass
3DH3	2480	1.6400	0.1312	0.4000	Pass
3DH5	2480	2.8800	0.1536	0.4000	Pass

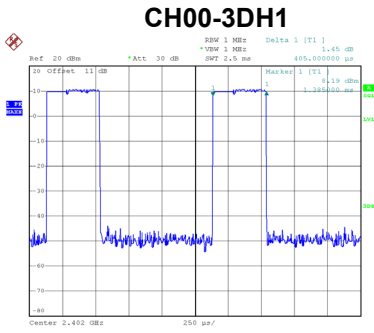

Date: 6.NOV.2021 15:08:17

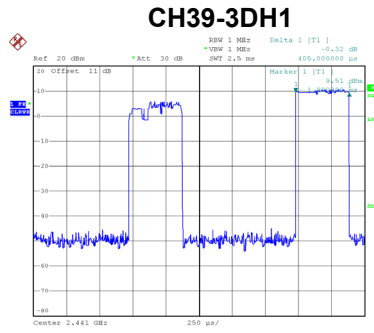

Date: 6.NOV.2021 15:08:35

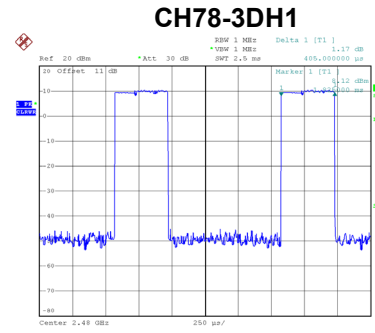

Date: 6.NOV.2021 15:08:45

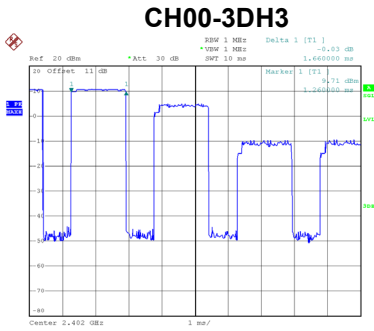

Date: 6.NOV.2021 15:19:45

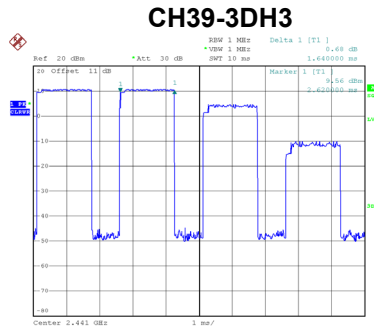

Date: 6.NOV.2021 15:20:06

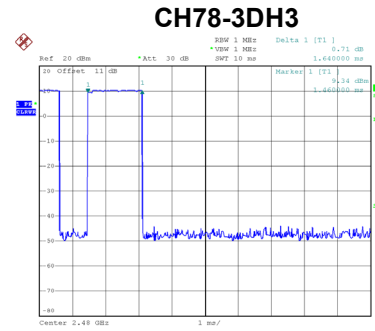

Date: 6.NOV.2021 15:20:12

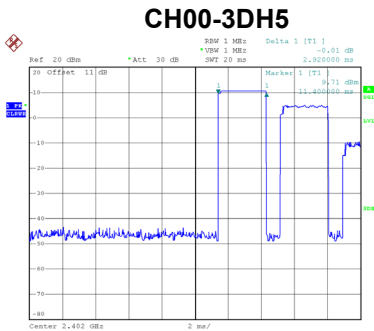

Date: 6.NOV.2021 15:20:23

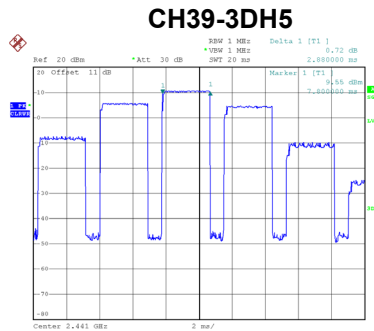

Date: 6.NOV.2021 15:20:29

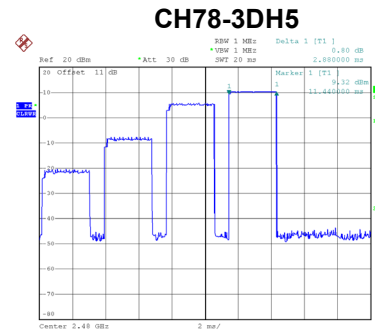

Date: 6.NOV.2021 15:20:35

APPENDIX G - HOPPING CHANNEL SEPARATION

Test Mode	Hopping Mode_1Mbps
-----------	--------------------

Channel	Frequency (MHz)	Channel Separation (MHz)	2/3 of 20 dB Bandwidth (MHz)	Test Result
00	2402	1.107	0.571	Pass
39	2441	1.013	0.617	Pass
78	2480	0.918	0.608	Pass

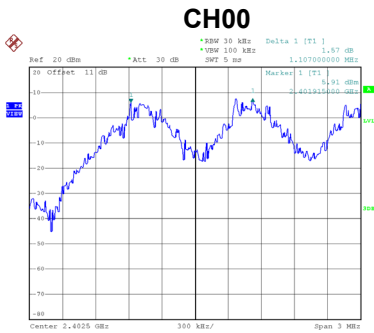

Date: 6.NOV.2021 14:53:11

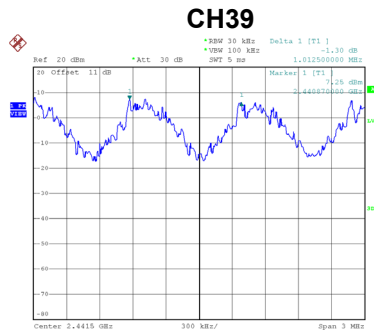

Date: 6.NOV.2021 14:54:25

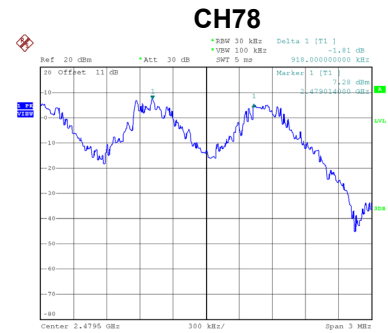

Date: 6.NOV.2021 14:55:30

Test Mode	Hopping Mode_3Mbps
-----------	--------------------

Channel	Frequency (MHz)	Channel Separation (MHz)	2/3 of 20 dB Bandwidth (MHz)	Test Result
00	2402	1.008	0.855	Pass
39	2441	1.149	0.843	Pass
78	2480	1.013	0.901	Pass

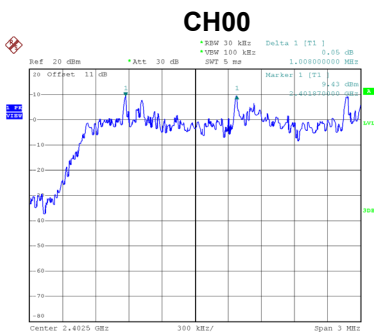

Date: 6.NOV.2021 15:09:52

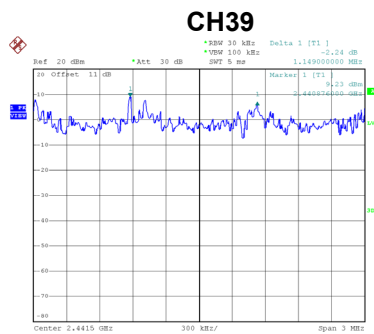

Date: 6.NOV.2021 15:11:06

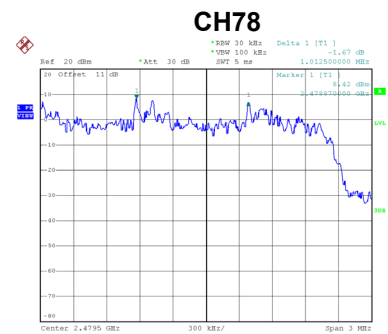

Date: 6.NOV.2021 15:14:56

APPENDIX H - BANDWIDTH

Test Mode	TX Mode _1Mbps
-----------	----------------

Channel	Frequency (MHz)	20 dB Bandwidth (MHz)	99 % Occupied Bandwidth (MHz)
00	2402	0.857	0.864
39	2441	0.926	0.884
78	2480	0.912	0.872

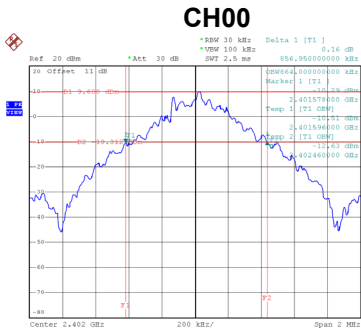

Date: 6.NOV.2021 14:43:25

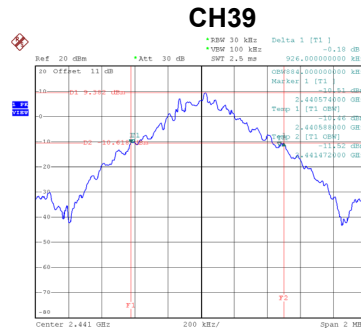

Date: 6.NOV.2021 14:45:45

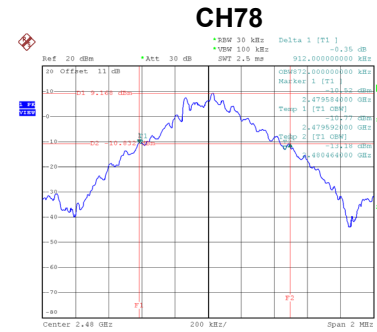

Date: 6.NOV.2021 14:47:01

Test Mode	TX Mode _3Mbps
-----------	----------------

Channel	Frequency (MHz)	20 dB Bandwidth (MHz)	99 % Occupied Bandwidth (MHz)
00	2402	1.282	1.204
39	2441	1.264	1.188
78	2480	1.352	1.208

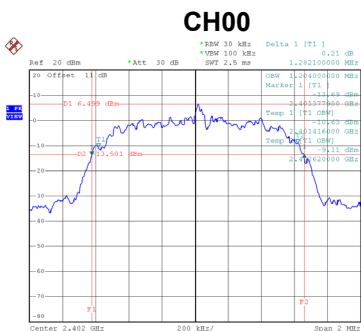

Date: 6.NOV.2021 16:13:08

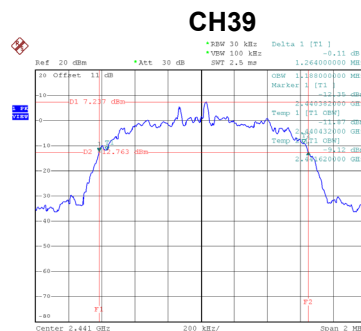

Date: 6.NOV.2021 16:15:11

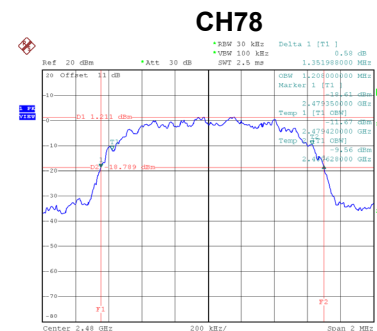

Date: 6.NOV.2021 16:16:20

APPENDIX I - MAXIMUM OUTPUT POWER

Test Mode	TX Mode _ 1Mbps
-----------	-----------------

Channel	Frequency (MHz)	Peak Output Power (dBm)	Max. Limit (dBm)	Max. Limit (W)	Test Result
00	2402	8.92	20.97	0.1250	Pass
39	2441	8.58	20.97	0.1250	Pass
78	2480	8.77	20.97	0.1250	Pass

Channel	Frequency (MHz)	Average Output Power (dBm)	Max. Limit (dBm)	Max. Limit (W)	Test Result
00	2402	8.80	20.97	0.1250	Pass
39	2441	8.51	20.97	0.1250	Pass
78	2480	8.39	20.97	0.1250	Pass

CH00

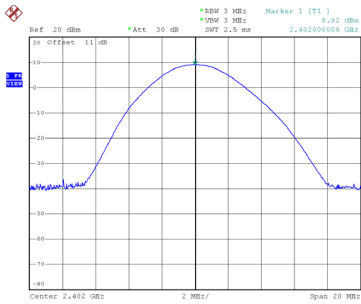

Date: 6.NOV.2021 13:48:47

CH39
Peak Output Power

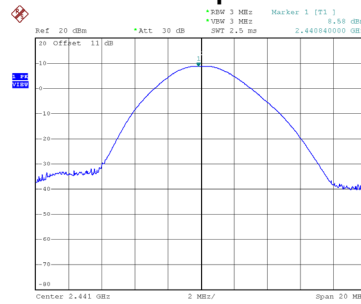

Date: 6.NOV.2021 13:49:39

CH78

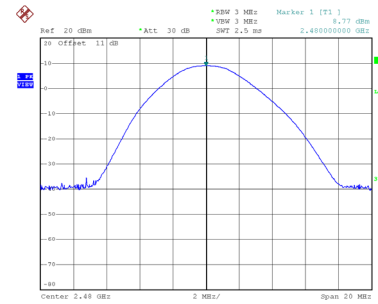

Date: 6.NOV.2021 15:07:38

Average Output Power

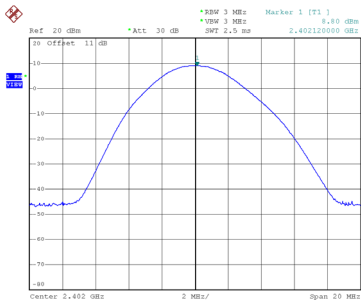

Date: 6.NOV.2021 13:57:22

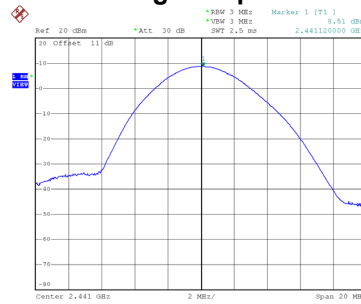

Date: 6.NOV.2021 13:58:21

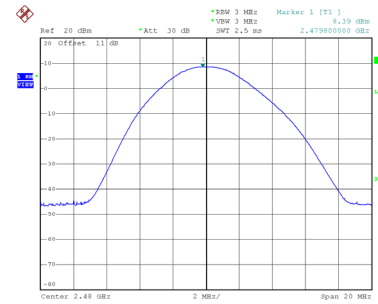

Date: 6.NOV.2021 13:58:48

Test Mode	TX Mode _2Mbps
-----------	----------------

Channel	Frequency (MHz)	Peak Output Power (dBm)	Max. Limit (dBm)	Max. Limit (W)	Test Result
00	2402	10.42	20.97	0.1250	Pass
39	2441	10.30	20.97	0.1250	Pass
78	2480	10.26	20.97	0.1250	Pass

Channel	Frequency (MHz)	Average Output Power (dBm)	Max. Limit (dBm)	Max. Limit (W)	Test Result
00	2402	8.36	20.97	0.1250	Pass
39	2441	8.30	20.97	0.1250	Pass
78	2480	8.39	20.97	0.1250	Pass

CH00

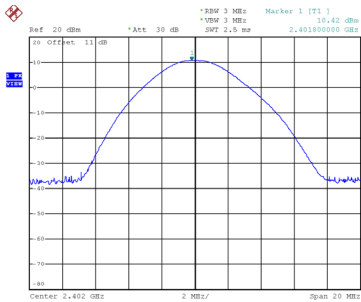

Date: 12.NOV.2021 09:41:13

CH39
Peak Output Power

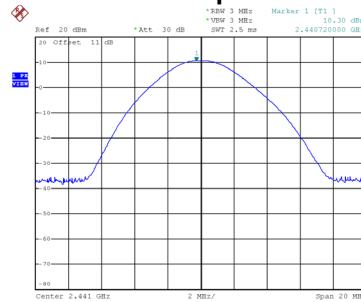

Date: 12.NOV.2021 09:41:36

CH78

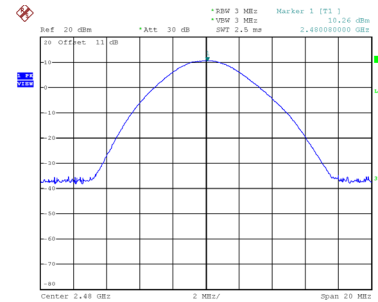

Date: 12.NOV.2021 09:41:56

Average Output Power

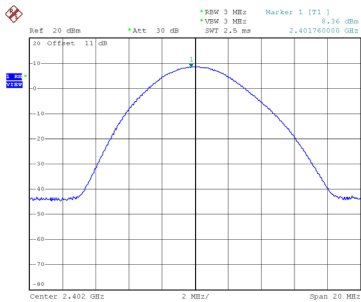

Date: 6.NOV.2021 14:02:13

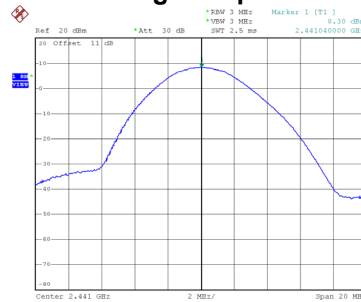

Date: 6.NOV.2021 14:02:42

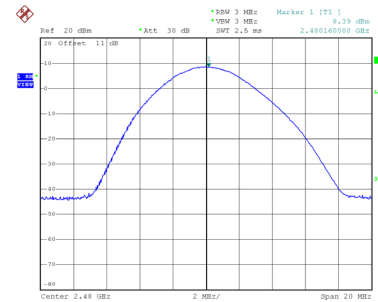

Date: 6.NOV.2021 14:03:35

Test Mode	TX Mode_3Mbps
-----------	---------------

Channel	Frequency (MHz)	Peak Output Power (dBm)	Max. Limit (dBm)	Max. Limit (W)	Test Result
00	2402	10.81	20.97	0.1250	Pass
39	2441	10.70	20.97	0.1250	Pass
78	2480	10.66	20.97	0.1250	Pass

Channel	Frequency (MHz)	Average Output Power (dBm)	Max. Limit (dBm)	Max. Limit (W)	Test Result
00	2402	8.53	20.97	0.1250	Pass
39	2441	8.46	20.97	0.1250	Pass
78	2480	8.52	20.97	0.1250	Pass

CH00

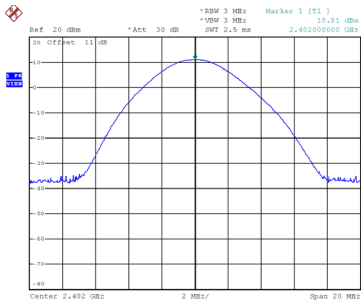

Date: 12.NOV.2021 09:42:35

CH39
Peak Output Power

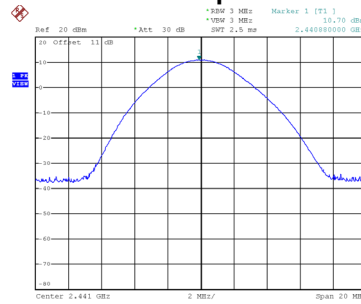

Date: 12.NOV.2021 09:42:59

CH78

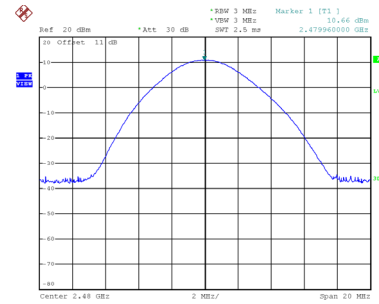

Date: 12.NOV.2021 09:43:17

Average Output Power

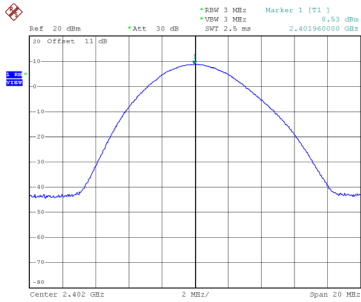

Date: 6.NOV.2021 14:39:33

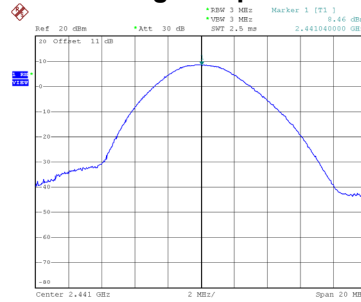

Date: 6.NOV.2021 14:40:05

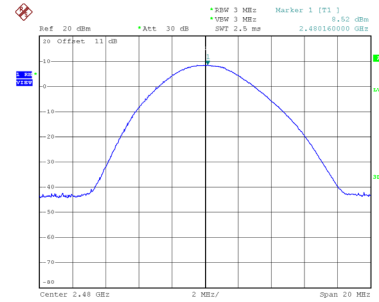

Date: 6.NOV.2021 14:40:33

APPENDIX J - CONDUCTED SPURIOUS EMISSION

Test Mode TX Mode _ 1Mbps

Bandedge CH00 (Lower)

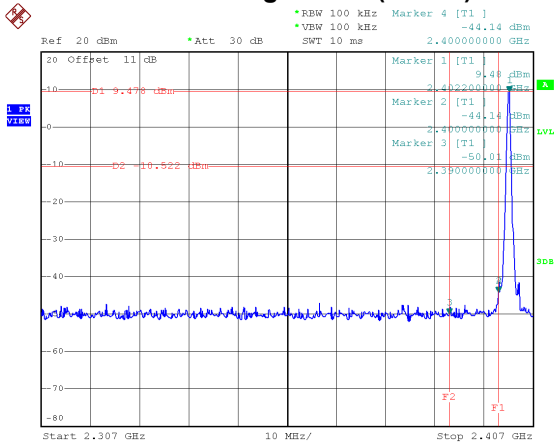

Date: 6.NOV.2021 14:42:32

Bandedge CH78 (Upper)

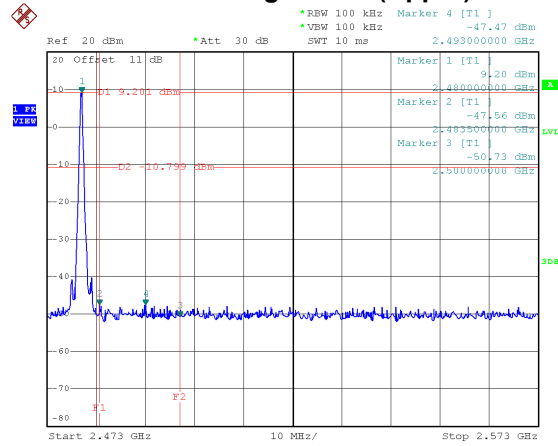

Date: 6.NOV.2021 14:46:08

Hopping on mode (Lower)

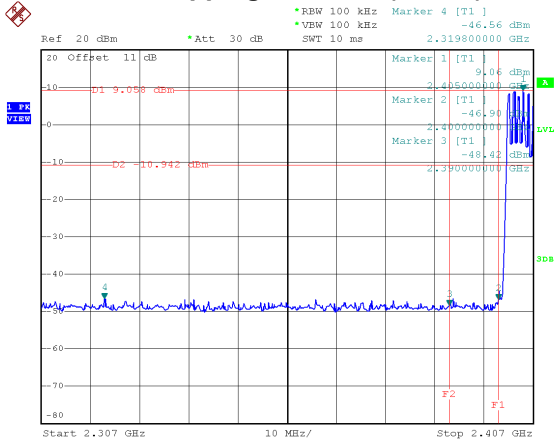

Date: 6.NOV.2021 14:59:35

Hopping on mode (Upper)

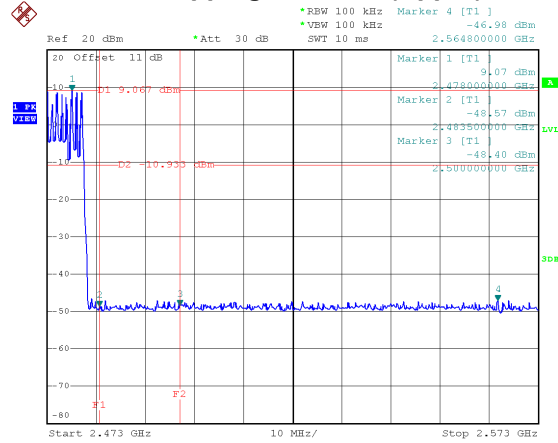

Date: 6.NOV.2021 14:58:36

CH00 – 10th Harmonic of the fundamental frequency

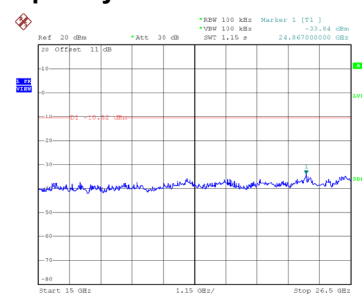
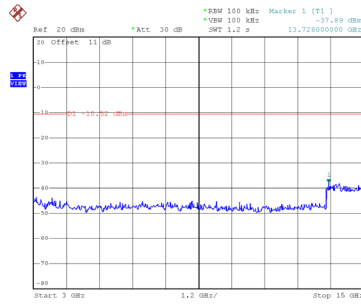
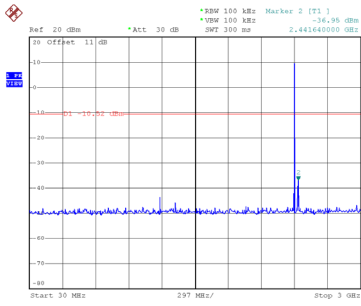

Date: 6.NOV.2021 14:43:40

Date: 6.NOV.2021 14:43:49

Date: 6.NOV.2021 14:43:58

CH39 – 10th Harmonic of the fundamental frequency

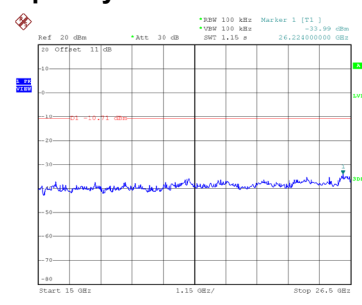
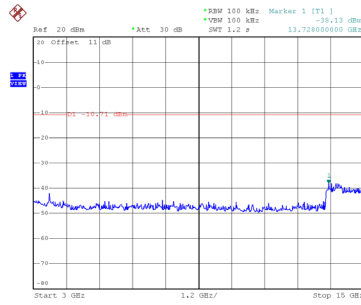
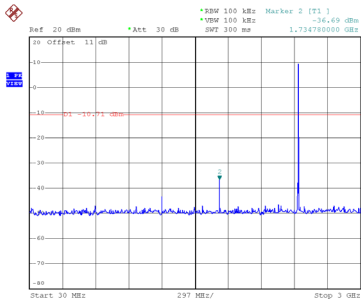

Date: 6.NOV.2021 14:44:37

Date: 6.NOV.2021 14:44:46

Date: 6.NOV.2021 14:44:55

CH78 – 10th Harmonic of the fundamental frequency

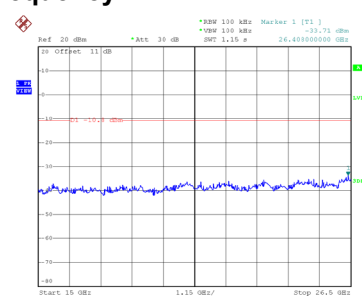
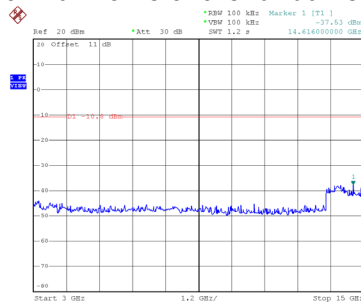
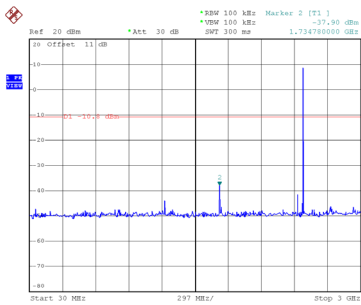

Date: 6.NOV.2021 14:47:16

Date: 6.NOV.2021 14:47:26

Date: 6.NOV.2021 14:47:35

Test Mode TX Mode_3Mbps

Bandedge CH00 (Lower)

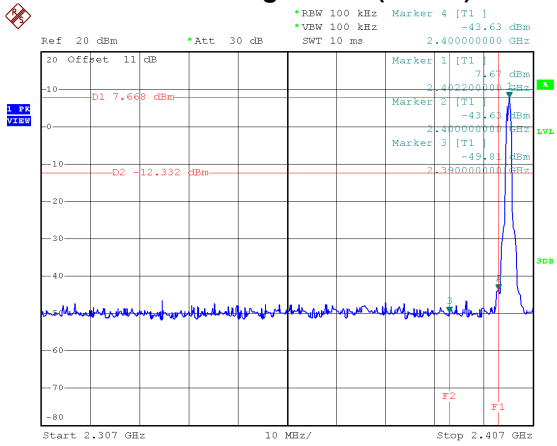

Date: 6.NOV.2021 16:12:30

Bandedge CH78 (Upper)

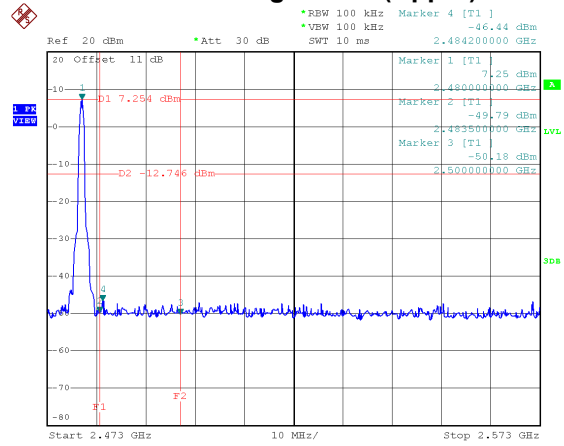

Date: 6.NOV.2021 16:15:44

Hopping on mode (Lower)

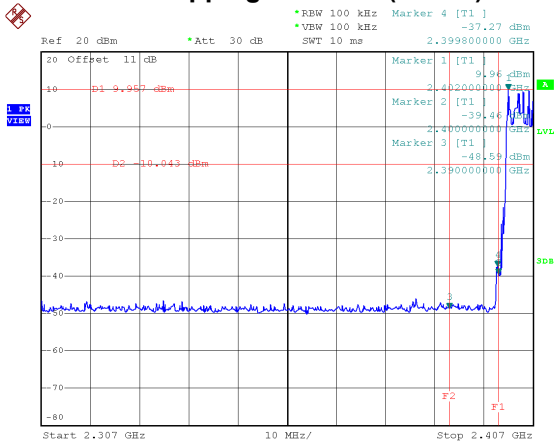

Date: 6.NOV.2021 15:17:27

Hopping on mode (Upper)

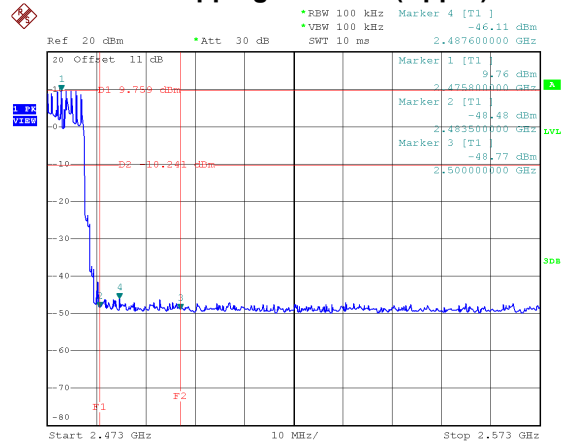

Date: 6.NOV.2021 15:18:53

CH00 – 10th Harmonic of the fundamental frequency

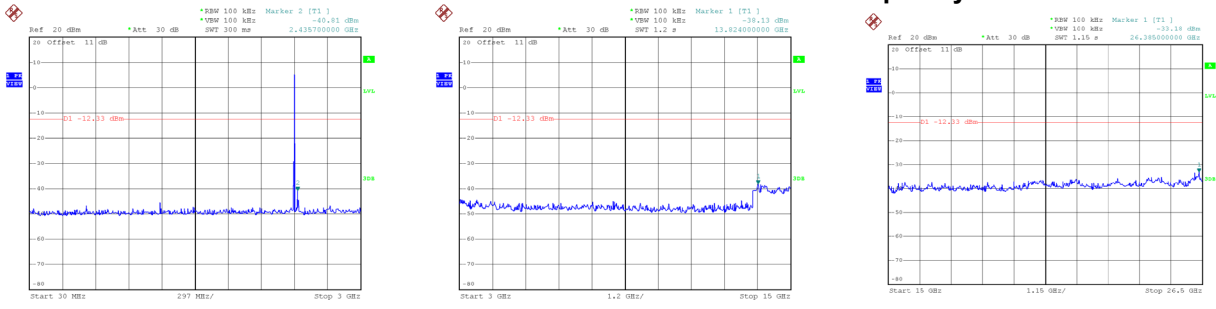

Date: 6.NOV.2021 16:13:23

Date: 6.NOV.2021 16:13:33

Date: 6.NOV.2021 16:13:42

CH39 – 10th Harmonic of the fundamental frequency

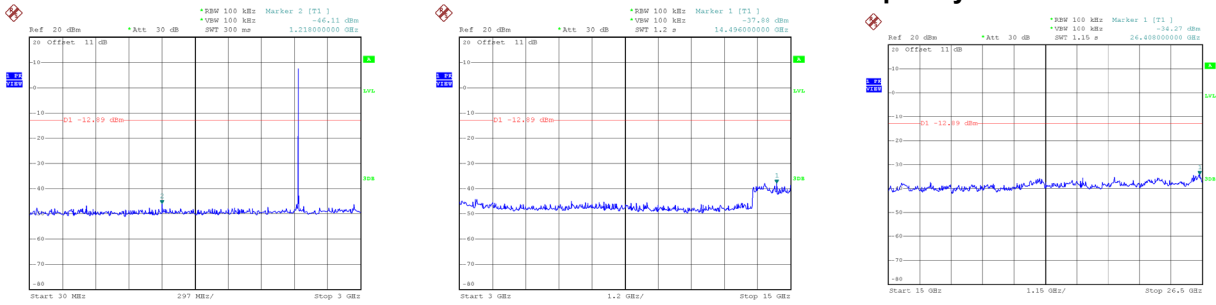

Date: 6.NOV.2021 16:14:17

Date: 6.NOV.2021 16:14:26

Date: 6.NOV.2021 16:14:35

CH78 – 10th Harmonic of the fundamental frequency

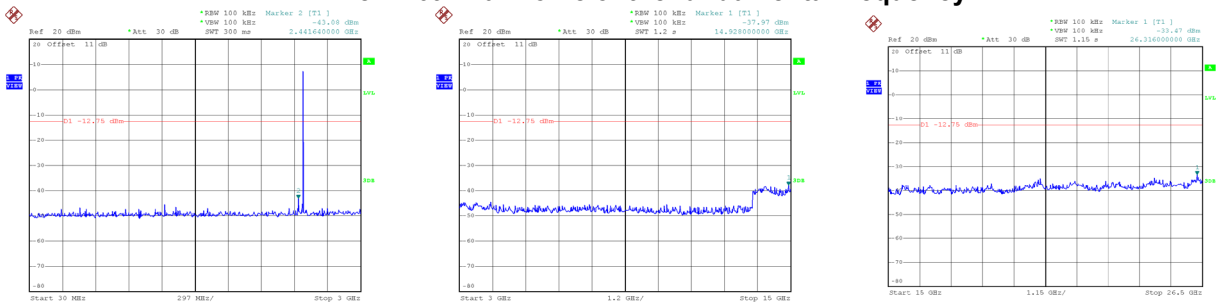

Date: 6.NOV.2021 16:16:35

Date: 6.NOV.2021 16:16:44

Date: 6.NOV.2021 16:16:54

APPENDIX K - DECLARATION FOR BLUETOOTH DEVICE

1. Output power and channel separation of a Bluetooth device in the different operating modes:

The different operating modes (data-mode, acquisition-mode) of a Bluetooth device has no influence on the output power and the channel spacing. There is only one transmitter which is driven by identical input parameters concerning these two parameters.

Only a different hopping sequence will be used. For this reason the check of these RF parameters in one op-mode is sufficient.

2. Frequency range of a Bluetooth device:

Hereby we declare that the maximum frequency of this device is: 2402 - 2480MHz. This is according to the Bluetooth Core Specification (+ critical errata) for devices which will be operated in the USA.

This was checked during the Bluetooth Qualification tests (Test Case: TRM/CA/04-E). Other frequency ranges (e.g. for Spain, France, Japan) which are allowed according the Core Specification are not supported by this device.

3. Co-ordination of the hopping sequence in data mode to avoid simultaneous occupancy by multiple transmitters:

Bluetooth units which want to communicate with other units must be organised in a structure called piconet. This piconet consist of max. 8 Bluetooth units. One unit is the master the other seven are the slaves. The master co-ordinates frequency occupation in this piconet for all units. As the master hop sequence is derived from its BD address which is unique for each Bluetooth device, additional masters intending to establish new piconets will always use different hop sequences.

4. Example of a hopping sequence in data mode:

Example of a 79 hopping sequence in data mode:

40, 21, 44, 23, 42, 53, 46, 55, 48, 33, 52, 35, 50, 65, 54, 67, 56, 37, 60, 39, 58, 69, 62, 71, 64, 25, 68, 27, 66, 57, 70, 59, 72, 29, 76, 31, 74, 61, 78, 63, 01, 41, 05, 43, 03, 73, 07, 75, 09, 45, 13, 47, 11, 77, 15, 00, 64, 49, 66, 53, 68, 02, 70, 06, 01, 51, 03, 55, 05, 04

5. Equally average use of frequencies in data mode and behaviour for short transmissions:

The generation of the hopping sequence in connection mode depends essentially on two input values:

- a) LAP/UAP of the master of the connection.
- b) Internal master clock.

The LAP (lower address part) are the 24 LSB's of the 48 BD_ADDRESS. The BD_ADDRESS is an unambiguous number of every Bluetooth unit. The UAP (upper address part) are the 24 MSB's of the 48 BD_ADDRESS.

The internal clock of a Bluetooth unit is derived from a free running clock which is never adjusted and is never turned off. For synchronisation with other units only offset are used. It has no relation to the time of the day. Its resolution is at least half the RX/TX slot length of 312.5 μ s. The clock has a cycle of about one day (23h30). In most case it is implemented as 28 bit counter. For the deriving of the hopping sequence the entire.

LAP (24 bits), 4 LSB's (4 bits) (Input 1) and the 27 MSB's of the clock (Input 2) are used. With this input values different mathematical procedures (permutations, additions, XOR- operations) are performed to generate the sequence. This will be done at the beginning of every new transmission.

Regarding short transmissions the Bluetooth system has the following behaviour:

The first connection between the two devices is established, a hopping sequence was generated. For transmitting the wanted data the complete hopping sequence was not used. The connection ended.

The second connection will be established. A new hopping sequence is generated. Due to the fact that the Bluetooth clock has a different value, because the period between the two transmission is longer (and it cannot be shorter) than the minimum resolution of the clock (312.5 μ s). The hopping sequence will always differ from the first one.

6. Receiver input bandwidth and behaviour for repeated single or multiple packets:

The input bandwidth of the receiver is 1 MHz. In every connection one Bluetooth device is the master and the other one is the slave. The master determines the hopping sequence (see chapter 5). The slave follows this sequence. Both devices shift between RX and TX time slot according to the clock of the master.

Additionally the type of connection (e.g. single or multislot packet) is set up at the beginning of the connection. The master adapts its hopping frequency and its TX/RX timing according to the packet type of the connection. Also the slave of the connection will use these settings.

Repeating of a packet has no influence on the hopping sequence. The hopping sequence generated by the master of the connection will be followed in any case. That means, a repeated packet will not be send on the same frequency, it is send on the next frequency of the hopping sequence.

End of Test Report