

FCC DFS Test Report

FCC ID: RWO-RZ040347

This report concerns: Original Grant

Project No. : 2007C004
Equipment : Gaming Headset
Brand Name : RAZER
Test Model : RZ04-0347
Series Model : RZ04-0347XXXX-XXXX (X can be 0-9 or A-Z)
Applicant : Razer Inc.
Address : 9 Pasteur, Suite 100, Irvine, CA92618, USA.
Manufacturer : Razer (Asia-Pacific) Pte.,Ltd.
Address : 514 Chai Chee Lane, #07-01-06,Singapore 469029
Factory : RAZER TECHNOLOGY AND DEVELOPMENT (SHENZHEN) CO., LTD
Address : East Wing, 3rd Floor, Block 2, Phase 1 of Vision Shenzhen Business Park
Keji South Road, Hi-Tech Industrial Park, Shenzhen 518057, China
Date of Receipt : Jul. 09, 2020
Date of Test : Jul. 09, 2020 ~ Sep. 26, 2020
Issued Date : Oct. 30, 2020
Report Version : R01
Test Sample : Sample No.: DG2020072771
Standard(s) : FCC Part 15, Subpart E (Section 15.407)
FCC KDB 789033 D02 General U-NII Test Procedures New Rules v02r01
FCC KDB 905462 D02 UNII DFS Compliance Procedures New Rules v02
FCC KDB 905462 D03 UNII Clients Without Radar Detection New Rules
v01r02

The above equipment has been tested and found compliance with the requirement of the relative standards by BTL Inc.



Prepared by : Welly Zhou



Approved by : Ethan Ma



Certificate #5123.02

Add: No.3, Jinshagang 1st Road, Shixia, Dalang Town,Dongguan, Guangdong, China.

Tel: +86-769-8318-3000

Web: www.newbtl.com

Declaration

BTL represents to the client that testing is done in accordance with standard procedures as applicable and that test instruments used has been calibrated with standards traceable to international standard(s) and/or national standard(s).

BTL's reports apply only to the specific samples tested under conditions. It is manufacture's responsibility to ensure that additional production units of this model are manufactured with the identical electrical and mechanical components. **BTL** shall have no liability for any declarations, inferences or generalizations drawn by the client or others from **BTL** issued reports.

The report must not be used by the client to claim product certification, approval, or endorsement by NVLAP, NIST, A2LA, or any agency of the U.S. Government.

This report is the confidential property of the client. As a mutual protection to the clients, the public and ourselves, the test report shall not be reproduced, except in full, without our written approval.

BTL's laboratory quality assurance procedures are in compliance with the **ISO/IEC 17025** requirements, and accredited by the conformity assessment authorities listed in this test report.

BTL is not responsible for the sampling stage, so the results only apply to the sample as received.

The information, data and test plan are provided by manufacturer which may affect the validity of results, so it is manufacturer's responsibility to ensure that the apparatus meets the essential requirements of applied standards and in all the possible configurations as representative of its intended use.

Limitation

For the use of the authority's logo is limited unless the Test Standard(s)/Scope(s)/Item(s) mentioned in this test report is (are) included in the conformity assessment authorities acceptance respective.

Please note that the measurement uncertainty is provided for informational purpose only and are not use in determining the Pass/Fail results.

Table of Contents	page
REPORT ISSUED HISTORY	4
1 . EUT INFORMATION	5
1.1 EUT SPECIFICATION TABLE	5
1.2 CONDUCTED OUTPUT POWER AND EIRP	6
2 . U-NII DFS RULE REQUIREMENTS	7
2.1 WORKING MODES AND REQUIRED TEST ITEMS	7
2.2 TEST LIMITS AND RADAR SIGNAL PARAMETERS	8
3 . TEST INSTRUMENTS	10
4 . DYNAMIC FREQUENCY SELECTION (DFS) TEST	11
4.1 DFS MEASUREMENT SYSTEM	11
4.2 CALIBRATION OF DFS DETECTION THRESHOLD LEVEL	13
4.3 DEVIATION FROM TEST STANDARD	13
5 . TEST RESULTS	14
5.1 SUMMARY OF TEST RESULT	14
5.2 TEST MODE: DEVICE OPERATING IN MASTER MODE	14
5.3 DFS DETECTION THRESHOLD	15
5.4 CHANNEL CLOSING TRANSMISSION AND CHANNEL MOVE TIME WLAN TRAFFIC	16
5.5 NON-OCCUPANCY PERIOD	18

REPORT ISSUED HISTORY

Report Version	Description	Issued Date
R00	Original Issue.	Oct. 21, 2020
R01	Revised report to address comments.	Oct. 30, 2020

1. EUT INFORMATION

1.1 EUT SPECIFICATION TABLE

Table 1: Specification of EUT

Equipment	Gaming Headset
Brand Name	RAZER
Test Model	RZ04-0347
Series Model	RZ04-0347XXXX-XXXX (X can be 0-9 or A-Z)
Model Difference(s)	It is the same as the basic model and X is used to define which country it is for under the same family series.
Power Source	1# Supplied from PC USB port. 2# Supplied from battery. Model: 553450
Power Rating	1# 5V \equiv 500mA 2# DC 3.7V 1000mAh
Operational Mode	Client
Operation Frequency Bands	UNII-2A: 5250 MHz ~ 5350 MHz UNII-2C: 5470 MHz ~ 5725 MHz
Modulation Type	OFDM

Note: This device was functioned as a

Master
 Client device without radar detection
 Client device with radar detection

Note:

1. For a more detailed features description, please refer to the manufacturer's specifications or the user's manual.

2. Channel List:

IEEE 802.11a IEEE 802.11n (HT20)	
UNII-2A	
Channel	Frequency (MHz)
52	5260
56	5280
60	5300
64	5320

IEEE 802.11a IEEE 802.11n (HT20)	
UNII-2C	
Channel	Frequency (MHz)
100	5500
104	5520
108	5540
112	5560
116	5580
120	5600
124	5620
128	5640
132	5660
136	5680
140	5700

3. Antenna Specification:

Ant.	Brand	Model Name	Antenna Type	Connector	Gain (dBi)
1	N/A	N/A	PCB	N/A	3.98

1.2 CONDUCTED OUTPUT POWER AND EIRP

Table 2: The Maximum Output Power and e.i.r.p. List

TX A Mode				
Frequency Band (MHz)	Max. Output Power (dBm)	Antenna Gain	Max. e.i.r.p. (dBm)	Max. e.i.r.p. (mW)
5250~5350	-3.84	3.98	0.14	1.03
5470~5725	1.99	3.98	5.97	3.95

2. U-NII DFS RULE REQUIREMENTS

2.1 WORKING MODES AND REQUIRED TEST ITEMS

The manufacturer shall state whether the UUT is capable of operating as a Master and/or a Client. If the UUT is capable of operating in more than one operating mode then each operating mode shall be tested separately. See tables 3 and 4 for the applicability of DFS requirements for each of the operational modes.

Table 3: Applicability of DFS requirements prior to use a channel

Requirement	Operational Mode		
	Master	Client without radar detection	Client with radar detection
Non-Occupancy Period	✓	✓	✓
DFS Detection Threshold	✓	Not required	✓
Channel Availability Check Time	✓	Not required	Not required
Uniform Spreading	✓	Not required	Not required
U-NII Detection Bandwidth	✓	Not required	✓

Table 4: Applicability of DFS requirements during normal operation.

Requirement	Operational Mode		
	Master	Client without radar detection	Client with radar detection
DFS Detection Threshold	✓	Not required	✓
Channel Closing Transmission Time	✓	✓	✓
Channel Move Time	✓	✓	✓
U-NII Detection Bandwidth	✓	Not required	✓

2.2 TEST LIMITS AND RADAR SIGNAL PARAMETERS

DETECTION THRESHOLD VALUES

Table 5: DFS Detection Thresholds for Master Devices and Client Devices With Radar Detection.

Maximum Transmit Power	Value (See Notes 1 and 2)
e.i.r.p. \geq 200 milliwatt	-64 dBm
e.i.r.p. < 200 milliwatt and power spectral density < 10 dBm/MHz	-62 dBm
e.i.r.p. < 200 milliwatt that do not meet the power spectral density requirement	-64 dBm

Note 1: This is the level at the input of the receiver assuming a 0 dBi receive antenna.

Note 2: Throughout these test procedures an additional 1 dB has been added to the amplitude of the test transmission waveforms to account for variations in measurement equipment. This will ensure that the test signal is at or above the detection threshold level to trigger a DFS response.

Note3: EIRP is based on the highest antenna gain. For MIMO devices refer to KDB Publication 662911 D01.

Table 6: DFS Response Requirement Values

Parameter	Value
Non-occupancy period	Minimum 30 minutes
Channel Availability Check Time	60 seconds
Channel Move Time	10 seconds See Note 1.
Channel Closing Transmission Time	200 milliseconds + an aggregate of 60 milliseconds over remaining 10 second period. See Notes 1 and 2.
U-NII Detection Bandwidth	Minimum 100% of the UNII 99% transmission power bandwidth. See Note 3.

Note 1: Channel Move Time and the Channel Closing Transmission Time should be performed with Radar Type 0. The measurement timing begins at the end of the Radar Type 0 burst.

Note 2: The Channel Closing Transmission Time is comprised of 200 milliseconds starting at the beginning of the Channel Move Time plus any additional intermittent control signals required to facilitate a Channel move (an aggregate of 60 milliseconds) during the remainder of the 10 second period. The aggregate duration of control signals will not count quiet periods in between transmissions.

Note 3: During the U-NII Detection Bandwidth detection test, radar type 0 should be used. For each frequency step the minimum percentage of detection is 90 percent. Measurements are performed with no data traffic.

PARAMETERS OF DFS TEST SIGNALS

Step intervals of 0.1 microsecond for Pulse Width, 1 microsecond for PRI, 1 MHz for chirp width and 1 for the number of pulses will be utilized for the random determination of specific test waveforms.

Table 7: Short Pulse Radar Test Waveforms.

Radar Type	Pulse Width (μsec)	PRI (μsec)	Number of Pulses	Minimum Percentage of Successful Detection	Minimum Number of Trials
0	1	1428	18	See Note 1	See Note 1
1	1	Test A: 15 unique PRI values randomly selected from the list of 23 PRI values in Table 5a	Roundup $\left\{ \begin{array}{l} \left(\frac{1}{360} \right) \cdot \\ \left(\frac{19 \cdot 10^6}{\text{PRI}_{\mu\text{sec}}} \right) \end{array} \right\}$	60%	30
		Test B: 15 unique PRI values randomly selected within the range of 518-3066 μsec, with a minimum increment of 1 μsec, excluding PRI values selected in Test A			
2	1-5	150-230	23-29	60%	30
3	6-10	200-500	16-18	60%	30
4	11-20	200-500	12-16	60%	30
Aggregate (Radar Types 1-4)				80%	120
Note 1: Short Pulse Radar Type 0 should be used for the detection bandwidth test, channel move time, and channel closing time tests.					

A minimum of 30 unique waveforms are required for each of the Short Pulse Radar Types 2 through 4. If more than 30 waveforms are used for Short Pulse Radar Types 2 through 4, then each additional waveform must also be unique and not repeated from the previous waveforms. If more than 30 waveforms are used for Short Pulse Radar Type 1, then each additional waveform is generated with Test B and must also be unique and not repeated from the previous waveforms in Tests A or B.

Table 8: Long Pulse Radar Test Waveform

Radar Type	Pulse Width (μsec)	Chirp Width (MHz)	PRI (μsec)	Number of Pulses per Burst	Number of Bursts	Minimum Percentage of Successful Detection	Minimum Number of Trials
5	50-100	5-20	1000-2000	1-3	8-20	80%	30

The parameters for this waveform are randomly chosen (The center frequency for each of the 30 trials of the Bin 5 radar shall be randomly selected within 80% of the Occupied Bandwidth.) Thirty unique waveforms are required for the Long Pulse Radar Type waveforms. If more than 30 waveforms are used for the Long Pulse Radar Type waveforms, then each additional waveform must also be unique and not repeated from the previous waveforms.

Table 9: Frequency Hopping Radar Test Waveform

Radar Type	Pulse Width (μsec)	Chirp Width (MHz)	PRI (μsec)	Number of Pulses per Burst	Number of Bursts	Minimum Percentage of Successful Detection	Minimum Number of Trials
6	1	333	9	0.333	300	70%	30

3. TEST INSTRUMENTS

Table 10: Test Instruments List.

DESCRIPTION	MANUFACTURER	MODEL NO.	SERIAL NO	CALIBRATION UNTIL
EXA Spectrum Analyzer	Agilent	N9010A	MY50520044	Mar. 01, 2021
Signal Generator	Agilent	E4438C	MY49071316	Mar. 01, 2021
POWER SPLITTER	Mini-Circuits	ZFRSC-123-S+	331000910-1	Mar. 01, 2021
POWER SPLITTER	Mini-Circuits	ZN4PD1-63-S+	SF9335D1045-1	Mar. 01, 2021
Attenuator	WOKEN	6SM3502	VAS1214NL	Feb. 11, 2021
Wi-Fi Router	tp-link	Archer AX6000	N/A	N/A
XBOX	Microsoft	N/A	012088290416	N/A

Note:

- (1) Calibration interval of instruments listed above is one year.
- (2) Wi-Fi Router's FCC ID: TE7AX6000

4. DYNAMIC FREQUENCY SELECTION (DFS) TEST

4.1 DFS MEASUREMENT SYSTEM

Test Procedure

1. Master device and client device are set up by conduction method as the following configuration.
2. The client device is connected to notebook and to access a IP address on wireless connection with the master device.
3. Then the master device is connected to another notebook to access a IP address.
4. Finally, let the two IP addresses run traffic with each other through the Run flow software "Lan test" to reach 17% channel loading as below

Setup

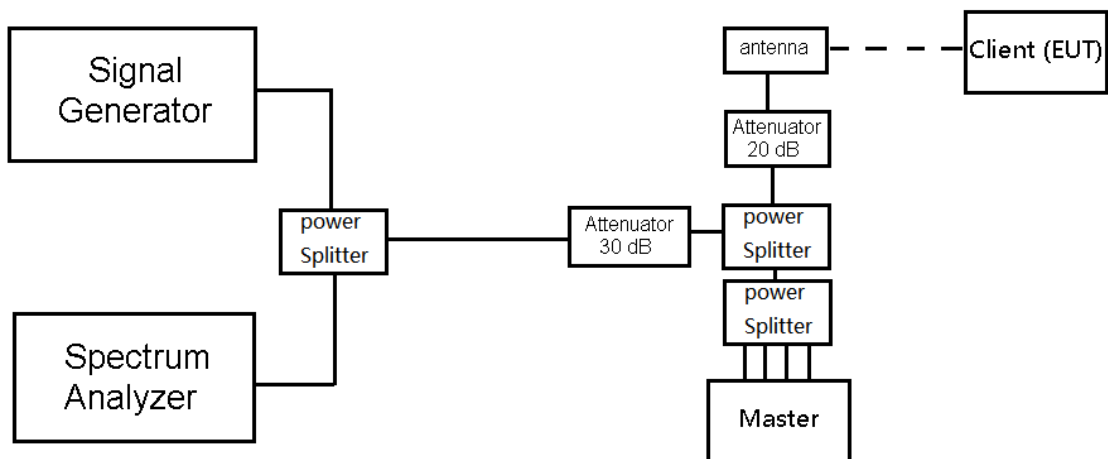

Channel Loading

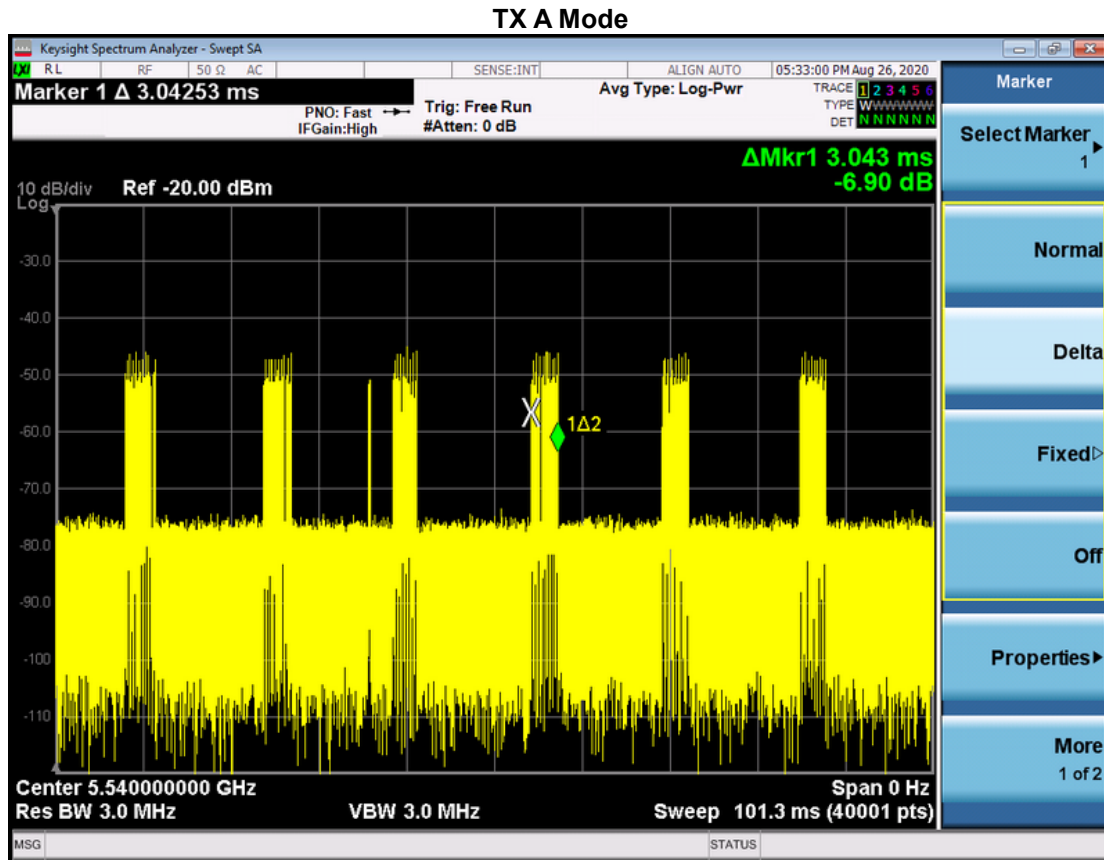

Frequency (MHz)	Marker Delta (ms)	Number	On Time (ms)	Total Time (ms)	Duty cycle (%)	Limit (%)
5540	3.043	6	18.258	101.3	18.02	17.00

The hopping type 6 pulse parameters are fixed while the hopping sequence is based on the August 2005 NTIA Hopping Frequency List. The initial starting point randomized at run-time and each subsequent starting point is incremented by 475. Each frequency in the 100-length segment is compared to the boundaries of the EUT Detection Bandwidth and the software creates a hopping burst pattern in accordance with Section 7.4.1.3 Method #2 Simulated Frequency Hopping Radar Waveform Generating Subsystem of FCC 06-96. The frequency of the signal generator is incremented in 1 MHz steps from FL to FH for each successive trial. This incremental sequence is repeated as required to generate a minimum of 30 total trials and to maintain a uniform frequency distribution over the entire Detection Bandwidth.

The signal monitoring equipment consists of a spectrum analyzer set to display 8001 bins on the horizontal axis. The time-domain resolution is 2 msec / bin with a 16 second sweep time, meeting the 10 second short pulse reporting criteria. The aggregate ON time is calculated by multiplying the number of bins above a threshold during a particular observation period by the dwell time per bin, with the analyzer set to peak detection and max hold.

Should multiple RF ports be utilized for the Master and/or Slave devices (for example, for diversity or MIMO implementations), additional combiner/dividers are inserted between the Master Combiner/Divider and the pad connected to the Master Device (and/or between the Slave Combiner/Divider and the pad connected to the Slave Device). Additional pads are utilized such that there is one pad at each RF port on each EUT.

4.2 CALIBRATION OF DFS DETECTION THRESHOLD LEVEL

A 50 ohm load is connected in place of the spectrum analyzer, and the spectrum analyzer is connected in place of the master device and the signal generator is set to CW mode. The amplitude of the signal generator is adjusted to yield a level of -62 dBm as measured on the spectrum analyzer.

Without changing any of the instrument settings, the spectrum analyzer is reconnected to the Common port of the Spectrum Analyzer Combiner/Divider. Measure the amplitude and calculate the difference from -62 dBm. Adjust the Reference Level Offset of the spectrum analyzer to this difference.

The spectrum analyzer displays the level of the signal generator as received at the antenna ports of the Master Device. The interference detection threshold may be varied from the calibrated value of -62 dBm and the spectrum analyzer will still indicate the level as received by the Master Device.

Set the signal generator to produce a radar waveform, trigger a burst manually and measure the level on the spectrum analyzer. Readjust the amplitude of the signal generator as required so that the peak level of the waveform is at a displayed level equal to the required or desired interference detection threshold. Separate signal generator amplitude settings are determined as required for each radar type.

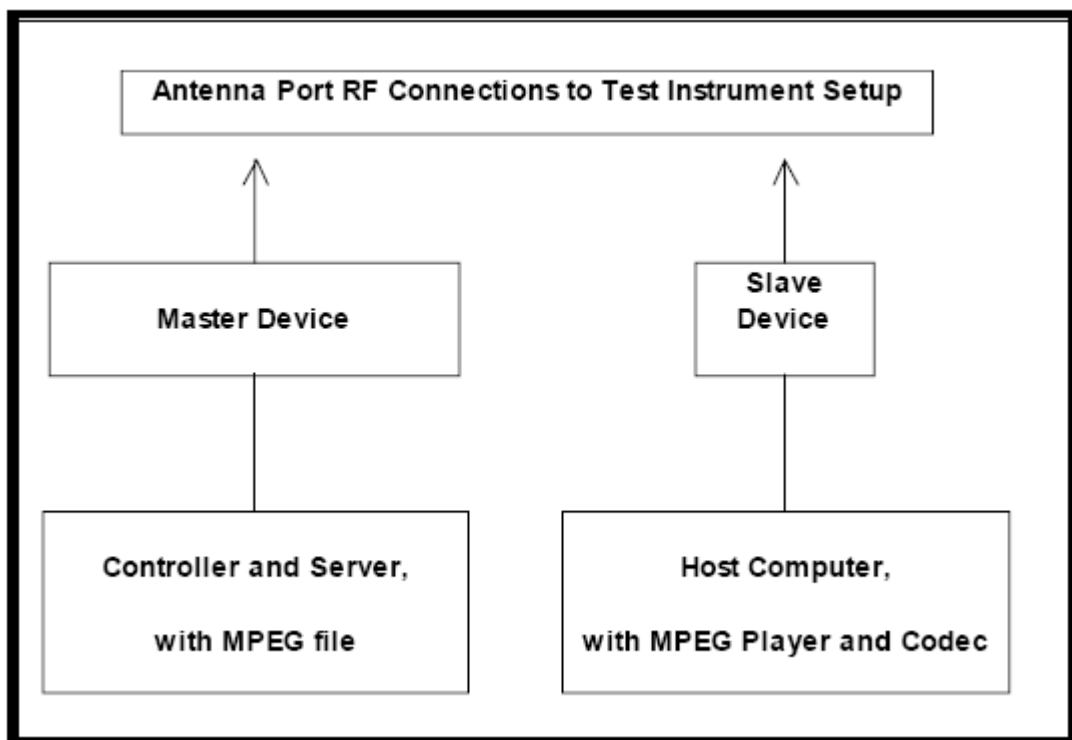

4.3 DEVIATION FROM TEST STANDARD

No deviation.

5. TEST RESULTS

5.1 SUMMARY OF TEST RESULT

Clause	Test Parameter	Test Mode and Channel	Remarks	Result
15.407	DFS Detection Threshold	-	No Applicable	N/A
	Channel Availability Check Time	-	Not Applicable	N/A
	Channel Move Time	TX A Mode 5540 MHz	Applicable	Pass
	Channel Closing Transmission Time	TX A Mode 5540 MHz	Applicable	Pass
	Non- Occupancy Period	TX A Mode 5540 MHz	Applicable	Pass
	Uniform Spreading	-	Not Applicable	N/A
	U-NII Detection Bandwidth	-	Not Applicable	N/A

5.2 TEST MODE: DEVICE OPERATING IN MASTER MODE

The EUT is slave equipment, it need a master device when testing.

Master with injection at the Master. (Radar Test Waveforms are injected into the Master)

5.3 DFS DETECTION THRESHOLD

Calibration:

The EUT is slave equipment and it with the biggest gain is 3.98 dBi.
 For a detection threshold level of -64dBm and the master antenna gain is 2.90 dBi, required detection threshold is -61.10 dBm (= -64+2.90).

Note: Maximum Transmit Power is more than 200 milliwatt in this report, so detection threshold level is -64dBm.

Radarsignal 0

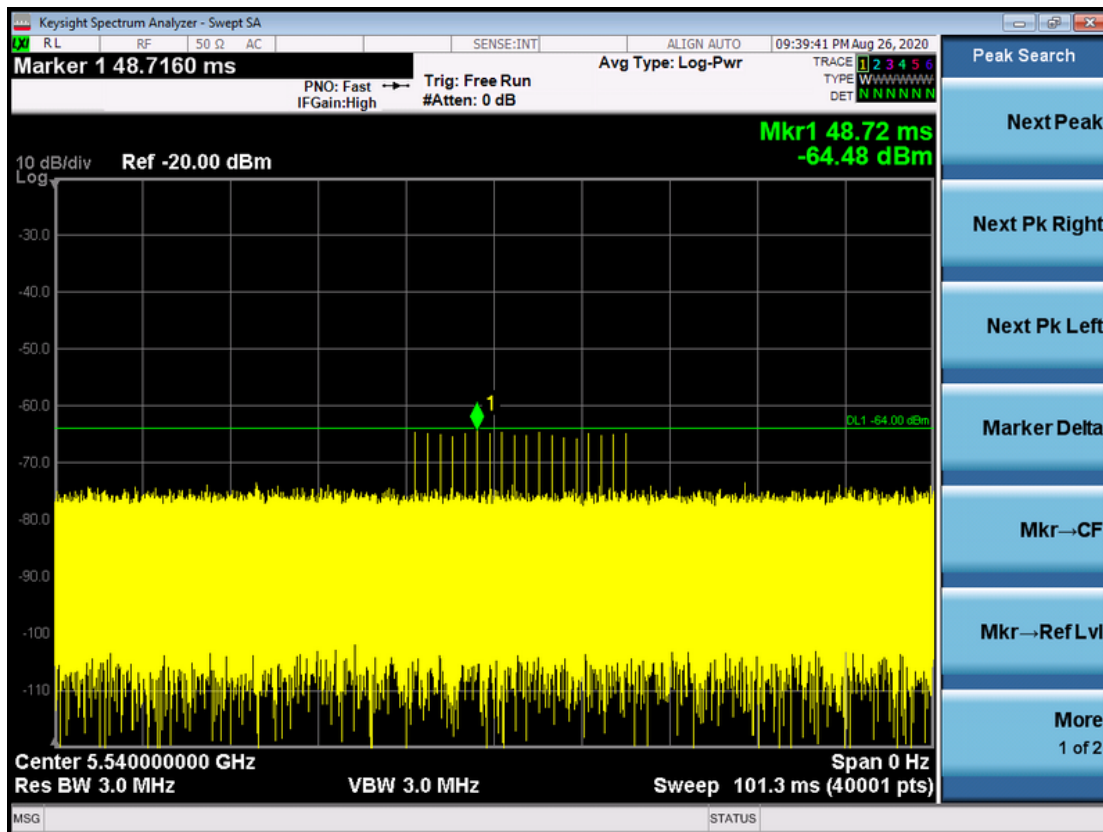

5.4 CHANNEL CLOSING TRANSMISSION AND CHANNEL MOVE TIME WLAN TRAFFIC

TX A Mode

Radar signal 0

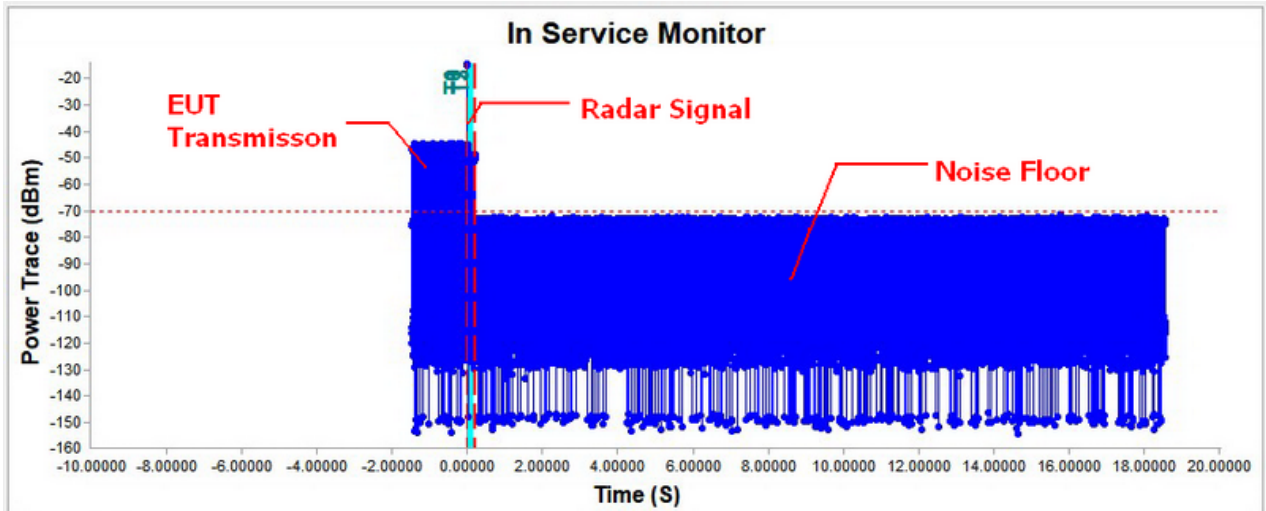

Time Index Info			
T0 : -0.0240 S	(Radar Injection Start)	Time Per Bin: 0.4999875	Channel Move Time: 0.2159946 S
T1 : 0.0000 S	(Radar Injection Stop)	T2~T3 Bins Over Threshold: = 17 Bins	Channel Close Time: 0.0084998 S
T2 : 0.2000 S	(200msec Interval)		
T3 : 0.2160 S	(Channel Move Time)		

Note: T0 denotes the Radar Injection Start.
 T1 denotes the start of Channel Move Time upon the end of the last Radar burst.
 T2 denotes the data transmission time of 200ms from T1.
 T3 denotes the end of Channel Move Time.

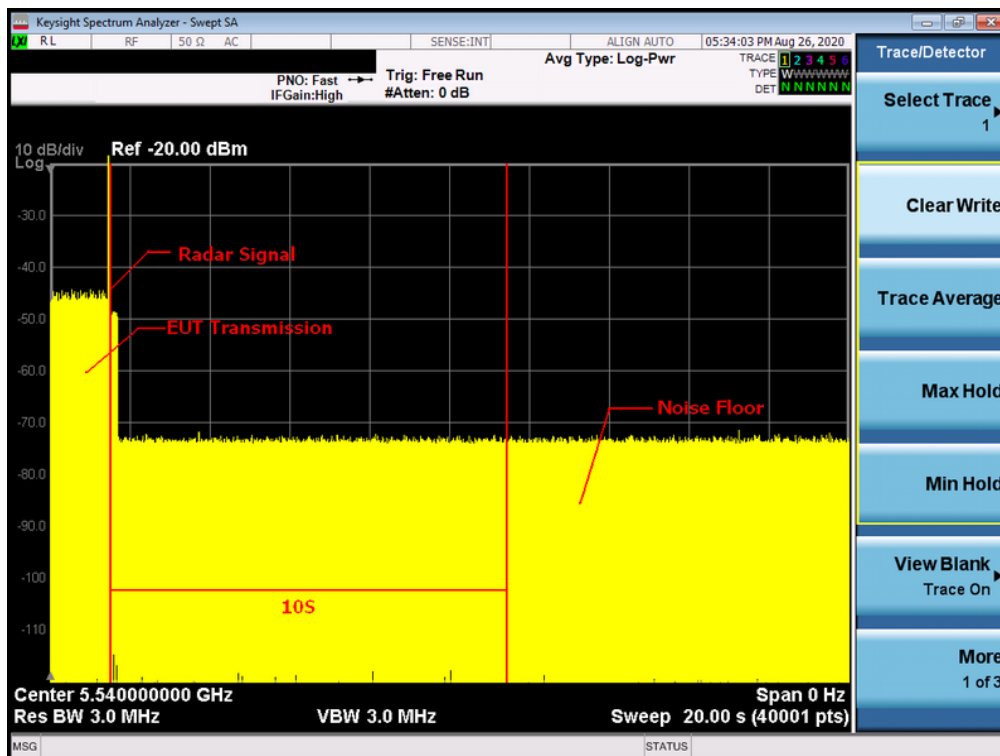

Note: An expanded plot for the device vacates the channel in the required 500ms

TX A Mode		
Item	Measured Value(s)	Limit(s)
Channel Move Time	0.2159946	10
Channel Close Time	0.0084998	200 milliseconds + an aggregate of 60 milliseconds over remaining 10 second period

5.5 NON-OCCUPANCY PERIOD

During the 30 minutes observation time, UUT did not make any transmissions on a channel after a radar signal was detected on that channel by either the Channel Availability Check or the In-Service Monitoring.

TX AMode 5540 Non-Occupancy period

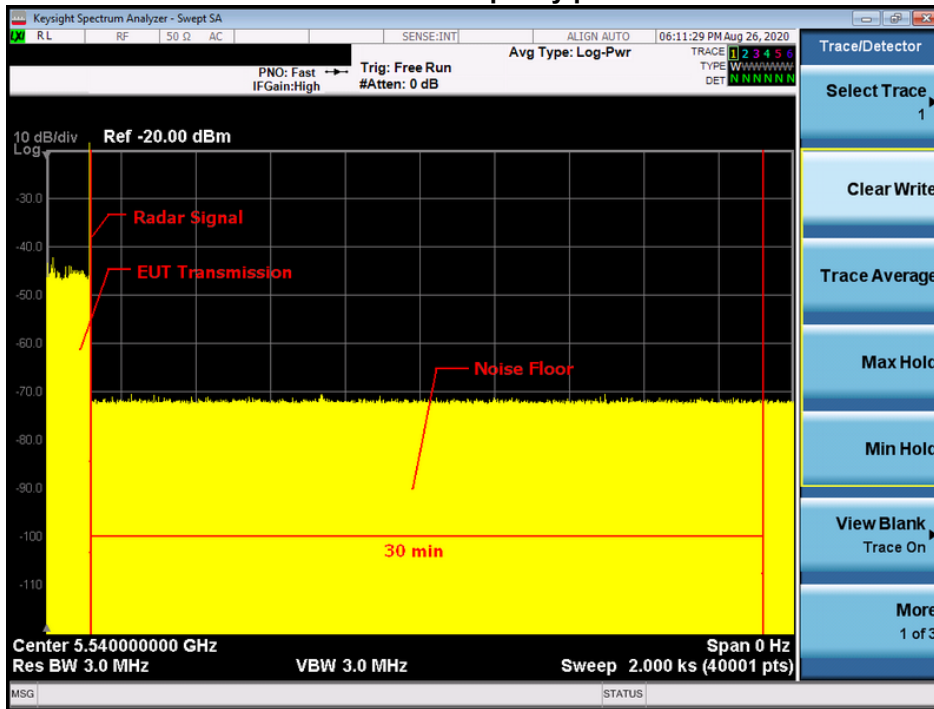

End of Test Report