

FCC Radio Test Report

FCC ID: RWO-RZ030282

This report concerns (check one): Original Grant Class I Change Class II Change

Project No. : 1810C143
Equipment : WIRELESS KEYBOARD
Test Model : RZ03-0282
Series Model : RZ03-0282XXXX-XXXX (X: Can be 0-9, A-Z)
Applicant : Razer Inc.
Address : 201 3rd Street, Suite 900, San Francisco, CA 94103
USA

Date of Receipt : Nov. 26, 2018
Date of Test : Nov. 26, 2018 ~ Dec. 07, 2018
Issued Date : Dec. 17, 2018
Tested by : BTL Inc.

Testing Engineer : Chay Cai
(Chay Cai)

Technical Manager : David Mao
(David Mao)

Authorized Signatory : Steven Lu
(Steven Lu)

B T L I N C .

No.3, Jinshagang 1st Road, Shixia, Dalang Town, Dongguan,
Guangdong, China.

TEL: +86-769-8318-3000 FAX: +86-769-8319-6000



Certificate #5123.02

Declaration

BTL represents to the client that testing is done in accordance with standard procedures as applicable and that test instruments used has been calibrated with standards traceable to international standard(s) and/or national standard(s).

BTL's reports apply only to the specific samples tested under conditions. It is manufacture's responsibility to ensure that additional production units of this model are manufactured with the identical electrical and mechanical components. **BTL** shall have no liability for any declarations, inferences or generalizations drawn by the client or others from **BTL** issued reports.

The report must not be used by the client to claim product certification, approval, or endorsement by NVLAP, NIST, A2LA, or any agency of the U.S. Government.

This report is the confidential property of the client. As a mutual protection to the clients, the public and ourselves, the test report shall not be reproduced, except in full, without our written approval.

BTL's laboratory quality assurance procedures are in compliance with the **ISO/IEC 17025** requirements, and accredited by the conformity assessment authorities listed in this test report.

BTL is not responsible for the sampling stage, so the results only apply to the sample as received.

The information, data and test plan are provided by manufacturer which may affect the validity of results, so it is manufacturer's responsibility to ensure that the apparatus meets the essential requirements of applied standards and in all the possible configurations as representative of its intended use.

Limitation

For the use of the authority's logo is limited unless the Test Standard(s)/Scope(s)/Item(s) mentioned in this test report is (are) included in the conformity assessment authorities acceptance respective.

Table of Contents	Page
1 . GENERAL SUMMARY	6
2 . SUMMARY OF TEST RESULTS	7
2.1 TEST FACILITY	8
2.2 MEASUREMENT UNCERTAINTY	8
3 . GENERAL INFORMATION	9
3.1 GENERAL DESCRIPTION OF EUT	9
3.2 DESCRIPTION OF TEST MODES	11
3.3 TABLE OF PARAMETERS OF TEST SOFTWARE SETTING	11
3.4 BLOCK DIAGRAM SHOWING THE CONFIGURATION OF SYSTEM TESTED	12
3.5 DESCRIPTION OF SUPPORT UNITS	13
4 . EMC EMISSION TEST	14
4.1 AC POWER LINE CONDUCTED EMISSION MEASUREMENT	14
4.1.1 AC POWER LINE CONDUCTED EMISSION LIMITS	14
4.1.2 TEST PROCEDURE	14
4.1.3 DEVIATION FROM TEST STANDARD	14
4.1.4 TEST SETUP	15
4.1.5 EUT OPERATING CONDITIONS	15
4.1.6 EUT TEST CONDITIONS	15
4.1.7 TEST RESULTS	15
4.2 RADIATED EMISSION MEASUREMENT	16
4.2.1 RADIATED EMISSION LIMITS	16
4.2.2 TEST PROCEDURE	17
4.2.3 DEVIATION FROM TEST STANDARD	17
4.2.4 TEST SETUP	18
4.2.5 EUT OPERATING CONDITIONS	19
4.2.6 EUT TEST CONDITIONS	19
4.2.7 TEST RESULTS (9KHZ TO 30MHZ)	19
4.2.8 TEST RESULTS (30MHZ TO 1000 MHZ)	20
4.2.9 TEST RESULTS (ABOVE 1000 MHZ)	20
5 . BANDWIDTH TEST	21
5.1 APPLIED PROCEDURES / LIMIT	21
5.1.1 TEST PROCEDURE	21
5.1.2 DEVIATION FROM STANDARD	21
5.1.3 TEST SETUP	21
5.1.4 EUT OPERATION CONDITIONS	21
5.1.5 EUT TEST CONDITIONS	21
5.1.6 TEST RESULTS	21
6 . MAXIMUM OUTPUT POWER TEST	22

Table of Contents	Page
6.1 APPLIED PROCEDURES / LIMIT	22
6.1.1 TEST PROCEDURE	22
6.1.2 DEVIATION FROM STANDARD	22
6.1.3 TEST SETUP	22
6.1.4 EUT OPERATION CONDITIONS	22
6.1.5 EUT TEST CONDITIONS	22
6.1.6 TEST RESULTS	22
7 . ANTENNA CONDUCTED SPURIOUS EMISSION	23
7.1 APPLIED PROCEDURES / LIMIT	23
7.1.1 TEST PROCEDURE	23
7.1.2 DEVIATION FROM STANDARD	23
7.1.3 TEST SETUP	23
7.1.4 EUT OPERATION CONDITIONS	23
7.1.5 EUT OPERATION CONDITIONS	23
7.1.6 TEST RESULTS	23
8 . POWER SPECTRAL DENSITY TEST	24
8.1 APPLIED PROCEDURES / LIMIT	24
8.1.1 TEST PROCEDURE	24
8.1.2 DEVIATION FROM STANDARD	24
8.1.3 TEST SETUP	24
8.1.4 EUT OPERATION CONDITIONS	24
8.1.5 EUT TEST CONDITIONS	24
8.1.6 TEST RESULTS	24
9 . MEASUREMENT INSTRUMENTS LIST	25
APPENDIX A - AC POWER LINE CONDUCTED EMISSION	27
APPENDIX B - RADIATED EMISSION (9KHZ TO 30MHZ)	32
APPENDIX C - RADIATED EMISSION (30MHZ TO 1000MHZ)	41
APPENDIX D - RADIATED EMISSION (ABOVE 1000MHZ)	46
APPENDIX E - BANDWIDTH	59
APPENDIX F - MAXIMUM OUTPUT POWER TEST	62
APPENDIX G - ANTENNA CONDUCTED SPURIOUS EMISSION	65
APPENDIX H - POWER SPECTRAL DENSITY TEST	69

REPORT ISSUED HISTORY

Report Version	Description	Issued Date
R00	Original Issue.	Dec. 17, 2018

1. GENERAL SUMMARY

Equipment : WIRELESS KEYBOARD
Brand Name : RAZER
Test Model : RZ03-0282
Series Model : RZ03-0282XXXX-XXXX (X: Can be 0-9, A-Z)
Applicant : Razer Inc.
Manufacturer : Razer (Asia-Pacific) Pte.,Ltd.
Address : 514 Chai Chee Lane, #07-01-06, Singapore 469029
Factory : RAZER TECHNOLOGY AND DEVELOPMENT (SHENZHEN) CO., LTD
Address : East Wing, 3rd Floor, Block 2, Phase 1 of Vision Shenzhen Business Park Keji South Road, Hi-Tech Industrial Park, Shenzhen 518057, China
Date of Test : Nov. 26, 2018 ~ Dec. 07, 2018
Test Sample : Engineering Sample No.: D181110847 for conducted, D181110850 for radiated.
Standard(s) : FCC Part15, Subpart C (15.247) / ANSI C63.10-2013

The above equipment has been tested and found compliance with the requirement of the relative standards by BTL Inc.

The test data, data evaluation, and equipment configuration contained in our test report (Ref No. BTL-FCCP-1-1810C143) were obtained utilizing the test procedures, test instruments, test sites that has been accredited by the Authority of A2LA according to the ISO/IEC 17025 quality assessment standard and technical standard(s).

2. SUMMARY OF TEST RESULTS

Test procedures according to the technical standard(s):

Applied Standard(s): FCC Part15 (15.247) , Subpart C			
Standard(s) Section	Test Item	Judgment	Remark
15.207	AC Power Line Conducted Emission	PASS	
15.247(d)	Antenna conducted Spurious Emission	PASS	
15.247(a)(2)	6dB Bandwidth	PASS	
15.247(b)(3)	Maximum Output Power	PASS	
15.247(e)	Power Spectral Density	PASS	
15.203	Antenna Requirement	PASS	
15.209/15.205	Transmitter Radiated Emissions	PASS	
15.209/15.205	Band Edge Emissions	PASS	

NOTE:

(1) "N/A" denotes test is not applicable to this device.

2.1 TEST FACILITY

The test facilities used to collect the test data in this report is at the location of No.3, Jinshagang 1st Road, Shixia, Dalang Town, Dongguan, Guangdong, China.

BTL's test firm number for FCC: 854385

BTL's designation number for FCC: CN5020

2.2 MEASUREMENT UNCERTAINTY

The measurement uncertainty figures shall be calculated according the methods described in the ETSI TR 100 028 and shall correspond to an expansion factor (coverage factor) $k=1.96$ or $k=2$ (which provide confidence levels of respectively 90% and 95.45% in the case where the distributions characterizing the actual measurement uncertainties are normal (Gaussian)). Measurement Uncertainty for a Level of Confidence of 95 %, $U=2xUc(y)$.

The BTL measurement uncertainty as below table:

A. AC Power Line Conducted Measurement:

Test Site	Method	Measurement Frequency Range	U, (dB)
DG-C02	CISPR	150 KHz ~ 30MHz	2.32

B. Radiated Measurement:

Test Site	Method	Measurement Frequency Range	Ant. H / V	U, (dB)
DG-CB03	CISPR	9KHz~30MHz	V	3.79
		9KHz~30MHz	H	3.57
		30MHz ~ 200MHz	V	3.82
		30MHz ~ 200MHz	H	3.78
		200MHz ~ 1,000MHz	V	4.10
		200MHz ~ 1,000MHz	H	4.06
		1GHz~18GHz	V	3.12
		1GHz~18GHz	H	3.68
		18GHz~40GHz	V	4.15
		18GHz~40GHz	H	4.14

Note: Unless specifically mentioned, the uncertainty of measurement has not been taken into account to declare the compliance or non-compliance to the specification.

3. GENERAL INFORMATION

3.1 GENERAL DESCRIPTION OF EUT

Equipment	WIRELESS KEYBOARD	
Brand Name	RAZER	
Test Model	RZ03-0282	
Series Model	RZ03-0282XXXX-XXXX (X: Can be 0-9, A-Z)	
Model Difference	It is the same as the basic model and X is used to define which country it is for under the same family series. The system model name is RZ84-0282, it consists of a Wireless Transceiver (DGRFG6), Wireless Mouse (RZ01-0282) and WIRELESS KEYBOARD (RZ03-0282).	
Power Source	1# DC voltage supplied from AC/DC adapter. Model: KSA29A0500250D5 2# Supplied from battery. Model: FT5936E2P	
Power Rating	1# I/P: 100-240V ~50/60Hz 0.5A O/P: 5V --- 2.5A 2# DC 3.7V, 4200mAh 15.54Wh	
Product Description	Operation Frequency	2403 MHz - 2479 MHz
	Modulation Technology	GFSK
	Bit Rate of Transmitter	2 Mbps
	Output Power (Max.)	4.23 dBm (0.0026 W)

Note:

1. For a more detailed features description, please refer to the manufacturer's specifications or the user's manual.

2. Channel List:

Channel	Frequency (MHz)	Channel	Frequency (MHz)	Channel	Frequency (MHz)
01	2403	27	2429	53	2455
02	2404	28	2430	54	2456
03	2405	29	2431	55	2457
04	2406	30	2432	56	2458
05	2407	31	2433	57	2459
06	2408	32	2434	58	2460
07	2409	33	2435	59	2461
08	2410	34	2436	60	2462
09	2411	35	2437	61	2463
10	2412	36	2438	62	2464
11	2413	37	2439	63	2465
12	2414	38	2440	64	2466
13	2415	39	2441	65	2467
14	2416	40	2442	66	2468
15	2417	41	2443	67	2469
16	2418	42	2444	68	2470
17	2419	43	2445	69	2471
18	2420	44	2446	70	2472
19	2421	45	2447	71	2473
20	2422	46	2448	72	2474
21	2423	47	2449	73	2475
22	2424	48	2450	74	2476
23	2425	49	2451	75	2477
24	2426	50	2452	76	2478
25	2427	51	2453	77	2479
26	2428	52	2454		

3. Table for Filed Antenna:

Ant.	Brand	Model Name	Antenna Type	Connector	Gain (dBi)
1	N/A	N/A	Internal	N/A	4.57

3.2 DESCRIPTION OF TEST MODES

To investigate the maximum EMI emission characteristics generates from EUT, the test system was pre-scanning tested base on the consideration of following EUT operation mode or test configuration mode which possible have effect on EMI emission level. Each of these EUT operation mode(s) or test configuration mode(s) mentioned above was evaluated respectively.

Pretest Mode	Description
Mode 1	TX Mode

The EUT system operated these modes were found to be the worst case during the pre-scanning test as following:

For Conducted Test	
Final Test Mode	Description
Mode 1	TX Mode

For Radiated Test	
Final Test Mode	Description
Mode 1	TX Mode

Note:

- (1) The measurements are performed at the high, middle, low available channels.
- (2) For AC Power Line Conducted Emission and radiated 9 kHz to 1000 MHz test, the low available channel is found to be the worst case and recorded.

3.3 TABLE OF PARAMETERS OF TEST SOFTWARE SETTING

During testing channel & power controlling software provided by the customer was used to control the operating channel as well as the output power level. The RF output power selection is for the setting of RF output power expected by the customer and is going to be fixed on the firmware of the final end product power parameters of WLAN

Test Software Version	N/A		
Frequency (MHz)	2403	2440	2479
Parameters	N/A	N/A	N/A

3.4 BLOCK DIAGRAM SHOWING THE CONFIGURATION OF SYSTEM TESTED For Adapter

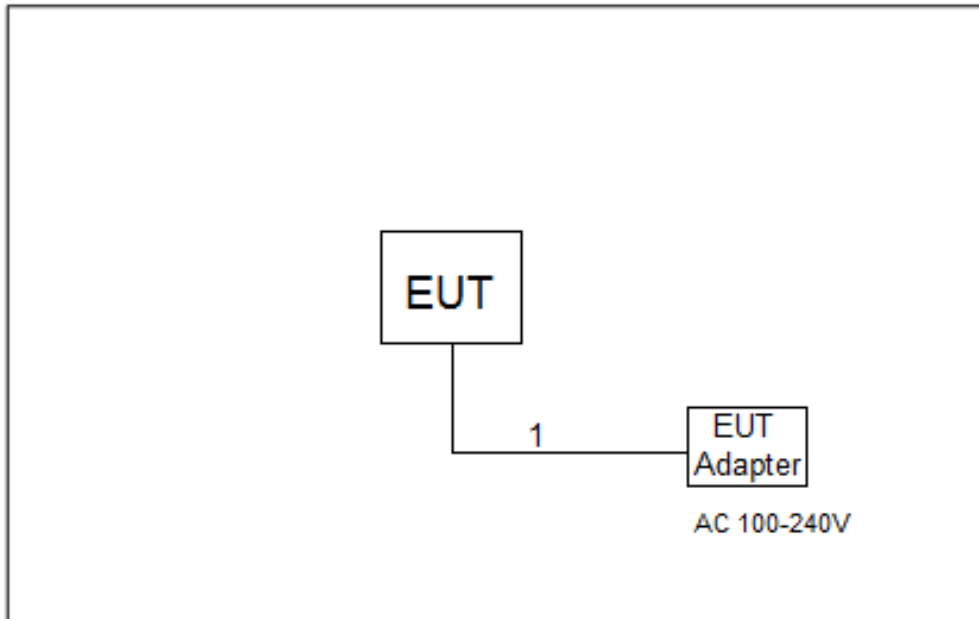

For PC

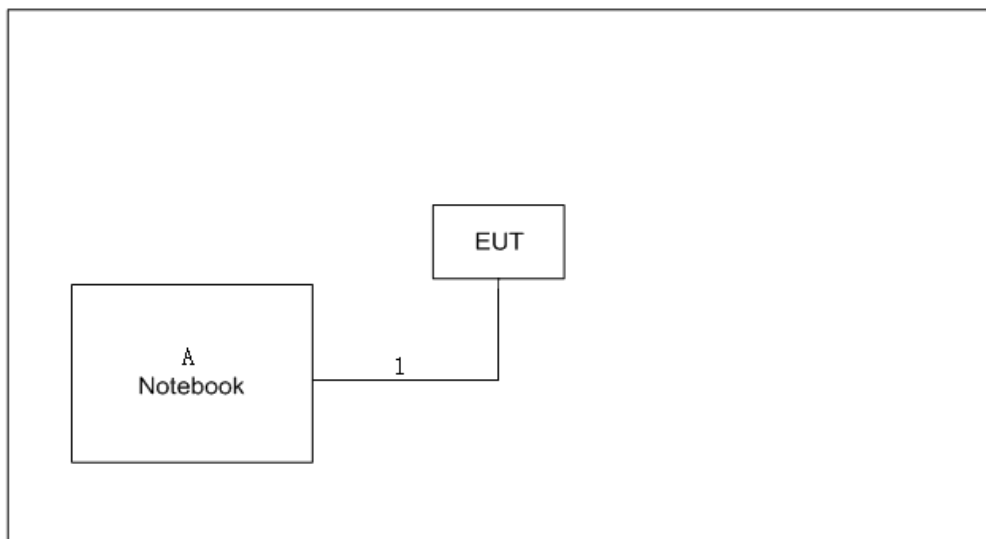

3.5 DESCRIPTION OF SUPPORT UNITS

The EUT has been tested as an independent unit together with other necessary accessories or support units. The following support units or accessories were used to form a representative test configuration during the tests.

For Adapter

Item	Equipment	Mfr/Brand	Model/Type No.	FCC ID	Series No.
-	-	-	-	-	-

Item	Shielded Type	Ferrite Core	Length	Note
1	YES	NO	2m	DC Cable

For PC

Item	Equipment	Mfr/Brand	Model/Type No.	FCC ID	Series No.
A	Notebook	Lenovo	V310-14ISK	N/A	LR07GZNB

Item	Shielded Type	Ferrite Core	Length	Note
1	YES	NO	2m	USB Cable

4. EMC EMISSION TEST

4.1 AC POWER LINE CONDUCTED EMISSION MEASUREMENT

4.1.1 AC POWER LINE CONDUCTED EMISSION (Frequency Range 150KHz-30MHz) LIMITS

Frequency of Emission (MHz)	Conducted Limit (dB μ V)	
	Quasi-peak	Average
0.15 -0.50	66 to 56*	56 to 46*
0.50 - 5.0	56	46
5.0 -30.0	60	50

Note:

- (1) The limit of " * " decreases with the logarithm of the frequency
- (2) The test result calculated as following:
 Measurement Value = Reading Level + Correct Factor
 Correct Factor = Insertion Loss + Cable Loss + Attenuator Factor(if use)
 Margin Level = Measurement Value - Limit Value

The following table is the setting of the receiver

Receiver Parameters	Setting
Attenuation	10 dB
Start Frequency	0.15 MHz
Stop Frequency	30 MHz
IF Bandwidth	9 kHz

4.1.2 TEST PROCEDURE

- a. The EUT was placed 0.8 meters from the horizontal ground plane with EUT being connected to the power mains through a line impedance stabilization network (LISN). All other support equipments powered from additional LISN(s). The LISN provide 50 Ohm/ 50uH of coupling impedance for the measuring instrument.
- b. Interconnecting cables that hang closer than 40 cm to the ground plane shall be folded back and forth in the center forming a bundle 30 to 40 cm long.
- c. I/O cables that are not connected to a peripheral shall be bundled in the center. The end of the cable may be terminated, if required, using the correct terminating impedance. The overall length shall not exceed 1 m.
- d. LISN at least 80 cm from nearest part of EUT chassis.
- e. For the actual test configuration, please refer to the related Item –EUT Test Photos.

4.1.3 DEVIATION FROM TEST STANDARD

No deviation

4.1.4 TEST SETUP

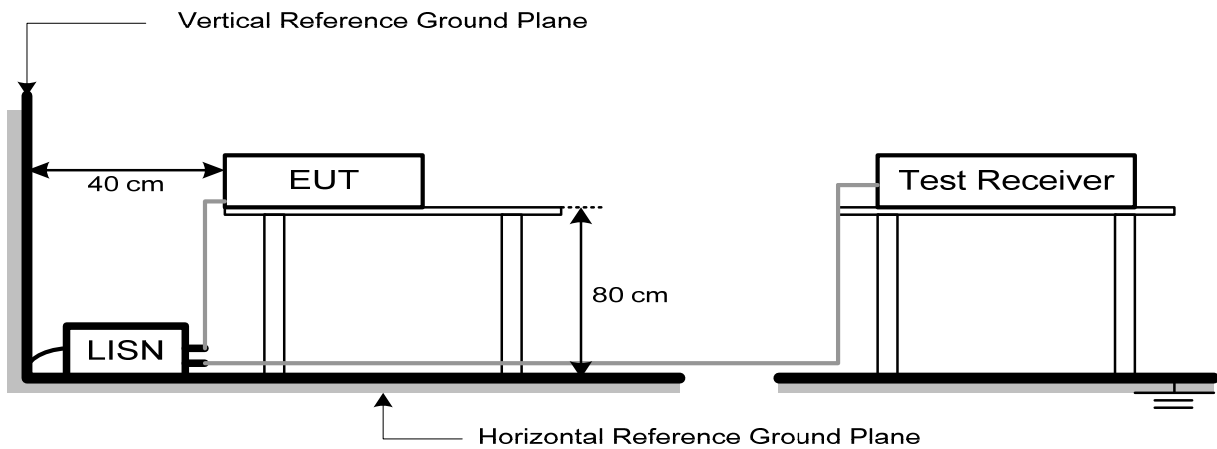

4.1.5 EUT OPERATING CONDITIONS

The EUT was configured for testing in a typical fashion (as a customer would normally use it). The EUT has been programmed to continuously transmit during test. This operating condition was tested and used to collect the included data.

4.1.6 EUT TEST CONDITIONS

Temperature: 25°C Relative Humidity: 53% Test Voltage: AC 120V/60Hz

4.1.7 TEST RESULTS

Please refer to the Appendix A.

Remark:

- (1) All readings are QP Mode value unless otherwise stated AVG in column of『Note』. If the QP Mode Measured value compliance with the QP Limits and lower than AVG Limits, the EUT shall be deemed to meet both QP & AVG Limits and then only QP Mode was measured, but AVG Mode didn't perform. In this case, a “ * ” marked in AVG Mode column of Interference Voltage Measured.
- (2) Measuring frequency range from 150KHz to 30MHz.
- (3) “ N/A ” denotes test is not applicable to this device.

4.2 RADIATED EMISSION MEASUREMENT

4.2.1 RADIATED EMISSION LIMITS

In case the emission fall within the restricted band specified on 15.205(a), then the 15.209(a) limit in the table below has to be followed.

LIMITS OF RADIATED EMISSION MEASUREMENT (9KHz-1000MHz)

Frequency (MHz)	Field Strength (microvolts/meter)	Measurement Distance (meters)
0.009~0.490	2400/F(KHz)	300
0.490~1.705	24000/F(KHz)	30
1.705~30.0	30	30
30~88	100	3
88~216	150	3
216~960	200	3
960~1000	500	3

LIMITS OF RADIATED EMISSION MEASUREMENT (Above 1000MHz)

Frequency (MHz)	(dBuV/m) (at 3 meters)	
	PEAK	AVERAGE
Above 1000	74	54

Notes:

- (1) The limit for radiated test was performed according to FCC PART 15C.
- (2) The tighter limit applies at the band edges.
- (3) Emission level (dBuV/m)=20log Emission level (uV/m).
- (4) The test result calculated as following:
 Measurement Value = Reading Level + Correct Factor
 Correct Factor = Antenna Factor + Cable Loss - Amplifier Gain(if use)
 Margin Level = Measurement Value - Limit Value

Spectrum Parameter	Setting
Attenuation	Auto
Start Frequency	1000 MHz
Stop Frequency	10th carrier harmonic
RBW / VBW (Emission in restricted band)	RBW 1MHz VBW 3MHz peak detector for Pk value RMS detector for AV value

Receiver Parameter	Setting
Attenuation	Auto
Start ~ Stop Frequency	9KHz~90KHz for PK/AVG detector
Start ~ Stop Frequency	90KHz~110KHz for QP detector
Start ~ Stop Frequency	110KHz~490KHz for PK/AVG detector
Start ~ Stop Frequency	490KHz~30MHz for QP detector
Start ~ Stop Frequency	30MHz~1000MHz for QP detector

4.2.2 TEST PROCEDURE

- a. The measuring distance of 3 m shall be used for measurements. The EUT was placed on the top of a rotating table 0.8 meter above the ground at a 3 meter semi-anechoic chamber. The table was rotated 360 degrees to determine the position of the highest radiation.(below 1GHz)
- b. The measuring distance of 3 m shall be used for measurements. The EUT was placed on the top of a rotating table 1.5 meter above the ground at a 3 meter semi-anechoic chamber. The table was rotated 360 degrees to determine the position of the highest radiation.(above 1GHz)
- c. The height of the equipment or of the substitution antenna shall be 0.8 m or 1.5 m, the height of the test antenna shall vary between 1 m to 4 m. Both horizontal and vertical polarizations of the antenna are set to make the measurement.
- d. The initial step in collecting radiated emission data is a receiver peak detector mode pre-scanning the measurement frequency range. Significant peaks are then marked and then Quasi Peak detector mode re-measured.
- e. All readings are Peak unless otherwise stated QP in column of Note. Peak denotes that the Peak reading compliance with the QP Limits and then QP Mode measurement didn't perform. (below 1GHz)
- f. All readings are Peak Mode value unless otherwise stated AVG in column of Note. If the Peak Mode Measured value compliance with the Peak Limits and lower than AVG Limits, the EUT shall be deemed to meet both Peak & AVG Limits and then only Peak Mode was measured, but AVG Mode didn't perform. (above 1GHz)
- g. For the actual test configuration, please refer to the related Item –EUT Test Photos.

4.2.3 DEVIATION FROM TEST STANDARD

No deviation

4.2.4 TEST SETUP

(A) Radiated Emission Test Set-Up Frequency Below 1 GHz

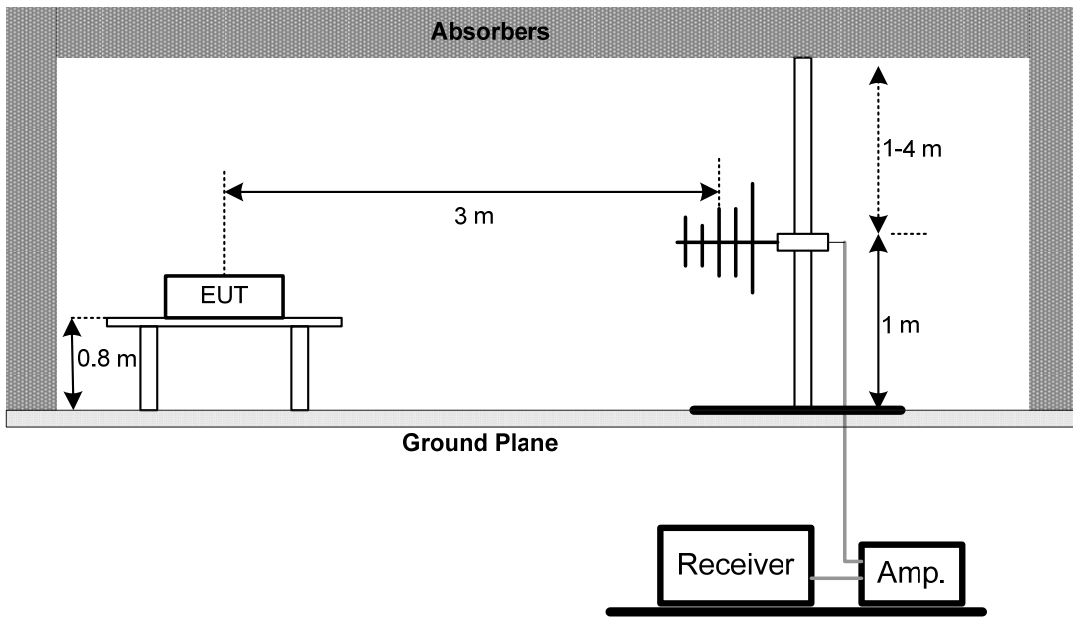

(B) Radiated Emission Test Set-Up Frequency Above 1 GHz

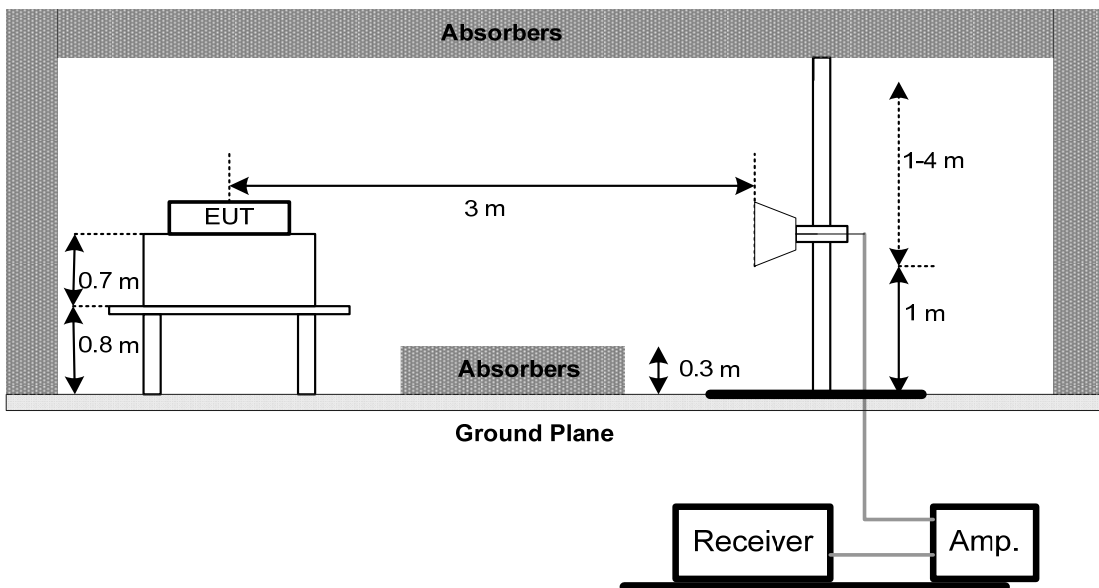

(C) For radiated emissions below 30MHz

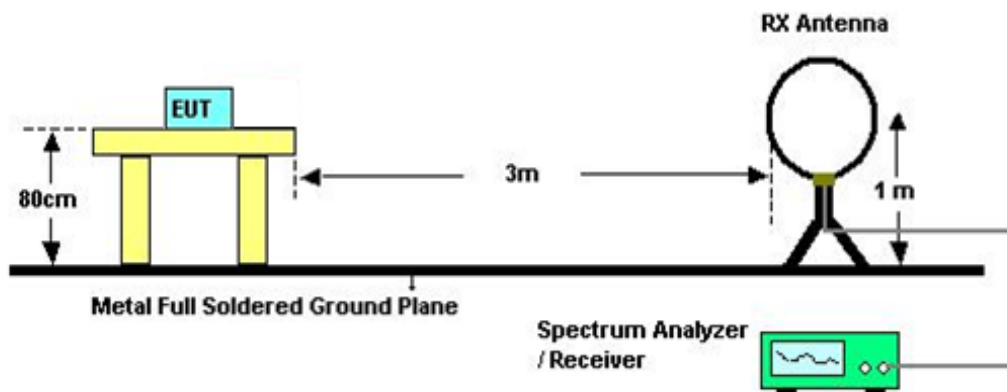

4.2.5 EUT OPERATING CONDITIONS

The EUT tested system was configured as the statements of 4.1.5 unless otherwise a special operating condition is specified in the follows during the testing.

4.2.6 EUT TEST CONDITIONS

Temperature: 25°C Relative Humidity: 60% Test Voltage: DC 5V

4.2.7 TEST RESULTS (9KHZ TO 30MHZ)

Please refer to the Appendix B

Remark:

- (1) The amplitude of spurious emissions which are attenuated by more than 20 dB below the permissible value has no need to be reported.
- (2) Distance extrapolation factor = $40 \log (\text{specific distance} / \text{test distance})$ (dB).
- (3) Limit line = specific limits (dBuV) + distance extrapolation factor.

4.2.8 TEST RESULTS (30MHZ TO 1000 MHZ)

Please refer to the Appendix C.

Remark:

- (1) All readings are Peak unless otherwise stated QP in column of 『Note』 . Peak denotes that the Peak reading compliance with the QP Limits and then QP Mode measurement didn't perform.
- (2) Measuring frequency range from 30MHz to 1000MHz.
- (3) If the peak scan value lower limit more than 20dB, then this signal data does not show in table.

4.2.9 TEST RESULTS (ABOVE 1000 MHZ)

Please refer to the Appendix D.

Remark:

- (1) All readings are Peak unless otherwise stated QP in column of 『Note』 . Peak denotes that the Peak reading compliance with the QP Limits and then QP Mode measurement didn't perform.
- (2) Radiated emissions measured in frequency range above 1000MHz were made with an instrument using Peak detector mode and AV detector mode of the emission
- (3) A preamp and high pass filter were used for this test in order to provide sufficient measurement sensitivity.
- (4) EUT Orthogonal Axis:
"X" - denotes Laid on Table ; "Y" - denotes Vertical Stand ; "Z" - denotes Side Stand
- (5) During the measurements above 1 GHz it is taken care of that the EUT is always within the 3 dB cone of radiation BW of the used antenna
- (6) No limit: This is fundamental signal, the judgment is not applicable.
For fundamental signal judgment was referred to Peak output test.

5. BANDWIDTH TEST

5.1 APPLIED PROCEDURES / LIMIT

FCC Part15 (15.247) , Subpart C				
Section	Test Item	Limit	Frequency Range (MHz)	Result
15.247(a)(2)	Bandwidth	$\geq 500\text{KHz}$ (6dB bandwidth)	2400-2483.5	PASS

5.1.1 TEST PROCEDURE

- The EUT was directly connected to the spectrum analyzer and antenna output port as show in the block diagram below,
- Spectrum Setting : RBW= 100KHz, VBW=300KHz, Sweep time = 2.5 ms.

5.1.2 DEVIATION FROM STANDARD

No deviation.

5.1.3 TEST SETUP



5.1.4 EUT OPERATION CONDITIONS

The EUT tested system was configured as the statements of 4.1.5 unless otherwise a special operating condition is specified in the follows during the testing.

5.1.5 EUT TEST CONDITIONS

Temperature: 26°C Relative Humidity: 35% Test Voltage: DC 5V

5.1.6 TEST RESULTS

Please refer to the Appendix E.

6. MAXIMUM OUTPUT POWER TEST

6.1 APPLIED PROCEDURES / LIMIT

FCC Part15 (15.247) , Subpart C				
Section	Test Item	Limit	Frequency Range (MHz)	Result
15.247(b)(3)	Maximum Output Power	1 watt or 30dBm	2400-2483.5	PASS

6.1.1 TEST PROCEDURE

- a. The EUT was directly connected to the spectrum analyzer and antenna output port as show in the block diagram below,
- b. The maximum output power was performed in accordance with method 11.9.2.2 of ANSI C63.10.

6.1.2 DEVIATION FROM STANDARD

No deviation.

6.1.3 TEST SETUP

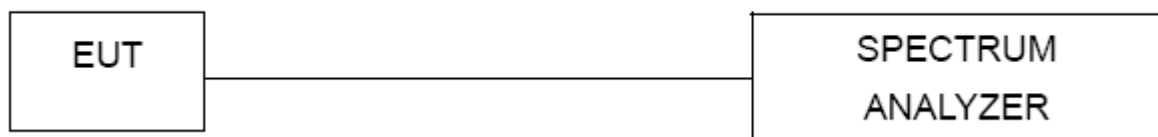

6.1.4 EUT OPERATION CONDITIONS

The EUT tested system was configured as the statements of 4.1.5 unless otherwise a special operating condition is specified in the follows during the testing.

6.1.5 EUT TEST CONDITIONS

Temperature: 26°C Relative Humidity: 35% Test Voltage: DC 5V

6.1.6 TEST RESULTS

Please refer to the Appendix F.

7. ANTENNA CONDUCTED SPURIOUS EMISSION

7.1 APPLIED PROCEDURES / LIMIT

In any 100 kHz bandwidth outside the frequency band in which the spread spectrum or digitally modulated intentional radiator is operating, the radio frequency power that is produced by the intentional radiator shall be at least 20 dB below that in the 100 kHz bandwidth within the band that contains the highest level of the desired power, based on either an RF conducted or a radiated measurement, provided the transmitter demonstrates compliance with the peak conducted powerlimits. If the transmitter complies with the conducted power limits based on these of RMS averaging over a time interval, as permitted under paragraph (b)(3) of this section, the attenuation required under this paragraph shall be 30 dB instead of 20 dB. Attenuation below the general limits specified in Section 15.209(a) is not required. In addition, radiated emissions which fall in the restricted bands, as defined in Section 15.205(a), must also comply with the radiated emission limits specified in Section 15.209(a) (see Section 15.205(c)).

7.1.1 TEST PROCEDURE

- a. The EUT was directly connected to the spectrum analyzer and antenna output port as show in the block diagram below,
- b. Spectrum Setting : RBW= 100KHz, VBW=300KHz, Sweep time = auto.

7.1.2 DEVIATION FROM STANDARD

No deviation.

7.1.3 TEST SETUP

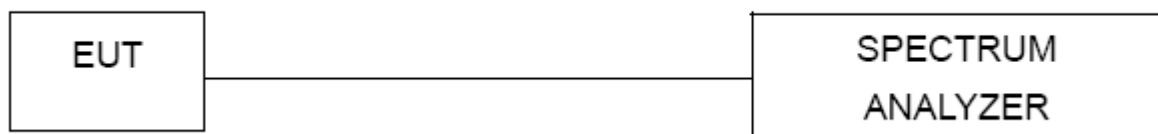

7.1.4 EUT OPERATION CONDITIONS

The EUT tested system was configured as the statements of 4.1.5 unless otherwise a special operating condition is specified in the follows during the testing.

7.1.5 EUT OPERATION CONDITIONS

Temperature: 26°C Relative Humidity: 35% Test Voltage: DC 5V

7.1.6 TEST RESULTS

Please refer to the Appendix G.

8. POWER SPECTRAL DENSITY TEST

8.1 APPLIED PROCEDURES / LIMIT

FCC Part15 (15.247) , Subpart C				
Section	Test Item	Limit	Frequency Range (MHz)	Result
15.247(e)	Power Spectral Density	8 dBm (in any 3KHz)	2400-2483.5	PASS

8.1.1 TEST PROCEDURE

- a. The EUT was directly connected to the spectrum analyzer and antenna output port as show in the block diagram below,
- b. Spectrum Setting: RBW=3KHz, VBW=10 KHz, Sweep time = auto.

8.1.2 DEVIATION FROM STANDARD

No deviation.

8.1.3 TEST SETUP

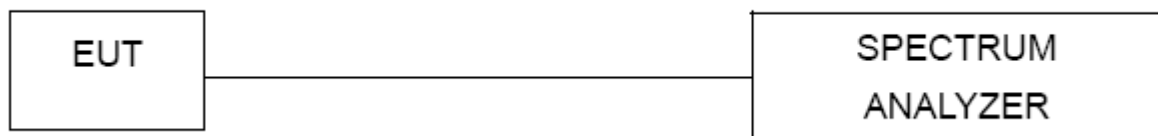

8.1.4 EUT OPERATION CONDITIONS

The EUT tested system was configured as the statements of 4.1.5 unless otherwise a special operating condition is specified in the follows during the testing.

8.1.5 EUT TEST CONDITIONS

Temperature: 26°C Relative Humidity: 35% Test Voltage: DC 5V

8.1.6 TEST RESULTS

Please refer to the Appendix H.

9. MEASUREMENT INSTRUMENTS LIST

AC Power Line Conducted Emission Measurement					
Item	Kind of Equipment	Manufacturer	Type No.	Serial No.	Calibrated until
1	EMI Test Receiver	R&S	ESCI	100382	Mar. 11, 2019
2	LISN	EMCO	3816/2	52765	Mar. 11, 2019
3	50Ω Terminator	SHX	TF2-3G-A	8122901	Mar. 11, 2019
4	TWO-LINE V-NETWORK	R&S	ENV216	101447	Mar. 11, 2019
5	Measurement Software	Farad	EZ-EMC Ver.NB-03A1-01	N/A	N/A
6	Cable	N/A	RG223	12m	Mar. 23, 2019

Radiated Emission Measurement-9 kHz TO 30 MHz					
Item	Kind of Equipment	Manufacturer	Type No.	Serial No.	Calibrated until
1	Loop Antenna	EM	EM-6876-1	230	Feb. 07, 2019
2	Cable	N/A	RG 213/U	C-102	Jun. 01, 2019
3	EMI Test Receiver	R&S	ESCI	100382	Mar. 11, 2019
4	Measurement Software	Farad	EZ-EMC Ver.NB-03A1-01	N/A	N/A

Radiated Emission Measurement-30 MHz TO 1000 MHz					
Item	Kind of Equipment	Manufacturer	Type No.	Serial No.	Calibrated until
1	Antenna	Schwarbeck	VULB9160	9160-3232	Mar. 11, 2019
2	Amplifier	HP	8447D	2944A09673	Aug. 11, 2019
3	Receiver	Agilent	N9038A	MY52130039	Aug. 11, 2019
4	Cable	emci	LMR-400(30MHz-1 GHz)(8m+5m)	N/A	May 25, 2019
5	Controller	CT	SC100	N/A	N/A
6	Controller	MF	MF-7802	MF780208416	N/A
7	Measurement Software	Farad	EZ-EMC Ver.NB-03A1-01	N/A	N/A

Radiated Emission Measurement - Above 1GHz					
Item	Kind of Equipment	Manufacturer	Type No.	Serial No.	Calibrated until
1	Double Ridged Guide Antenna	ETS	3115	75789	Mar. 11, 2019
2	Broad-Band Horn Antenna	Schwarzbeck	BBHA 9170	9170319	Jun. 30, 2019
3	Amplifier	Agilent	8449B	3008A02274	Mar. 11, 2019
4	Microwave Preamplifier With Adaptor	EMC INSTRUMENT	EMC2654045	980039 & HA01	Mar. 11, 2019
5	Receiver	Agilent	N9038A	MY52130039	Aug. 11, 2019
6	Controller	CT	SC100	N/A	N/A
7	Controller	MF	MF-7802	MF780208416	N/A
8	Cable	mitron	B10-01-01-12M	18072744	Jul. 30, 2019
9	Measurement Software	Farad	EZ-EMC Ver.NB-03A1-01	N/A	N/A

6 dB Bandwidth					
Item	Kind of Equipment	Manufacturer	Type No.	Serial No.	Calibrated until
1	Spectrum Analyzer	R&S	FSP40	100185	Aug. 11, 2019

Maximum output power					
Item	Kind of Equipment	Manufacturer	Type No.	Serial No.	Calibrated until
1	Spectrum Analyzer	R&S	FSP40	100185	Aug. 11, 2019

Antenna Conducted Spurious Emission					
Item	Kind of Equipment	Manufacturer	Type No.	Serial No.	Calibrated until
1	Spectrum Analyzer	R&S	FSP40	100185	Aug. 11, 2019

Power Spectral Density					
Item	Kind of Equipment	Manufacturer	Type No.	Serial No.	Calibrated until
1	Spectrum Analyzer	R&S	FSP40	100185	Aug. 11, 2019

Remark: "N/A" denotes no model name, serial no. or calibration specified.
 All calibration period of equipment list is one year.

APPENDIX A - AC POWER LINE CONDUCTED EMISSION

Test Mode: TX Mode_2403 MHz_Supplied from Adapter.

Line

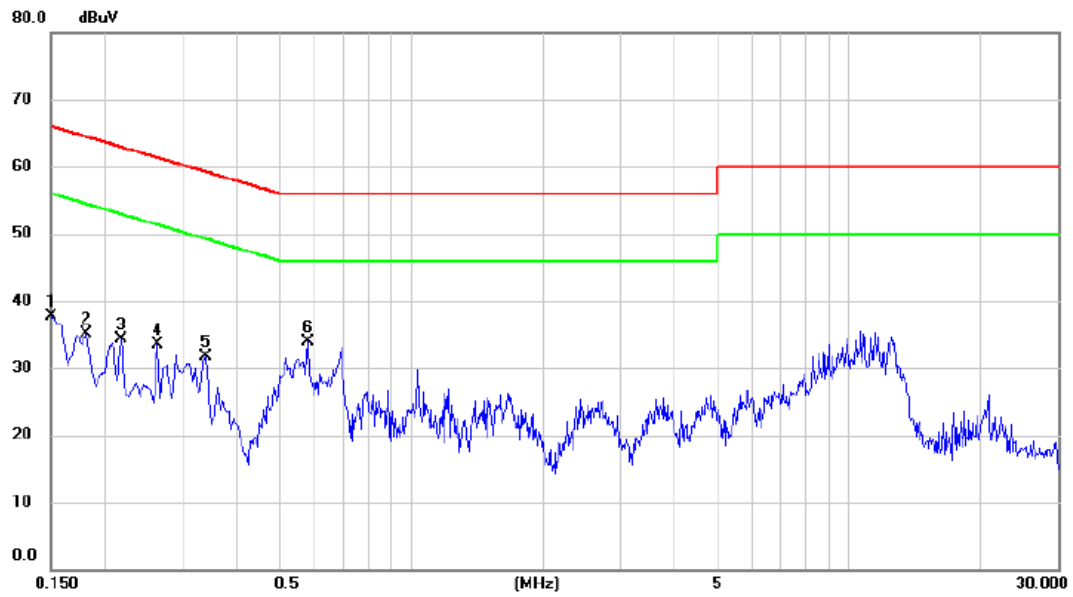

No.	Mk.	Freq. MHz	Reading Level dBuV	Correct Factor dB	Measure- ment dBuV	Limit dBuV	Margin dB	Detector	Comment
1		0.1500	27.90	9.82	37.72	66.00	-28.28	peak	
2		0.1815	25.30	9.83	35.13	64.42	-29.29	peak	
3		0.2175	24.45	9.82	34.27	62.91	-28.64	peak	
4		0.2625	23.72	9.82	33.54	61.35	-27.81	peak	
5		0.3390	21.93	9.81	31.74	59.23	-27.49	peak	
6	*	0.5820	24.00	9.82	33.82	56.00	-22.18	peak	

Test Mode: TX Mode_2403 MHz_Supplied from Adapter.

Neutral

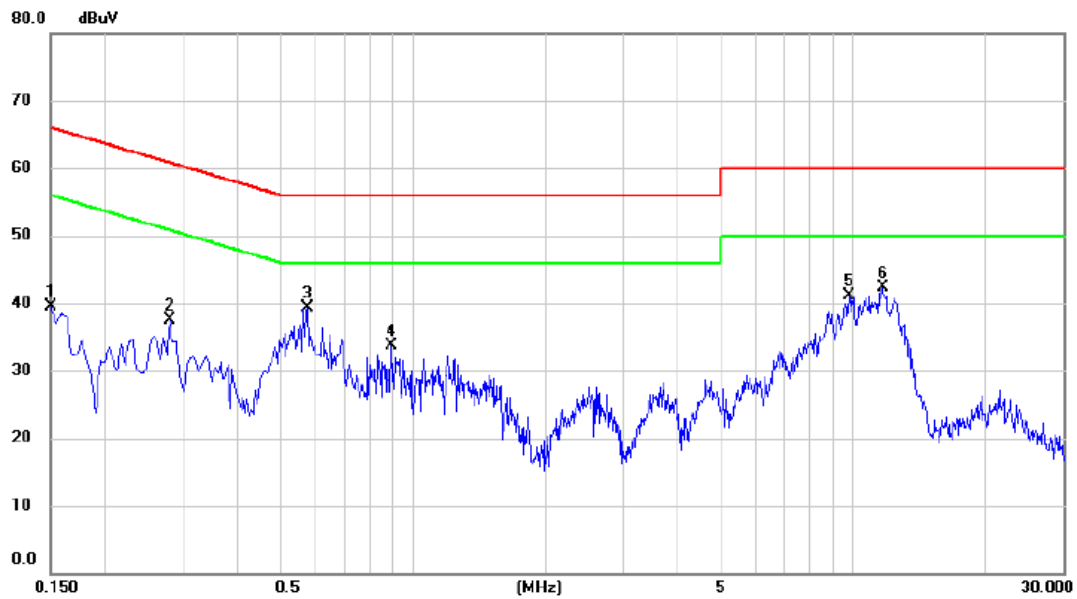

No.	Mk.	Freq. MHz	Reading Level dBuV	Correct Factor dB	Measure- ment dBuV	Limit dBuV	Margin dB	Detector	Comment
1		0.1500	29.60	9.91	39.51	66.00	-26.49	peak	
2		0.2805	27.52	9.92	37.44	60.80	-23.36	peak	
3	*	0.5775	29.41	9.97	39.38	56.00	-16.62	peak	
4		0.8925	23.68	10.09	33.77	56.00	-22.23	peak	
5		9.7620	30.35	10.72	41.07	60.00	-18.93	peak	
6		11.6700	31.40	10.86	42.26	60.00	-17.74	peak	

Test Mode: TX Mode_2403 MHz_Supplied from PC USB port.

Line

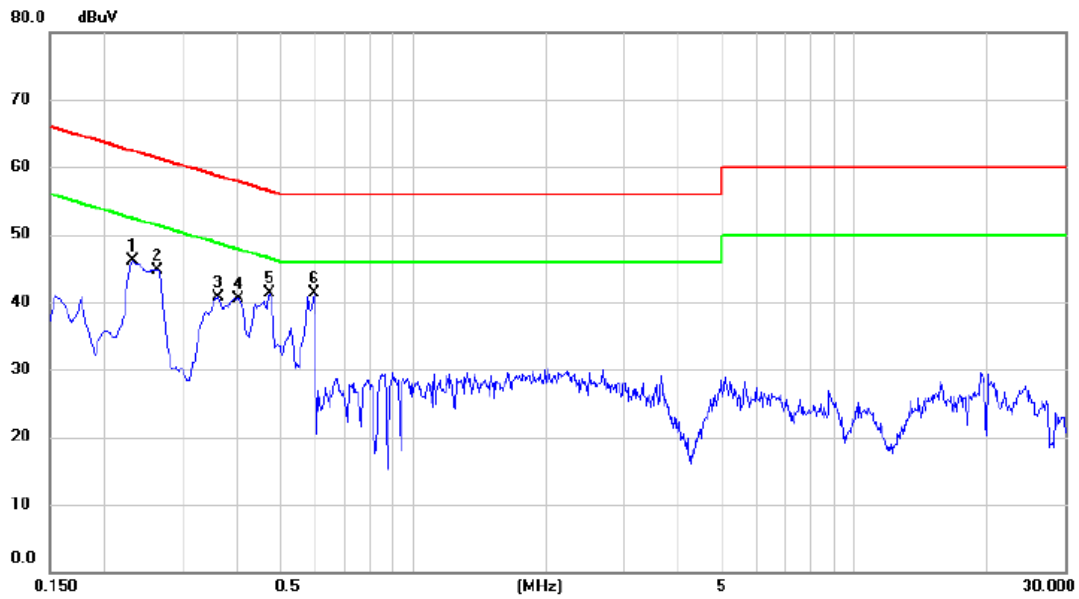

No.	Mk.	Freq. MHz	Reading Level dBuV	Correct Factor dB	Measure- ment dBuV	Limit dBuV	Margin dB	Detector	Comment
1		0.2310	36.24	9.82	46.06	62.41	-16.35	peak	
2		0.2625	34.91	9.82	44.73	61.35	-16.62	peak	
3		0.3615	30.89	9.81	40.70	58.69	-17.99	peak	
4		0.4020	30.74	9.81	40.55	57.81	-17.26	peak	
5		0.4740	31.51	9.80	41.31	56.44	-15.13	peak	
6	*	0.5955	31.52	9.83	41.35	56.00	-14.65	peak	

Test Mode: TX Mode_2403 MHz_Supplied from PC USB port.

Neutral

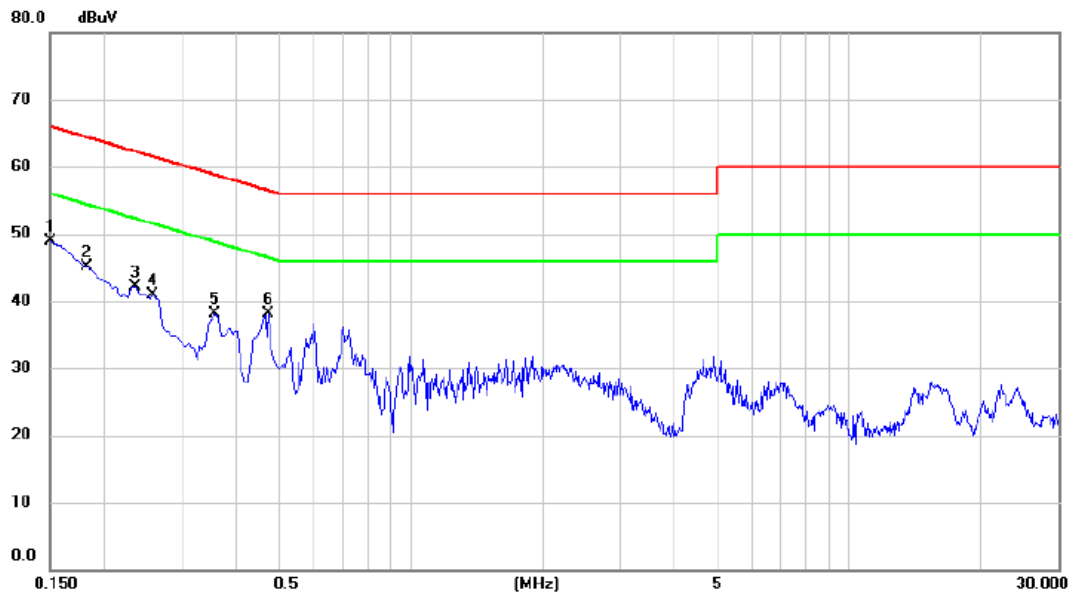

No.	Mk.	Freq. MHz	Reading Level dBuV	Correct Factor dB	Measure- ment dBuV	Limit dBuV	Margin dB	Detector	Comment
1	*	0.1500	39.03	9.91	48.94	66.00	-17.06	peak	
2		0.1825	35.17	9.92	45.09	64.37	-19.28	peak	
3		0.2355	32.16	9.91	42.07	62.25	-20.18	peak	
4		0.2580	30.90	9.92	40.82	61.50	-20.68	peak	
5		0.3570	28.10	9.95	38.05	58.80	-20.75	peak	
6		0.4740	28.08	9.95	38.03	56.44	-18.41	peak	

APPENDIX B - RADIATED EMISSION (9KHZ TO 30MHZ)

Test Mode: TX Mode Channel 01_Supplied from Adapter.

Ant 0°

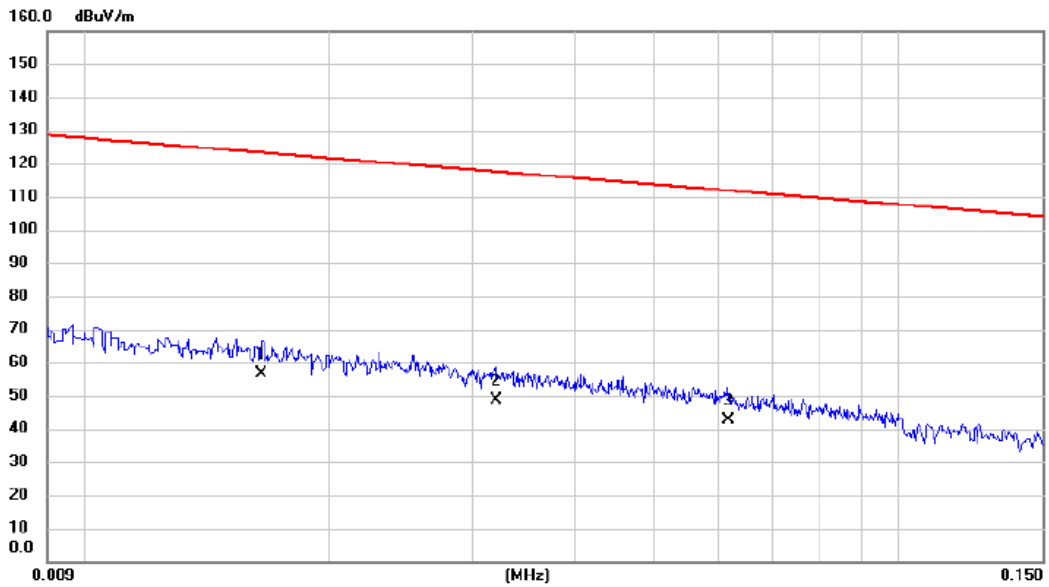

No.	Mk.	Freq. MHz	Reading Level dBuV	Correct Factor dB	Measure- ment dBuV/m	Limit dBuV/m	Margin dB	Detector	Comment
1	*	0.0165	36.10	20.51	56.61	123.26	-66.65	AVG	
2		0.0320	28.70	19.83	48.53	117.50	-68.97	AVG	
3		0.0617	23.20	19.30	42.50	111.80	-69.30	AVG	

Test Mode: TX Mode Channel 01_Supplied from Adapter.

Ant 0°

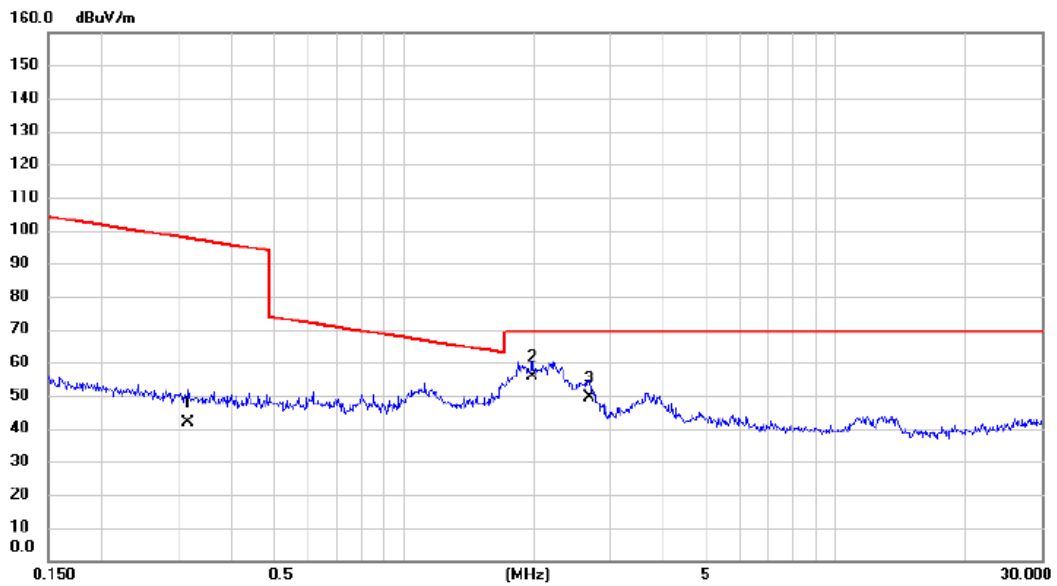

No.	Mk.	Freq. MHz	Reading Level dBuV	Correct Factor dB	Measure- ment dBuV/m	Limit dBuV/m	Margin dB	Detector	Comment
1		0.3166	24.70	17.03	41.73	97.59	-55.86	AVG	
2	*	1.9801	38.70	17.10	55.80	69.54	-13.74	QP	
3		2.6925	32.80	16.71	49.51	69.54	-20.03	QP	

Test Mode: TX Mode Channel 01_Supplied from Adapter.

Ant 90°

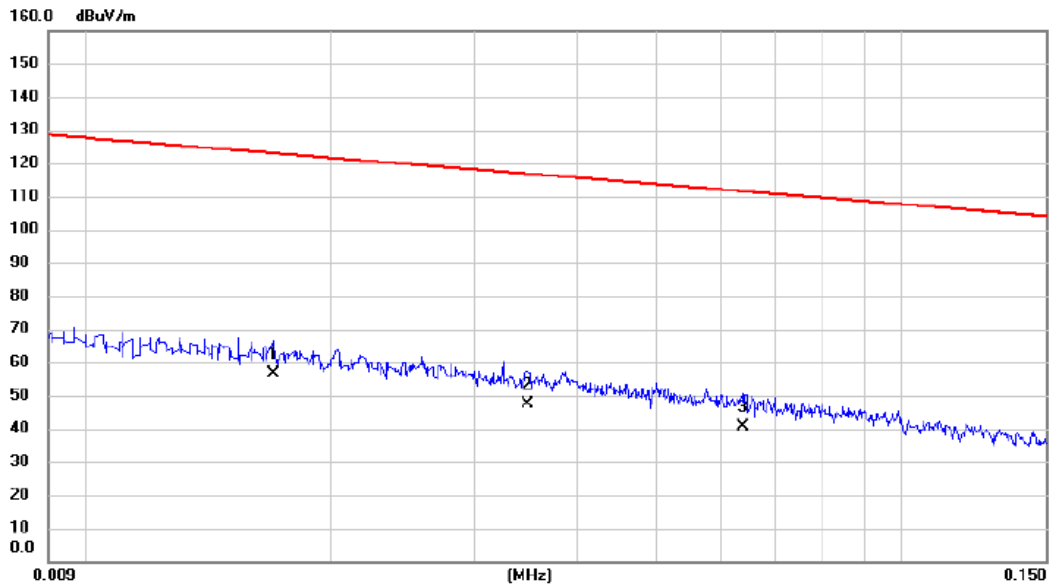

No.	Mk.	Freq. MHz	Reading Level dBuV	Correct Factor dB	Measure- ment dBuV/m	Limit dBuV/m	Margin dB	Detector	Comment
1	*	0.0170	36.10	20.44	56.54	123.00	-66.46	AVG	
2		0.0348	27.70	19.78	47.48	116.77	-69.29	AVG	
3		0.0640	21.40	19.25	40.65	111.48	-70.83	AVG	

Test Mode: TX Mode Channel 01_Supplied from Adapter.

Ant 90°

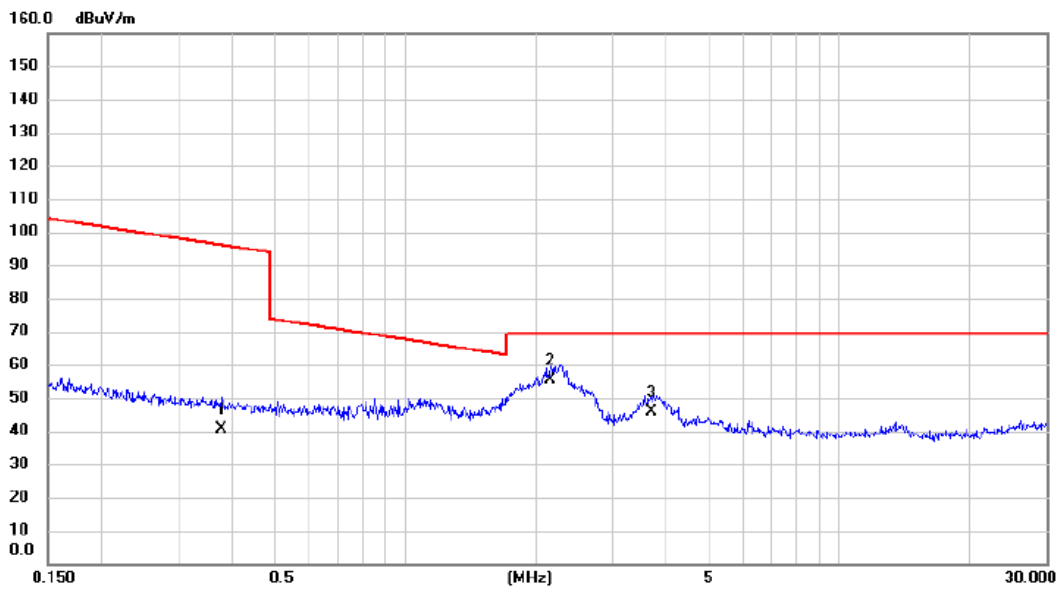

No.	Mk.	Freq. MHz	Reading Level dBuV	Correct Factor dB	Measure- ment dBuV/m	Limit dBuV/m	Margin dB	Detector	Comment
1		0.3771	23.40	17.01	40.41	96.08	-55.67	AVG	
2	*	2.1552	38.30	17.03	55.33	69.54	-14.21	QP	
3		3.6806	29.70	16.00	45.70	69.54	-23.84	QP	

Test Mode: TX Mode Channel 01_Supplied from PC USB port.

Ant 0°

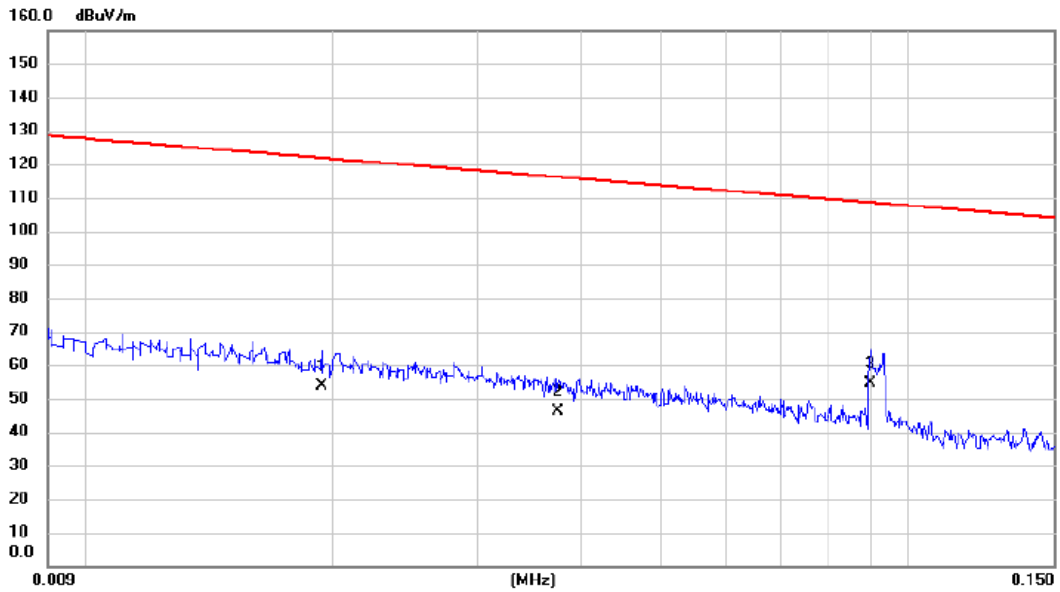

No.	Mk.	Freq. MHz	Reading Level dBuV	Correct Factor dB	Measure- ment dBuV/m	Limit dBuV/m	Margin dB	Detector	Comment
1		0.0194	33.80	20.10	53.90	121.85	-67.95	AVG	
2		0.0375	26.50	19.74	46.24	116.12	-69.88	AVG	
3	*	0.0898	35.80	18.68	54.48	108.54	-54.06	AVG	

Test Mode: TX Mode Channel 01_Supplied from PC USB port.

Ant 0°

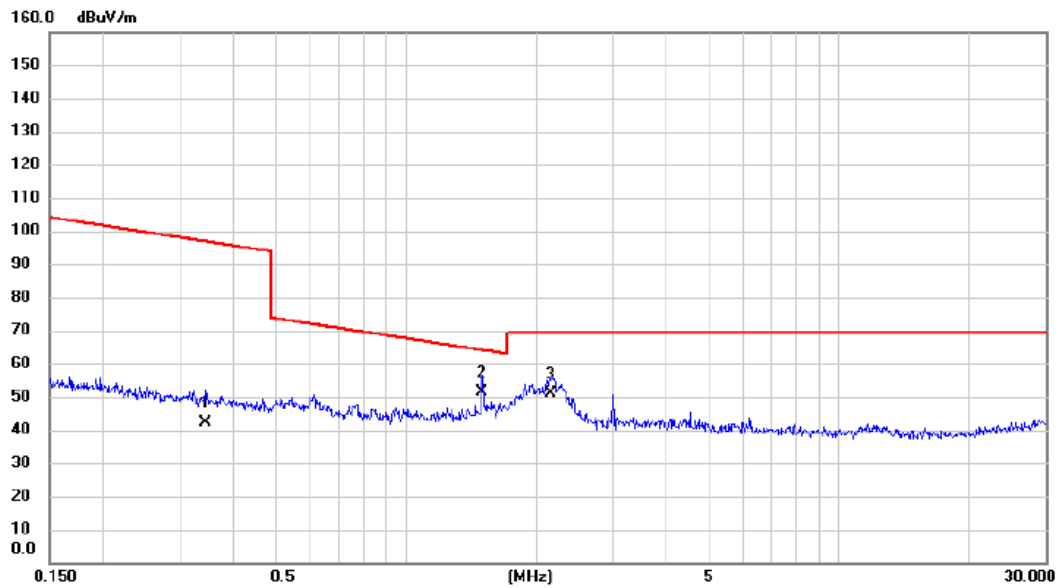

No.	Mk.	Freq. MHz	Reading Level dBuV	Correct Factor dB	Measure- ment dBuV/m	Limit dBuV/m	Margin dB	Detector	Comment
1		0.3446	25.10	17.02	42.12	96.86	-54.74	AVG	
2	*	1.4953	34.70	16.86	51.56	64.11	-12.55	QP	
3		2.1552	34.10	17.03	51.13	69.54	-18.41	QP	

Test Mode: TX Mode Channel 01_Supplied from PC USB port.

Ant 90°

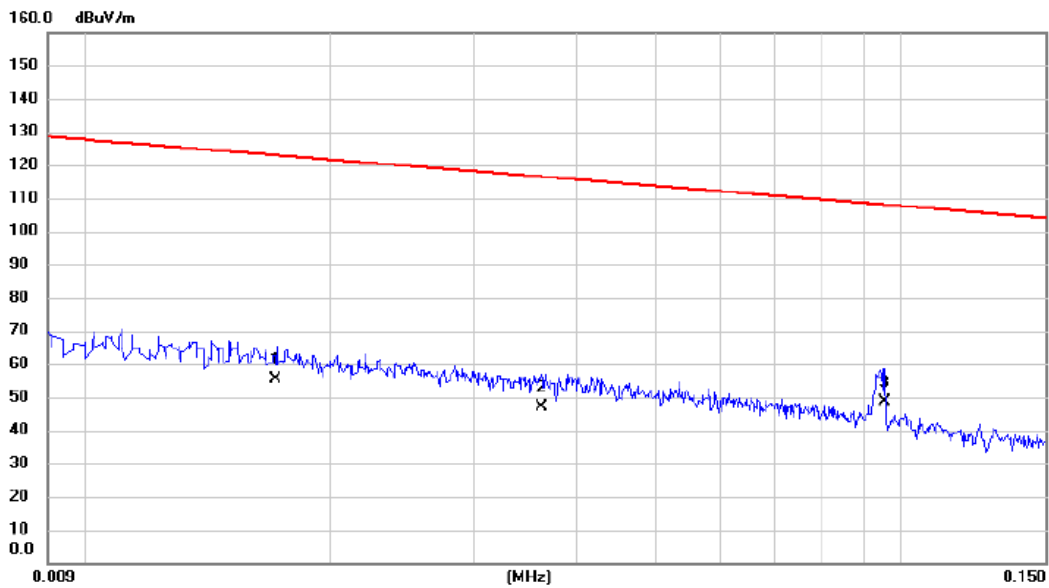

No.	Mk.	Freq. MHz	Reading Level dBuV	Correct Factor dB	Measure- ment dBuV/m	Limit dBuV/m	Margin dB	Detector	Comment
1		0.0171	34.88	20.43	55.31	122.94	-67.63	AVG	
2		0.0362	27.40	19.76	47.16	116.43	-69.27	AVG	
3	*	0.0954	30.10	18.55	48.65	108.01	-59.36	QP	

Test Mode: TX Mode Channel 01_Supplied from PC USB port.

Ant 90°

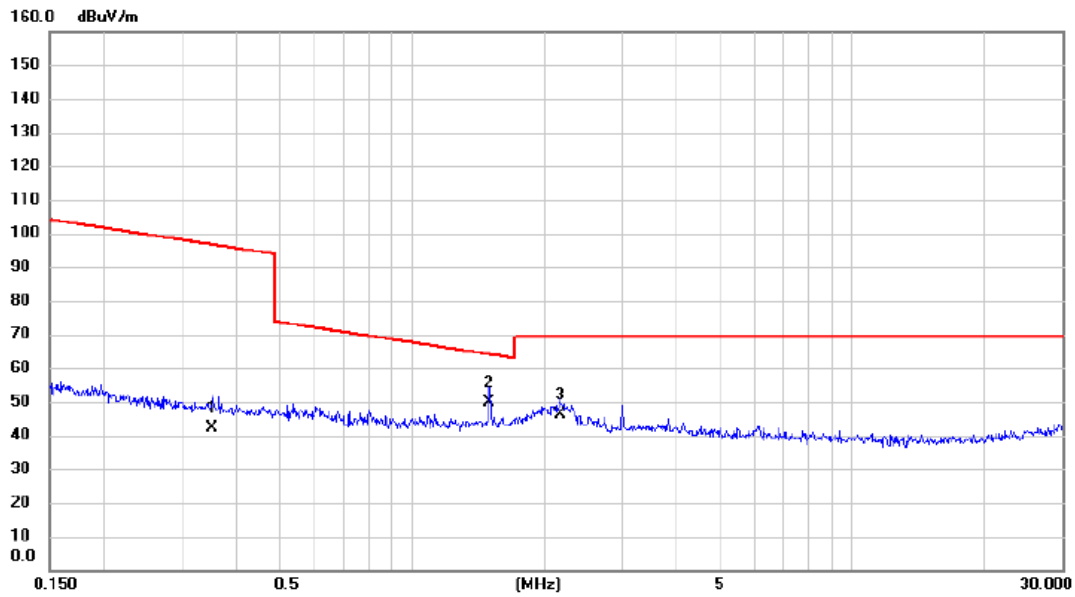

No.	Mk.	Freq. MHz	Reading Level dBuV	Correct Factor dB	Measure- ment dBuV/m	Limit dBuV/m	Margin dB	Detector	Comment
1		0.3520	25.10	17.02	42.12	96.67	-54.55	AVG	
2	*	1.4953	32.80	16.86	49.66	64.11	-14.45	QP	
3		2.1783	29.10	17.01	46.11	69.54	-23.43	QP	

APPENDIX C - RADIATED EMISSION (30MHZ TO 1000MHZ)

Test Mode: TX Mode Channel 01_Supplied from Adapter.

Vertical

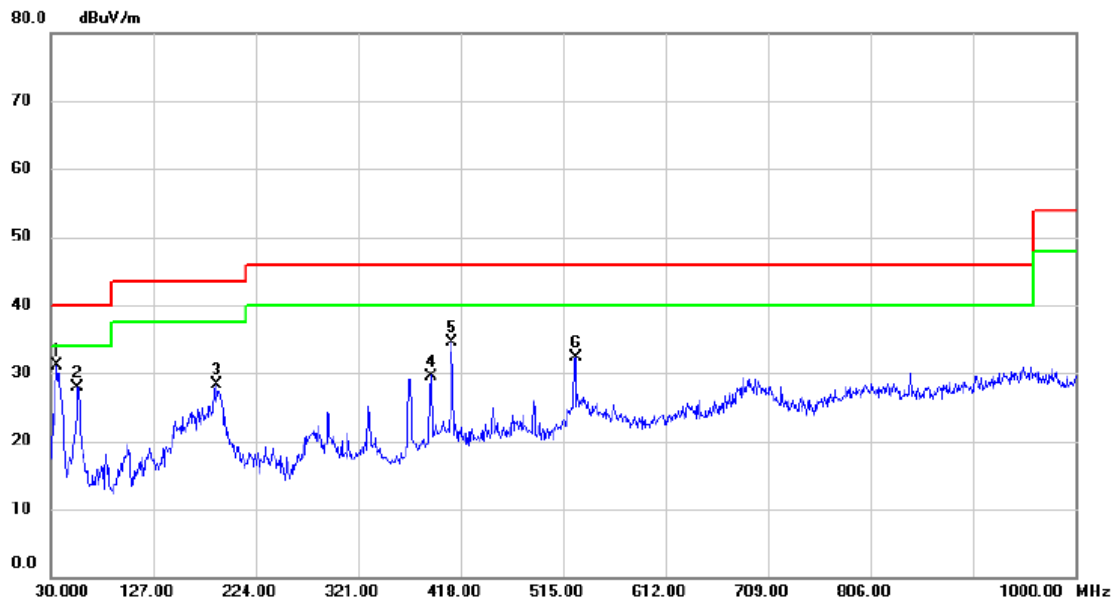

No.	Mk.	Freq. MHz	Reading Level dBuV	Correct Factor dB	Measure- ment dBuV/m	Limit dBuV/m	Margin dB	Detector	Comment
1	*	36.3050	45.98	-14.93	31.05	40.00	-8.95	peak	
2		55.7050	42.97	-15.02	27.95	40.00	-12.05	peak	
3		187.6250	42.32	-13.95	28.37	43.50	-15.13	peak	
4		389.8700	39.32	-9.72	29.60	46.00	-16.40	peak	
5		409.2700	43.48	-9.02	34.46	46.00	-11.54	peak	
6		526.6400	39.25	-6.90	32.35	46.00	-13.65	peak	

Test Mode: TX Mode Channel 01_Supplied from Adapter.

Horizontal

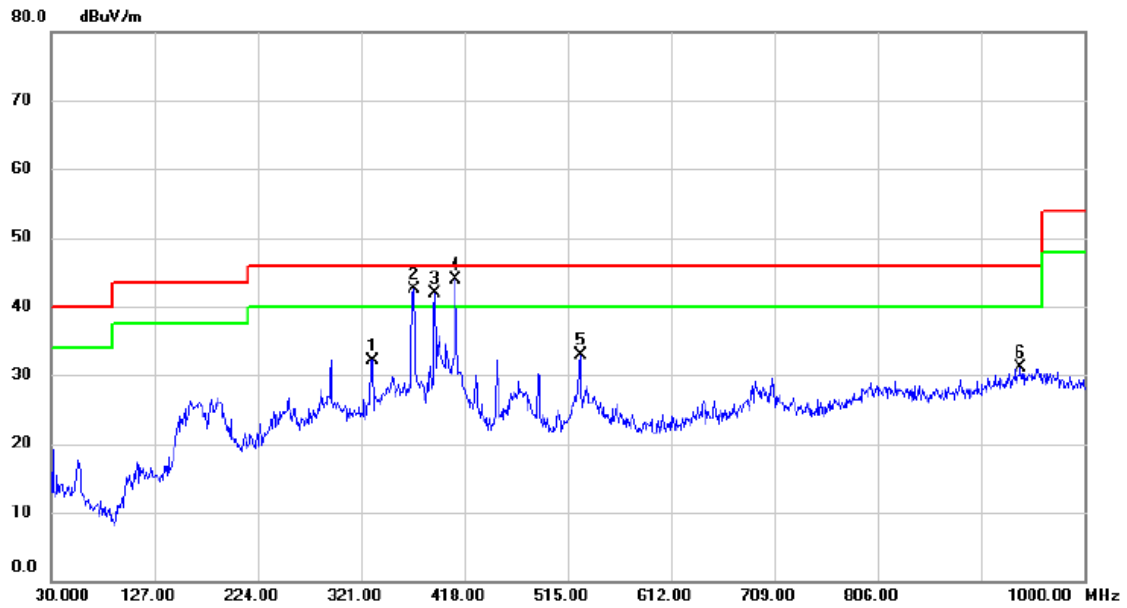

No.	Mk.	Freq. MHz	Reading Level dBuV	Correct Factor dB	Measure- ment dBuV/m	Limit dBuV/m	Margin dB	Detector	Comment
1		331.6700	42.97	-10.82	32.15	46.00	-13.85	peak	
2	!	370.9550	52.89	-10.37	42.52	46.00	-3.48	peak	
3	!	389.8700	51.64	-9.72	41.92	46.00	-4.08	peak	
4	*	409.2700	52.93	-9.02	43.91	46.00	-2.09	peak	
5		526.6400	39.82	-6.90	32.92	46.00	-13.08	peak	
6		939.8600	30.03	1.01	31.04	46.00	-14.96	peak	

Test Mode: TX Mode Channel 01_Supplied from PC USB port.

Vertical

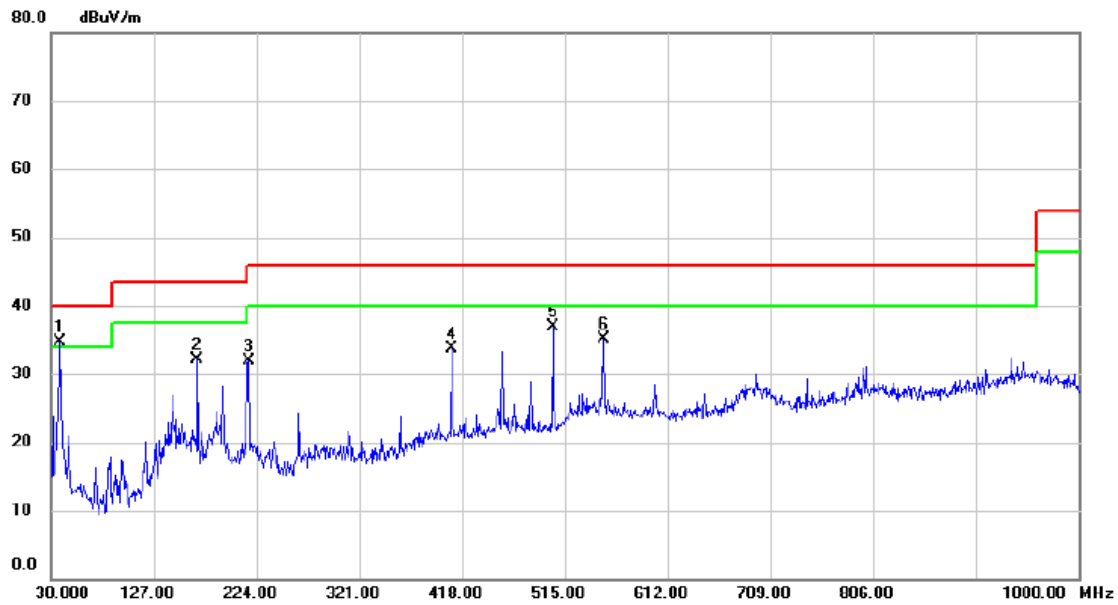

No.	Mk.	Freq. MHz	Reading Level dBuV	Correct Factor dB	Measure- ment dBuV/m	Limit dBuV/m	Margin dB	Detector	Comment
1	*	38.7300	49.32	-14.66	34.66	40.00	-5.34	peak	
2		168.2250	43.21	-11.10	32.11	43.50	-11.39	peak	
3		216.2400	46.79	-14.98	31.81	46.00	-14.19	peak	
4		407.8150	42.69	-9.07	33.62	46.00	-12.38	peak	
5		503.8450	45.29	-8.29	37.00	46.00	-9.00	peak	
6		551.8600	40.53	-5.49	35.04	46.00	-10.96	peak	

Test Mode: TX Mode Channel 01_Supplied from PC USB port.

Horizontal

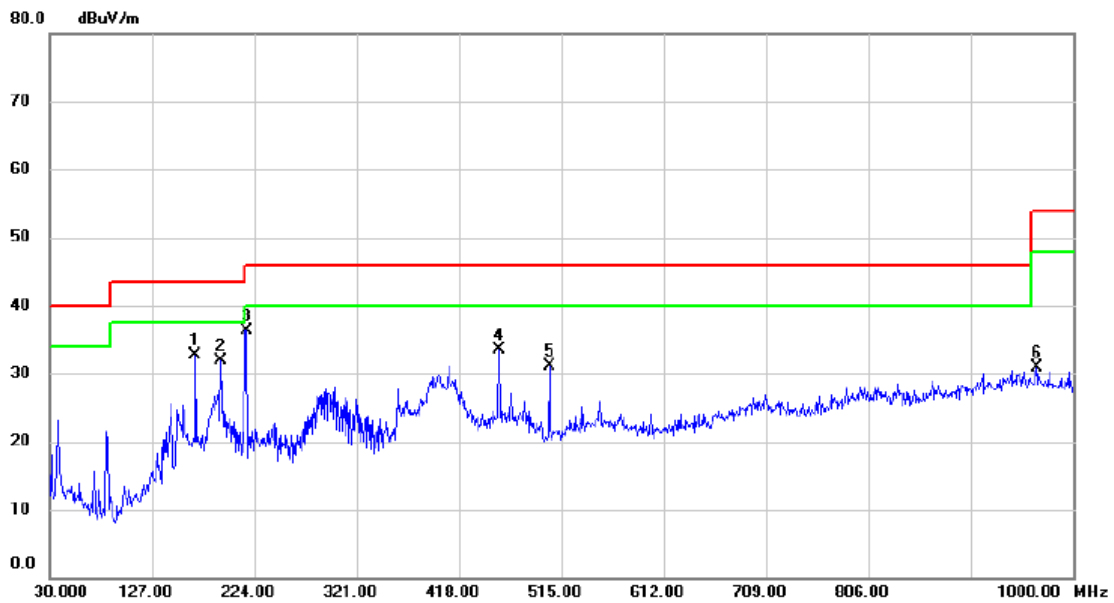

No.	Mk.	Freq. MHz	Reading Level dBuV	Correct Factor dB	Measure- ment dBuV/m	Limit dBuV/m	Margin dB	Detector	Comment
1		168.2250	43.83	-11.10	32.73	43.50	-10.77	peak	
2		191.9900	46.31	-14.48	31.83	43.50	-11.67	peak	
3	*	216.2400	51.23	-14.98	36.25	46.00	-9.75	peak	
4		455.8300	41.05	-7.54	33.51	46.00	-12.49	peak	
5		503.8450	39.42	-8.29	31.13	46.00	-14.87	peak	
6		965.0800	29.80	1.05	30.85	54.00	-23.15	peak	

APPENDIX D - RADIATED EMISSION (ABOVE 1000MHZ)

Test Mode TX Mode Channel 01

Vertical

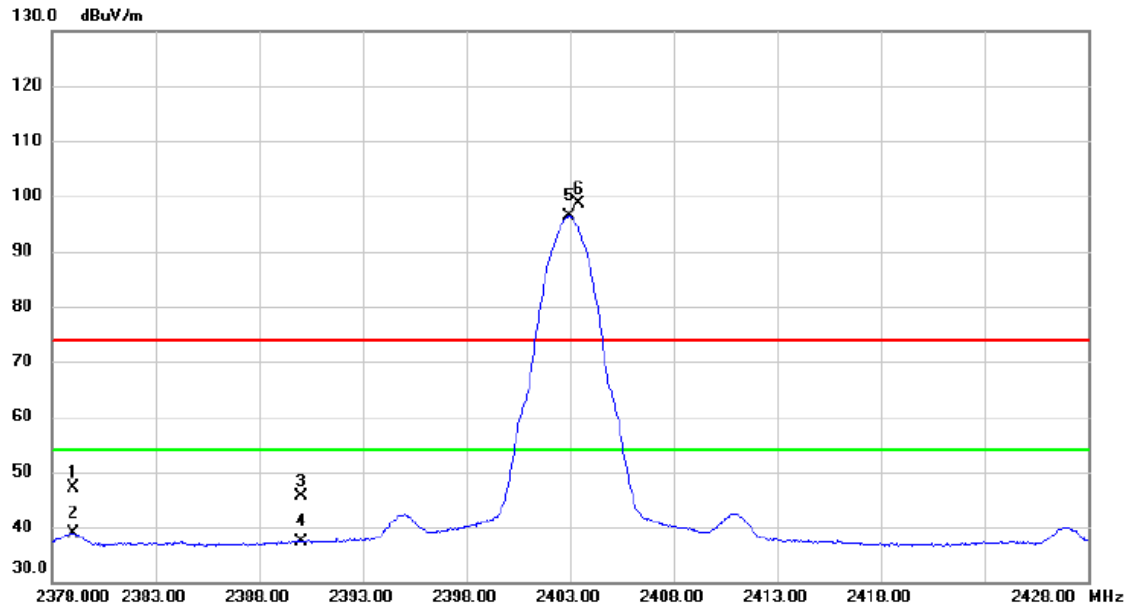

No.	Mk.	Freq. MHz	Reading Level dBuV	Correct Factor dB	Measure- ment dBuV/m	Limit dBuV/m	Margin dB	Detector	Comment
1		2379.050	40.54	6.62	47.16	74.00	-26.84	peak	
2		2379.050	32.33	6.62	38.95	54.00	-15.05	AVG	
3		2390.000	39.06	6.62	45.68	74.00	-28.32	peak	
4		2390.000	30.71	6.62	37.33	54.00	-16.67	AVG	
5	*	2402.975	89.68	6.62	96.30	54.00	42.30	AVG	No Limit
6	X	2403.425	91.99	6.62	98.61	74.00	24.61	peak	No Limit

Test Mode	TX Mode Channel 01
-----------	--------------------

Vertical

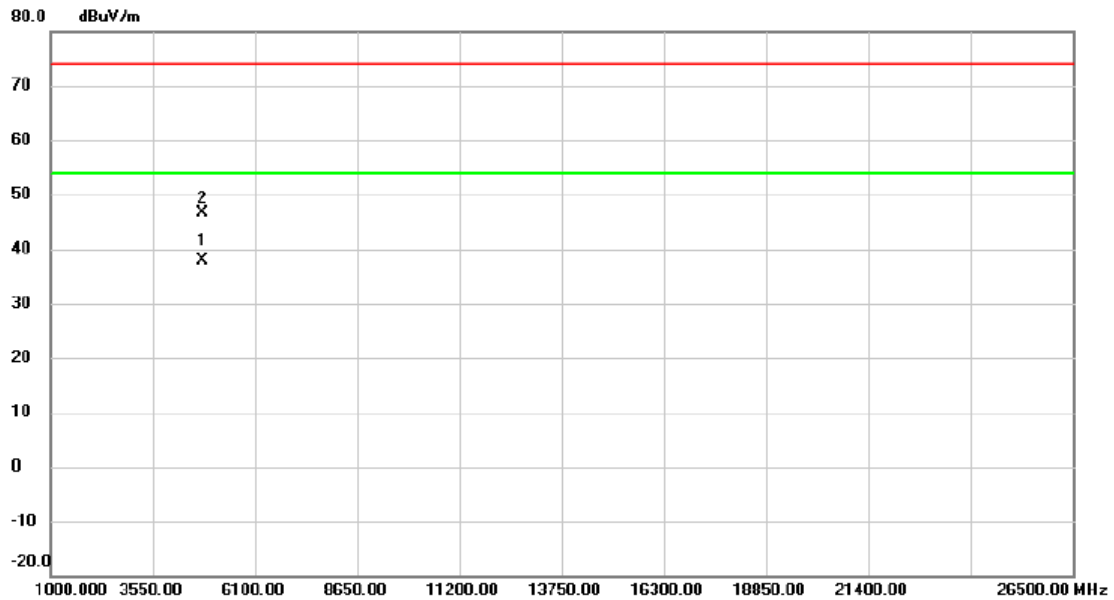

No.	Mk.	Freq.	Reading Level	Correct Factor	Measurement	Limit	Margin	Detector	Comment
		MHz	dBuV	dB	dBuV/m	dBuV/m	dB		
1	*	4805.780	34.42	3.53	37.95	54.00	-16.05	AVG	
2		4806.188	43.02	3.53	46.55	74.00	-27.45	peak	

Test Mode TX Mode Channel 01

Horizontal

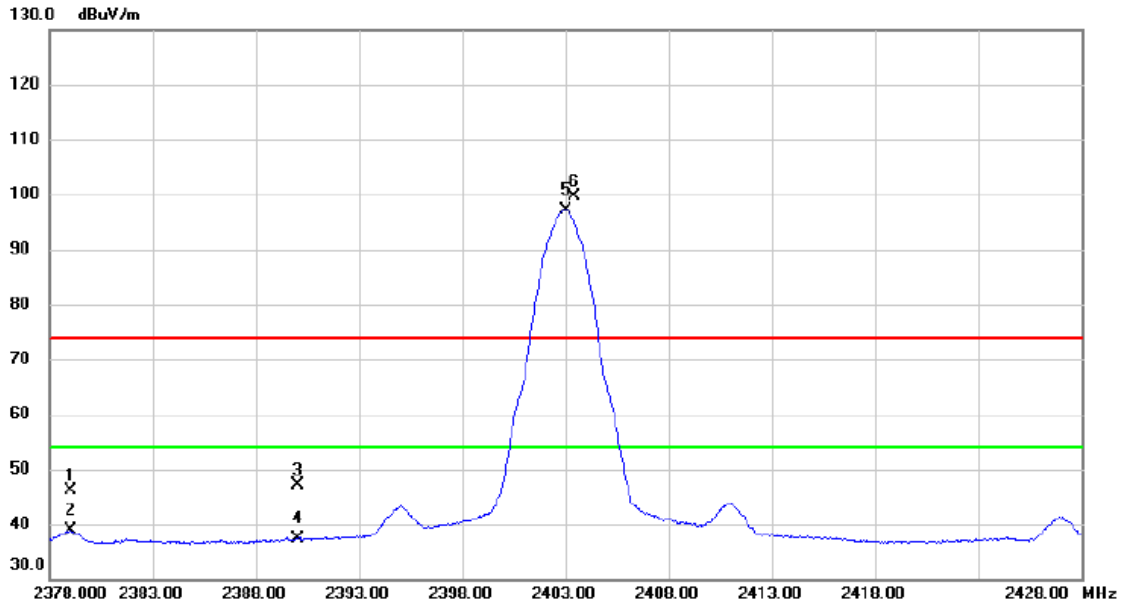

No.	Mk.	Freq. MHz	Reading Level dBuV	Correct Factor dB	Measure- ment dBuV/m	Limit dBuV/m	Margin dB	Detector	Comment
1		2379.025	39.62	6.62	46.24	74.00	-27.76	peak	
2		2379.025	32.22	6.62	38.84	54.00	-15.16	AVG	
3		2390.000	40.45	6.62	47.07	74.00	-26.93	peak	
4		2390.000	30.78	6.62	37.40	54.00	-16.60	AVG	
5	*	2403.000	90.62	6.62	97.24	54.00	43.24	AVG	No Limit
6	X	2403.425	92.96	6.62	99.58	74.00	25.58	peak	No Limit

Test Mode TX Mode Channel 01

Horizontal

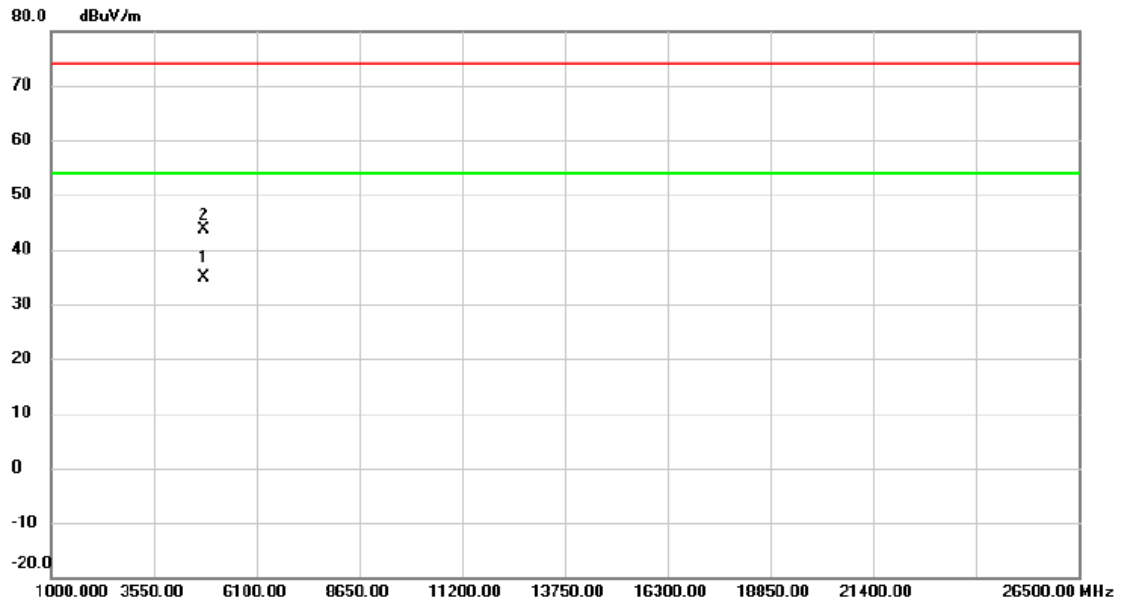

No.	Mk.	Freq. MHz	Reading Level dBuV	Correct Factor dB	Measure- ment dBuV/m	Limit dBuV/m	Margin dB	Detector	Comment
1	*	4805.762	31.42	3.53	34.95	54.00	-19.05	AVG	
2		4806.815	40.03	3.53	43.56	74.00	-30.44	peak	

Test Mode	TX Mode Channel 38
-----------	--------------------

Vertical

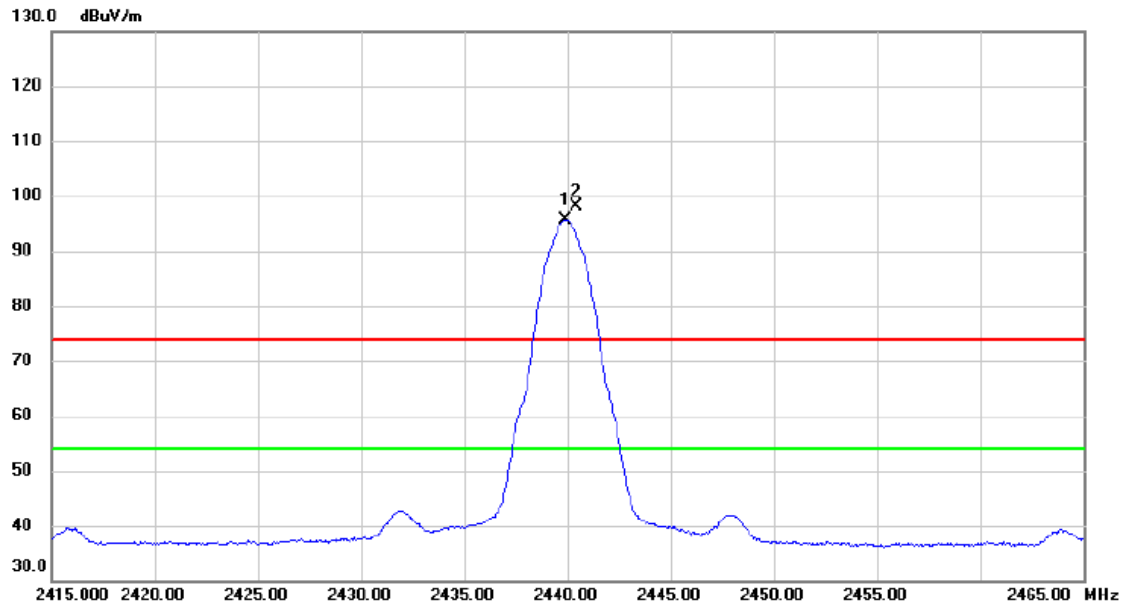

No.	Mk.	Freq.	Reading Level	Correct Factor	Measurement	Limit	Margin	Detector	Comment
		MHz	dBuV	dB	dBuV/m	dBuV/m	dB		
1	*	2439.900	89.11	6.61	95.72	54.00	41.72	AVG	No Limit
2	X	2440.450	91.48	6.61	98.09	74.00	24.09	peak	No Limit

Test Mode	TX Mode Channel 38
-----------	--------------------

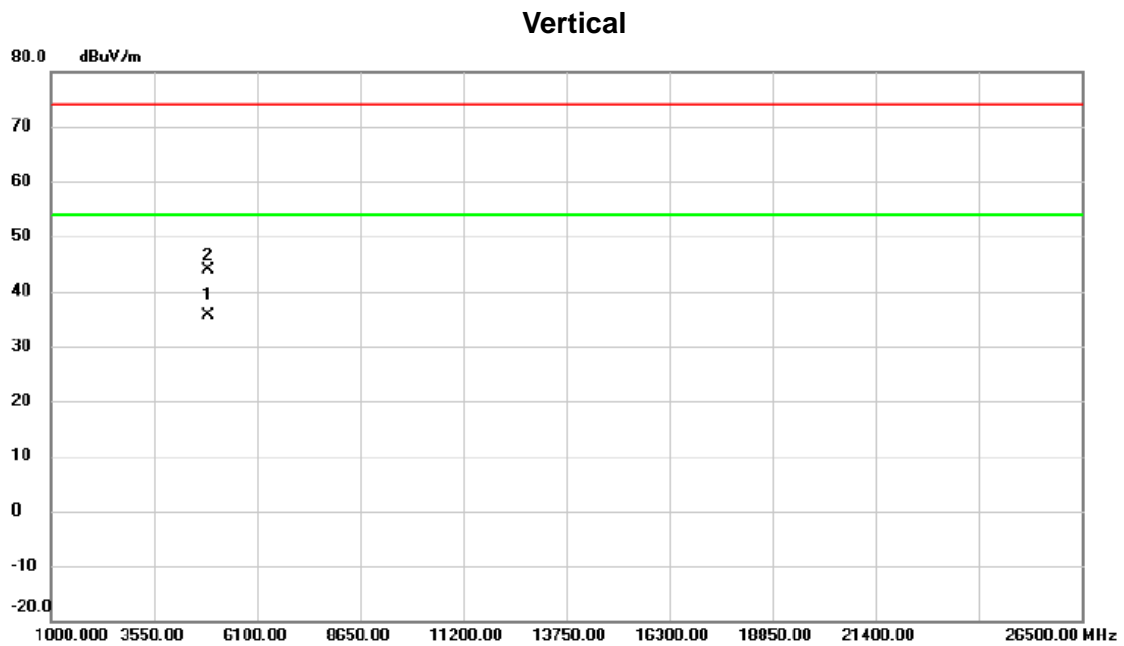

No.	Mk.	Freq.	Reading Level	Correct Factor	Measurement	Limit	Margin	Detector	Comment
		MHz	dBuV	dB	dBuV/m	dBuV/m	dB		
1	*	4879.767	32.00	3.69	35.69	54.00	-18.31	AVG	
2		4879.970	40.15	3.69	43.84	74.00	-30.16	peak	

Test Mode TX Mode Channel 38

Horizontal

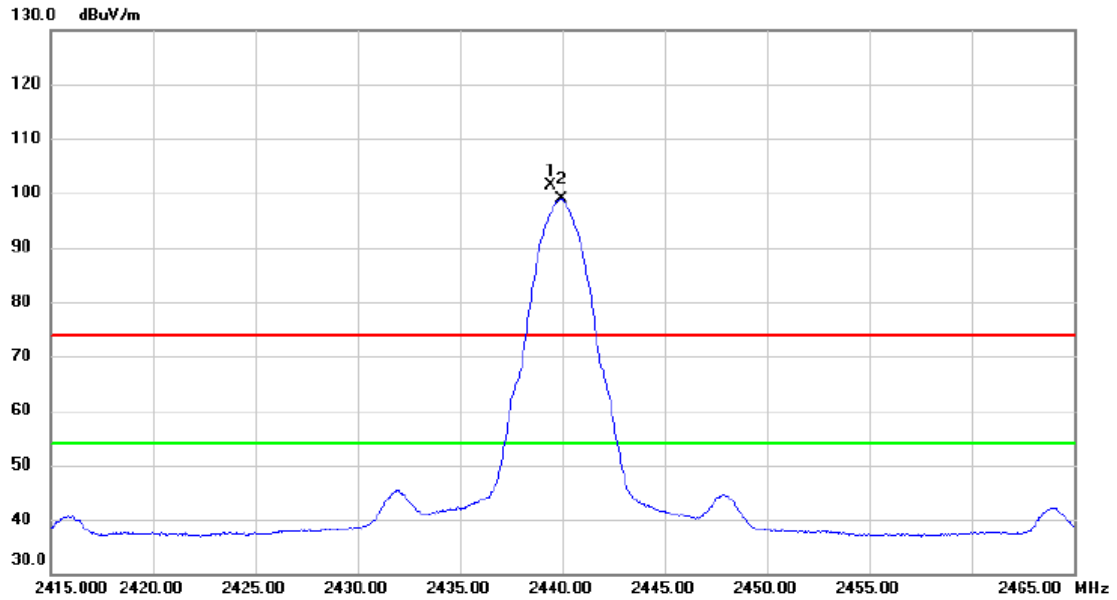

No.	Mk.	Freq. MHz	Reading Level dBuV	Correct Factor dB	Measure- ment dBuV/m	Limit dBuV/m	Margin dB	Detector	Comment
1	X	2439.425	94.65	6.61	101.26	74.00	27.26	peak	No Limit
2	*	2439.950	92.25	6.61	98.86	54.00	44.86	AVG	No Limit

Test Mode	TX Mode Channel 38
-----------	--------------------

Horizontal

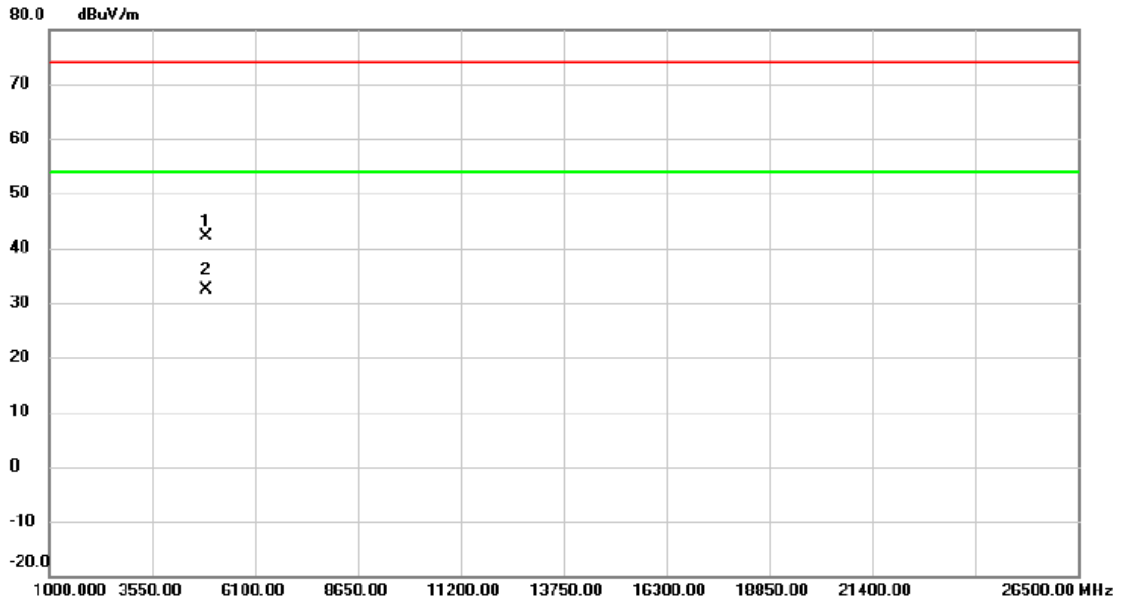

No.	Mk.	Freq.	Reading Level	Correct Factor	Measure-ment	Limit	Margin	Detector	Comment
		MHz	dBuV	dB	dBuV/m	dBuV/m	dB		
1		4879.688	38.37	3.69	42.06	74.00	-31.94	peak	
2	*	4879.825	28.68	3.69	32.37	54.00	-21.63	AVG	

Test Mode TX Mode Channel 77

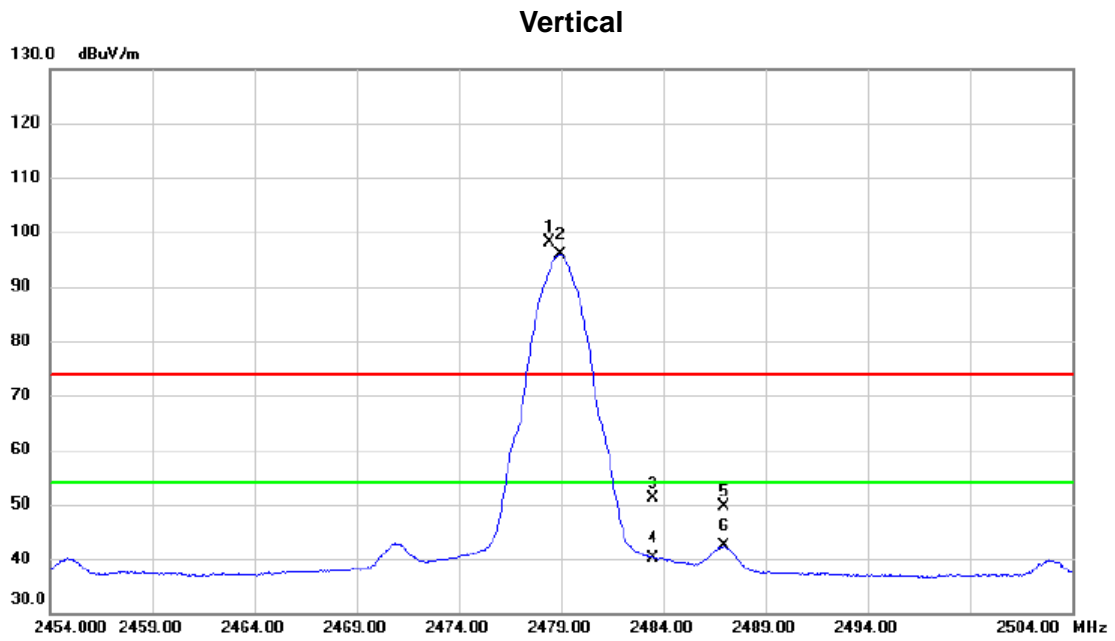

No.	Mk.	Freq. MHz	Reading Level dBuV	Correct Factor dB	Measure- ment dBuV/m	Limit dBuV/m	Margin dB	Detector	Comment
1	X	2478.425	91.46	6.61	98.07	74.00	24.07	peak	No Limit
2	*	2478.950	89.27	6.61	95.88	54.00	41.88	AVG	No Limit
3		2483.500	44.49	6.61	51.10	74.00	-22.90	peak	
4		2483.500	33.57	6.61	40.18	54.00	-13.82	AVG	
5		2486.975	43.11	6.61	49.72	74.00	-24.28	peak	
6		2486.975	35.66	6.61	42.27	54.00	-11.73	AVG	

Test Mode	TX Mode Channel 77
-----------	--------------------

Vertical

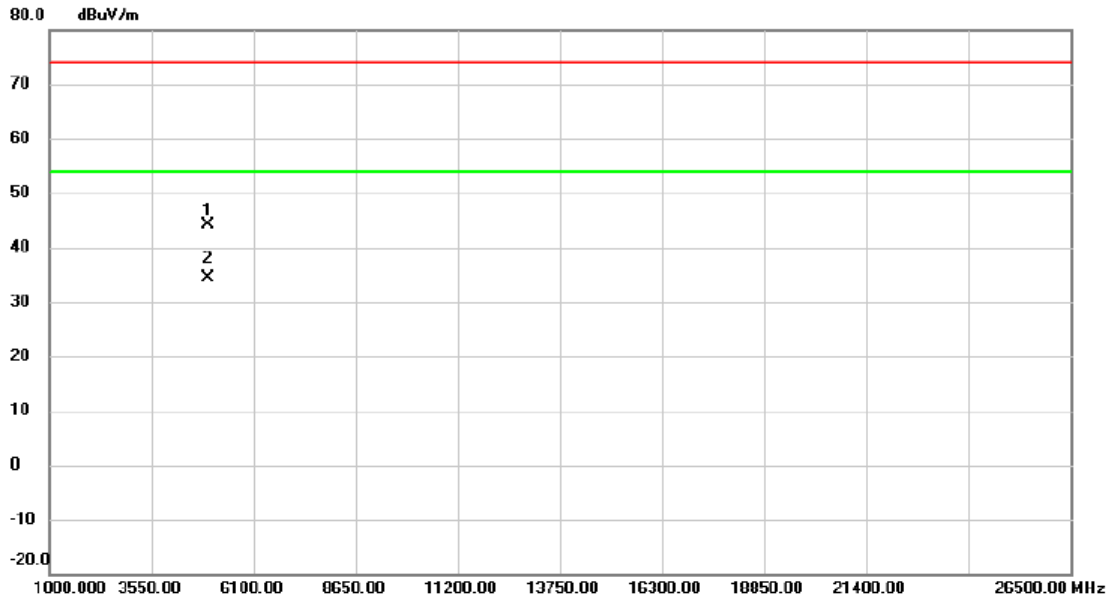

No.	Mk.	Freq.	Reading Level	Correct Factor	Measure-ment	Limit	Margin	Detector	Comment
		MHz	dBuV	dB	dBuV/m	dBuV/m	dB		
1		4956.620	40.23	3.86	44.09	74.00	-29.91	peak	
2	*	4957.727	30.47	3.86	34.33	54.00	-19.67	AVG	

Test Mode TX Mode Channel 77

Horizontal

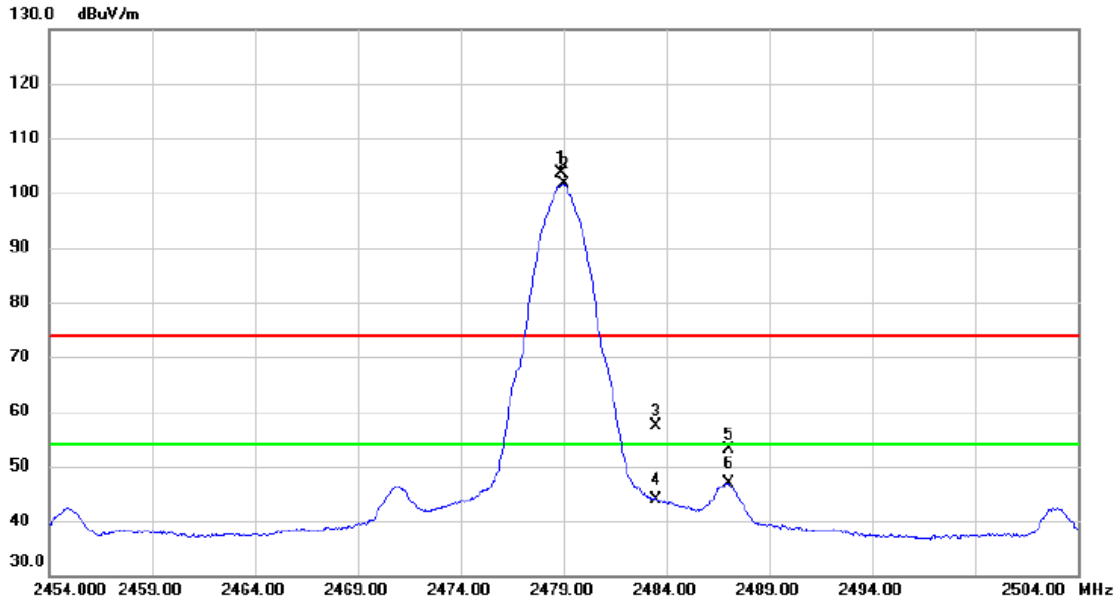

No.	Mk.	Freq. MHz	Reading Level dBuV	Correct Factor dB	Measure- ment dBuV/m	Limit dBuV/m	Margin dB	Detector	Comment
1	X	2478.925	97.08	6.61	103.69	74.00	29.69	peak	No Limit
2	*	2479.000	94.93	6.61	101.54	54.00	47.54	AVG	No Limit
3		2483.500	50.75	6.61	57.36	74.00	-16.64	peak	
4		2483.500	37.22	6.61	43.83	54.00	-10.17	AVG	
5		2487.000	46.61	6.61	53.22	74.00	-20.78	peak	
6		2487.000	40.28	6.61	46.89	54.00	-7.11	AVG	

Test Mode TX Mode Channel 77

Horizontal

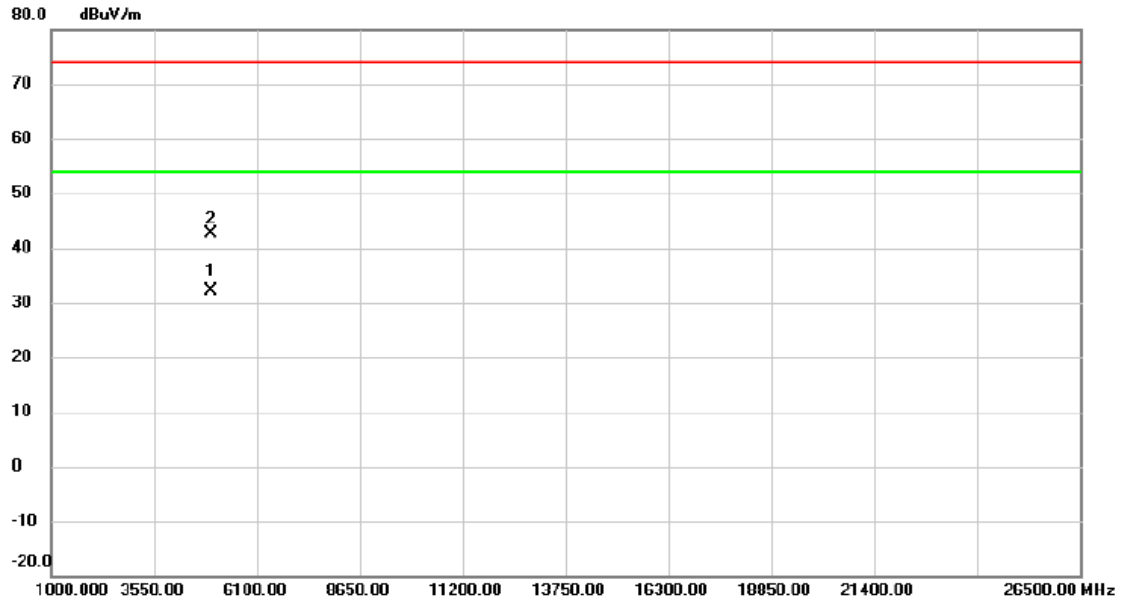

No.	Mk.	Freq. MHz	Reading Level dBuV	Correct Factor dB	Measure- ment dBuV/m	Limit dBuV/m	Margin dB	Detector	Comment
1	*	4957.823	28.36	3.86	32.22	54.00	-21.78	AVG	
2		4958.485	38.81	3.87	42.68	74.00	-31.32	peak	

APPENDIX E - BANDWIDTH

Test Mode:	TX Mode
------------	---------

Frequency (MHz)	6dB Bandwidth (MHz)	99% Occupied BW (MHz)	Min. Limit (kHz)	Test Result
2403	1.13	2.07	500	Complies
2440	1.14	2.08	500	Complies
2479	1.14	2.09	500	Complies

TX Mode_2403 MHz

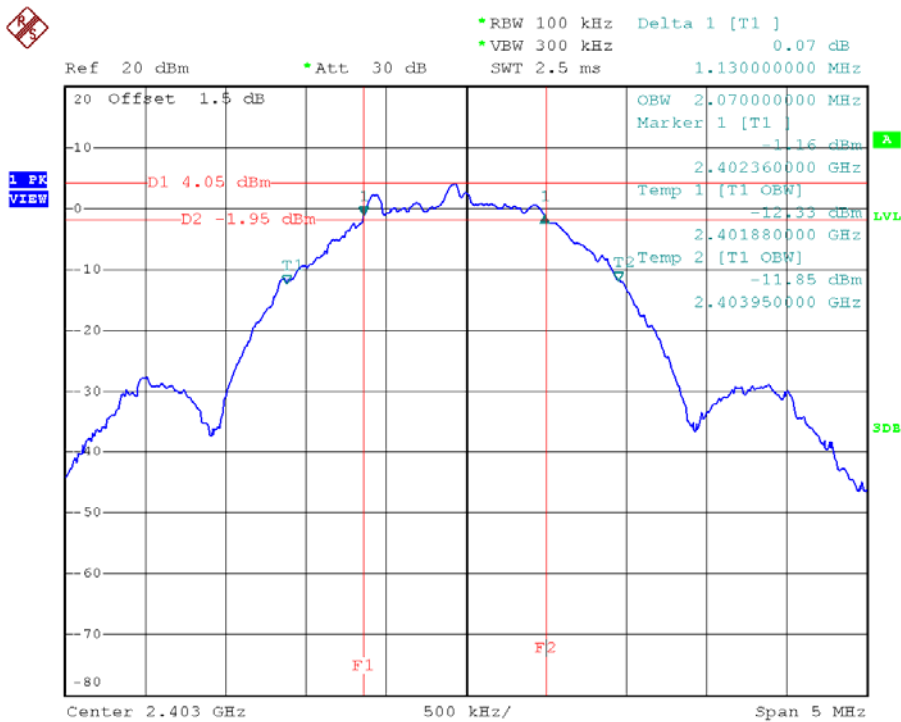

Date: 29.NOV.2018 09:17:11

TX Mode_2440 MHz

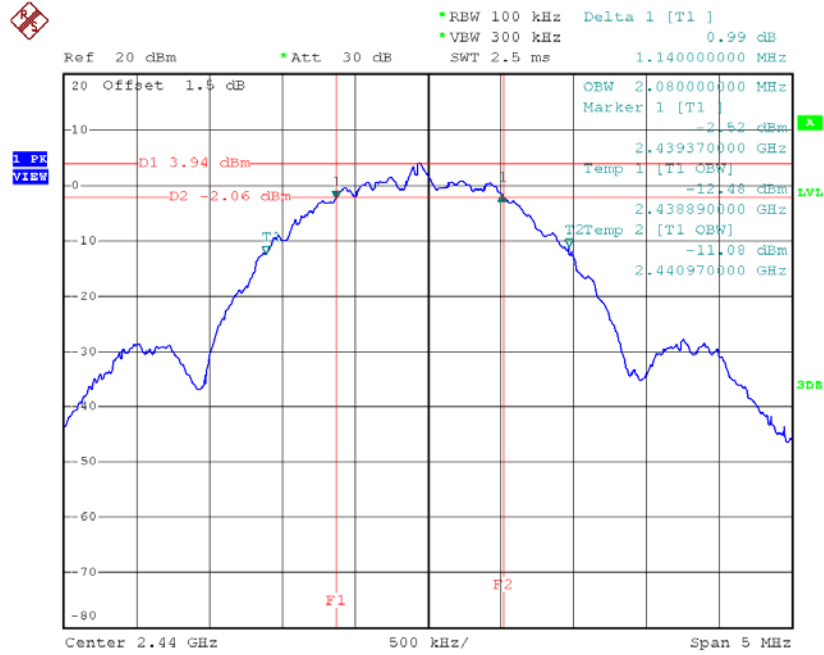

Date: 29.NOV.2018 09:31:26

TX Mode_2479 MHz

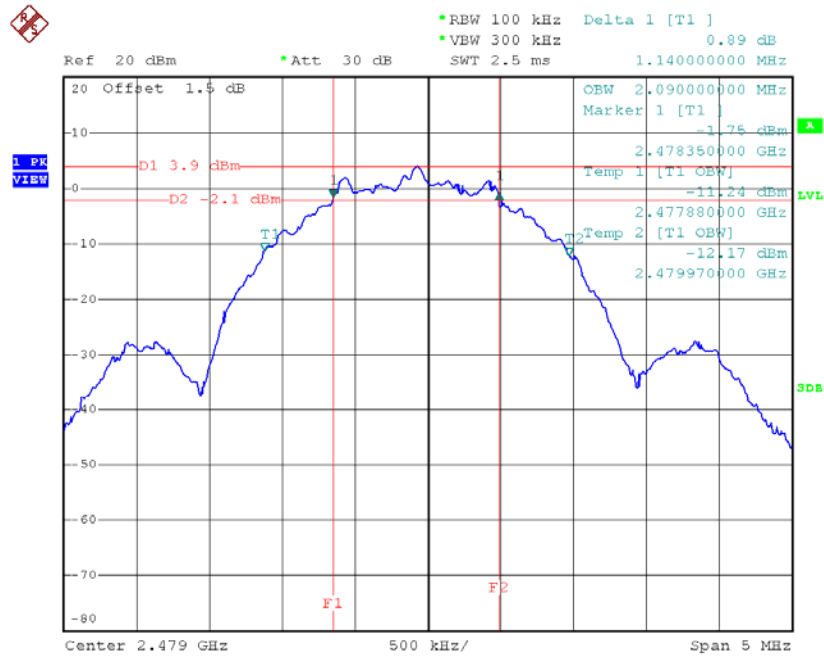

Date: 29.NOV.2018 09:36:50

APPENDIX F - MAXIMUM OUTPUT POWER TEST

TX Mode_2440 MHz

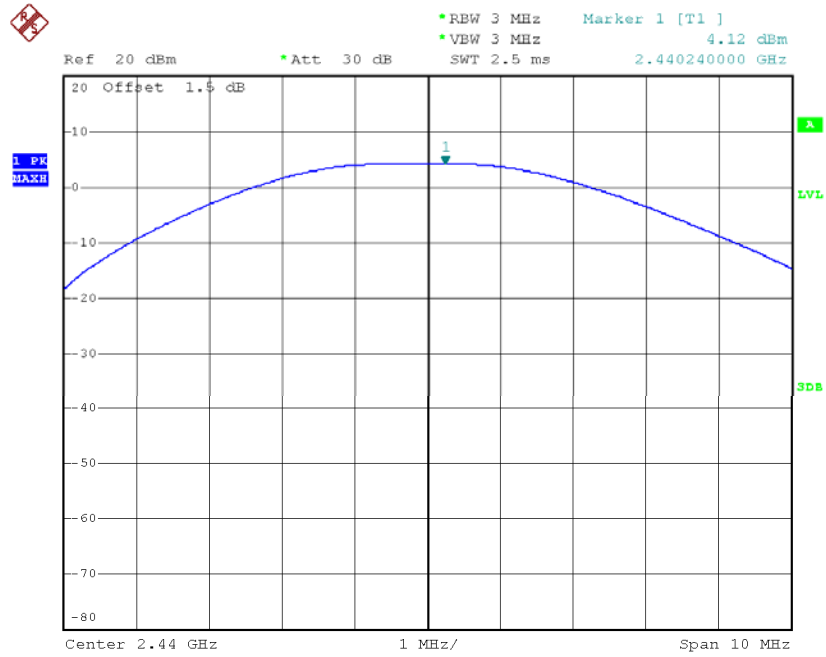

Date: 29.NOV.2018 09:28:32

TX Mode_2479 MHz

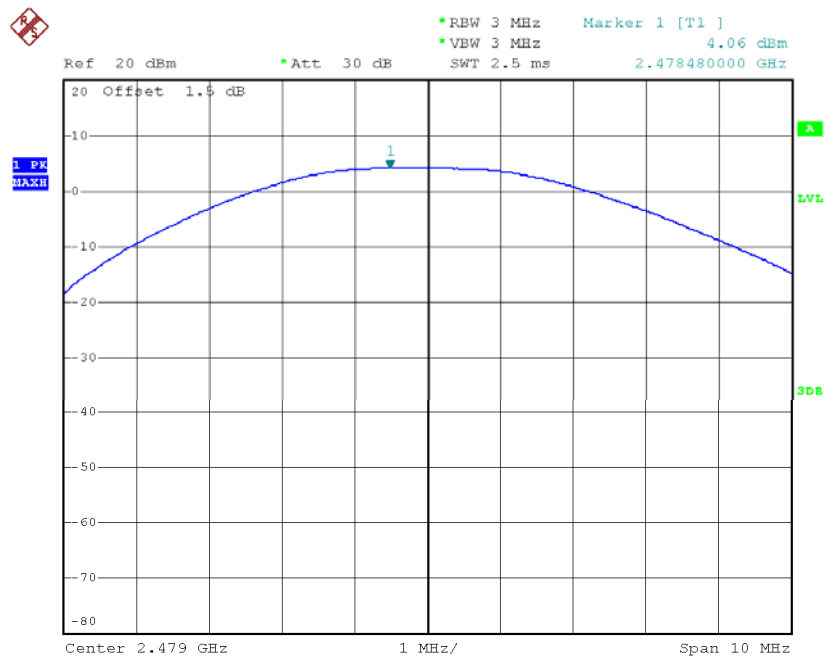

Date: 29.NOV.2018 09:34:48

APPENDIX G - ANTENNA CONDUCTED SPURIOUS EMISSION

Test Mode : CH01, CH38 , CH77

CH01 (Lower)

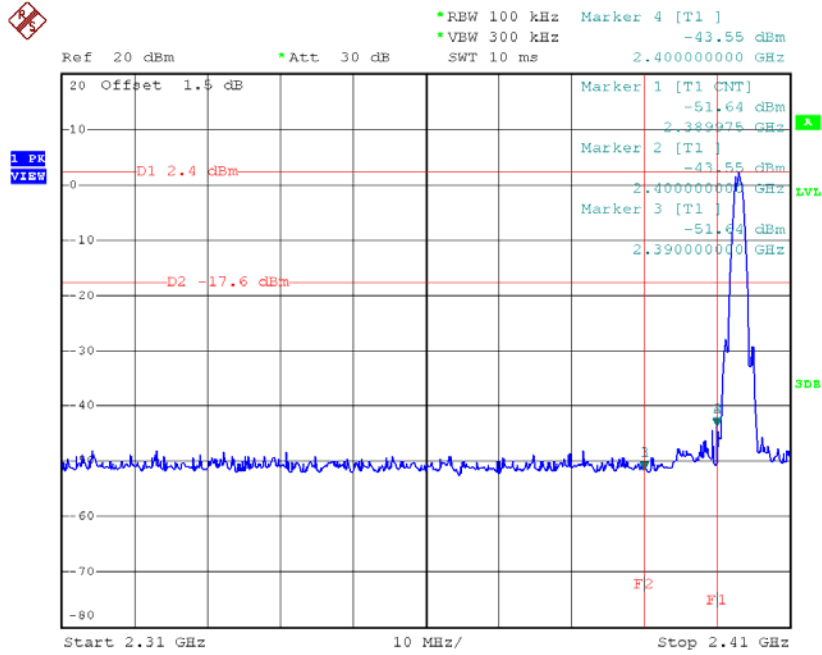

Date: 29.NOV.2018 09:20:20

CH77 (upper)

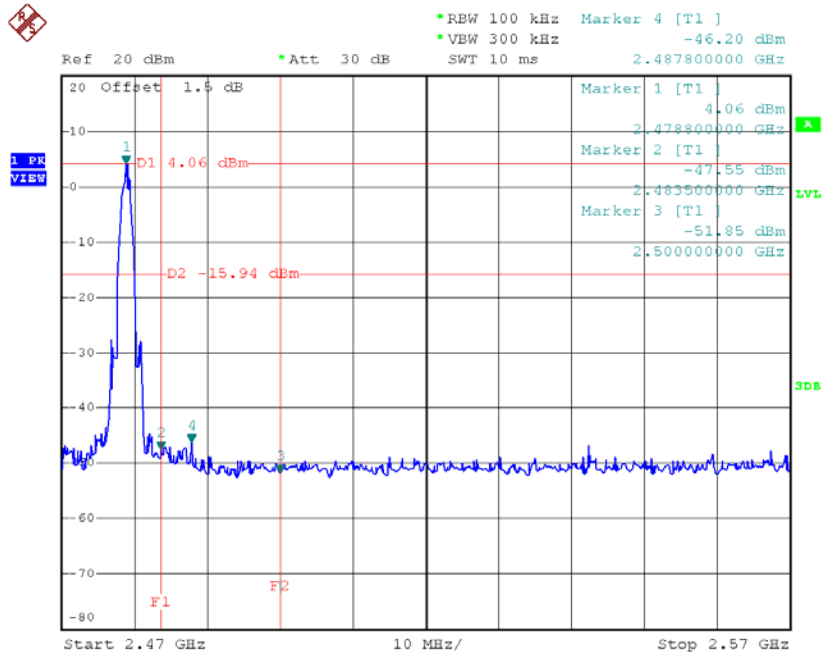

Date: 29.NOV.2018 09:39:14

CH01 (10 Harmonic of the frequency)

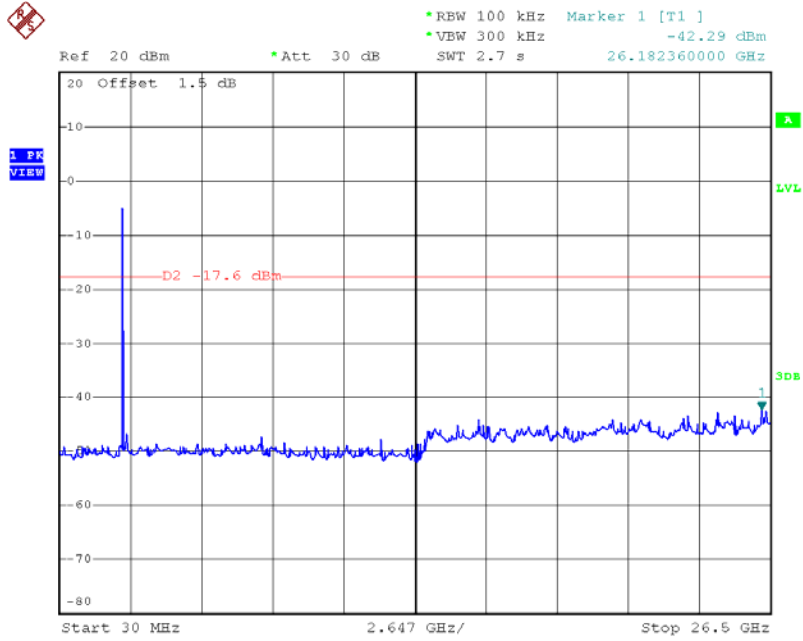

Date: 29.NOV.2018 09:22:27

CH38 (10 Harmonic of the frequency)

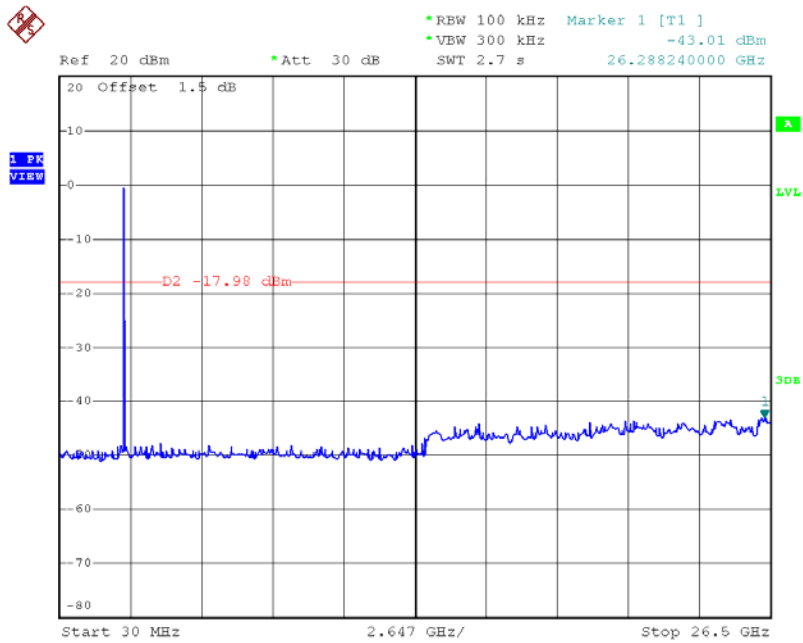

Date: 29.NOV.2018 09:33:33

CH77 (10 Harmonic of the frequency)

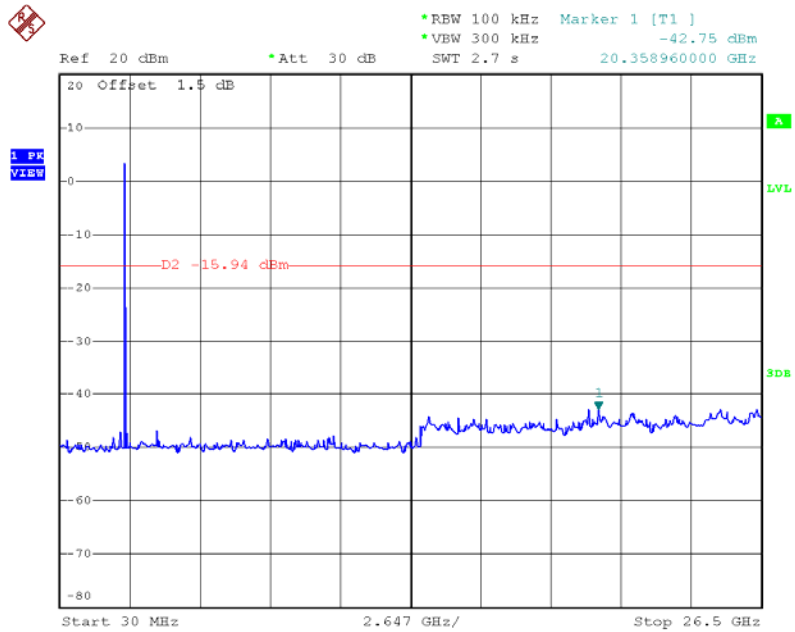

Date: 29.NOV.2018 09:40:02

APPENDIX H - POWER SPECTRAL DENSITY TEST

Test Mode:	TX Mode
------------	---------

Frequency (MHz)	Power Density (dBm/3kHz)	Power Density (mW/3kHz)	Max. Limit (dBm/3kHz)	Result
2403	-11.65	0.068	8.00	Complies
2440	-12.50	0.056	8.00	Complies
2479	-12.07	0.062	8.00	Complies

TX CH01

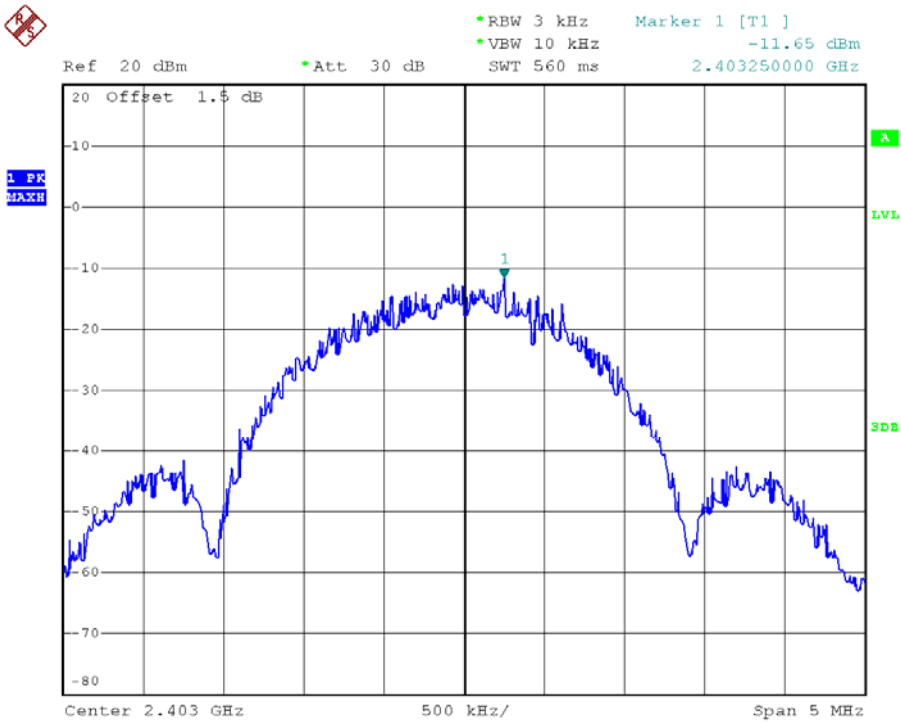

Date: 29.NOV.2018 09:13:20

TX CH38

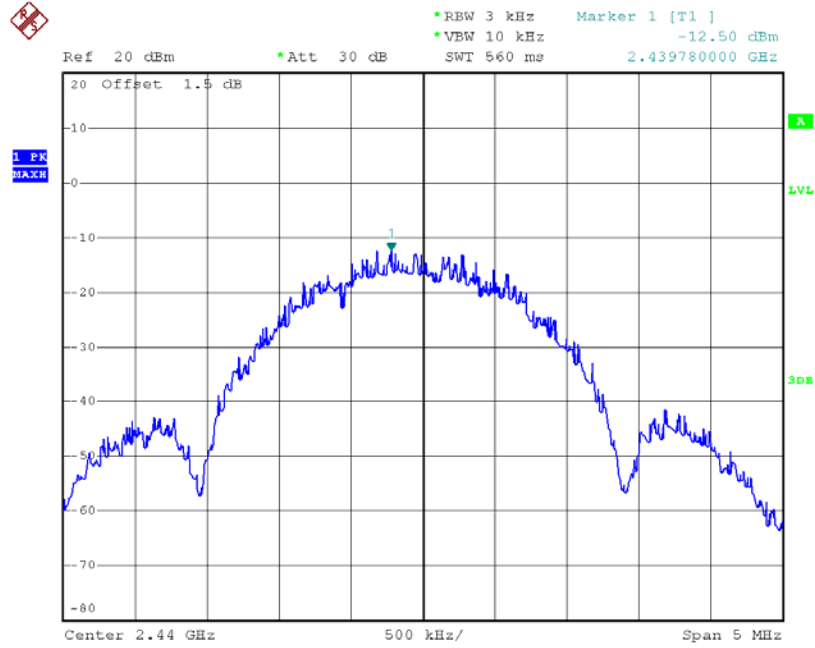

Date: 29.NOV.2018 09:29:20

TX CH77

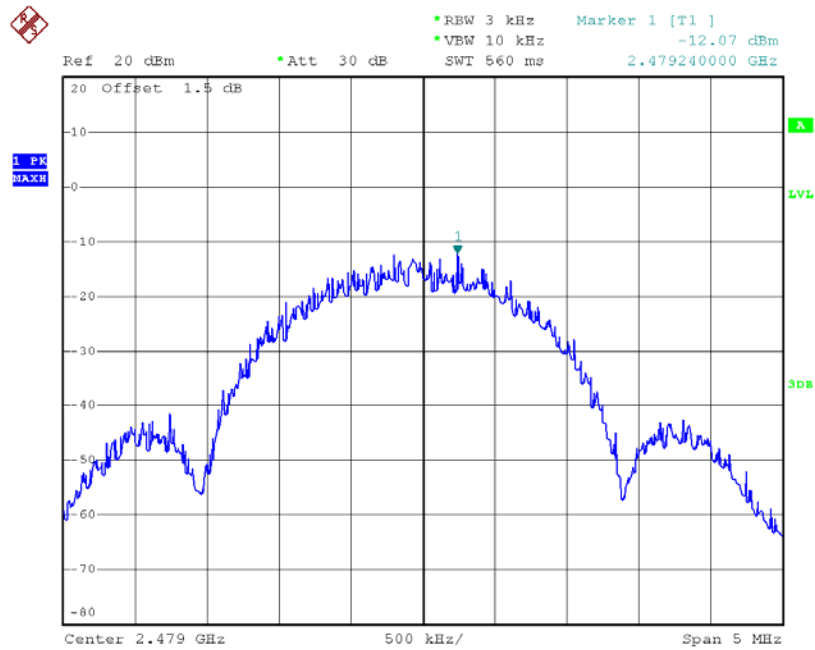

Date: 29.NOV.2018 09:35:10

End of Test Report