

FCC Test Report

Project No. : 1712C046
Equipment : Gaming Mouse Mat
Test Model : RZ02-0248
Series Model : RZ02-0248XXXX-XXXX (X: Can be 0-9, A-Z)
Applicant : Razer Inc.
Address : 201 3rd Street, Suite 900, San Francisco, CA 94103, USA

Date of Receipt : Dec. 07, 2017
Date of Test : Dec. 07, 2017 ~ Jan. 29, 2018
Issued Date : Jan. 30, 2018
Tested by : BTL Inc.

Testing Engineer : 
(Justin Jiang)

Technical Manager : 
(Bill Zhang)

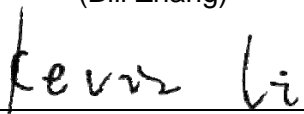
Authorized Signatory : 
(Kevin Li)

B T L I N C .

No.3, Jinshagang 1st Road, Shixia, Dalang Town, Dongguan,
Guangdong, China.

TEL: +86-769-8318-3000 FAX: +86-769-8319-6000



Declaration

BTL represents to the client that testing is done in accordance with standard procedures as applicable and that test instruments used has been calibrated with standards traceable to international standard(s) and/or national standard(s).

BTL's reports apply only to the specific samples tested under conditions. It is manufacture's responsibility to ensure that additional production units of this model are manufactured with the identical electrical and mechanical components. **BTL** shall have no liability for any declarations, inferences or generalizations drawn by the client or others from **BTL** issued reports.

BTL's report must not be used by the client to claim product certification, approval, or endorsement by NVLAP, NIST, or any agency of the Federal Government.

This report is the confidential property of the client. As a mutual protection to the clients, the public and **BTL-self**, extracts from the test report shall not be reproduced except in full with **BTL's** authorized written approval.

BTL's laboratory quality assurance procedures are in compliance with the **ISO Guide 17025** requirements, and accredited by the conformity assessment authorities listed in this test report.

Limitation

For the use of the authority's logo is limited unless the Test Standard(s)/Scope(s)/Item(s) mentioned in this test report is (are) included in the conformity assessment authorities acceptance respective.

Table of Contents	Page
REPORT ISSUED HISTORY	4
1 . CERTIFICATION	5
2 . SUMMARY OF TEST RESULTS	6
2.1 TEST FACILITY	7
2.2 MEASUREMENT UNCERTAINTY	7
3 . GENERAL INFORMATION	8
3.1 GENERAL DESCRIPTION OF EUT	8
3.2 DESCRIPTION OF TEST MODES	8
3.3 EUT OPERATING CONDITIONS	9
3.4 BLOCK DIAGRAM SHOWING THE CONFIGURATION OF SYSTEM TESTED	9
3.5 DESCRIPTION OF SUPPORT UNITS	10
4 . EMC EMISSION TEST	11
4.1 CONDUCTED EMISSION MEASUREMENT	11
4.1.1 POWER LINE CONDUCTED EMISSION	11
4.1.2 TEST PROCEDURE	11
4.1.3 DEVIATION FROM TEST STANDARD	11
4.1.4 TEST SETUP	12
4.1.5 EUT OPERATING CONDITIONS	12
4.1.6 TEST RESULTS	12
4.2 RADIATED EMISSION MEASUREMENT	13
4.2.1 LIMITS OF RADIATED EMISSION MEASUREMENT	13
4.2.2 TEST PROCEDURE	13
4.2.3 DEVIATION FROM TEST STANDARD	13
4.2.4 TEST SETUP	14
4.2.5 TEST RESULTS - 9KHZ TO 30MHZ	14
5 . MEASUREMENT INSTRUMENTS LIST	15
6 . EUT TEST PHOTO	16
APPENDIX A - CONDUCTED EMISSION	18
APPENDIX B - RADIATED EMISSION (9KHZ TO 30MHZ)	21

REPORT ISSUED HISTORY

Issued No.	Description	Issued Date
BTL-FCCE-2-1712C046	Original Issue.	Jan. 30, 2018

1. CERTIFICATION

Equipment : Gaming Mouse Mat
Brand Name : RAZER
Test Model : RZ02-0248
Series Model : RZ02-0248XXXX-XXXX (X: Can be 0-9, A-Z)
Applicant : Razer Inc.
Manufacturer : Razer (Asia-Pacific) Pte.,Ltd.
Address : 514 Chai Chee Lane #07-01 ~ 06 Singapore 469029, Tel: +65 6505 2188
Factory : RAZER TECHNOLOGY AND DEVELOPMENT (SHENZHEN) CO., LTD
Address : East Wing, 3rd Floor, Block 2, Phase 1 of Vision Shenzhen Business Park Keji
South Road, Hi-Tech Industrial Park, Shenzhen 518057, China
Date of Test : Dec. 07, 2017 ~ Jan. 29, 2018
Test Sample : Engineering Sample
Standard(s) : FCC Part 18
FCC/OET MP-5

The above equipment has been tested and found compliance with the requirement of the relative standards by BTL Inc.

The test data, data evaluation, and equipment configuration contained in our test report (Ref No. BTL-FCCE-2-1712C046) were obtained utilizing the test procedures, test instruments, test sites that has been accredited by the Authority of NVLAP according to the ISO-17025 quality assessment standard and technical standard(s).

2. SUMMARY OF TEST RESULTS

Test procedures according to the technical standards:

EMC Emission			
Standard(s)	Test Item	Judgment	Remark
FCC Part 18 FCC/OET MP-5	Conducted Emission	PASS	
	Radiated emission between 9kHz and 30MHz	PASS	NOTE(2)
	Radiated emission between 30MHz and 1000MHz	N/A	NOTE(1)
	Radiated emission Above 1 GHz	N/A	NOTE(1)

NOTE:

(1) "N/A" denotes test is not applicable to this device.

(2) The main frequency of wireless charge is below 1.705MHz , so radiation test to 30MHz.

2.1 TEST FACILITY

The test facilities used to collect the test data in this report at the location of No.3, Jinshagang 1st Road, Shixia, Dalang Town, Dongguan, Guangdong, China.

BTL's test firm number for FCC: 854385

BTL's designation number for FCC: CN5020

2.2 MEASUREMENT UNCERTAINTY

Where relevant, the following measurement uncertainty levels have been estimated for tests performed on the EUT as specified in CISPR 16-4-2, The BTL measurement uncertainty is less than the CISPR 16-4-2 U_{CISPR} requirement.

The reported uncertainty of measurement $y \pm U$, where expanded uncertainty U is based on a standard uncertainty multiplied by a coverage factor of $k=2$, providing a level of confidence of approximately **95%**.

A. Conducted Measurement :

Test Site	Method	Measurement Frequency Range	U, (dB)
DG-C02	CISPR	150 kHz ~ 30MHz	2.32

B. Radiated Measurement :

Test Site	Method	Measurement Frequency Range	U,(dB)
DG-CB01	CISPR	9kHz ~ 30MHz	3.42

Note: Unless specifically mentioned, the uncertainty of measurement has not been taken into account to declare the compliance or non-compliance to the specification.

3. GENERAL INFORMATION

3.1 GENERAL DESCRIPTION OF EUT

Equipment	Gaming Mouse Mat
Brand Name	RAZER
Test Model	RZ02-0248
Series Model	RZ02-0248XXXX-XXXX (X: Can be 0-9, A-Z)
Model Difference	It is the same as the basic model and X is used to define which country it is for under the same family series. The system's model is RZ84-0248, and the system contains of Gaming Mouse (Model: RZ01-0248) and Gaming Mouse Mat (Model: RZ02-0248).
Power Source	Supplied from USB port.
Power Rating	DC 5V, 900mA
Connecting I/O ports	1* USB port

Note:

1. For a more detailed features description, please refer to the manufacturer's specifications or the user's manual.

3.2 DESCRIPTION OF TEST MODES

To investigate the maximum EMI emission characteristics generated from EUT, the test system was pre-scanning tested based on the consideration of following EUT operation mode or test configuration mode which possible have effect on EMI emission level. Each of these EUT operation mode(s) or test configuration mode(s) mentioned above was evaluated respectively.

Pretest Mode	Description
Mode 1	Wireless Charging

For Conducted Test	
Final Test Mode	Description
Mode 1	Wireless Charging

For Radiated Test	
Final Test Mode	Description
Mode 1	Wireless Charging

3.3 EUT OPERATING CONDITIONS

The EUT exercise program used during radiated and/or conducted emission measurement was designed to exercise the various system components in a manner similar to a typical use. The standard test signals and output signal as following:

1. EUT connected to PC via USB cable.
2. PC connected to keyboard via USB cable.
3. PC connected to monitor via D-SUB cable.
4. PC connected to printer via parallel cable.
5. PC connected to modem via RS232 cable.
6. The mouse is putted on the EUT.

3.4 BLOCK DIAGRAM SHOWING THE CONFIGURATION OF SYSTEM TESTED

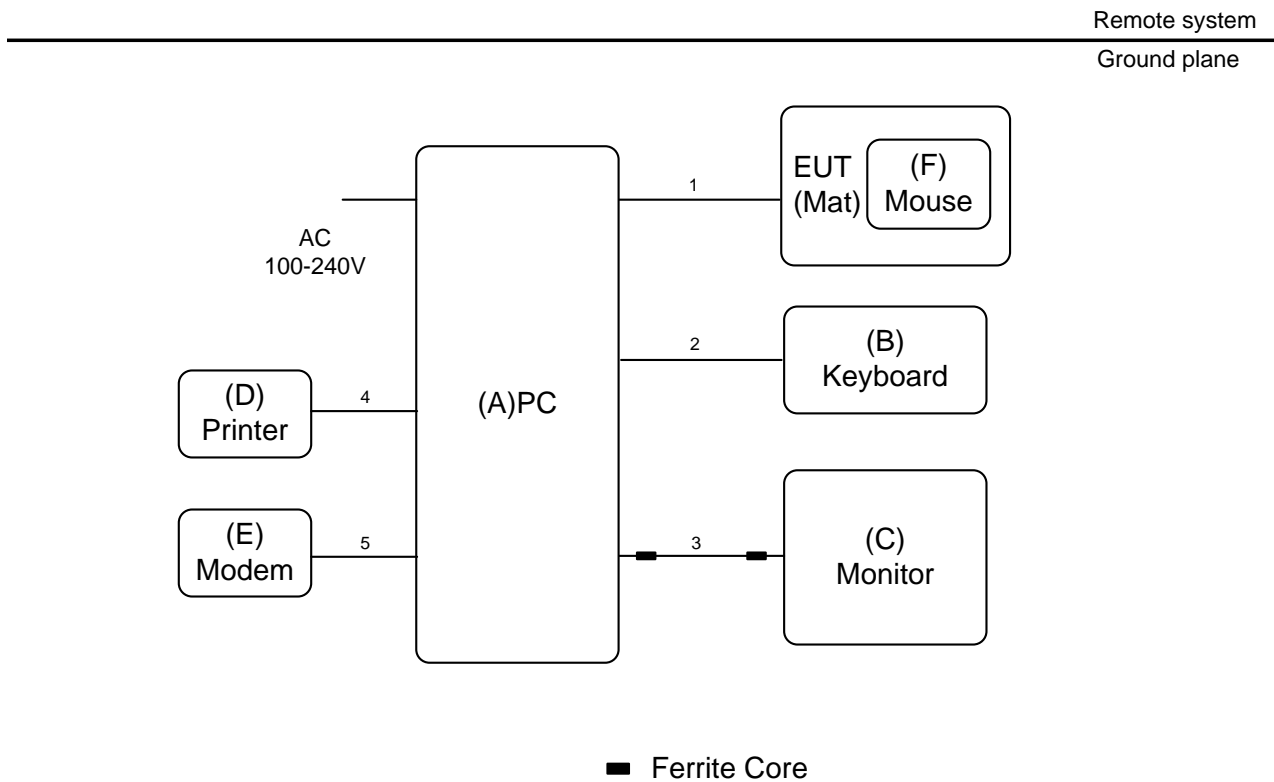

3.5 DESCRIPTION OF SUPPORT UNITS

The EUT has been tested as an independent unit together with other necessary accessories or support units. The following support units or accessories were used to form a representative test configuration during the tests.

Item	Equipment	Mfr/Brand	Model/Type No.	FCC ID	Series No.
A	PC	DELL	VOSTRO 470	DOC	24454162837
B	Keyboard	DELL	L100	DOC	CNORH6596589071T08NE
C	Monitor	DELL	U2713	DOC	CN-0GK0DK-74445-35H-A12L
D	Printer	SII	DPU-414	DOC	3018507 B
E	Modem	ACEEX	DM-1414V	IFAXDM1414	0603002131
F	Gaming Mouse Mat	Razer	RZ01-0248	N/A	N/A

Item	Shielded Type	Ferrite Core	Length	Note
1	YES	NO	1.8m	USB Cable
2	YES	NO	1.8m	USB Cable
3	YES	YES	1.8m	D-SUB Cable
4	YES	NO	1.8m	Parallel Cable
5	YES	NO	1.8m	RS232 Cable

4. EMC EMISSION TEST

4.1 CONDUCTED EMISSION MEASUREMENT

4.1.1 POWER LINE CONDUCTED EMISSION (Frequency Range 150KHz-30MHz)

FREQUENCY (MHz)	Conducted limit (dBuV)	
	Quasi-peak	Average
0.15- 0.5	66 - 56 *	56 - 46 *
0.50 -5.0	56.00	46.00
5.0 -30.0	60.00	50.00

Note:

- (1) The tighter limit applies at the band edges.
- (2) The limit of " * " marked band means the limitation decreases linearly with the logarithm of the frequency in the range.
- (3) The test result calculated as following:
 Measurement Value = Reading Level + Correct Factor
 Correct Factor = Insertion Loss + Cable Loss + Attenuator Factor(if use)
 Margin Level = Measurement Value - Limit Value

4.1.2 TEST PROCEDURE

- a. The EUT was placed 0.8 meters from the horizontal ground plane with EUT being connected to the power mains through a line impedance stabilization network (LISN). All other support equipment powered from additional LISN(s). The LISN provide 50 Ohm/ 50uH of coupling impedance for the measuring instrument.
- b. Interconnecting cables that hang closer than 40 cm to the ground plane shall be folded back and forth in the center forming a bundle 30 to 40 cm long.
- c. I/O cables that are not connected to a peripheral shall be bundled in the center. The end of the cable may be terminated, if required, using the correct terminating impedance. The overall length shall not exceed 1 m.
- d. LISN at least 80 cm from nearest part of EUT chassis.
- e. For the actual test configuration, please refer to the related Item –EUT Test Photos..

4.1.3 DEVIATION FROM TEST STANDARD

No deviation

4.1.4 TEST SETUP

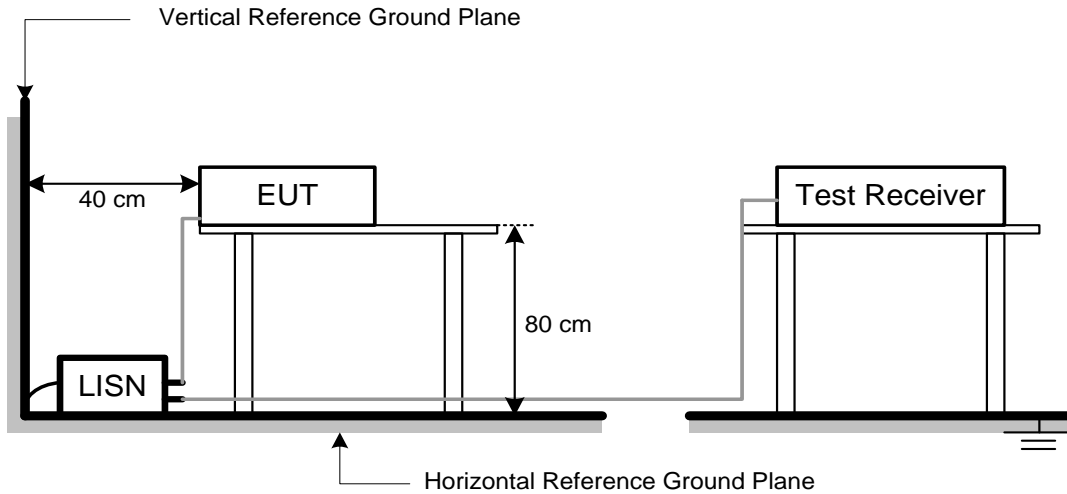

4.1.5 EUT OPERATING CONDITIONS

The EUT exercise program used during radiated and/or conducted emission measurement was designed to exercise the various system components in a manner similar to a typical use.

4.1.6 TEST RESULTS

Please refer to the Appendix A.

Temperature: 25°C Relative Humidity: 53%

Remark

- (1) Reading in which marked as QP means measurements by using are Quasi-Peak Mode with Detector BW=9KHz; SPA setting in RBW=10KHz,VBW =10KHz, Swp. Time = 0.3 sec./MHz ◦ Reading in which marked as AV means measurements by using are Average Mode with instrument setting in RBW=10KHz,VBW =10KHz, Swp. Time =0.3 sec./MHz ◦
- (2) All readings are QP Mode value unless otherwise stated AVG in column of『Note』. If the QP Mode Measured value compliance with the QP Limits and lower than AVG Limits, the EUT shall be deemed to meet both QP & AVG Limits and then only QP Mode was measured, but AVG Mode didn't perform ◦ In this case, a “ * ” marked in AVG Mode column of Interference Voltage Measured ◦
- (3) Measuring frequency range from 150KHz to 30MHz ◦

4.2 RADIATED EMISSION MEASUREMENT

4.2.1 LIMITS OF RADIATED EMISSION MEASUREMENT

Operating frequency	Field Strength (uV/m)	Measurement Distance (meters)	F.S Limitation at 3m Distance
			(dBuV/m)
Any non-ISM	15	300	103.5

Notes:

- (1) The Equipment is for 18.305(b) Any type unless otherwise specified (miscellaneous) Operating frequency in any non-ISM frequency
- (2) Operation of ISM equipment within the following safety, search and rescue frequency bands is prohibited: 490–510 kHz, 2170–2194 kHz, 8354–8374 kHz, 121.4–121.6 MHz, 156.7–156.9 MHz, and 242.8–243.2 MHz.
- (3) Distance extrapolation factor = $40 \log(\text{specific distance} / \text{test distance})$ (dB);
Limit line = specific limits (dBuV) + distance extrapolation factor.
- (4) The test result calculated as following:
Measurement Value = Reading Level + Correct Factor
Correct Factor = Antenna Factor + Cable Loss - Amplifier Gain(if use)
Margin Level = Measurement Value - Limit Value

4.2.2 TEST PROCEDURE

- a. The EUT was placed on the top of a rotating table 0.8 meters above the ground at a 1m or 3 meter open area test site. The table was rotated 360 degrees to determine the position of the highest radiation.
- b. The height of the equipment or of the substitution antenna shall be 0.8 m; the height of the test antenna shall vary between 1 m to 4 m. Both horizontal and vertical polarizations of the antenna are set to make the measurement.
- c. The initial step in collecting radiated emission data is a spectrum analyzer peak detector mode pre-scanning the measurement frequency range. Significant peaks are then marked and then Quasi Peak detector mode re-measured.
- d. If the Peak Mode measured value compliance with and lower than Quasi Peak Mode Limit, the EUT shall be deemed to meet QP Limits and then no additional QP Mode measurement performed.
- e. For the actual test configuration, please refer to the related Item –EUT Test Photos.

4.2.3 DEVIATION FROM TEST STANDARD

No deviation

4.2.4 TEST SETUP

For radiated emissions between 9kHz and 30MHz

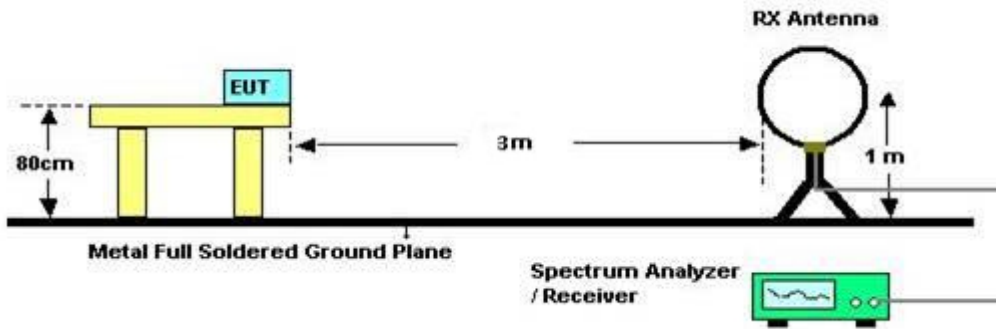

4.2.5 TEST RESULTS - 9KHZ TO 30MHZ

Please refer to the Appendix B.

Temperature: 25°C Relative Humidity: 60%

Remark:

- (1) All readings are Peak unless otherwise stated QP in column of 『Note』 . Peak denotes that the Peak reading compliance with the QP Limits and then QP Mode measurement didn't perform ◦
- (2) Measuring frequency range from 9kHz to 1000MHz & 30MHz to 1000MH.
- (3) If the peak scan value lower limit more than 20dB, then this signal data does not show in table.

5. MEASUREMENT INSTRUMENTS LIST

Conducted Emission					
Item	Kind of Equipment	Manufacturer	Type No.	Serial No.	Calibrated until
1	EMI Test Receiver	R&S	ESCI	100382	Mar. 26, 2018
2	LISN	EMCO	3816/2	52765	Mar. 26, 2018
3	50Ω Terminator	SHX	TF2-3G-A	8122901	Mar. 26, 2018
4	TWO-LINE V-NETWORK	R&S	ENV216	101447	Mar. 26, 2018
5	Measurement Software	Farad	EZ-EMC Ver.NB-03A1-01	N/A	N/A
6	Cable	N/A	RG223	12m	Oct. 19, 2018

Radiated Emission-9KHz to 30MHz					
Item	Kind of Equipment	Manufacturer	Type No.	Serial No.	Calibrated until
1	Antenna	ETS	3142B	26419	Mar. 26, 2018
2	EMI Test Receiver	R&S	ESCI	100895	Mar. 26, 2018
3	Cable	emci	LMR-400(30MHz-1GHz)(7m+7m)	N/A	Jun. 26, 2018
4	Controller	ETS-Lindgren	2090	N/A	N/A
5	Measurement Software	Farad	EZ-EMC Ver.NB-03A1-01	N/A	N/A

Remark: "N/A" denotes no model name, no serial no. or no calibration specified.

All calibration period of equipment list is one year.

APPENDIX A - CONDUCTED EMISSION

Test Voltage:	DC 5V
Test Mode:	Wireless Charging

Phase: Line

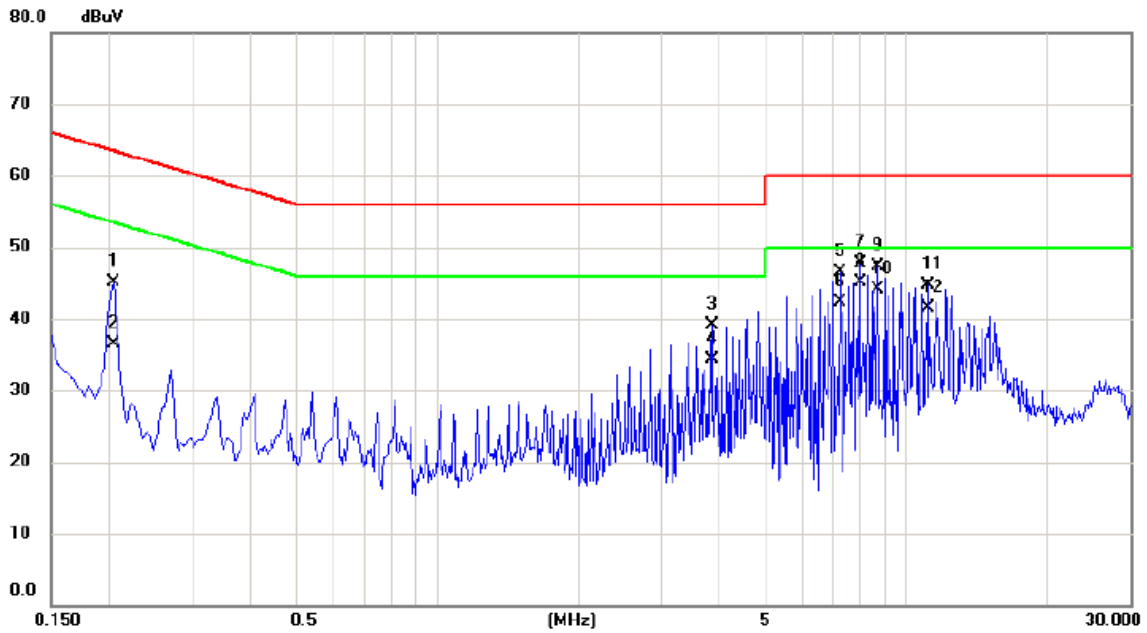

No.	Mk.	Freq. MHz	Reading Level dBuV	Correct Factor dB	Measure- ment dBuV	Limit dBuV	Margin dB	Detector	Comment
1		0.2040	35.34	9.76	45.10	63.45	-18.35	QP	
2		0.2040	26.69	9.76	36.45	53.45	-17.00	AVG	
3		3.8400	29.11	10.02	39.13	56.00	-16.87	QP	
4		3.8400	24.23	10.02	34.25	46.00	-11.75	AVG	
5		7.2465	36.32	10.19	46.51	60.00	-13.49	QP	
6		7.2465	32.15	10.19	42.34	50.00	-7.66	AVG	
7		7.9575	37.41	10.23	47.64	60.00	-12.36	QP	
8	*	7.9575	34.90	10.23	45.13	50.00	-4.87	AVG	
9		8.6684	37.03	10.26	47.29	60.00	-12.71	QP	
10		8.6684	33.90	10.26	44.16	50.00	-5.84	AVG	
11		11.1300	34.35	10.38	44.73	60.00	-15.27	QP	
12		11.1300	31.12	10.38	41.50	50.00	-8.50	AVG	

Test Voltage:	DC 5V
Test Mode:	Wireless Charging

Phase: Neutral

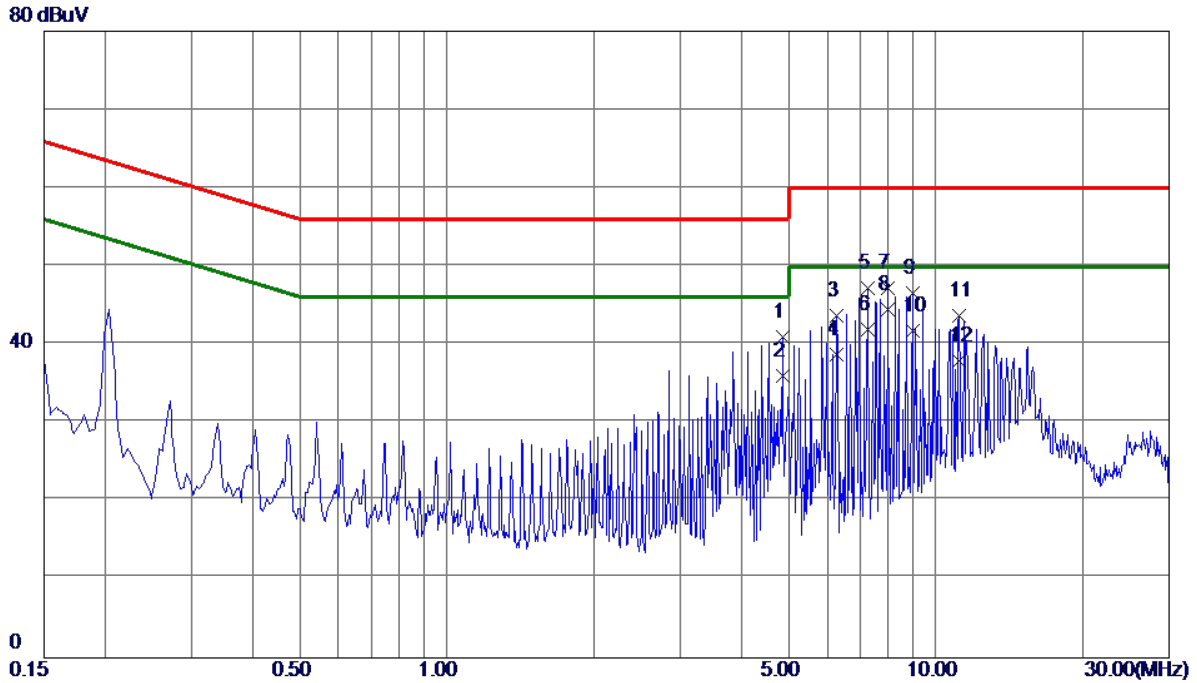

No.	Freq. MHz	Reading Level dBuV	Correct Factor dB	Measure ment dBuV	Limit dBuV	Margin dB	Detector
1	4.8570	30.92	10.00	40.92	56.00	-15.08	QP
2	4.8570	25.95	10.00	35.95	46.00	-10.05	AVG
3	6.2564	33.55	10.08	43.63	60.00	-16.37	QP
4	6.2565	28.65	10.08	38.73	50.00	-11.27	AVG
5	7.2510	37.04	10.12	47.16	60.00	-12.84	QP
6	7.2510	31.81	10.12	41.93	50.00	-8.07	AVG
7	7.9620	37.03	10.15	47.18	60.00	-12.82	QP
8 *	7.9620	34.31	10.15	44.46	50.00	-5.54	AVG
9	8.9610	36.31	10.21	46.52	60.00	-13.48	QP
10	8.9610	31.56	10.21	41.77	50.00	-8.23	AVG
11	11.1390	33.32	10.35	43.67	60.00	-16.33	QP
12	11.1390	27.63	10.35	37.98	50.00	-12.02	AVG

APPENDIX B - RADIATED EMISSION (9KHZ TO 30MHZ)

Test Voltage:	DC 5V
Test Mode:	Wireless Charging

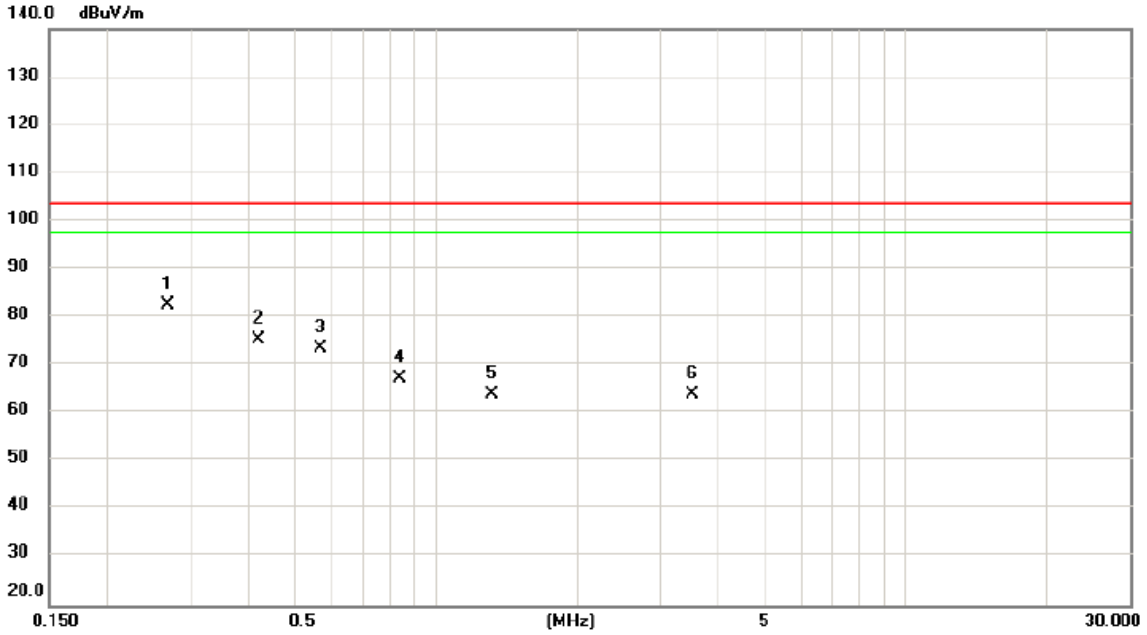

No.	Mk.	Freq. MHz	Reading Level dBuV	Correct Factor dB	Measure- ment dBuV/m	Limit dBuV/m	Margin dB	Detector	Comment
1	*	0.2694	63.85	18.63	82.48	103.50	-21.02	QP	
2		0.4187	56.75	18.46	75.21	103.50	-28.29	QP	
3		0.5680	55.02	18.40	73.42	103.50	-30.08	QP	
4		0.8366	49.00	18.20	67.20	103.50	-36.30	QP	
5		1.3141	46.14	17.75	63.89	103.50	-39.61	QP	
6		3.5231	46.09	17.74	63.83	103.50	-39.67	QP	