



# FCC Radio Test Report

## FCC ID: RWO-RZ010524

This report concerns: **Original Grant**

**Project No.** : 2405C230  
**Equipment** : Gaming Mouse  
**Brand Name** :   
**Test Model** : RZ01-0524  
**Series Model** : RZ01-0524XXXX-XXXX (X can be 0-9 or A-Z)  
**Applicant** : Razer Inc.  
**Address** : 9 Pasteur, Suite 100, Irvine, CA92618, USA  
**Manufacturer** : RAZER (ASIA-PACIFIC) PTE. LTD.  
**Address** : Razer SEA HQ, 1 One-north Crescent, #02-01, Singapore 138538  
**Factory** : RAZER TECHNOLOGY AND DEVELOPMENT (SHENZHEN) CO., LTD  
**Address** : East Wing, 3rd Floor, Block 2, Phase 1 of Vision Shenzhen Business Park Keji South Road, Hi-Tech Industrial Park, Shenzhen 518057, China  
**Date of Receipt** : May 21, 2024  
**Date of Test** : May 23, 2024 ~ Jun. 17, 2024  
**Issued Date** : Jun. 27, 2024  
**Report Version** : R00  
**Test Sample** : Sample No.: DG20240521184 for radiated emissions and conducted emissions, DG20240521183 for conducted.  
**Standard(s)** : FCC CFR Title 47, Part 15, Subpart C

The above equipment has been tested and found compliance with the requirement of the relative standards by BTL Inc.

**Prepared by** : Vincent Tan  
 Vincent Tan

**Approved by** : Chay Cai  
 Chay Cai

Room 108, Building 2, No.1, Yile Road, Songshan Lake Zone, Dongguan City, Guangdong, People's Republic of China.

Tel: +86-769-8318-3000    Web: www.newbtl.com    Service mail: btl\_qa@newbtl.com

**Declaration**

**BTL** represents to the client that testing is done in accordance with standard procedures as applicable and that test instruments used has been calibrated with standards traceable to international standard(s) and/or national standard(s).

**BTL's** reports apply only to the specific samples tested under conditions. It is manufacture's responsibility to ensure that additional production units of this model are manufactured with the identical electrical and mechanical components. **BTL** assumes no responsibility for the data provided by the customer, any statements, inferences or generalizations drawn by the customer or others from the reports issued by **BTL**. The report must not be used by the client to claim product certification, approval, or endorsement by A2LA or any agency of the U.S. Government.

This report is the confidential property of the client. As a mutual protection to the clients, the public and ourselves, the test report shall not be reproduced, except in full, without our written approval.

**BTL's** laboratory quality assurance procedures are in compliance with the ISO/IEC 17025: 2017 requirements, and accredited by the conformity assessment authorities listed in this test report.

**BTL** is not responsible for the sampling stage, so the results only apply to the sample as received.

The information, data and test plan are provided by manufacturer which may affect the validity of results, so it is manufacturer's responsibility to ensure that the apparatus meets the essential requirements of applied standards and in all the possible configurations as representative of its intended use.

**Limitation**

For the use of the authority's logo is limited unless the Test Standard(s)/Scope(s)/Item(s) mentioned in this test report is (are) included in the conformity assessment authorities acceptance respective.

Please note that the measurement uncertainty is provided for informational purpose only and are not use in determining the Pass/Fail results.

<b>Table of Contents</b>	<b>Page</b>
<b>REPORT ISSUED HISTORY</b>	<b>6</b>
<b>1 . APPLICABLE STANDARDS</b>	<b>7</b>
<b>2 . SUMMARY OF TEST RESULTS</b>	<b>7</b>
2.1 TEST FACILITY	8
2.2 MEASUREMENT UNCERTAINTY	8
2.3 TEST ENVIRONMENT CONDITIONS	9
<b>3 . GENERAL INFORMATION</b>	<b>10</b>
3.1 GENERAL DESCRIPTION OF EUT	10
3.2 DESCRIPTION OF TEST MODES	12
3.3 PARAMETERS OF TEST SOFTWARE	12
3.4 BLOCK DIAGRAM SHOWING THE CONFIGURATION OF SYSTEM TESTED	13
3.5 SUPPORT UNITS	14
3.6 CUSTOMER INFORMATION DESCRIPTION	14
<b>4 . AC POWER LINE CONDUCTED EMISSIONS</b>	<b>15</b>
4.1 LIMIT	15
4.2 TEST PROCEDURE	15
4.3 DEVIATION FROM TEST STANDARD	15
4.4 TEST SETUP	16
4.5 EUT OPERATING CONDITIONS	16
4.6 TEST RESULTS	16
<b>5 . RADIATED EMISSIONS</b>	<b>17</b>
5.1 LIMIT	17
5.2 TEST PROCEDURE	18
5.3 DEVIATION FROM TEST STANDARD	19
5.4 TEST SETUP	19
5.5 EUT OPERATING CONDITIONS	21
5.6 TEST RESULT - 9 KHZ TO 30 MHZ	21
5.7 TEST RESULT - 30 MHZ TO 1000 MHZ	21
5.8 TEST RESULT - ABOVE 1000 MHZ	21
<b>6 . BANDWIDTH</b>	<b>22</b>
6.1 LIMIT	22
6.2 TEST PROCEDURE	22

<b>Table of Contents</b>	<b>Page</b>
6.3 DEVIATION FROM STANDARD	22
6.4 TEST SETUP	22
6.5 EUT OPERATION CONDITIONS	22
6.6 TEST RESULTS	22
<b>7 . MAXIMUM OUTPUT POWER</b>	<b>23</b>
7.1 LIMIT	23
7.2 TEST PROCEDURE	23
7.3 DEVIATION FROM STANDARD	23
7.4 TEST SETUP	23
7.5 EUT OPERATION CONDITIONS	23
7.6 TEST RESULTS	23
<b>8 . CONDUCTED SPURIOUS EMISSION</b>	<b>24</b>
8.1 LIMIT	24
8.2 TEST PROCEDURE	24
8.3 DEVIATION FROM STANDARD	24
8.4 TEST SETUP	24
8.5 EUT OPERATION CONDITIONS	24
8.6 TEST RESULTS	24
<b>9 . POWER SPECTRAL DENSITY</b>	<b>25</b>
9.1 LIMIT	25
9.2 TEST PROCEDURE	25
9.3 DEVIATION FROM STANDARD	25
9.4 TEST SETUP	25
9.5 EUT OPERATION CONDITIONS	25
9.6 TEST RESULTS	25
<b>10 . MEASUREMENT INSTRUMENTS LIST</b>	<b>26</b>
<b>APPENDIX A - AC POWER LINE CONDUCTED EMISSIONS</b>	<b>28</b>
<b>APPENDIX B - RADIATED EMISSION - 9 KHZ TO 30 MHZ</b>	<b>31</b>
<b>APPENDIX C - RADIATED EMISSION - 30 MHZ TO 1000 MHZ</b>	<b>36</b>
<b>APPENDIX D - RADIATED EMISSION - ABOVE 1000 MHZ</b>	<b>39</b>
<b>APPENDIX E - BANDWIDTH</b>	<b>45</b>
<b>APPENDIX F - MAXIMUM OUTPUT POWER</b>	<b>47</b>

**Table of Contents****Page****APPENDIX G - CONDUCTED SPURIOUS EMISSION****49****APPENDIX H - POWER SPECTRAL DENSITY****51**

**REPORT ISSUED HISTORY**

Report No.	Version	Description	Issued Date	Note
BTL-FCCP-2-2405C230	R00	Original Report.	Jun. 27, 2024	Valid

### 1. APPLICABLE STANDARDS

According to the specifications of the manufacturer, the EUT must comply with the requirements of the following standards:

ANSI C63.10-2013

The following reference test guidance is not within the scope of accreditation of A2LA:

KDB 558074 D01 15.247 Meas Guidance v05r02

### 2. SUMMARY OF TEST RESULTS

Test procedures according to the technical standard(s):

FCC CFR Title 47, Part 15, Subpart C				
Standard(s) Section	Test Item	Test Result	Judgment	Remark
15.207	AC Power Line Conducted Emissions	APPENDIX A	PASS	-----
15.247(d) 15.205(a) 15.209(a)	Radiated Emissions	APPENDIX B APPENDIX C APPENDIX D	PASS	-----
15.247(a)(2)	Bandwidth	APPENDIX E	PASS	-----
15.247(b)(3)	Maximum Output Power	APPENDIX F	PASS	-----
15.247(d)	Conducted Spurious Emission	APPENDIX G	PASS	-----
15.247(e)	Power Spectral Density	APPENDIX H	PASS	-----
15.203	Antenna Requirement	-----	PASS	Note(2)

Note:

(1) "N/A" denotes test is not applicable to this device.

(2) The device what use a permanently attached antenna were considered sufficient to comply with the provisions of 15.203.

## 2.1 TEST FACILITY

The test facilities used to collect the test data in this report is at the location of No.3, Jinshagang 1st Road, Dalang, Dongguan City, Guangdong People's Republic of China.

BTL's Registration Number for FCC: 747969

BTL's Designation Number for FCC: CN1377

## 2.2 MEASUREMENT UNCERTAINTY

ISO/IEC 17025 requires that an estimate of the measurement uncertainties associated with the emissions test results be included in the report. The measurement uncertainties given below are based on a 95.45% confidence level (based on a coverage factor (k=2))

The BTL measurement uncertainty as below table:

### A. AC power line conducted emissions Measurement:

Test Site	Method	Measurement Frequency Range	U,(dB)
DG-C02	CISPR	150kHz ~ 30MHz	2.88

### B. Radiated emissions Measurement:

Test Site	Method	Measurement Frequency Range	U,(dB)
DG-CB01	CISPR	9kHz ~ 30MHz	2.36

Test Site	Method	Measurement Frequency Range	Ant. H / V	U,(dB)
DG-CB03 (3m)	CISPR	30MHz ~ 200MHz	V	4.40
		30MHz ~ 200MHz	H	3.62
		200MHz ~ 1,000MHz	V	4.58
		200MHz ~ 1,000MHz	H	3.98

Test Site	Method	Measurement Frequency Range	U,(dB)
DG-CB03 (3m)	CISPR	1GHz ~ 6GHz	4.08
		6GHz ~ 18GHz	4.62

Test Site	Method	Measurement Frequency Range	U,(dB)
DG-CB03 (1m)	CISPR	18 ~ 26.5 GHz	3.36

### C. Other Measurement:

Test Item	Uncertainty
Bandwidth	0.90 %
Maximum Output Power	1.3 dB
Conducted Spurious Emission	1.9 dB
Power Spectral Density	1.4 dB
Temperature	0.8 °C
Humidity	2.2 %

Note: Unless specifically mentioned, the uncertainty of measurement has not been taken into account to declare the compliance or non-compliance to the specification.



### 2.3 TEST ENVIRONMENT CONDITIONS

Test Item	Temperature	Humidity	Test Voltage	Tested By	Test Date
AC Power Line Conducted Emissions	25°C	40%	AC □20V/60Hz	Hayden Chen	Jun. 04, 2024
Radiated Emissions-9 kHz to 30 MHz	23°C	56%	DC 3.7V	Hayden Chen	Jun. 05 2024
Radiated Emissions-30 MHz to 1000 MHz	21°C	50%	DC 3.7V	Allen Tong	Jun. 01 2024
Radiated Emissions-Above 1000 MHz	21-22°C	50-58%	DC 3.7V	Terry Deng Allen Tong	Jun. 01 2024- Jun. 05 2024
Bandwidth	24°C	49%	DC 3.7V	Parker Yang	May 25, 2024
Maximum Output Power	24°C	49%	DC 3.7V	Parker Yang	May 25, 2024
Conducted Spurious Emission	24°C	49%	DC 3.7V	Parker Yang	May 25, 2024
Power Spectral Density	24°C	49%	DC 3.7V	Parker Yang	May 25, 2024

### 3. GENERAL INFORMATION

#### 3.1 GENERAL DESCRIPTION OF EUT

Equipment	Gaming Mouse
Brand Name	 RAZER,
Test Model	RZ01-0524
Series Model	RZ01-0524XXXX-XXXX (X can be 0-9 or A-Z)
Model Difference(s)	Only differ in model name.
Hardware Version	V1.5
Software Version	v0.00.03.00
Power Source	1# Supplied from PC USB port. 2# Supplied from battery. Model: PL642930
Power Rating	1# 5V===500mA 2# 3.7V 600mAh 2.22Wh
Operation Frequency	2402 MHz ~ 2480 MHz
Modulation Type	GFSK
Bit Rate of Transmitter	2Mbps
Max. Output Power	2Mbps: 4.78 dBm (0.0030 W)

Note:

- For a more detailed features description, please refer to the manufacturer's specifications or the user's manual.
- The system's model name is RZ01-0524XXXX-XXXX (X: Can be 0-9, A-Z), and the system contains a Gaming Mouse (Model name:RZ01-0524) and USB Dongle (Model name: DGRFG7).

## 3. Channel List:

Channel	Frequency (MHz)	Channel	Frequency (MHz)	Channel	Frequency (MHz)
00	2402	27	2429	54	2456
01	2403	28	2430	55	2457
02	2404	29	2431	56	2458
03	2405	30	2432	57	2459
04	2406	31	2433	58	2460
05	2407	32	2434	59	2461
06	2408	33	2435	60	2462
07	2409	34	2436	61	2463
08	2410	35	2437	62	2464
09	2411	36	2438	63	2465
10	2412	37	2439	64	2466
11	2413	38	2440	65	2467
12	2414	39	2441	66	2468
13	2415	40	2442	67	2469
14	2416	41	2443	68	2470
15	2417	42	2444	69	2471
16	2418	43	2445	70	2472
17	2419	44	2446	71	2473
18	2420	45	2447	72	2474
19	2421	46	2448	73	2475
20	2422	47	2449	74	2476
21	2423	48	2450	75	2477
22	2424	49	2451	76	2478
23	2425	50	2452	77	2479
24	2426	51	2453	78	2480
25	2427	52	2454		
26	2428	53	2455		

## 4. Table for Filed Antenna:

Ant.	Brand	Model Name	Antenna Type	Connector	Gain (dBi)
1	RAZER	RZ01-0524	PCB	N/A	3.00

### 3.2 DESCRIPTION OF TEST MODES

The test system was pre-tested based on the consideration of all possible combinations of EUT operation mode.

Pretest Mode	Description
Mode 1	TX Mode_2Mbps Channel 00/39/78
Mode 2	TX Mode_2Mbps Channel 78

Following mode(s) was (were) found to be the worst case(s) and selected for the final test.

AC power line conducted emissions test	
Final Test Mode	Description
Mode 2	TX Mode_2Mbps Channel 78

Radiated emissions test - Below 1GHz	
Final Test Mode	Description
Mode 2	TX Mode_2Mbps Channel 78

Radiated emissions test - Above 1GHz	
Final Test Mode	Description
Mode 1	TX Mode_2Mbps Channel 00/39/78

Conducted test	
Final Test Mode	Description
Mode 1	TX Mode_2Mbps Channel 00/39/78

Note:

- (1) For radiated emission above 1 GHz test, the spurious points of 1GHz~26.5GHz have been pre-tested and in this report only recorded the worst case. The remaining spurious points are all below the limit value of 20dB.
- (2) For AC power line conducted emissions and radiated emissions below 1 GHz test, the 2Mbps Channel 78 is found to be the worst case and recorded.
- (3) For radiated emission Harmonic above 18GHz test, only tested the worst case and recorded.
- (4) For radiated emission above 1GHz test, both Vertical and Horizontal are evaluated, only the worst case is recorded.

### 3.3 PARAMETERS OF TEST SOFTWARE

During testing channel & power controlling software provided by the customer was used to control the operating channel as well as the output power level.

Test Software Version	N/A		
Frequency (MHz)	2402	2441	2480
2Mbps	default	default	default

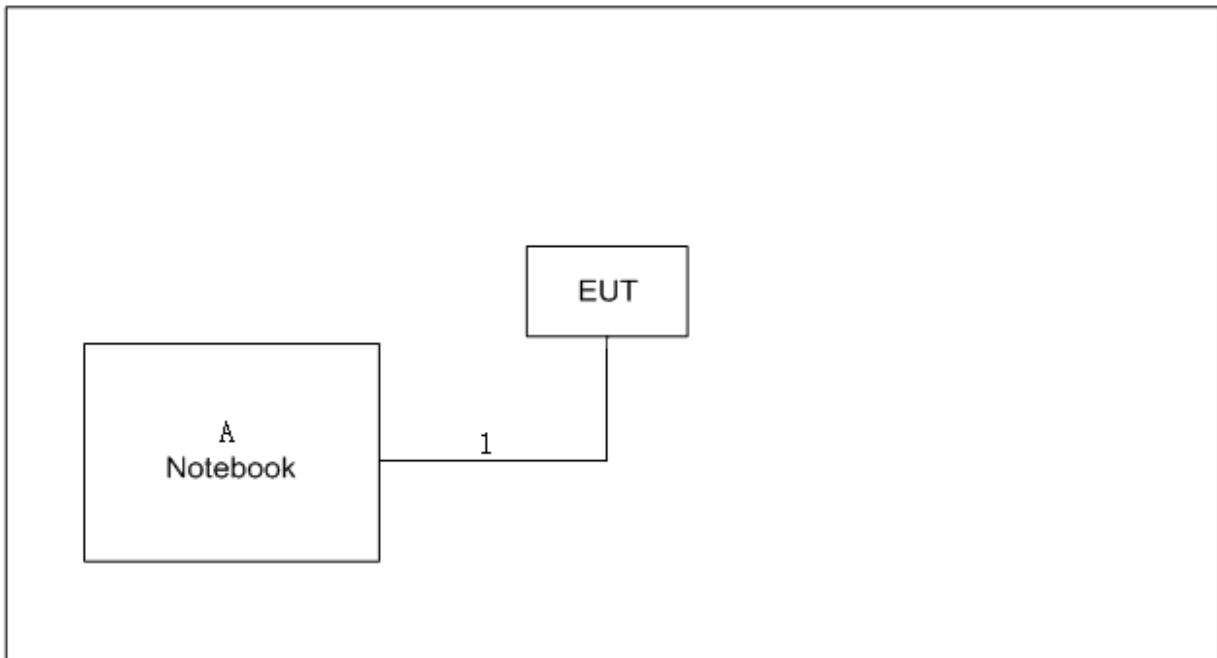
**3.4 BLOCK DIAGRAM SHOWING THE CONFIGURATION OF SYSTEM TESTED****For AC power line conducted emissions test****For others**

**3.5 SUPPORT UNITS****For AC power line conducted emissions test**

Item	Equipment	Brand	Model No.	Series No.
A	Notbook	Honor	14SER5 3500	N/A

Item	Cable Type	Shielded Type	Ferrite Core	Length
1	USB Cable	NO	NO	1.2m

**For others**

Item	Equipment	Brand	Model No.	Series No.
-	-	-	-	-

Item	Cable Type	Shielded Type	Ferrite Core	Length
-	-	-	-	-

**3.6 CUSTOMER INFORMATION DESCRIPTION**

- 1) The antenna gain is provided by the manufacturer.
- 2) Except for radiated spurious emissions, the results of all test items include cable losses. Part of the cable losses (1dB) are provided by the manufacturer, while the other parts of the cable losses are provided by the testing laboratory.

## 4. AC POWER LINE CONDUCTED EMISSIONS

### 4.1 LIMIT

Frequency of Emission (MHz)	Limit (dB $\mu$ V)	
	Quasi-peak	Average
0.15 - 0.5	66 to 56*	56 to 46*
0.5 - 5.0	56	46
5.0 - 30.0	60	50

Note:

- (1) The tighter limit applies at the band edges.
- (2) The limit of " \* " marked band means the limitation decreases linearly with the logarithm of the frequency in the range.

### 4.2 TEST PROCEDURE

- a. The EUT was placed 0.8 meters from the horizontal ground plane with EUT being connected to the power mains through a line impedance stabilization network (LISN). All other support equipment powered from additional LISN(s). The LISN provide 50 Ohm/ 50uH of coupling impedance for the measuring instrument.
- b. Interconnecting cables that hang closer than 40 cm to the ground plane shall be folded back and forth in the center forming a bundle 30 to 40 cm long.
- c. I/O cables that are not connected to a peripheral shall be bundled in the center. The end of the cable may be terminated, if required, using the correct terminating impedance. The overall length shall not exceed 1 m.
- d. LISN at least 80 cm from nearest part of EUT chassis.
- e. For the actual test configuration, please refer to the related Item –EUT Test Photos.

The following table is the setting of the receiver:

Receiver Parameters	Setting
Start Frequency	0.15 MHz
Stop Frequency	30 MHz
IF Bandwidth	9 kHz

### 4.3 DEVIATION FROM TEST STANDARD

No deviation.

#### 4.4 TEST SETUP

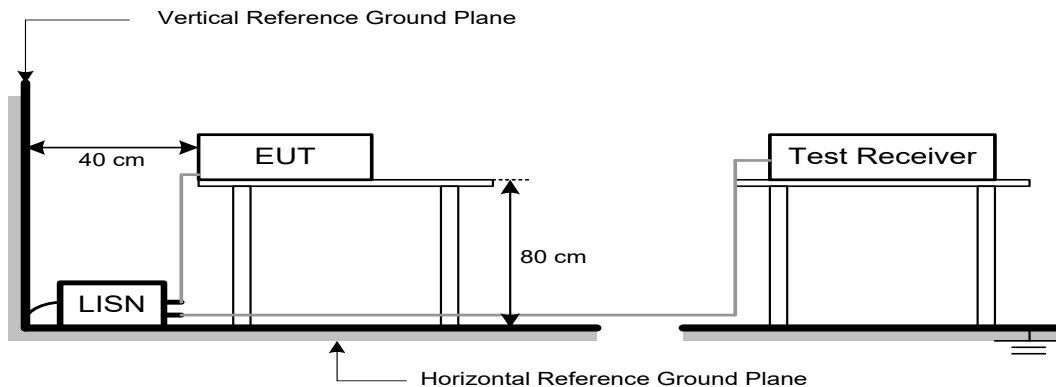

#### 4.5 EUT OPERATING CONDITIONS

The EUT was configured for testing in a typical fashion (as a customer would normally use it). The EUT has been programmed to continuously transmit during test. This operating condition was tested and used to collect the included data.

#### 4.6 TEST RESULTS

Please refer to the APPENDIX A.

Remark:

- (1) All readings are QP Mode value unless otherwise stated AVG in column of 『Note』 . If the QP Mode Measured value compliance with the QP Limits and lower than AVG Limits, the EUT shall be deemed to meet both QP & AVG Limits and then only QP Mode was measured, but AVG Mode didn't perform. In this case, a “ \* ” marked in AVG Mode column of Interference Voltage Measured.
- (2) Measuring frequency range from 150 kHz to 30 MHz.



## 5. RADIATED EMISSIONS

### 5.1 LIMIT

In case the emission fall within the restricted band specified on 15.205(a), then the 15.209(a) limit in the table below has to be followed.

#### LIMITS OF RADIATED EMISSION MEASUREMENT (9 kHz-1000 MHz)

Frequency (MHz)	Field Strength (microvolts/meter)	Measurement Distance (meters)
0.009-0.490	2400/F(kHz)	300
0.490-1.705	24000/F(kHz)	30
1.705-30.0	30	30
30-88	100	3
88-216	150	3
216-960	200	3
Above 960	500	3

#### LIMITS OF RADIATED EMISSION MEASUREMENT (Above 1000 MHz)

Frequency (MHz)	Band edge/ Harmonic at 3m (dB $\mu$ V/m)		Harmonic at 1m (dB $\mu$ V/m)	
	Peak	Average	Peak	Average
Above 1000	74	54	83.5 (Note 4)	63.5 (Note 4)

Note:

- (1) The limit for radiated test was performed according to FCC CFR Title 47, Part 15, Subpart C.
- (2) The tighter limit applies at the band edges.
- (3) Emission level (dB $\mu$ V/m)=20log Emission level (uV/m).
- (4)

$$FS_{\text{limit}} = FS_{\text{max}} - 20 \log \left( \frac{d_{\text{limit}}}{d_{\text{measure}}} \right)$$

$$20 \log (d_{\text{limit}}/d_{\text{measure}}) = 20 \log (3/1) = 9.5 \text{ dB.}$$

## 5.2 TEST PROCEDURE

- a. The measuring distance of 3 m shall be used for measurements. The EUT was placed on the top of a rotating table 0.8 meter above the ground at a 3 meter semi-anechoic chamber. The table was rotated 360 degrees to determine the position of the highest radiation.(below 1 GHz)
- b. The measuring distance of 3 m shall be used for measurements. The EUT was placed on the top of a rotating table 1.5 meter above the ground at a 3 meter semi-anechoic chamber. The table was rotated 360 degrees to determine the position of the highest radiation.(above 1 GHz)
- c. The height of the equipment or of the substitution antenna shall be 0.8m or 1.5m; the height of the test antenna shall vary between 1 m to 4 m. Both horizontal and vertical polarizations of the antenna are set to make the measurement.
- d. For each suspected emission, the EUT was arranged to its worst case and then the antenna was tuned to heights find the maximum reading (used Bore sight function).
- e. The receiver system was set to peak and average detect function and specified bandwidth with maximum hold mode when the test frequency is above 1 GHz.
- f. The initial step in collecting radiated emission data is a receiver peak detector mode pre-scanning the measurement frequency range. Significant peaks are then marked and then Quasi Peak detector mode re-measured.
- g. All readings are Peak unless otherwise stated QP in column of Note. Peak denotes that the Peak reading compliance with the QP Limits and then QP Mode measurement didn't perform.  
(below 1 GHz)
- h. All readings are Peak Mode value unless otherwise stated AVG in column of Note. If the Peak Mode Measured value compliance with the Peak Limits and lower than AVG Limits, the EUT shall be deemed to meet both Peak & AVG Limits and then only Peak Mode was measured, but AVG Mode didn't perform. (above 1 GHz)
- i. For the actual test configuration, please refer to the related Item –EUT Test Photos.

The following table is the setting of the receiver:

Spectrum Parameters	Setting
Start ~ Stop Frequency	9 kHz~150 kHz for RBW 200 Hz
Start ~ Stop Frequency	0.15 MHz~30 MHz for RBW 9 kHz
Start ~ Stop Frequency	30 MHz~1000 MHz for RBW 100 kHz

Spectrum Parameters	Setting
Start Frequency	1000 MHz
Stop Frequency	10th carrier harmonic
RBW / VBW (Emission in restricted band)	1 MHz / 3 MHz for PK value 1 MHz / 1/T Hz for AVG value

Spectrum Parameters	Setting
Start ~ Stop Frequency	9 kHz~90 kHz for PK/AVG detector
Start ~ Stop Frequency	90 kHz~110 kHz for QP detector
Start ~ Stop Frequency	110 kHz~490 kHz for PK/AVG detector
Start ~ Stop Frequency	490 kHz~30 MHz for QP detector
Start ~ Stop Frequency	30 MHz~1000 MHz for QP detector
Start ~ Stop Frequency	1 GHz~26.5 GHz for PK/AVG detector

**5.3 DEVIATION FROM TEST STANDARD**

No deviation.

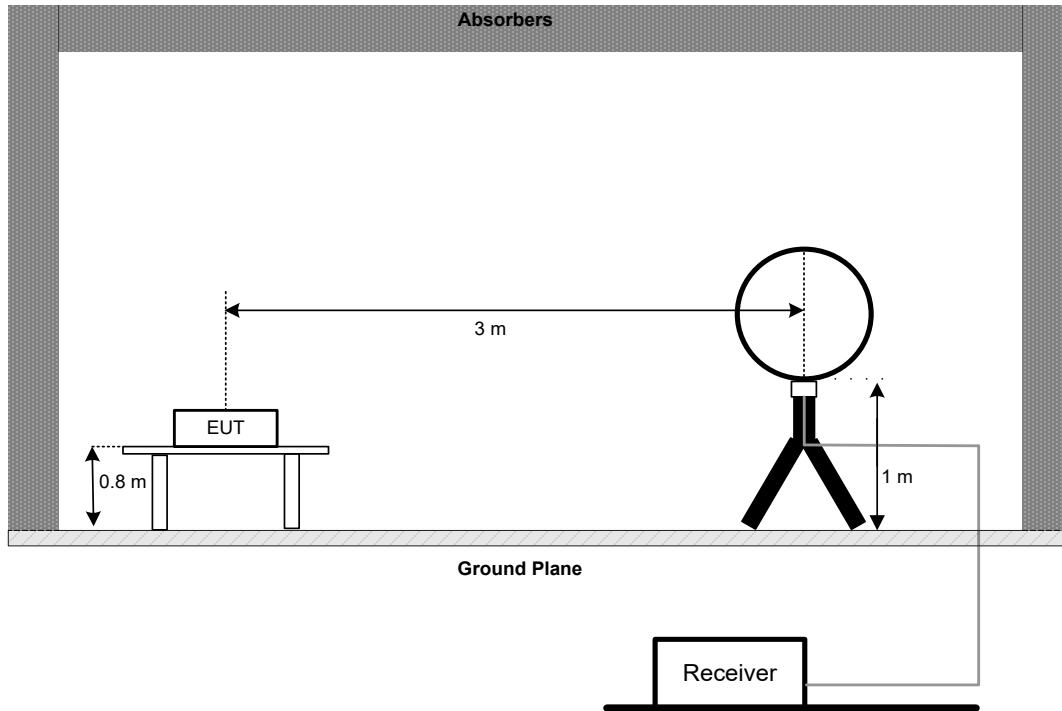
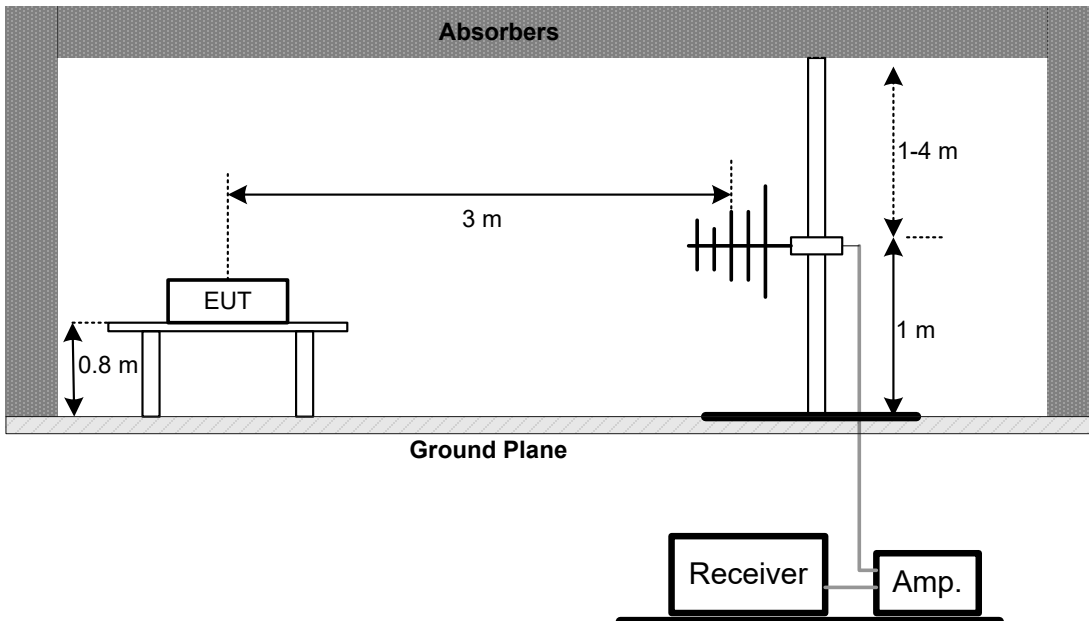
**5.4 TEST SETUP****9 kHz to 30 MHz****30 MHz to 1 GHz**

**Above 1 GHz**  
Band edge & Harmonic(1 GHz to 18 GHz)

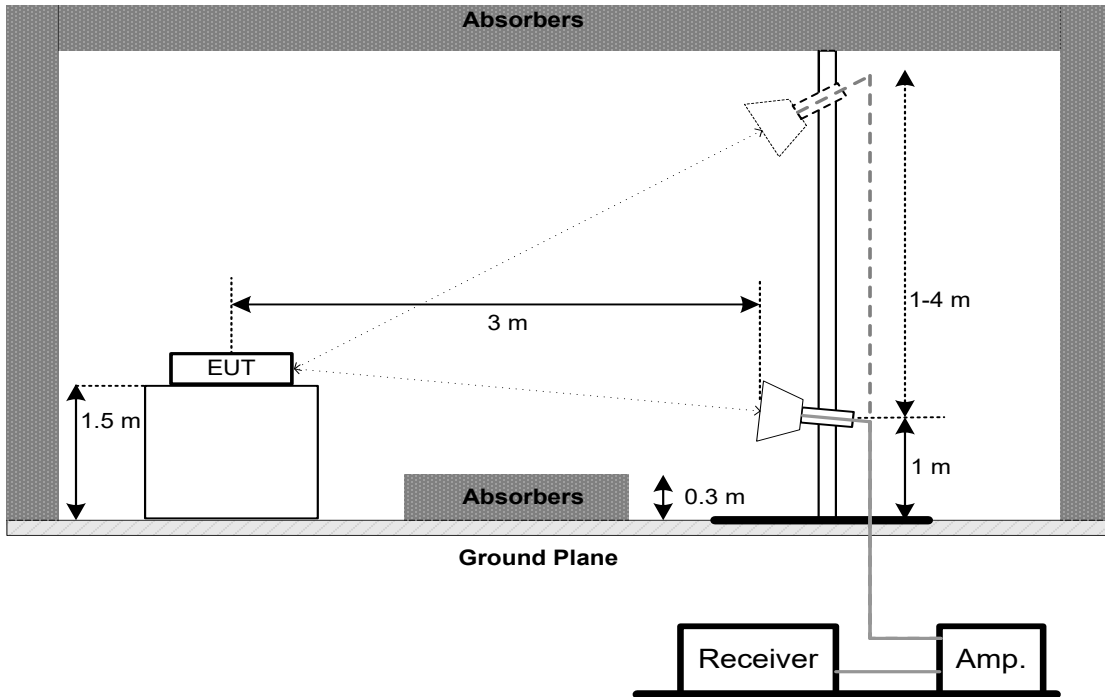

Harmonic(18 GHz to 26.5 GHz)

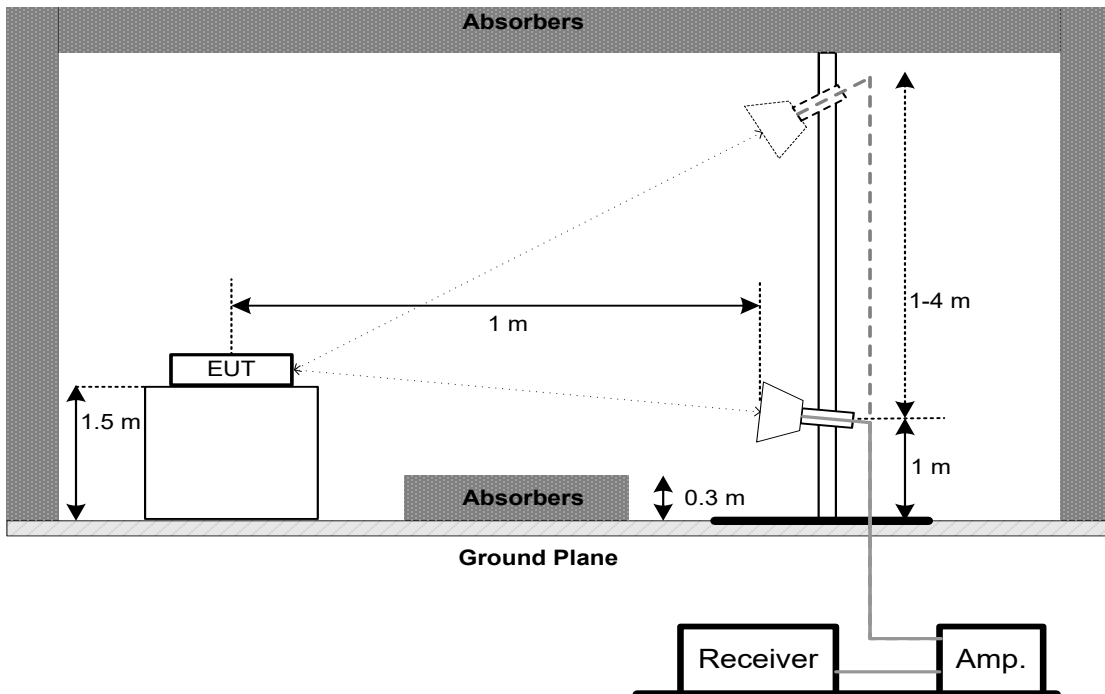

**5.5 EUT OPERATING CONDITIONS**

The EUT was programmed to be in continuously transmitting mode.

**5.6 TEST RESULT - 9 kHz TO 30 MHz**

Please refer to the APPENDIX B.

Remark:

- (1) Distance extrapolation factor =  $40 \log(\text{specific distance} / \text{test distance})$  (dB).
- (2) Limit line = specific limits (dBuV) + distance extrapolation factor.

**5.7 TEST RESULT - 30 MHz TO 1000 MHz**

Please refer to the APPENDIX C.

**5.8 TEST RESULT - ABOVE 1000 MHz**

Please refer to the APPENDIX D.

Remark:

- (1) No limit: This is fundamental signal, the judgment is not applicable.  
For fundamental signal judgment was referred to Peak output test.

## 6. BANDWIDTH

### 6.1 LIMIT

Section	Test Item	Limit
FCC 15.247(a)(2)	6 dB Bandwidth	$\geq 500$ kHz
	99% Emission Bandwidth	-

### 6.2 TEST PROCEDURE

- The EUT was directly connected to the spectrum analyzer and antenna output port as show in the block diagram below.
- The following table is the setting of the spectrum analyzer:

For 6 dB Bandwidth:

Spectrum Parameters	Setting
Span Frequency	$>$ Measurement Bandwidth
RBW	100 kHz
VBW	300 kHz
Detector	Peak
Trace	Max Hold
Sweep Time	Auto

For 99% Emission Bandwidth:

Spectrum Parameters	Setting
Span Frequency	Between 1.5 times and 5.0 times the OBW
RBW	30 kHz
VBW	100 kHz
Detector	Peak
Trace	Max Hold
Sweep Time	Auto

### 6.3 DEVIATION FROM STANDARD

No deviation.

### 6.4 TEST SETUP

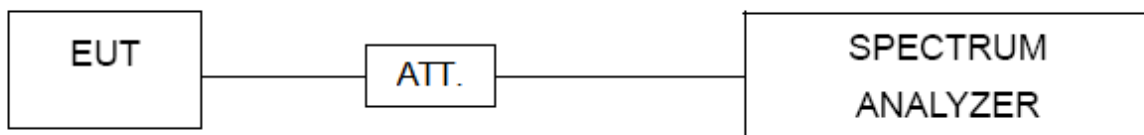

### 6.5 EUT OPERATION CONDITIONS

The EUT was programmed to be in continuously transmitting mode.

### 6.6 TEST RESULTS

Please refer to the APPENDIX E.

## 7. MAXIMUM OUTPUT POWER

### 7.1 LIMIT

Section	Test Item	Limit
FCC 15.247(b)(3)	Maximum Output Power	1.0000 watt or 30.00 dBm

### 7.2 TEST PROCEDURE

- The EUT was directly connected to the spectrum analyzer and antenna output port as show in the block diagram below.
- The following table is the setting of the spectrum analyzer:

Spectrum Parameters	Setting
Span Frequency	$\geq 3 \times \text{RBW}$
RBW	3 MHz
VBW	3 MHz
Detector	Peak
Trace	Max Hold
Sweep Time	Auto

### 7.3 DEVIATION FROM STANDARD

No deviation.

### 7.4 TEST SETUP



### 7.5 EUT OPERATION CONDITIONS

The EUT was programmed to be in continuously transmitting mode.

### 7.6 TEST RESULTS

Please refer to the APPENDIX F.

## 8. CONDUCTED SPURIOUS EMISSION

### 8.1 LIMIT

In any 100 kHz bandwidth outside the frequency band in which the spread spectrum or digitally modulated intentional radiator is operating, the radio frequency power that is produced by the intentional radiator shall be at least 20 dB below that in the 100 kHz bandwidth within the band that contains the highest level of the desired power, based on either an RF conducted or a radiated measurement, provided the transmitter demonstrates compliance with the peak Output Power limits. If the transmitter complies with the Output Power limits based on the use of RMS averaging over a time interval, as permitted under paragraph (b)(3) of this section, the attenuation required under this paragraph shall be 30 dB instead of 20 dB. Attenuation below the general limits specified in Section 15.209(a) is not required.

### 8.2 TEST PROCEDURE

- The EUT was directly connected to the spectrum analyzer and antenna output port as show in the block diagram below.
- The following table is the setting of the spectrum analyzer:

Spectrum Parameters	Setting
Start Frequency	30 MHz
Stop Frequency	26.5 GHz
RBW	100 kHz
VBW	300 kHz
Detector	Peak
Trace	Max Hold
Sweep Time	Auto

### 8.3 DEVIATION FROM STANDARD

No deviation.

### 8.4 TEST SETUP

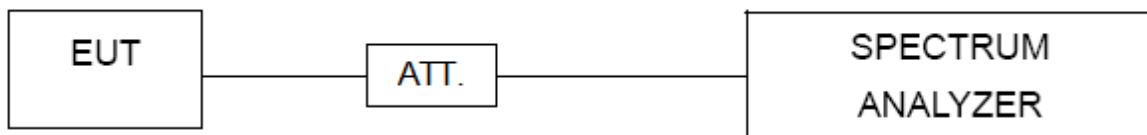

### 8.5 EUT OPERATION CONDITIONS

The EUT was programmed to be in continuously transmitting mode.

### 8.6 TEST RESULTS

Please refer to the APPENDIX G.



## 9. POWER SPECTRAL DENSITY

### 9.1 LIMIT

Section	Test Item	Limit
FCC 15.247(e)	Power Spectral Density	8 dBm (in any 3 kHz)

### 9.2 TEST PROCEDURE

- a. The EUT was directly connected to the spectrum analyzer and antenna output port as show in the block diagram below.
- b. The following table is the setting of the spectrum analyzer:

Spectrum Parameters	Setting
Span Frequency	2 MHz (1 Mbps) / 4 MHz (2 Mbps)
RBW	3 kHz
VBW	10 kHz
Detector	Peak
Trace	Max Hold
Sweep Time	Auto

### 9.3 DEVIATION FROM STANDARD

No deviation.

### 9.4 TEST SETUP

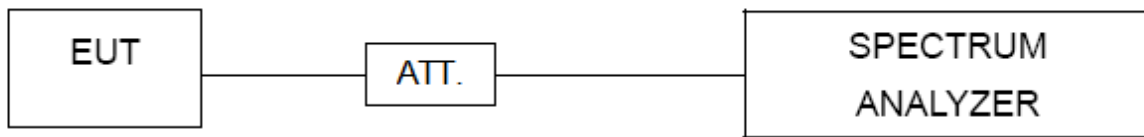

### 9.5 EUT OPERATION CONDITIONS

The EUT was programmed to be in continuously transmitting mode.

### 9.6 TEST RESULTS

Please refer to the APPENDIX H.

**10. MEASUREMENT INSTRUMENTS LIST**

AC Power Line Conducted Emissions					
Item	Kind of Equipment	Manufacturer	Type No.	Serial No.	Calibrated until
1	EMI Test Receiver	R&S	ESR3	103027	Jun. 16, 2024
2	TWO-LINE V-NETWORK	R&S	ENV216	101447	Dec. 22, 2024
3	Measurement Software	Farad	EZ-EMC Ver.NB-03A1-01	N/A	N/A
4	Cable	N/A	SFT205-NMNM-9M-001	9M	Nov. 27, 2024
5	643 Shield Room	ETS	6*4*3	N/A	N/A

Radiated Emissions - 9 kHz to 30 MHz					
Item	Kind of Equipment	Manufacturer	Type No.	Serial No.	Calibrated until
1	Active Loop Antenna	Schwarzbeck	FMZB 1513-60B	1513-60 B-034	Mar. 30, 2025
2	MXE EMI Receiver	Keysight	N9038A	MY56400091	Dec. 22, 2024
3	Cable	N/A	RW2350-3.8A-NMB M-1.5M	N/A	Jun. 10, 2024
4	Measurement Software	Farad	EZ-EMC Ver.NB-03A1-01	N/A	N/A
5	966 Chamber room	ETS	9*6*6	N/A	Jul. 11, 2024

Radiated Emissions - 30 MHz to 1 GHz					
Item	Kind of Equipment	Manufacturer	Type No.	Serial No.	Calibrated until
1	Trilog-Broadband Antenna	Schwarzbeck	VULB 9168	1462	Dec. 13, 2024
2	Attenuator	EMC INSTRUMENT	EMCI-N-6-06	AT-06009	Dec. 13, 2024
3	Preamplifier	EMC INSTRUMENT	EMC001330	980863	Apr. 07, 2025
4	Cable	RegalWay	LMR400-NMNM-12.5m	N/A	Jul. 04, 2024
5	Cable	RegalWay	LMR400-NMNM-3m	N/A	Jul. 04, 2024
6	Cable	RegalWay	LMR400-NMNM-0.5m	N/A	Jul. 04, 2024
7	Receiver	Agilent	N9038A	MY52130039	Dec. 22, 2024
8	Positioning Controller	MF	MF-7802	N/A	N/A
9	Measurement Software	Farad	EZ-EMC Ver.NB-03A1-01	N/A	N/A
10	966 Chamber room	CM	9*6*6	N/A	May 16, 2025

Radiated Emissions - Above 1 GHz					
Item	Kind of Equipment	Manufacturer	Type No.	Serial No.	Calibrated until
1	EXA Spectrum Analyzer	Keysight	N9010A	MY55150209	Jun. 16, 2024
2	Low Noise Amplifier	CONNPHY	CLN-18G40G-4330-K	619413	Jul. 06, 2024
3	Cable	RegalWay	RWLP50-2.6A-2.92M 2.92M-1.1M	N/A	Jul. 26, 2024
4	Cable	Tonscend	HF160-KMKM-3M	N/A	Jul. 26, 2024
5	Broad-Band Horn Antenna	Schwarzbeck	BBHA9170	1227	Oct. 10, 2024
6	966 Chamber room	CM	9*6*6	N/A	May 19, 2025
7	Positioning Controller	MF	MF-7802	N/A	N/A
8	Measurement Software	Farad	EZ-EMC Ver.NB-03A1-01	N/A	N/A

<b>Bandwidth &amp; Maximum Output Power &amp; Power Spectral Density &amp; Conducted Spurious Emission</b>					
Item	Kind of Equipment	Manufacturer	Type No.	Serial No.	Calibrated until
1	Attenuator	Talent Microwave	TA10A0-S-26.5	N/A	N/A
2	DC Block	N/A	N/A	N/A	N/A
3	Spectrum Analyzer	R&S	FSP38	100852	Jun. 16, 2024
4	Measurement Software	BTL	BTL Conducted Test	N/A	N/A

Remark: "N/A" denotes no model name, serial no. or calibration specified.  
All calibration period of equipment list is one year.

## **APPENDIX A - AC POWER LINE CONDUCTED EMISSIONS**

Test Mode	TX Mode_2Mbps Channel 78	Phase	Line
-----------	--------------------------	-------	------

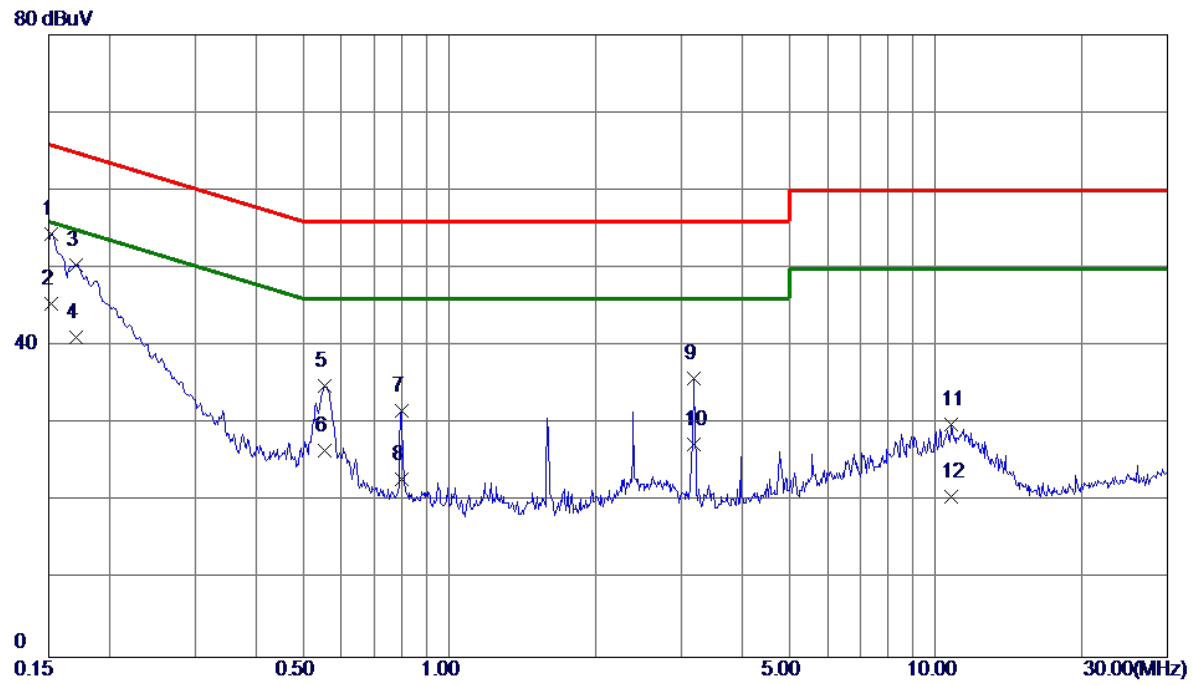

No.	Freq. MHz	Reading Level dBuV	Correct Factor dB	Measurement dBuV	Limit dBuV	Margin dB	Detector	Comment
1	0.1522	44.46	9.97	54.43	65.88	-11.45	QP	
2 *	0.1522	35.50	9.97	45.47	55.88	-10.41	AVG	
3	0.1703	40.38	9.97	50.35	64.95	-14.60	QP	
4	0.1703	31.20	9.97	41.17	54.95	-13.78	AVG	
5	0.5550	24.10	10.74	34.84	56.00	-21.16	QP	
6	0.5550	15.80	10.74	26.54	46.00	-19.46	AVG	
7	0.7980	20.54	11.11	31.65	56.00	-24.35	QP	
8	0.7980	11.70	11.11	22.81	46.00	-23.19	AVG	
9	3.1829	25.44	10.45	35.89	56.00	-20.11	QP	
10	3.1829	16.90	10.45	27.35	46.00	-18.65	AVG	
11	10.7970	17.68	12.24	29.92	60.00	-30.08	QP	
12	10.7970	8.40	12.24	20.64	50.00	-29.36	AVG	

REMARKS:  
 (1) Measurement Value = Reading Level + Correct Factor.  
 (2) Margin Level = Measurement Value - Limit Value.

Test Mode	TX Mode_2Mbps Channel 78	Phase	Neutral
-----------	--------------------------	-------	---------

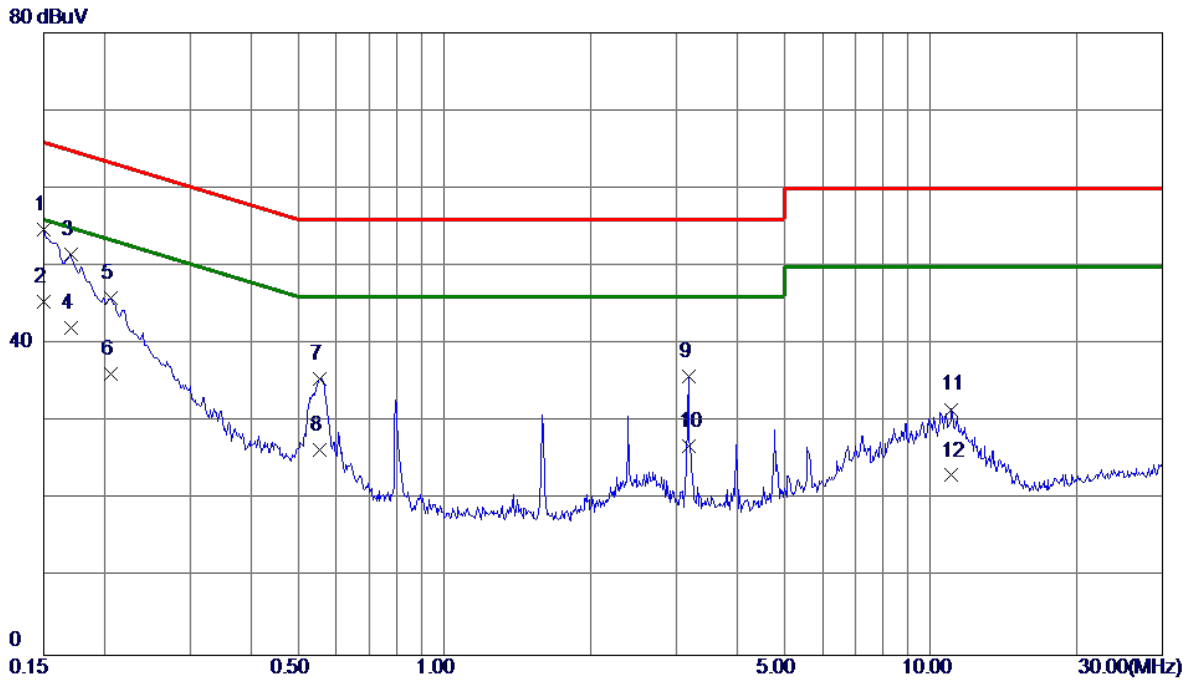

No.	Freq. MHz	Reading Level dBuV	Correct Factor dB	Measure ment dBuV	Limit dBuV	Margin dB	Detector	Comment
1	0.1500	44.78	9.93	54.71	66.00	-11.29	QP	
2 *	0.1500	35.50	9.93	45.43	56.00	-10.57	AVG	
3	0.1703	41.55	9.93	51.48	64.95	-13.47	QP	
4	0.1703	32.10	9.93	42.03	54.95	-12.92	AVG	
5	0.2063	35.89	9.95	45.84	63.35	-17.51	QP	
6	0.2063	26.20	9.95	36.15	53.35	-17.20	AVG	
7	0.5550	24.85	10.70	35.55	56.00	-20.45	QP	
8	0.5550	15.70	10.70	26.40	46.00	-19.60	AVG	
9	3.1829	25.83	10.07	35.90	56.00	-20.10	QP	
10	3.1829	16.80	10.07	26.87	46.00	-19.13	AVG	
11	11.0378	19.38	12.22	31.60	60.00	-28.40	QP	
12	11.0378	10.90	12.22	23.12	50.00	-26.88	AVG	

**REMARKS:**

- (1) Measurement Value = Reading Level + Correct Factor.
- (2) Margin Level = Measurement Value - Limit Value.

## **APPENDIX B - RADIATED EMISSION - 9 KHZ TO 30 MHZ**

Test Mode	TX Mode_2Mbps Channel 78	Polarization	Ant 0°
-----------	--------------------------	--------------	--------

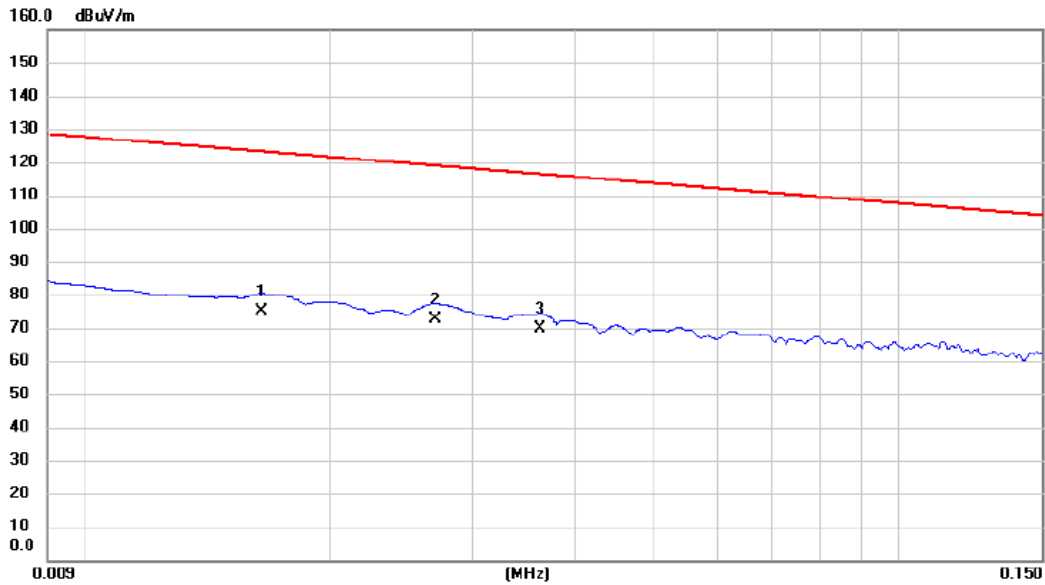

No.	Mk.	Freq. MHz	Reading Level dBuV	Correct Factor dB	Measure- ment dBuV/m	Limit dBuV/m	Margin dB	Detector	Comment
1		0.0165	54.13	20.70	74.83	123.26	-48.43	AVG	
2	*	0.0270	51.77	21.01	72.78	118.98	-46.20	AVG	
3		0.0362	48.63	21.13	69.76	116.43	-46.67	AVG	

**REMARKS:**

(1) Measurement Value = Reading Level + Correct Factor.

(2) Margin Level = Measurement Value - Limit Value.



Test Mode	TX Mode_2Mbps Channel 78	Polarization	Ant 0°
-----------	--------------------------	--------------	--------

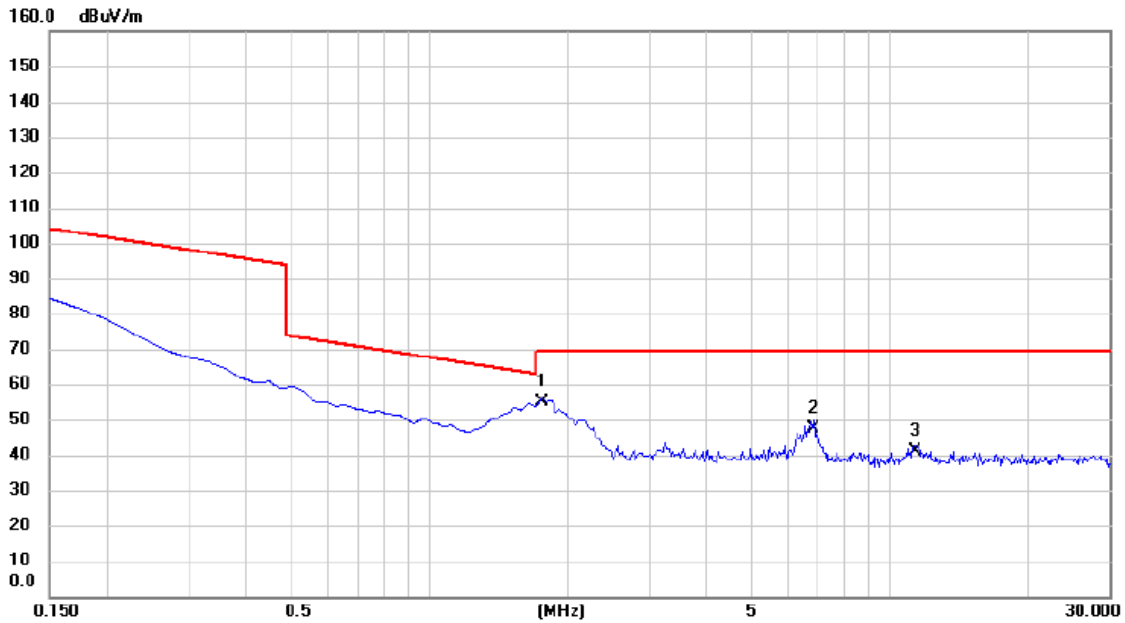

No.	Mk.	Freq. MHz	Reading Level dBuV	Correct Factor dB	Measure- ment dBuV/m	Limit dBuV/m	Margin dB	Detector	Comment
1	*	1.7620	33.71	21.11	54.82	69.54	-14.72	QP	
2		6.8065	26.14	21.17	47.31	69.54	-22.23	QP	
3		11.3736	19.78	21.15	40.93	69.54	-28.61	QP	

**REMARKS:**

- (1) Measurement Value = Reading Level + Correct Factor.
- (2) Margin Level = Measurement Value - Limit Value.

Test Mode	TX Mode_2Mbps Channel 78	Polarization	Ant 90°
-----------	--------------------------	--------------	---------

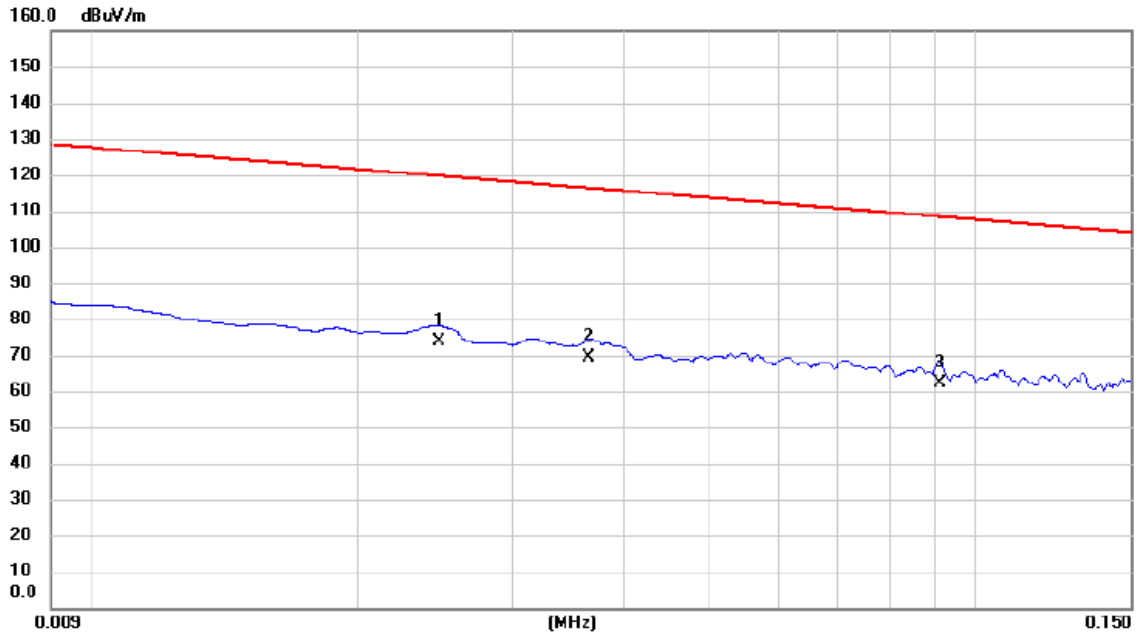

No.	Mk.	Freq. MHz	Reading Level dBuV	Correct Factor dB	Measure- ment dBuV/m	Limit dBuV/m	Margin dB	Detector	Comment
1	*	0.0247	52.69	20.94	73.63	119.75	-46.12	AVG	
2		0.0366	48.41	21.13	69.54	116.34	-46.80	AVG	
3		0.0911	40.95	21.33	62.28	108.41	-46.13	QP	

**REMARKS:**

- (1) Measurement Value = Reading Level + Correct Factor.
- (2) Margin Level = Measurement Value - Limit Value.

Test Mode	TX Mode_2Mbps Channel 78	Polarization	Ant 90°
-----------	--------------------------	--------------	---------

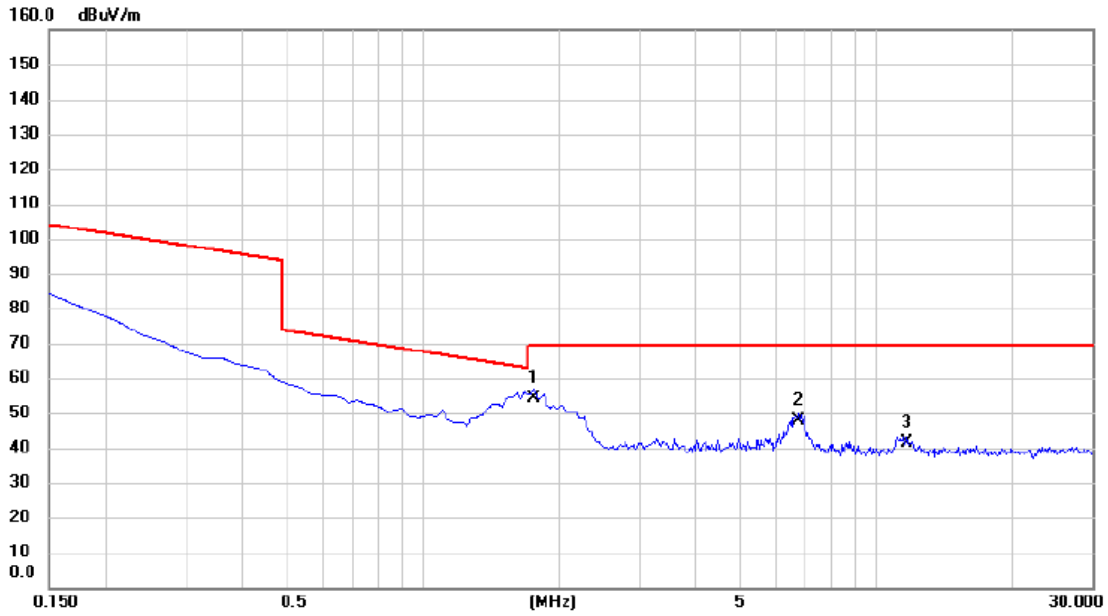

No.	Mk.	Freq. MHz	Reading Level dBuV	Correct Factor dB	Measure- ment dBuV/m	Limit dBuV/m	Margin dB	Detector	Comment
1	*	1.7620	33.02	21.11	54.13	69.54	-15.41	QP	
2		6.7470	26.46	21.17	47.63	69.54	-21.91	QP	
3		11.6423	20.13	21.15	41.28	69.54	-28.26	QP	

**REMARKS:**

- (1) Measurement Value = Reading Level + Correct Factor.
- (2) Margin Level = Measurement Value - Limit Value.

**APPENDIX C - RADIATED EMISSION - 30 MHZ TO 1000 MHZ**

Test Mode	TX Mode_2Mbps Channel 78	Polarization	Vertical
-----------	--------------------------	--------------	----------

80 dBuV/m

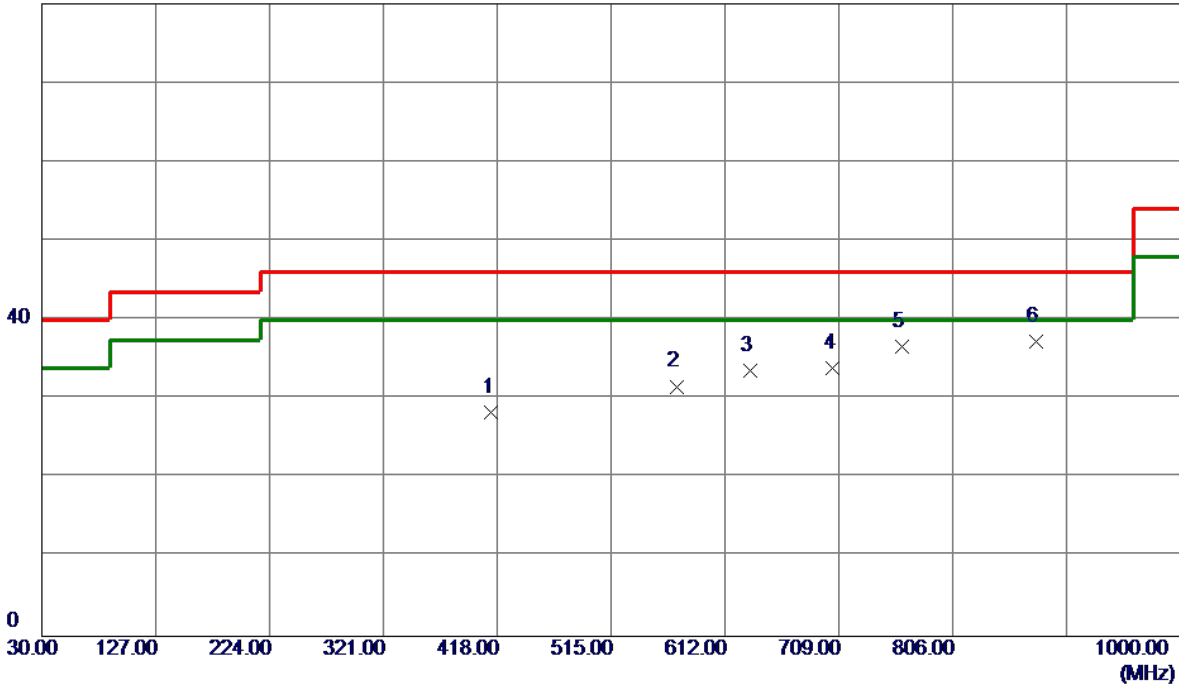

No.	Freq. MHz	Reading Level dBuV/m	Correct Factor dB	Measure ment dBuV/m	Limit dBuV/m	Margin dB	Detector	Comment
1	413.1500	35.96	-7.64	28.32	46.00	-17.68	Peak	
2	570.7750	35.98	-4.38	31.60	46.00	-14.40	Peak	
3	633.3400	36.66	-3.08	33.58	46.00	-12.42	Peak	
4	704.1500	36.09	-2.23	33.86	46.00	-12.14	Peak	
5	763.3200	37.87	-1.17	36.70	46.00	-9.30	Peak	
6 *	877.2950	37.43	-0.11	37.32	46.00	-8.68	Peak	

**REMARKS:**

- (1) Measurement Value = Reading Level + Correct Factor.
- (2) Margin Level = Measurement Value - Limit Value.

Test Mode	TX Mode_2Mbps Channel 78	Polarization	Horizontal
-----------	--------------------------	--------------	------------

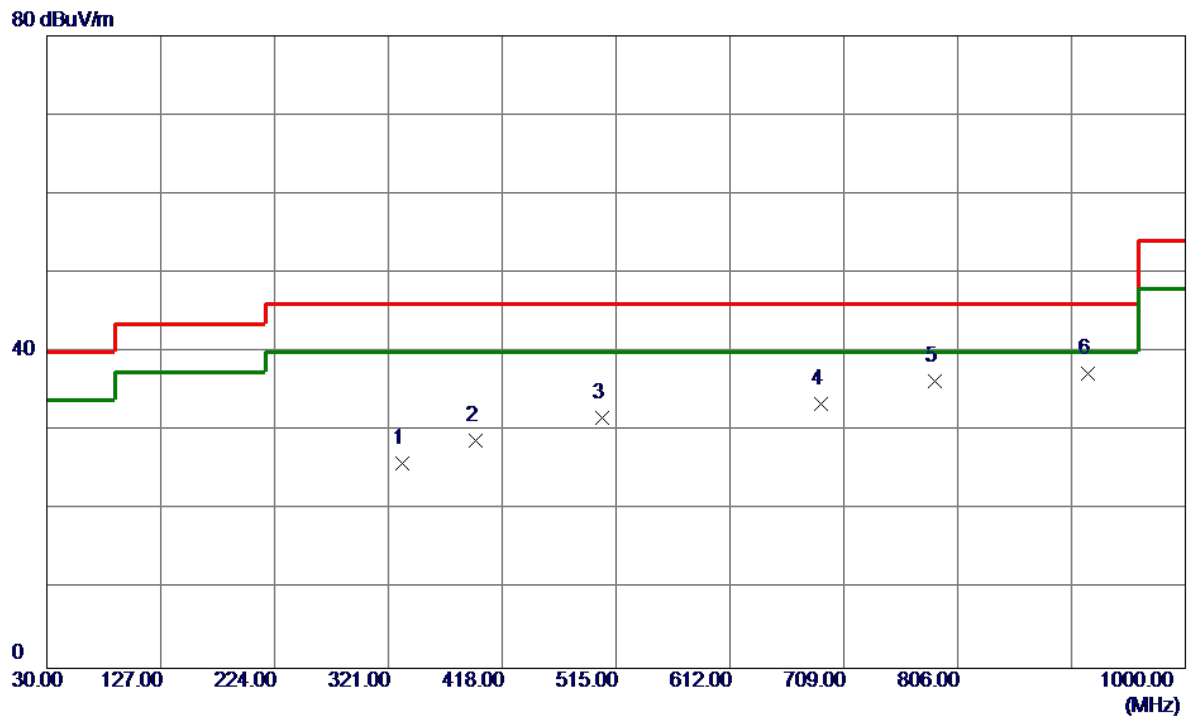

No.	Freq. MHz	Reading Level dBuV/m	Correct Factor dB	Measure ment dBuV/m	Limit dBuV/m	Margin dB	Detector	Comment
1	332.6400	35.45	-9.58	25.87	46.00	-20.13	Peak	
2	395.6900	36.84	-8.07	28.77	46.00	-17.23	Peak	
3	503.3600	37.58	-5.86	31.72	46.00	-14.28	Peak	
4	690.0850	35.83	-2.43	33.40	46.00	-12.60	Peak	
5	786.1150	37.63	-1.26	36.37	46.00	-9.63	Peak	
6 *	916.5800	37.07	0.27	37.34	46.00	-8.66	Peak	

REMARKS:  
 (1) Measurement Value = Reading Level + Correct Factor.  
 (2) Margin Level = Measurement Value - Limit Value.

## **APPENDIX D - RADIATED EMISSION - ABOVE 1000 MHZ**

Test Mode	TX 2402 MHz _CH00_2Mbps	Polarization	Vertical
-----------	-------------------------	--------------	----------

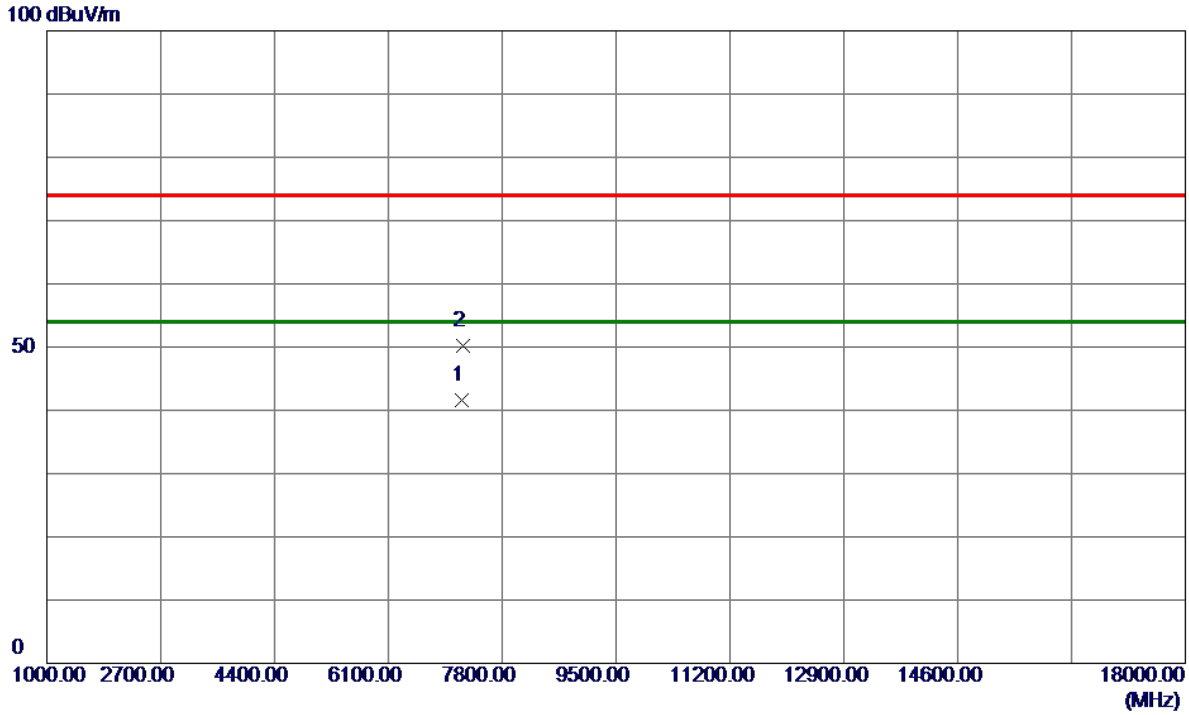

No.	Freq. MHz	Reading Level dBuV/m	Correct Factor dB	Measure ment dBuV/m	Limit dBuV/m	Margin dB	Detector	Comment
1 *	7204.7600	35.83	5.81	41.64	54.00	-12.36	AVG	
2	7207.4300	44.43	5.81	50.24	74.00	-23.76	Peak	

**REMARKS:**

- (1) Measurement Value = Reading Level + Correct Factor.
- (2) Margin Level = Measurement Value - Limit Value.



Test Mode	TX 2402 MHz _CH00_2Mbps	Polarization	Horizontal
-----------	-------------------------	--------------	------------

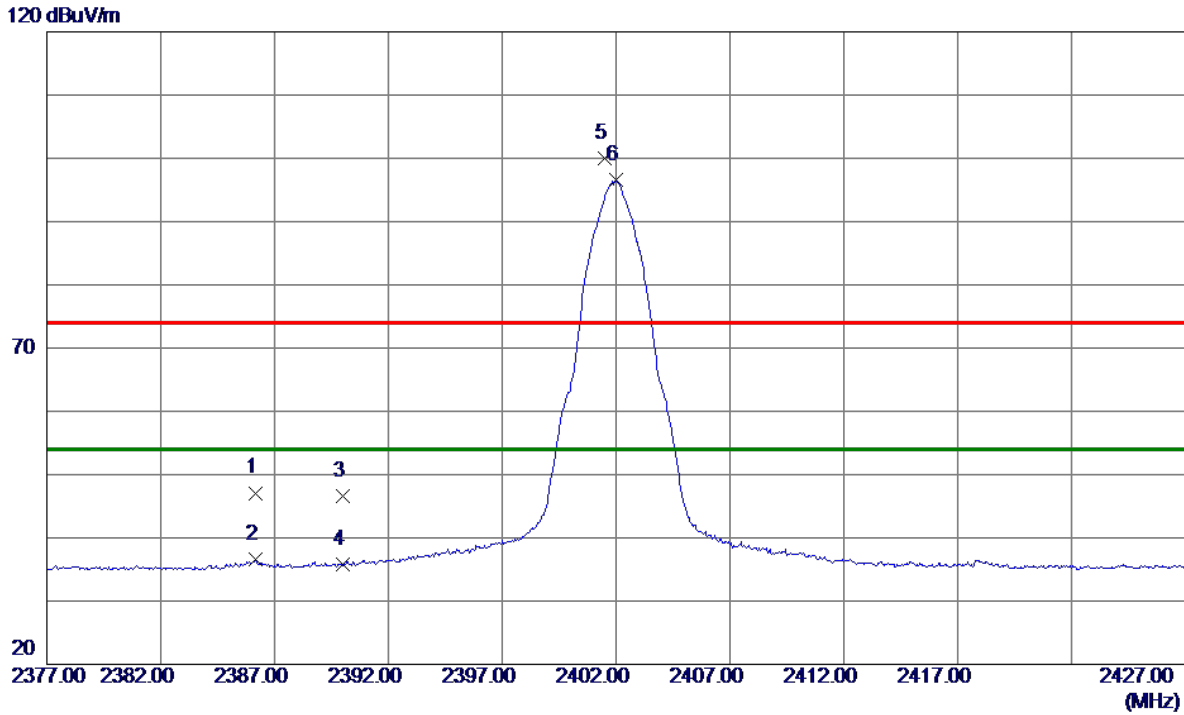

No.	Freq. MHz	Reading Level dBuV/m	Correct Factor dB	Measure ment dBuV/m	Limit dBuV/m	Margin dB	Detector	Comment
1	2386.1500	41.59	5.51	47.10	74.00	-26.90	Peak	
2	2386.1750	31.04	5.51	36.55	54.00	-17.45	AVG	
3	2390.0000	41.07	5.51	46.58	74.00	-27.42	Peak	
4	2390.0000	30.35	5.51	35.86	54.00	-18.14	AVG	
5	2401.5000	94.52	5.51	100.03	74.00	26.03	Peak	No Limit
6 *	2401.9750	91.05	5.51	96.56	54.00	42.56	AVG	No Limit

REMARKS:  
 (1) Measurement Value = Reading Level + Correct Factor.  
 (2) Margin Level = Measurement Value - Limit Value.

Test Mode	TX 2441 MHz _CH39_2Mbps	Polarization	Vertical
-----------	-------------------------	--------------	----------

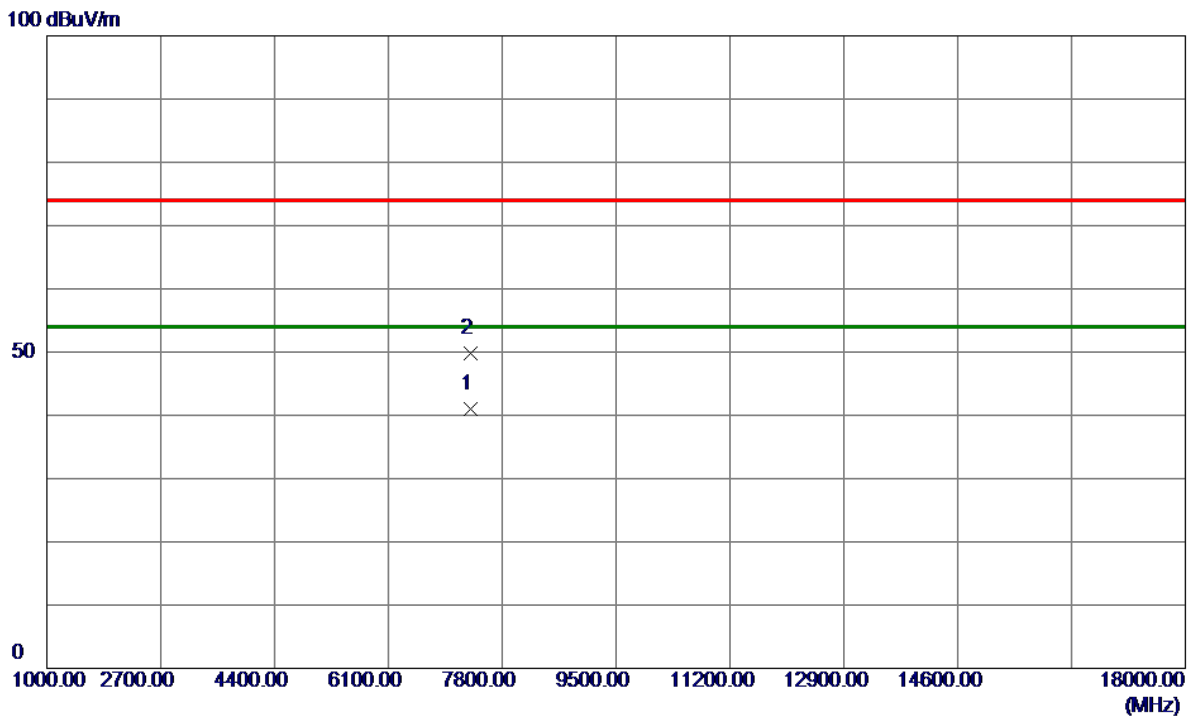

No.	Freq. MHz	Reading Level dBuV/m	Correct Factor dB	Measure ment dBuV/m	Limit dBuV/m	Margin dB	Detector	Comment
1 *	7324.1550	35.07	6.01	41.08	54.00	-12.92	AVG	
2	7324.3650	43.79	6.01	49.80	74.00	-24.20	Peak	

REMARKS:  
 (1) Measurement Value = Reading Level + Correct Factor.  
 (2) Margin Level = Measurement Value - Limit Value.

Test Mode	TX 2480 MHz _CH78_2Mbps	Polarization	Vertical
-----------	-------------------------	--------------	----------

100 dBuV/m

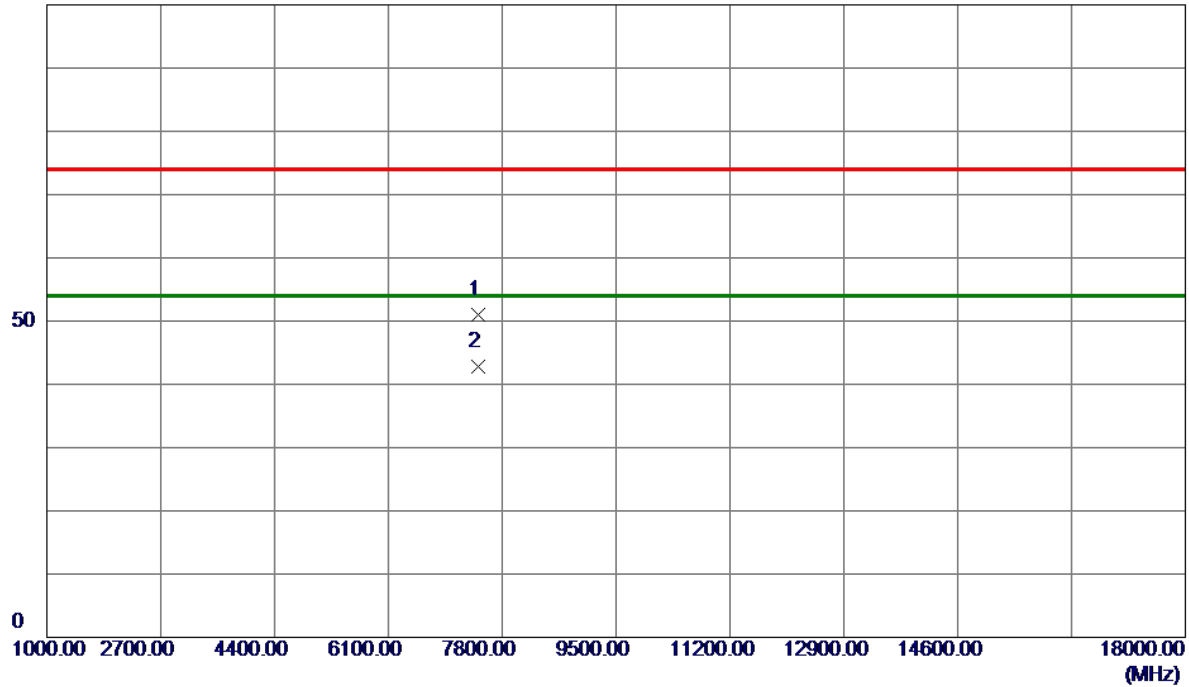

No.	Freq. MHz	Reading Level dBuV/m	Correct Factor dB	Measure ment dBuV/m	Limit dBuV/m	Margin dB	Detector	Comment
1	7440.0500	44.81	6.22	51.03	74.00	-22.97	Peak	
2 *	7441.1750	36.59	6.22	42.81	54.00	-11.19	AVG	

REMARKS:

- (1) Measurement Value = Reading Level + Correct Factor.
- (2) Margin Level = Measurement Value - Limit Value.

Test Mode	TX 2480 MHz _CH78_2Mbps	Polarization	Horizontal
-----------	-------------------------	--------------	------------

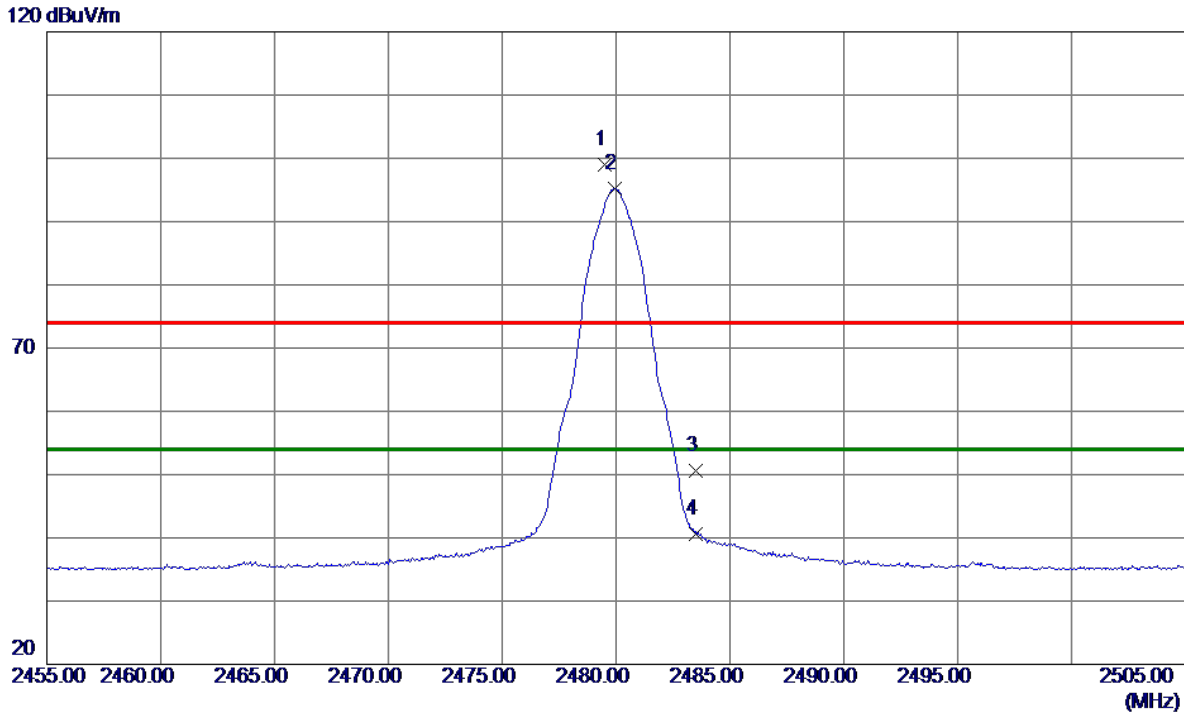

No.	Freq. MHz	Reading Level dBuV/m	Correct Factor dB	Measure ment dBuV/m	Limit dBuV/m	Margin dB	Detector	Comment
1	2479.5000	93.43	5.49	98.92	74.00	24.92	Peak	No Limit
2 *	2479.9250	89.75	5.49	95.24	54.00	41.24	AVG	No Limit
3	2483.5000	45.15	5.48	50.63	74.00	-23.37	Peak	
4	2483.5000	35.21	5.48	40.69	54.00	-13.31	AVG	

**REMARKS:**

- (1) Measurement Value = Reading Level + Correct Factor.
- (2) Margin Level = Measurement Value - Limit Value.

## APPENDIX E - BANDWIDTH

Test Mode	TX Mode_2Mbps
-----------	---------------

Channel	Frequency (MHz)	6 dB Bandwidth (MHz)	99 % Occupied Bandwidth (MHz)	6 dB Bandwidth Min. Limit (MHz)	Test Result
00	2402	1.084	2.032	0.5	Pass
39	2441	1.074	2.056	0.5	Pass
78	2480	1.138	2.064	0.5	Pass

**CH00**

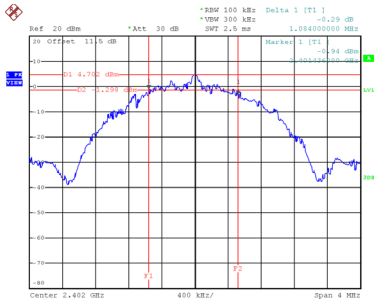

Date: 25.MAY.2024 10:44:50

**CH39**

**6 dB Bandwidth**

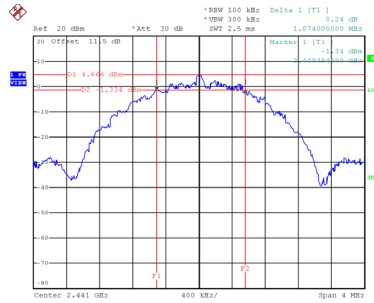

Date: 25.MAY.2024 10:47:10

**CH78**

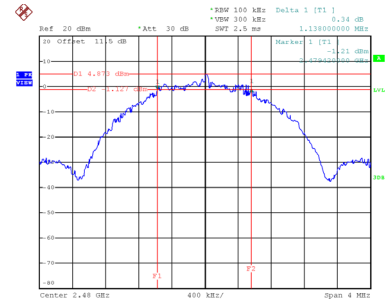

Date: 25.MAY.2024 10:50:55

**99 % Occupied Bandwidth**

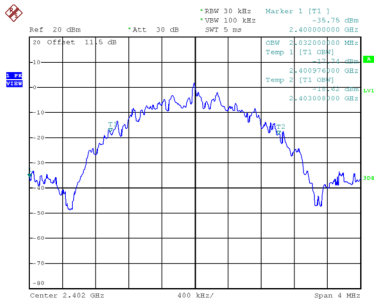

Date: 25.MAY.2024 10:44:20

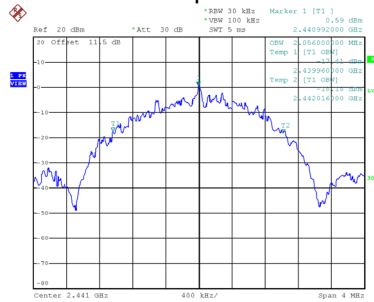

Date: 25.MAY.2024 10:47:16

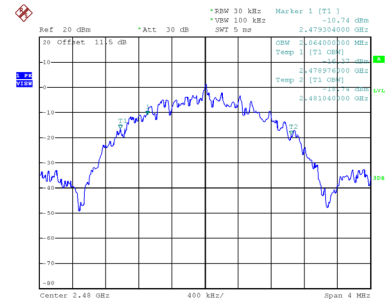

Date: 25.MAY.2024 10:51:01

## **APPENDIX F - MAXIMUM OUTPUT POWER**

Test Mode	TX Mode_2Mbps
-----------	---------------

Frequency (MHz)	Output Power (dBm)	Output Power (W)	Max. Limit (dBm)	Max. Limit (W)	Test Result
2402	4.67	0.0029	30.00	1.0000	Pass
2441	4.60	0.0029	30.00	1.0000	Pass
2480	4.78	0.0030	30.00	1.0000	Pass

Note: Output power = Measure result + Cable loss

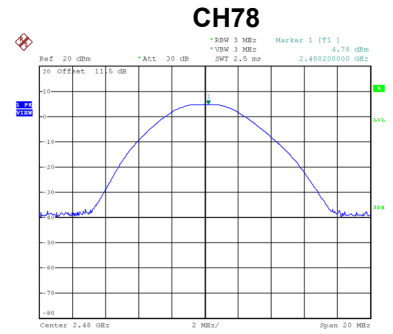
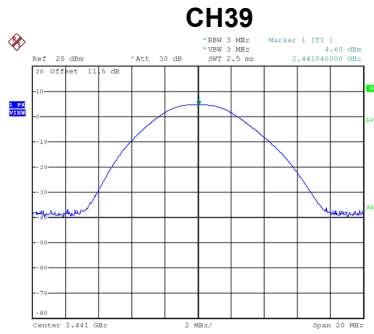
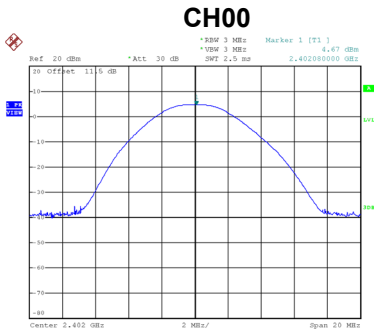



## **APPENDIX G - CONDUCTED SPURIOUS EMISSION**

Test Mode TX Mode\_2Mbps

### Bandedge CH00 (Lower)

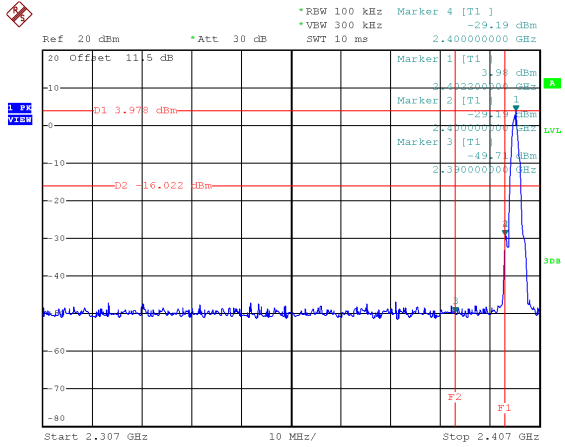

### Bandedge CH78 (Upper)

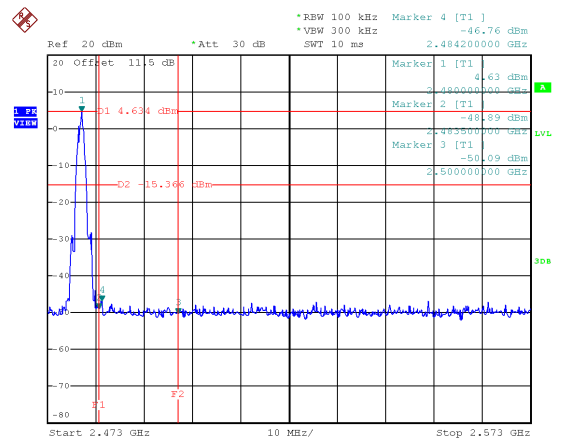

Date: 25.MAY.2024 10:44:58

Date: 25.MAY.2024 10:51:47

### CH00 – 10th Harmonic of the fundamental frequency

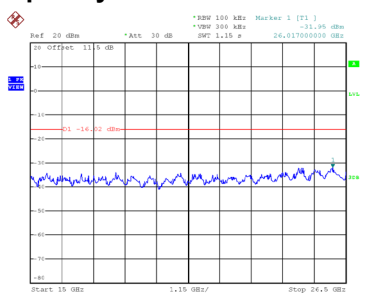
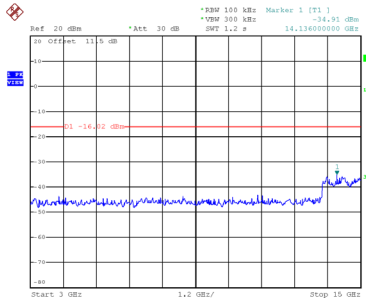
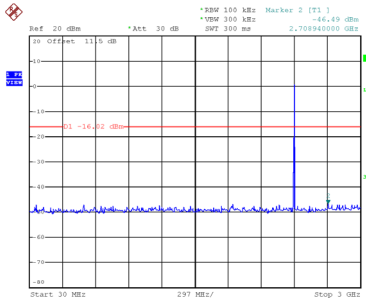

Date: 25.MAY.2024 10:45:11

Date: 25.MAY.2024 10:45:18

Date: 25.MAY.2024 10:45:26

### CH39 – 10th Harmonic of the fundamental frequency

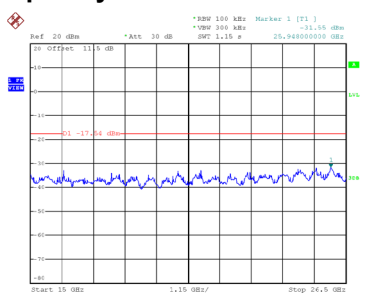
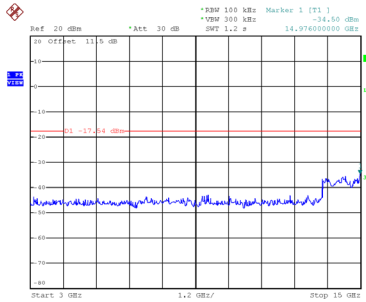
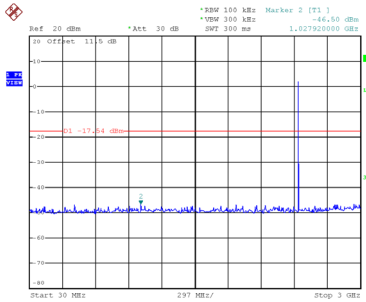

Date: 25.MAY.2024 10:48:25

Date: 25.MAY.2024 10:48:32

Date: 25.MAY.2024 10:48:40

### CH78 – 10th Harmonic of the fundamental frequency

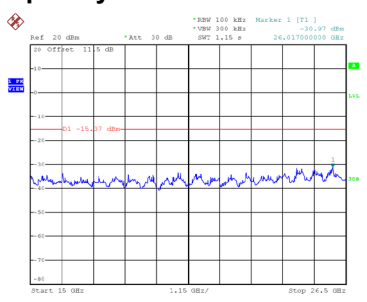
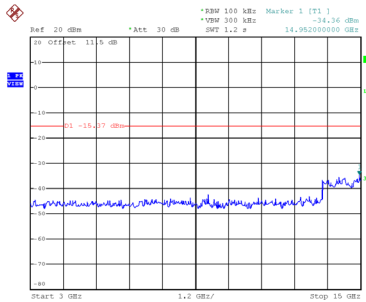
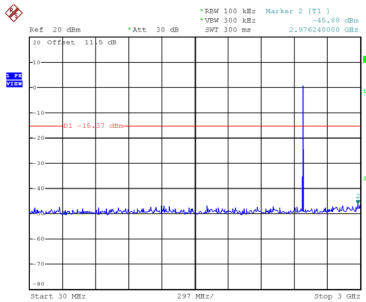

Date: 25.MAY.2024 10:52:00

Date: 25.MAY.2024 10:52:08

Date: 25.MAY.2024 10:52:15

## APPENDIX H - POWER SPECTRAL DENSITY

Test Mode TX Mode\_2Mbps

Channel	Frequency (MHz)	Power Spectral Density (dBm/3 kHz)	Max. Limit (dBm/3 kHz)	Test Result
00	2402	-12.11	8.00	Pass
39	2441	-11.45	8.00	Pass
78	2480	-13.20	8.00	Pass

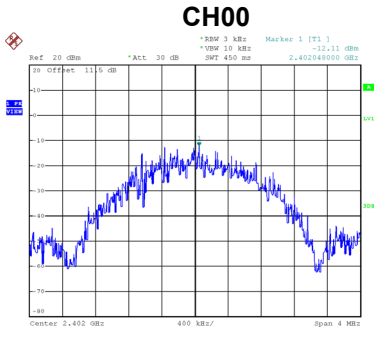

Date: 25.MAY.2024 10:45:32

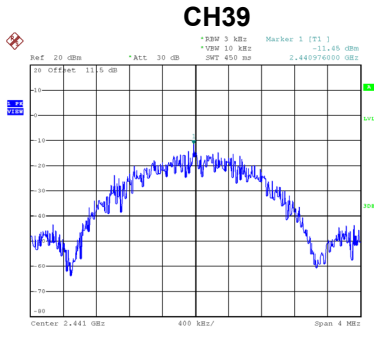

Date: 25.MAY.2024 10:48:46

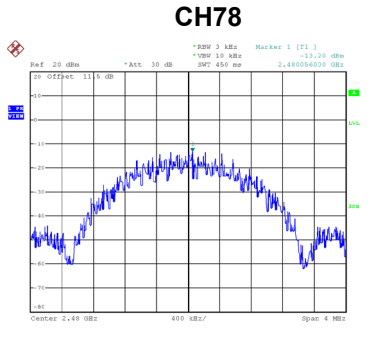

Date: 25.MAY.2024 10:52:21

End of Test Report